



This is a digital copy of a book that was preserved for generations on library shelves before it was carefully scanned by Google as part of a project to make the world's books discoverable online.

It has survived long enough for the copyright to expire and the book to enter the public domain. A public domain book is one that was never subject to copyright or whose legal copyright term has expired. Whether a book is in the public domain may vary country to country. Public domain books are our gateways to the past, representing a wealth of history, culture and knowledge that's often difficult to discover.

Marks, notations and other marginalia present in the original volume will appear in this file - a reminder of this book's long journey from the publisher to a library and finally to you.

Usage guidelines

Google is proud to partner with libraries to digitize public domain materials and make them widely accessible. Public domain books belong to the public and we are merely their custodians. Nevertheless, this work is expensive, so in order to keep providing this resource, we have taken steps to prevent abuse by commercial parties, including placing technical restrictions on automated querying.

We also ask that you:

- + *Make non-commercial use of the files* We designed Google Book Search for use by individuals, and we request that you use these files for personal, non-commercial purposes.
- + *Refrain from automated querying* Do not send automated queries of any sort to Google's system: If you are conducting research on machine translation, optical character recognition or other areas where access to a large amount of text is helpful, please contact us. We encourage the use of public domain materials for these purposes and may be able to help.
- + *Maintain attribution* The Google "watermark" you see on each file is essential for informing people about this project and helping them find additional materials through Google Book Search. Please do not remove it.
- + *Keep it legal* Whatever your use, remember that you are responsible for ensuring that what you are doing is legal. Do not assume that just because we believe a book is in the public domain for users in the United States, that the work is also in the public domain for users in other countries. Whether a book is still in copyright varies from country to country, and we can't offer guidance on whether any specific use of any specific book is allowed. Please do not assume that a book's appearance in Google Book Search means it can be used in any manner anywhere in the world. Copyright infringement liability can be quite severe.

About Google Book Search

Google's mission is to organize the world's information and to make it universally accessible and useful. Google Book Search helps readers discover the world's books while helping authors and publishers reach new audiences. You can search through the full text of this book on the web at <http://books.google.com/>



HOOVER INSTITUTION
on War, Revolution, and Peace

FOUNDED BY HERBERT HOOVER, 1919





THE ENCYCLOPÆDIA BRITANNICA

ELEVENTH EDITION

FIRST	edition, published in three	volumes,	1768—1771.
SECOND	" " ten	"	1777—1784.
THIRD	" " eighteen	"	1788—1797.
FOURTH	" " twenty	"	1801—1810.
FIFTH	" " twenty	"	1815—1817.
SIXTH	" " twenty	"	1823—1824.
SEVENTH	" " twenty-one	"	1830—1842.
EIGHTH	" " twenty-two	"	1853—1860.
NINTH	" " twenty-five	"	1875—1889.
TENTH	" ninth edition and eleven supplementary volumes,		1902—1903.
ELEVENTH	" published in twenty-nine volumes,		1910—1911.

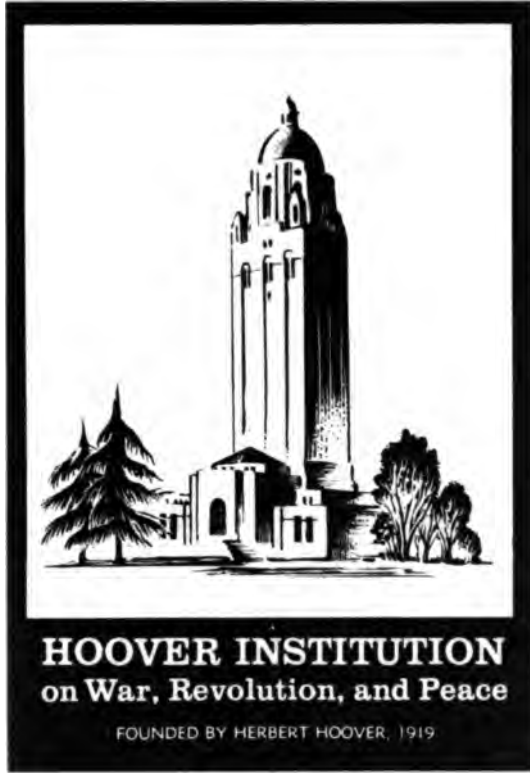

HOOVER INSTITUTION
on War, Revolution, and Peace

FOUNDED BY HERBERT HOOVER, 1919





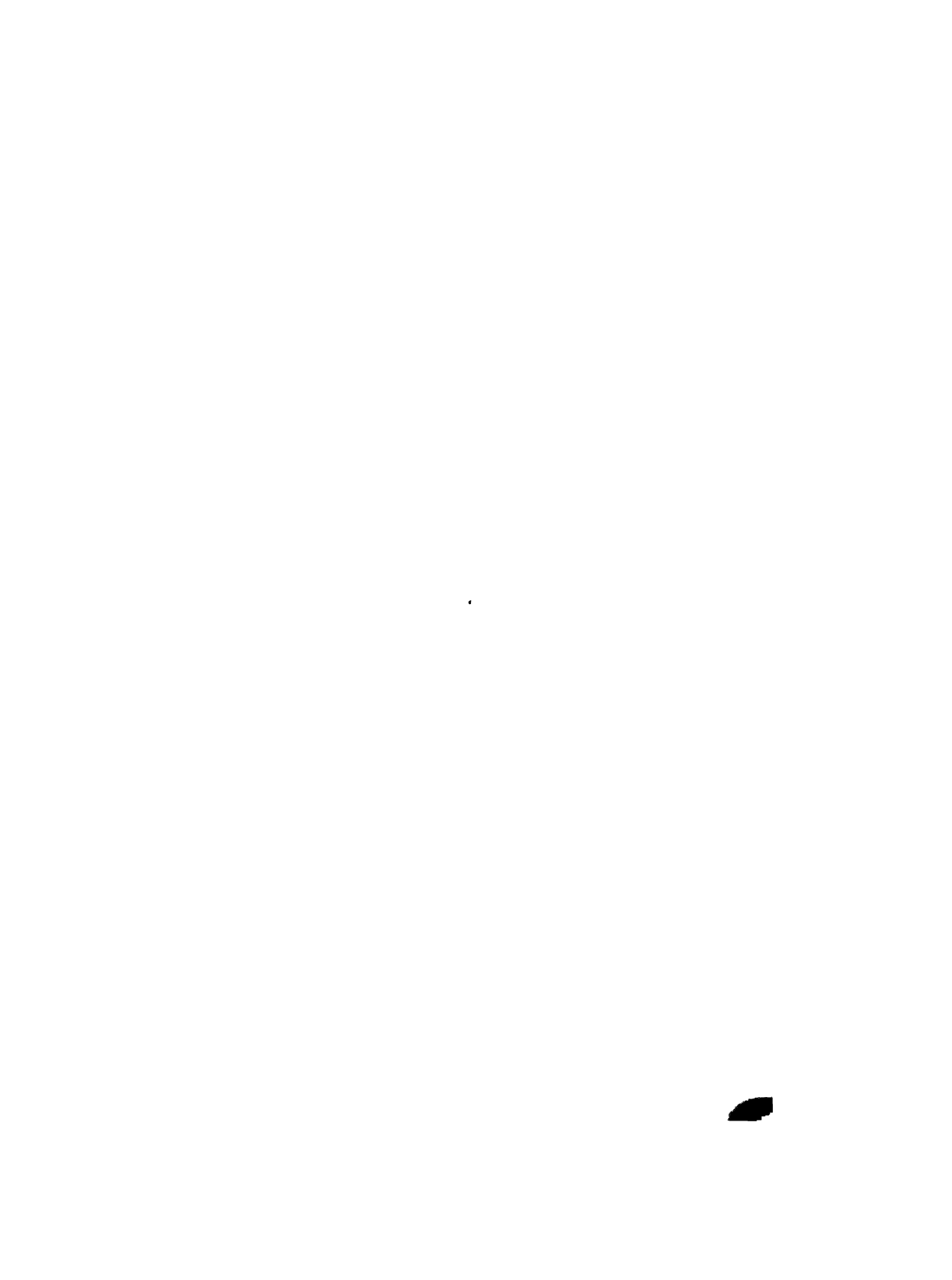

INITIALS AND HEADINGS OF ARTICLES

- A. W. W.** ADOLPHUS WILLIAM WARD, LITT.D., LL.D.
See the biographical article, WARD, A. W. { Garrick, David (*in part*).
- B. A. W. R.** HON. BERTRAND ARTHUR WILLIAM RUSSELL, M.A., F.R.S.
Formerly Fellow of Trinity College, Cambridge. Author of *Foundations of Geometry*; *Principles of Mathematics*; &c. { Geometry: VI. (*in part*).
- B. S. P.** BERTHA SURTEES PHILPOTTS, M.A. (Dublin).
Formerly Librarian of Girton College, Cambridge. { Germany: *Archæology*.
- C. B.*** CHARLES BÉMONT, LITT.D. (Oxon.).
See the biographical article, BÉMONT, C. { Fustel De Coulanges;
Gascony.
- C. D. W.** HON. CARROLL DAVIDSON WRIGHT.
See the biographical article, WRIGHT, HON. CARROLL DAVIDSON. { Friendly Societies:
United States.
- C. E.*** CHARLES EVERITT, M.A., F.C.S., F.G.S., F.R.A.S.
Sometime Scholar of Magdalen College, Oxford. { Geometry: *History*.
- C. F. A.** CHARLES FRANCIS ATKINSON.
Formerly Scholar of Queen's College, Oxford. Captain, 1st City of London (Royal Fusiliers). Author of *The Wilderness and Cold Harbour*. { Franco-German War
(*in part*);
French Revolutionary
Wars: *Military
Operations*;
Germany: *Army*;
Gibraltar: *History*.
- C. H. Ha.** CARLTON HUNTLEY HAYES, A.M., PH.D.
Assistant Professor of History in Columbia University, New York City. Member of the American Historical Association. { Gelasius II.
- C. K. S.** CLEMENT KING SHORTER.
Editor of *The Sphere*. Author of *Sixty Years of Victorian Literature*; *Immortal Memories*; *The Bronzits*; *Life and Letters*; &c. { Gaskell, Elizabeth.
- C. Ml.** CERDOMILLE MIJATOVICH.
Senator of the Kingdom of Servia. Envoy Extraordinary and Minister Plenipotentiary of the King of Servia to the Court of St James's, 1895-1900 and 1902-1903. { Garashanin.
- C. M. K.** SIR CHARLES MALCOLM KENNEDY, K.C.M.G., C.B. (1831-1908).
Head of Commercial Department, Foreign Office, 1872-1893. Lecturer on International Law, University College, Bristol. Commissioner in the Levant, 1870-1871, at Paris, 1872-1886. Plenipotentiary, Treaty of the Hague, 1882. Editor of Kennedy's *Ethnological and Linguistic Essays*; *Diplomacy and International Law*. { Free Ports.
- C. Pl.** CHRISTIAN PFISTER, D.-ÉS.-L.
Professor at the Sorbonne, Paris. Chevalier of the Legion of Honour. Author of *Études sur le règne de Robert le Pieux*; *Le Duché mérovingien d'Alsace et la légende de Sainte-Odile*. { Frank;
Frédegonde;
Germanic Laws, Early.
- C. R. B.** CHARLES RAYMOND BEAZLEY, M.A., D.LITT., F.R.G.S., F.R.HIST.S.
Professor of Modern History in the University of Birmingham. Formerly Fellow of Merton College, Oxford, and University Lecturer in the History of Geography, Lothian Prize-man, Oxford, 1889. Lowell Lecturer, Boston, 1908. Author of *Henry the Navigator*; *The Dawn of Modern Geography*; &c. { Gerard of Cremona.
- C. R. G.** CLAUDE REGNIER CONDER, LL.D.
Colonel, Royal Engineers. Formerly in command of Survey of Palestine. Author of *The City of Jerusalem*; *The Bible and the East*; *The Hittites and their Language*; &c. { Galilee (*in part*);
Galilee, Sea of (*in part*).
- C. T.*** REV. CHARLES TAYLOR, M.A., D.D., LL.D. (1840-1908).
Formerly Master of St John's College, Cambridge. Vice-Chancellor, Cambridge University, 1887-1888. Author of *Geometrical Conics*; &c. { Geometrical Continuity.
- C. We.** CECIL WEATHERLY.
Formerly Scholar of Queen's College, Oxford. Barrister-at-Law. { Gato.
- C. W. W.** SIR CHARLES WILLIAM WILSON, K.C.B., K.C.M.G., F.R.S. (1836-1907).
Major-General, Royal Engineers. Secretary to the North American Boundary Commission, 1858-1862. British Commissioner on the Servian Boundary Commission. Director-General of the Ordnance Survey, 1886-1894. Director-General of Military Education, 1895-1898. Author of *From Korts to Kharitonum*; *Life of Lord Clive*; &c. { Galilee, Sea of (*in part*).
- D. G.** DUGALD CLERE, M.INST.C.E., F.R.S.
Director of the National Gas Engine Co., Ltd. Inventor of the Clerk Cycle Gas Engine. { Gas Engine.
- D. F. T.** DONALD FRANCIS TOVEY.
Balliol College, Oxford. Author of *Essays in Musical Analysis*, comprising *The Classical Concerto*, *The Goldberg Variations*, and analyses of many other classical works. { Fugue.
- D. H.** DAVID HANNAY.
Formerly British Vice-consul at Barcelona. Author of *Short History of Royal Navy, 1217-1688*; *Life of Emilio Castelar*; &c. { French Revolutionary War:
Naval Operations.

INITIALS AND HEADINGS OF ARTICLES

vii

E. Br.	ERNEST BARKER, M.A. Fellow of, and Lecturer in Modern History at, St John's College, Oxford. Formerly Fellow and Tutor of Merton College. Craven Scholar, 1895.	{ Fulk, King of Jerusalem.
E. B. M.	EDWIN BAILEY ELLIOTT, M.A., F.R.S., F.R.A.S. Waynflete Professor of Pure Mathematics, and Fellow of Magdalen College, Oxford. Formerly Fellow of Queen's College, Oxford. President of London Mathematical Society, 1896-1898. Author of <i>Algebra of Quantics</i> ; &c.	{ Geometry, IV.
E. C. B.	RIGHT REV. EDWARD CUTHBERT BUTLER, O.S.B., D.LITT. (Dublin). Abbot of Downside Abbey, Bath. Author of "The Lausiac History of Palladius" in <i>Cambridge Texts and Studies</i> .	{ Franchiscans; Friar.
E. E.	LADY EASTLAKE. See the biographical article, EASTLAKE, SIR C. L.	{ Gibson, John.
E. G.	EDMUND GOSSE, LL.D. See the biographical article, GOSSE, EDMUND.	{ Fryzell; Gariand, John.
E. J. D.	EDWARD JOSEPH DENT, M.A., MUS.BAC. Formerly Fellow of King's College, Cambridge.	{ Galuppi.
E. O.*	EDMUND OWEN, M.B., F.R.C.S., LL.D., D.Sc. Consulting Surgeon to St Mary's Hospital, London, and to the Children's Hospital, Great Ormond Street; late Examiner in Surgery at the Universities of Cambridge, Durham and London. Author of <i>A Manual of Anatomy for Senior Students</i> .	{ Gastric Ulcer.
E. Pr.	EDGAR PRESTAGE. Special Lecturer in Portuguese Literature in the University of Manchester. Comandador Portuguese Order of S. Thiago. Corresponding Member of Lisbon Royal Academy of Sciences and Lisbon Geographical Society; &c.	{ Gargyle; Garrett.
E. W. B.	SIR EDWARD WILLIAM BRABROOK, C.B., F.S.A. Barrister-at-Law, Lincoln's Inn. Chief Registrar of Friendly Societies, 1891-1904. Author of <i>Building Societies; Provident Societies and Industrial Welfare; Institutions of Thrift</i> ; &c.	{ Friendly Societies.
F. C. C.	FREDERICK CORNWALLIS CONYBEARE, M.A., D.Th. (Geissen). Fellow of the British Academy. Formerly Fellow of University College, Oxford. Author of <i>The Ancient Armenian Texts of Aristotle; Myth, Magic and Morals</i> ; &c.	{ Funeral Rites.
F. C. M.	FRANCIS CHARLES MONTAGUE, M.A. Astor Professor of European History, University College, London. Formerly Fellow of Oriol College, Oxford. Author of <i>Limits of Individual Liberty</i> ; chapters in <i>Cambridge Modern History</i> ; &c.	{ French Revolution.
F. F.*	SIR JAMES FORTESCUE-FLANNERY, BART., M.P., M.INST.C.E. Ex-President of the Institute of Marine Engineers. M.P. for the Maldon Division of Essex, 1910. M.P. for the Shipley Division of Yorkshire, 1895-1906.	{ Fuel: Liquid.
F. G. M. B.	FREDERICK GEORGE MEESON BECK, M.A. Fellow and Lecturer in Classics, Clare College, Cambridge.	{ Germany: Ethnography and Early History.
F. H. B.	FRANCIS HENRY BUTLER, M.A. Worcester College, Oxford. Associate of Royal School of Mines.	{ Frankincense; Galls.
F. J. H.	FRANCIS JOHN HAVERFIELD, M.A., LL.D., F.S.A. Camden Professor of Ancient History in the University of Oxford. Fellow of Brasenose College. Fellow of the British Academy. Formerly Censor, Student, Tutor and Librarian of Christ Church, Oxford. Ford's Lecturer, 1906-1907. Author of Monographs on Roman History, especially Roman Britain; &c.	{ Gaul.
F. M. M.	COLONEL FREDERIC NATUSCH MAUDE, C.B. Lecturer in Military History, Manchester University. Author of <i>War and the World's Policy; The Leipzig Campaign; The Jena Campaign</i> .	{ Franco-German War (in part).
F. R. C.	FRANK R. CANA. Author of <i>South Africa from the Great Trek to the Union</i> .	{ French Congo; German East Africa; German South-West Africa.
F. R. H.	FRIEDRICH ROBERT HELMERT, Ph.D., D.ING. Professor of Geodesy, University of Berlin.	{ Geodesy (in part).
F. S.	FRANCIS STORR. Editor of the <i>Journal of Education</i> , London. Officer d'Académie (Paris).	{ Games, Classical.
F. W. R.*	FREDERICK WILLIAM RUDLER, L.S.O., F.G.S. Curator and Librarian of the Museum of Practical Geology, London, 1879-1902. President of the Geologists' Association, 1887-1889.	{ Garnet; Gem: L.
G. E.	REV. GEORGE EDMUNDSON, M.A., F.R.HIST.S. Formerly Fellow and Tutor of Brasenose College, Oxford. Ford's Lecturer, 1909.	{ Gelderland (Duchy).
G. L.	GEORG LUNGE. See the biographical article, LUNGE, G.	{ Fuel: Gaseous; Gas: Manufacture, II.
G. Sa.	GEORGE SAINTSBURY, D.C.L., LL.D. See the biographical article, SAINTSBURY, G.	{ French Literature; Gautier.

INITIALS AND HEADINGS OF ARTICLES

- G. W. T.** REV. GRIFFITHS WHEELER TRATCHER, M.A., B.D.
Warden of Camden College; Sydney, N.S.W. Formerly Tutor in Hebrew and Old Testament History at Mansfield College, Oxford. { **Ghasseh.**
- H. B.** HILARY BAUTERMANN, F.G.S. (d. 1909).
Formerly Lecturer on Metallurgy at the Ordnance College, Woolwich. Author of { **Fuel: Solid.**
A Treatise on the Metallurgy of Iron.
- H. B. W.** HORACE BOLINGBROKE WOODWARD, F.R.S., F.G.S.
Late Assistant Director, Geological Survey of England and Wales. Wolfaston Medalist, Geological Society. Author of *The History of the Geological Society of London*; &c. { **Gaudry.**
- H. Ch.** HUGH CUDDEHILL, M.A.
Formerly Scholar of Corpus Christi College, Oxford. Editor of the 11th edition of the *Encyclopaedia Britannica*; Co-editor of the 10th edition. { **Gambetta;**
Garnett, Richard;
George IV. (in part).
- H. C. L.** HON. HENRY CABOT LODGE.
See the biographical article, LODGE, HENRY CABOT. { **Gallatin.**
- H. F. Ba.** HENRY FRIDRICK BAKER, M.A., D.Sc., F.R.S.
Fellow and Lecturer of St John's College, Cambridge. Cayley Lecturer in Mathematics in the University. Author of *Abel's Theorem and the Allied Theory*; &c. { **Function: Functions of**
Complex Variables.
- H. L. C.** HUGH LONGBOURNE CALLENDAR, F.R.S., LL.D.
Professor of Physics, Royal College of Science, London. Formerly Professor of Physics in MacGill College, Montreal, and in University College, London. { **Fusion.**
- H. M.*** HUGH MITCHELL.
Barrister-at-Law, Inner Temple. { **Gibraltar (in part).**
- H. M. W.** H. MARSHALL WARD, M.A., D.Sc., F.R.S. (d. 1905).
Formerly Professor of Botany, Cambridge. President of the British Mycological Society. Author of *Timber and Some of its Diseases*; *The Oak*; *Sach's Lectures on the Physiology of Plants*; *Diseases in Plants*; &c. { **Fungi (in part).**
- H. N.** HENRY NICOL. { **French Language (in part).**
- H. R. M.** HUGH ROBERT MILL, D.Sc., LL.D.
Director of British Rainfall Organisation. Editor of *British Rainfall*. Formerly President of the Royal Meteorological Society. Hon. Member of Vienna Geographical Society. Hon. Corresponding Member of Geographical Societies of Paris, Berlin, Budapest, St Petersburg, Amsterdam, &c. Author of *The Realm of Nature*; *The International Geography*; &c. { **Geography.**
- H. W. C. D.** HENRY WILLIAM CARLESS DAVIS, M.A.
Fellow and Tutor of Balliol College, Oxford. Fellow of All Souls College, Oxford, 1895-1902. Author of *England under the Normans and Angevins*; *Charlemagne*. { **Geoffrey, Archbishop of**
York;
Geoffrey of Monmouth;
Gerard;
Gervase of Canterbury;
Gervase of Tilbury.
- H. W. S.** H. WICKHAM STEED.
Correspondent of *The Times* at Rome (1897-1902) and Vienna. { **Garibaldi.**
- I. A.** ISRAEL ABRAHAM, M.A.
Reader in Talmudic and Rabbinic Literature in the University of Cambridge. Formerly President, Jewish Historical Society of England. Author of *A Short History of Jewish Literature*; *Jewish Life in the Middle Ages*; *Judaism*; &c. { **Frank, Jakob;**
Frankel, Zacharias;
Frankl, Ludwig A.;
Friedmann, Meir;
Gaon; Geiger (in part);
Gerzonides.
- J. A. F.** JOHN AMBROSE FLEMING, M.A., D.Sc., F.R.S.
Pender Professor of Electrical Engineering in the University of London. Fellow of University College, London. Formerly Fellow of St John's College, Cambridge, and Lecturer on Applied Mechanics in the University. Author of *Magnets and Electric Currents*. { **Galvanometer.**
- J. A. H.** JOHN ALLEN HOWE, B.Sc.
Curator and Librarian of the Museum of Practical Geology, London. Author of { **Fuller's, Earth.**
The Geology of Building Stones.
- J. B. B.** JOHN BAGNALL BURY, LL.D., D.C.L.
See the biographical article, BURY, J. B. { **Gibson, Edward.**
- J. B. McM.** JOHN BACH McMASTER, LL.D.
Professor of American History in the University of Pennsylvania. Author of { **Garfield, James Abram.**
A History of the People of the United States; &c.
- J. Ga.** JAMES GAIRDNER, LL.D., C.B.
See the biographical article, GAIRDNER, J. { **Gardiner, Stephen.**
- J. G. C. A.** JOHN GEORGE CLARK ANDERSON, M.A.
Censor and Tutor of Christ Church, Oxford. Formerly Fellow of Lincoln College; Craven Fellow, Oxford, 1896. Conington prizeman, 1893. { **Galska.**
- J. G. R.** JOHN GEORGE ROBERTSON, M.A., Ph.D.
Professor of German, University of London. Author of *History of German Literature*; *Schiller after a Century*; &c. { **Froberg;**
German Literature.

INITIALS AND HEADINGS OF ARTICLES

ix

J. Hn.	<p>JUSTUS HARBAGEN, PH.D. Privat-doцент in Medieval and Modern History, University of Bonn. Author of <i>Das Rheinland und die französische Herrschaft.</i></p>	}	<p>Frederick Augustus I. and II.; Frederick William I.</p>
J. H. Gr.	<p>JOHN HILTON GRACE, M.A., F.R.S. Lecturer in Mathematics at Peterhouse and Pembroke College, Cambridge. Fellow of Peterhouse</p>	}	<p>Geometry, V.</p>
J. H. H.	<p>JOHN HENRY HESSELS, M.A. Author of <i>Gutenberg: an Historical Investigation</i></p>	}	<p>Fust.</p>
J. H. R.	<p>JOHN HORACE ROUND, M.A., LL.D. (Edin.) Author of <i>Feudal England: Studies in Peerage and Family History; Peerage and Pedigree, &c.</i></p>	}	<p>Geoffrey De Montheray.</p>
J. Hl. R.	<p>JOHN HOLLAND ROSE, M.A., Litt.D. Christ's College, Cambridge. Lecturer on Modern History to the Cambridge University Local Lectures Syndicate. Author of <i>Life of Napoleon I.; Napoleonic Studies; The Development of the European Nations; The Life of Pitt; &c.</i></p>	}	<p>Gardane.</p>
J. Mt.	<p>JAMES MOFFATT, M.A., D.D. Jowett Lecturer, London, 1907. Author of <i>Historical New Testament; &c.</i></p>	}	<p>Galatians, Epistle to the.</p>
J. P.-B.	<p>JAMES GEORGE JOSEPH PENDEREL-BRODBURST. Editor of the <i>Guardian</i> (London).</p>	}	<p>Furniture.</p>
J. Si.	<p>JAMES SIME, M.A. (1843-1895). Author of <i>A History of Germany; &c.</i></p>	}	<p>Frederick the Great (in part).</p>
J. S. Bi	<p>JOHN SCOTLAND BLACK, M.A., LL.D. Assistant Editor 9th edition <i>Encyclopaedia Britannica</i>. Joint-editor of the <i>Encyclopaedia Biblica</i>.</p>	}	<p>Free Church of Scotland (in part).</p>
J. S. F.	<p>JOHN SMITH FLETT, D.Sc., F.G.S. Petrographer to the Geological Survey. Formerly Lecturer on Petrology in Edinburgh University. Neill Medallist of the Royal Society of Edinburgh. Bigsby Medallist of the Geological Society of London.</p>	}	<p>Fulgurite; Gabbro.</p>
J. T. Be	<p>JOHN T. BEALBY. Joint-author of <i>Stanford's Europe</i>. Formerly Editor of the <i>Scottish Geographical Magazine</i>. Translator of Sven Hedin's <i>Through Asia, Central Asia and Tibet; &c.</i></p>	}	<p>Georgia (Russia), (in part).</p>
J. T. C.	<p>JOSEPH THOMAS CUNNINGHAM, M.A., F.Z.S. Lecturer on Zoology at the South-Western Polytechnic, London. Formerly Fellow of University College, Oxford. Assistant Professor of Natural History in the University of Edinburgh. Naturalist to the Marine Biological Association.</p>	}	<p>Gastropoda.</p>
J. V. B.	<p>JAMES VERNON BARTLET, M.A., D.D. (St. Andrews). Professor of Church History, Mansfield College, Oxford. Author of <i>The Apostolic Age; &c.</i></p>	}	<p>Frommel.</p>
J. Ws.	<p>JOHN WEATHERS, F.R.H.S. Lecturer on Horticulture to the Middlesex County Council. Author of <i>Practical Guide to Garden Plants; French Market Gardening; &c.</i></p>	}	<p>Fruit and Flower Farming (in part).</p>
J. W. Ho	<p>JAMES WYCLIFFE HEADLAM, M.A. Staff Inspector of Secondary Schools under the Board of Education. Formerly Fellow of King's College, Cambridge. Professor of Greek and Ancient History at Queen's College, London. Author of <i>Bismarck and the Foundation of the German Empire; &c.</i></p>	}	<p>Frederick III. of Prussia; Germany: History (in part).</p>
K. S.	<p>KATHLEEN SCHLESINGER. Author of <i>The Instruments of the Orchestra; &c.</i> Editor of the <i>Portfolio of Musical Archaeology</i>.</p>	}	<p>Free Reed Vibrator Geige.</p>
L. D.	<p>LOUIS DUCHESNE. See the biographical article, DUCHESNE, L. M. O.</p>	}	<p>Gelasius I.</p>
L. H.*	<p>LOUIS HALDPHEN, D.-ès.-L. Principal of the course of the Faculty of Letters in the University of Bordeaux. Author of <i>Le Comté d'Anjou au XI^e siècle; Recueil des actes angevins; &c.</i></p>	}	<p>Fulk Nerra; Geoffrey, Count of Anjou Geoffrey Plantagenet.</p>
L. J. S.	<p>LEONARD JAMES SPENCER, M.A. Assistant in Department of Mineralogy, British Museum. Formerly Scholar of Sidney Sussex College, Cambridge, and Harkness Scholar. Editor of the <i>Mineralogical Magazine</i></p>	}	<p>Galena.</p>
L. V.	<p>LINDA MARY VILLARI. See the biographical article, VILLARI, PASQUALE.</p>	}	<p>Frederick III. King of Sicily.</p>
M. G.	<p>MOSES GASTER, PH.D. Chief Rabbi of the Sephardic communities of England. Vice-President, Zionist Congress, 1898, 1899, 1900. Ilchester Lecturer at Oxford on Slavonic and Byzantine Literature, 1886 and 1891. President, Folk-lore Society of England. Vice-President, Anglo-Jewish Association. Author of <i>History of Rumanian Popular Literature; A New Hebrew Fragment of Ben-Sira; The Hebrew Version of the Secretum Secretorum of Aristotle.</i></p>	}	<p>Ghica.</p>
M. N. T.	<p>MARCUS NIEBUHR TOD, M.A. Fellow and Tutor of Oriel College, Oxford. University Lecturer in Epigraphy. Joint-author of <i>Catalogue of the Sports Museum.</i></p>	}	<p>Gerotisia.</p>

INITIALS AND HEADINGS OF ARTICLES

- O. Ba.** **OSWALD BARRON, F.S.A.**
Editor of *The Ancestor*, 1902-1905. Hon. Genealogist to Standing Council of the Honourable Society of the Baronetage. } Genealogy: *Modern*.
- O. H.** **OLAUS MAGNUS FRIEDRICH HENRICI, PH.D., LL.D., F.R.S.**
Professor of Mechanics and Mathematics in the Central Technical College of the City and Guilds of London Institute. Author of *Vectors and Rotors*; *Congruent Figures*; &c. } Geometry, I., II., and III.
- P. A.** **PAUL DANIEL ALPHANDÉRY.**
Professor of the History of Dogma, École pratique des hautes études, Sorbonne, Paris. Author of *Les Idées morales chez les hétérodoxes latines au début du XIII^e siècle*. } Fratitcoll.
- P. A. A.** **PHILIP A. ASHWORTE, M.A., DOC. JURIS.**
New College, Oxford. Barrister-at-Law. Translator of H. R. von Gneist's *History of the English Constitution*. } Germany: *Geography*.
- P. G.** **PETER GILES, M.A., LL.D., LITT.D.**
Fellow and Classical Lecturer of Emmanuel College, Cambridge, and University Reader in Comparative Philology. Formerly Secretary of the Cambridge Philological Society. Author of *Manual of Comparative Philology*; &c. } G.
- P. La.** **PHILIP LAKE, M.A., F.G.S.**
Lecturer on Physical and Regional Geography in Cambridge University. Formerly of the Geological Survey of India. Author of *Monograph of British Cambrian Trilobites*. Translator and editor of Kayser's *Comparative Geology*. } Germany: *Geology*.
- P. M.** **PAUL MEYER.**
See the biographical article, MEYER, M. P. H. } French Language (in part).
- R. Ad.** **ROBERT ADAMSON, LL.D.**
See the biographical article, ADAMSON, ROBERT. } Cassendi (in part).
- R. A. S. M.** **ROBERT ALEXANDER STEWART MACALISTER, M.A., F.S.A.**
St John's College, Cambridge. Director of Excavations for the Palestine Exploration Fund. } Gadara; Galilee (in part);
Galilee, Sea of (in part);
Gerasa; Gerizim;
Gezer; Gibbon.
- R. Ch.** **ROBERT CARRUTHERS, LL.D. (1799-1878).**
Editor of the *Inverness Courier*, 1828-1878. Part-editor of Chambers's *Cyclopaedia of English Literature*; Lecturer at the Philosophical Institution, Edinburgh. Author of *History of Huntingdon*; *Life of Pope*. } Garrick, David (in part).
- R. H. Q.** **REV. ROBERT HERBERT QUICK, M.A., (1831-1891).**
Trinity College, Cambridge. Formerly Lecturer on Education, University of Cambridge. Author of *Essays on Educational Reformers*. } Froebel.
- R. L.^o** **RICHARD LYDEKKE, F.R.S., F.Z.S., F.G.S.**
Member of the Staff of the Geological Survey of India, 1874-1882. Author of *Catalogues of Fossil Mammals, Reptiles and Birds in British Museum*; *The Deer of all Lands*; &c. } Galago; Galeopithecus;
Ganodonta; Gelada;
Gibbon.
- R. H. B.** **ROBERT NISBET BAIN (d. 1909).**
Assistant Librarian, British Museum, 1883-1909. Author of *Scandinavia, the Political History of Denmark, Norway and Sweden, 1513-1900*; *The First Romanesque, 1013 to 1725*; *Seasonic Europe, the Political History of Poland and Russia from 1469 to 1796*; &c. } Frederick II. and III. of
Denmark and Norway.
Gedymn.
- R. Fr.** **ROBERT FRIEBSCH, PH.D.**
Professor of German Philology, University of London. Author of *Deutsche Handschriften in England*; &c. } German Language.
- R. P. S.** **R. PHENÉ SPIERS, F.S.A., F.R.L.B.A.**
Formerly Master of the Architectural School, Royal Academy, London. Past President of Architectural Association. Associate and Fellow of King's College, London. Corresponding Member of the Institute of France. Editor of Fergusson's *History of Architecture*. Author of *Architecture: East and West*; &c. } Garnier, J.
- R. Wc.** **RICHARD WEBSTER, A.M. (Princeton).**
Formerly Fellow in Classics, Princeton University. Editor of *The Elegies of Maximæsus*; &c. } Franklin, Benjamin.
- S. A. C.** **STANLEY ARTHUR COOK, M.A.**
Editor for Palestine Exploration Fund. Lecturer in Hebrew and Syriac, and formerly Fellow, Gonville and Caius College, Cambridge. Examiner in Hebrew and Aramaic, London University, 1904-1908. Council of Royal Asiatic Society, 1904-1909. Author of *Glossary of Aramaic Inscriptions*; *The Laws of Moses and the Code of Hammurabi*; *Critical Notes on Old Testament History*; *Religion of Ancient Palestine*, &c. } Genealogy: *Biblical*;
Genesis.
- St. C.** **VISCOUNT ST CYRES.**
See the biographical article, IDDESLEIGH, 1ST EARL OF. } Gallicanism.
- S. R. G.** **SAMUEL RAWSON GARDINER, LL.D., D.C.L.**
See the biographical article, GARDINER, S. R. } George I., II., III.,
George IV. (in part).
- T. As.** **THOMAS ASHEY, M.A., D.LITT. (Oxon.).**
Director of British School of Archaeology at Rome. Formerly Scholar at Christ Church, Oxford. Craven Fellow, 1897. Conington Prize-man, 1906. Member of the Imperial German Archaeological Institute. } Frascati; Fregellæ;
Frascati; Fregellæ;
Fusine, Lago Di; Fulginiae;
Fusaro, Lago; Gabil; .
Caeta; Gallipoli (Italy);
Gela; Genoa.

INITIALS AND HEADINGS OF ARTICLES

21

T. Ba.	<p>SIR THOMAS BARCLAY, M.P. Member of the Institute of International Law. Member of the Supreme Council of the Congo Free State. Officer of the Legion of Honour. Author of <i>Problems of International Practice and Diplomacy</i>; &c. M.P. for Blackburn, 1910.</p>	}	Geneva Convention.
T. C. H.	<p>THOMAS CALLAN HODSON. Registrar, East London College, University of London. Late Indian Civil Service. Author of <i>The Maths</i>; &c.</p>	}	Geneva.
T. E. H.	<p>THOMAS ESKINE HOLLAND, K.C., D.C.L., LL.D. Fellow of All Souls College, Oxford. Professor of International Law and Diplomacy in the University of Oxford, 1874-1910. Fellow of the British Academy. Bencher of Lincoln's Inn. Author of <i>Studies in International Law; The Elements of Jurisprudence; Alberici Gentilis de jure belli; The Laws of War on Land; Neutral Duties in a Maritime War</i>; &c.</p>	}	Geneva.
T. G. S.	<p>THOMAS GASKELL SHEARMAN (d. 1900). Author of <i>The Single Tax; Natural Taxation; Distribution of Wealth</i>; &c.</p>	}	George, Henry.
T. H. H.*	<p>COLONEL SIR THOMAS HUNGERFORD HOLDICH, K.C.M.G., K.C.I.E., D.Sc. Superintendent Frontier Surveys, India, 1892-1898. Gold Medallist, R.G.S. (London), 1887. Author of <i>The Indian Borderland; The Countries of the King's Award; India; Tibet</i>; &c.</p>	}	Geneva.
T. M. L.	<p>REV. THOMAS MARTIN LINDSAY, D.D. Principal and Professor of Church History, United Free Church College, Glasgow. Author of <i>Life of Luther</i>; &c.</p>	}	Geneva (in part).
V. B. L.	<p>VIVIAN BYAM LEWIS, F.I.C., F.C.S. Professor of Chemistry, Royal Naval College, Greenwich. Chief Superintending Gas Examiner to City of London.</p>	}	Gas; Manufacture, I.
V. H. B.	<p>VERNON HERBERT BLACKMAN, M.A., D.Sc. Professor of Botany in the University of Leeds. Formerly Fellow of St John's College, Cambridge.</p>	}	Fungi (in part).
W. A. B. G.	<p>REV. WILLIAM AUGUSTUS BREVOORT COOLIDGE, M.A., F.R.G.S., Ph.D. (Bern). Fellow of Magdalen College, Oxford. Professor of English History, St David's College, Lampeter, 1880-1881. Author of <i>Guide du Haut Dauphin; The Range of the Tâbi; Guide to Grindelwald; Guide to Switzerland; The Alps in Nature and in History</i>; &c. Editor of <i>The Alpine Journal</i>, 1880-1881; &c.</p>	}	Frauenfeld; Fribourg; Gaps; Garda, Lake of; Gemmi Pass; Geneva; Geneva, Lake of.
W. A. P.	<p>WALTER ALISON PHILLIPS, M.A. Formerly Exhibitioner of Merton College and Senior Scholar of St John's College, Oxford. Author of <i>Modern Europe</i>; &c.</p>	}	Frederick II. of Prussia (in part); Gentleman; Gents, Friedrich; Germany: History (in part).
W. Ba.	<p>WILLIAM BACHER, Ph.D. Professor of Biblical Science at the Rabbinical Seminary, Budapest.</p>	}	Gamelle.
W. Be.	<p>SIR WALTER BESANT. See the biographical article, BESANT, SIR W.</p>	}	Froissart.
W. C.	<p>SIR WILLIAM CROOKES, F.R.S. See the biographical article, CROOKES, SIR WILLIAM.</p>	}	Gem, Artificial.
W. Cu.	<p>THE VEN. WILLIAM CUNNINGHAM, M.A., D.D. Archdeacon of Ely. Birkbeck Lecturer in Ecclesiastical History, Trinity College, Cambridge. Fellow of the British Academy. Fellow of Trinity College, Cambridge. Author of <i>Growth of English Industry and Commerce</i>; &c.</p>	}	Free Trade.
W. E. D.	<p>WILLIAM ERNEST DALBY, M.A., M.Inst.C.E., M.I.M.E. Professor of Civil and Mechanical Engineering at the City and Guilds of London Institute Central Technical College, South Kensington. Formerly University Demonstrator in the Engineering Department of Cambridge University. Author of <i>The Balancing of Engines; Valves and Valve Gear Mechanism</i>; &c.</p>	}	Friction (in part).
W. Fr.	<p>WILLIAM FREAM, LL.D. (d. 1906). Formerly Lecturer on Agricultural Entomology, University of Edinburgh, and Agricultural Correspondent of <i>The Times</i>.</p>	}	Fruit and Flower Farming (in part).
W. F. C.	<p>WILLIAM FEILDEN CRAIGES, M.A. Barrister-at-Law, Inner Temple. Lecturer on Criminal Law, King's College, London. Editor of Archbold's <i>Criminal Pleading</i> (23rd edition).</p>	}	Game Laws; Gaming and Wagering.
W. Hu.	<p>REV. WILLIAM HUNT, M.A., Litt.D. President of the Royal Historical Society 1905-1909. Author of <i>History of English Church, 597-1066; The Church of England in the Middle Ages; Political History of England, 1760-1801</i>; &c.</p>	}	Freeman, Edward A.; Froude; Gardiner, Samuel Rawson.
W. J. H.	<p>WILLIAM JAMES HUGHAN. Past S.G.D. of the Grand Lodge of England. Author of <i>Origin of the English Rite of Freemasonry</i>.</p>	}	Freemasonry.
W. L. F.	<p>WALTER LYNWOOD FLEMING, A.M., Ph.D. Professor of History in Louisiana State University. Author of <i>Documentary History of Reconstruction</i>; &c.</p>	}	Freedmen's Bureau.
W. L. G.	<p>WILLIAM LAWSON GRANT, M.A. Professor of Colonial History, Queen's University, Kingston, Canada. Formerly Beit Lecturer in Colonial History, Oxford University. Editor of <i>Acts of the Privy Council</i> (Canadian Series).</p>	}	Galt, Sir Alexander T.

INITIALS AND HEADINGS OF ARTICLES

W. M. R.	WILLIAM MICHAEL ROSSETTI. See the biographical article, ROSSETTI, DANTE G.	Fuseli; Gaddi; Gainsborough; Ghirlandajo, Domenico; Ghirlandajo, Ridolfo.
W. R. B. ^o	WILLIAM RAYMOND BAIRD, LL.D. Author of <i>Manual of American College Fraternities</i> ; &c. Editor of <i>The Beta Theta Pi</i> .	
W. S. P.	WALTER SUTHERLAND PARKER. Deputy Chairman, Fur Section, London Chamber of Commerce.	Fur.

PRINCIPAL UNSIGNED ARTICLES

Franz Josef Land.	Fuero.	Genius.	German Baptist Brethren.
Free Church Federation.	Furnace.	Gentian.	German Catholics.
French Guinea.	Galapagos Islands.	Gentianaceae.	Gettysburg.
French West Africa.	Galicja.	George, Saint.	Geyer.
Friedland.	Galway.	George Junior Republic.	Ghazni.
Frisian Islands.	Gambia.	Georgia (U.S.A.).	Ghent.
Frisians.	Gawain.	Geraniaceae.	Ghor.
Fronde, The.	Gelatin.	Geranium.	Giant.

ENCYCLOPÆDIA BRITANNICA

ELEVENTH EDITION

VOLUME XI

FRANCISCANS (otherwise called Friars Minor, or Minorites; the Seraphic Order; and in England Grey Friars, from the colour of the habit, which, however, is now brown rather than grey), religious order founded by St Francis of Assisi (*q.v.*). It was in 1206 that St Francis left his father's house and devoted himself to a life of poverty and to the service of the poor, the sick and the lepers; and in 1209 that he felt the call to add preaching to his ministrations, and to lead a life in the closest imitation of Christ's life. Within a few weeks disciples began to join themselves to him; the condition was that they should dispose of their possessions. When their number was twelve Francis took the little flock to Rome to obtain the pope's sanction for their undertaking. Innocent III. received them kindly, but with some misgivings as to the feasibility of the proposed manner of life; these difficulties were overcome, and the pope accorded his formal approval by word of mouth: they were to become monks and to elect a superior. Francis was elected and made a promise of obedience to the pope, and the others promised obedience to Francis.

His formal inauguration of the institute was in 1209 or (as is more probable) 1210. Francis and his associates were known as "Penitents of Assisi," and then Francis chose the name of "Minors." On their return to Assisi they obtained from Benedictine abbey on Mount Subasio the use of the little chapel of St Mary of the Angels, called the Portiuncula, in the neighbourhood below Assisi, which became the cradle and headquarters of the order. Around the Portiuncula they built themselves huts and branches and twigs, but they had no fixed abode; they wandered in pairs over the country, dressed in the ordinary dress of the peasants, working in the fields to earn their daily bread, sleeping in barns or in the hedgerows or in the porches of churches, mixing with the labourers and the poor, with the lepers and the outcasts, ever joyous—the "joculatores" or "gleemen" of God—ever carrying out their mission of preaching to the lowly and to the wretched religion and repentance and the kingdom of God. The key-note of the movement was the imitation of the public life of Christ, especially the poverty of the East. Francis and his disciples were to aim at possessing nothing, absolutely nothing, so far as was compatible with life; they were to earn their bread from day to day by the work of their hands, and only when they could not do so were they to beg;

they were to make no provision for the morrow, lay by no store, accumulate no capital, possess no land; their clothes should be the poorest and their dwellings the meanest; they were forbidden to receive or to handle money. On the other hand they were bound only to the fast observed in those days by pious Christians, and were allowed to eat meat—the rule said they should eat whatever was set before them; no austerities were imposed, beyond those inseparable from the manner of life they lived.

Thus the institute in its original conception was quite different from the monastic institute, Benedictine or Canon Regular. It was a confraternity rather than an order, and there was no formal novitiate, no organization. But the number of brothers increased with extraordinary rapidity, and the field of work soon extended itself beyond the neighbourhood of Assisi and even beyond Umbria—within three or four years there were settlements in Perugia, Cortona, Pisa, Florence and elsewhere, and missions to the Saracens and Moors were attempted by Francis himself. About 1217 Franciscan missions set out for Germany, France, Spain, Hungary and the Holy Land; and in 1219 a number of provinces were formed, each governed by a provincial minister. These developments, whereby the little band of Umbrian apostles had grown into an institute spread all over Europe and even penetrating to the East, and numbering thousands of members, rendered impossible the continuance of the original free organization whereby Francis's word and example were the sufficient practical rule of life for all: it was necessary as a condition of efficiency and even of existence and permanence that some kind of organization should be provided. From an early date yearly meetings or chapters had been held at the Portiuncula, at first attended by the whole body of friars; but as the institute extended this became unworkable, and after 1219 the chapter consisted only of the officials, provincial ministers and others. During Francis's absence in the East (1219–1220) a deliberate movement was initiated by the two vicars whom he had left in charge of the order, towards assimilating it to the monastic orders. Francis hurried back, bringing with him Elias of Cortona, the provincial minister of Syria, and immediately summoned an extraordinary general chapter (September 1220). Before it met he had an interview on the situation with Cardinal Hugolino of Ostia (afterwards Gregory IX.), the great friend and supporter of both Francis and Dominic,

and he went to Honorius III. at Orvieto and begged that Hugolino should be appointed the official protector of the order. The request was granted, and a bull was issued formally approving the order of Friars Minor, and decreeing that before admission every one must pass a year's novitiate, and that after profession it was not lawful to leave the order. By this bull the Friars Minor were constituted an order in the technical sense of the word. When the chapter assembled, Francis, no doubt from a genuine feeling that he was not able to govern a great world-wide order, practically abdicated the post of minister-general by appointing a vicar, and the policy of turning the Friars Minor into a great religious order was consistently pursued, especially by Elias, who a year later became Francis's vicar.

St Francis's attitude towards this change is of primary importance for the interpretation of Franciscan history. There can be little doubt that his affections never altered from his first love, and that he looked back regretfully on the "Umbrian idyll" that had passed away; on the other hand, there seems to be no reason for doubting that he saw that the methods of the early days were now no longer possible, and that he acquiesced in the inevitable. This seems to be Professor Goetz's view, who holds that Sabatier's picture of Francis's agonized sadness at witnessing the destruction of his great creation going on under his eyes, has no counterpart in fact, and who rejects the view that the changes were forced on Francis against his better judgment by Hugolino and Elias (see "Note on Sources" at end of article FRANCIS OF ASSISI; also ELIAS OF CORTONA); Goetz holds that the only conflict was the inevitable one between an unrealizable ideal and its practical working among average men. But there does seem to be evidence that Francis deplored tendencies towards a departure from the severe simplicity of life and from the strict observance of poverty which he considered the ground-idea of his institute. In the final redaction of his Rule made in 1223 and in his Testament, made after it, he again clearly asserts his mind on these subjects, especially on poverty; and in the Testament he forbids any glosses in the interpretation of the Rule, declaring that it is to be taken simply as it stands. Sabatier's view as to the difference between the "First Rule" and that of 1223 is part of his general theory, and is, to say the least, a grave exaggeration. No doubt the First Rule, which is fully four times as long, gives a better picture of St Francis's mind and character; the later Rule has been formed from the earlier by the elimination of the frequent scripture texts and the edificatory element; but the greater portion of it stood almost verbally in the earlier.

On Francis's death in 1226 the government of the order rested in the hands of Elias until the chapter of 1227. At this chapter Elias was not elected minister-general; the building of the great basilica and monastery at Assisi was so manifest a violation of St Francis's ideas and precepts that it produced a reaction, and John Parenti became St Francis's first successor. He held fast to St Francis's ideas, but was not a strong man. At the chapter of 1230 a discussion arose concerning the binding force of St Francis's Testament, and the interpretation of certain portions of the Rule, especially concerning poverty, and it was determined to submit the questions to Pope Gregory IX., who had been St Francis's friend and had helped in the final redaction of the Rule. He issued a bull, *Quo elongati*, which declared that as the Testament had not received the sanction of the general chapter it was not binding on the order, and also allowed trustees to hold and administer money for the order. John Parenti and those who wished to maintain St Francis's institute intact were greatly disturbed by these relaxations; but a majority of the chapter of 1232, by a sort of *coup d'état*, proclaimed Elias minister-general, and John retired, though in those days the office was for life. Under Elias the order entered on a period of extraordinary extension and prosperity; the number of friars in all parts of the world increased wonderfully, new provinces were formed, new missions to the heathen organized, the Franciscans entered the universities and vied with the Dominicans as teachers of theology and canon law, and as a body they became influential in church and state. With all this side of Elias's policy the great bulk of the order sympathized; but his rule was despotic and tyrannical and his private life was lax—at least according to any Franciscan standard, for no charge of grave irregularity was ever brought against him. And so a widespread movement against his government arose, the backbone of which was the university element at Paris and Oxford, and at a dramatic scene in a chapter held in the presence of Gregory IX. Elias was deposed (1239).

The story of these first years after St Francis's death is best told by Ed. Lempp, *Frère Elie de Corone* (1901) (but see the warning at the end of the article ELIAS OF CORTONA).

At this time the Franciscans were divided into three parties: there were the Zealots, or Spirituals, who called for a literal observance of St Francis's Rule and Testament; they deplored all the developments since 1219, and protested against turning the institute into an order, the frequentation of the universities and the pursuit of learning; in a word, they wished to restore the life to what it had been during the first few years—the hermitages and the huts of twigs, and the care of the lepers and the nomadic preaching. The Zealots were few in number but of great consequence from the fact that to them belonged most of the first disciples and the most intimate companions of St Francis. They had been grievously persecuted under Elias—Br. Leo and others had been scourged, several had been imprisoned, one while trying to escape was accidentally killed, and Br. Bernard, the "first disciple," passed a year in hiding in the forests and mountains hunted like a wild beast. At the other extreme was a party of relaxation, that abandoned any serious effort to practise Franciscan poverty and simplicity of life. Between these two stood the great middle party of moderates, who desired indeed that the Franciscans should be really poor and simple in their manner of life, and really pious, but on the other hand approved of the development of the Order on the lines of other orders, of the acquisition of influence, of the cultivation of the theology and other sciences, and of the frequenting of the universities.

The questions of principle at issue in these controversies is reasonably and clearly stated, from the modern Capuchin standpoint, in the "Introductory Essay" to *The Friars and how they came to England*, by Fr. Cuthbert (1903).

The moderate party was by far the largest, and embraced nearly all the friars of France, England and Germany. It was the Moderates and not the Zealots that brought about Elias's deposition, and the next general ministers belonged to this party. Further relaxations of the law of poverty, however, caused a reaction, and John of Parma, one of the Zealots, became minister-general, 1247-1257. Under him the more extreme of the Zealots took up and exaggerated the theories of the Eternal Gospel of the Calabrian Cistercian abbot Joachim of Fiore (Floris); some of their writings were condemned as heretical, and John of Parma, who was implicated in these apocalyptic tendencies, had to resign. He was succeeded by St Bonaventura (1257-1274), one of the best type of the middle party. He was a man of high character, a theologian, a mystic, a holy man and a strong ruler. He set himself with determination to effect a working compromise; and proceeded with firmness against the extremists on both sides. But controversy and recrimination and persecution had stiffened the more ardent among the Zealots into obstinate fanatics—some of them threw themselves into a movement that may best be briefly described as a recrudescence of Montanism (see Émile Gebhart's *Italie mystique*, 1899, cc. v. and vi.), and developed into a number of sects, some on the fringe of Catholic Christianity and others beyond its pale. But the majority of the Zealot party, or Spirituals, did not go so far, and adopted as the principle of Franciscan poverty the formula "a poor and scanty use" (*usus pauper et tenuis*) of earthly goods, as opposed to the "moderate use" advocated by the less strict party. The question thus posed came before the Council of Vienne, 1312, and was determined, on the whole, decidedly in favour of the stricter view. Some of the French Zealots were not satisfied and formed a semi-schismatical body in Provence; twenty-five of them were tried before the Inquisition, and four were burned alive at Marseilles as obstinate heretics, 1328. After this the schism in the Order subsided. But the disintegrating forces produced by the Great Schism and by the other disorders of the 14th century caused among the Franciscans the same relaxations and corruptions, and also the same reactions and reform movements, as among the other orders.

The chief of these reforms was that of the Observants, which began at Foligno about 1370. The Observant reform was on the basis of the "poor and scanty use" of worldly goods, but it was organized as an order and its members freely pursued

theological studies; thus it did not represent the position of the original Zealot party, nor was it the continuation of it. The Observant reform spread widely throughout Italy and into France, Spain and Germany. The great promoters of the movement were St Bernardine of Siena and St John Capistran. The council of Constance, 1415, allowed the French Observant friaries to be ruled by a vicar of their own, under the minister-general, and the same privilege was soon accorded to other countries. By the end of the middle ages the Observants had some 1400 houses divided into 50 provinces. This movement produced a "half-reform" among the Conventuals or friars of the mitigated observance; it also called forth a number of lesser imitations or congregations of strict observance.

After many attempts had been made to bring about a working union among the many observances, in 1517 Leo X. divided the Franciscan order into two distinct and independent bodies, each with its own minister-general, its own provinces and provincials and its own general chapter: (1) The Conventuals, who were authorized to use the various papal dispensations in regard to the observance of poverty, and were allowed to possess property and fixed income, corporately, like the monastic orders: (2) The Observants, who were bound to as close an observance of St Francis's Rule in regard to poverty and all else as was practically possible.

At this time a great number of the Conventuals went over to the Observants, who have ever since been by far the more numerous and influential branch of the order. Among the Observants in the course of the sixteenth century arose various reforms, each striving to approach more and more nearly to St Francis's ideal; the chief of these reforms were the Alcantarines in Spain (St Peter of Alcantara, St Teresa's friend, d. 1562), the Riformati in Italy and the Recollects in France: all of these were semi-independent congregations. The Capuchins (*g.v.*), established c. 1525, who claim to be the reform which approaches nearest in its conception to the original type, became a distinct order of Franciscans in 1619. Finally Leo XIII. grouped the Franciscans into three bodies or orders—the Conventuals; the Observants, embracing all branches of the strict observance, except the Capuchins; and the Capuchins—which together constitute the "First Order." For the "Second Order," or the nuns, see CLARA, ST, and CLARES, POOR; and for the "Third Order" see TERTIARIES. Many of the Tertiaries live a fully monastic life in community under the usual vows, and are formed into Congregations of Regular Tertiaries, both men and women. They have been and are still very numerous, and give themselves up to education, to the care of the sick and of orphans and to good works of all kinds.

No order has had so stormy an internal history as the Franciscans; yet in spite of all the troubles and dissensions and strivings that have marred Franciscan history, the Friars Minor of every kind have in each age faithfully and zealously carried on St Francis's great work of ministering to the spiritual needs of the poor. Always recruited in large measure from among the poor, they have ever been the order of the poor, and in their preaching and missions and ministrations they have ever laid themselves out to meet the needs of the poor. Another great work of the Franciscans throughout the whole course of their history has been their missions to the Mohammedans, both in western Asia and in North Africa, and to the heathens in China, Japan and India, and North and South America; a great number of the friars were martyred. The news of the martyrdom of five of its friars in Morocco was one of the joys of St Francis's closing years. Many of these missions exist to this day. In the Universities, too, the Franciscans made themselves felt alongside of the Dominicans, and created a rival school of theology, wherein, as contrasted with the Aristotelianism of the Dominican school, the Platonism of the early Christian doctors has been perpetuated.

The Franciscans came to England in 1224 and immediately made foundations in Canterbury, London and Oxford; by the middle of the century there were fifty friaries and over 1200 friars in England; at the Dissolution there were some 66 Franciscan friaries, whereof some six belonged to the Observants

(for list see *Catholic Dictionary* and F. A. Gasquet's *English Monastic Life*, 1904). Though nearly all the English houses belonged to what has been called the "middle party," as a matter of fact they practised great poverty, and the commissioners of Henry VIII. often remark that the Franciscan Friary was the poorest of the religious houses of a town. The English province was one of the most remarkable in the order, especially in intellectual achievement; it produced Friar Roger Bacon, and, with the single exception of St Bonaventure, all the greatest doctors of the Franciscan theological school—Alexander Hales, Duns Scotus and Occam.

The Franciscans have always been the most numerous by far of the religious orders; it is estimated that about the period of the Reformation the Friars Minor must have numbered nearly 100,000. At the present day the statistics are roughly (including lay-brothers): Observants, 15,000, Conventuals, 1500; to these should be added 9500 Capuchins, making the total number of Franciscan friars about 26,000. There are various houses of Observants and Capuchins in England and Ireland; and the old Irish Conventuals survived the penal times and still exist.

There have been four Franciscan popes: Nicholas IV. (1288-1292), Sixtus IV. (1471-1484), Sixtus V. (1585-1590), Clement XIV. (1769-1774); the three last were Conventuals.

The great source for Franciscan history is Wadding's *Annales*; it has been many times continued, and now extends in 25 vols. fol. to the year 1622. The story is also told by Helyot, *Hist. des ordres religieux* (1714), vol. vii. Abridgments, with references to recent literature, will be found in Max Heimbücher, *Ordens und Kongregationen* (1896), i. §§ 37-51; in Wetzer and Welte, *Kirchenlexicon* (2nd ed.), articles "Armut (III.)," "Franciscaner orden" ("this article contains the best account of the inner history and the polity of the order up to 1886"); in Herzog, *Realencyclopädie* (3rd ed.), articles "Franz von Assisi" (fullest references to literature up to 1899), "Fratricellen." Of modern critical studies on Franciscan origins, K. Müller's *Anfänge des Minoritenordens und der Bussbrüderschaften* (1885), and various articles by F. Ehrle in *Archiv für Literatur- und Kirchengeschichte des Mittelalters und Zeitschrift für Katholische Theologie*, deserve special mention. Eccleston's charming chronicle of "The Coming of the Friars Minor into England" has been translated into English by the Capuchin Fr. Cuthbert, who has prefixed an Introductory Essay giving by far the best account in English of "the Spirit and Genius of the Franciscan Friars" (*The Friars and how they came to England*, 1903). Fuller information on the English Franciscans will be found in A. G. Little's *Grey Friars in Oxford* (Oxford Hist. Soc., 1892). (E. C. B.)

FRANCK. The name of Franck has been given indiscriminately but improperly to painters of the school of Antwerp who belong to the families of Francken (*g.v.*) and Vranck (*g.v.*). One artist truly entitled to be called Franck is Gabriel, who entered the guild of Antwerp in 1605, became its president in 1636 and died in 1639. But his works cannot now be traced.

FRANCK, CÉSAR (1822-1890), French musical composer, a Belgian by birth, who came of German stock, was born at Liège on the 10th of December 1822. Though one of the most remarkable of modern composers, César Franck laboured for many years in comparative obscurity. After some preliminary studies at Liège he came to Paris in 1837 and entered the conservatoire. He at once obtained the first prize for piano, transposing a fugue at sight to the astonishment of the professors, for he was only fifteen. He won the prize for the organ in 1841, after which he settled down in the French capital as teacher of the piano. His earliest compositions date from this period, and include four trios for piano and strings, besides several piano pieces. *Ruth*, a biblical cantata was produced with success at the Conservatoire in 1846. An opera entitled *Le Valet de ferme* was written about this time, but has never been performed. For many years Franck led a retired life, devoting himself to teaching and to his duties as organist, first at Saint-Jean-Saint-François, then at Ste Clotilde, where he acquired a great reputation as an improviser. He also wrote a mass, heard in 1861, and a quantity of motets, organ pieces and other works of a religious character.

Franck was appointed professor of the organ at the Paris conservatoire, in succession to Benoist, his old master, in 1872, and the following year he was naturalized a Frenchman. Until then he was esteemed as a clever and conscientious musician.

but he was now about to prove his title to something more. A revival of his early oratorio, *Ruth*, had brought his name again before the public, and this was followed by the production of *Redemption*, a work for solo, chorus and orchestra, given under the direction of M. Colonne on the 10th of April 1873. The unconventionality of the music rather disconcerted the general public, but the work nevertheless made its mark, and Franck became the central figure of an enthusiastic circle of pupils and adherents whose devotion atoned for the comparative indifference of the masses. His creative power now manifested itself in a series of works of varied kinds, and the name of Franck began gradually to emerge from its obscurity. The following is an enumeration of his subsequent compositions: *Rebecca* (1881), a biblical idyll for solo, chorus and orchestra; *Les Béatitudes*, an oratorio composed between 1870 and 1880, perhaps his greatest work; the symphonic poems, *Les Éolides* (1876), *Le Chasseur maudit* (1883), *Les Djinns* (1884), for piano and orchestra; *Psyche* (1888), for orchestra and chorus; symphonic variations for piano and orchestra (1885); symphony in D (1889); quintet for piano and strings (1886); sonata for piano and violin (1886); string quartet (1889); prelude, choral and fugue for piano (1884); prelude, aria and finale for piano (1889); various songs, notably "La Procession" and "Les Cloches du Soir." Franck also composed two four-act operas, *Hulda* and *Giselle*, both of which were produced at Monte Carlo after his death, which took place in Paris on the 8th of November 1890. The second of these was left by the master in an unfinished state, and the instrumentation was completed by several of his pupils.

César Franck's influence on younger French composers has been very great. Yet his music is German in character rather than French. A more sincere, modest, self-respecting composer probably never existed. In the centre of the brilliant French capital he was able to lead a laborious existence consecrated to his threefold career of organist, teacher and composer. He never sought to gain the suffrages of the public by unworthy concessions, but kept straight on his path, ever mindful of an ideal to be reached and never swerving therefrom. A statue was erected to the memory of César Franck in Paris on the 22nd of October 1904, the occasion producing a panegyric from Alfred Bruneau, in which he speaks of the composer's works as "cathedrals in sound."

FRANCK, or FRANK [Latinized FRANCUS], SEBASTIAN (c. 1499-c. 1543), German freethinker, was born about 1499 at Donauwörth, whence he constantly styled himself Franck von Wörd. He entered the university of Ingolstadt (March 26, 1515), and proceeded thence to the Dominican College, incorporated with the university, at Heidelberg. Here he met his subsequent antagonists, Bucer and Frecht, with whom he seems to have attended the Augsburg conference (October 1518) at which Luther declared himself a true son of the Church. He afterwards reckoned the Leipzig disputation (June-July 1519) and the burning of the papal bull (December 1520) as the beginning of the Reformation. Having taken priest's orders, he held in 1524 a cure in the neighbourhood of Augsburg, but soon (1525) went over to the Reformed party at Nuremberg and became preacher at Gutfensteden. His first work (finished September 1527) was a German translation with additions (1528) of the first part of the *Diallage*, or *Conciliatio locorum Scripturæ*, directed against Sacramentarians and Anabaptists by Andrew Althamer, then deacon of St Sebald's at Nuremberg. On the 17th of March 1528 he married Otilie Beham, a gifted lady, whose brothers, pupils of Albrecht Dürer, had got into trouble through Anabaptist leanings. In the same year he wrote a very popular treatise against drunkenness. In 1529 he produced a free version (*Klagbrief der armen Dürftigen in England*) of the famous *Supplication of the Beggars*, written abroad (1528?) by Simon Fish. Franck, in his preface, says the original was in English; elsewhere he says it was in Latin, the theory that his German was really the original is unwarrantable. Advance in his religious ideas led him to seek the freer atmosphere of Strassburg in the autumn of 1529. To his translation (1530) of a Latin *Chronicle*

and *Description of Turkey*, by a Transylvanian captive, which had been prefaced by Luther, he added an appendix holding up the Turks as in many respects an example to Christians, and presenting, in lieu of the restrictions of Lutheran, Zwinglian and Anabaptist sects, the vision of an invisible spiritual church, universal in its scope. To this ideal he remained faithful. At Strassburg began his intimacy with Caspar Schwenkfeld, a congenial spirit. Here, too, he published, in 1531, his most important work, the *Chronica, Zeitbuch und Geschichtsbibel*, largely a compilation on the basis of the Nuremberg Chronicle (1493), and in its treatment of social and religious questions connected with the Reformation, exhibiting a strong sympathy with heretics, and an unexampled fairness to all kinds of freedom in opinion. It is too much to call him "the first of German historians"; he is a forerunner of Gottfried Arnold, with more vigour and directness of purpose. Driven from Strassburg by the authorities, after a short imprisonment in December 1531, he tried to make a living in 1532 as a soapboiler at Esslingen, removing in 1533 for a better market to Ulm, where (October 28 1534) he was admitted as a burges.

His *Wellbuch*, a supplement to his *Chronica*, was printed at Tübingen in 1534; the publication, in the same year, of his *Paradoxa* at Ulm brought him into trouble with the authorities. An order for his banishment was withdrawn on his promise to submit future works for censure. Not interpreting this as applying to works printed outside Ulm, he published in 1538 at Augsburg his *Guldin Arch* (with pagan parallels to Christian sentiments) and at Frankfurt his *Germania chronicon*, with the result that he had to leave Ulm in January 1539. He seems henceforth to have had no settled abode. At Basel he found work as a printer, and here, probably, it was that he died in the winter of 1542-1543. He had published in 1539 his *Kriegbüchlein des Friedens* (pseudonymous), his *Schriftliche und ganz gründliche Auslegung des 64 Psalms*, and his *Das verbüscherte mit sieben Siegeln verschlossene Buch* (a biblical index, exhibiting the dissonance of Scripture); in 1541 his *Spruchwörter* (a collection of proverbs, several times reprinted with variations); in 1542 a new edition of his *Paradoxa*; and some smaller works.

Franck combined the humanist's passion for freedom with the mystic's devotion to the religion of the spirit. His breadth of human sympathy led him to positions which the comparative study of religions has made familiar, but for which his age was unprepared. Luther contemptuously dismissed him as a "devil's mouth." Pastor Frecht of Nuremberg pursued him with bitter zeal. But his courage did not fail him, and in his last year, in a public Latin letter, he exhorted his friend John Campanus to maintain freedom of thought in face of the charge of heresy.

See Hegler, in Hauck's *Realencyklopädie* (1899); C. A. Hase, *Sebastian Franck von Wörd* (1869); J. F. Smith, in *Theological Review* (April 1874); E. Tausch, *Sebastian Franck von Donauwörth und seine Lehrer* (1893). (A. Co.)

FRANCKE, AUGUST HERMANN (1663-1727), German Protestant divine, was born on the 22nd of March 1663 at Lübeck. He was educated at the gymnasium in Gotha, and afterwards at the universities of Erfurt, Kiel, where he came under the influence of the pietist Christian Kortholt (1633-1694), and Leipzig. During his student career he made a special study of Hebrew and Greek; and in order to learn Hebrew more thoroughly, he for some time put himself under the instructions of Rabbi Ezra Edzardi at Hamburg. He graduated at Leipzig, where in 1685 he became a *Privatdozent*. A year later, by the help of his friend P. Anton, and with the approval and encouragement of P. J. Spener, he founded the Collegium Philobiblicum, at which a number of graduates were accustomed to meet for the systematic study of the Bible, philologically and practically. He next passed some months at Lüneburg as assistant or curate to the learned superintendent, C. H. Sandhagen (1639-1697), and there his religious life was remarkably quickened and deepened. On leaving Lüneburg he spent some time in Hamburg, where he became a teacher in a private school, and made the acquaintance of Nikolaus Lange (1659-1720) After a long visit to Spene,

who was at that time a court preacher in Dresden, he returned to Leipzig in the spring of 1689, and began to give Bible lectures of an exegetical and practical kind, at the same time resuming the Collegium Philobiblicum of earlier days. He soon became popular as a lecturer; but the peculiarities of his teaching almost immediately aroused a violent opposition on the part of the university authorities; and before the end of the year he was interdicted from lecturing on the ground of his alleged pietism. Thus it was that Francke's name first came to be publicly associated with that of Spener, and with pietism. Prohibited from lecturing in Leipzig, Francke in 1690 found work at Erfurt as "deacon" of one of the city churches. Here his evangelistic fervour attracted multitudes to his preaching, including Roman Catholics, but at the same time excited the anger of his opponents; and the result of their opposition was that after a ministry of fifteen months he was commanded by the civil authorities (27th of September 1691) to leave Erfurt within forty-eight hours. The same year witnessed the expulsion of Spener from Dresden.

In December, through Spener's influence, Francke accepted an invitation to fill the chair of Greek and oriental languages in the new university of Halle, which was at that time being organized by the elector Frederick III. of Brandenburg; and at the same time, the chair having no salary attached to it, he was appointed pastor of Glaucha in the immediate neighbourhood of the town. He afterwards became professor of theology. Here, for the next thirty-six years, until his death on the 8th of June 1727, he continued to discharge the twofold office of pastor and professor with rare energy and success. At the very outset of his labours he had been profoundly impressed with a sense of his responsibility towards the numerous outcast children who were growing up around him in ignorance and crime. After a number of tentative plans, he resolved in 1695 to institute what is often called a "ragged school," supported by public charity. A single room was at first sufficient, but within a year it was found necessary to purchase a house, to which another was added in 1697. In 1698 there were 100 orphans under his charge to be clothed and fed, besides 500 children who were taught as day scholars. The schools grew in importance and are still known as the *Francke'sche Stiftungen*. The education given was strictly religious. Hebrew was included, while the Greek and Latin classics were neglected; the *Homilies* of Macarius took the place of Thucydides. The same principle was consistently applied in his university teaching. Even as professor of Greek he had given great prominence in his lectures to the study of the Scriptures; but he found a much more congenial sphere when in 1698, he was appointed to the chair of theology. Yet his first courses of lectures in that department were readings and expositions of the Old and New Testament; and to this, as also to hermeneutics, he always attached special importance, believing that for theology a sound exegesis was the one indispensable requisite. "Theologus nascitur in scripturis," he used to say; but during his occupancy of the theological chair he lectured at various times upon other branches of theology also. Amongst his colleagues were Paul Anton (1661-1730), Joachim J. Breithaupt (1658-1732) and Joachim Lange (1670-1744),—men like-minded with himself. Through their influence upon the students, Halle became a centre from which pietism (*q.v.*) became very widely diffused over Germany.

His principal contributions to theological literature were: *Manuductio ad lectionem Scripturæ Sacræ* (1693); *Prælectiones Hermeneuticæ* (1717); *Commentatio de scopo librorum Veteris et Novi Testamenti* (1724); and *Lectiones paræneticæ* (1726-1736). The *Manuductio* was translated into English in 1813, under the title *A Guide to the Reading and Study of the Holy Scriptures*. An account of his orphanage, entitled *Segenvolle Fussstapfen*, &c. (1709), which subsequently passed through several editions, has also been partially translated, under the title *The Footsteps of Divine Providence: or, The bountiful Hand of Heaven defraying the Expenses of Faith*. See H. E. F. Guericke's *A. H. Francke* (1827), which has been translated into English (*The Life of A. H. Francke*, 1837); Gustave Kramer's *Beiträge zur Geschichte A. H. Francke's* (1861), and *Neue Beiträge* (1875); A. Stein, *A. H. Francke* (3rd ed. 1894); article in Herzog-Hauck's *Realencyclopædie* (ed. 1899); Knauth, *Die Francke'schen Stiftungen* (2nd ed., 1903).

FRANCKEN. Eleven painters of this family cultivated their art in Antwerp during the 16th and 17th centuries. Several of these were related to each other, whilst many bore the same Christian name in succession. Hence unavoidable confusion in the subsequent classification of paintings not widely differing in style or execution. When Franz Francken the first found a rival in Franz Francken the second, he described himself as the "elder," in contradistinction to his son, who signed himself the "younger." But when Franz the second was threatened with competition from Franz the third, he took the name of "the elder," whilst Franz the third adopted that of Frans "the younger."

It is possible, though not by any means easy, to sift the works of these artists. The eldest of the Franckens, Nicholas of Herenthals, died at Antwerp in 1596, with nothing but the reputation of having been a painter. None of his works remain. He bequeathed his art to three children. Jerom Francken, the eldest son, after leaving his father's house, studied under Franz Floris, whom he afterwards served as an assistant, and wandered, about 1560, to Paris. In 1566 he was one of the masters employed to decorate the palace of Fontainebleau, and in 1574 he obtained the appointment of court painter from Henry III., who had just returned from Poland and visited Titian at Venice. In 1603, when Van Mander wrote his biography of Flemish artists, Jerom Francken was still in Paris living in the then aristocratic Faubourg St Germain. Among his earliest works we should distinguish a "Nativity" in the Dresden museum, executed in co-operation with Franz Floris. Another of his important pieces is the "Abdication of Charles V." in the Amsterdam museum. Equally interesting is a "Portrait of a Falconer," dated 1558, in the Brunswick gallery. In style these pieces all recall Franz Floris. Franz, the second son of Nicholas of Herenthals, is to be kept in memory as Franz Francken the first. He was born about 1544, matriculated at Antwerp in 1567, and died there in 1616. He, too, studied under Floris, and never settled abroad, or lost the hard and gaudy style which he inherited from his master. Several of his pictures are in the museum of Antwerp; one dated 1597 in the Dresden museum—represents "Christ on the Road to Golgotha," and is signed by him as D. 5 (Den ouden) F. Franck. Ambrose, the third son of Nicholas of Herenthals, has bequeathed to us more specimens of his skill than Jerom or Franz the first. He first started as a partner with Jerom at Fontainebleau, then he returned to Antwerp, where he passed for his gild in 1573, and he lived at Antwerp till 1618. His best works are the "Miracle of the Loaves and Fishes" and the "Martyrdom of St Crispin," both large and ambitious compositions in the Antwerp museum. In both these pieces a fair amount of power is displayed, but marred by want of atmosphere and shadow or by hardness of line and gaudiness of tone. There is not a trace in the three painters named of the influence of the revival which took place under the lead of Rubens. Franz Francken the first trained three sons to his profession, the eldest of whom, though he practised as a master of gild at Antwerp from 1600 to 1610, left no visible trace of his labours behind. Jerom the second took service with his uncle Ambrose. He was born in 1578, passed for his gild in 1607, and in 1620 produced that curious picture of "Horatius Cocles defending the Sublician Bridge" which still hangs in the Antwerp museum. The third son of Franz Francken the first is Franz Francken the second, who signed himself in pictures till 1616 "the younger," from 1630 till his death "the elder" F. Francken. These pictures are usually of a small size, and are found in considerable numbers in continental collections. Franz Francken the second was born in 1581. In 1605 he entered the gild, of which he subsequently became the president, and in 1642 he died. His earliest composition is the "Crucifixion" in the Belvedere at Vienna, dated 1606. His latest compositions as "the younger" F. Francken are the "Adoration of the Virgin" (1616) in the gallery of Amsterdam, and the "Woman taken in Adultery" (1628) in Dresden. From 1616 to 1630 many of his pieces signed F. Francken; then come the "Seven Works of Charity" (1630) at Munich, signed "the elder F. F.," the "Prodigal S

(1633) at the Louvre, and other almost countless examples. It is in F. Francken the second's style that we first have evidence of the struggle which necessarily arose when the old customs, hardened by Van Orley and Floris, or Breughel and De Vos, were swept away by Rubens. But F. Francken the second, as before observed, always clung to small surfaces; and though he gained some of the freedom of the moderns, he lost but little of the dryness or gaudiness of the earlier Italo-Flemish revivalists. F. Francken the third, the last of his name who deserves to be recorded, passed in the Antwerp guild in 1630 and died at Antwerp in 1667. His practice was chiefly confined to adding figures to the architectural or landscape pieces of other artists. As Franz Pourbus sometimes put in the portrait figures for Franz Francken the second, so Frans Francken the third often introduced the necessary personages into the works of Pieter Neefs the younger (museums of St Petersburg, Dresden and the Hague). In a "Moses striking the Rock," dated 1654, of the Augsburg gallery, this last of the Franckens signs D. ð (Den ouden) F. Franck. In the pictures of this artist we most clearly discern the effects of Rubens's example.

FRANCO-GERMAN WAR (1870-1871). The victories of Prussia in 1866 over the Austrians and their German allies (see SEVEN WEEKS' WAR) rendered it evident to the statesmen and soldiers of France that a struggle between the two nations could only be a question of time. Army reforms were at once undertaken, and measures were initiated in France to place the armament and equipment of the troops on a level with the requirements of the times. The chassepot, a new breech-loading rifle, immensely superior to the Prussian needle-gun, was issued; the artillery trains were thoroughly overhauled, and a new machine-gun, the *mitrailleuse*, from which much was expected, introduced. Wide schemes of reorganization (due mainly to Marshal Niel) were set in motion, and, since these required time to mature, recourse was had to foreign alliances in the hope of delaying the impending rupture. In the first week of June 1870, General Lebrun, as a confidential agent of the emperor Napoleon III., was sent to Vienna to concert a plan of joint operations with Austria against Prussia. Italy was also to be included in the alliance, and it was agreed that in case of hostilities the French armies should concentrate in northern Bavaria, where the Austrians and Italians were to join them, and the whole immense army thus formed should march via Jena on Berlin. To what extent Austria and Italy committed themselves to this scheme remains uncertain, but that the emperor Napoleon believed in their *bona fides* is beyond doubt.

Whether the plan was betrayed to Prussia is also uncertain, and almost immaterial, for Moltke's plans were based on an accurate estimate of the time it would take Austria to mobilize and on the effect of a series of victories on French soil. At any rate Moltke was not taken into Bismarck's confidence in the affair of Ems in July 1870, and it is to be presumed that the chancellor had already satisfied himself that the schemes of operations prepared by the chief of the General Staff fully provided against all eventualities. These schemes were founded on Clausewitz's view of the objects to be pursued in a war against France—in the first place the defeat of the French field armies and in the second the occupation of Paris. On these lines plans for the strategic deployment of the Prussian army were prepared by the General Staff and kept up to date year by year as fresh circumstances (e.g. the co-operation of the minor German armies) arose and new means of communication came into existence. The campaign was actually opened on a revise of 1868-1869, to which was added, on the 6th of May 1870, a secret memorandum for the General Staff.

Under the German organization then existing the preliminary to all active operations was of necessity full and complete mobilization. Then followed transport by road and rail to the line selected for the "strategic deployment," and it was essential that no part of these operations should be disturbed by action on the part of the enemy. But no such delay imposed itself of necessity upon the French, and a vigorous offensive was so much

in harmony with their traditions that the German plan had to be framed so as to meet such emergencies. On the whole, Moltke concluded that the enemy could not undertake this offensive before the eighth day after mobilization. At that date about five French army corps (150,000 men) could be collected near Metz, and two corps (70,000) near Strassburg; and as it was six days' march from Metz to the Rhine, no serious attack could be delivered before the fourteenth day, by which day it could be met by superior forces near Kirchheimbolanden. Since, however, the transport of the bulk of the Prussian forces could not begin till the ninth day, their ultimate line of detrainment need not be fixed until the French plans were disclosed, and, as it was important to strike at the earliest moment possible, the deployment was provisionally fixed to be beyond the Rhine on the line Wittlich-Neunkirchen-Landau. Of the thirteen North German corps (three had to be left behind to guard the eastern frontier and the coast, one other, the VIII., was practically on the ground already and could concentrate by road, and the remaining nine were distributed to the nine through railway lines available. These ten corps were grouped in three armies, and as the French might violate Belgian neutrality or endeavour to break into southern Germany, two corps (Prussian Guard and Saxon XII. corps) were temporarily held back at a central position around Mainz, whence they could move rapidly up or down the Rhine valley. If Belgian neutrality remained unmolested, the reserve would join the III. army on the left wing, giving it a two to one superiority over its adversary; all three armies would then wheel to the right and combine in an effort to force the French army into a decisive battle on the Saar on or about the twenty-third day. As in this wheel the army on the right formed the pivot and was required only to stand fast, two corps only were allotted to it; two corps for the present formed the III. army, and the remaining five were assigned to the II. army in the centre.

When (16th-17th July) the South German states decided to throw in their lot with the rest, their three corps were allotted to the III. army, the Guards and Saxons to the II. army, whilst the three corps originally left behind were finally distributed one to each army, so that up to the investment of Metz the order of battle was as follows:

		Headquarters:	
	The king of Prussia	(General v. Moltke, chief of staff.)	
	I. Army:	(I. corps, v. Manteuffel)	
	General v. Steinmetz	VII. " v. Zastrow	
	(C. of S., v. Spering)	VIII. " v. Goeben	
		(1st and 3rd cavalry divisions	
		Total . . .	85,000
		Guard Pr. August of Württemberg	
		(II. corps, v. Fransecky)	
	II. Army:	III. " v. Alvensleben II.	
	Prince Frederick Charles	IV. " v. Alvensleben I.	
	(C. of S., v. Stiehle)	IX. " v. Manstein	
		X. " v. Voigts-Rhetz	
		XII. " (Saxons) crown prince of Saxony	
		5th and 6th cavalry divisions	
		Total . . .	210,000
		V. corps, v. Kirchbach	
		(VI. " v. Tümpling	
		XI. " v. Bose	
	III. Army:	I. Bavarian, v. der Tann	
	crown prince of Prussia	II. " v. Hartmann	
	(C. of S., v. Blumenthal)	Württemberg div. } v. Werder	
		Baden div. }	
		(2nd and 4th cavalry divisions	
		Total . . .	180,000
		Grand Total . . .	475,000
		(The units within brackets were those at first retained in Germany.)	

On the French side no such plan of operations was in existence when on the night of the 15th of July *Krieg mobil* was telegraphed all over Prussia. An outline scheme had indeed been prepared as a basis for agreement with Austria and Italy, but practically no details were fixed, and the troops were without transport and supplies. Nevertheless, since speed was the essence of the contract, the troops

Strategic
deployment
of the
German
armies.

Positions
of the
French
armies.

were hurried up without waiting for their reserves, and delivered, as Moltke had foreseen, just where the lie of the railways and convenience of temporary supply dictated, and the Prussian Intelligence Department was able to inform Moltke on the 22nd of July (seventh day of mobilization) that the French stood from right to left in the following order, on or near the frontier:

1st corps	..	Marshal MacMahon, duke of Magenta, Strasbourg
5th corps	..	General de Failly, Saargemund and Bitche
2nd corps	..	General Frossard, St Avold
4th corps	..	General de Ladmirault, Thionville
		With behind them:
3rd corps	..	Marshal Bazaine, Metz
Guard	..	General Bourbaki, Nancy
6th corps	..	Marshal Canrobert, Châlons
7th corps	..	General Félix Douay, Belfort

If therefore they began a forward movement on the 23rd (eighth day) the case foreseen by Moltke had arisen, and it became necessary to detain the II. army upon the Rhine. Without waiting for further confirmation of this intelligence, Moltke, with the consent of the king, altered the arrangements accordingly, a decision which, though foreseen, exercised the gravest influence on the course of events. As it happened this decision was premature, for the French could not yet move. Supply trains had to be organized by requisition from the inhabitants, and even arms and ammunition procured for such reserves as had succeeded in joining. Nevertheless, by almost superhuman exertions on the part of the railways and administrative services, all essential deficiencies were made good, and by the 28th of July (13th day) the troops had received all that was absolutely indispensable and might well have been led against the enemy, who, thanks to Moltke's premature action, were for the moment at a very serious disadvantage. But the French generals were unequal to their responsibilities. It is now clear that, had the great Napoleon and his marshals been in command, they would have made light of the want of cooking pots, cholera belts, &c., and, by a series of rapid marches, would have concentrated odds of at least three to one upon the heads of the Prussian columns as they struggled through the defiles of the Hardt, and won a victory whose political results might well have proved decisive.

To meet this pressing danger, which came to his knowledge during the course of the 29th, Moltke sent a confidential staff officer, Colonel v. Verdy du Vernois, to the III. army to impress upon the crown prince the necessity of an immediate advance to distract the enemy's attention from the I. and II. armies; but, like the French generals, the crown prince pleaded that he could not move until his trains were complete. Fortunately for the Germans, the French intelligence service not only failed to inform the staff of this extraordinary opportunity, but it allowed itself to be hypnotized by the most amazing rumours. In imagination they saw armies of 100,000 men behind every forest, and to guard against these dangers, the French troops were marched and counter-marched along the frontiers in the vain hope of discovering an ideal defensive position which should afford full scope to the power of their new weapons.

As these delays were exerting a most unfavourable effect on public opinion not only in France but throughout Europe, the emperor decided on the 1st of August to initiate a movement towards the Saar, chiefly as a guarantee of good faith to the Austrians and Italians.

On this day the French corps held the following positions from right to left:

1st corps	..	Hagenau
2nd corps	..	Forbach
3rd corps	..	St Avold
4th corps	..	Bouzonville
5th corps	..	Bitche
6th corps	..	Châlons
7th corps	..	Belfort and Colmar
Guard	..	near Metz

The French 2nd corps was directed to advance on the following morning direct on Saarbrücken, supported on the flanks by two divisions from the 5th and 3rd corps. The order was duly carried out, and the Prussians (one battalion, two squadrons and a

battery), seeing the overwhelming numbers opposed to them, fell back fighting and vanished to the northward, having given a very excellent example of steadiness and discipline to their enemy.¹ The latter contented themselves by occupying Saarbrücken and its suburb St Johann, and here, as far as the troops were concerned, the incident closed. Its effect, however, proved far-reaching. The Prussian staff could not conceive that nothing lay behind this display of five whole divisions, and immediately took steps to meet the expected danger. In their excitement, although they had announced the beginning of the action to the king's headquarters at Mainz, they forgot to notify the close and its results, so that Moltke was not in possession of the facts till noon on the 3rd of August. Meanwhile, Steinmetz, left without instructions and fearing for the safety of the II. army, the heads of whose columns were still in the defiles of the Hardt, moved the I. army from the neighbourhood of Merzig obliquely to his left front, so as to strike the flank of the French army if it continued its march towards Kaiserslautern, in which direction it appeared to be heading.

Whilst this order was in process of execution, Moltke, aware that the II. army was behind time in its march, issued instructions to Steinmetz for the 4th of August which entailed a withdrawal to the rear, the idea being that both armies should, if the French advanced, fight a defensive battle in a selected position farther back. Steinmetz obeyed, though bitterly resenting the idea of retreat.

This movement, further, drew his left across the roads reserved for the right column of the II. army, and on receipt of a peremptory order from Prince Frederick Charles to evacuate the road, Steinmetz telegraphed for instructions direct to the king, over Moltke's head. In reply he received a telegram from Moltke, ordering him to clear the road at once, and couched in terms which he considered as a severe reprimand. An explanatory letter, meant to soften the rebuke, was delayed in transmission and did not reach him till too late to modify the orders he had already issued. It must be remembered that Steinmetz at the front was in a better position to judge the apparent situation than was Moltke at Mainz, and that all through the day of the 5th of August he had received intelligence indicating a change of attitude in the French army.

The news of the German victory at Weissenburg on the 4th (see below) had in fact completely paralysed the French headquarters, and orders were issued by them during the course of the 5th to concentrate the whole army of the Rhine on the selected position of Cadenbronn. As a preliminary, Frossard's corps withdrew from Saarbrücken and began to entrench a position on the Spicheren heights, 3000 yds. to the southward. Steinmetz, therefore, being quite unaware of the scheme for a great battle on the Saar about the 12th of August, felt that the situation would best be met, and the letter of his instructions strictly obeyed, by moving his whole command forward to the line of the Saar, and orders to this effect were issued on the evening of the 5th. In pursuance of these orders, the advance guard of the 14th division (Lieutenant General von Kameke) reached Saarbrücken about 9 A.M. on the 6th, where the Germans found to their amazement that the bridges were intact. To secure this advantage was the obvious duty of the commander on the spot, and he at once ordered his troops to occupy a line of low heights beyond the town to serve as a bridge-head. As the leading troops deployed on the heights Frossard's guns on the Spicheren Plateau opened fire, and the advanced guard battery replied. The sound of these guns unchained the whole fighting instinct carefully developed by a long course of Prussian manoeuvre training. Everywhere, generals and troops hurried towards the cannon thunder. Kameke, even more in the dark than Steinmetz as to Moltke's intentions and the strength of his adversaries, attacked at once, precisely as he would have done at manoeuvres, and in half an hour his men were committed beyond recall. As each fresh unit reached the field it was hurried into action where its services

¹ This was the celebrated "baptême de feu" of the prince imperial.

Action of Saarbrücken.

Moltke, Prince Frederick Charles and Steinmetz.

Battle of Spicheren.

were most needed, and each fresh general as he arrived took a new view of the combat and issued new orders. On the other side, Frossard, knowing the strength of his position, called on his neighbours for support, and determined to hold his ground. Victory seemed certain. There were sufficient troops within easy reach to have ensured a crushing numerical superiority. But the other generals had not been trained to mutual support, and thought only of their own immediate security, and their staffs were too inexperienced to act upon even good intentions; and, finding himself in the course of the afternoon left to his own devices, Frossard began gradually to withdraw, even before the pressure of the 13th German division on his left flank (about 8 P.M.) compelled his retirement. When darkness ended the battle the Prussians were scarcely aware of their victory. Steinmetz, who had reached the field about 6 P.M., rode back to his headquarters without issuing any orders, while the troops bivouacked where they stood, the units of three army corps being mixed up in almost inextricable confusion. But whereas out of 42,000 Prussians with 120 guns, who in the morning lay within striking distance of the enemy, no fewer than 27,000, with 78 guns were actually engaged; of the French, out of 64,000 with 210 guns only 24,000 with 90 guns took part in the action.

Meanwhile on the German left wing the III. army had begun its advance. Early on the 4th of August it crossed the frontier and fell upon a French detachment under Abel Douay, which had been placed near Weissenburg, partly to cover the Pigeonnier pass, but principally to consume the supplies accumulated in the little dismantled fortress, as these could not easily be moved. Against this force of under 4000 men of all arms, the Germans brought into action successively portions of three corps, in all over 25,000 men with 90 guns. After six hours' fighting, in which the Germans lost some 1500 men, the gallant remnant of the French withdrew deliberately and in good order, notwithstanding the death of their leader at the critical moment. The Germans were so elated by their victory over the enemy, whose strength they naturally overestimated, that they forgot to send cavalry in pursuit, and thus entirely lost touch with the enemy.

Next day the advance was resumed, the two Bavarian corps moving via Mattstall through the foothills of the Vosges, the V. corps on their left towards Preuschdorf, and the XI. farther to the left again, through the wooded plain of the Rhine valley. The 4th cavalry division scouted in advance, and army headquarters moved to Sulz. About noon the advanced patrols discovered MacMahon's corps in position on the left bank of the Sauer (see WÖRTE: *Battle of*). As his army was dispersed over a wide area, the crown prince determined to devote the 6th to concentrating the troops, and, probably to avoid alarming the enemy, ordered the cavalry to stand fast.

At night the outposts of the I. Bavarians and V. corps on the Sauer saw the fires of the French encampment and heard the noise of railway traffic, and rightly conjectured the approach of reinforcements. MacMahon had in fact determined to stand in the very formidable position he had selected, and he counted on receiving support both from the 7th corps (two divisions of which were being rallied up from Colmar) and from the 5th corps, which lay around Bitche. It was also quite possible, and the soundest strategy, to withdraw the bulk of the troops then facing the German I. and II. armies to his support, and these would reach him by the 8th. He was therefore justified in accepting battle, though it was to his interest to delay it as long as possible.

At dawn on the 6th of August the commander of the V. corps outposts noticed certain movements in the French lines, and to clear up the situation brought his guns into action. As at Spichenen, the sound of the guns set the whole machinery of battle in motion. The French artillery immediately accepted the Prussian challenge. The I. Bavarians, having been ordered to be ready to move if they heard artillery fire, immediately advanced against the French left, encountering presently such a stubborn resistance that parts of their line began to give way. The Prussians of the V. corps felt that they

could not abandon their allies, and von Kirchbach, calling on the XI. corps for support, attacked with the troops at hand. When the crown prince tried to break off the fight it was too late. Both sides were feeding troops into the firing line, as and where they could lay hands on them. Up to 2 P.M. the French fairly held their own, but shortly afterwards their right yielded to the overwhelming pressure of the XI. corps, and by 3.30 it was in full retreat. The centre held on for another hour, but in its turn was compelled to yield, and by 4.30 all organized resistance was at an end. The débris of the French army was hotly pursued by the German divisional squadrons towards Reichshofen, where serious panic showed itself. When at this stage the supports sent by de Failly from Bitche came on the ground they saw the hopelessness of intervention, and retired whence they had come. Fortunately for the French, the German 4th cavalry division, on which the pursuit should have devolved, had been forgotten by the German staff, and did not reach the front before darkness fell. Out of a total of 82,000 within reach of the battlefield, the Germans succeeded in bringing into action 77,500. The French, who might have had 50,000 on the field, deployed only 37,000, and these suffered a collective loss of no less than 20,100; some regiments losing up to 90% and still retaining some semblance of discipline and order.

Under cover of darkness the remnants of the French army escaped. When at length the 4th cavalry division had succeeded in forcing a way through the confusion of the battlefield, all touch with the enemy had been lost, and being without firearms the troopers were checked by the French stragglers in the woods and the villages, and thus failed to establish the true line of retreat of the French. Ultimately the latter, having gained the railway near Lunéville, disappeared from the German front altogether, and all trace of them was lost until they were discovered, about the 26th of August, forming part of the army of Châlons, whither they had been conveyed by rail via Paris. This is a remarkable example of the strategical value of railways to an army operating in its own country.

In the absence of all resistance, the III. army now proceeded to carry out the original programme of marches laid down in Moltke's memorandum of the 6th of May, and marching on a broad front through a fertile district it reached the line of the Moselle in excellent order about the 17th of August, where it halted to await the result of the great battle of Gravelotte-St Privat.

We return now to the I. army at Saarbrücken. Its position on the morning of the 7th of August gave cause for the gravest anxiety. At daylight a dense fog lay over the country, and through the mist sounds of heavy firing came from the direction of Forbach, where French stragglers had rallied during the night. The confusion on the battlefield was appalling, and the troops in no condition to go forward. Except the 3rd, 5th and 6th cavalry divisions no closed troops were within a day's march; hence Steinmetz decided to spend the day in reorganizing his infantry, under cover of his available cavalry. But the German cavalry and staff were quite new to their task. The 6th cavalry division, which had bivouacked on the battlefield, sent on only one brigade towards Forbach, retaining the remainder in reserve. The 5th, thinking that the 6th had already undertaken all that was necessary, withdrew behind the Saar, and the 3rd, also behind the Saar, reported that the country in its front was unsuited to cavalry movements, and only sent out a few officers' patrols. These were well led, but were too few in number, and their reports were consequently unconvincing.

In the course of the day Steinmetz became very uneasy, and ultimately he decided to concentrate his army by retiring the VII. and VIII. corps behind the river on to the I. (which had arrived near Saarlouis), thus clearing the Saarbrücken-Metz road for the use of the II. army. But at this moment Prince Frederick Charles suddenly modified his views. During the 6th of August his scouts had reported considerable French forces near Bitche (these were the 5th, de Failly's corps), and early in the morning of the 7th he received a telegram from Moltke

*Action of
Weissen-
burg.*

*Movements on
the Saar.*

*Battle of
Wörth.*

1
2
3
4
5
6
7
8
9
10
11
12
13
14
15
16
17
18
19
20
21
22
23
24
25
26
27
28
29
30
31
32
33
34
35
36
37
38
39
40
41
42
43
44
45
46
47
48
49
50
51
52

informing him that MacMahon's beaten army was retreating on the same place (the troops observed were in fact those which had marched to MacMahon's assistance). The prince forthwith deflected the march of the Guards, IV. and X. corps, towards Rohrbach, whilst the IX. and XII. closed up to supporting distance behind them. Thus, as Steinmetz moved away to the west and north, Frederick Charles was diverging to the south and east, and a great gap was opening in the very centre of the German front. This was closed only by the III. corps, still on the battle-field, and by portions of the X. near Saargemünd,¹ whilst within striking distance lay 130,000 French troops, prevented only by the incapacity of their chiefs from delivering a decisive counter-stroke.

Fortunately for the Prussians, Moltke at Mainz took a different view. Receiving absolutely no intelligence from the front during the 7th, he telegraphed orders to the I. and II. armies (10.25 P.M.) to halt on the 8th, and impressed on Steinmetz the necessity of employing his cavalry to clear up the situation. The I. army had already begun the marches ordered by Steinmetz. It was now led back practically to its old bivouacs amongst the unburied dead. Prince Frederick Charles only conformed to Moltke's order with the III. and X. corps; the remainder executed their concentration towards the south and east.

During the night of the 7th of August Moltke decided that the French army must be in retreat towards the Moselle and forthwith busied himself with the preparation of fresh tables of march for the two armies, his object being to swing up the left wing to outflank the enemy from the south. This work, and the transfer of headquarters to Homburg, needed time, hence no fresh orders were issued to either army, and neither commander would incur the responsibility of moving without any. The I. army therefore spent a fourth night in bivouac on the battle-field. But Constantin von Alvensleben, commanding the III. corps, a man of very different stamp from his colleagues, hearing at first hand that the French had evacuated St Avold, set his corps in motion early in the morning of the 10th August down the St Avold-Metz road, reached St Avold and obtained conclusive evidence that the French were retreating.

During the 9th the orders for the advance to the Moselle were issued. These were based, not on an exact knowledge of where the French army actually stood, but on the opinion *Advanced to the Moselle.* Moltke had formed as to where it ought to have been on military grounds solely, overlooking the fact that the French staff were not free to form military decisions but were compelled to bow to political expediency.

Actually on the 7th of August the emperor had decided to attack the Germans on the 8th with the whole Rhine Army, but this decision was upset by alarmist reports from the beaten army of MacMahon. He then decided to retreat to the Moselle, as Moltke had foreseen, and there to draw to himself the remnants of MacMahon's army (now near Lunéville). At the same time he assigned the executive command over the whole Rhine Army to Marshal Bazaine. This retreat was begun during the course of the 8th and 9th of August; but on the night of the 9th urgent telegrams from Paris induced the emperor to suspend the movement, and during the 10th the whole army took up a strong position on the French Nied.

Meanwhile the II. German army had received its orders to march in a line of army corps on a broad front in the general direction of Pont-à-Mousson, well to the south of Metz. The I. army was to follow by short marches in échelon on the right; only the III. corps was directed on Falkenberg, a day's march farther towards Metz along the St Avold-Metz road. The movement was begun on the 10th, and towards evening the French army was located on the right front of the III. corps. This entirely upset Moltke's hypothesis, and called for a complete modification of his plans, as the III. corps alone could not be expected to resist the impact of Bazaine's five corps. The III. corps therefore received orders to stand fast for the moment, and the remainder of the II. army was instructed to wheel to the

¹ The II. corps had not yet arrived from Germany.

right and concentrate for a great battle to the east of Metz on the 16th or 17th.

Before, however, these orders had been received the sudden retreat of the French completely changed the situation. The Germans therefore continued their movement towards the Moselle. On the 13th the French took up a fresh position 5 m. to the east of Metz, where they were located by the cavalry and the advanced guards of the I. army.

Again Moltke ordered the I. army to observe and hold the enemy, whilst the II. was to swing round to the north. The cavalry was to scout beyond the Moselle and intercept all communication with the heart of France (see METZ). *Battle of Colombey-Borny.* By this time the whole German army had imbibed the idea that the French were in full retreat and endeavouring to evade a decisive struggle. When therefore during the morning of the 14th their outposts observed signs of retreat in the French position, their impatience could no longer be restrained; as at Wörth and Spicheren, an outpost commander brought up his guns, and at the sound of their fire, every unit within reach spontaneously got under arms (battle of Colombey-Borny). In a short time, with or without orders, the I., VII., VIII. and IX. corps were in full march to the battle-field. But the French too turned back to fight, and an obstinate engagement ensued, at the close of which the Germans barely held the ground and the French withdrew under cover of the Metz forts.

Still, though the fighting had been indecisive, the conviction of victory remained with the Germans, and the idea of a French retreat became an obsession. To this idea Moltke gave expression in his orders issued early on the 15th, in which he laid down that the "fruits of the victory" of the previous evening could only be reaped by a vigorous pursuit towards the passages of the Meuse, where it was hoped the French might yet be overtaken. This order, however, did not allow for the hopeless inability of the French staff to regulate the movement of congested masses of men, horses and vehicles, such as were now accumulated in the streets and environs of Metz. Whilst Bazaine had come to no definite decision whether to stand and fight or continue to retreat, and was merely drifting under the impressions of the moment, the Prussian leaders, in particular Prince Frederick Charles, saw in imagination the French columns in rapid orderly movement towards the west, and calculated that at best they could not be overtaken short of Verdun.

In this order of ideas the whole of the II. army, followed on its right rear by two-thirds of the I. army (the I. corps being detached to observe the eastern side of the fortress), were pushed on towards the Moselle, the cavalry far in advance towards the Meuse, whilst only the 5th cavalry division was ordered to scout towards the Metz-Verdun road, and even that was disseminated over far too wide an area.

Later in the day (15th) Frederick Charles sent orders to the III. corps, which was on the right flank of his long line of columns and approaching the Moselle at Corny and Novéant, to march via Gorze to Mars-la-Tour on the Metz-Verdun road; to the X. corps, strung out along the road from Thiaucourt to Pont-à-Mousson, to move to Jarny; and for the remainder to push on westward to seize the Meuse crossings. No definite information as to the French army reached him in time to modify these instructions.

Meanwhile the 5th (Rheinbaben's) cavalry division, at about 3 P.M. in the afternoon, had come into contact with the French cavalry in the vicinity of Mars-la-Tour, and gleaned intelligence enough to show that no French infantry had as yet reached Rezonville. The commander of the X. corps at Thiaucourt, informed of this, became anxious for the security of his flank during the next day's march and decided to push out a strong flanking detachment under von Caprivi, to support von Rheinbaben and maintain touch with the III. corps marching on his right rear.

Von Alvensleben, to whom the 6th cavalry division had meanwhile been assigned, seems to have received no local intelligence whatsoever; and at daybreak on the 16th he began his march

In two columns, the 6th division on Mars-la-Tour, the 5th towards the Rezonville-Vionville plateau. And shortly after 9.15 A.M. he suddenly discovered the truth. The entire French army lay on his right flank, and his nearest supports were almost a day's march distant. In this crisis he made up his mind at once to attack with every available man, and to continue to attack, in the conviction that his audacity would serve to conceal his weakness. All day long, therefore, the Brandenburgers of the III. corps, supported ultimately by the X. corps and part of the IX., attacked again and again. The enemy was thrice their strength, but very differently led, and made no adequate use of his superiority (battle of Vionville-Mars-la-Tour).

Meanwhile Prince Frederick Charles, at Pont-à-Mousson, was still confident in the French retreat to the Meuse, and had even issued orders for the 17th on that assumption. Firing had been heard since 9.15 A.M., and about noon Alvensleben's first report had reached him, but it was not till after 2 that he realized the situation. Then, mounting his horse, he covered the 15 m. to Flavigny over crowded and difficult roads within the hour, and on his arrival abundantly atoned for his strategic errors by his unconquerable determination and tactical skill. When darkness put a stop to the fighting, he considered the position. Cancelling all previous orders, he called all troops within reach to the battle-field and resigned himself to wait for them. The situation was indeed critical. The whole French army of five corps, only half of which had been engaged, lay in front of him. His own army lay scattered over an area of 30 m. by 20, and only some 20,000 fresh troops—of the IX. corps—

could reach the field during the forenoon of the 17th. He did not then know that Moltke had already intervened and had ordered the VII., VIII. and II. corps¹ to his assistance. Daylight revealed the extreme exhaustion of both men and horses. The men lay around in hopeless confusion amongst the killed and wounded, each where sleep had overtaken him, and thus the extent of the actual losses, heavy enough, could not be estimated. Across the valley, bugle sounds revealed the French already alert, and presently a long line of skirmishers approached the Prussian position. But they halted just beyond rifle range, and it was soon evident that they were only intended to cover a further withdrawal. Presently came the welcome intelligence that the reinforcements were well on their way.

About noon the king and Moltke drove up to the ground, and there was an animated discussion as to what the French would do next. Aware of their withdrawal from his immediate front, Prince Frederick Charles reverted to his previous idea and insisted that they were in full retreat towards the north, and that their entrenchments near Point du Jour and St Hubert (see map in article METZ) were at most a rearguard position. Moltke was inclined to the same view, but considered the alternative possibility of a withdrawal towards Metz, and about 2 P.M. orders were issued to meet these divergent opinions. The whole army was to be drawn up at 6 A.M. on the 18th in an échelon facing north, so as to be ready for action in either direction. The king and Moltke then drove to Pont-à-Mousson, and the troops bivouacked in a state of readiness. The rest of the 17th was spent in restoring order in the shattered III. and X. corps, and by nightfall both corps were reported fit for action. Strangely enough, there were no organized cavalry reconnaissances, and no intelligence of importance was collected during the night of the 17th-18th.

Early on the 18th the troops began to move into position in the following order from left to right: XII. (Saxons), Guards, IX., VIII. and VII. The X. and III. were retained in reserve.

The idea of the French retreat was still uppermost in the prince's mind, and the whole army therefore moved north. But between 10 and 11 A.M. part of the truth—viz. that the French had their backs to Metz and stood in battle order

¹ Of the I. army the I. corps was retained on the east side of Metz. The II. corps belonged to the II. army, but had not yet reached the front.

from St Hubert northwards—became evident, and the II. army, pivoting on the I., wheeled to the right and moved eastward. Suddenly the IX. corps fell right on the centre of the French line (Amanvillers), and a most desperate encounter began, superior control, as before, ceasing after the guns had opened fire. Prince Frederick Charles, however, a little farther north, again asserted his tactical ability, and about 7 P.M. he brought into position no less than five army corps for the final attack. The sudden collapse of French resistance, due to the frontal attack of the Guards (St Privat) and the turning movement of the Saxons (Roncourt), rendered the use of this mass unnecessary, but the resolution to use it was there. On the German right (I. army), about Gravelotte, all superior leading ceased quite early in the afternoon, and at night the French still showed an unbroken front. Until midnight, when the prince's victory was reported, the suspense at headquarters was terrible. The I. army was exhausted, no steps had been taken to ensure support from the III. army, and the IV. corps (II. army) lay inactive 30 m. away.

This seems a fitting place to discuss the much-disputed point of Bazaine's conduct in allowing himself to be driven back into Metz when fortune had thrown into his hands the great opportunity of the 16th and 17th of August. He had been appointed to command on the 10th, but the presence of the emperor, who only left the front early on the 16th, and their dislike of Bazaine, exercised a disturbing influence on the headquarters staff officers. During the retreat to Metz the marshal had satisfied himself as to the inability of his corps commanders to handle their troops, and also as to the ill-will of the staff. In the circumstances he felt that a battle in the open field could only end in disaster; and, since it was proved that the Germans could outmarch him, his army was sure to be overtaken and annihilated if he ventured beyond the shelter of the fortress. But near Metz he could at least inflict very severe punishment on his assailants, and in any case his presence in Metz would neutralize a far superior force of the enemy for weeks or months. What use the French government might choose to make of the breathing space thus secured was their business, not his; and subsequent events showed that, had they not forced MacMahon's hand, the existence of the latter's nucleus army of trained troops might have prevented the investment of Paris. Bazaine was condemned by court-martial after the war, but if the case were reheard to-day it is certain that no charge of treachery could be sustained.

On the German side the victory at St Privat was at once followed up by the headquarters. Early on the 19th the investment of Bazaine's army in Metz was commenced. A new army, the Army of the Meuse (often called the IV.), was as soon as possible formed of all troops not required for the maintenance of the investment, and marched off under the command of the crown prince of Saxony to discover and destroy the remainder of the French field army, which at this moment was known to be at Châlons.

The operations which led to the capture of MacMahon's army in Sedan call for little explanation. Given seven corps, each capable of averaging 15 m. a day for a week in succession, opposed to four corps only, shaken and unable as a whole to cover more than 5 m. a day, the result could hardly be doubtful. But Moltke's method of conducting operations left his opponent many openings which could only be closed by excessive demands on the marching power of the men. Trusting only to his cavalry screens to secure information, he was always without any definite fixed point about which to manoeuvre, for whilst the reports of the screen and orders based thereon were being transmitted, the enemy was free to move, and generally their movements were dictated by political expediency, not by calculable military motives.

Thus whilst the German army, on a front of nearly 50 m., was marching due west on Paris, MacMahon, under political pressure, was moving parallel to them, but on a northerly route, to attempt the relief of Metz.

So unexpected was this move and so uncertain the information which called attention to it, that Moltke did not venture to change at once the direction of march of the whole army, but he directed the Army of the Meuse northward on Damvillers and ordered Prince Frederick Charles to detach two corps from the forces investing Metz to reinforce it. For the moment, therefore, MacMahon's move had succeeded, and the opportunity existed for Bazaine to break out. But at the critical moment the hopeless want of real efficiency in MacMahon's army compelled the latter so to delay his advance that it became evident to the Germans that there was no longer any necessity for the III. army to maintain the direction towards Paris, and that the probable point of contact between the Meuse army and the French lay nearer to the right wing of the III. army than to Prince Frederick Charles's investing force before Metz.

The detachment from the II. army was therefore countermanded, and the whole III. army changed front to the north, while the Meuse army headed the French off from the east. The latter came into contact with the head of the French columns, during the 29th, about Nouart, and on the 30th at Buzancy (battle of Beaumont); and the French, yielding to the force of numbers combined with superior moral, were driven northward upon Sedan (q.v.), right across the front of the III. army, which was now rapidly coming up from the south.

During the 31st the retreat practically became a rout, and the morning of the 1st of September found the French crowded around the little fortress of Sedan, with only one line of retreat to the north-west still open. By 11 A.M. the XI. corps (III. army) had already closed that line, and about noon the Saxons (Army of the Meuse) moving round between the town and the Belgian frontier joined hands with the XI., and the circle of investment was complete. The battle of Sedan was closed about 4.15 P.M. by the hoisting of the white flag. Terms were agreed upon during the night, and the whole French army, with the emperor, passed into captivity. (F. N. M.)

Thus in five weeks one of the French field armies was imprisoned in Metz, the other destroyed, and the Germans were free to march upon Paris. This seemed easy. There could be no organized opposition to their progress,¹ and Paris, if not so defenceless as in 1814, was more populous.

Starvation was the best method of attacking an overcrowded fortress, and the Parisians were not thought to be proof against the deprivation of their accustomed luxuries. Even Moltke hoped that by the end of October he would be "shooting hares at Creisau," and with this confidence the German III. and IV. armies left the vicinity of Sedan on the 4th of September. The march called for no more than good staff arrangements, and the two armies arrived before Paris a fortnight later and gradually encircled the place—the III. army on the south, the IV. on the north side—in the last days of September. Headquarters were established at Versailles. Meanwhile the Third Empire had fallen, giving place on the 4th of September to a republican Government of National Defence, which made its appeal to, and evoked, the spirit of 1792. Henceforward the French nation, which had left the conduct of the war to the regular army and had been little more than an excited spectator, took the burden upon itself.

The regular army, indeed, still contained more than 500,000 men (chiefly recruits and reservists), and 50,000 sailors, marines, douaniers, &c., were also available. But the Garde Mobile, famed by Marshal Niel in 1863, doubled this figure, and the addition of the Garde Nationale, called into existence on the 15th of September, and including all able-bodied men of from 31 to 60 years of age, more than trebled it. The German staff had of course to reckon on the Garde Mobile, and did so beforehand, but they wholly underestimated both its effective members and its willingness, while, possessing themselves a system in which all the military elements of the German nation stood close behind

¹ The 13th corps (Vinoy), which had followed MacMahon's army at some distance, was not involved in the catastrophe of Sedan, and by good luck as well as good management evaded the German pursuit and returned safely to Paris.

the troops of the active army, they ignored the potentialities of the Garde Nationale.

Meanwhile, both as a contrast to the events that centred on Paris and because in point of time they were decided for the most part in the weeks immediately following Sedan, we must briefly allude to the sieges conducted by the Germans—Paris (q.v.), Metz (q.v.) and Belfort (q.v.) excepted. Old and ruined as many of them were, the French fortresses possessed considerable importance in the eyes of the Germans. Strassburg, in particular, the key of Alsace, the standing menace to South Germany and the most conspicuous of the spoils of Louis XIV.'s *Raubkriege*, was an obvious target. Operations were begun on the 9th of August, three days after Wörth, General v. Werder's corps (Baden troops and Prussian Landwehr) making the siege. The French commandant, General Uhrich, surrendered after a stubborn resistance on the 28th of September. Of the smaller fortresses many, being practically unarmed and without garrisons, capitulated at once. Toul, defended by Major Huck with 2000 mobiles, resisted for forty days, and drew upon itself the efforts of 13,000 men and 100 guns. Verdun, commanded by General Guérin de Waldersbach, held out till after the fall of Metz. Some of the fortresses lying to the north of the Prussian line of advance on Paris, e.g. Mézières, resisted up to January 1871, though of course this was very largely due to the diminution of pressure caused by the appearance of new French field armies in October. On the 9th of September a strange incident took place at the surrender of Laon. A powder magazine was blown up by the soldiers in charge and 300 French and a few German soldiers were killed by the explosion. But as the Germans advanced, their lines of communication were thoroughly organized, and the belt of country between Paris and the Prussian frontier subdued and garrisoned. Most of these fortresses were small town enclosures, dating from Vauban's time, and open, under the new conditions of warfare, to concentric bombardment from positions formerly out of range, upon which the besieger could place as many guns as he chose to employ. In addition they were usually deficient in armament and stores and garrisoned by newly-raised troops. Belfort, where the defenders strained every nerve to keep the besiegers out of bombarding range, and Paris formed the only exceptions to this general rule.

The policy of the new French government was defined by Jules Favre on the 6th of September. "It is for the king of Prussia, who has declared that he is making war on the Empire and not on France, to stay his hand; we shall not cede an inch of our territory or a stone of our fortresses." These proud words, so often ridiculed as empty bombast, were the prelude of a national effort which re-established France in the eyes of Europe as a great power, even though provinces and fortresses were ceded in the peace that that effort proved unable to avert. They were translated into action by Léon Gambetta, who escaped from Paris in a balloon on the 7th of October, and established the headquarters of the defence at Tours, where already the "Delegation" of the central government—which had decided to remain in Paris—had concentrated the machinery of government. Thenceforward Gambetta and his principal assistant de Freycinet directed the whole war in the open country, co-ordinating it, as best they could with the precarious means of communication at their disposal, with Trochu's military operations in and round the capital. His critics—Gambetta's personality was such as to ensure him numerous enemies among the higher civil and military officials, over whom, in the interests of *La Patrie*, he rode rough-shod—have acknowledged the fact, which is patent enough in any case, that nothing but Gambetta's driving energy enabled France in a few weeks to create and to equip twelve army corps, representing thirty-six divisions (600,000 rifles and 1400 guns), after all her organized regular field troops had been destroyed or neutralized. But it is claimed that by undue interference with the generals at the front, by presuming to dictate their plans of campaign, and by forcing them to act when the troops were unready, Gambetta and de Freycinet nullified the efforts of themselves and the rest of the nation and subjected France

to a humiliating treaty of peace. We cannot here discuss the justice or injustice of such a general condemnation, or even whether in individual instances Gambetta trespassed too far into the special domain of the soldier. But even the brief narrative given below must at least suggest to the reader the existence amongst the generals and higher officials of a dead weight of passive resistance to the Delegation's orders, of unnecessary distrust of the qualities of the improvised troops, and above all of the utter fear of responsibility that twenty years of literal obedience had bred. The closest study of the war cannot lead to any other conclusion than this, that whether or not Gambetta as a strategist took the right course in general or in particular cases, no one else would have taken any course whatever.

On the approach of the enemy Paris hastened its preparations for defence to the utmost, while in the provinces, out of reach of the German cavalry, new army corps were rapidly organized out of the few constituted regular units not involved in the previous catastrophes, the depot troops and the mobile national guard. The first-fruits of these efforts were seen in Beauce, where early in October important masses of French troops prepared not only to bar the further progress of the invader but actually to relieve Paris. The so-called "fog of war"—the armed inhabitants, franc-tireurs, sedentary national guard and volunteers—prevented the German cavalry from venturing far out from the infantry camps around Paris, and behind this screen the new 15th army corps assembled on the Loire. But an untimely demonstration of force alarmed the Germans, all of whom, from Moltke downwards, had hitherto disbelieved in the existence of the French new formations, and the still unready 15th corps found itself the target of an expedition of the I. Bavarian corps, which drove the defenders out of Orleans after a sharp struggle, while at the same time another expedition swept the western part of Beauce, sacked Châteaudun as a punishment for its brave defence, and returned via Chartres, which was occupied.

After these events the French forces disappeared from German eyes for some weeks. D'Aurelle de Paladines, the commander of the "Army of the Loire" (15th and 16th corps), improvised a camp of instruction at Salbris in Sologne, several marches out of reach, and subjected his raw troops to a stern régime of drill and discipline. At the same time an "Army of the West" began to gather on the side of Le Mans. This army was almost imaginary, yet rumours of its existence and numbers led the German commanders into the gravest errors, for they soon came to suspect that the main army lay on that side and not on the Loire, and this mistaken impression governed the German dispositions up to the very eve of the decisive events around Orleans in December. Thus when at last D'Aurelle took the offensive from Tours (whither he had transported his forces, now 100,000 strong) against the position of the I. Bavarian corps near Orleans, he found his task easy. The Bavarians, outnumbered and unsupported, were defeated with heavy losses in the battle of Coulmiers (November 9), and, had it not been for the inexperience, want of combination, and other technical weaknesses of the French, they would have been annihilated. What the results of such a victory as Coulmiers might have been, had it been won by a fully organized, smoothly working army of the same strength, it is difficult to overestimate. As it was, the retirement of the Bavarians rang the alarm bell all along the line of the German positions, and that was all.

Then once again, instead of following up its success, the French army disappeared from view. The victory had emboldened the "fog of war" to make renewed efforts, and resistance to the pressure of the German cavalry grew day by day. The Bavarians were reinforced by two Prussian divisions and by all available cavalry commands, and constituted as an "army detachment" under the grand-duke Friedrich Franz of Mecklenburg-Schwerin to deal with the Army of the Loire, the strength of which was far from being accurately known. Meantime the capitulation of Metz on the 28th of October had set free the veterans of Prince Frederick Charles, the best troops in the

German army, for field operations. The latter were at first misdirected to the upper Seine, and yet another opportunity arose for the French to raise the siege of Paris. But D'Aurelle utilized the time he had gained in strengthening the army and in imparting drill and discipline to the new units which gathered round the original nucleus of the 15th and 16th corps. All this was, however, unknown and even unsuspected at the German headquarters, and the invaders, feeling the approaching crisis, became more than uneasy as to their prospects of maintaining the siege of Paris.

At this moment, in the middle of November, the general situation was as follows: the German III. and Meuse armies, investing Paris, had had to throw off important detachments to protect the enterprise, which they had undertaken on the assumption that no further field armies of the enemy were to be encountered. The maintenance of their communications with Germany, relatively unimportant when the struggle took place in the circumstances of field warfare, had become supremely necessary, now that the army had come to a standstill and undertaken a great siege, which required heavy guns and constant replenishment of ammunition and stores. The rapidity of the German invasion had left no time for the proper organization and full garrisoning of these communications, which were now threatened, not merely by the Army of the Loire, but by other forces assembling on the area protected by Langres and Belfort. The latter, under General Cambriels, were held in check and no more by the Baden troops and reserve units (XIV. German corps) under General Werder, and eventually without arousing attention they were able to send 40,000 men to the Army of the Loire. This army, still around Orleans, thus came to number perhaps 150,000 men, and opposed to it, about the 14th of November, the Germans had only the Army Detachment of about 40,000, the II. army being still distant. It was under these conditions that the famous Orleans campaign took place. After many vicissitudes of fortune, and with many misunderstandings between Prince Frederick Charles, Moltke and the grand-duke, the Germans were ultimately victorious, thanks principally to the brilliant fighting of the X. corps at Beaune-la-Rolande (28th of November), which was followed by the battle of Loigny-Poupry on the 2nd of December and the second capture of Orleans after heavy fighting on the 4th of December.

The result of the capture of Orleans was the severance of the two wings of the French army, henceforward commanded respectively by Chanzy and Bourbaki. The latter fell back at once and hastily, though not closely pursued, to Bourges. But Chanzy, opposing the Detachment between Beaugency and the Forest of Marchenoir, was of sterner metal, and in the five days' general engagement around Beaugency (December 7-11) the Germans gained little or no real advantage. Indeed their solitary material success, the capture of Beaugency, was due chiefly to the fact that the French there were subjected to conflicting orders from the military and the governmental authorities. Chanzy then abandoned little but the field of battle, and on the grand-duke's representations Prince Frederick Charles, leaving a mere screen to impose upon Bourbaki (who allowed himself to be deceived and remained inactive), hurried thither with the II. army. After that Chanzy was rapidly driven north-westward, though always presenting a stubborn front. The Delegation left Tours and betook itself to Bordeaux, whence it directed the government for the rest of the war. But all this continuous marching and fighting, and the growing severity of the weather, compelled Prince Frederick Charles to call a halt for a few days. About the 19th of December, therefore, the Germans (II. army and Detachment) were closed up in the region of Chartres, Orleans, Auxerre and Fontainebleau, Chanzy along the river Sarthe about Le Mans and Bourbaki still passive towards Bourges.

During this, as during other halts, the French government and its generals occupied themselves with fresh plans of campaign, the former with an eager desire for results, the latter (Chanzy excepted) with many misgivings. Ultimately, and

fatally, it was decided that Bourbaki, whom nothing could move towards Orleans, should depart for the south-east, with a view to relieving Belfort and striking perpendicularly against the long line of the Germans' communications. This movement, bold to the point of extreme rashness judged by any theoretical rules of strategy, seems to have been suggested by de Freycinet. As the execution of it fell actually into incapable hands, it is difficult to judge what would have been the result had a Chanzy or a Faidherbe been in command of the French. At any rate it was vicious in so far as immediate advantages were sacrificed to hopes of ultimate success which Gambetta and de Freycinet did wrong to base on Bourbaki's powers of generalship. Late in December, for good or evil, Bourbaki marched off into Franche-Comté and ceased to be a factor in the Loire campaign. A mere calculation of time and space sufficed to show the German headquarters that the moment had arrived to demolish the stubborn Chanzy.

Prince Frederick Charles resumed the interrupted offensive, pushing westward with four corps and four cavalry divisions which converged on Le Mans. There on the 10th, 11th and 12th of January 1871 a stubbornly contested battle ended with the retreat of the French, who owed their defeat solely to the misbehaviour of the Breton mobiles. These, after deserting their post on the battlefield at a mere threat of the enemy's infantry, fled in disorder and infected with their terrors the men in the reserve camps of instruction, which broke up in turn. But Chanzy, resolute as ever, drew off his field army intact towards Laval, where a freshly raised corps joined him. The prince's army was far too exhausted to deliver another effective blow, and the main body of it gradually drew back into better quarters, while the grand duke departed for the north to aid in opposing Faidherbe. Some idea of the strain to which the invaders had been subjected may be gathered from the fact that army corps, originally 30,000 strong, were in some cases reduced to 10,000 and even fewer bayonets. And at this moment Bourbaki was at the head of 120,000 men! Indeed, so threatening seemed the situation on the Loire, though the French south of that river between Gien and Blois were mere isolated brigades, that the prince hurried back from Le Mans to Orleans to take personal command. A fresh French corps, bearing the number 25, and being the twenty-first actually raised during the war, appeared in the field towards Blois. Chanzy was again at the head of 156,000 men. He was about to take the offensive against the 40,000 Germans left near Le Mans when to his bitter disappointment he received the news of the armistice. "We have still France," he had said to his staff, undeterred by the news of the capitulation of Paris, but now he had to submit, for even if his improvised army was still cheerful, there were many significant tokens that the people at large had sunk into apathy and hoped to avoid worse terms of peace by discontinuing the contest at once.

So ended the critical period of the "Défense nationale." It may be taken to have lasted from the day of Coulmiers to the last day of Le Mans, and its central point was the battle of Beaune-la-Rolande. Its characteristics were, on the German side, inadequacy of the system of strategy practised, which became palpable as soon as the organs of reconnaissance met with serious resistance, misjudgment of and indeed contempt for the fighting powers of "new formations," and the rise of a spirit of ferocity in the man in the ranks, born of his resentment at the continuance of the war and the ceaseless sniping of the franc-tireur's rifle and the peasant's shot-gun. On the French side the continual efforts of the statesmen to stimulate the generals to decisive efforts, coupled with actual suggestions as to the plans of the campaign to be followed (in default, be it said, of the generals themselves producing such plans), and the professional soldiers' distrust of half-trained troops, acted and reacted upon one another in such a way as to neutralize the powerful, if disconnected and erratic, forces that the war and the Republic had unchained. As for the soldiers themselves, their most conspicuous qualities were their uncomplaining endurance of fatigues and wet bivouacs, and in action their

capacity for a single great effort and no more. But they were unreliable in the hands of the veteran regular general, because they were heterogeneous in recruiting, and unequal in experience and military qualities, and the French staff in those days was wholly incapable of moving masses of troops with the rapidity demanded by the enemy's methods of war, so that on the whole it is difficult to know whether to wonder more at their missing success or at their so nearly achieving it.

The decision, as we have said, was fought out on the Loire and the Sarthe. Nevertheless the glorious story of the "Défense nationale" includes two other important campaigns—that of Faidherbe in the north and that of Bourbaki in the east.

In the north the organization of the new formations was begun by Dr Testelin and General Farre. Bourbaki held the command for a short time in November before proceeding to Tours, but the active command in field operations came into the hands of Faidherbe, a general whose natural powers, so far from being cramped by years of peace routine and court repression, had been developed by a career of pioneer warfare and colonial administration. General Farre was his capable chief of staff. Troops were raised from fugitives from Metz and Sedan, as well as from depot troops and the Garde Mobile, and several minor successes were won by the national troops in the Seine valley, for here, as on the side of the Loire, mere detachments of the investing army round Paris were almost powerless. But the capitulation of Metz came too soon for the full development of these sources of military strength, and the German I. army under Manteuffel, released from duty at Metz, marched north-eastward, capturing the minor fortresses on its way. Before Faidherbe assumed command, Farre had fought several severe actions near Amiens; but, greatly outnumbered, had been defeated and forced to retire behind the Somme. Another French general, Briand, had also engaged the enemy without success near Rouen. Faidherbe assumed the command on the 3rd of December, and promptly moved forward. A general engagement on the little river Hallue (December 23), east-north-east of Amiens, was fought with no decisive results, but Faidherbe, feeling that his troops were only capable of winning victories in the first rush, drew them off on the 24th. His next effort, at Bapaume (January 2-3, 1871), was more successful, but its effects were counterbalanced by the surrender of the fortress of Péronne (January 9) and the consequent establishment of the Germans on the line of the Somme. Meanwhile the Rouen troops had been contained by a strong German detachment, and there was no further chance of succouring Paris from the north. But Faidherbe, like Chanzy, was far from despair, and in spite of the deficiencies of his troops in equipment (50,000 pairs of shoes, supplied by English contractors, proved to have paper soles), he risked a third great battle at St Quentin (January 19). This time he was severely defeated, though his loss in killed and wounded was about equal to that of the Germans, who were commanded by Goeben. Still the attempt of the Germans to surround him failed and he drew off his forces with his artillery and trains unharmed. The Germans, who had been greatly impressed by the solidity of his army, did not pursue him far, and Faidherbe was preparing for a fresh effort when he received orders to suspend hostilities.

The last episode in Bourbaki's campaign in the east, with its mournful close at Pontarlier. Before the crisis of the last week of November, the French forces under General Crémier, Cambricls' successor, had been so far successful in minor enterprises that, as mentioned above, the right wing of the Loire army, severed from the left by the battle of Orleans and subsequently held inactive at Bourges and Nevers, was ordered to Franche Comté to take the offensive against the XIV corps and other German troops there, to relieve Belfort and to strike a blow across the invaders' line of communications. But there were many delays in execution. The staff work, which was at no time satisfactory in the French armies of 1870, was complicated by the snow, the bad state of the roads, and the mountainous nature of the country, and Bourbaki, a brave general of division in action,

Faidherbe's campaign.

but irresolute and pretentious as a commander in chief, was not the man to cope with the situation. Only the furious courage and patient endurance of hardships of the rank and file, and the good qualities of some of the generals, such as Clinchant, Crémier and Billot, and junior staff officers such as Major Brugère (afterwards generalissimo of the French army), secured what success was attained.

Werder, the German commander, warned of the imposing concentration of the French, evacuated Dijon and Dôle just in time to avoid the blow and rapidly drew together his forces behind the Ognon above Vesoul. A furious attack on one of his divisions at Villersexel (January 9) cost him 2000 prisoners as well as his killed and wounded, and Bourbaki, heading for Belfort, was actually nearer to the fortress than the Germans. But at the crisis more time was wasted, Werder (who had almost lost hope of maintaining himself and had received both encouragement and stringent instructions to do so) slipped in front of the French, and took up a long weak line of defence on the river Lisaine, almost within cannon shot of Belfort. The cumbersome French army moved up and attacked him there with 150,000 against 60,000 (January 15-17, 1871). It was at last repulsed, thanks chiefly to Bourbaki's inability to handle his forces, and, to the bitter disappointment of officers and men alike, he ordered a retreat, leaving Belfort to its fate.

Ere this, so urgent was the necessity of assisting Werder, Manteuffel had been placed at the head of a new Army of the South. Bringing two corps from the I army opposing Faidherbe and calling up a third from the armies around Paris, and a fourth from the II. army, Manteuffel hurried southward by Langres to the Saône. Then, hearing of Werder's victory on the Lisaine, he deflected the march so as to cut off Bourbaki's retreat, drawing off the left flank guard of the latter (commanded with much *éclat* and little real effect by Garibaldi) by a sharp feint attack on Dijon. The pressure of Werder in front and Manteuffel in flank gradually forced the now thoroughly disheartened French forces towards the Swiss frontier, and Bourbaki, realizing at once the ruin of his army and his own incapacity to re-establish its efficiency, shot himself, though not fatally, on the 26th of January. Clinchant, his successor, acted promptly enough to remove the immediate danger, but on the 29th he was informed of the armistice without at the same time being told that Belfort and the eastern theatre of war had been on Jules Favre's demand expressly excepted from its operation.¹ Thus the French, the leaders distracted by doubts and the worn-out soldiers fully aware that the war was practically over, stood still, while Manteuffel completed his preparations for hemming them in. On the 1st of February General Clinchant led his troops into Switzerland, where they were disarmed, interned and well cared for by the authorities of the neutral state. The rearguard fought a last action with the advancing Germans before passing the frontier. On the 16th, by order of the French government, Belfort capitulated, but it was not until the 11th of March that the Germans took possession of Bitche, the little fortress on the Vosges, where in the early days of the war de Failly had illustrated so signally the want of concerted action and the neglect of opportunities which had throughout proved the bane of the French armies.

The losses of the Germans during the whole war were 28,000 dead and 101,000 wounded and disabled, those of the French, 156,000 dead (17,000 of whom died, of sickness and wounds, as prisoners in German hands) and 143,000 wounded and disabled. 720,000 men surrendered to the Germans or to the authorities of neutral states, and at the close of the war there were still 250,000 troops on foot, with further resources not immediately available to the number of 280,000 more. In this connexion, and as evidence of the respective numerical yields of the German system working normally and of the French improvised for the emergency, we quote from Berndt (*Zahl im Kriege*) the following comparative figures:—

¹ Jules Favre, it appears, neglected to inform Gambetta of the exception.

End of July	French 250,000,	Germans 384,000	under arms
Middle of November	" 600,000	" 425,000	"
After the surrender of Paris and the disarmament of Bourbaki's army	" 534,000	" 835,000	"

The date of the armistice was the 28th of January, and that of the ratification of the treaty of Frankfurt the 23rd of May 1871.

BIBLIOGRAPHY.—The literature of the war is ever increasing in volume, and the following list only includes a very short selection made amongst the most important works.

General.—German official history, *Der deutsch-französische Krieg* (Berlin, 1872-1881, English and French translations), monographs of the German general staff (*Kriegsgesch. Einzelschriften*); Moitke, *Gesch. des deutsch-französ. Krieges* (Berlin, 1891, English translation) and *Gesammelte Schriften des G. F. M. Grafen v. Moitke* (Berlin, 1900-) (the fullest and most accurate account); P. Lehautcourt (General Palat), *Hist. de la guerre de 1870-1871* (Paris, 1901-1902); v. Verdy du Vernois, *Studien über den Krieg auf Grundl. der Tage 1870-1871* (Berlin, 1892-1896); G. Cardinal von Widdern, *Kritische Tage 1870-1871* (French translation, *Journées critiques*). Events preceding the war are dealt with in v. Bernhardi, *Zwischen zwei Kriegen*, Baron Stoffel, *Rapports militaires 1866-1870* (Paris, 1871; English translation); G. Lehmann, *Die Mobilmachung 1870-1871* (Berlin, 1905).

For the war in Lorraine: Prince Kraft of Hohenlohe-Ingelfingen, *Briefe über Strategie* (English translation, *Letters on Strategy*); F. Foch, *Conduite de la guerre*, pt. II., H. Bonnal, *Mémoires de Saint Privat* (Paris, 1904-1906); Maistre, *Spicheren* (Paris, 1908), v. Schell, *Die Operationen der I. Armee unter Gen. von Stossmetz* (Berlin, 1872; English translation); F. Hoening, *Taktik der Zukunft* (English translation), and *24 Stunden Moitke'schen Strategie* (Berlin, 1892; English and French translations).

For the war in Alsace and Champagne: H. Kunz, *Schlacht von Wörth* (Berlin, 1891), and later works by the same author; H. Bonnal, *Fröschweiler* (Paris, 1899), Hahnke, *Die Operationen des III. Armee bis Sedan* (Berlin, 1873; French translation).

For the war in the Provinces: v. der Goltz, *Léon Gambetta und seine Armeen* (Berlin, 1877), *Die Operationen der II. Armee an die Loire* (Berlin, 1875); *Die sieben Tage von La Mauve* (Berlin, 1873); Kunz, *Die Zusammenkunft der französischen Provinzialheeren*; de Freycinet, *La Guerre en province* (Paris, 1871), L. A. Hale, *The People's War* (London, 1904); Hoening, *Volkskrieg an die Loire* (Berlin, 1892); Blume, *Operationen v. Sedan bis zum Ende d. Krieges* (Berlin, 1872; English translation), v. Schell, *Die Operationen der I. Armee unter Gen. v. Goebes* (Berlin, 1873; English translation); Count Wartensleben, *Feldzug der Nordarmee unter Gen. v. Manteuffel* (Berlin, 1872), *Operationen der Sudarmee* (Berlin, 1872, English translation); Faidherbe, *Campagne de l'armée du nord* (Paris, 1872).

For the sieges: Frobenius, *Kriegsgesch. Beispiele d. Festungsbrieges aus d. deutsch-franz. Kg.* (Berlin, 1809-1900), Goetze, *Tätigkeit der deutschen Ingenieuren* (Berlin, 1871, English translation).

The most useful bibliography is that of General Palat ("P. Lehautcourt"). (C. F. A.)

FRANÇOIS DE NEUFCHÂTEAU, NICOLAS LOUIS, Court (1750-1828), French statesman and poet, was born at Saffais near Rosières in Lorraine on the 17th of April 1750, the son of a school-teacher. He studied at the Jesuit college of Neufchâteau in the Vosges, and at the age of fourteen published a volume of poetry which obtained the approbation of Rousseau and of Voltaire. Neufchâteau conferred on him its name, and he was elected member of some of the principal academies of France. In 1783 he was named *procureur-général* to the council of Santo Domingo. He had previously been engaged on a translation of Ariosto, which he finished before his return to France five years afterwards, but it perished during the shipwreck which occurred during his voyage home. After the Revolution he was elected deputy *suppléant* to the National Assembly, was charged with the organization of the Department of the Vosges, and was elected later to the Legislative Assembly, of which he first became secretary and then president. In 1793 he was imprisoned on account of the political sentiments, in reality very innocent, of his drama *Pamela ou la vertu récompensée* (Théâtre de la Nation, 1st August 1793), but was set free a few days afterwards at the revolution of the 9th Thermidor. In 1797 he became minister of the interior, in which office he distinguished himself by the thoroughness of his administration in all departments. It is to him that France owes its system of inland navigation. He inaugurated the museum of the Louvre,

and was one of the promoters of the first universal exhibition of industrial products. From 1804 to 1806 he was president of the Senate, and in that capacity the duty devolved upon him of soliciting Napoleon to assume the title of emperor. In 1808 he received the dignity of count. Retiring from public life in 1814, he occupied himself chiefly in the study of agriculture, until his death on the 10th of January 1828.

François de Neuchâteau had very multifarious accomplishments, and interested himself in a great variety of subjects, but his fame rests chiefly on what he did as a statesman for the encouragement and development of the industries of France. His maturer poetical productions did not fulfil the promise of those of his early years, for though some of his verses have a superficial elegance, his poetry generally lacks force and originality. He had considerable qualifications as a grammarian and critic, as is witnessed by his editions of the *Provinciales* and *Pensées* of Pascal (Paris, 1822 and 1826) and *Gil Blas* (Paris, 1820). His principal poetical works are *Poésies diverses* (1765), *Ode sur les parlements* (1771); *Nouveaux Contes moraux* (1781); *Les Vosges* (1796); *Fables et contes* (1814), and *Les Tropes, ou les figures de mots* (1817). He was also the author of a large number of works on agriculture.

See *Recueil des lettres, circulaires, discours et autres actes publics innés du Cte François pendant ses deux exercices du ministère de l'intérieur* (Paris, An vii.-viii., 2 vols.), *Notice biographique sur M le comte François de Neuchâteau* (1828), by A. F. de Sillery; H. Bonnelier, *Mémoires sur François de Neuchâteau* (Paris, 1829); J. Lamoureux, *Notice historique et littéraire sur la vie et les écrits de François de Neuchâteau* (Paris, 1843); E. Meaume, *Etude historique et biographique sur les Lorrains révolutionnaires: Palissot, Grégoire, François de Neuchâteau* (Nancy, 1882); Ch. Simian, *François de Neuchâteau et les expositions* (Paris, 1899).

FRANCONIA (Ger *Franken*), the name of one of the stem-duchies of medieval Germany. It stretched along the valley of the Main from the Rhine to Bohemia, and was bounded on the north by Saxony and Thuringia, and on the south by Swabia and Bavaria. It also included a district around Mainz, Spire and Worms, on the left bank of the Rhine. The word *Franconia*, first used in a Latin charter of 1053, was applied like the words *France*, *Francia* and *Franken*, to a portion of the land occupied by the Franks.

About the close of the 5th century this territory was conquered by Clovis, king of the Salian Franks, was afterwards incorporated with the kingdom of Austrasia, and at a later period came under the rule of Charlemagne. After the treaty of Verdun in 843 it became the centre of the East Frankish or German kingdom, and in theory remained so for a long period, and was for a time the most important of the duchies which arose on the ruins of the Carolingian empire. The land was divided into counties, or *gauces*, which were ruled by counts, prominent among whom were members of the families of Conradine and Babenberg, by whose feuds it was frequently devastated. Conrad, a member of the former family, who took the title of "duke in Franconia" about the year 900, was chosen German king in 911 as the representative of the foremost of the German races. Conrad handed over the chief authority in Franconia to his brother Eberhard, who remained on good terms with Conrad's successor Henry I the Fowler, but rose against the succeeding king, Otto the Great, and was killed in battle in 939, when his territories were divided. The influence of Franconia began to decline under the kings of the Saxon house. It lacked political unity, had no opportunities for extension, and soon became divided into Rhenish Franconia (*Francia rhemensis*, Ger *Rheinfranken*) and Eastern Franconia (*Francia orientalis*, Ger *Ostfranken*). The most influential family in Rhenish Franconia was that of the Salfians, the head of which early in the 10th century was Conrad the Red, duke of Lorraine, and son-in-law of Otto the Great. This Conrad, his son Otto and his grandson Conrad are sometimes called dukes of Franconia, and in 1024 his great-grandson Conrad, also duke of Franconia, was elected German king as Conrad II and founded the line of Franconian or Salian emperors. Rhenish Franconia gradually became a land of free towns and lesser nobles, and under the earlier Franconian

emperors sections passed to the count palatine of the Rhine, the archbishop of Mainz, the bishops of Worms and Spire and other clerical and lay nobles; and the name *Franconia*, or *Francia orientalis* as it was then called, was confined to the eastern portion of the duchy. Clerical authority was becoming predominant in this region. A series of charters dating from 822 to 1025 had granted considerable powers to the bishops of Würzburg, who, by the time of the emperor Henry II., possessed judicial authority over the whole of eastern Franconia. The duchy was nominally retained by the emperors in their own hands until 1115, when the emperor Henry V., wishing to curb the episcopal influence in this neighbourhood, appointed his nephew Conrad of Hohenstaufen as duke of Franconia. Conrad's son Frederick took the title of duke of Rothenburg instead of duke of Franconia, but in 1196, on the death of Conrad of Hohenstaufen, son of the emperor Frederick I., the title fell into disuse. Meanwhile the bishop of Würzburg had regained his former power in the duchy, and this was confirmed in 1168 by the emperor Frederick I.

The title remained in abeyance until the early years of the 15th century, when it was assumed by John II., bishop of Würzburg, and retained by his successors until the bishopric was secularized in 1802. The greater part of the lands were united with Bavaria, and the name Franconia again fell into abeyance. It was revived in 1837, when Louis I., king of Bavaria, gave to three northern portions of his kingdom the names of Upper, Middle and Lower Franconia. In 1633 Bernhard, duke of Saxe-Weimar, hoping to create a principality for himself out of the ecclesiastical lands, had taken the title of duke of Franconia, but his hopes were destroyed by his defeat at Nördlingen in 1634. When Germany was divided into circles by the emperor Maximilian I. in 1500, the name Franconia was given to that circle which included the eastern part of the old duchy. The lands formerly comprised in the duchy of Franconia are now divided between the kingdoms of Bavaria and Württemberg, the grand-duchies of Baden and Hesse, and the Prussian province of Hesse-Nassau.

See J. G. ab Eckhart, *Commentarii de rebus Franciæ orientalis et episcopatus Wirceburgensis* (Würzburg, 1729); F. Stein, *Geschichte Frankens* (Schweinfurt, 1885-1886); T. Henner, *Die herzogliche Gewalt der Bischöfe von Würzburg* (Würzburg, 1874).

FRANCS-ARCHERS. The institution of the *francs-archers* was the first attempt at the formation of regular infantry in France. They were created by the ordinance of Montils-les-Tours on the 28th of August 1448, which prescribed that in each parish an archer should be chosen from among the most apt in the use of arms; this archer to be exempt from the *taille* and certain obligations, to practise shooting with the bow on Sundays and feast-days, and to hold himself ready to march fully equipped at the first signal. Under Charles VII. the *francs-archers* distinguished themselves in numerous battles with the English, and assisted the king to drive them from France. During the succeeding reigns the institution languished, and finally disappeared in the middle of the 16th century. The *francs-archers* were also called *francs-taupins*.

See Daniel, *Histoire de la milice française* (1721); and E. Boutaric, *Institutions militaires de la France avant les armées permanentes* (1863).

FRANCS-TIREURS ("Free-Shooters"), irregular troops, almost exclusively infantry, employed by the French in the war of 1870-1871. They were originally rifle clubs or unofficial military societies formed in the east of France at the time of the Luxemburg crisis of 1867. The members were chiefly concerned with the practice of rifle-shooting, and were expected in war to act as light troops. As under the then system of conscription the greater part of the nation's military energy was allowed to run to waste, the *francs-tireurs* were not only popular, but efficient workers in their sphere of action. As they wore no uniforms, were armed with the best existing rifles and elected their own officers, the government made repeated attempts to bring the societies, which were at once a valuable asset to the armed strength of France and a possible menace to internal order, under military discipline. This was strenuously resisted by the societies, to their sorrow as it turned out, for the Germans treated

captured francs-tireurs as irresponsible non-combatants found with arms in their hands and usually exacted the death penalty. In July 1870, at the outbreak of the war, the societies were brought under the control of the minister of war and organized for field service, but it was not until the 4th of November—by which time the *levée en masse* was in force—that they were placed under the orders of the generals in the field. After that they were sometimes organized in large bodies and incorporated in the mass of the armies, but more usually they continued to work in small bands, blowing up culverts on the invaders' lines of communication, cutting off small reconnoitring parties, surprising small posts, &c. It is now acknowledged, even by the Germans, that though the francs-tireurs did relatively little active mischief, they paralysed large detachments of the enemy, contested every step of his advance (as in the Loire campaign), and prevented him from gaining information, and that their soldierly qualities improved with experience. Their most celebrated feats were the blowing up of the Moselle railway bridge at Fontenoy on the 22nd of January 1871 (see *Les Chasseurs des Vosges* by Lieut.-Colonel St Étienne, Toul, 1906), and the heroic defence of Châteaudun by Lipowski's Paris corps and the francs-tireurs of Cannes and Nantes (October 18, 1870). It cannot be denied that the original members of the rifle clubs were joined by many bad characters, but the patriotism of the majority was unquestionable, for little mercy was shown by the Germans to those francs-tireurs who fell into their hands. The severity of the German reprisals is itself the best testimony to the fear and anxiety inspired by the presence of active bands of francs-tireurs on the flanks and in rear of the invaders.

FRANEKER, a town in the province of Friesland, Holland, 5 m E of Harlingen on the railway and canal to Leeuwarden. Pop (1900) 7187. It was at one time a favourite residence of the Frisian nobility, many of whom had their castles here, and it possessed a celebrated university, founded by the Frisian estates in 1585. This was suppressed by Napoleon I in 1811, and the endowments were diverted four years later to the support of an atheneum, and afterwards of a gymnasium, with which a physiological cabinet and a botanical garden are connected. Franeker also possesses a town hall (1591), which contains a *planetarium*, made by one Eise Eisinga in 1774-1881. The fine observatory was founded about 1780. The church of St Martin (1420) contains several fine tombs of the 15th-17th centuries. The industries of the town include silk-weaving, woollen-spinning, shipbuilding and pottery-making. It is also a considerable market for agricultural produce.

FRANK, JAKOB (1726-1791), a Jewish theologian, who founded in Poland, in the middle of the 18th century, a sect which emanated from Judaism but ended by merging with Christianity. The sect was the outcome of the Messianic mysticism of Sabbetai Zebi. It was an antinomian movement in which the authority of the Jewish law was held to be superseded by personal freedom. The Jewish authorities, alarmed at the moral laxity which resulted from the emotional rites of the Frankists, did their utmost to suppress the sect. But the latter, posing as an anti-Talmudic protest in behalf of a spiritual religion, won a certain amount of public sympathy. There was, however, no deep sincerity in the tenets of the Frankists, for though in 1759 they were baptized *en masse*, amid much pomp, the Church soon became convinced that Frank was not a genuine convert. He was imprisoned on a charge of heresy, but on his release in 1763 the empress Maria Theresa patronized him, regarding him as a propagandist of Christianity among the Jews. He thenceforth lived in state as baron of Offenbach, and on his death (1791) his daughter Eva succeeded him as head of the sect. The Frankists gradually merged in the general Christian body, the movement leaving no permanent trace in the synagogue (I A.)

FRANK-ALMOIGN (*libera elemosyna*, free alms), in the English law of real property, a species of spiritual tenure, whereby a religious corporation, aggregate or sole, holds lands of the donor to them and their successors for ever. It was a tenure dating from Saxon times, held not on the ordinary feudal conditions, but discharged of all services except the *trinoda necessitas*

But "they which hold in frank-almoign are bound of right before God to make orisons, prayers, masses and other divine services for the souls of their grantor or feoffor, and for the souls of their heirs which are dead, and for the prosperity and good life and good health of their heirs which are alive. And therefore they shall do no fealty to their lord, because that this divine service is better for them before God than any doing of fealty" (Litt. s. 135). It was the tenure by which the greater number of the monasteries and religious houses held their lands, it was expressly exempted from the statute 12 Car. II c. 24 (1660), by which the other ancient tenures were abolished, and it is the tenure by which the parochial clergy and many ecclesiastical and eleemosynary foundations hold their lands at the present day. As a form of donation, however, it came to an end by the passing of the statute *Quia Emptores*, for by that statute no new tenure of frank-almoign could be created, except by the crown.

See Pollock and Maitland, *History of English Law*, where the history of frank-almoign is given at length.

FRANKEL, ZECHARIAS (1801-1875), Jewish theologian, one of the founders of the Breslau school of "historical Judaism." This school attempts to harmonize critical treatment of the documents of religion with fidelity to traditional beliefs and observances. For a time at least, the compromise succeeded in staying the disintegrating effects of the liberal movement in Judaism. Frankel was the author of several valuable works, among them *Septuagint Studies*, an *Introduction to the Mishnah* (1859), and a similar work on the Palestinian Talmud (1870). He also edited the *Monatsschrift*, devoted to Jewish learning on modern lines. But his chief claim to fame rests on his headship of the Breslau Seminary. This was founded in 1854 for the training of rabbis who should combine their rabbinic studies with secular courses at the university. The whole character of the rabbinate has been modified under the influence of this, the first seminary of the kind. (I A.)

FRANKENBERG, a manufacturing town of Germany, in the kingdom of Saxony, on the Zschopau, 7 m N E of Chemnitz, on the railway Niederwiesna-Rosswein. Pop (1905) 13,303. The principal buildings are the large Evangelical parish church, restored in 1874-1875, and the town-hall. Its industries include extensive woollen, cotton and silk weaving, dyeing, the manufacture of brushes, furniture and cigars, iron-founding and machine building. It is well provided with schools, including one of weaving.

FRANKENHAUSEN, a town of Germany, in the principality of Schwarzburg-Rudolstadt, on an artificial arm of the Wipper, a tributary of the Saale, 36 m N N E of Gotha. Pop (1905) 6534. It consists of an old and a new town, the latter mostly rebuilt since a destructive fire in 1833, and has an old chateau of the princes of Schwarzburg, three Protestant churches, a seminary for teachers, a hospital and a modern town-hall. Its industries include the manufacture of sugar, cigars and buttons, and there are brine springs, with baths, in the vicinity. At Frankenhausem a battle was fought on the 15th of May 1525, in which the insurgent peasants under Thomas Münzer were defeated by the allied princes of Saxony and Hesse.

FRANKENSTEIN, a town of Germany, in the Prussian province of Silesia, on the Pausebach, 35 m. S. by W of Breslau. Pop (1905) 7800. It is still surrounded by its medieval walls, has two Evangelical and three Roman Catholic churches, among the latter the parish church with a curious overhanging tower, and a monastery. The industries include the manufacture of artificial manures, bricks, beer and straw hats. There are also mills for grinding the magnesite found in the neighbourhood.

FRANKENTHAL, a town of Germany, in the Bavarian Palatinate, on the Isenach, connected with the Rhine by a canal 3 m in length, 6 m NW from Mannheim, and on the railways Neunkirchen-Worms and Frankenthal-Grosskarlbach. Pop (1905) 18,191. It has two Evangelical and a Roman Catholic church, a fine medieval town-hall, two interesting old gates, remains of its former environing walls, several public monuments, including one to the veterans of the Napoleonic wars, and a museum. Its industries include the manufacture

of machinery, casks, corks, soap, dolls and furniture, iron-founding and bell-founding—the famous "Kaiserglocke" of the Cologne cathedral was cast here. Frankenthal was formerly famous for its porcelain factory, established here in 1755 by Paul Anton Hannong of Strassburg, who sold it in 1762 to the elector palatine Charles Theodore. Its fame is mainly due to the modellers Konrad Link (1732-1802) and Johann Peter Melchior (d. 1796) (who worked at Frankenthal between 1779 and 1793). The best products of this factory are figures and groups representing contemporary life, or allegorical subjects in the rococo taste of the period, and they are surpassed only by those of the more famous factory at Meissen. In 1795 the factory was sold to Peter von Reuccum, who removed it to Grünstadt.

Frankenthal (Franconodal) is mentioned as a village in the 8th century. A house of Augustinian canons established here in 1119 by Erkenbert, chamberlain of Worms, was suppressed in 1562 by the elector palatine Frederick III., who gave its possessions to Protestant refugees from the Netherlands. In 1577 this colony received town rights from the elector John Casimir, whose successor fortified the place. From 1623 until 1652, save for two years, it was occupied by the Spaniards, and in 1688-1689 it was stormed and burned by the French, the fortifications being razed. In 1697 it was reconstituted as a town, and under the elector Charles Theodore it became the capital of the Palatinate. From 1793 to 1814 it was incorporated in the French department of Mont Tonnerre.

See Wille, *Stadt u. Festung Frankenthal während des dreissig-jährigen Krieges* (Heidelberg, 1877); Hildenbrand, *Gesch. der Stadt Frankenthal* (1893). For the porcelain see Heuser, *Frankenthaler Gruppen und Figuren* (Spire, 1899).

FRANKENWALD, a mountainous district of Germany, forming the geological connexion between the Fichtelgebirge and the Thuringian Forest. It is a broad well-wooded plateau, running for about 30 m. in a north-westerly direction, descending gently on the north and eastern sides towards the Saale, but more precipitously to the Bavarian plain in the west, and attaining its highest elevation in the Kieferle near Steinheid (2900 ft.). Along the centre lies the watershed between the basins of the Main and the Saale, belonging to the systems of the Rhine and Elbe respectively. The principal tributaries of the Main from the Frankenwald are the Rodach and Hasslach, and of the Saale, the Sebitz.

See H. Schmid, *Führer durch den Frankenwald* (Bamberg, 1894); Meyer, *Thüringen und der Frankenwald* (15th ed. Leipzig, 1900), and Gärtel, *Geognostische Beschreibung des Fichtelgebirges mit dem Frankenwald* (Gotha, 1879).

FRANKFORT, a city and the county-seat of Clinton county, Indiana, U.S.A., 40 m. N.W. of Indianapolis. Pop. (1890) 5019; (1900) 7100 (144 foreign-born); (1910) 8634. Frankfort is served by the Chicago, Indianapolis & Louisville, the Lake Erie & Western, the Vandalia, and the Toledo, St. Louis & Western railways, and by the Indianapolis & North-Western Traction Interurban railway (electric). The city is a division point on the Toledo, St. Louis & Western railway, which has large shops here. Frankfort is a trade centre for an agricultural and lumbering region; among its manufactures are handles, agricultural implements and foundry products. The first settlement in the neighbourhood was made in 1826; in 1830 the town was founded, and in 1875 it was chartered as a city. The city limits were considerably extended immediately after 1900.

FRANKFORT, the capital city of Kentucky, U.S.A., and the county-seat of Franklin county, on the Kentucky river, about 55 m. E. of Louisville. Pop. (1890) 7892; (1900) 9487, of whom 3316 were negroes; (1910 census) 10,465. The city is served by the Chesapeake & Ohio, the Louisville & Nashville, and the Frankfort & Cincinnati railways, by the Central Kentucky Traction Co. (electric), and by steamboat lines to Cincinnati, Louisville and other river ports. It is built among picturesque hills on both sides of the river, and is in the midst of the famous Kentucky "blue grass region" and of a rich lumber-producing region. The most prominent building is the Capitol, about 400 ft. long and 185 ft. wide, built of granite and white limestone in the Italian Renaissance style, with 70 large Ionic columns, and a

dome 205 ft. above the terrace line, supported by 24 other columns. The Capitol was built in 1905-1907 at a cost of more than \$2,000,000; in it are housed the state library and the library of the Kentucky State Historical Society. At Frankfort, also, are the state arsenal, the state penitentiary and the state home for feeble-minded children, and just outside the city limits is the state coloured normal school. The old capitol (first occupied in 1829) is still standing. In Franklin cemetery rest the remains of Daniel Boone and of Theodore O'Hara (1820-1867), a lawyer, soldier, journalist and poet, who served in the U.S. army in 1846-1848 during the Mexican War, took part in filibustering expeditions to Cuba, served in the Confederate army, and is best known as the author of "The Bivouac of the Dead," a poem written for the burial in Frankfort of some soldiers who had lost their lives at Buena Vista. Here also are the graves of Richard M. Johnson, vice-president of the United States in 1837-1841, and the sculptor Joel T. Hart (1810-1877). The city has a considerable trade with the surrounding country, in which large quantities of tobacco and hemp are produced; its manufactures include lumber, brooms, chairs, shoes, hemp twine, canned vegetables and glass bottles. The total value of the city's factory product in 1905 was \$1,747,338, being 31.6% more than in 1900. Frankfort (said to have been named after Stephen Frank, one of an early pioneer party ambushed here by Indians) was founded in 1786 by General James Wilkinson, then deeply interested in trade with the Spanish at New Orleans, and in the midst of his Spanish intrigues. In 1792 the city was made the capital of the state. In 1862, during the famous campaign in Kentucky of General Braxton Bragg (Confederate) and General D. C. Buell (Federal), Frankfort was occupied for a short time by Bragg, who, just before being forced out by Buell, took part in the inauguration of Richard J. Hawes, chosen governor by the Confederates of the state. Hawes, however, never discharged the duties of his office. During the bitter contest for the governorship in 1900 between William Goebel (Democrat) and William S. Taylor (Republican), each of whom claimed the election, Goebel was assassinated at Frankfort. (See also KENTUCKY.) Frankfort received a city charter in 1839.

FRANKFORT-ON-MAIN (*Ger. Frankfurt am Main*), a city of Germany, in the Prussian province of Hesse-Nassau, principally on the right bank of the Main, 24 m. above its confluence with the Rhine at Mainz, and 16 m. N. from Darmstadt. Always a place of great trading importance, long the place of election for the German kings, and until 1866, together with Hamburg, Bremen and Lübeck, one of the four free cities of Germany, it still retains its position as one of the leading commercial centres of the German empire. Its situation in the broad and fertile valley of the Main, the northern horizon formed by the soft outlines of the Taunus range, is one of great natural beauty, the surrounding country being richly clad with orchard and forest.

Frankfort is one of the most interesting, as it is also one of the wealthiest, of German cities. Apart from its commercial importance, its position, close to the fashionable watering-places of Homburg, Nauheim and Wiesbaden, has rendered it "cosmopolitan" in the best sense of the term. The various stages in the development of the city are clearly indicated in its general plan and the surviving names of many of its streets. The line of the original 12th century walls and moat is marked by the streets of which the names end in *-graben*, from the Hirschgraben on the W. to the Wollgraben on the E. The space enclosed by these and by the river on the S. is known as the "old town" (*Allstadt*). The so-called "new town" (*Neustadt*), added in 1333, extends to the *Anlegen*, the beautiful gardens and promenades laid out (1806-1812) on the site of the 17th century fortifications, of which they faithfully preserve the general ground plan. Of the medieval fortifications the picturesque Eschenheimer Tor, a round tower 155 ft. high, dating from 1400 to 1428, the Rententurm (1456) on the Main and the Kuhlhirtenturm (c. 1490) in Sachsenhausen, are the sole remains. Since the demolition of the fortifications the city has greatly expanded. Sachsenhausen on the south bank of the river, formerly the seat of a commandery

of the Teutonic Order (by treaty with Austria in 1842 all property and rights of the order in Frankfort territory were sold to the city, except the church and house), is now a quarter of the city. In other directions also the expansion has been rapid; the village of Bornheim was incorporated in Frankfort in 1877, the former Hessian town of Bockenheim in 1895, and the suburbs of Niederrad, Oberrad and Seckbach in 1900.

The main development of the city has been to the north of the river, which is crossed by numerous bridges and flanked by fine quays and promenades. The Altstadt, though several broad streets have been opened through it, still preserves many of its narrow alleys and other medieval features. The Judengasse (Ghetto), down to 1806 the sole Jews' quarter, has been pulled down, with the exception of the ancestral house of the Rothschild family—No. 148—which has been restored and retains its ancient façade. As the Altstadt is mainly occupied by artisans and petty tradesmen, so the Neustadt is the principal business quarter of the city, containing the chief public buildings and the principal hotels. The main arteries of the city are the Zeil, a broad street running from the Friedberger Anlage to the Rossmarkt and thence continued, by the Kaiserstrasse, through the fine new quarter built after 1872, to the magnificent principal railway station; and the Steinweg and Goethestrasse, which lead by the Bockenheimer Tor to the Bockenheimer Landstrasse, a broad boulevard intersecting the fashionable residential suburb to the N.W.

Churches.—The principal ecclesiastical building in Frankfort is the cathedral (Dom). Built of red sandstone, with a massive tower terminating in a richly ornamented cupola and 300 ft. in height, it is the most conspicuous object in the city. This building, in which the Roman emperors were formerly elected and, since 1562, crowned, was founded in 852 by King Louis the German, and was later known as the Salvator Kirche. After its reconstruction (1235-1239), it was dedicated to St Bartholomew. From this period date the nave and the side aisles; the choir was completed in 1319-1338 and the long transepts in 1346-1354. The cloisters were rebuilt in 1348-1447, and the electoral chapel, on the south of the choir, was completed in 1355. The tower was begun in 1415, but remained unfinished. On the 15th of August 1867 the tower and roof were destroyed by fire and considerable damage was done to the rest of the edifice. The restoration was immediately taken in hand, and the whole work was finished in 1881, including the completion of the tower, according to the plans of the 15th century architect, Hans von Engelheim. In the interior is the tomb of the German king Günther of Schwarzburg, who died in Frankfort in 1349, and that of Rudolph, the last knight of Sachsenhausen, who died in 1371. Among the other Roman Catholic churches are the Leonhardskirche, the Liebfrauenkirche (church of Our Lady) and the Deutschordenskirche (14th century) in Sachsenhausen. The Leonhardkirche (restored in 1882) was begun in 1219, it is said on the site of the palace of Charlemagne. It was originally a three-aisled basilica, but is now a five-aisled *Hallenkirche*; the choir was added in 1314. It has two Romanesque towers. The Liebfrauenkirche is first mentioned in 1314 as a collegiate church; the nave was consecrated in 1340. The choir was added in 1506-1509 and the whole church thoroughly restored in the second half of the 18th century, when the tower was built (1770). Of the Protestant churches the oldest is the Nikolalkirche, which dates from the 13th century, the fine cast-iron spire erected in 1843 had to be taken down in 1901. The Paulskirche, the principal Evangelical (Lutheran) church, built between 1786 and 1833, is a red sandstone edifice of no architectural pretensions, but interesting as the seat of the national parliament of 1848-1849. The Katharinenkirche, built 1678-1681 on the site of an older building, is famous in Frankfort history as the place where the first Protestant sermon was preached in 1522. Among the more noteworthy of the newer Protestant churches are the Peterskirche (1892-1895) in the North German Renaissance style, with a tower 256 ft. high, standing north from the Zeil, the Christuskirche (1883) and the Lutherkirche (1889-1893). An English church, in Early English Gothic style, situated adjacent to the

Bockenheimer Landstrasse, was completed and consecrated in 1906.

Of the five synagogues, the chief (or Hauptsynagoge), lying in the Börnestrasse, is an attractive building of red sandstone in the Moorish-Byzantine style.

Public Buildings.—Of the secular buildings in Frankfort, the Römer, for almost five hundred years the Rathaus (town hall) of the city, is of prime historical interest. It lies on the Römerberg, a square flanked by curious medieval houses. It is first mentioned in 1322, was bought with the adjacent hostelry in 1405 by the city and rearranged as a town hall, and has since, from time to time, been enlarged by the purchase of adjoining patrician houses, forming a complex of buildings of various styles and dates surmounted by a clock tower. The façade was rebuilt (1896-1898) in late Gothic style. It was here, in the Wahlzimmer (or election-chamber) that the electors or their plenipotentiaries chose the German kings, and here in the Kaisersaal (emperors' hall) that the coronation festival was held, at which the new king or emperor dined with the electors after having shown himself from the balcony to the people. The Kaisersaal retained its antique appearance until 1843, when, as also again in 1904, it was restored and redecorated; it is now furnished with a series of modern paintings representing the German kings and Roman emperors from Charlemagne to Francis II., in all fifty-two, and a statue of the first German emperor, William I. New municipal buildings adjoining the "Römer" on the north side were erected in 1900-1903 in German Renaissance style, with a handsome tower 220 ft. high; beneath it is a public wine-cellar, and on the first storey a grand municipal hall. The palace of the princes of Thurn and Taxis in the Eschenheimer Gasse was built (1732-1741) from the designs of Robert de Cotte, chief architect to Louis XIV. of France. From 1806 to 1810 it was the residence of Karl von Dalberg, prince-primate of the Confederation of the Rhine, with whose dominions Frankfort had been incorporated by Napoleon. From 1816 to 1866 it was the seat of the German federal diet. It is now annexed to the principal post office (built 1892-1894), which lies close to it on the Zeil. The Saalhof, built on the site of the palace erected by Louis the Pious in 822, overlooking the Main, has a chapel of the 12th century, the substructure dating from Carolingian times. This is the oldest building in Frankfort. The façade of the Saalhof in the Saalgasse dates from 1604, the southern wing with the two gables from 1715 to 1717. Of numerous other medieval buildings may be mentioned the Leinwandhaus (linendrapers' hall), a 15th century building reconstructed in 1892 as a municipal museum. In the Grosser Hirschgraben is the Goethehaus, a 16th century building which came into the possession of the Goethe family in 1733. Here Goethe lived from his birth in 1749 until 1775. In 1803 the house was acquired by the *Freies deutsche Hochstift* and was opened to the public. It has been restored, from Goethe's account of it in *Dichtung und Wahrheit*, as nearly as possible to its condition in the poet's day, and is now connected with a Goethemuseum (1897), with archives and a library of 25,000 volumes representative of the Goethe period of German literature.

Literary and Scientific Institutions.—Few cities of the same size as Frankfort are so richly endowed with literary, scientific and artistic institutions, or possess so many handsome buildings appropriated to their service. The opera-house, erected near the Bockenheimer Tor in 1873-1880, is a magnificent edifice in the style of the Italian Renaissance and ranks among the finest theatres in Europe. There are also a theatre (*Schauspielhaus*) in modern Renaissance style (1899-1902), devoted especially to drama, a splendid concert hall (*Saalbau*), opened in 1861, and numerous minor places of theatrical entertainment. The public picture gallery in the Saalhof possesses works by Hans Holbein, Grünewald, Van Dyck, Teniers, Van der Neer, Hans von Kulmbach, Lucas Cranach and other masters. The Süddel Art Institute (Stüdel'sches Kunstinstitut) in Sachsenhausen, founded by the banker J. F. Stüdel in 1816, contains a picture gallery and a cabinet of engravings extremely rich in works of German art. The municipal library, with 300,000 volumes,

boasts among its rarer treasures a Gutenberg Bible printed at Mainz between 1450 and 1455, another on parchment dated 1462, the *Institutiones Justiniani* (Mainz, 1468), the *Thewerdank*, with woodcuts by Hans Schütelein, and numerous valuable autographs. It also contains a fine collection of coins. The Bethmann Museum owes its celebrity principally to Dannecker's "Ariadne," but it also possesses the original plaster model of Thorwaldsen's "Entrance of Alexander the Great into Babylon." There may also be mentioned the Industrial Art Exhibition of the Polytechnic Association and two conservatories of music. Among the scientific institutions the first place belongs to the *Senckenberg'sches naturhistorische Museum*, containing valuable collections of birds and shells. Next must be mentioned the *Kunstgewerbe* (museum of arts and crafts) and the Musical Museum, with valuable MSS. and portraits. Besides the municipal library (*Stadtbibliothek*) mentioned above there are three others of importance, the Rothschild, the Senckenberg and the Jewish library (with a well-appointed reading-room). There are numerous high-grade schools, musical and other learned societies and excellent hospitals. The last include the large municipal infirmary and the Senckenberg'sches Stift, a hospital and almshouses founded by a doctor, Johann C. Senckenberg (d. 1772). The Royal Institute for experimental therapeutics (*Königl. Institut für experimentelle Therapie*), moved to Frankfurt in 1899, attracts numerous foreign students, and is especially concerned with the study of bacteriology and serums.

Bridges.—Seven bridges (of which two are railway) cross the Main. The most interesting of these is the Alte Mainbrücke, a red sandstone structure of fourteen arches, 815 ft. long, dating from the 14th century. On it are a mill, a statue of Charlemagne and an iron crucifix surmounted by a gilded cock. The latter commemorates, according to tradition, the fowl which was the first living being to cross the bridge and thus fell a prey to the devil, who in hope of a nobler victim had sold his assistance to the architect. Antiquaries, however, assert that it probably marks the spot where criminals were in olden times flung into the river. Other bridges are the Obermainbrücke of five iron arches, opened in 1878; an iron foot (suspension) bridge, the Untermainbrücke; the Wilhelmbrücke, a fine structure, which from 1849 to 1890 served as a railway bridge and was then opened as a road bridge; and two new iron bridges at Gutleuthof and Niederrad (below the city), which carry the railway traffic from the south to the north bank of the Main, where all lines converge in a central station of the Prussian state railways. This station, which was built in 1883-1888 and has replaced the three stations belonging to private companies, which formerly stood in juxtaposition on the Anlagen (or promenades) near the Mainzer Tor, lies some half-mile to the west. The intervening ground upon which the railway lines and buildings stood was sold for building sites, the sum obtained being more than sufficient to cover the cost of the majestic central terminus (the third largest in the world), which, in addition to spacious and handsome halls for passenger accommodation, has three glass-covered spans of 180 ft. width each. Yet the exigencies of traffic demand further extensions, and another large station was in 1909 in process of construction at the east end of the city, devised to receive the local traffic of lines running eastward, while a through station for the north to south traffic was projected on a site farther west of the central terminus.

Frankfort lies at the junction of lines of railway connecting it directly with all the important cities of south and central Germany. Here cross and unite the lines from Berlin to Basel, from Cologne to Würzburg and Vienna, from Hamburg and Cassel, and from Dresden and Leipzig to France and Switzerland. The river Main has been dredged so as to afford heavy barge traffic with the towns of the upper Main and with the Rhine, and cargo boats load and unload alongside its busy quays. A well-devised system of electric tramways provides for local communication within the city and with the outlying suburbs.

Trade, Commerce and Industries.—Frankfort has always been more of a commercial than an industrial town, and though of late years it has somewhat lost its pre-eminant position as

a banking centre it has counterbalanced the loss in increased industrial development. The suburbs of Sachsenhausen and Bockenheim have particularly developed considerable industrial activity, especially in publishing and printing, brewing and the manufacture of quinine. Other sources of employment are the cutting of hair for making hats, the production of fancy goods, type, machinery, soap and perfumery, ready-made clothing, chemicals, electro-technical apparatus, jewelry and metal wares. Market gardening is extensively carried on in the neighbourhood and cider largely manufactured. There are two great fairs held in the town,—the Ostermesse, or spring fair, and the Herbstmesse, or autumn fair. The former, which was the original nucleus of all the commercial prosperity of the city, begins on the second Wednesday before Easter; and the latter on the second Wednesday before the 8th of September. They last three weeks, and the last day save one, called the *Nickelchestag*, is distinguished by the influx of people from the neighbouring country. The trade in leather is of great and growing importance. A horse fair has been held twice a year since 1862 under the patronage of the agricultural society; and the wool market was reinstated in 1872 by the German Trade Society (*Deutscher Handelsverein*). Frankfort has long been famous as one of the principal banking centres of Europe, and is now only second to Berlin, in this respect, among German cities, and it is remarkable for the large business that is done in government stock. In the 17th century the town was the seat of a great book-trade; but it has long been distanced in this department by Leipzig. The *Frankfurter Journal* was founded in 1615, the *Postzeitung* in 1616, the *Neue Frankfurter Zeitung* in 1850, and the *Frankfurter Presse* in 1866.

Of memorial monuments the largest and most elaborate in Frankfort is that erected in 1858 in honour of the early German printers. It was modelled by Ed. von der Launitz and executed by Herr von Kreis. The statues of Gutenberg, Fust and Schöffer form a group on the top; an ornamented frieze presents medallions of a number of famous printers; below these are figures representing the towns of Mainz, Strassburg, Venice and Frankfort; and on the corners of the pedestal are allegorical statues of theology, poetry, science and industry. The statue of Goethe (1844) in the Goetheplatz is by Ludwig von Schwanthaler. The Schiller statue, erected in 1863, is the work of a Frankfort artist, Johann Dietmann. A monument in the Bockenheim Anlage, dated 1837, preserves the memory of Guillet, the burgomaster, to whom the town is mainly indebted for the beautiful promenades which occupy the site of the old fortifications; and similar monuments have been reared to Senckenberg (1863), Schopenhauer, Klemens Brentano the poet and Samuel Thomas Sömmerring (1755-1830), the anatomist and inventor of an electric telegraph. In the Opernplatz is an equestrian statue of the emperor Wilhelm I. by Buscher.

Cemeteries.—The new cemetery (opened in 1828) contains the graves of Arthur Schopenhauer and Feuerbach, of Passavant the biographer of Raphael, Ballenberger the artist, Hessemmer the architect, Sömmerring, and Johann Friedrich Böhmer the historian. The Bethmann vault attracts attention by three bas-reliefs from the chisel of Thorwaldsen; and the Reichenbach mausoleum is a vast pile designed by Hessemmer at the command of William II. of Hesse, and adorned with sculptures by Zwerger and von der Lausitz. In the Jewish section, which is walled off from the rest of the burying-ground, the most remarkable tombs are those of the Rothschild family.

Parks.—In addition to the park in the south-western district, Frankfort possesses two delightful pleasure grounds, which attract large numbers of visitors, the Palmengarten in the west and the zoological garden in the east of the city. The former is remarkable for the collection of palms purchased in 1868 from the deposed duke Adolph of Nassau.

Government.—The present municipal constitution of the city dates from 1867 and presents some points of difference from the ordinary Prussian system. Bismarck was desirous of giving the city, in view of its former freedom, a more liberal constitution than is usual in ordinary cases. Formerly fifty-four representatives were elected, but provision was made (in the

constitution) for increasing the number, and they at present number sixty-four, elected for six years. Every two years a third of the number retire, but they are eligible for re-election. These sixty-four representatives elect twenty town-councillors, ten of whom receive a salary and ten do not. The chief burgo-master (Oberbürgermeister) is nominated by the emperor for two years, and the second burgo-master must receive the emperor's approval.

Since 1885 the city has been supplied with water of excellent quality from the Stadtwald, Goldstein and Hinkelstein, and the favourable sanitary condition of the town is seen in the low death rate.

Population.—The population of Frankfort has steadily increased since the beginning of the 19th century; it amounted in 1817 to 41,458; (1840) 55,269, (1864) 77,372; (1871) 59,265; (1875) 103,136; (1890) 179,985; and (1905), including the incorporated suburban districts, 334,951, of whom 175,909 were Protestants, 88,457 Roman Catholics and 21,974 Jews.

History.—Excavations around the cathedral have indisputably proved that Frankfort-on-Main (*Trojectum ad Moenum*) was a settlement in Roman times and was probably founded in the 1st century of the Christian era. It may thus be accounted one of the earliest German—the so-called "Roman"—towns. Numerous places in the valley of the Main are mentioned in chronicles anterior to the time that Frankfort is first noticed. Disregarding popular tradition, which connects the origin of the town with a legend that Charlemagne, when retreating before the Saxons, was safely conducted across the river by a doe, it may be asserted that the first genuine historical notice of the town occurs in 793, when Einhard, Charlemagne's biographer, tells us that he spent the winter in the villa Frankonovurd. Next year there is mention more than once of a royal palace here, and the early importance of the place is indicated by the fact that in this year it was chosen as the seat of the ecclesiastical council by which image-worship was condemned. The name Frankfort is also found in several official documents of Charlemagne's reign; and from the notices that occur in the early chronicles and charters it would appear that the place was the most populous at least of the numerous villages of the Main district. During the Carolingian period it was the seat of no fewer than 16 imperial councils or colloquies. The town was probably at first built on an island in the river. It was originally governed by the royal officer or *actor dominicus*, and down even to the close of the Empire it remained a purely imperial or royal town. It gradually acquired various privileges, and by the close of the 14th century the only mark of dependence was the payment of a yearly tax. Louis the Pious dwelt more frequently at Frankfort than his father Charlemagne had done, and about 823 he built himself a new palace, the basis of the later Saalhof. In 822 and 823 two great diets were held in the palace, and at the former there were present deputies from the eastern Slavs, the Avars and the Normans. The place continued to be a favourite residence with Louis the German, who died there in 876, and was the capital of the East Frankish kingdom. By the rest of the Carolingian kings it was less frequently visited, and this neglect was naturally greater during the period of the Saxon and Salic emperors from 919 to 1137. Diets, however, were held in the town in 951, 1015, 1060 and 1109, and councils in 1000 and 1006. From a privilege of Henry IV, in 1074, granting the city of Worms freedom from tax in their trade with several royal cities, it appears that Frankfort was even then a place of some commercial importance.

Under the Hohenstaufens many brilliant diets were held within its walls. That of 1147 saw, also, the first election of a German king at Frankfort, in the person of Henry, son of Conrad III. But as the father outlived the son, it was Frederick I, Barbarossa, who was actually the first reigning king to be elected here (in 1152). With the beginning of the 13th century the municipal constitution appears to have taken definite shape. The chief official was the royal bailiff (*Schultheiss*), who is first mentioned in 1193, and whose powers were subsequently enlarged by the abolition, in 1279, of the office of the royal *Vogt* or *advocatus*.

About this time a body of *Schöffen* (*scabini*, jurats), fourteen in number, was formed to assist in the control of municipal affairs, and with their appointment the first step was taken towards civic representative government. Soon, however, the activity of the *Schöffen* became specifically confined to the determination of legal disputes, and in their place a new body (*Collegium*) of counsellors—*Rathmannen*—also fourteen in number, was appointed for the general administration of local matters. In 1311, the two burgo-masters, now chiefs of the municipality, take the place of the royal *Schultheiss*. In the 13th century, the Frankfort Fair, which is first mentioned in 1150, and the origin of which must have been long anterior to that date, is referred to as being largely frequented. No fewer than 10 new churches were erected in the years from 1220 to 1270. It was about the same period, probably in 1240, that the Jews first settled in the town. In the contest which Louis the Bavarian maintained with the papacy Frankfort sided with the emperor, and it was consequently placed under an interdict for 20 years from 1329 to 1349. On Louis's death it refused to accept the papal conditions of pardon, and only yielded to Charles IV., the papal nominee, when Günther of Schwarzburg thought it more prudent to abdicate in his favour. Charles granted the city a full amnesty, and confirmed its liberties and privileges.

By the famous Golden Bull of 1356 Frankfort was declared the seat of the imperial elections, and it still preserves an official contemporaneous copy of the original document as the most precious of the eight imperial bulls in its possession. From the date of the bull to the close of the Empire Frankfort retained the position of "Wahlstadt," and only five of the two-and-twenty monarchs who ruled during that period were elected elsewhere. In 1388-1389 Frankfort assisted the South German towns in their wars with the princes and nobles (the *Städtekrig*), and in a consequent battle with the troops of the Palatinate, the town banner was lost and carried to Kronberg, where it was long preserved as a trophy. On peace being concluded in 1391, the town had to pay 12,562 florins, and this brought it into great financial difficulties. In the course of the next 50 years debt was contracted to the amount of 126,772 florins. The diet at Worms in 1495 chose Frankfort as the seat of the newly instituted imperial chamber, or "*Reichskammergericht*," and it was not till 1527 that the chamber was removed to Spire. At the Reformation Frankfort heartily joined the Protestant party, and in consequence it was hardly treated both by the emperor Charles V. and by the archbishop of Mainz. It refused to subscribe the Augsburg Recess, but at the same time it was not till 1536 that it was persuaded to join the League of Schmalkalden. On the failure of this confederation it opened its gates to the imperial general Büren on the 29th of December 1546, although he had passed by the city, which he considered too strong for the forces under his command. The emperor was merciful enough to leave it in possession of its privileges, but he inflicted a fine of 80,000 gold gulden, and until October 1547 the citizens had to endure the presence of from 8000 to 10,000 soldiers. This resulted in a pestilence which not only lessened the population, but threatened to give the death-blow to the great annual fairs; and at the close of the war it was found that it had cost the city no less than 228,931 gulden. In 1552 Frankfort was invested for three weeks by Maurice of Saxony, who was still in arms against the emperor Charles V., but it continued to hold out till peace was concluded between the principal combatants. Between 1612 and 1616 occurred the great Fettmilch insurrection, perhaps the most remarkable episode in the internal history of Frankfort. The magistracy had been acquiring more and more the character of an oligarchy; all power was practically in the hands of a few closely-related families; and the gravest peculation and malversation took place without hindrance. The ordinary citizens were roused to assert their rights, and they found a leader in Vincenz Fettmilch, who carried the contest to dangerous excesses, but lacked ability to bring it to a successful issue. An imperial commission was ultimately appointed, and the three principal culprits and several of their associates were executed in 1616. It was not till

1801 that the last mouldering head of the Fettmilch company dropped unnoticed from the Rentenkurm, the old tower near the bridge. In the words of Dr Kriegg, *Geschichte von Frankfurt*, (1871), the insurrection completely destroyed the political power of the guilds, gave new strength to the supremacy of the patriciate, and brought no further advantage to the rest of the citizens than a few improvements in the organization and administration of the magistracy. The Jews, who had been attacked by the popular party, were solemnly reinstated by imperial command in all their previous privileges, and received full compensation for their losses.

During the Thirty Years' War Frankfurt did not escape. In 1631 Gustavus Adolphus garrisoned it with 600 men, who remained in possession till they were expelled four years later by the imperial general Lamboy. In 1792 the citizens had to pay 2,000,000 gulden to the French general Custine; and in 1796 Kléber exacted 8,000,000 francs. The independence of Frankfurt was brought to an end in 1806, on the formation of the Confederation of the Rhine; and in 1810 it was made the capital of the grand-duchy of Frankfurt, which had an area of 3215 sq. m. with 302,100 inhabitants, and was divided into the four districts of Frankfurt, Aschaffenburg, Fulda and Hanau. On the reconstitution of Germany in 1815 it again became a free city, and in the following year it was declared the seat of the German Confederation. In April 1833 occurred what is known as the Frankfurt Insurrection (Frankfurter Attentat), in which a number of insurgents led by Georg Bunsen attempted to break up the diet. The city joined the German Zollverein in 1836. During the revolutionary period of 1848 the people of Frankfurt, where the united German parliament held its sessions, took a chief part in political movements, and the streets of the town were more than once the scene of conflict. In the war of 1866 they were on the Austrian side. On the 16th of July the Prussian troops, under General Vogel von Falkenstein, entered the town, and on the 18th of October it was formally incorporated with the Prussian state. A fine of 6,000,000 florins was exacted. In 1871 the treaty which concluded the Franco-German War was signed in the Swan Hotel by Prince Bismarck and Jules Favre, and it is consequently known as the peace of Frankfurt.

AUTHORITIES.—F. Rittweger, *Frankfurt im Jahre 1848* (1898); E. Jung, *Das historische Archiv der Stadt Frankfurt* (1897); A. Horne, *Geschichte von Frankfurt* (4th ed., 1903); H. Grotfend, *Quellen zur Frankfurter Geschichte* (Frankfurt, 1884-1888); J. C. von Fichard, *Die Entstehung der Reichsstadt Frankfurt* (Frankfurt, 1810); G. L. Kriegg, *Geschichte von Frankfurt* (Frankfurt, 1871); J. F. Böhmner, *Wanderbuch der Reichsstadt Frankfurt* (new ed., 1907); B. Weber, *Die Reformationsgeschichte der freien Reichsstadt Frankfurt* (1895); O. Speyer, *Die Frankfurter Revolution 1612-1616* (1883); and L. Woelfl, *Guide to Frankfurt* (Leipzig, 1898).

FRANKFORT-ON-ODER, a town of Germany, in the Prussian province of Brandenburg, 50 m. S.E. from Berlin on the main line of railway to Breslau and at the junction of lines to Custrin, Hsen and Grossenhain. Pop. (1905) 64,943. The town proper is on the left bank of the river Oder and is connected by a stone bridge (replacing the old historical wooden structure) 900 ft. long, with the suburb of Damm. The town is agreeably situated and has broad and handsome streets, among them the "Linden," a spacious avenue. Above, on the western side, and partly lying on the site of the old ramparts, is the residential quarter, consisting mainly of villas and commanding a fine prospect of the Oder valley. Between this suburb and the town lies the park, in which is a monument to the poet Ewald Christian von Kleist, who died here of wounds received in the battle of Kunersdorf. Among the more important public buildings must be noticed the Evangelical Marienkirche (Oberkirche), a handsome brick edifice of the 13th century with five aisles, the Roman Catholic church, the Rathhaus dating from 1607, and bearing on its southern gable the device of a member of the Hanseatic League, the government offices and the theatre. The university of Frankfurt, founded in 1506 by Joachim I., elector of Brandenburg, was removed to Breslau in 1811, and the academical buildings are now occupied by a school. To compensate it for the loss of its university, Frankfort-on-Oder was long the seat

of the court of appeal for the province, but of this it was deprived in 1879. There are several handsome public monuments, notably that to Duke Leopold of Brunswick, who was drowned in the Oder while attempting to save life, on the 27th of April 1785. The town has a large garrison, consisting of nearly all arms. Its industries are considerable, including the manufacture of machinery, metal ware, chemicals, paper, leather and sugar. Situated on the high road from Berlin to Silesia, and having an extensive system of water communication by means of the Oder and its canals to the Vistula and the Elbe, and being an important railway centre, it has a lively export trade, which is further fostered by its three annual fairs, held respectively at *Reminisere* (the second Sunday in Lent), St Margaret's day and at Martinmas. In the neighbourhood are extensive coal fields.

Frankfort-on-the-Oder owes its origin and name to a settlement of Franconian merchants here, in the 13th century, on land conquered by the margrave of Brandenburg from the Wends. In 1253 it was raised to the rank of a town by the margrave John I. and borrowed from Berlin the Magdeburg civic constitution. In 1379 it received from King Sigismund, then margrave of Brandenburg, the right to free navigation of the Oder, and from 1368 to about 1450 it belonged to the Hanseatic League. The university, which is referred to above, was opened by the elector Joachim I. in 1506, was removed in 1516 to Kottbus and restored again to Frankfurt in 1539, at which date the Reformation was introduced. It was dispersed during the Thirty Years' War and again restored by the Great Elector, but finally transferred to Breslau in 1811.

Frankfort has suffered much from the vicissitudes of war. In the 15th century it successfully withstood sieges by the Hussites (1429 and 1432), by the Poles (1450) and by the duke of Sagan (1477). In the Thirty Years' War it was successively taken by Gustavus Adolphus (1631), by Wallenstein (1633), by the elector of Brandenburg (1634), and again by the Swedes, who held it from 1640 to 1644. During the Seven Years' War it was taken by the Russians (1759). In 1812 it was occupied by the French, who remained till March 1813, when the Russians marched in.

See K. R. Hausen, *Geschichte der Universität und Stadt Frankfurt* (1806), and Bieder and Gurnik, *Bilder aus der Geschichte der Stadt Frankfurt-an-der-Oder* (1898).

FRANKINCENSE,¹ or **OLIBANUM**² (Gr. *λίβανός*, later *θιβός*; Lat., *lus* or *thus*; Heb., *lebani*;³ Ar., *lubān*; Turk., *ghyunluk*; Hind., *ganda-biroso*), a gum-resin obtained from certain species of trees of the genus *Boswellia*, and natural order *Burseraceae*. The members of the genus are possessed of the following characters:—Bark often papyraceous; leaves deciduous, compound, alternate and imparipinnate, with leaflets serrate or entire; flowers in racemes or panicles, white, green, yellowish or pink, having a small persistent, 5-dentate calyx, 5 petals, 10 stamens, a sessile 3 to 5-chambered ovary, a long style, and a 3-lobed stigma; fruit trigonal or pentagonal; and seed compressed. Sir George Birdwood (*Trans. Lin. Soc.* xxvii.,

¹ Stephen Skinner, M.D. (*Etymologiae linguae Anglicanae*, Lond., 1671), gives the derivation: "Frankincense, Thus, q.d. Incensum (i.e. Thus Libere seu Liberaliter, ut in sacris officiis par est, adoleendum."

² "Sic *olibanum* dixerit pro *thure* ex Graeco *λίβανος*" (Salmasius, *C. S. Plinianae exercitationes*, t. ii. p. 926, b. f., Traj. ad Rhen., 1689 fol.). So also Fuchs (*Op. didact.* pars. ii. p. 42, 1604 fol.). "Officinis non sine risu eruditorum, Graeco articulo adjecto, *Olibanum* vocatur." The term *olibanum* was used in ecclesiastical Latin as early as the pontificate of Benedict IX., in the 11th century. (See Ferd. Ughellus, *Italia sacra*, tom. i. 108, D., Ven., 1717 fol.)

³ So designated from its whiteness (J. C. Stuckius, *Sacror. et sacrific. gent. descrip.*, p. 79, Lugd. Bat., 1695, fol.; Kitto, *Cycl. Bibl. Lit.* ii. p. 806, 1870); cf. *Laben*, the Somali name for cream (R. F. Burton, *First Footsteps in E. Africa*, p. 178, 1856).

⁴ Written *Louani* by Garcias da Horta (*Aromat. et simpl. medicament. Hist.*, C. *Cinisi Arabalis Exalticorum lib. sept.*, p. 157, 1605, fol.), and stated to have been derived by the Arabs from the Greek name, the term less commonly used by them being *Cander*; cf. Sanskrit *Kunda*. According to Colebrooke (in *Asiatic Res.* ix. p. 379, 1807), the Hindu writers on Materia Medica use for the resin of *Boswellia thurifera* the designation *Canduru*.

⁵ A term applied also to the resinous exudation of *Pinus longifolia* (see Dr E. J. Waring, *Pharmacopoeia of India*, p. 52, Lond., 1868).

1871) distinguishes five species of *Boswellia*: (A) *B. thurifera*, Colebr. (*B. glabra* and *B. serrata*, Roxb.), indigenous to the mountainous tracts of central India and the Coromandel coast, and *B. papyrifera* (*Plösslea floribunda*, Endl.) of Abyssinia, which, though both thuriferous, are not known to yield any of the oil of commerce; and (B) *B. frereana* (see ELEM., vol. x. p. 259), *B. Bhu-Dajiana*, and *B. Carteri*, the "Yeggar," "Mohr Add," and "Mohr Madow" of the Somali country, in East Africa, the last species including a variety, the "Maghrayt d'Sheclaz" of Hadramaut, Arabia, all of which are sources of true frankincense or olibanum. The trees on the Somali coast are described by Captain G. B. Kemphorne as growing, without soil, out of polished marble rocks, to which they are attached by a thick oval mass of substance resembling a mixture of lime and mortar: the purer the marble the finer appears to be the growth of the tree. The young trees, he states, furnish the most valuable gum, the older yielding merely a clear glutinous fluid resembling copal varnish.¹ To obtain the frankincense a deep incision is made in the trunk of the tree, and below it a narrow strip of bark 5 in. in length is peeled off. When the milk-like juice ("spuma pinguis," Pliny) which exudes has hardened by exposure to the atmosphere, the incision is deepened. In about three months the resin has attained the required degree of consistency. The season for gathering lasts from May until the first rains in September. The large clear globules are scraped off into baskets, and the inferior quality that has run down the tree is collected separately. The coast of south Arabia is yearly visited by parties of Somalis, who pay the Arabs for the privilege of collecting frankincense.² In the interior of the country about the plain of Dhofar,³ during the south-west monsoon, frankincense and other gums are gathered by the Beni Gurrah Bedouins, and might be obtained by them in much larger quantities; their lawlessness, however, and the lack of a safe place of exchange or sale are obstacles to the development of trade. (See C. Y. Ward, *The Gulf of Aden Pilot*, p. 117, 1863.) Much as formerly in the region of Sakhalites in Arabia (the tract between Ras Makalla and Ras Agab),⁴ described by Arrian, so now on the sea-coast of the Somali country, the frankincense when collected is stored in heaps at various stations. Thence, packed in sheep- and goat-skins, in quantities of 20 to 40 lb, it is carried on camels to Berbera, for shipment either to Aden, Makalla and other Arabian ports, or directly to Bombay.⁵ At Bombay, like gum-acacia, it is assorted, and is then packed for re-exportation to Europe, China and elsewhere.⁶ Arrian relates that it was an import of Barbarike on the Sinthus (Indus). The idea held by several writers, including Niebuhr, that frankincense was a product of India, would seem to have originated in a confusion of that drug with benzoin and other odoriferous substances, and also in the sale of imported frankincense with the native products of India. The gum resin of *Boswellia thurifera* was described by Colebrooke (in *Asiatick Researches*, ix. 381), and after him by Dr J. Fleming (*Ib.* xi. 158), as true frankincense, or olibanum; from this, however, it differs in its softness, and tendency to melt into a mass⁷ (Birdwood, *loc. cit.*, p. 146). It is sold in the village bazaars of Khandeish in India under the name of *Dup-Salai*, i.e. incense of the "Salai tree"; and according to Mr F. Porter Smith, M.B. (*Contrib. towards the Mat. Med. and Nat. Hist. of China*, p. 162, Shanghai, 1871), is used as incense in China. The last authority also mentions⁸ "See "Appendix," vol. i. p. 419 of Sir W. C. Harris's *Highland of Aethiopia* (2nd ed., Lond., 1844); and *Trans. Bombay Geog. Soc.* xiii. (1857), p. 136.

² Cruttenden, *Trans. Bombay Geog. Soc.* vii. (1846), p. 121; S. B. Miles, *J. Geog. Soc.* (1872).

³ Or Dhofar. The incense of "Dofar" is alluded to by Camoens, *Os Lusitadas*, x. 201.

⁴ H. J. Carter, "Comparative Geog. of the South-East Coast of Arabia," in *J. Bombay Branch of R. Asiatic Soc.* iii. (Jan. 1851), p. 296; and Müller, *Geog. Graeci Minores*, i. p. 278 (Paris, 1855).

⁵ J. Vaughan, *Pharm. Journ.* xii. (1853) pp. 227-229; and Ward, *op. cit.* p. 97.

⁶ Pereira, *Elem. of Mat. Med.* ii. pt. 2, p. 380 (4th ed., 1847).

⁷ "*Boswellia thurifera*," says Waring (*Pharm. of India*, p. 52), "has been thought to yield East Indian olibanum, but there is no reliable evidence of its so doing."

olibanum as a reputed natural product of China. Bernhard von Breydenbach,⁹ Aousonius, Florus and others, arguing, it would seem, from its Hebrew and Greek names, concluded that olibanum came from Mount Lebanon; and Chardin (*Voyage en Perse*, &c., 1711) makes the statement that the frankincense tree grows in the mountains of Persia, particularly Caramania.

Frankincense, or olibanum, occurs in commerce in semi-opaque, round, ovate or oblong tears or irregular lumps, which are covered externally with a white dust, the result of their friction against one another. It has an amorphous internal structure, a dull fracture; is of a yellow to yellowish-brown hue, the purer varieties being almost colourless, or possessing a greenish tinge, and has a somewhat bitter aromatic taste, and a balsamic odour, which is developed by heating. Immersed in alcohol it becomes opaque, and with water it yields an emulsion. It contains about 72% of resin soluble in alcohol (Kurbatow); a large proportion of gum soluble in water, and apparently identical with gum arabic; and a small quantity of a colourless inflammable essential oil, one of the constituents of which is the body oil, C₁₀H₁₆. Frankincense burns with a bright white flame, leaving an ash consisting mainly of calcium carbonate, the remainder being calcium phosphate, and the sulphate, chloride and carbonate of potassium (Braconnot).¹⁰ Good frankincense, Pliny tells us, is recognized by its whiteness, size, brittleness and ready inflammability. That which occurs in globular drops is, he says, termed "male frankincense"; the most esteemed, he further remarks, is in breast-shaped drops, formed each by the union of two tears.¹¹ The best frankincense, as we learn from Arrian,¹² was formerly exported from the neighbourhood of Cape Elephant in Africa (the modern Ras Fiel); and A. von Kremer, in his description of the commerce of the Red Sea (*Aegypten*, &c., p. 185, ii. Theil, Leipzig, 1863), observes that the African frankincense, called by the Arabs "asli," is of twice the value of the Arabian "luban." Captain S. B. Miles (*loc. cit.*, p. 64) states that the best kind of frankincense, known to the Somali as "bedwi" or "sheheri," comes from the trees "Mohr Add" and "Mohr Madow" (*vide supra*), and from a taller species of *Boswellia*, the "Boido," and is sent to Bombay for exportation to Europe; and that an inferior "mayeti," the produce of the "Yeggar," is exported chiefly to Jeddah and Yemen ports.¹³ The latter may possibly be what Niebuhr alludes to as "Indian frankincense."¹⁴ Garcias da Horta, in asserting the Arabian origin of the drug, remarks that the term "Indian" is often applied by the Arabs to a dark-coloured variety.¹⁵

According to Pliny (*Nat. Hist.* xiv. 1; cf. Ovid, *Fasti* i. 337

¹ "Libanus igitur est mons redolentis & summe aromaticitatis. nam ibi herbe odorifere crescunt. ibi etiam arbores thurifere coalescunt quarum gummi electum olibanum a medicis nuncupatur."—*Perigrinatio*, p. 53 (1502, fol.).

² See, on the chemistry of frankincense, Braconnot, *Ann. de chimie*, lxxviii. (1808) pp. 60-69; Johnston, *Phil. Trans.* (1839), pp. 301-303; J. Stenhouse, *Ann. der Chem. und Pharm.* xxxv. (1840) p. 306; and A. Kurbatow, *Zeitsch. für Chem.* (1871), p. 201.

³ "Fræcipua autem gratia est marmosco, cum hærente lacryma priore consecuta alia miscuit se" (*Nat. Hist.* xii. 32). One of the Chinese names for frankincense, *Ju-hiang*, "milk-perfume," is explained by the *Pen Tsan* (xxiv. 45), a Chinese work, as being derived from the nipple-like form of its drops. (See E. Bretschneider, *On the Knowledge possessed by the Ancient Chinese of the Arabs*, &c., p. 19, Lond., 1871.)

⁴ *The Voyage of Nearchus*, *loc. cit.*

⁵ Vaughan (*Pharm. Journ.* xii. 1853) speaks of the Arabian Luban, commonly called *Morbat* or *Shaharree Luban*, as realizing higher prices in the market than any of the qualities exported from Africa. The incense of "Esber," i.e. Shih or Shehr, is mentioned by Marco Polo, as also by Barbosa. (See Yule, *op. cit.* ii. p. 377.) J. Raymond Wellsted (*Travels to the City of the Caliphs*, p. 173, Lond., 1840) distinguishes two kinds of frankincense—"Mauy," selling at \$4 per cwt., and an inferior article fetching 20% less.

⁶ "Es scheint, dass selber die Araber ihr eignes Räucherwerk nicht hoch schätzen; denn die Vornehmer in Jemen brauchen gemeinlich indianisches Räucherwerk, ja eine grosse Menge Mastix von der Insel Scio" (*Beschreibung von Arabien*, p. 143, Kopenh., 1772).

⁷ "De Arabibus minus mirum, qui nigricantem colorem, quo Thus Indicum præditum esse vult Dioscorides [lib. i. c. 70], Indum plerumque vocent, ut ex Myrobalano nigro quem Indum appellant, patet" (*op. sup. cit.* p. 157).

sq-7, frankincense was not sacrificially employed in Trojan times. It was used by the ancient Egyptians in their religious rites, but, as Herodotus tells us (ii. 86), not in embalming. It constituted a fourth part of the Jewish incense of the sanctuary (Ex. xxx. 34), and is frequently mentioned in the Pentateuch. With other spices it was stored in a great chamber of the house of God at Jerusalem (1 Chron. ix. 29, Neh. xiii. 5-9). On the sacrificial use and import of frankincense and similar substances see INCENSE.

In the Red Sea regions frankincense is valued not only for its sweet odour when burnt, but as a masticatory; and blazing lumps of it are not infrequently used for illumination instead of oil lamps. Its fumes are an excellent insectifuge. As a medicine it was in former times in high repute. Pliny (*Nat. Hist.* xxv. 82) mentions it as an antidote to hemlock. Avicenna (ed. Plempil, *ib. ii.* p. 161, Lovanii, 1658, fol.) recommends it for tumours, ulcers of the head and ears, affections of the breast, vomiting, dysentery and fevers. In the East frankincense has been found efficacious as an external application in carbuncles, blind boils and gangrenous sores, and as an internal agent is given in gonorrhoea. In China it was an old internal remedy for leprosy and struma, and is accredited with stimulant, tonic, sedative, astringent and vulnerary properties. It is not used in modern medicine, being destitute of any special virtues. (See Waring, *Pharm. of India*, p. 443, &c.; and F. Porter Smith, *op. cit.*, p. 162.)

Common frankincense or thus, *Abies resino*, is the term applied to a resin which exudes from fissures in the bark of the Norway spruce fir, *Abies excelsa*, D.C.; when melted in hot water and strained it constitutes "Burgundy pitch," *Pice abietina*. The concreted turpentine obtained in the United States by making incisions in the trunk of a species of pine, *Pinus strobus*, is also so designated. It is commercially known as "scrape," and is similar to the French "galipot" or "barras." Common frankincense is an ingredient in some ointments and plasters, and on account of its pleasant odour when burned has been used in incense as a substitute for oilburnum. (See Flückiger and Hanbury, *Pharmacographia*.) The "black frankincense oil" of the Turks is stated by Hanbury (*Science Papers*, p. 142, 1876) to be liquid storax. (F. H. B.)

FRANKING, a term used for the right of sending letters or postal packages free (*Fr. franc*) of charge. The privilege was deemed by the House of Commons in 1660 in "a Bill for erecting and establishing a Post Office," their demand being that all letters addressed to or sent by members during the session should be carried free. The clause embodying this claim was struck out by the Lords, but with the proviso in the Act as passed for the free carriage of all letters to and from the king and the great officers of state, and also the single inland letters of the members of that present parliament during that session only. It seems, however, that the practice was tolerated until 1764, when by an act dealing with postage it was legalized, every peer and each member of the House of Commons being allowed to send free ten letters a day, not exceeding an ounce in weight, to any part of the United Kingdom, and to receive fifteen. The act did not restrict the privilege to letters either actually written by or to the member, and thus the right was very easily abused, members sending and receiving letters for friends, all that was necessary being the signature of the peer or M.P. in the corner of the envelope. Wholesale franking grew usual, and M.P.'s supplied their friends with envelopes already signed to be used at any time. In 1837 the scandal had become so great that stricter regulations came into force. The franker had to write the full address, to which he had to add his name, the post-town and the day of the month; the letter had to be posted on the day written or the following day at the latest, and in a post-town not more than 20 m. from the place where the peer or M.P. was then living. On the 10th of January 1840 parliamentary franking was abolished on the introduction of the uniform penny rate.

In the United States the franking privilege was first granted in January 1776 to the soldiers engaged in the American War of Independence. The right was gradually extended till it included nearly all officials and members of the public service. By special acts the privilege was bestowed on presidents and their widows.

By an act of the 3rd of March 1845, franking was limited to the president, vice-president, members and delegates in Congress and postmasters, other officers being required to keep quarterly accounts of postage and pay it from their contingent funds. In 1851 free exchange of newspapers was re-established. By an act of the 3rd of March 1863 the privilege was granted the president and his private secretary, the vice-president, chiefs of executive departments, such heads of bureaus and chief clerks as might be designated by the postmaster-general for official letters only; senators and representatives in Congress for all correspondence, senders of petitions to either branch of the legislature, and to publishers of newspapers for their exchanges. There was a limit as to weight. Members of Congress could also frank, in matters concerning the federal department of agriculture, "seeds, roots and cuttings," the weight to be fixed by the postmaster-general. This act remained in force till the 31st of January 1873, when franking was abolished. Since 1875, by sundry acts, franking for official correspondence, government publications, seeds, &c., has been allowed to congressmen, ex-congressmen (for 9 months after the close of their term), congressmen-elect and other government officials. By special acts of 1881, 1886, 1902, 1909, respectively, the franking privilege was granted to the widows of Presidents Garfield, Grant, McKinley and Cleveland.

FRANKL, LUDWIG AUGUST (1810-1894), Austrian poet. He took part in the revolution of 1848, and his poems on liberty had considerable vogue. His lyrics are among his best work. He was secretary of the Jewish community in Vienna, and did a lasting service to education by his visit to the Orient in 1856. He founded the first modern Jewish school (the Von Lämmel Schule) in Jerusalem. His brilliant volumes *Nach Jerusalem* describing his eastern tour have been translated into English, as is the case with many of his poems. His collected poems appeared in three volumes in 1886. (I. A.)

FRANKLAND, SIR EDWARD (1825-1899), English chemist, was born at Churchtown, near Lancaster, on the 18th of January 1825. After attending the grammar school at Lancaster he spent six years as an apprentice to a druggist in that town. In 1845 he went to London and entered Lyon Playfair's laboratory, subsequently working under R. W. Bunsen at Marburg. In 1847 he was appointed science-master at Queenwood school, Hampshire, where he first met J. Tyndall, and in 1851 first professor of chemistry at Owens College, Manchester. Returning to London six years later he became lecturer in chemistry at St Bartholomew's hospital, and in 1863 professor of chemistry at the Royal Institution. From an early age he engaged in original research with great success.

Analytical problems, such as the isolation of certain organic radicals, attracted his attention to begin with, but he soon turned to synthetical studies, and he was only about twenty-five years of age when an investigation, doubtless suggested by the work of his master, Bunsen, on cacodyl, yielded the interesting discovery of the organo-metallic compounds. The theoretical deductions which he drew from the consideration of these bodies were even more interesting and important than the bodies themselves. Perceiving a molecular isomony between them and the inorganic compounds of the metals from which they may be formed, he saw their true molecular type in the oxygen, sulphur or chlorine compounds of those metals, from which he held them to be derived by the substitution of an organic group for the oxygen, sulphur, &c. In this way they enabled him to overthrow the theory of conjugate compounds, and they further led him in 1853 to publish the conception that the atoms of each elementary substance have a definite saturation capacity, so that they can only combine with a certain limited number of the atoms of other elements. The theory of valency thus founded has dominated the subsequent development of chemical doctrine, and forms the groundwork upon which the fabric of modern structural chemistry reposes.

In applied chemistry Frankland's great work was in connexion with water-supply. Appointed a member of the second royal commission on the pollution of rivers in 1868, he was provided

by the government with a completely-equipped laboratory, in which, for a period of six years, he carried on the inquiries necessary for the purposes of that body, and was thus the means of bringing to light an enormous amount of valuable information respecting the contamination of rivers by sewage, trade-refuse, &c., and the purification of water for domestic use. In 1865, when he succeeded A. W. von Hofmann at the School of Mines, he undertook the duty of making monthly reports to the registrar-general on the character of the water supplied to London, and these he continued down to the end of his life. At one time he was an unsparing critic of its quality, but in later years he became strongly convinced of its general excellence and wholesomeness. His analyses were both chemical and bacteriological, and his dissatisfaction with the processes in vogue for the former at the time of his appointment caused him to spend two years in devising new and more accurate methods. In 1859 he passed a night on the very top of Mont Blanc in company with John Tyndall. One of the purposes of the expedition was to discover whether the rate of combustion of a candle varies with the density of the atmosphere in which it is burnt, a question which was answered in the negative. Other observations made by Frankland at the time formed the starting-point of a series of experiments which yielded far-reaching results. He noticed that at the summit the candle gave a very poor light, and was thereby led to investigate the effect produced on luminous flames by varying the pressure of the atmosphere in which they are burning. He found that pressure increases luminosity, so that hydrogen, for example, the flame of which in normal circumstances gives no light, burns with a luminous flame under a pressure of ten or twenty atmospheres, and the inference he drew was that the presence of solid particles is not the only factor that determines the light-giving power of a flame. Further, he showed that the spectrum of a dense ignited gas resembles that of an incandescent liquid or solid, and he traced a gradual change in the spectrum of an incandescent gas under increasing pressure, the sharp lines observable when it is extremely attenuated broadening out to nebulous bands as the pressure rises, till they merge in the continuous spectrum as the gas approaches a density comparable with that of the liquid state. An application of these results to solar physics in conjunction with Sir Norman Lockyer led to the view that at least the external layers of the sun cannot consist of matter in the liquid or solid forms, but must be composed of gases or vapours. Frankland and Lockyer were also the discoverers of helium. In 1868 they noticed in the solar spectrum a bright yellow line which did not correspond to any substance then known, and which they therefore attributed to the then hypothetical element, helium.

Sir Edward Frankland, who was made a K.C.B. in 1897, died on the 9th of August 1899 while on a holiday at Gollas, Gudbrandsdalen, Norway.

A memorial lecture delivered by Professor H. E. Armstrong before the London Chemical Society on the 31st of October 1901 contained many personal details of Frankland's life, together with a full discussion of his scientific work; and a volume of *Autobiographical Sketches* was printed for private circulation in 1902. His original papers, down to 1877, were collected and published in that year as *Experimental Researches in Pure, Applied and Physical Chemistry*.

FRANKLIN, BENJAMIN (1706-1790), American diplomat, statesman and scientist, was born on the 17th of January 1706 in a house in Milk Street, opposite the Old South church, Boston, Massachusetts. He was the tenth son of Josiah Franklin, and the eighth child and youngest son of ten children borne by Abiah Folger, his father's second wife. The elder Franklin was born at Ecton in Northamptonshire, England, where the strongly Protestant Franklin family may be traced back for nearly four centuries. He had married young and had migrated from Banbury to Boston, Massachusetts, in 1685. Benjamin could not remember when he did not know how to read, and when eight years old he was sent to the Boston grammar school, being destined by his father for the church as a tithing of his sons. He spent a year there and a year in a school for writing and arithmetic, and then at the age of ten he was taken from school

to assist his father in the business of a tallow-chandler and soap-boiler. In his thirteenth year he was apprenticed to his half-brother James, who was establishing himself in the printing business, and who in 1721 started the *New England Courant*, one of the earliest newspapers in America.

Benjamin's tastes had at first been for the sea rather than the pulpit; now they inclined rather to intellectual than to other pleasures. At an early age he had made himself familiar with *The Pilgrim's Progress*, with Locke, *On the Human Understanding*, and with a volume of *The Spectator*. Thanks to his father's excellent advice, he gave up writing doggerel verse (much of which had been printed by his brother and sold on the streets) and turned to prose composition. His success in reproducing articles he had read in *The Spectator* led him to write an article for his brother's paper, which he slipped under the door of the printing shop with no name attached, and which was printed and attracted some attention. After repeated successes of the same sort Benjamin threw off his disguise and contributed regularly to the *Courant*. When, after various journalistic indiscretions, James Franklin in 1722 was forbidden to publish the *Courant*, it appeared with Benjamin's name as that of the publisher and was received with much favour, chiefly because of the cleverness of his articles signed "Dr Janus," which, like those previously signed "Mistress Silence Dogood," gave promise of "Poor Richard." But Benjamin's management of the paper, and particularly his free-thinking, displeased the authorities; the relations of the two brothers gradually grew unfriendly, possibly, as Benjamin thought, because of his brother's jealousy of his superior ability; and Benjamin determined to quit his brother's employ and to leave New England. He made his way first to New York City, and then (October 1723) to Philadelphia, where he got employment with a printer named Samuel Keimer.¹

A rapid composer and a workman full of resource, Franklin was soon recognized as the master spirit of the shop. Sir William Keith (1680-1749), governor of the province, urged him to start in business for himself, and when Franklin had unsuccessfully appealed to his father for the means to do so, Keith promised to furnish him with what he needed for the equipment of a new printing office and sent him to England to buy the materials. Keith had repeatedly promised to send a letter of credit by the ship on which Franklin sailed, but when the Channel was reached and the ship's mails were examined no such letter was found. Franklin reached London in December 1724, and found employment first at Palmer's, a famous printing house in Bartholomew Close, and afterwards at Watts's Printing House. At Palmer's he had set up a second edition of Wollaston's *Religion of Nature Delineated*. To refute this book and to prove that there could be no such thing as religion, he wrote and printed a small pamphlet, *A Dissertation on Liberty and Necessity, Pleasure and Pain*, which brought him some curious acquaintances, and of which he soon became thoroughly ashamed. After a year and a half in London, Franklin was persuaded by a friend named Denham, a Quaker merchant, to return with him to America and engage in mercantile business; he accordingly gave up printing, but a few days before sailing he received a tempting offer to remain and give lessons in swimming—his feats as a swimmer having given him considerable reputation—and he says that he might have consented "had the overtures been sooner made." He reached Philadelphia in October 1726, but a few months later Denham died, and Franklin was induced by large wages to return to his old employer Keimer; with Keimer he quarrelled repeatedly, thinking himself ill used and kept only to train apprentices until they could in some degree take his place.

¹ Keimer and his sister had come the year before from London, where he had learned his trade; both were ardent members of the fanatic band of "French prophets." He proposed founding a new sect with the help of Franklin, who after leaving his shop ridiculed him for his long square beard and for keeping the seventh day. Keimer settled in the Barbadoes about 1730; and in 1731 began to publish at Bridgetown the semi-weekly *Barbadoes Gazette*. Selections from it called *Caribbeana* (1741) and *A Brand Plucked from the Burning*, Exemplified in the Unparalleled Case of Samuel Keimer (1718) are from his pen. He died about 1738.

In 1728 Franklin and Hugh Meredith, a fellow-worker at Keimer's, set up in business for themselves; the capital being furnished by Meredith's father. In 1730 the partnership was dissolved, and Franklin, through the financial assistance of two friends, secured the sole management of the printing house. In September 1729 he bought at a merely nominal price *The Pennsylvania Gazette*, a weekly newspaper which Keimer had started nine months before to defeat a similar project of Franklin's, and which Franklin conducted until 1765. Franklin's superior management of the paper, his new type, "some spirited remarks" on the controversy between the Massachusetts assembly and Governor Burnet, brought his paper into immediate notice, and his success both as a printer and as a journalist was assured and complete. In 1731 he established in Philadelphia one of the earliest circulating libraries in America (often said to have been the earliest), and in 1732 he published the first of his *Almanacks*, under the pseudonym of Richard Saunders. These "Poor Richard's Almanacks" were issued for the next twenty-five years with remarkable success, the annual sale averaging 10,000 copies, and far exceeding the sale of any other publication in the colonies.

Beginning in 1733 Franklin taught himself enough French, Italian, Spanish and Latin to read these languages with some ease. In 1736 he was chosen clerk of the General Assembly, and served in this capacity until 1751. In 1737 he had been appointed postmaster at Philadelphia, and about the same time he organized the first police force and fire company in the colonies; in 1749, after he had written *Proposals Relating to the Education of Youth in Pennsylvania*, he and twenty-three other citizens of Philadelphia formed themselves into an association for the purpose of establishing an academy, which was opened in 1751, was chartered in 1753, and eventually became the University of Pennsylvania; in 1727 he organized a debating club, the "Jaunto," in Philadelphia, and later he was one of the founders of the American Philosophical Society (1743; incorporated 1780); he took the lead in the organization of a militia force, and in the paving of the city streets, improved the method of street lighting, and assisted in the founding of a city hospital (1751); in brief, he gave the impulse to nearly every measure or project for the welfare and prosperity of Philadelphia undertaken in his day. In 1751 he became a member of the General Assembly of Pennsylvania, in which he served for thirteen years. In 1753 he and William Hunter were put in charge of the post service of the colonies, which he brought in the next ten years to a high state of efficiency and made a financial success; this position he held until 1774. He visited nearly every post office in the colonies and increased the mail service between New York and Philadelphia from once to three times a week in summer, and from twice a month to once a week in winter. When war with France appeared imminent in 1754, Franklin was sent to the Albany Convention, where he submitted his plan for colonial union (see ALBANY, N.Y.). When the home government sent over General Edward Braddock¹ with two regiments of British troops, Franklin undertook to secure the requisite number of horses and waggons for the march against Ft. Duquesne, and became personally responsible for payment to the Pennsylvanians who furnished them. Notwithstanding the alarm occasioned by Braddock's defeat, the old quarrel between the proprietors of Pennsylvania and the assembly prevented any adequate preparations for defence; "with incredible meanness" the proprietors had instructed their governors to approve no act for levying the necessary taxes, unless the vast estates of the proprietors were by the same act exempted. So great was the confidence in Franklin in this emergency that early in 1756 the governor of Pennsylvania placed him in charge of the north-western frontier of the province, with power to raise troops, issue commissions and erect blockhouses; and Franklin remained in the wilderness for over a month, superintending the building

of forts and watching the Indians. In February 1757 the assembly, "finding the proprietary obstinately persisted in manacling their deputies with instructions inconsistent not only with the privileges of the people, but with the service of the crown, resolv'd to petition the king against them," and appointed Franklin as their agent to present the petition. He arrived in London on the 27th of July 1757, and shortly afterwards, when, at a conference with Earl Granville, president of the council, the latter declared that "the King is the legislator of the colonies," Franklin in reply declared that the laws of the colonies were to be made by their assemblies, to be passed upon by the king, and when once approved were no longer subject to repeal or amendment by the crown. As the assemblies, said he, could not make permanent laws without the king's consent, "neither could he make a law for them without theirs." This opposition of views distinctly raised the issue between the home government and the colonies. As to the proprietors Franklin succeeded in 1760 in securing an understanding that the assembly should pass an act exempting from taxation the *unsurveyed* waste lands of the Penn estate, the surveyed waste lands being assessed at the usual rate for other property of that description. Thus the proprietors finally acknowledged the right of the assembly to tax their estates.

The success of Franklin's first foreign mission was, therefore, substantial and satisfactory. During this sojourn of five years in England he had made many valuable friends outside of court and political circles, among whom Hume, Robertson and Adam Smith were conspicuous. In 1759, for his literary and more particularly his scientific attainments, he received the freedom of the city of Edinburgh and the degree of doctor of laws from the university of St Andrews. He had been made a Master of Arts at Harvard and at Yale in 1753, and at the college of William and Mary in 1756; and in 1762 he received the degree of D.C.L. at Oxford. While in England he had made active use of his remarkable talent for pamphleteering. In the clamour for peace following the death of George II. (25th of October 1760), he was for a vigorous prosecution of the war with France; he had written what purported to be a chapter from an old book written by a Spanish Jesuit, *On the Means of Disposing the Enemies to Peace*, which had a great effect; and in the spring of 1760 there had been published a more elaborate paper written by Franklin with the assistance of Richard Jackson, agent of Massachusetts and Connecticut in London, entitled *The Interest of Great Britain Considered with Regard to Her Colonies, and the Acquisitions of Canada and Guadeloupe* (1760). This pamphlet answered the argument that it would be unsafe to keep Canada because of the added strength that would thus be given to any possible movement for independence in the English colonies, by urging that so long as Canada remained French there could be no safety for the English colonies in North America, nor any permanent peace in Europe. Tradition reports that this pamphlet had considerable weight in determining the ministry to retain Canada.

Franklin sailed again for America in August 1762, hoping to be able to settle down in quiet and devote the remainder of his life to experiments in physics. This quiet was interrupted, however, by the "Paxton Massacre" (Dec. 14, 1763)—the slaughter of a score of Indians (children, women and old men) at Lancaster, Pennsylvania, by some young rowdies from the town of Paxton, who then marched upon Philadelphia to kill a few Christian Indians there. Franklin, appealed to by the governor, raised a troop sufficient to frighten away the "Paxton boys," and for the moment there seemed a possibility of an understanding between Franklin and the proprietors. But the question of taxing the estates of the proprietors came up in a new form, and a petition from the assembly was drawn by Franklin, requesting the king "to resume the government" of Pennsylvania. In the autumn election of 1764 the influence of the proprietors was exerted against Franklin, and by an adverse majority of 25 votes in 4000 he failed to be re-elected to the assembly. The new assembly sent Franklin again to England as its special agent to take charge of another petition for a change

¹ The meeting between Franklin, the type of the shrewd, cool provincial, and Braddock, a blustering, blundering, drinking British soldier, is dramatically portrayed by Thackeray in the 9th chapter of *The Virginians*.

of government, which, however, came to nothing. Matters of much greater consequence soon demanded Franklin's attention.

Early in 1764 Lord Grenville had informed the London agents of the American colonies that he proposed to lay a portion of the burden left by the war with France upon the shoulders of the colonists by means of a stamp duty, unless some other tax equally productive and less inconvenient were proposed. The natural objection of the colonies, as voiced, for example, by the assembly of Pennsylvania, was that it was a cruel thing to tax colonies already taxed beyond their strength, and surrounded by enemies and exposed to constant expenditures for defence, and that it was an indignity that they should be taxed by a parliament in which they were not represented; at the same time the Pennsylvania assembly recognized it as "their duty to grant aid to the crown, according to their abilities, whenever required of them in the usual manner." To prevent the introduction of the Stamp Act, which he characterized as "the mother of mischief," Franklin used every effort, but the bill was easily passed, and it was thought that the colonists would soon be reconciled to it. Because he, too, thought so, and because he recommended John Hughes, a merchant of Philadelphia, for the office of distributor of stamps, Franklin himself was denounced—he was even accused of having planned the Stamp Act—and his family in Philadelphia was in danger of being mobbed. Of Franklin's examination, in February 1766, by the House in Committee of the Whole, as to the effects of the Stamp Act, Burke said that the scene reminded him of a master examined by a parcel of schoolboys, and George Whitefield said: "Dr Franklin has gained immortal honour by his behaviour at the bar of the House. His answer was always found equal to the questioner. He stood unappalled, gave pleasure to his friends and did honour to his country."¹ Franklin compared the position of the colonies to that of Scotland in the days before the union, and in the same year (1766) audaciously urged a similar union with the colonies before it was too late. The knowledge of colonial affairs gained from Franklin's testimony, probably more than all other causes combined, determined the immediate repeal of the Stamp Act. For Franklin this was a great triumph, and the news of it filled the colonists with delight and restored him to their confidence and affection. Another bill (the Declaratory Act), however, was almost immediately passed by the king's party, asserting absolute supremacy of parliament over the colonies, and in the succeeding parliament, by the Townshend Acts of 1767, duties were imposed on paper, paints and glass imported by the colonists; a tax was imposed on tea also. The imposition of these taxes was bitterly resented in the colonies, where it quickly crystallized public opinion round the principle of "No taxation without representation." In spite of the opposition in the colonies to the Declaratory Act, the Townshend Acts and the tea tax, Franklin continued to assure the British ministry and the British public of the loyalty of the colonists. He tried to find some middle ground of reconciliation, and kept up his quiet work of informing England as to the opinions and conditions of the colonies, and of moderating the attitude of the colonies toward the home government; so that, as he said, he was accused in America of being too much an Englishman, and in England of being too much an American. He was agent now, not only of Pennsylvania, but also of New Jersey, of Georgia and of Massachusetts. Hillsborough, who became secretary of state for the colonies in 1768, refused to recognize Franklin as agent of Massachusetts, because the governor of Massachusetts had not approved the appointment, which was by resolution of the assembly. Franklin contended that the governor, as a mere agent of the king, could have nothing to do with the assembly's appointment of its agent to the king; that "the King, and not the King, Lords, and Commons collectively, is their sovereign; and that the King, with *their* respective Parliaments, is their only legislator." Franklin's influence helped to oust Hillsborough, and Dartmouth, whose name Franklin suggested, was made

¹ Many questions (about 20 of the first 25) were put by his friends to draw out what he wished to be known.

secretary in 1772 and promptly recognized Franklin as the agent of Massachusetts.

In 1773 there appeared in the *Public Advertiser* one of Franklin's cleverest hoaxes, "An Edict of the King of Prussia," proclaiming that the island of Britain was a colony of Prussia, having been settled by Angles and Saxons, having been protected by Prussia, having been defended by Prussia against France in the war just past, and never having been definitely freed from Prussia's rule; and that, therefore, Great Britain should now submit to certain taxes laid by Prussia—the taxes being identical with those laid upon the American colonies by Great Britain. In the same year occurred the famous episode of the Hutchinson Letters. These were written by Thomas Hutchinson, Governor of Massachusetts, Andrew Oliver (1706–1774), his lieutenant-governor, and others to William Whately, a member of Parliament, and private secretary to George Grenville, suggesting an increase of the power of the governor at the expense of the assembly, "an abridgement of what are called English liberties," and other measures more extreme than those undertaken by the government. The correspondence was shown to Franklin by a mysterious "member of parliament" to back up the contention that the quartering of troops in Boston was suggested, not by the British ministry, but by Americans and Bostonians. Upon his promise not to publish the letters Franklin received permission to send them to Massachusetts, where they were much passed about and were printed, and they were soon republished in English newspapers. The Massachusetts assembly on receiving the letters resolved to petition the crown for the removal of both Hutchinson and Oliver. The petition was refused and was condemned as scandalous, and Franklin, who took upon himself the responsibility for the publication of the letters, in the hearing before the privy council at the Cockpit on the 29th of January 1774 was insulted and was called a thief by Alexander Wedderburn (the solicitor-general, who appeared for Hutchinson and Oliver), and was removed from his position as head of the post office in the American colonies.

Satisfied that his usefulness in England was at an end, Franklin entrusted his agencies to the care of Arthur Lee, and on the 21st of March 1775 again set sail for Philadelphia. During the last years of his stay in England there had been repeated attempts to win him (probably with an under-secretaryship) to the British service, and in these same years he had done a great work for the colonies by gaining friends for them among the opposition, and by impressing France with his ability and the excellence of his case. Upon reaching America, he heard of the fighting at Lexington and Concord, and with the news of an actual outbreak of hostilities his feeling toward England seems to have changed completely. He was no longer a peacemaker, but an ardent war-maker. On the 6th of May, the day after his arrival in Philadelphia, he was elected by the assembly of Pennsylvania a delegate to the Continental Congress in Philadelphia. In October he was elected a member of the Pennsylvania assembly, but, as members of this body were still required to take an oath of allegiance to the crown, he refused to serve. In the Congress he served on as many as ten committees, and upon the organization of a continental postal system, he was made postmaster-general, a position he held for one year, when (in 1776) he was succeeded by his son-in-law, Richard Bache, who had been his deputy. With Benjamin Harrison, John Dickinson, Thomas Johnson and John Jay he was appointed in November 1775 to a committee to carry on a secret correspondence with the friends of America "in Great Britain, Ireland and other parts of the world." He planned an appeal to the king of France for aid, and wrote the instructions of Silas Deane who was to convey it. In April 1776 he went to Montreal with Charles Carroll, Samuel Chase and John Carroll, as a member of the commission which conferred with General Arnold, and attempted without success to gain the co-operation of Canada. Immediately after his return from Montreal he was a member of the committee of five appointed to draw up the Declaration of Independence, but he took no actual part himself in drafting that instrument, aside from suggesting the change or insertion of a few

words in Jefferson's draft. From July 16 to September 28 he acted as president of the Constitutional Convention of Pennsylvania.

With John Adams and Edward Rutledge he was selected by Congress to discuss with Admiral Howe (September 1776, at Staten Island) the terms of peace proposed by Howe, who had arrived in New York harbour in July 1776, and who had been an intimate friend of Franklin; but the discussion was fruitless, as the American commissioners refused to treat "back of this step of independency." On the 26th of September in the same year Franklin was chosen as commissioner to France to join Arthur Lee, who was in London, and Silas Deane, who had arrived in France in June 1776. He collected all the money he could command, between £3000 and £4000, lent it to Congress before he set sail, and arrived at Paris on the 22nd of December. He found quarters at Passy,¹ then a suburb of Paris, in a house belonging to Le Ray de Chaumont, an active friend of the American cause, who had influential relations with the court, and through whom he was enabled to be in the fullest communication with the French government without compromising it in the eyes of Great Britain.

At the time of Franklin's arrival in Paris he was already one of the most talked about men in the world. He was a member of every important learned society in Europe; he was a member, and one of the managers, of the Royal Society, and was one of eight foreign members of the Royal Academy of Sciences in Paris. Three editions of his scientific works had already appeared in Paris, and a new edition had recently appeared in London. To all these advantages he added a political purpose—the dismemberment of the British empire—which was entirely congenial to every citizen of France. "Franklin's reputation," wrote John Adams with characteristic extravagance, "was more universal than that of Leibnitz or Newton, Frederick or Veltaire; and his character more esteemed and beloved than all of them. . . . If a collection could be made of all the gazettes of Europe, for the latter half of the 18th century, a greater number of panegyric paragraphs upon *le grand Franklin* would appear, it is believed, than upon any other man that ever lived." "Franklin's appearance in the French salons, even before he began to negotiate," says Friedrich Christoph Schlosser, "was an event of great importance to the whole of Europe. . . . His dress, the simplicity of his external appearance, the friendly meekness of the old man, and the apparent humility of the Quaker, procured for Freedom a mass of votaries among the court circles who used to be alarmed at its coarseness and unsophisticated truths. Such was the number of portraits,² busts and medallions of him in circulation before he left Paris that he would have been recognized from them by any adult citizen in any part of the civilized world."

Franklin's position in France was a difficult one from the start, because of the delicacy of the task of getting French aid at a time when France was unready openly to take sides against Great Britain. But on the 6th of February 1778, after the news of the defeat and surrender of Burgoyne had reached Europe, a treaty of alliance and a treaty of amity and commerce between France and the United States were signed at Paris by Franklin, Deane and Lee. On the 28th of October this commission was discharged and Franklin was appointed sole plenipotentiary to the French court. Lee, from the beginning of the mission to Paris, seems to have been possessed of a mania of jealousy toward Franklin, or of misunderstanding of his acts, and he tried to undermine his influence with the Continental Congress. John Adams, when he succeeded Deane (recalled from Paris through Lee's machinations) joined in the chorus of fault-finding against Franklin, dilated upon his social habits, his personal slothfulness and his complete lack of business-like system; but Adams soon came to see that, although careless of details, Franklin was doing what no other man could have

done, and he ceased his harsher criticism. Even greater than his diplomatic difficulties were Franklin's financial straits. Drafts were being drawn on him by all the American agents in Europe, and by the Continental Congress at home. Acting as American naval agent for the many successful privateers who harried the English Channel, and for whom he skillfully got every bit of assistance possible, open and covert, from the French government, he was continually called upon for funds in these ventures. Of the vessels to be sent to Paris with American cargoes which were to be sold for the liquidation of French loans to the colonies made through Beaumarchais, few arrived; those that did come did not cover Beaumarchais's advances, and hardly a vessel came from America without word of fresh drafts on Franklin. After bold and repeated overtures for an exchange of prisoners—an important matter, both because the American frigates had no place in which to stow away their prisoners, and because of the maltreatment of American captives in such prisons as Dartmoor—exchanges began at the end of March 1779, although there were annoying delays, and immediately after November 1781 there was a long break in the agreement; and the Americans discharged from English prisons were constantly in need of money. Franklin, besides, was constantly called upon to meet the indebtedness of Lee and of Ralph Izard (1742-1804), and of John Jay, who in Madrid was being drawn on by the American Congress. In spite of the poor condition in Europe of the credit of the struggling colonies, and of the fact that France was almost bankrupt (and in the later years was at war), and although Necker strenuously resisted the making of any loans to the colonies, France, largely because of Franklin's appeals, expended, by loan or gift to the colonies, or in sustenance of the French arms in America, a sum estimated at \$60,000,000.

In 1781 Franklin, with John Adams, John Jay, Jefferson, who remained in America, and Henry Laurens, then a prisoner in England, was appointed on a commission to make peace with Great Britain. In the spring of 1782 Franklin had been informally negotiating with Shelburne, secretary of state for the home department, through the medium of Richard Oswald, a Scotch merchant, and had suggested that England should cede Canada to the United States in return for the recognition of loyalist claims by the states. When the formal negotiations began Franklin held closely to the instructions of Congress to its commissioners, that they should maintain confidential relations with the French ministers and that they were "to undertake nothing in the negotiations for peace or truce without their knowledge and concurrence," and were ultimately to be governed by "their advice and opinion." Jay and Adams disagreed with him on this point, believing that France intended to curtail the territorial aspirations of the Americans for her own benefit and for that of her ally, Spain. At last, after the British government had authorized its agents to treat with the commissioners as representatives of an independent power, thus recognizing American independence before the treaty was made, Franklin acquiesced in the policy of Jay. The preliminary treaty was signed by the commissioners on the 30th of November 1782, the final treaty on the 3rd of September 1783. Franklin had repeatedly petitioned Congress for his recall, but his letters were unanswered or his appeals refused until the 7th of March 1785, when Congress resolved that he be allowed to return to America; on the 10th of March Thomas Jefferson, who had joined him in August of the year before, was appointed to his place. Jefferson, when asked if he replaced Franklin, replied, "No one can replace him, sir; I am only his successor." Before Franklin left Paris on the 12th of July 1785 he had made commercial treaties with Sweden (1783) and Prussia (1785; signed after Franklin's departure by Jefferson and John Adams). Franklin arrived in Philadelphia on the 13th of September, disembarking at the same wharf as when he had first entered the city. He was immediately elected a member of the municipal council of Philadelphia, becoming its chairman; and was chosen president of the Supreme Executive Council (the chief executive officer) of Pennsylvania, and was re-elected in 1786 and 1787,

¹ The house is familiar from the drawing of it by Victor Hugo.

² Many of these portraits bore inscriptions, the most famous of which was Turgot's line, "Eripuit fulmen coelo sceptrumque tyranniam."

serving from October 1785 to October 1788. In May 1787 he was elected a delegate to the Convention which drew up the Federal Constitution, this body thus having a member upon whom all could agree as chairman, should Washington be absent. He opposed over-centralization of government and favoured the Connecticut Compromise, and after the work of the Convention was done used his influence to secure the adoption of the Constitution.¹ As president of the Pennsylvania Society for Promoting the Abolition of Slavery, Franklin signed a petition to Congress (12th February 1790) for immediate abolition of slavery, and six weeks later in his most brilliant manner parodied the attack on the petition made by James Jackson (1757-1806) of Georgia, taking off Jackson's quotations of Scripture with pretended texts from the Koran cited by a member of the Divan of Algiers in opposition to a petition asking for the prohibition of holding Christians in slavery. These were his last public acts. His last days were marked by a fine serenity and calm; he died in his own house in Philadelphia on the 17th of April 1790, the immediate cause being an abscess in the lungs. He was buried with his wife in the graveyard (Fifth and Arch Streets) of Christ Church, Philadelphia.

Physically Franklin was large, about 5 ft. 10 in. tall, with a well-rounded, powerful figure; he inherited an excellent constitution from his parents—"I never knew," says he, "either my father or mother to have any sickness but that of which they dy'd, he at 89, and she at 85 years of age"—but injured it somewhat by excesses; in early life he had severe attacks of pleurisy, from one of which, in 1727, it was not expected that he would recover, and in his later years he was the victim of stone and gout. When he was sixteen he became a vegetarian for a time, rather to save money for books than for any other reason, and he always preached moderation in eating, though he was less consistent in his practice in this particular than as regards moderate drinking. He was always enthusiastically fond of swimming, and was a great believer in fresh air, taking a cold air bath regularly in the morning, when he sat naked in his bedroom beguiling himself with a book or with writing for a half-hour or more. He insisted that fresh, cold air was not the cause of colds, and preached zealously the "gospel of ventilation." He was a charming talker, with a gay humour and a quiet sarcasm and a telling use of anecdote for argument. Henri Martin, the French historian, speaks of him as "of a mind altogether French in its grace and elasticity." In 1730 he married Deborah Read, in whose father's house he had lived when he had first come to Philadelphia, to whom he had been engaged before his first departure from Philadelphia for London, and who in his absence had married a ne'er-do-well, one Rogers, who had deserted her. The marriage to Franklin is presumed to have been a common law marriage, for there was no proof that Miss Read's former husband was dead, nor that, as was suspected, a former wife, alive when Rogers married Miss Read, was still alive, and that therefore his marriage to Deborah was void. His "Debby," or his "dear child," as Franklin usually addressed her in his letters, received into the family, soon after her marriage, Franklin's illegitimate son, William Franklin (1729-1813),² with whom she afterwards quarrelled, and whose mother, tradition says, was Barbara, a servant in the Franklin household. Another illegitimate child became the wife of John Foxcroft of Philadelphia. Deborah, who was "as much dispos'd to industry and frugality as" her husband, was illiterate and shared none of her husband's tastes for literature and science;

¹ Notably in a pamphlet comparing the Jews and the Anti-Federalists.

² William Franklin served on the Canadian frontier with Pennsylvania troops, becoming captain in 1750; was in the post-office in 1754-1756; went to England with his father in 1758; was admitted to legal practice in 1758; in 1763, recommended by Lord Fairfax, became governor of New Jersey; he left the Whig for the Tory party; and in the War of Independence was a faithful loyalist, much to the pain and regret of his father, who, however, was reconciled to him in part in 1784. He was held as a prisoner from 1776 until exchanged in 1778; and lived four years in New York, and during the remainder of his life in England with an annual pension of £800 from the crown.

her dread of an ocean voyage kept her in Philadelphia during Franklin's missions to England, and she died in 1774, while Franklin was in London. She bore him two children, one a son, Francis Folger, "whom I have seldom since seen equal'd in everything, and whom to this day [thirty-six years after the child's death] I cannot think of without a sigh," who died (1736) when four years old of small-pox, not having been inoculated; the other was Sarah (1744-1808), who married Richard Bache (1737-1811), Franklin's successor in 1776-1782 as postmaster-general. Franklin's gallant relations with women after his wife's death were probably innocent enough. Best known of his French *amies* were Mme Helvétius, widow of the philosopher, and the young Mme Brillou, who corrected her "Papa's" French and tried to bring him safely into the Roman Catholic Church. With him in France were his grandsons, William Temple Franklin, William Franklin's natural son, who acted as private secretary to his grandfather, and Benjamin Franklin Bache (1769-1798), Sarah's son, whom he sent to Geneva to be educated, for whom he later asked public office of Washington, and who became editor of the *Aurora*, one of the leading journals in the Republican attacks on Washington.

Franklin early rebelled against New England Puritanism and spent his Sundays in reading and in study instead of attending church. His free-thinking ran its extreme course at the time of his publication in London of *A Dissertation on Liberty and Necessity, Pleasure and Pain* (1725), which he recognized as one of the great *errata* of his life. He later called himself a deist, or theist, not discriminating between the terms. To his favourite sister he wrote: "There are some things in your New England doctrine and worship which I do not agree with; but I do not therefore condemn them, or desire to shake your belief or practice of them." Such was his general attitude. He did not believe in the divinity of Christ, but thought "his system of morals and his religion, as he left them to us, the best the world ever saw, or is like to see." His intense practical-mindedness drew him away from religion, but drove him to a morality of his own (the "art of virtue," he called it), based on thirteen virtues each accompanied by a short precept; the virtues were Temperance, Silence, Order, Resolution, Frugality, Industry, Sincerity, Justice, Moderation, Cleanliness, Tranquility, Chastity and Humility, the precept accompanying the last-named virtue being "Imitate Jesus and Socrates." He made a business-like little notebook, ruled off spaces for the thirteen virtues and the seven days of the week, "determined to give a week's strict attention to each of the virtues successively . . . [going] thro' a course complete in thirteen weeks and four courses in a year," marking for each day a record of his adherence to each of the precepts. "And conceiving God to be the fountain of wisdom," he "thought it right and necessary to solicit His assistance for obtaining it," and drew up the following prayer for daily use: "O powerful Goodness! bountiful Father! merciful Guide! Increase in me that wisdom which discovers my truest interest. Strengthen my resolution to perform what that wisdom dictates. Accept my kind offices to Thy other children, as the only return in my power for Thy continual favours to me." He was by no means prone to overmuch introspection, his great interest in the conduct of others being shown in the wise maxims of Poor Richard, which were possibly too utilitarian but were wonderfully successful in instructing American morals. His *Art of Virtue* on which he worked for years was never completed or published in any form.

"Benjamin Franklin, Printer," was Franklin's own favourite description of himself. He was an excellent compositor and pressman; his workmanship, clear impressions, black ink and comparative freedom from errata did much to get him the public printing in Pennsylvania and New Jersey, and the printing of the paper money³ and other public matters in Delaware. The first book with his imprint is *The Psalms of David Imitated in*

³ For the prevention of counterfeiting continental paper money Franklin long afterwards suggested the use on the different denominations of different leaves, having noted the infinite variety of leaf venation.

the Language of the New Testament and apply'd to the Christian State and Worship. By I. Watts . . . Philadelphia: Printed by B. F. and H. M. for Thomas Godfrey, and Sold at his Shop, 1729. The first novel printed in America was Franklin's reprint in 1744 of *Pamela*; and the first American translation from the classics which was printed in America was a version by James Logan (1674-1751) of Cato's *Moral Distichs* (1735). In 1744 he published another translation of Logan's, *Cicero On Old Age*, which Franklin thought typographically the finest book he had ever printed. In 1733 he had established a press in Charleston, South Carolina, and soon after did the same in Lancaster, Pa., in New Haven, Conn., in New York, in Antigua, in Kingston, Jamaica, and in other places. Personally he had little connexion with the Philadelphia printing office after 1748, when David Hall became his partner and took charge of it. But in 1753 he was eagerly engaged in having several of his improvements incorporated in a new press, and more than twenty years after was actively interested in John Walter's scheme of "logography." In France he had a private press in his house in Passy, on which he printed "bagatelles." Franklin's work as a publisher is for the most part closely connected with his work in issuing the *Gazette* and *Poor Richard's Almanack* (a summary of the proverbs from which appeared in the number for 1758, and has often been reprinted—under such titles as *Father Abraham's Speech*, and *The Way to Wealth*).¹

Of much of Franklin's work as an author something has already been said. Judged as literature, the first place belongs to his *Autobiography*, which unquestionably ranks among the few great autobiographies ever written. His style in its simplicity, facility and clearness owed something to De Foe, something to Cotton Mather, something to Plutarch, more to Bunyan and to his early attempts to reproduce the manner of the third volume of the *Spectator*; and not the least to his own careful study of word usage. From Xenophon's *Memorabilia* he learned when a boy the Socratic method of argument. Swift he resembled in the occasional broadness of his humour, in his brilliantly successful use of sarcasm and irony,² and in his mastery of the hoax. Balzac said of him that he "invented the lightning-rod, the hoax ('le canard') and the republic." Among his more famous hoaxes were the "Edict of the King of Prussia" (1773), already described; the fictitious supplement to the *Boston Chronicle*, printed on his private press at Passy in 1762, and containing a letter with an invoice of eight packs of 954 cured, dried, hooped and painted scalps of rebels, men, women and children, taken by Indians in the British employ; and another fictitious *Letter from the Count de Schaunberg to the Baron Elohendorf commanding the Hessian Troops in America* (1777)—the count's only anxiety is that not enough men will be killed to bring him in moneys he needs, and he urges his officer in command in America "to prolong the war . . . for I have made arrangements for a grand Italian opera, and I do not wish to be obliged to give it up."³

Closely related to Franklin's political pamphlets are his writings on economics, which, though undertaken with a political

¹ Seventy-five editions of it have been printed in English, fifty-six in French, eleven in German and nine in Italian. It has been translated into Spanish, Danish, Swedish, Welsh, Polish, Gaelic, Russian, Bohemian, Dutch, Catalan, Chinese, modern Greek and phonetic writing. It has been printed at least four hundred times, and is to-day as popular as ever.—P. L. Ford, in *The Many-Sided Franklin* (1899).

² Both Swift and Franklin made sport of the typical astrologer almanack-maker.

³ Another hoax was Franklin's parable against religious persecution thrown into Scriptural form and quoted by him as the fifty-first chapter of Genesis. In a paper on a "Proposed New Version of the Bible" he paraphrased a few verses of the first chapter of Job, making them a satiric attack on royal government; but the version was well rank with these hoaxes, and even modern writers have been taken in by it, regarding it as a serious proposal for a "modernized" version and decrying it as poor taste. Matthew Arnold, for example, declared this an instance in which Franklin was lacking in his "imperturbable common sense"; and J. B. McMaster, though devoting several pages to its discussion, very ingeniously declares it "beneath criticism."

or practical purpose and not in a purely scientific spirit, rank him as the first American economist. He wrote in 1729 *A Modest Enquiry into the Nature and Necessity of a Paper Currency*, which argued that a plentiful currency will make rates of interest low and will promote immigration and home manufactures, and which did much to secure the further issue of paper money in Pennsylvania. After the British Act of 1750 forbidding the erection or the operating of iron or steel mills in the colonies, Franklin wrote *Observations concerning the Increase of Mankind and the Peopling of Countries* (1751); its thesis was that manufactures come to be common only with a high degree of social development and with great density of population, and that Great Britain need not, therefore, fear the industrial competition of the colonies, but it is better known for the estimate (adopted by Adam Smith) that the population of the colonies would double every quarter-century; and for the likeness to Malthus's⁴ "preventive check" of its statement: "The greater the common fashionable expense of any rank of people the more cautious they are of marriage." His *Positions to be examined concerning National Wealth* (1760) shows that he was greatly influenced by the French physiocrats after his visit to France in 1767. His *Wail of a Protected Manufacturer* voices a protest against protection as raising the cost of living; and he held that free trade was based on a natural right. He knew Kames, Hume and Adam Smith, and corresponded with Mirabeau, "the friend of Man." Some of the more important of his economic theses, as summarized by W. A. Wetzel, are: that money as coin may have more than its bullion value; that natural interest is determined by the rent of land valued at the sum of money loaned—an anticipation of Turgot; that high wages are not inconsistent with a large foreign trade; that the value of an article is determined by the amount of labour necessary to produce the food consumed in making the article; that manufactures are advantageous but agriculture only is truly productive; and that when practicable (as he did not think it practicable at the end of the War of Independence) state revenue should be raised by direct tax.

Franklin as a scientist⁵ and as an inventor has been decried by experts as an amateur and a dabbler; but it should be remembered that it was always his hope to retire from public life and devote himself to science. In the American Philosophical Society (founded 1743) scientific subjects were much discussed. Franklin wrote a paper on the causes of earthquakes for his *Gazette* of the 15th of December 1737; and he eagerly collected material to uphold his theory that waterspouts and whirlwinds resulted from the same causes. In 1743, from the circumstance that an eclipse not visible in Philadelphia because of a storm had been observed in Boston, where the storm although north-easterly did not occur until an hour after the eclipse, he surmised that storms move *against* the wind along the Atlantic coast. In the year before (1742) he had planned the "Pennsylvania fire-place," better known as the "Franklin stove," which saved fuel, heated all the room, and had the same principle as the hot-air furnace; the stove was never patented by Franklin, but was described in his pamphlet dated 1744. He was much engaged at the same time in remedying smoking chimneys, and as late as 1785 wrote to Jan Ingenhousz, physician to the emperor of Austria, on chimneys and draughts; smoking street lamps he remedied by a simple contrivance. The study of electricity he took up in 1746 when he first saw a Leyden jar, in the manipulation of which he became expert and which he improved by the use of granulated lead in the place of water for the interior armatures; he recognized that condensation is due to the dielectric and not to the metal coatings. A note in his diary, dated the 7th of November 1749, shows that he had then

⁴ Malthus quoted Franklin in his first edition, but it was not until the second that he introduced the theory of the "preventive check." Franklin noted the phenomenon with disapproval in his advocacy of increased population; Malthus with approval in his search for means to decrease population.

⁵ The title of philosopher as used in Franklin's lifetime referred neither in England nor in France to him as author of moral maxims, but to him as a scientist—a "natural philosopher."

conjectured that thunder and lightning were electrical manifestations; in the same year he planned the lightning-rod (long known as "Franklin's rod"), which he described and recommended to the public in 1753, when the Copley medal of the Royal Society was awarded him for his discoveries. The famous experiment with the kite, proving lightning an electrical phenomenon, was performed by Franklin in June 1752. He overthrew entirely the "friction" theory of electricity and conceived the idea of plus and minus charges (1753); he thought the sea the source of electricity. On light Franklin wrote to David Rittenhouse in June 1784; the sum of his own conjectures was that the corpuscular theory of Newton was wrong, and that light was due to the vibration of an elastic aether. He studied with some care the temperature of the Gulf Stream. In navigation he suggested many new contrivances, such as water-tight compartments, floating anchors to lay a ship to in a storm, and dishes that would not upset during a gale; and beginning in 1757 made repeated experiments with oil on stormy waters. As a mathematician he devised various elaborate magic squares and novel magic circles, of which he speaks apologetically, because they are of no practical use. Always much interested in agriculture, he made an especial effort (like Robert R. Livingston) to promote the use of plaster of Paris as a fertiliser. He took a prominent part in aeronautic experiments during his stay in France. He made an excellent clock, which because of a slight improvement introduced by James Ferguson in 1757 was long known as Ferguson's clock. In medicine Franklin was considered important enough to be elected to the Royal Medical Society of Paris in 1777, and an honorary member of the Medical Society of London in 1787. In 1784 he was on the committee which investigated Mesmer, and the report is a document of lasting scientific value. Franklin's advocacy of vegetarianism, of sparing and simple diet, and of temperance in the use of liquors, and of proper ventilation has already been referred to. His most direct contribution to medicine was the invention for his own use of bifocal eyeglasses.

A summary of so versatile a genius is impossible. His services to America in England and France rank him as one of the heroes of the American War of Independence and as the greatest of American diplomats. Almost the only American scientist of his day, he displayed remarkably deep as well as remarkably varied abilities in science and deserved the honours enthusiastically given him by the savants of Europe.

BIBLIOGRAPHY.—Franklin's works were not collected in his own lifetime, and he made no effort to publish his writings. *Experiments and Observations on Electricity* (London, 1769) was translated into French by Barbeau Dubourg (Paris, 1773); Vaughan attempted a more complete edition, *Political, Miscellaneous and Philosophical Pieces* (London, 1779); an edition in three volumes appeared after Franklin's death (London, 1806); what seemed the authentic *Works*, as it was under the care of Temple Franklin, was published at London (6 vols., 1817-1819; 3 vols., 1818) and with some additional matter at Philadelphia (6 vols., 1818). Sparks's edition (10 vols., Boston, 1836-1842; revised, Philadelphia, 1858) also contained fresh matter; and there are further additions in the edition of John Bigelow (Philadelphia, 1857-1888; 5th ed., 1905) and in that by Albert Henry Smyth (10 vols., New York, 1905-1907). There are important Frankliniana, about 13,000 papers, in the possession of the American Philosophical Society, to which they were conveyed by the son of Temple Franklin's executor, George Fox. Other papers which had been left to Fox lay for years in barrels in a stable garret; they were finally cleared out by their owner, Mary Fox, intending to send them to a paper mill. One barrel went to the mill. The others, it was found, contained papers belonging to Franklin, and this important collection was bought and presented to the university of Pennsylvania. The valuable Frankliniana collected by Henry Stevens were purchased by Congress in 1885. These MS. collections were first carefully gone over for the edition of the *Works* by A. H. Smyth. Franklin's *Autobiography* was begun in 1771 as a private chronicle for his son, Governor William Franklin; the papers, bringing the story of his father's life down to 1730, were lost by the governor during the War of Independence, and in 1783 came into the possession of Abel James, who restored them to Franklin and urged him to complete the sketch. He wrote a little in 1784, more in 1788, when he furnished a copy to his friend Le Veillard, and a little more in 1790. The original manuscript was long in the possession of Temple Franklin, who spent years rearranging the matter in it and making over into polished English his grandfather's plain-spokenness. So long was the publication delayed that it was generally believed

that Temple Franklin had sold all the papers to the British government; a French version, *Mémoires de la vie privée* (Paris, 1791), was retranslated into English twice in 1793 (London), and from one of these versions (by Robinson) still another French version was made (Paris, 1798). Temple Franklin, deciding to print, got from Le Veillard the copy sent to him in 1788 (sending in return the original with autograph alterations and the final addition), and from the copy published (London, 1817) an edition supposed to be authentic and complete. The complete autograph of the biography, acquired by John Bigelow in 1867 from its French owners, upon collation with Temple Franklin's edition showed that the latter contained 1200 emendations and that it omitted entirely what had been written in 1790. Bigelow published the complete *Autobiography* with additions from Franklin's correspondence and other writings in 1868; a second edition (3 vols., Philadelphia, 1888) was published under the title, *The Life of Benjamin Franklin, Written by Himself*. In addition to the *Autobiography* see James Parton, *Life and Times of Benjamin Franklin* (2 vols., New York, 1864); John T. Morse, Jr., *Benjamin Franklin* (Boston, 1889, in the American Statesmen series); J. B. McMaster, *Benjamin Franklin as a Man of Letters* (Boston, 1887, in American Men of Letters series); Paul L. Ford, *The Many-Sided Franklin* (New York, 1899) and *Franklin Bibliography* (Brooklyn, 1889); E. E. Hale and E. E. Hale, Jr., *Franklin in France* (2 vols., Boston, 1888); J. H. A. Doniol, *Histoire de la participation de la France à l'établissement des États-Unis d'Amérique* (Paris, 6 vols., 1886-1900); S. G. Fisher, *The True Benjamin Franklin* (Philadelphia, 1899); E. Robins, *Benjamin Franklin* (New York, 1898, in the American Men of Energy series); W. A. Wetzel, "Benjamin Franklin as an Economist," No. 9, in series 13 of *Johns Hopkins Studies in Historical and Political Science*; and the prefaces and biographical matter in A. H. Smyth's edition of the *Works* (New York, 10 vols., 1905-1907). (R. W. E.)

FRANKLIN, SIR JOHN (1786-1847), English rear-admiral and explorer, was born at Spilsby, Lincolnshire, on the 16th of April 1786. His family was descended from a line of free-holders or "franklins" from whom some centuries earlier they had derived their surname; but the small family estate was sold by his father, who went into business. John, who was the fifth and youngest son and ninth child, was destined for the church. At the age of ten he was sent to school at St Ives, and soon afterwards was transferred to Louth grammar school, which he attended for two years. About this time his imagination was deeply impressed by a holiday walk of 12 m. which he made with a companion to look at the sea, and he determined to be a sailor. In the hope of dispelling this fancy his father sent him on a trial voyage to Lisbon in a merchantman; but it being found on his return that his wishes were unchanged he was entered as a midshipman on board the "Polypheusus," and shortly afterwards took part in her in the hard-fought battle of Copenhagen (2nd of April 1801). Two months later he joined the "Investigator," a discovery-ship commanded by his cousin Captain Matthew Flinders, and under the training of that able scientific officer was employed in the exploration and mapping of the coasts of Australia, where he acquired a correctness of astronomical observation and a skill in surveying which proved of eminent utility in his future career. He was on board the "Porpoise" when that ship and the "Cato" were wrecked (18th of August 1803) on a coral reef off the coast of Australia, and after this misfortune proceeded to China. Thence he obtained a passage to England in the "Earl Camden," East Indiaman, commanded by Captain (afterwards Sir) Nathaniel Dance, and performed the duty of signal midshipman in the famous action of the 15th of February 1804 when Captain Dance repulsed a strong French squadron led by the redoubtable Admiral Lincoln. On reaching England he joined the "Bellerophon," 74, and was in charge of the signals on board that ship during the battle of Trafalgar. Two years later he joined the "Bedford," attaining the rank of lieutenant the year after, and served in her on the Brazil station (whither the "Bedford" went as part of the convoy which escorted the royal family of Portugal to Rio de Janeiro in 1808), in the blockade of Flushing, and finally in the disastrous expedition against New Orleans (1814), in which campaign he displayed such zeal and intelligence as to merit special mention in despatches.

On peace being established, Franklin turned his attention once more to the scientific branch of his profession, and sedulously extended his knowledge of surveying. In 1818 the discovery of a North-West Passage to the Pacific became again, after a

long interval, an object of national interest, and Lieutenant Franklin was given the command of the "Trent" in the Arctic expedition, under the orders of Captain Buchan in the "Dorothea". During a heavy storm the "Dorothea" was so much damaged by the pack-ice that her reaching England became doubtful, and, much to the chagrin of young Franklin, the "Trent" was compelled to convey her home instead of being allowed to prosecute the voyage alone. This voyage, however, had brought Franklin into personal intercourse with the leading scientific men of London, and they were not slow in ascertaining his peculiar fitness for the command of such an enterprise. To calmness in danger, promptness and fertility of resource, and excellent seamanship, he added an ardent desire to promote science for its own sake, together with a love of truth that led him to do full justice to the merits of his subordinate officers, without wishing to claim their discoveries as a captain's right. Furthermore, he possessed a cheerful buoyancy of mind, sustained by deep religious principle, which was not depressed in the most gloomy times. It was therefore with full confidence in his ability and exertions that, in 1819, he was placed in command of an expedition appointed to proceed overland from the Hudson Bay to the shores of the Arctic Sea, and to determine the trendings of that coast eastward of the Coppermine river. At this period the northern coast of the American continent was known at two isolated points only,—this, the mouth of the Coppermine river (which, as Franklin discovered, was erroneously placed four degrees of latitude too much to the north), and the mouth of the Mackenzie far to the west of it. Lieutenant Franklin and his party, consisting of Dr Richardson, Midshipmen George Back and Richard Hood, and a few ordinary boatmen, arrived at the depot of the Hudson's Bay Company at the end of August 1819, and making an autumnal journey of 700 m. spent the first winter on the Saskatchewan. Owing to the supplies which had been promised by the North-West and Hudson's Bay Companies not being forthcoming the following year, it was not until the summer of 1821 that the Coppermine was ascended to its mouth, and a considerable extent of sea-coast to the eastward surveyed. The return journey led over the region known as the Barren Ground, and was marked by the most terrible sufferings and privations and the tragic death of Lieutenant Hood. The survivors of the expedition reached York Factory in the month of June 1822, having accomplished altogether 5550 m. of travel. While engaged on this service Franklin was promoted to the rank of commander (1st of January 1821), and upon his return to England at the end of 1822 he obtained the post rank of captain and was elected a fellow of the Royal Society. The narrative of this expedition was published in the following year and became at once a classic of travel, and soon after he married Eleanor, the youngest daughter of William Porden, an eminent architect.

Early in 1825 he was entrusted with the command of a second overland expedition, and upon the earnest entreaty of his dying wife, who encouraged him to place his duty to his country before his love for her, he set sail without waiting to witness her end. Accompanied as before by Dr (afterwards Sir) John Richardson and Lieutenant (afterwards Sir) George Back, he descended the Mackenzie river in the season of 1826 and traced the North American coast as far as 149° 37' W. long., whilst Richardson at the head of a separate party connected the mouths of the Coppermine and Mackenzie rivers. Thus between the years 1819 and 1827 he had added 1200 m. of coast-line to the American continent, or one-third of the whole distance from the Atlantic to the Pacific. These exertions were fully appreciated at home and abroad. He was knighted in 1820, received the honorary degree of D.C.L. from the university of Oxford, was awarded the gold medal of the Geographical Society of Paris, and was elected corresponding member of the Paris Academy of Sciences. The results of these expeditions are described by Franklin and Dr Richardson in two magnificent works published in 1824-1829. In 1828 he married his second wife, Jane, second daughter of John Griffin. His next official employment was on the Mediterranean station, in command of the "Rainbow," and his ship

soon became proverbial in the squadron for the happiness and comfort of her officers and crew. As an acknowledgment of the essential service which he rendered off Patras in the Greek War of Independence, he received the cross of the Redeemer of Greece from King Otto, and after his return to England he was created knight commander of the Guelphic order of Hanover.

In 1836 he accepted the lieutenant-governorship of Van Diemen's Land (now Tasmania), and held that post till the end of 1843. His government was marked by several events of much interest, one of his most popular measures being the opening of the doors of the legislative council to the public. He also founded a college, endowing it largely from his private funds, and in 1838 established a scientific society at Hobart Town (now called the Royal Society of Tasmania), the meetings of which were held in Government House and its papers printed at his expense. In his time also the colony of Victoria was founded by settlers from Tasmania; and towards its close, transportation to New South Wales having been abolished, the convicts from every part of the British empire were sent to Tasmania. On an increase of the lieutenant-governor's salary being voted by the colonial legislature, Sir John declined to derive any advantage from it personally, while he secured the augmentation to his successors. He welcomed eagerly the various expeditions for exploration and surveying which visited Hobart Town, conspicuous among these, and of especial interest to himself, being the French and English Antarctic expeditions of Dumont d'Urville and Sir James C. Ross—the latter commanding the "Erebus" and "Terror," with which Franklin's own name was afterwards to be so pathetically connected. A magnetic observatory fixed at Hobart Town, as a dependency of the central establishment under Colonel Sabine, was also an object of deep interest up to the moment of his leaving the colony. That his unflinching efforts for the social and political advancement of the colony were appreciated was abundantly proved by the affection and respect shown him by every section of the community on his departure; and several years afterwards the colonists showed their remembrance of his virtues and services by sending Lady Franklin a subscription of £1700 in aid of her efforts for the search and relief of her husband, and later still by a unanimous vote of the legislature for the erection of a statue in honour of him at Hobart Town.

Sir John found on reaching England that there was about to be a renewal of polar research, and that the confidence of the admiralty in him was undiminished, as was shown by his being offered the command of an expedition for the discovery of a North-West Passage to the Pacific. This offer he accepted. The prestige of Arctic service and of his former experiences attracted a crowd of volunteers of all classes, from whom were selected a body of officers conspicuous for talent and energy. Captain Crozier, who was second in command, had been three voyages with Sir Edward Parry, and had commanded the "Terror" in Ross's Antarctic expedition. Captain Fitzjames, who was commander on board the "Erebus," had been five times gazetted for brilliant conduct in the operations of the first China war, and in a letter which he wrote from Greenland has bequeathed some good-natured but masterly sketches of his brother officers and messmates on this expedition. Thus supported, with crews carefully chosen (some of whom had been engaged in the whaling service), victualled for three years, and furnished with every appliance then known, Franklin's expedition, consisting of the "Erebus" and "Terror" (120 officers and men), with a transport ship to convey additional stores as far as Disco in Greenland, sailed from Greenhithe on the 19th of May 1845. The letters which Franklin despatched from Greenland were couched in language of cheerful anticipation of success, while those received from his officers expressed their glowing hope, their admiration of the seamanlike qualities of their commander, and the happiness they had in serving under him. The ships were last seen by a whaler near the entrance of Lancaster Sound, on the 26th of July, and the deep gloom which settled down upon their subsequent movements was not finally raised till fourteen years later.

Franklin's instructions were framed in conjunction with Sir John Barrow and upon his own suggestions. The experience of Parry had established the navigability of Lancaster Sound (leading westwards out of Baffin Bay), whilst Franklin's own surveys had long before satisfied him that a navigable passage existed along the north coast of America from the Fish river to Bering Strait. He was therefore directed to push through Lancaster Sound and its continuation, Barrow Strait, without loss of time, until he reached the portion of land on which Cape Walker is situated, or about long. 98° W., and from that point to pursue a course southward towards the American coast. An explicit prohibition was given against a westerly course beyond the longitude of 98° W., but he was allowed the single alternative of previously examining Wellington Channel (which leads out of Barrow Strait) for a northward route, if the navigation here were open.

In 1847, though there was no real public anxiety as to the fate of the expedition, preparations began to be made for the possible necessity of sending relief. As time passed, however, and no tidings reached England, the search began in earnest, and from 1848 onwards expedition after expedition was despatched in quest of the missing explorers. The work of these expeditions forms a story of achievement which has no parallel in maritime annals, and resulted in the discovery and exploration of thousands of miles of new land within the grim Arctic regions, the development of the system of sledge travelling, and the discovery of a second North-West Passage in 1850 (see POLAR REGIONS). Here it is only necessary to mention the results so far as the search for Franklin was concerned. In this great national undertaking Lady Franklin's exertions were unwearied, and she exhausted her private funds in sending out auxiliary vessels to quarters not comprised in the public search, and by her pathetic appeals roused the sympathy of the whole civilized world.

The first traces of the missing ships, consisting of a few scattered articles, besides three graves, were discovered at Franklin's winter quarters (1845-1846) on Beechey Island, by Captain (afterwards Sir) Erasmus Ommanney of the "Assistance," in August 1851, and were brought home by the "Prince Albert," which had been fitted out by Lady Franklin. No further tidings were obtained until the spring of 1854, when Dr John Rae, then conducting a sledging expedition of the Hudson's Bay Company from Repulse Bay, was told by the Eskimo that (as was inferred) in 1850 white men, to the number of about forty, had been seen dragging a boat southward along the west shore of King William's Island, and that later in the same season the bodies of the whole party were found by the natives at a point a short distance to the north-west of Back's Great Fish river, where they had perished from the united effects of cold and famine. The latter statement was afterwards disproved by the discovery of skeletons upon the presumed line of route; but indisputable proof was given that the Eskimo had communicated with members of the missing expedition, by the various articles obtained from them and brought home by Dr Rae. In consequence of the information obtained by Dr Rae, a party in canoes, under Messrs Anderson and Stewart, was sent by government down the Great Fish river in 1855, and succeeded in obtaining from the Eskimo at the mouth of the river a considerable number of articles which had evidently belonged to the Franklin expedition; while others were picked up on Montreal Island a day's march to the northward. It was clear, therefore, that a party from the "Erebus" and "Terror" had endeavoured to reach the settlements of the Hudson's Bay Company by the Fish river route, and that in making a southerly course it had been arrested within the channel into which the Great Fish river empties itself. The admiralty now decided to take no further steps to determine the exact fate of the expedition, and granted to Dr Rae the reward of £10,000 which had been offered in 1849 to whosoever should first succeed in obtaining authentic news of the missing men. It was therefore reserved for the latest effort of Lady Franklin to develop, not only the fate of her husband's expedition but also the steps of its progress up to the very verge of success, mingled indeed with almost unprecedented disaster. With all her available means, and

aided, as she had been before, by the subscriptions of sympathizing friends, she purchased and fitted out the little yacht "Fox," which sailed from Aberdeen in July 1857. The command was accepted by Captain (afterwards Sir) Leopold M'Clintock, whose high reputation had been won in three of the government expeditions sent out in search of Franklin. Having been compelled to pass the first winter in Baffin Bay, it was not till the autumn of 1858 that the "Fox" passed down Prince Regent's Inlet, and put into winter quarters at Port Kennedy at the eastern end of Bellot Strait, between North Somerset and Boothia Felix. In the spring of 1859 three sledging parties went out, Captain (afterwards Sir) Allen Young to examine Prince of Wales Island, Lieutenant (afterwards Captain) Hobson the north and west coasts of King William's Island, and M'Clintock the east and south coasts of the latter, the west coast of Boothia, and the region about the mouth of Great Fish river. This splendid and exhaustive search added 800 m. of new coast-line to the knowledge of the Arctic regions, and brought to light the course and fate of the expedition. From the Eskimo in Boothia many relics were obtained, and reports as to the fate of the ships and men; and on the west and south coast of King William's Island were discovered skeletons and remains of articles that told a terrible tale of disaster. Above all, in a cairn at Point Victoria a precious record was discovered by Lieutenant Hobson that briefly told the history of the expedition up to April 25, 1848, three years after it set out full of hope. In 1845-1846 the "Erebus" and "Terror" wintered at Beechey Island on the S.W. coast of North Devon, in lat. $74^{\circ} 43' 28''$ N., long. $91^{\circ} 39' 15''$ W., after having ascended Wellington Channel to lat. 77° and returned by the west side of Cornwallis Island. This statement was signed by Graham Gore, lieutenant, and Charles F. des Voeux, mate, and bore date May 28, 1847. These two officers and six men, it was further told, left the ships on May 24, 1847 (no doubt for an exploring journey), at which time all was well.

Such an amount of successful work has seldom been accomplished by an Arctic expedition within any one season. The alternative course permitted Franklin by his instructions had been attempted but not pursued, and in the autumn of 1846 he had followed that route which was specially commended to him. But after successfully navigating Peel and Franklin Straits on his way southward, his progress had been suddenly and finally arrested by the obstruction of heavy ("palaeocrystic") ice, which presses down from the north-west through M'Clintock Channel (not then known to exist) upon King William's Island. It must be remembered that in the chart which Franklin carried King William's Island was laid down as a part of the mainland of Boothia, and he therefore could pursue his way *only* down its western coast. Upon the margin of the printed admiralty form on which this brief record was written was an addendum dated the 25th of April 1848, which extinguished all further hopes of a successful termination of this grand enterprise. The facts are best conveyed in the terse and expressive words in which they were written, and are therefore given *verbatim*: "April 25th, 1848. H.M. Ships 'Terror' and 'Erebus' were deserted on 22nd April, five leagues N.N.W. of this, having been beset since 12th September 1846. The officers and crews, consisting of 105 souls under the command of Captain F. R. M. Crozier, landed in lat. $69^{\circ} 37' 42''$ N., long. $98^{\circ} 41' 7''$ W. This paper was found by Lieut. Irving . . . where it had been deposited by the late Commander Gore in June 1847. Sir John Franklin died on the 11th June 1847; and the total loss by deaths in the expedition has been to this date 9 officers and 15 men." The handwriting is that of Captain Fitzjames, to whose signature is appended that of Captain Crozier, who also adds the words of chief importance, namely, that they would "start on to-morrow 26th April 1848 for Back's Fish river." A briefer record has never been told of so tragic a story.

All the party had without doubt been greatly reduced through want of sufficient food, and the injurious effects of three winters in these regions. They had attempted to drag with them two boats, besides heavily laden sledges, and doubtless had soon

been compelled to abandon much of their burden, and leave one boat on the shore of King William's Island, where it was found by M'Clintock near the middle of the west coast, containing two skeletons. The route adopted was the shortest possible, but their strength and supplies had failed, and at that season of the year the snow-covered land afforded no subsistence. An old Eskimo woman stated that these heroic men "fell down and died as they walked," and, as Sir John Richardson has well said, they "forged the last link of the North-West Passage with their lives." From all that can be gathered, one of the ships must have been crushed in the ice and sunk in deep water, and the other, stranded on the shore of King William's Island, lay there for years, forming a mine of wealth for the neighbouring Eskimo.

This is all we know of the fate of Franklin and his brave men. His memory is cherished as one of the most conspicuous of the naval heroes of Britain, and as one of the most successful and daring of her explorers. He is certainly entitled to the honour of being the first discoverer of the North-West Passage; the point reached by the ships having brought him to within a few miles of the known waters of America, and on the monument erected to him by his country, in Waterloo Place, London, this honour is justly awarded to him and his companions,—a fact which was also affirmed by the president of the Royal Geographical Society, when presenting their gold medal to Lady Franklin in 1860. On the 26th of October 1852 Franklin had been promoted to the rank of rear-admiral. He left an only daughter by his first marriage. Lady Franklin died in 1875 at the age of eighty-three, and a fortnight after her death a fine monument was unveiled in Westminster Abbey, commemorating the heroic deeds and fate of Sir John Franklin, and the inseparable connexion of Lady Franklin's name with the fame of her husband. Most of the relics brought home by M'Clintock were presented by Lady Franklin to the United Service Museum, while those given by Dr Rae to the admiralty are deposited in Greenwich hospital. In 1864-1869 the American explorer Captain Hall made two journeys in endeavouring to trace the remnant of Franklin's party, bringing back a number of additional relics and some information confirmatory of that given by M'Clintock, and in 1878 Lieutenant F. Schwatka of the United States army and a companion made a final land search, but although accomplishing a remarkable record of travel discovered nothing which threw any fresh light on the history of the expedition.

See H. D. Traill, *Life of Sir John Franklin* (1896).

FRANKLIN, WILLIAM BUEL (1823-1903), Federal general in the American Civil War, was born at York, Pennsylvania, on the 27th of February 1823. He graduated at West Point, at the head of his class, in 1843, was commissioned in the Engineer Corps, U.S.A., and served with distinction in the Mexican War, receiving the brevet of first lieutenant for his good conduct at Buena Vista, in which action he was on the staff of General Taylor. After the war he was engaged in miscellaneous engineering work, becoming a first lieutenant in 1853 and a captain in 1857. Soon after the outbreak of the Civil War in 1861 he was made colonel of a regular infantry regiment, and a few days later brigadier-general of volunteers. He led a brigade in the first battle of Bull Run, and on the organization by McClellan of the Army of the Potomac he received a divisional command. He commanded first a division and then the VI. Corps in the operations before Richmond in 1862, earning the brevet of brigadier-general in the U.S. Army; was promoted major-general, U.S.V., in July 1862; commanded the VI. corps at South Mountain and Antietam; and at Fredericksburg commanded the "Left Grand Division" of two corps (I. and VI.). His part in the last battle led to charges of disobedience and negligence being preferred against him by the commanding general, General A. E. Burnside, on which the congressional committee on the conduct of the war reported unfavourably to Franklin, largely, it seems, because Burnside's orders to Franklin were not put in evidence. Burnside had issued on the 23rd of January 1863 an order relieving Franklin from duty,

and Franklin's only other service in the war was as commander of the XIX. corps in the abortive Red River Expedition of 1864. In this expedition he received a severe wound at the action of Sabine Cross Roads (April 8, 1864), in consequence of which he took no further active part in the war. He served for a time on the retiring board, and was captured by the Confederates on the 11th of July 1864, but escaped the same night. In 1865 he was brevetted major-general in the regular army, and in 1866 he was retired. After the war General Franklin was vice-president of the Colt's Patent Firearms Manufacturing Company, was president of the commission to lay out Long Island City, N.Y. (1871-1872), of the commission on the building of the Connecticut state house (1872-1873), and, from 1880 to 1899, of the board of managers of the national home for disabled volunteer soldiers; as a commissioner of the United States to the Paris Exposition of 1889 he was made a grand officer of the Legion of Honour; and he was for a time a director of the Panama railway. He died at Hartford, Connecticut, on the 8th of March 1903. He wrote a pamphlet, *The Gulling Gun for Service Ashore and Afloat* (1874).

See *A Reply of Major-General William B. Franklin to the Report of the Joint Committee of Congress on the Conduct of the War* (New York, 1863; 2nd ed., 1867), and Jacob L. Greene, *Gen. W. B. Franklin and the Operations of the Left Wing at the Battle of Fredericksburg* (Hartford, 1900).

FRANKLIN, an organized district of Canada, extending from the Arctic Circle to the North Pole. It was formed by order-in-council on the 2nd of October 1895, and includes numerous islands and peninsulas, such as Banks, Prince Albert, Victoria, Wollaston, King Edward and Baffin Land, Melville, Bathurst, Prince of Wales and Cockburn Islands. Of these, Baffin Land alone extends south of the Arctic Circle. The area is estimated at 500,000 sq. m., but the inhabitants consist of a few Indians, Eskimo and fur-traders. Musk-oxen, polar bears, foxes and other valuable fur-bearing animals are found in large numbers. The district is named after Sir John Franklin.

FRANKLIN, a township of Norfolk county, Massachusetts, U.S.A., with an area of 29 sq. m. of rolling surface. Pop. (1900) 5017, of whom 1250 were foreign-born; (1905, state census) 5244; (1910 census) 5641. The principal village, also named Franklin, is about 27 m. S.W. of Boston, and is served by the New York, New Haven & Hartford railway. Franklin has a public library (housed in the Ray memorial building and containing 7700 volumes in 1910) and is the seat of Dean Academy (Universalist; founded in 1865), a secondary school for boys and girls. Straw goods, felt, cotton and woollen goods, pianos and printing presses are manufactured here. The township was incorporated in 1778, previous to which it was a part of Wrentham (1673). It was the first of the many places in the United States named in honour of Benjamin Franklin (who later contributed books for the public library). Horace Mann was born here.

FRANKLIN, a city of Merrimack county, New Hampshire, U.S.A., at the confluence of the Pemigewasset and Winnepesaukee rivers to form the Merrimack; about 95 m. N.N.W. of Boston. Pop. (1890) 4085; (1900) 5846 (1323 foreign-born); (1910) 6132; area, about 14.4 sq. m. Franklin is served by the Concord Division of the Boston & Maine railway, with a branch to Bristol (13 m. N.W.) and another connecting at Tilton (about 5 m. E.) with the White Mountains Division. It contains the villages of Franklin, Franklin Falls, Webster Place and Lake City, the last a summer resort. The rivers furnish good water power, which is used in the manufacture of a variety of commodities, including foundry products, paper and pulp, woollen goods, hosiery, saws, needles and knitting machines. The water-works are owned and operated by the municipality. Here, in what was then a part of the town of Salisbury, Daniel Webster was born, and on the Webster farm is the New Hampshire orphans' home, established in 1871. The town of Franklin was formed in 1828 by the union of portions of Salisbury, Sanbornton, Andover and Northfield. The earliest settlement within its limits was made in 1748 in the portion taken from Salisbury. Franklin was incorporated as a city in 1895.

soldiers; *Salii seniores* and *Salii juniores* are mentioned in the *Notitia dignitatum*, and *Salii* appear among the *auxilia palatina*.

At the end of the 4th century and at the beginning of the 5th, when the Roman legions withdrew from the banks of the Rhine, the *Salians* installed themselves in the district as an independent people. The place-names became entirely Germanic; the Latin language disappeared; and the Christian religion suffered a check, for the Franks were to a man pagans. The *Salians* were subdivided into a certain number of tribes, each tribe placing at its head a king, distinguished by his long hair and chosen from the most noble family (*Historia Francorum*, II. 9).

The most ancient of these kings, reigning over the principal tribe, who is known to us is *Chlodio*.¹ According to Gregory of Tours *Chlodio* dwelt at a place called *Dispargum*, which it is impossible to identify. Towards 431 he crossed the great Roman road from *Bavay* to *Cologne*, which was protected by numerous forts and had long arrested the invasions of the barbarians. He then invaded the territory of *Arras*, but was severely defeated at *Headin-le-Vieux* by *Aetius*, the commander of the Roman army in *Gaul*. *Chlodio*, however, soon took his revenge. He explored the region of *Cambrai*, seized that town, and occupied all the country as far as the *Somme*. At this time *Tournai* became the capital of the *Salian Franks*.

After *Chlodio* a certain *Meroveus* (*Merowech*) was king of the *Salian Franks*. We do not know if he was the son of *Chlodio*; *Gregory of Tours* simply says that he belonged to *Chlodio's* stock—"de hujus stirpe quidam *Merovechum* regem fuisse adserunt,"—and then only gives the fact at second hand. Perhaps the remarks of the Byzantine historian *Priscus* may refer to *Meroveus*. A king of the *Franks* having died, his two sons disputed the power. The elder journeyed into *Pannonia* to obtain support from *Attila*; the younger betook himself to the imperial court at *Rome*. "I have seen him," writes *Priscus*; "he was still very young, and we all remarked his fair hair which fell upon his shoulders." *Actius* welcomed him warmly and sent him back a friend and *foederatus*. In any case, eventually, *Franks* fought (451) in the Roman ranks at the great battle of *Mauriac* (the *Catalaunian Fields*), which arrested the progress of *Attila* into *Gaul*; and in the *Vita Lupi*, which, though undoubtedly of later date, is a recension of an earlier document, the name of *Meroveus* appears among the combatants. Towards 457 *Meroveus* was succeeded by his son *Childeric*. At first *Childeric* was a faithful *foederatus* of the Romans, fighting for them against the *Visigoths* and the *Saxons* south of the *Loire*; but he soon sought to make himself independent and to extend his conquests. He died in 481 and was succeeded by his son *Clovis*, who conquered the whole of *Gaul* with the exception of the kingdom of *Burgundy* and *Provence*. *Clovis* made his authority recognized over the other *Salian* tribes (whose kings dwelt at *Cambrai* and other cities), and put an end to the domination of the *Riparian Franks*.

These *Riparians* must have comprised a certain number of *Frankish* tribes, such as the *Ampivarii* and the *Bructeri*. They settled in the 5th century in compact masses on the left bank of the *Rhine*, but their progress was slow. It was not until the Christian writer *Salvian* (who was born about 400) had already reached a fairly advanced age that they were able to seize *Cologne*. The town, however, was recaptured and was not definitely in their possession until 463. The *Riparians* subsequently occupied all the country from *Cologne* to *Trier*. *Aix-la-Chapelle*, *Bonn* and *Zülpich* were their principal centres, and they even advanced southward as far as *Metz*, which appears to have resisted their attacks. The Roman civilization and the Latin language disappeared from the countries which they occupied; indeed it seems that the actual boundaries of the German and French languages nearly coincide with those of their dominion. In their southward progress the *Riparians*

¹The chronicler *Fredegarius* and the author of the *Liber historiarum Francorum* make *Sunno* and *Marcomeris* his predecessors, but in reality they were chiefs of other *Frankish* tribes. The author of the *Liber* also claims that *Chlodio* was the son of *Pharamund*, but this personage is quite legendary. In the *Chronicon* of *Fredegarius* it is already affirmed that the *Franks* are descended from the *Trojans*.

encountered the *Alamanni*, who, already masters of *Alsace*, were endeavouring to extend their conquests in all directions. There were numerous battles between the *Riparians* and the *Alamanni*; and the memory of one fought at *Zülpich* has come down to us. In this battle *Siebert*, the king of the *Riparians*, was wounded in the knee and limped during the remainder of his life—hence his surname *Claudus* (the Lame). The *Riparians* long remained allies of *Clovis*, *Siebert's* son *Chloderic* fighting under the king of the *Salian Franks* at *Vouillé* in 507. *Clovis*, however, persuaded *Chloderic* to assassinate his father, and then posed as *Siebert's* avenger, with the result that *Chloderic* was himself assassinated and the *Riparians* raised *Clovis* on the shield and chose him as king. Thus the *Salian Franks* united under their rule all the *Franks* on the left bank of the *Rhine*. During the reigns of *Clovis's* sons they again turned their eyes on *Germany*, and imposed their suzerainty upon the *Franks* on the right bank. This country, north of the *Main* and the first residence of the *Franks*, then received the name of *Francia Orientalis*, and became the origin of one of the duchies into which *Germany* was divided in the 10th century—the duchy of *Franconia* (*Franken*).

The *Franks* were redoubtable warriors, and were generally of great stature. Their fair or red hair was brought forward from the crown of the head towards the forehead, leaving the nape of the neck uncovered; they shaved the face except the upper lip. They wore fairly close breeches reaching to the knee and a tunic fastened by brooches. Round the waist over the tunic was worn a leathern girdle having a broad iron buckle damascened with silver. From the girdle hung the single-edged missile axe or *francisca*, the *scramasax* or short knife, a poniard and such articles of toilet as scissors, a comb (of wood or bone), &c. The *Franks* also used a weapon called the *franca* (an iron lance set firmly in a wooden shaft), and bows and arrows. They protected themselves in battle with a large wooden or wicker shield, the centre of which was ornamented with an iron boss (*umbo*). *Frankish* arms and armour have been found in the cemeteries which abound throughout northern *France*, the warriors being buried fully armed.

See J. Grimm, *Deutsche Rechtsalterthümer* (Göttingen, 1828); K. Müllenhoff, *Deutsche Alterthumskunde* (Berlin, 1883-1900); E. von Wietersheim, *Geschichte der Völkerwanderung*, 2nd ed., ed. by F. Dahn (Leipzig, 1880-1881); G. Waitz, *Deutsche Verfassungsgeschichte*, vol. i. (4th ed. revised by Zeumer); R. Schröder, "Die Ausbreitung der salischen Franken," in *Forschungen zur deutschen Geschichte*, vol. xix.; K. Lamprecht, *Frankische Wanderungen und Ansiedelungen* (Aix-la-Chapelle, 1882); W. Schultz, *Deutsche Geschichte von der Urzeit bis zu den Karolingern*, vol. ii. (Stuttgart, 1896); Fustel de Coulanges, *Histoire des institutions politiques de l'ancienne France—Féodalisme germanique* (Paris, 1891). Also the articles *SALIC LAW* and *GERMANIC LAWS*, EARLY. (C. FF.)

FRANZ, ROBERT (1815-1892), German composer, was born at Halle on the 28th of June 1815. One of the most gifted of German song writers, he suffered in early life, as many musicians have suffered, from the hostility of his parents to a musical career. He was twenty years old when, his father's animosity conquered, he was allowed to live in Dessau to study organ-playing under *Schneider*. The two years of dry study under that famous teacher were advantageous chiefly in making him uncommonly intimate with the works of *Bach* and *Handel*, his knowledge of which he showed in his editions of the *Matthäus Passion*, *Magnificat*, ten cantatas, and of the *Messiah* and *L'Allegro*, though some of these editions have long been a subject of controversy among musicians. In 1843 he published his first book of songs, which ultimately was followed by some fifty more books, containing in all about 250 songs. At Halle, *Franz* filled various public offices, including those of organist to the city, conductor of the Sing-akademie and of the Symphony concerts, and he was also a royal music-director and master of the music at the university. The first book of songs was warmly praised by *Schumann* and *Liszt*, the latter of whom wrote a lengthy review of it in *Schumann's* paper, *Die neue Zeitschrift*, which later was published separately. Deafness had begun to make itself apparent as early as 1841, and *Franz* suffered also from a nervous disorder, which in 1868 compelled him to resign his

offices. His future was then provided for by Liszt, Dr Joachim, Frau Magnus and others, who gave him the receipts of a concert tour, amounting to some 100,000 marks. Franz died on the 24th of October 1892. On his seventieth birthday he published his first and only pianoforte piece. It is easy to find here and there among his songs gems that are hardly less brilliant than the best of Schumann's. Certainly no musician was ever more thoughtful and more painstaking. In addition to songs he wrote a setting for double choir of the 117th Psalm, and a four-part Kyrie; he also edited Astorga's *Stabat Mater* and Durante's *Magnificat*.

FRANZÉN, FRANS MIKAEL (1772-1847), Swedish poet, was born at Uleåborg in Finland on the 9th of February 1772. At thirteen he entered the university of Abo, where he attended the lectures of H. G. Porthan (1739-1804), a pioneer in the study of Finnish history and legend. He graduated in 1790, and became "doquentiae docens" in 1792. Three years later he started on a tour through Denmark, Germany, France and England, returning in 1796 to accept the office of university librarian at Abo. In 1801 he became professor of history and ethics, and in 1808 was elected a member of the Swedish Academy. On the cession of Finland to Russia, Franzén removed to Sweden, where he was successively appointed parish priest of Kumla in the diocese of Strengnäs (1810), minister of the Clara Church in Stockholm (1824) and bishop of Hernösand (1831). He died at Sibirsk parsonage on the 14th of August 1847. From the autumn of 1793, when his *Till en ung Flicka* and *Menniskans ölsö* were inserted by Kellgren in the *Stockholmspost*, Franzén grew in popular favour by means of many minor poems of singular simplicity and truth, as *Till Selma, Den gamle knekten, Biddar St Göran, De Små blommorna, Modren vid vagnen, Nyårsborgonen* and *Stjärnhimmelen*. His songs *Goda gosse fluset löm, Sörj ej den gryende dagen förut, Champagnecinet* and *Beväringsång* were widely sung, and in 1797 he won the prize of the Swedish Academy by his *Sång öfver grejven Filip Creutz*. Henceforth his muse, touched with the academic spirit, grew more reflective and didactic. His longer works, as *Emilii eller en afton i Lappland*, and the epics *Stante Sture eller mötet vid Ånströ, Kolumbus eller Amerikas upptäckt* and *Gustaf Adolf i Tyckland* (the last two incomplete), though rich in beauties of detail, are far inferior to his shorter pieces.

The poetical works of Franzén are collected under the title *Skalde-sången* (7 vols., 1824-1861); new ed., *Samlade dikter*, with a biography by A. A. Graffström (1867-1869); also a selection (*Valda dikter*) 12 vols. (1871). His prose writings, *Om svenska drottningar* (Abo, 1826; Örebro, 1823), *Skrifter i obunden stil*, vol. i. (1835), *Predikningar* (5 vols., 1841-1845) and *Minnestekningar*, prepared for the academy (3 vols., 1848-1860), are marked by faithful portraiture and purity of style. See B. E. Malmström, in the *Handlingar* of the Swedish Academy (1852, new series 1887), vol. ii.; S. A. Hollander, *Minne af F. M. Franzén* (Örebro, 1868); F. Cygnaeus, *Tekningar af F. M. Franzéns lefnad* (Helsingfors, 1872); and Gustaf Ljunggren, *Svenska litteraturens häfder efter Gustaf III:s död*, vol. ii. (1876).

FRANZENSBAD, or KAISER-FRANZENSBAD, a town and watering-place of Bohemia, Austria, 152 m. W.N.W. of Prague by rail. Pop. (1900) 2330. It is situated at an altitude of about 1300 ft. between the spurs of the Fichtelgebirge, the Böhmerwald and the Erzgebirge, and lies 4 m. N.W. of Eger. It possesses a large kursaal, several bathing establishments, a hospital for poor patients and several parks. There are altogether 12 mineral springs with saline, alkaline and ferruginous waters, of which the oldest and most important is the Franzensquelle. One of the springs gives off carbonic acid gas and another contains a considerable proportion of lithia salts. The waters, which have an average temperature between 50.2° F. and 54.5° F., are used both internally and externally, and are efficacious in cases of anaemia, nervous disorders, sexual diseases, specially for women, and heart diseases. Franzensbad is frequently resorted to as an after-cure by patients from Carlsbad and Marienbad. Another important part of the cure is the so-called *mor* or mud-baths, prepared from the peat of the Franzensbad marsh, which is very rich in mineral substances, like sulphates of iron, of soda and of potash, organic acids, salt, &c.

The first information about the springs dates from the 16th century, and an analysis of the waters was made in 1565. They

were first used for bathing purposes in 1707. But the foundation of Franzensbad as a watering-place really dates from 1793, when Dr Adler built here the first *Kurhaus*, and the place received its name after the emperor Francis I.

See Dr Loimann, *Franzensbad* (3rd ed., Vienna, 1900).

FRANZ JOSEF LAND, an arctic archipelago lying E. of Spitsbergen and N. of Novaya Zemlya, extending northward from about 80° to 82° N., and between 42° and 64° E. It is described as a lofty glacier-covered land, reaching an extreme elevation of about 2400 ft. The glaciers front, with a perpendicular ice-wall, a shore of debris on which a few low plants are found to grow—poppies, mosses and the like. The islands are volcanic, the main geological formation being Tertiary or Jurassic basalt, which occasionally protrudes through the ice-cap in high isolated blocks near the shore. A connecting island-chain between Franz Josef Land and Spitzbergen is probable. The bear and fox are the only land mammals; insects are rare; but the avifauna is of interest, and the Jackson expedition distinguished several new species.

August Petermann expressed the opinion that Baffin may have sighted the west of Franz Josef Land in 1614, but the first actual discovery is due to Julius Payer, a lieutenant in the Austrian army, who was associated with Weyprecht in the second polar expedition fitted out by Count Wilczek on the ship "Tegetthof" in 1872. On the 13th of August 1873, the "Tegetthof" being then beset, high land was seen to the north-west. Later in the season Payer led expeditions to Hochstetter and Wilczek islands, and after a second winter in the ice-bound ship, a difficult journey was made northward through Austria Sound, which was reported to separate two large masses of land, Wilczek Land on the east from Zichy Land on the west, to Cape Fligely, in 82° 5' N.; where Rawlinson Sound branched away to the north-east. Cape Fligely was the highest latitude attained by Payer, and remained the highest attained in the Old World till 1895. Payer reported that from Cape Fligely land (Rudolf Land) stretched north-east to a cape (Cape Sherard Osborn), and mountain ranges were visible to the north, indicating lands beyond the 83rd parallel, to which the names King Oscar Land and Petermann Land were given. In 1879 De Bruyne sighted high land in the Franz Josef Land region, but otherwise it remained untouched until Leigh Smith, in the yacht "Eira," explored the whole southern coast from 42° to 54° E. in 1881 and 1882, discovering many islands and sounds, and ascertaining that the coast of Alexandra Land, in the extreme west, trended to north-west and north.

After Leigh Smith came another pause, and no further mention is made of Franz Josef Land till 1894. In that year Mr Alfred Harmsworth (afterwards Lord Northcliffe) fitted out an expedition in the ship "Windward" under the leadership of Mr F. G. Jackson, with the object of establishing a permanent base from which systematic exploration should be carried on for successive years and, if practicable, a journey should be made to the Pole. Mr Jackson and his party landed at "Elmwood" (which was named from Lord Northcliffe's seat in the Isle of Thanet), near Cape Flora, at the western extremity of Northbrook Island, on the 7th of September. After a preliminary reconnaissance to the north, which afterwards turned out to be vitally important, the summer of 1895 was spent in exploring the coast to the north-west by a boating expedition. This expedition visited many of the points seen by Leigh Smith, and discovered land, which it has been suggested may be the Gillies Land reported by the Dutch captain Gillies in 1707. In 1896 the Jackson-Harmsworth expedition worked northwards through an archipelago for about 70 m. and reached Cape Richthofen, a promontory 700 ft. high, whence an expanse of open water was seen to the northward, which received the name of Queen Victoria Sea. To the west, on the opposite side of a wide opening which was called the British Channel, appeared glacier-covered land, and an island lay to the northward. The island was probably the King Oscar Land of Payer. To north and north-east was the land which had been visited in the reconnaissance of the previous year, but beyond it a water-sky appeared in the

supposed position of Petermann Land. Thus Zichy Land itself was resolved into a group of islands, and the outlying land sighted by Payer was found to be islands also. Meanwhile Nansen, on his southward journey, had approached Franz Josef Land from the north-east, finding only sea at the north end of Wilczek Land, and seeing nothing of Payer's Rawlinson Sound, or of the north end of Austria Sound. Nansen wintered near Cape Norway, only a few miles from the spot reached by Jackson in 1895. He had finally proved that a deep oceanic basin lies to the north. On the 17th of June 1896 the dramatic meeting of Jackson and Nansen took place, and in the same year the "Windward" revisited "Elmwood" and brought Nansen home, the work of the Jackson-Harmsworth expedition being continued for another year. As the non-existence of land to the north had been proved, the attempt to penetrate northwards was abandoned, and the last season was devoted to a survey and scientific examination of the archipelago, especially to the west; this was carried out by Messrs Jackson, Armitage, R. Koettlitz, H. Fisher and W. S. Bruce.

Further light was thrown on the relations of Franz Josef Land and Spitzbergen during 1897 by the discoveries of Captain Robertson of Dundee, and Wyche's Land was circumnavigated by Mr Arnold Pike and Sir Savile Crossley. The latter voyage was repeated in the following year by a German expedition under Dr Th. Lerner and Captain Rüdiger. In August 1898 an expedition under Mr Walter Wellman, an American, landed at Cape Tegetthof. Beginning a northward journey with sledges at the end of the winter, Wellman met with an accident which compelled him to return, but not before some exploration had been accomplished, and the eastern extension of the archipelago fairly well defined. In June 1899 H.R.H. the duke of Abruzzi started from Christiania in his yacht, the "Stella Polare," to make the first attempt to force a ship into the newly discovered ocean north of Franz Josef Land. The "Stella Polare" succeeded in making her way through the British Channel to Crown Prince Rudolf Land, and wintered in Teplitz Bay, in 81° 33' N. lat. The ship was nearly wrecked in the autumn, and the party had to spend most of the winter on shore, the duke of Abruzzi suffering severely from frost-bite. In March 1900 a sledge party of thirteen, under Captain Cagni, started northwards. They found no trace of Petermann Land, but with great difficulty crossed the ice to 86° 33' N. lat., 20 m. beyond Nansen's farthest, and 240 m. from the Pole. The party, with the exception of three, returned to the ship after an absence of 104 days, and the "Stella Polare" returned to Tromsø in September 1900. In 1901-1902 the Baldwin-Ziegler expedition also attempted a northward journey from Franz Josef Land.

See *Geographical Journal*, vol. xi, February 1898; F. G. Jackson, *A Thousand Days in the Arctic* (1899).

FRANZOS, KARL EMIL (1838-1904), German novelist, was born of Jewish parentage on the 25th of October 1838 in Russian Podolia, and spent his early years at Czortkôw in Galicia. His father, a district physician, died early, and the boy, after attending the gymnasium of Czernowitz, was obliged to teach in order to support himself and prepare for academic study. He studied law at the universities of Vienna and Graz, but after passing the examination for employment in the state judicial service abandoned this career and, becoming a journalist, travelled extensively in south-east Europe, and visited Asia Minor and Egypt. In 1877 he returned to Vienna, where from 1884 to 1886 he edited the *Neue illustrierte Zeitung*. In 1887 he removed to Berlin and founded the fortnightly review *Deutsche Dichtung*. Franzos died on the 28th of January 1904. His earliest collections of stories and sketches, *Aus Halb-Asien, Land und Leute des östlichen Europas* (1876) and *Die Juden von Barrow* (1877) depict graphically the life and manners of the races of south-eastern Europe. Among other of his works may be mentioned the short stories, *Junge Liebe* (1878), *Stille Geschichten* (1880), and the novels *Moschko von Parma* (1880), *Ein Kampf ums Recht* (1881), *Der Präsident* (1884), *Judith Trachtenberg* (1890), *Der Wahrheitsucher* (1894).

FRASCATI, a town and episcopal see of Italy, in the of Rome, 15 m. S.E. of Rome by rail, and also reached by tramway via Grottaferrata. Pop. (1901) 8,453. The situated 1056 ft. above the sea-level, on the N. slopes of crater ring of the Alban Hills, and commands a very of the Campagna of Rome. The cathedral contains a tablet to Charles Edward, the Young Pretender, who for some while rested here; his brother, Henry, Cardi owned a villa at Frascati. The villas of the Roman with their beautiful gardens and fountains, are the chief of Frascati. The earliest in date is the Villa I planned by Cardinal Ruffini before 1550; the most I of the rest are the Villa Torlonia (formerly Conti), I (formerly Piccolomini), Ruffinella (now belonging to Lancelotti), Aldobrandini, Borghese and Mondragon Jesuit school). The surrounding country, covered with of ancient villas, is fertile and noted for its wine. seems to have arisen on the site of a very large ancient which, under Domitian at any rate, belonged to the house about the 9th century, in which period we find *Liber Pontificalis* the names of four churches in the medieval stronghold of the counts of Tusculum which occupied the site of the ancient city, was dismantled the Romans in 1191, and the inhabitants put to the mutilated. Many of the fugitives naturally took Frascati. The see of Tusculum had, however, always cathedral church in Frascati. For the greater part of 13 ages Frascati belonged to the papacy.

See C. Tomassetti, *La Via Latina nel medio evo* (Rome 170 seq.; T. Ashby in *Papers of the British School at Rome*, London, 1907).

FRASER, ALEXANDER CAMPBELL (1819-), philosopher, was born at Ardhattan, Argyllshire, on the 1st of September 1819. He was educated at Glasgow and Edinburgh, where, from 1846 to 1856, he was professor of Logic in Glasgow College. He edited the *North British Review* from 1859 to 1865, and in 1856, having previously been a Free Church minister, he succeeded Sir William Hamilton as professor of Logic and Metaphysics at Edinburgh University. In 1859 he became dean of the faculty of arts. He devoted himself to the study of English philosophers, especially Berkeley, and published *Collected Edition of the Works of Bishop Berkeley with Introduction, &c.* (1871; enlarged 1901), a *Biography of Berkeley* (1871), an *Annotated Edition of Locke's Essay* (1894), the *Philosophy of Theism* (1896) and the *Biography of Thomas Reid* (1896). He contributed the article on John Locke to the *Encyclopædia Britannica*. In 1904 he published an autobiography, *Biographia philosophica*, in which he sketched the progress of his intellectual development. From this work and from his lectures we learn objectively what had previously been known from his critical works. After a childhood spent in an atmosphere which stigmatized as unholy even the novels of Sir Walter Scott, he began his college career at the age of fourteen at the University of Glasgow, where he was lecturing in Philosophy and Logic. His first philosophical advancement was stimulated by Thomas Brown's *Cause and Effect*, which introduced him to the problems which were to occupy his mind. From this point he fell into the scepticism of Hume. Sir William Hamilton was appointed to the chair of Logic and Metaphysics, and Fraser became his pupil. He him- self said, "I owe more to Hamilton than to any other influence of the time also that he began his study of Berkeley." Coleridge, and deserted his early phenomenalism for the conception of a spiritual will as the universal cause. In his *Biographia* this "Theistic faith" appears in its full development (see the concluding chapter), and is especially impressive perhaps the nearest approach to Kantian ethics made by an English philosopher. Apart from the philosophical in his *Biographia*, the work contains valuable pictures of the life of Lorne and Argyllshire society in the early 19th century, and of university life in Glasgow and Edinburgh, and a history of the *North British Review*.

FRASER, JAMES (1818-1885), English bishop, was born at Prestbury, in Gloucestershire, on the 18th of August 1818, and was educated at Bridgnorth, Shrewsbury, and Lincoln College, Oxford. In 1839 he was Ireland scholar, and took a first class. In 1840 he gained an Oriol fellowship, and was for some time tutor of the college, but did not take orders until 1846. He was successively vicar of Cholderton, in Wiltshire, and rector of Ufton Nervet, in Berkshire; but his subsequent importance was largely due to W. K. Hamilton, bishop of Salisbury, who recommended him as an assistant commissioner of education. His report on the educational condition of thirteen poor-law unions, made in May 1850, was described by Thomas Hughes as "a superb, almost a unique piece of work." In 1865 he was commissioned to report on the state of education in the United States and Canada, and his able performance of this task brought him an offer of the bishopric of Calcutta, which he declined, but in January 1870 he accepted the see of Manchester. The task before him was an arduous one, for although his predecessor, James Prince Lee, had consecrated no fewer than 130 churches, the enormous population was still greatly in advance of the ecclesiastical machinery. Fraser worked with the utmost energy, and did even more for the church by the liberality and geniality which earned him the title of "the bishop of all denominations." He was prominent in secular as well as religious works, interesting himself in every movement that promoted health, morality, or education; and especially serviceable as the friendly, unofficial counsellor of all classes. His theology was that of a liberal high-churchman, and his sympathies were broad. In convocation he seconded a motion for the disuse of the Athanasian Creed, and in the House of Lords he voted for the abolition of university tests. He died suddenly on the 22nd of October 1885.

A biography by Thomas Hughes was published in 1887, and an account of his Lancashire life by J. W. Diggle (1889), who also edited a vol. of *University and Parochial Sermons* (1887).

FRASER, JAMES BAILLIE (1783-1856), Scottish traveller and author, was born at Reelick in the county of Inverness on the 11th of June 1783. He was the eldest of the four sons of Edward Satchell Fraser of Reelick, all of whom found their way to the East, and gave proof of their ability. In early life he went to the West Indies and thence to India. In 1815 he made a tour of exploration in the Himalayas, accompanied by his brother William (d. 1835). When Reza Kuli Mirza and Nejeff Kali Mirza, the exiled Persian princes, visited England, he was appointed to look after them during their stay, and on their return he accompanied them as far as Constantinople. He was afterwards sent to Persia on a diplomatic mission by Lord Glenelg, and effected a most remarkable journey on horseback through Asia Minor to Teheran. His health, however, was impaired by the exposure. In 1823 he married a daughter of Alexander Fraser Tytler, Lord Woodhouselee, a sister of the historian Patrick Fraser Tytler. He died at Reelick in January 1856. Fraser is said to have displayed great skill in water-colours, and several of his drawings have been engraved; and the astronomical observations which he took during some of his journeys did considerable service to the cartography of Asia. The works by which he attained his literary reputation were accounts of his travels and fictitious tales illustrative of Eastern life. In both he employed a vigorous and impassioned style, which was on the whole wonderfully effective in spite of minor faults in taste and flaws in structure.

Fraser's earliest writings are: *Journal of a Tour through Part of the Himala Mountains and to the Sources of the Jumna and the Ganges* (1820); *A Narrative of a Journey into Khorasan in the Years 1821 and 1822, including some Account of the Countries to the North-East of Persia* (1825); and *Travels and Adventures in the Persian Provinces on the Southern Banks of the Caspian Sea* (1826). His romances include *The Kucshibask, a Tale of Khorasan* (1828), and its sequel, *The Persian Adventure* (1830); *Allee Necmroo* (1842); and *The Dark Bazar* (1844). He also wrote *An Historical and Descriptive Account of Persia* (1834); *A Winter's Journey (Titar) from Constantinople to Teheran* (1838); *Travels in Koordistan, Mesopotamia, &c.* (1840); *Mesopotamia and Assyria* (1842); and *Military Memoirs of Col. James Shinner* (1851).

FRASER, SIR WILLIAM AUGUSTUS, Bart. (1826-1898), English politician, author and collector, was born on the 10th of February 1826, the son of Sir James John Fraser, 3rd baronet, a colonel of the 7th Hussars, who had served on Wellington's staff at Waterloo. He was educated at Eton and at Christ Church, Oxford, entered the 1st Life Guards in 1847, but retired with a captain's rank in 1852. He then set about entering parliament, and the ups and downs of his political career were rather remarkable. He was returned for Barnstaple in 1852, but the election was declared void on account of bribery, and the constituency was disfranchised for two years. At the election of 1857 Sir William, who had meantime been defeated at Harwich, was again returned at Barnstaple. He was, however, defeated in 1859, but was elected in 1863 at Ludlow. This seat he held for only two years, when he was again defeated and did not re-enter parliament until 1874, when he was returned for Kidderminster, a constituency he represented for six years, when he retired. He was a familiar figure at the Carlton Club, always ready with a copious collection of anecdotes of Wellington, Disraeli and Napoleon III. He died on the 17th of August 1898. He was an assiduous collector of relics; and his library was sold for some £20,000. His own books comprise *Words on Wellington* (1889), *Disraeli and his Day* (1891), *Hic et Ubique* (1893), *Napoleon III.* (1896) and the *Waterloo Ball* (1897).

FRASER, the chief river of British Columbia, Canada, rising in two branches among the Rocky Mountains near 52° 45' N., 118° 30' W. Length 740 m. It first flows N.W. for about 160 m., then rounds the head of the Cariboo Mountains, and flows directly S. for over 400 m. to Hope, where it again turns abruptly and flows W. for 80 m., falling into the Gulf of Georgia at New Westminster. After the junction of the two forks near its northern extremity, the first important tributary on its southern course is the Stuart, draining Lakes Stuart, Fraser and François. One hundred miles lower down the Quessnel, draining a large lake of the same name, flows in from the east at a town also so named. Farther on the Fraser receives from the west the Chilcotin, and at Lytton, about 180 m. from the sea, the Thompson, its largest tributary, flows in from the east, draining a series of mountain lakes, and receiving at Kamloops the North Thompson, which flows through deep and impassable canyons. Below Hope the Lillooet flows in from the north. The Fraser is a typical mountain stream, rapid and impetuous through all its length, and like most of its tributaries is in many parts not navigable even by canoes. On its southern course between Lytton and Yale, while bursting its way through the Coast Range, it flows through majestic canyons, which, like those of the Thompson, were the scene of many tragedies during the days of the gold-rush to the Cariboo district. At Yale, about 80 m. from its mouth, it becomes navigable, though its course is still very rapid. In the Cariboo district, comprised within the great bend of the river, near Tête Jaune Cache, are many valuable gold deposits. With its tributaries the Fraser drains the whole province from 54° to 49° N., except the extreme south-eastern corner, which is within the basin of the Columbia and its tributary the Kootenay.

FRASERBURGH, a police burgh and seaport, on the N. coast of Aberdeenshire, Scotland. Pop. (1891), 7466; (1901), 9105. It is situated 47½ m. by rail N. of Aberdeen, from which there is a branch line, of which it is the terminus, of the Great North of Scotland railway. It takes its name from Sir Alexander Fraser, the ancestor of Lord Saltoun, whose seat, Philorth House, lies 2 m. to the south. Sir Alexander obtained for it in 1613 a charter as a burgh of royalty, and also in 1592 a charter for the founding of a university. This latter project, however, was not carried out, and all that remains of the building intended for the college is a three-storeyed tower. The old castle of the Frasers on Kinnaird Head now contains a lighthouse, and close by is the Wine Tower, with a cave below. The town cross is a fine structure standing upon a huge hexagon, surmounted by a stone pillar 12 ft. high, ornamented by the royal and Fraser arms. The port is one of the leading stations of the herring fishery in the north of Scotland and the head

of a fishery district. During the herring season (June to September) the population is increased by upwards of 10,000 persons. The fleet numbers more than 700 boats, and the annual value of the catch exceeds £200,000. The harbour, originally constructed as a refuge for British ships of war, is one of the best on the east coast, and has been improved by the widening of the piers and the extension of the breakwaters. It has an area of upwards of eight acres, is easy of access, and affords anchorage for vessels of every size.

FRASERVILLE (formerly Rivière du Loup en Bas), a town and watering-place in Temiscouata county, Quebec, Canada, 107 m. (by water) north-east of Quebec, on the south shore of the St Lawrence river, and at the mouth of the Rivière du Loup, at the junction of the Intercolonial and Temiscouata railways. It contains a convent, boys' college, hospital, several mills, and is a favourite summer resort on account of the angling and shooting, and the magnificent scenery. Pop. (1901) 4569.

FRATER, FRATER HOUSE or FRATERY, a term in architecture for the hall where the members of a monastery or friary met for meals or refreshment. The word is by origin the same as "refectory." The older forms, such as *fratour*, *fraytor* and the like, show the word to be an adaptation of the O.Fr. *fratour*, a shortened form of *refratour*, from the Med. Lat. *refectorium*. The word has been confused with *frater*, a brother or friar, and hence sometimes confined in meaning to the dining-hall of a friary, while "refectory" is used of a monastery.

FRATERNITIES, COLLEGE, a class of student societies peculiar to the colleges and universities of the United States and Canada, with certain common characteristics, and mostly named from two or three letters of the Greek alphabet; hence they are frequently called "Greek Letter Societies." They are organized on the lodge system, and each fraternity comprises a number of affiliated lodges of which only one of any one fraternity is connected with the same institution. The lodges, called "chapters," in memory of the convocations of monks of medieval times, are usually designated by Greek letters also. They are nominally secret, with one exception (*Delta Upsilon*). Each chapter admits members from the lowest or freshman class, and of course loses its members as the students depart from college, consequently each chapter has in it at the same time members of all the four college classes and frequently those pursuing postgraduate studies. Where the attendance at a college is large the material from which fraternity members may be drawn is correspondingly abundant, and in some of the large colleges (e.g. at Cornell University and the University of Michigan) there are chapters of over twenty fraternities. All the fraternities aim to be select and to pick their members from the mass of incoming students. Where, however, the material to select from is not abundant and the rival fraternities are numerous, care in selection is impossible, and the chapters at any one college are apt to secure much the same general type of men. Many of the fraternities have, however, on account of a persistent selection of men of about the same tastes at different colleges, acquired a distinct character and individuality; for instance, *Alpha Delta Phi* is literary.

The first of these fraternities was the *Phi Beta Kappa*, founded at the College of William and Mary at Williamsburg, Virginia, in 1776. It was a little social club of five students: John Heath, Richard Booker, Thomas Smith, Armistead Smith and John Jones. Its badge was a square silver medal displaying the Greek letters of its name and a few symbols. In 1779 it authorized Elisha Parmelee, one of its members, to establish "meetings" or chapters at Yale and Harvard, these chapters being authorized to establish subordinate branches in their respective states. In 1781 the College of William and Mary was closed, its buildings being occupied in turn by the British, French and American troops, and the society ceased to exist. The two branches, however, were established—that at Yale in 1780 and that at Harvard in 1781. Chapters were established at Dartmouth in 1787, at Union in 1817, at Bowdoin in 1824 and at Brown in 1830. This society changed its character in 1826 and became non-secret and purely honorary in character, admitting to membership a

certain proportion of the scholars of highest standing in each class (only in classical courses, usually and with few exceptions only in graduating classes). More recent honorary societies of similar character among schools of science and engineering are *Sigma Xi* and *Tau Beta Pi*.

In 1825, at Union College, *Kappa Alpha* was organized, copying in style of badge, membership restrictions and the like, its predecessor. In 1827 two other similar societies, *Sigma Phi* and *Delta Phi*, were founded at the same place. In 1831 *Sigma Phi* placed a branch at Hamilton College and in 1832 *Alpha Delta Phi* originated there. In 1833 *Psi Upsilon*, a fourth society, was organized at Union. In 1835 *Alpha Delta Phi* placed a chapter at Miami University, and in 1839 *Beta Theta Pi* originated there, and so the system spread. These fraternities, it will be observed, were all undergraduate societies among the male students. In 1910 the total number of men's general fraternities was 32, with 1068 living chapters, and owning property worth many millions of dollars. In 1864 *Theta Xi*, the first professional fraternity restricting its membership to students intending to engage in the same profession, was organized. There were in 1910 about 50 of these organizations with some 400 chapters. In addition there are about 100 local societies or chapters acting as independent units. Some of the older of these, such as *Kappa Kappa Kappa* at Dartmouth, *IKA* at Trinity, *Phi Nu Theta* at Wesleyan and *Delta Psi* at Vermont, are permanent in character, but the majority of them are purely temporary, designed to maintain an organization until the society becomes a chapter of one of the general fraternities. In 1870 the first women's society or "sorority," the *Kappa Alpha Theta*, was organized at De Pauw University. There were in 1910, 17 general sororities with some 300 active chapters.

It is no exaggeration to say that these apparently insignificant organizations of irresponsible students have modified the college life of America and have had a wide influence. Members join in the impressionable years of their youth; they retain for their organizations a peculiar loyalty and affection, and freely contribute with money and influence to their advancement.

Almost universally the members of any particular chapter (or part of them) live together in a lodge or chapter house. The men's fraternities own hundreds of houses and rent as many more. The fraternities form a little aristocracy within the college community. Sometimes the line of separation is invisible, sometimes sharply marked. Sometimes this condition militates against the college discipline and sometimes it assists it. Conflicts not infrequently occur between the fraternity and non-fraternity element in a college.

It can readily be understood how young men living together in the intimate relationship of daily contact in the same house, having much the same tastes, culture and aspirations would form among themselves enduring friendships. In addition each fraternity has a reputation to maintain, and this engenders an esprit du corps which at times places loyalty to fraternity interests above loyalty to college interest or the real advantage of the individual. At commencements and upon other occasions the former members of the chapters return to their chapter houses and help to foster the pride and loyalty of the undergraduates. The chapter houses are commonly owned by corporations made up of the alumni. This brings the undergraduates into contact with men of mature age and often of national fame, who treat their membership as a serious privilege.

The development of this collegiate aristocracy has led to jealousy and bitter animosity among those not selected for membership. Some of the states, notably South Carolina and Arkansas, have by legislation, either abolished the fraternities at state-controlled institutions or seriously limited the privileges of their members. The constitutionality of such legislation has never been tested. Litigation has occasionally arisen out of attempts on the part of college authorities to prohibit the fraternities at their several institutions. This, it has been held, may lawfully be done at a college maintained by private endowment but not at an institution supported by public funds.

the latter case all classes of the public are equally entitled to the same educational privileges and members of the fraternities may not be discriminated against.

The fraternities are admirably organized. The usual system comprises a legislative body made up of delegates from the different chapters and an executive or administrative body elected by the delegates. Few of the fraternities have any judiciary. None is needed. The financial systems are sound, and the conventions of delegates meet in various parts of the United States, several hundred in number, spend thousands of dollars in travel and entertainment, and attract much public attention. Most of the fraternities have an inspection system by which chapters are periodically visited and kept up to a certain level of excellence.

The leading fraternities publish journals usually from four to eight times during the college year. The earliest of these was the *Beta Theta Pi*, first issued in 1872. All publish catalogues of their members and the most prosperous have issued histories. They also publish song books, music and many ephemeral and local publications.

The alumni of the fraternities are organized into clubs or associations having headquarters at centres of population. These organizations are somewhat loose, but nevertheless are capable of much exertion and influence should occasion arise.

The college fraternity system has no parallel among the students of colleges outside of America. One of the curious things about it, however, is that while it is practically uniform throughout the United States, at the three prominent universities of Harvard, Yale and Princeton it differs in many respects from its character elsewhere. At Harvard, although there are chapters of a few of the fraternities, their influence is insignificant, their place being taken by a group of local societies, some of them class organizations. At Yale, the regular system of fraternities obtains in the engineering or technical department (the Sheffield Scientific School), but in the classical department the fraternity chapters are called "junior" societies, because they limit their membership to the three upper classes and allow the juniors each year practically to control the chapter affairs. Certain senior societies, of which the oldest is the Skull and Bones, which are inter-fraternity societies admitting freely members of the fraternities, are more prominent at Yale than the fraternities themselves. Princeton has two (secret) literary and fraternal societies, the American Whig and the Ciosophic, and various local social clubs, with no relationship to organizations in other colleges and not having Greek letter names.

At a few universities (for instance, Michigan, Cornell and Virginia), senior societies or other inter-fraternity societies exert great influence and have modified the strength of the fraternity system.

Of late years, numerous societies bearing Greek names and imitating the externals of the college fraternities have sprung up in the high schools and academies of the country, but have excited the earnest and apparently united opposition of the authorities of such schools.

See William Raimond Baird, *American College Fraternities* (6th ed., New York, 1905); Albert C. Stevens, *Cyclopedia of Fraternities* (Paterson, N. J., 1899); Henry D. Sheldon, *Student Life and Customs* (New York, 1901); Homer L. Patterson, *Paterson's College and School Directory* (Chicago, 1904); H. K. Kellogg, *College Secret Societies* (Chicago, 1874); Albert P. Jacobs, *Greek Letter Societies* (Detroit, 1879). (W. R. B.)

FRATICELLI (plural diminutive of Ital. *frate*, brother), the name given during the 13th, 14th and 15th centuries to a number of religious groups in Italy, differing widely from each other, but all derived more or less directly from the Franciscan movement. Fra Salimbene says in his *Chronicle* (Parma ed., p. 108): "All who wished to found a new rule borrowed something from the Franciscan order, the sandals or the habit." As early as 1238 Gregory IX., in his bull *Quoniam abundavit iniquitas*, condemned and denounced as forgers (*tanquam falsarios*) all who begged or preached in a habit resembling that of the mendicant orders, and this condemnation was repeated by him or his successors. The term Fraticelli was used contemptuously to denote, not any particular sect, but the members of orders formed on the fringe

of the church. Thus Giovanni Villani, speaking of the heretic Dolcino, says in his *Chronicle* (bk. viii. ch. 84): "He is not a brother of an ordered rule, but a *fraticello* without an order." Similarly, John XXII., in his bull *Sacra Romana et Universalis Ecclesie* (28th of December 1317), condemns vaguely those "*profanae multitudinis viri* commonly called Fraticelli, or Brethren of the Poor Life, or Bizocchi, or Beguines, or by all manner of other names."

Some historians, in their zeal for rigid classification, have regarded the Fraticelli as a distinct sect, and have attempted to discover its dogmas and its founder. Some of the contemporaries of these religious groups fell into the same error, and in this way the vague term Fraticelli has sometimes been applied to the disciples of Armano Pongilupo of Ferrara (d. 1269), who was undoubtedly a Cathar, and to the followers of Gerard Segarelli and Dolcino, who were always known among themselves as Apostolic Brethren (Apostolici). Furthermore, it seems absurd to classify both the Dolcinists and the Spiritual Franciscans as Fraticelli, since, as has been pointed out by Ehrle (*Arch.-f. Lit. u. Kirchengesch. des Mittelalters*, ii. 107, &c.), Angelo of Clarino, in his *De septem tribulationibus*, written to the glory of the Spirituals, does not scruple to stigmatize the Dolcinists as "disciples of the devil." It is equally absurd to include in the same category the ignorant Bizocchi and Segarellists and such learned disciples of Michael of Cesena and Louis of Bavaria as William of Occam and Bonagratia of Bergamo, who have often been placed under this comprehensive rubric.

The name Fraticelli may more justly be applied to the most exalted fraction of Franciscanism. In 1322 some prisoners declared to the inquisitor Bernard Gui at Toulouse that the Franciscan order was divided into three sections—the Conventuals, who were allowed to retain their real and personal property; the Spirituals or Beguines, who were at that time the objects of persecution; and the Fraticelli of Sicily, whose leader was Henry of Ceva (see Gui's *Practica Inquisitionis*, v.). It is this fraction of the order which John XXII. condemned in his bull *Gloriosam Ecclesiam* (23rd of January 1318), but without calling them Fraticelli. Henry of Ceva had taken refuge in Sicily at the time of Pope Boniface VIII.'s persecution of the Spirituals, and thanks to the good offices of Frederick of Sicily, a little colony of Franciscans who rejected all property had soon established itself in the island. Under Pope Clement V., and more especially under Pope John XXII., fresh Spirituals joined them; and this group of exalted and isolated ascetics soon began to regard itself as the sole legitimate order of the Minorites and then as the sole Catholic Church. After being excommunicated as "schismatics and rebels, founders of a superstitious sect, and propagators of false and pestiferous doctrines," they proceeded to elect a general (for Michael of Cesena had disavowed them) and then a pope called Celestine (L. Wadding, *Annales*, at date 1313). The rebels continued to carry on an active propaganda. In Tuscany particularly the Inquisition made persistent efforts to suppress them; Florence afflicted them with severe laws, but failed to rouse the populace against them. The papacy dreaded their social even more than their dogmatic influence. At first in Sicily and afterwards throughout Italy the Ghibellines gave them a warm welcome; the rigorists and the malcontents who had either left the church or were on the point of leaving it, were attracted by these communities of needy rebels; and the tribune Rienzi was at one time disposed to join them. To overcome these ascetics it was necessary to have recourse to other ascetics, and from the outset the reformed Franciscans, or Franciscans of the Strict Observance, under the direction of their first leaders, Paoluccio da Trinci (d. 1390), Giovanni Stronconi (d. 1405), and St. Bernardine of Siena, had been at great pains to restore the Fraticelli to orthodoxy. These early efforts, however, had little success. Alarmed by the number of the sectaries and the extent of their influence, Pope Martin V., who had encouraged the Observants, and particularly Bernardine of Siena, fulminated two bulls (1418 and 1421) against the heretics, and entrusted different legates with the task of hunting them down. These measures failing, he decided, in

1426, to appoint two Observants as inquisitors without territorial limitation to make a special crusade against the heresy of the Fraticelli. These two inquisitors, who pursued their duties under three popes (Martin V., Eugenius IV. and Nicholas V.) were Giovanni da Capistrano and Giacomo della Marca. The latter's valuable *Dialogus contra Fraticellos* (Baluze and Mansi, *Miscellanea*, iv. 595-610) gives an account of the doctrines of these heretics and of the activity of the two inquisitors, and shows that the Fraticelli not only constituted a distinct church but a distinct society. They had a pope called Rinaldo, who was elected in 1429 and was succeeded by a brother named Gabriel. This supreme head of their church they styled "bishop of Philadelphia," Philadelphia being the mystic name of their community; under him were bishops, e.g. the bishops of Florence, Venice, &c.; and, furthermore, a member of the community named Guglielmo Majoretto bore the title of "Emperor of the Christians." This organization, at least in so far as concerns the heretical church, had already been observed among the Fraticelli in Sicily, and in 1423 the general council of Siena affirmed with horror that at Peniscola there was an heretical pope surrounded with a college of cardinals who made no attempt at concealment. From 1426 to 1449 the Fraticelli were unremittingly pursued, imprisoned and burned. The sect gradually died out after losing the protection of the common people, whose sympathy was now transferred to the austere Observants and their miracle-worker Capistrano. From 1466 to 1471 there were sporadic burnings of Fraticelli, and in 1471 Tommaso di Scarlino was sent to Piombino and the littoral of Tuscany to track out some Fraticelli who had been discovered in those parts. After that date the name disappears from history.

See F. Ehrle, "Die Spirituellen, ihr Verhältnis zum Franziskanerorden und zu den Fraticellen" and "Zur Vorgeschichte des Concils von Vienne," in *Archiv für Literatur- und Kirchengeschichte des Mittelalters*, vols. i., ii., iii.; Wetzler and Welte, *Kirchenlexikon*, s.v. "Fraticellen"; H. C. Lea, *History of the Inquisition of the Middle Ages*, iii. 129-180 (London, 1888). (P. A.)

FRAUD (Lat. *fraus*, deceit), in its widest sense, a term which has never been exhaustively defined by an English court of law, and for legal purposes probably cannot usefully be defined. But as denoting a cause of action for which damages can be recovered in civil proceedings it now has a clear and settled meaning. In actions in which damages are claimed for fraud, the difficulties and obscurities which commonly arise are due rather to the complexity of modern commerce and the ingenuity of modern swindlers than to any uncertainty or technicality in the modern law. To succeed in such an action, the person aggrieved must first prove a representation of fact, made either by words, by writing or by conduct, which is in fact untrue. Mere concealment is not actionable unless it amounts not only to *suppressio veri*, but to *suggestio falsi*. An expression of opinion or of intention is not enough, unless it can be shown that the opinion was not really held, or that the intention was not really entertained, in which case it must be borne in mind, to use the phrase of Lord Bowen, that the state of a man's mind is as much a matter of fact as the state of his digestion. Next, it must be proved that the representation was made without any honest belief in its truth, that is, either with actual knowledge of its falsity or with a reckless disregard whether it is true or false. It was finally established, after much controversy, in the case of *Derry v. Peck* in 1889, that a merely negligent misstatement is not actionable. Further, the person aggrieved must prove that the offender made the representation with the intention that he should act on it, though not necessarily directly to him, and that he did in fact act in reliance on it. Lastly, the complainant must prove that, as the direct consequence, he has suffered actual damage capable of pecuniary measurement.

As soon as the case of *Derry v. Peck* had established, as the general rule of law, that a merely negligent misstatement is not actionable, a statutory exception was made to the rule in the case of directors and promoters of companies who publish prospectuses and similar documents. By the Directors' Liability Act 1890, such persons are liable for damage caused by untrue statements in such documents, unless they can prove that they

had reasonable grounds for believing the statements to be true. It is also to be observed that, though damages cannot be recovered in an action for a misrepresentation made with an honest belief in its truth, still any person induced to enter into a contract by a misrepresentation, whether fraudulent or innocent, is entitled to avoid the contract and to obtain a declaration that it is not binding upon him. This is in accordance with the rule of equity, which since the Judicature Act prevails in all the courts. Whether the representation is fraudulent or innocent, the contract is not void, but voidable. The party misled must exercise his option to avoid the contract without delay, and before it has become impossible to restore the other party to the position in which he stood before the contract was made. If he is too late, he can only rely on his claim for damages, and in order to assert this claim it is necessary to prove that the misrepresentation was fraudulent. Fraud, in its wider sense of dishonest dealing, though not a distinct cause of action, is often material as preventing the acquisition of a right, for which good faith is a necessary condition. Also a combination or conspiracy by two or more persons to defraud gives rise to liabilities not very clearly or completely defined.

FRAUENBURG, a town of Germany, in the kingdom of Prussia, on the Frische Haflf, at the mouth of the Bande, 41 m. S.W. from Königsberg on the railway to Elbing. Pop. 2500. The cathedral (founded 1209), with six towers, stands on a commanding eminence adjoining the town and surrounded by castellated walls and bastions. This is known as Dom-Frauenburg, and is the seat of the Roman Catholic bishop of Ermeland. Within the cathedral is a monument to the astronomer Copernicus bearing the inscription *Astronomo celeberrimo, cujus nomen et gloria utrumque implent orbem*. There is a small port with inconsiderable trade. Frauenberg was founded in 1287 and received the rights of a town in 1310.

FRAUENFELD, the capital of the Swiss canton of Thurgau, 27 m. by rail N.E. of Zürich or 14½ m. W. of Romanshorn. It is built on the Murg stream a little above its junction with the Thur. It is a prosperous commercial town, being situated at the meeting point of several routes, while it possesses several industrial establishments, chiefly concerned with different branches of the iron trade. In 1900 its population (including the neighbouring villages) was 7761, mainly German-speaking, while there were 5563 Protestants to 2188 Romanists. Frauenfeld is the artillery depot for North-East Switzerland. The upper town is the older part, and centres round the castle, of which the tower dates from the 10th century, though the rest is of a later period. Both stood on land belonging to the abbot of Reichenau, who, with the count of Kyburg, founded the town, which is first mentioned in 1255. The abbot retained all manorial rights till 1803, while the political powers of the Kyburgers (who were the "protectors" of Reichenau) passed to the Habsburgs in 1273, and were seized by the Swiss in 1460 with the rest of the Thurgau. In 1712 the town succeeded Baden in Aargau as the meeting-place of the Federal Diet, and continued to be the capital of the Confederation till its transformation in 1798. In 1799 it was successively occupied by the Austrians and the French. The old Capuchin convent (1591-1848) is now occupied as a vicarage by the Romanist priest. (W. A. B. C.)

FRAUENLOB, the name by which HEINRICH VON MEISSER, a German poet of the 13th century, is generally known. He seems to have acquired the sobriquet because in a famous *Liederstreit* with his rival Regenbogen he defended the use of the word *Frau* (i.e. *fronae*, = lady) instead of *Weib* (*weip* = woman). Frauenlob was born about 1250 of a humble burgher family. His youth was spent in straitened circumstances, but he gradually acquired a reputation as a singer at the various courts of the German princes. In 1278 we find him with Rudolph I. in the Marchfeld, in 1286 he was at Prague at the knightly festival celebrated by Waldemar of Brandenburg before Rostock. After this he settled in Mainz, and there according to the popular account, founded the first school of Meistersingers (q.v.). He died in 1318, and was buried in the cloisters of the cathedral at

Mainz. His grave is still marked by a copy made in 1783 of the original tombstone of 1318; and in 1842 a monument by Schwanthaler was erected in the cloisters. Frauenlob's poems make a great display of learning; he delights in far-fetched metaphors, and his versification abounds in tricks of form and rhyme.

Frauenlob's poetry was edited by L. Ettmüller in 1843; a selection will be found in K. Bartsch, *Deutsche Liederdichter des 12. bis 14. Jahrhunderts* (3rd ed., 1893). An English translation of Frauenlob's *Cantica canticorum*, by A. E. Kroeger, with notes, appeared in 1877 at St. Louis, U.S.A. See A. Boetkel, *Frauenlob* (2nd ed., 1881).

FRAUNCE, ABRAHAM (c. 1558-1633), English poet, a native of Shropshire, was born between 1558 and 1560. His name was registered as a pupil of Shrewsbury School in January 1571/2, and he joined St John's College, Cambridge, in 1576, becoming a fellow in 1580/81. His Latin comedy of *Victoria*, dedicated to Sidney, was probably written at Cambridge, where he remained until he had taken his M.A. degree in 1583. He was called to the bar at Gray's Inn in 1588, and then apparently practised as a barrister in the court of the Welsh marches. After the death of his patron Sir Philip Sidney, Fraunce was protected by Sidney's sister Mary, countess of Pembroke. His last work was published in 1592, and we have no further knowledge of him until 1633, when he is said to have written an *Epithalamium* in honour of the marriage of Lady Magdalen Egerton, 7th daughter of the earl of Bridgwater, whose service he may possibly have entered.

His works are: *The Lamentations of Amintás for the death of Phyllis* (1587), a version in English hexameters of his friend's, Thomas Watson's, Latin *Amyntas*; *The Lawiers Logike, exemplifying the precepts of Logike by the practise of the common Lawe* (1588); *Arcadian Rhetorike* (1588); *Abrahami Fransi Iustissimus, Armorum... explicatio* (1588); *The Countess of Pembroke's Iyvychurch* (1591/2), containing a translation of Tasso's *Aminta*, a reprint of his earlier version of Watson, "The Lamentation of Corydon for the love of Alexis" (Virgil, *eclogue ii.*), a short translation from Heliodorus, and, in the third part (1592) "Amintás's Dale," a collection of "conceited" tales supposed to be related by the nymphs of Ivychurch; *The Countess of Pembroke's Emanuell* (1591); *The Third Part of the Countess of Pembroke's Iyvychurch, entitled Amintás's Dale* (1592). His *Arcadian Rhetorike* owes much to earlier critical treatises, but has a special interest from its references to Spenser, and Fraunce quotes from the *Faerie Queene* a year before the publication of the first books. In "Colin Clout's come home again," Spenser speaks of Fraunce as Corydon, on account of his translations of Virgil's second *eclogue*. His poems are written in classical metres, and he was regarded by his contemporaries as the best exponent of Gabriel Harvey's theory. Even Thomas Nashe had a good word for "sweete Master Fraunce."

The Countess of Pembroke's Emanuell, hexameters on the nativity and passion of Christ, with versions of some psalms, were reprinted by Dr A. B. Grosart in the third volume of his *Miscellanies of the Fuller Worthies Library* (1872). Joseph Hunter in his *Chorus Vaticanum* stated that five of Fraunce's songs were included in Sidney's *Astrophel and Stella*, but it is probable that these should be attributed not to Fraunce, but to Thomas Campion. See a life prefixed to the transcription of a MS. Latin comedy by Fraunce, *Victoria*, by Professor G. C. Moore Smith, published in Bang's *Materialien zur Kunde des älteren englischen Dramas*, vol. xiv., 1906.

FRAUNHOFER, JOSEPH VON (1787-1826), German optician and physicist, was born at Straubing in Bavaria on the 6th of March 1787, the son of a glazier who died in 1798. He was apprenticed in 1799 to Weichselberger, a glass-polisher and looking-glass maker. On the 21st of July 1801 he nearly lost his life by the fall of the house in which he lodged, and the elector of Bavaria, Maximilian Joseph, who was present at his extrication from the ruins, gave him 18 ducats. With a portion of this sum he obtained release from the last six months of his apprenticeship, and with the rest he purchased a glass-polishing machine. He now employed himself in making optical glasses, and in engraving on metal, devoting his spare time to the perusal of works on mathematics and optics. In 1806 he obtained the place of optician in the mathematical institute which in 1804 had been founded at Munich by Joseph von Utzschneider, G. Reichenbach and J. Liebherr; and in 1807 arrangements were made by

Utzschneider for his instruction by Pierre Louis Guinand, a skilled optician, in the fabrication of flint and crown glass, in which he soon became an adept (see R. Wolf, *Gesch. der Wissensch. in Deutschl.* bd. xvi. p. 586). With Reichenbach and Utzschneider, Fraunhofer established in 1809 an optical institute at Benedictbeuern, near Munich, of which he in 1818 became sole manager. The institute was in 1810 removed to Munich, and on Fraunhofer's death came under the direction of G. Merz.

Amongst the earliest mechanical contrivances of Fraunhofer was a machine for polishing mathematically uniform spherical surfaces. He was the inventor of the stage-micrometer, and of a form of heliometer; and in 1816 he succeeded in constructing for the microscope achromatic glasses of long focus, consisting of a single lens, the constituent glasses of which were in juxtaposition, but not cemented together. The great reflecting telescope at Dorpat was manufactured by him, and so great was the skill he attained in the making of lenses for achromatic telescopes that, in a letter to Sir David Brewster, he expressed his willingness to furnish an achromatic glass of 18 in. diameter. Fraunhofer is especially known for the researches, published in the *Denkschriften der Münchener Akademie* for 1814-1815, by which he laid the foundation of solar and stellar chemistry. The dark lines of the spectrum of sunlight, earliest noted by Dr W. H. Wollaston (*Phil. Trans.*, 1802, p. 378), were independently discovered, and, by means of the telescope of a theodolite, between which and a distant slit admitting the light a prism was interposed, were for the first time carefully observed by Fraunhofer, and have on that account been designated "Fraunhofer's lines." He constructed a map of as many as 576 of these lines, the principal of which he denoted by the letters of the alphabet from A to G; and by ascertaining their refractive indices he determined that their relative positions are constant, whether in spectra produced by the direct rays of the sun, or by the reflected light of the moon and planets. The spectra of the stars he obtained by using, outside the object-glass of his telescope, a large prism, through which the light passed to be brought to a focus in front of the eye-piece. He showed that in the spectra of the fixed stars many of the dark lines were different from those of the solar spectrum, whilst other well-known solar lines were wanting; and he concluded that it was not by any action of the terrestrial atmosphere upon the light passing through it that the lines were produced. He further expressed the belief that the dark lines D of the solar spectrum coincide with the bright lines of the sodium flame. He was also the inventor of the diffraction grating.

In 1823 he was appointed conservator of the physical cabinet at Munich, and in the following year he received from the king of Bavaria the civil order of merit. He died at Munich on the 7th of June 1826, and was buried near Reichenbach, whose decease had taken place eight years previously. On his tomb is the inscription "Approximavit sidera."

See J. von Utzschneider, *Kurzer Umriss der Lebensgeschichte des Herrn Dr J. von Fraunhofer* (Munich, 1826); and G. Merz, *Das Leben und Wirken Fraunhofers* (Landshut, 1865).

FRAUSTADT (Polish, *Wssnowa*), a town of Germany, in the Prussian province of Posen, in a flat sandy country dotted with windmills, 50 m. S.S.W. of Posen, on the railway Lissa-Sagan. Pop. (including a garrison) 7500. It has three Evangelical and two Roman Catholic churches, a classical school and a teachers' seminary; the manufactures include woolen and cotton goods, hats, morocco leather and gloves, and there is a considerable trade in corn, cattle and wool. Fraustadt was founded by Silesians in 1348, and afterwards belonged to the principality of Glogau. Near the town the Swedes under Charles XII. defeated the Saxons on the 13th of February 1706.

FRAYSSINOUS, DENIS ANTOINE LUC, COMTE DE (1765-1841), French prelate and statesman, distinguished as an orator and as a controversial writer, was born of humble parentage at Curières, in the department of Aveyron, on the 9th of May 1765. He owes his reputation mainly to the lectures on dogmatic theology, known as the "conferences" of Saint Sulpice, delivered in the church of Saint Sulpice, Paris, from 1803 to

1806, to which admiring crowds were attracted by his lucid exposition and by his graceful oratory. The freedom of his language in 1809, when Napoleon had arrested the pope and declared the annexation of Rome to France, led to a prohibition of his lectures; and the dispersion of the congregation of Saint Sulpice in 1811 was followed by his temporary retirement from the capital. He returned with the Bourbons, and resumed his lectures in 1814; but the events of the Hundred Days again compelled him to withdraw into private life, from which he did not emerge until February 1816. As court preacher and almoner to Louis XVIII., he now entered upon the period of his greatest public activity and influence. In connexion with the controversy raised by the signing of the reactionary concordat of 1817, he published in 1818 a treatise entitled *Vrais Principes de l'église Gallicane sur la puissance ecclésiastique*, which though unfavourably criticized by Lamennais, was received with favour by the civil and ecclesiastical authorities. The consecration of Frayssinous as bishop of Hermopolis "in partibus," his election to the French Academy, and his appointment to the grand-mastership of the university, followed in rapid succession. In 1824, on the accession of Charles X., he became minister of public instruction and of ecclesiastical affairs under the administration of Villèle; and about the same time he was created a peer of France with the title of count. His term of office was chiefly marked by the recall of the Jesuits. In 1825 he published his lectures under the title *Défense du christianisme*. The work passed through 15 editions within 18 years, and was translated into several European languages. In 1828 he, along with his colleagues in the Villèle ministry, was compelled to resign office, and the subsequent revolution of July 1830 led to his retirement to Rome. Shortly afterwards he became tutor to the duke of Bordeaux (Comte de Chambord) at Prague, where he continued to live until 1838. He died at St Genez on the 12th of December 1841.

See Bertrand, *Bibl. Sulpicienne* (t. ii. 135 sq.; iii. 253) for bibliography, and G. A. Henrion (Paris, 2 vols., 1844) for biography.

FRÉCHETTE, LOUIS HONORÉ (1839-1908), French-Canadian poet, was born at Levis, Quebec, on the 16th of November 1839, the son of a contractor. He was educated in his native province, and called to the Canadian bar in 1864. He started the *Journal de Lévis*, and his revolutionary doctrines compelled him to leave Canada for the United States. After some years spent in journalism at Chicago, he was in 1874 elected as the Liberal candidate to represent Levis in the Canadian parliament. At the elections of 1878 and 1882 he was defeated, and thereafter confined himself to literature. He edited *La Patrie* and other French papers in the Dominion; and in 1889 was appointed clerk of the Quebec legislative council. He was long a warm advocate of the political union of Canada and the United States, but in later life became less ardent, and in 1897 accepted the honour of C.M.G. from Queen Victoria. He was president of the Royal Society of Canada, and of the Canadian Society of Arts, and received numerous honorary degrees. His works include: *Mes Loisirs* (1863); *La Voix d'un exilé* (1867), a satire against the Canadian government; *Pêle-mêle* (1877); *Les Fleurs boréales*, and *Les Oiseaux de neige* (1880), crowned by the French academy; *La Légende d'un peuple* (1887); two historical dramas, *Papineau* (1886) and *Felix Ponté* (1886); *La Noël au Canada* (1900), and several prose works and translations. An exponent of local French sentiment, he won the title of the "Canadian Laureate." He died on the 1st of June 1908.

FREDEGOND (*Fredigundis*) (d. 597), Frankish queen. Originally a serving-woman, she inspired the Frankish king, Chilperic I., with a violent passion. At her instigation he repudiated his first wife Audovera, and strangled his second, Galswintha, Queen Brunhilda's sister. A few days after this murder Chilperic married Fredegond (567). This woman exercised a most pernicious influence over him. She forced him into war against Austrasia, in the course of which she procured the assassination of the victorious king Sigebert (575); she carried on a malignant struggle against Chilperic's sons by his first wife, Theodebert, Merwich and Clovis, who all died tragic deaths; and she per-

sistently endeavoured to secure the throne for her own children. Her first son Thierry, however, to whom Bishop Ragnemod of Paris stood godfather, died soon after birth, and Fredegond tortured a number of women whom she accused of having bewitched the child. Her second son also died in infancy. Finally, she gave birth to a child who afterwards became king as Clotaire II. Shortly after the birth of this third son, Chilperic himself perished in mysterious circumstances (584). Fredegond has been accused of complicity in his murder, but with little show of probability, since in her husband she lost her principal supporter.

Henceforth Fredegond did all in her power to gain the kingdom for her child. Taking refuge at the church of Notre Dame at Paris, she appealed to King Guntram of Burgundy, who took Clotaire under his protection and defended him against his other nephew, Childebert II., king of Austrasia. From that time until her death Fredegond governed the western kingdom. She endeavoured to prevent the alliance between King Guntram and Childebert, which was cemented by the pact of Andelot; and made several attempts to assassinate Childebert by sending against him hired braves armed with poisoned *scramasaxes* (heavy single-edged knives). After the death of Childebert in 595 she resolved to augment the kingdom of Neustria at the expense of Austrasia; and to this end seized some cities near Paris and defeated Theodebert at the battle of Laffaux, near Soissons. Her triumph, however, was short-lived, as she died quietly in her bed in 597 soon after her victory.

See V. N. Augustin Thierry, *Récits des temps mérovingiens* (Brussels, 1840); Ulysse Chevalier, *Bio-bibliographie* (2nd ed.), s.v. "Frédégonde." (C. Fr.)

FREDERIC, HAROLD (1856-1898), Anglo-American novelist, was born on the 19th of August 1856 at Utica, N.Y., was educated there, and took to journalism. He went to live in England as London correspondent of the *New York Times* in 1884, and was soon recognized for his ability both as a writer and as a talker. He wrote several clever early stories; but it was not till he published *Illumination* (1896), followed by *Gloria Mundi* (1898), that his remarkable gifts as a novelist were fully realized. He died in England on the 19th of October 1898.

FREDERICIA (**FREDERICIA**), a seaport of Denmark, near the S.E. corner of Jutland, on the west shore of the Little Belt opposite the island of Fünen. Pop. (1901) 12,714. It has railway communication with both south and north, and a steam ferry connects with Middelfart, a seaside resort and railway station on Fünen. There is a considerable shipping trade, and the industries comprise the manufacture of tobacco, salt and chitroy, and of cotton goods and hats. A small fort was erected on the site of Fredericia by Christian IV. of Denmark, and his successor, Frederick III., determined about 1650 to make it a powerful fortress. Free exercise of religion was offered to all who should settle in the new town, which at first bore the name of Frederiksodde, and only received its present designation in 1664. In 1657 it was taken by storm by the Swedish general Wrangel, and in 1659, after the fortress had been dismantled, it was occupied by Frederick William of Brandenburg. It was not till 1709-1710 that the works were again put in a state of defence. In 1848 no attempt was made by the Danes to oppose the Prussians, who entered on the 2nd of May, and maintained their position against the Danish gunboats. During the armistice of 1848-1849 the fortress was strengthened, and soon afterwards it stood a siege of two months, which was brought to a glorious close by a successful sortie on the 6th of July 1849. In memory of the victory several monuments have been erected in the town and its vicinity, of which the most noticeable are the bronze statue of the Danish Land Soldier by Bissen (one of Thorvaldsen's pupils), and the great barrow over 500 Danes in the cemetery of the Holy Trinity Church, with a bas-relief by the same sculptor. On the outbreak of the war of 1864, the fortress was again strengthened by new works and an entrenched camp; but the Danes suddenly evacuated it on the 28th of April after a siege of six weeks. The Austro-Prussian army promptly destroyed the fortifications, and kept possession of the town till the conclusion of peace.

FREDERICK (Mod. Ger. *Friedrich*; Ital. *Federigo*; Fr. *Frédéric* and *Fédéric*; M.H.G. *Fridrich*; O.H.G. *Fridurth*, "king or lord of peace," from O.H.G. *fridu*, A.S. *frith*, "peace," and *rih* "rich," "a ruler," for derivation of which see HENRY), a Christian name borne by many European sovereigns and princes, the more important of whom are given below in the following order:—(1) Roman emperors and German kings; (2) other kings in the alphabetical order of their states; (3) other reigning princes in the same order.

FREDERICK I. (c. 1123—1190), Roman emperor, surnamed "Barbarossa" by the Italians, was the son of Frederick II. of Hohenstaufen, duke of Swabia, and Judith, daughter of Henry IX. the Black, duke of Bavaria. The precise date and place of his birth, together with details of his early life, are wanting; but in 1143 he assisted his maternal uncle, Count Welf VI., in his attempts to conquer Bavaria, and by his conduct in several local feuds earned the reputation of a brave and skillful warrior. When his father died in 1147 Frederick became duke of Swabia, and immediately afterwards accompanied his uncle, the German king Conrad III., on his disastrous crusade, during which he greatly distinguished himself and won the complete confidence of the king. Abandoning the cause of the Welfs, he fought for Conrad against them, and in 1152 the dying king advised the princes to choose Frederick as his successor to the exclusion of his own young son. Energetically pressing his candidature, he was chosen German king at Frankfort on the 4th or 5th of March 1152, and crowned at Aix-la-Chapelle on the 9th of the same month, owing his election partly to his personal qualities, and partly to the fact that he united in himself the blood of the rival families of Welf and Waiblingen.

The new king was anxious to restore the Empire to the position it had occupied under Charlemagne and Otto the Great, and saw clearly that the restoration of order in Germany was a necessary preliminary to the enforcement of the imperial rights in Italy. Issuing a general order for peace, he was prodigal in his concessions to the nobles. Count Welf was made duke of Spoleto and margrave of Tuscany; Berthold VI., duke of Zähringen, was entrusted with extensive rights in Burgundy; and the king's nephew, Frederick, received the duchy of Swabia. Abroad Frederick decided a quarrel for the Danish throne in favour of Swend, or Peter as he is sometimes called, who did homage for his kingdom, and negotiations were begun with the East Roman emperor, Manuel Comnenus. It was probably about this time that the king obtained a divorce from his wife Adela, daughter of Dietpold, margrave of Volburg and Cham, on the ground of consanguinity, and made a vain effort to obtain a bride from the court of Constantinople. On his accession Frederick had communicated the news of his election to Pope Eugenius III., but neglected to ask for the papal confirmation. In spite of this omission, however, and of some trouble arising from a double election to the archbishopric of Magdeburg, a treaty was concluded between king and pope at Constance in March 1153, by which Frederick promised in return for his coronation to make peace with Roger I. king of Sicily, or with the rebellious Romans, without the consent of Eugenius, and generally to help and defend the papacy.

The journey to Italy made by the king in 1154 was the precursor of five other expeditions which engaged his main energies for thirty years, during which the subjugation of the peninsula was the central and abiding aim of his policy. Meeting the new pope, Adrian IV., near Nepi, Frederick at first refused to hold his stirrup; but after some negotiations he consented and received the kiss of peace, which was followed by his coronation as emperor at Rome on the 18th of June 1155. As his slender forces were inadequate to encounter the fierce hostility which he aroused, he left Italy in the autumn of 1155 to prepare for a new and more formidable campaign. Disorder was again rampant in Germany, especially in Bavaria, but general peace was restored by Frederick's vigorous measures. Bavaria was transferred from Henry II. Jasomirgott, margrave of Austria, to Henry the Lion, duke of Saxony; and the former was pacified by the section of his margraviate into a duchy, while Frederick's

step-brother Conrad was invested with the Palatinate of the Rhine. On the 9th of June 1156 the king was married at Würzburg to Beatrix, daughter and heiress of the dead count of Upper Burgundy, Renaud III., when Upper Burgundy or Franche Comté, as it is sometimes called, was added to his possessions. An expedition into Poland reduced Duke Boleslaus IV. to an abject submission, after which Frederick received the homage of the Burgundian nobles at a diet held at Besançon in October 1157, which was marked by a quarrel between pope and emperor. A Swedish archbishop, returning from Rome, had been seized by robbers, and as Frederick had not punished the offenders Adrian sent two legates to remonstrate. The papal letter when translated referred to the imperial crown as a benefice conferred by the pope, and its reading aroused great indignation. The emperor had to protect the legates from the fury of the nobles; and afterwards issued a manifesto to his subjects declaring that he held the Empire from God alone, to which Adrian replied that he had used the ambiguous word *beneficia* as meaning benefits, and not in its feudal sense.

In June 1158 Frederick set out upon his second Italian expedition, which was signalized by the establishment of imperial officers called *podestats* in the cities of northern Italy, the revolt and capture of Milan, and the beginning of the long struggle with pope Alexander III., who excommunicated the emperor on the 2nd of March 1160. During this visit Frederick summoned the doctors of Bologna to the diet held near Roncaglia in November 1158, and as a result of their inquiries into the rights belonging to the kingdom of Italy he obtained a large amount of wealth. Returning to Germany towards the close of 1162, Frederick prevented a conflict between Henry the Lion, duke of Saxony, and a number of neighbouring princes, and severely punished the citizens of Mainz for their rebellion against Archbishop Arnold. A further visit to Italy in 1163 saw his plans for the conquest of Sicily checked by the formation of a powerful league against him, brought together mainly by the exactions of the *podestats* and the enforcement of the rights declared by the doctors of Bologna. Frederick had supported an anti-pope Victor IV. against Alexander, and on Victor's death in 1163 a new anti-pope called Paschal III. was chosen to succeed him. Having tried in vain to secure the general recognition of Victor and Paschal in Europe, the emperor held a diet at Würzburg in May 1165; and by taking an oath, followed by many of the clergy and nobles, to remain true to Paschal and his successors, brought about a schism in the German church. A temporary alliance with Henry II., king of England, the magnificent celebration of the canonization of Charlemagne at Aix-la-Chapelle, and the restoration of peace in the Rhineland, occupied Frederick's attention until October 1166, when he made his fourth journey to Italy. Having captured Ancona, he marched to Rome, stormed the Leonine city, and procured the entrenchment of Paschal, and the coronation of his wife Beatrix; but his victorious career was stopped by the sudden outbreak of a pestilence which destroyed the German army and drove the emperor as a fugitive to Germany, where he remained for the ensuing six years. Henry the Lion was again saved from a threatening combination; conflicting claims to various bishoprics were decided; and the imperial authority was asserted over Bohemia, Poland and Hungary. Friendly relations were entered into with the emperor Manuel, and attempts made to come to a better understanding with Henry II., king of England, and Louis VII., king of France.

In 1174, when Frederick made his fifth expedition to Italy, the Lombard league had been formed, and the fortress of Alessandria raised to check his progress. The campaign was a complete failure. The refusal of Henry the Lion to bring help into Italy was followed by the defeat of the emperor at Legnano on the 29th of May 1176, when he was wounded and believed to be dead. Reaching Pavia, he began negotiations for peace with Alexander, which ripened into the treaty of Venice in August 1177, and at the same time a truce with the Lombard league was arranged for six years. Frederick, loosed from the papal ban, recognized Alexander as the rightful pope, and in July 1177 knelt before him and kissed his feet. The possession of the vast

estates left by Matilda, marchioness of Tuscany, and claimed by both pope and emperor, was to be decided by arbitration, and in October 1178 the emperor was again in Germany. Various small feuds were suppressed; Henry the Lion was deprived of his duchy, which was dismembered, and sent into exile; a treaty was made with the Lombard league at Constance in June 1183; and most important of all, Frederick's son Henry was betrothed in 1184 to Constance, daughter of Roger I., king of Sicily, and aunt and heiress of the reigning king, William II. This betrothal, which threatened to unite Sicily with the Empire, made it difficult for Frederick, when during his last Italian expedition in 1184 he met Pope Lucius III. at Verona, to establish friendly relations with the papacy. Further causes of trouble arose, moreover, and when the potentates separated the question of Matilda's estates was undecided; and Lucius had refused to crown Henry or to recognize the German clergy who had been ordained during the schism. Frederick then formed an alliance with Milan, where the citizens witnessed a great festival on the 27th of January 1186. The emperor, who had been crowned king of Burgundy, or Arles, at Arles on the 30th of July 1178, had this ceremony repeated; while his son Henry was crowned king of Italy and married to Constance, who was crowned queen of Germany.

The quarrel with the papacy was continued with the new pope Urban III., and open warfare was begun. But Frederick was soon recalled to Germany by the news of a revolt raised by Philip of Heinsberg, archbishop of Cologne, in alliance with the pope. The German clergy remained loyal to the emperor, and hostilities were checked by the death of Urban and the election of a new pope as Gregory VIII., who adopted a more friendly policy towards the emperor. In 1188 Philip submitted, and immediately afterwards Frederick took the cross in order to stop the victorious career of Saladin, who had just taken Jerusalem. After extensive preparations he left Regensburg in May 1189 at the head of a splendid army, and having overcome the hostility of the East Roman emperor Isaac Angelus, marched into Asia Minor. On the 10th of June 1190 Frederick was either bathing or crossing the river Calycadnus (Geuksu), near Seleucia (Selefke) in Cilicia, when he was carried away by the stream and drowned. The place of his burial is unknown, and the legend which says he still sits in a cavern in the Kyffhäuser mountain in Thuringia waiting until the need of his country shall call him, is now thought to refer, at least in its earlier form, to his grandson, the emperor Frederick II. He left by his wife, Beatrix, five sons, of whom the eldest afterwards became emperor as Henry VI.

Frederick's reign, on the whole, was a happy and prosperous time for Germany. He encouraged the growth of towns, easily suppressed the few risings against his authority, and took strong and successful measures to establish order. Even after the severe reverses which he experienced in Italy, his position in Germany was never seriously weakened; and in 1181, when, almost without striking a blow, he deprived Henry the Lion of his duchy, he seemed stronger than ever. This power rested upon his earnest and commanding personality, and also upon the support which he received from the German church, the possession of a valuable private domain, and the care with which he exacted feudal dues from his dependents.

Frederick I. is said to have taken Charlemagne as his model; but the contest in which he engaged was entirely different both in character and results from that in which his great predecessor achieved such a wonderful temporary success. Though Frederick failed to subdue the republics, the failure can scarcely be said to reflect either on his prudence as a statesman or his skill as a general, for his ascendancy was finally overthrown rather by the ravages of pestilence than by the might of human arms. In Germany his resolute will and sagacious administration subdued or disarmed all discontent, and he not only succeeded in welding the various rival interests into a unity of devotion to himself against which papal intrigues were comparatively powerless, but won for the empire a prestige such as it had not possessed since the time of Otto the Great. The wide contrast between his German and Italian rule is strikingly exemplified in the fact that,

while he endeavoured to overthrow the republics in Italy, he held in check the power of the nobles in Germany, by conferring municipal franchises and independent rights on the principality cities. Even in Italy, though his general course of action was warped by wrong prepossessions, he in many instances manifested exceptional practical sagacity in dealing with immediate difficulties and emergencies. Possessing frank and open manners untiring and unresting energy, and a prowess which found its native element in difficulty and danger, he seemed the embodiment of the chivalrous and warlike spirit of his age, and was the model of all the qualities which then won highest admiration. Stern and ambitious he certainly was, but his aims can scarcely be said to have exceeded his prerogatives as emperor; and though he had sometimes recourse when in straits to expedients almost diabolically ingenious in their cruelty, yet his general conduct was marked by a clemency which in that age was exceptional. His quarrel with the papacy was an inherited conflict, not reflecting at all on his religious faith, but the inevitable consequence of inconsistent theories of government, which had been created and could be dissipated only by a long series of events. His interference in the quarrels of the republics was not only quite justifiable from the relation in which he stood to them, but seemed absolutely necessary. From the beginning, however, he treated the Italians, as indeed was very natural, less as rebellious subjects than as conquered aliens; and it must be admitted that in regard to them the only effective portion of his procedure was, not his energetic measures of repression nor his brilliant victories, but, after the battle of Legnano, his quiet and cheerful acceptance of the inevitable, and the consequent complete change in his policy, by which if he did not obtain the great object of his ambition, he at least did much to render innocuous for the Empire his previous mistakes.

In appearance Frederick was a man of well-proportioned, medium stature, with flowing yellow hair and a reddish beard. He delighted in hunting and the reading of history, was zealous in his attention to public business, and his private life was unimpeachable. Carlyle's tribute to him is interesting: "No king so furnished out with apparatus and arena, with personal faculty to rule and scene to do it in, has appeared elsewhere. A magnificent, magnanimous man; holding the reins of the world, not quite in the imaginary sense; scourging anarchy down, and urging noble effort up, really on a grand scale. A terror to evil-doers and a praise to well-doers in this world, probably beyond what was ever seen since."

The principal contemporary authority for the earlier part of the reign of Frederick is the *Gesta Frederici imperatoris*, mainly the work of Otto, bishop of Freising. This is continued from 1156 to 1166 by Rahewin, a canon of Freising, and from 1166 to 1170 by an anonymous author. The various annals and chronicles of the period, among which may be mentioned the *Chronica regia Coloniensis* and the *Annales Magdeburgenses*, are also important. Other authorities for the different periods in Frederick's reign are Tagam of Passau, *Descriptio expeditionis asiaticae Frederici I.*; Burchard, *Historia Frederici imperatoris magni*; Godfrey of Viterbo, *Carmina de gestis Frederici I.*, which are all found in the *Monumenta Germaniae historica*. *Scriptores* (Hanover and Berlin, 1826-1892); Otto Morena of Lodi, *Historia rerum Laudensium*, continued by his son, Acerbus, also in the *Monumenta*; Ansbert, *Historia de expeditione Frederici, 1187-1196*, published in the *Fonnes rerum Austriacarum*. *Scriptores* (Vienna, 1855 fol.). Many valuable documents are found in the *Monumenta Germaniae selecta*, Band iv., edited by M. Doehring (Munich, 1889-1890).

The best modern authorities are J. Jastrow, *Deutsche Geschichte im Zeitalter der Hohenstaufen* (Berlin, 1893); W. von Giesebrach, *Geschichte der deutschen Kaiserzeit*, Band iv. (Brunswick, 1877); H. von Bünau, *Leben und Thaten Friedrichs I.* (Leipzig, 1872); E. Prutz, *Kaiser Friedrich I.* (Dantzig, 1871-1874); C. Peters, *Die Wahl Kaiser Friedrichs I.* in the *Forschungen zur deutschen Geschichte*, Band xx. (Göttingen, 1862-1886); W. Gundlach, *Barbarossalied* (Innsbruck, 1899). For a complete bibliography see Dahlmann, Waitz, *Quellenkunde der deutschen Geschichte* (Göttingen, 1894), and U. Chevalier, *Répertoire des sources historiques du moyen âge*, tome iii. (Paris, 1904).

FREDERICK II. (1194-1250), Roman emperor, king of Sicily, and Jerusalem, was the son of the emperor Henry VI. and Constance, daughter of Roger I., king of Sicily, and therefore grandson of the emperor Frederick I. and a member of the Hohenstaufen

family. Born at Jesi near Ancona on the 26th of December 1194, he was baptized by the name of Frederick Roger, chosen German king at Frankfort in 1196, and after his father's death crowned king of Sicily at Palermo on the 17th of May 1198. His mother, who assumed the government, died in November 1198, leaving Pope Innocent III. as regent of Sicily and guardian of her son. The young king passed his early years amid the terrible anarchy in his island kingdom, which Innocent was powerless to check; but his education was not neglected, and his character and habits were formed by contact with men of varied nationalities and interests, while the darker traits of his nature were developed in the atmosphere of lawlessness in which he lived. In 1208 he was declared of age, and soon afterwards Innocent arranged a marriage, which was celebrated the following year, between him and Constance, daughter of Alphonso II. king of Aragon, and widow of Emerich or Imre, king of Hungary.

The dissatisfaction felt in Germany with the emperor Otto IV. came to a climax in September 1211, when a number of influential princes met at Nuremberg, declared Otto deposed, and invited Frederick to come and occupy the vacant throne. In spite of the reluctance of his wife, and the opposition of the Sicilian nobles, he accepted the invitation; and having recognized the papal supremacy over Sicily, and procured the coronation of his son Henry as its king, reached Germany after an adventurous journey in the autumn of 1212. This step was taken with the approval of the pope, who was anxious to strike a blow at Otto IV.

Frederick was welcomed in Swabia, and the renown of the Hohenstaufen name and a liberal distribution of promises made his progress easy. Having arranged a treaty against Otto with Louis, son of Philip Augustus, king of France, whom he met at Vincouleurs, he was chosen German king a second time at Frankfort on the 5th of December 1212, and crowned four days later at Mainz. Anxious to retain the support of the pope, Frederick promulgated a bull at Eger on the 12th of July 1213, by which he renounced all lands claimed by the pope since the death of the emperor Henry VI in 1197, gave up the right of spoils and all interference in episcopal elections, and acknowledged the right of appeal to Rome. He again affirmed the papal supremacy over Sicily, and promised to root out heresy in Germany. The victory of his French allies at Bouvines on the 27th of July 1214 greatly strengthened his position, and a large part of the Rhine-land having fallen into his power, he was crowned German king at Aix-la-Chapelle on the 25th of July 1215. His cause continued to prosper, fresh supporters gathered round his standard, and in May 1218 the death of Otto freed him from his rival and left him undisputed ruler of Germany. A further attempt to allay the pope's apprehension lest Sicily should be united with the Empire had been made early in 1216, when Frederick, in a letter to Innocent, promised after his own coronation as emperor to recognize his son Henry as king of Sicily, and to place him under the suzerainty of Rome. Henry nevertheless was brought to Germany and chosen German king at Frankfort in April 1220, though Frederick assured the new pope, Honorius III., that this step had been taken without his consent. The truth, however, seems to be that he had taken great trouble to secure this election, and for the purpose had won the support of the spiritual princes by extensive concessions. In August 1220 Frederick set out for Italy, and was crowned emperor at Rome on the 22nd of November 1220, after which he repeated the undertaking he had entered into at Aix-la-Chapelle in 1215 to go on crusade, and made lavish promises to the Church. The clergy were freed from taxation and from lay jurisdiction, the ban of the Empire was to follow the ban of the Church, and heretics were to be severely punished.

Neglecting his promise to lead a crusade, Frederick was occupied until 1225 in restoring order in Sicily. The island was smothered with disorder, but by stern and sometimes cruel measures the emperor suppressed the anarchy of the barons, curbed the power of the cities, and subdued the rebellious Saracens, many of whom, transferred to the mainland and settled at Nocera, afterwards rendered him valuable military service. Meanwhile the crusade was postponed again and again; until under a threat of excommunication, after the fall of

Damietta in 1221, Frederick definitely undertook by a treaty made at San Germano in 1225 to set out in August 1227 or to submit to this penalty. His own interests turned more strongly to the East, when on the 9th of November 1225, after having been a widower since 1222, he married Iolande (Yolande or Isabella), daughter of John, count of Brienne, titular king of Jerusalem. John appears to have expected that this alliance would restore him to his kingdom, but his hopes were dashed to the ground when Frederick himself assumed the title of king of Jerusalem. The emperor's next step was an attempt to restore the imperial authority in northern Italy, and for the purpose a diet was called at Cremona. But the cities, watchful and suspicious, renewed the Lombard league and took up a hostile attitude. Frederick's reply was to annul the treaty of Constance and place the cities under the imperial ban; but he was forced by lack of military strength to accept the mediation of Pope Honorius and the maintenance of the *status quo*.

After these events, which occurred early in 1227, preparations for the crusade were pressed on, and the emperor sailed from Brindisi on the 8th of September. A pestilence, however, which attacked his forces compelled him to land in Italy three days later, and on the 29th of the same month he was excommunicated by the new pope, Gregory IX. The greater part of the succeeding year was spent by pope and emperor in a violent quarrel. Alarmed at the increase in his opponent's power, Gregory denounced him in a public letter, to which Frederick replied in a clever document addressed to the princes of Europe. The reading of this manifesto, drawing attention to the absolute power claimed by the popes, was received in Rome with such evidences of approval that Gregory was compelled to fly to Viterbo. Having lost his wife Isabella on the 8th of May 1228, Frederick again set sail for Palestine; where he met with considerable success, the result of diplomatic rather than of military skill. By a treaty made in February 1229 he secured possession of Jerusalem, Bethlehem, Nazareth and the surrounding neighbourhood. Entering Jerusalem, he crowned himself king of that city on the 18th of March 1229. These successes had been won in spite of the hostility of Gregory, which deprived Frederick of the assistance of many members of the military orders and of the clergy of Palestine. But although the emperor's possessions on the Italian mainland had been attacked in his absence by the papal troops and their allies, Gregory's efforts had failed to arouse serious opposition in Germany and Sicily; so that when Frederick returned unexpectedly to Italy in June 1229 he had no difficulty in driving back his enemies, and compelling the pope to sue for peace. The result was the treaty of San Germano, arranged in July 1230, by which the emperor, loosed from the ban, promised to respect the papal territory, and to allow freedom of election and other privileges to the Sicilian clergy. Frederick was next engaged in completing the pacification of Sicily. In 1231 a series of laws were published at Melfi which destroyed the ascendancy of the feudal nobles. Royal officials were appointed for administrative purposes, large estates were recovered for the crown, and fortresses were destroyed, while the church was placed under the royal jurisdiction and all gifts to it were prohibited. At the same time certain privileges of self-government were granted to the towns, representatives from which were summoned to sit in the diet. In short, by means of a centralized system of government, the king established an almost absolute monarchical power.

In Germany, on the other hand, an entirely different policy was pursued. The concessions granted by Frederick in 1220, together with the Privilege of Worms, dated the 1st of May 1231, made the German princes virtually independent. All jurisdiction over their lands was vested in them, no new mints or toll-centres were to be erected on their domains, and the imperial authority was restricted to a small and dwindling area. A fierce attack was also made on the rights of the cities. Compelled to restore all their lands, their jurisdiction was bounded by their city-walls; they were forbidden to receive the dependents of the princes; all trade guilds were declared abolished; and all official appointments made without the consent of the archbishop or bishop were

annulled. A further attack on the Lombard cities at the diet of Ravenna in 1231 was answered by a renewal of their league, and was soon connected with unrest in Germany. About 1231 a breach took place between Frederick and his elder son Henry, who appears to have opposed the Privilege of Worms and to have favoured the towns against the princes. After refusing to travel to Italy, Henry changed his mind and submitted to his father at Aquileia in 1232; and a temporary peace was made with the Lombard cities in June 1233. But on his return to Germany Henry again raised the standard of revolt, and made a league with the Lombards in December 1234. Frederick, meanwhile, having helped Pope Gregory against the rebellious Romans and having secured the friendship of France and England, appeared in Germany early in 1235 and put down this rising without difficulty. Henry was imprisoned, but his associates were treated leniently. In August 1235 a splendid diet was held at Mainz, during which the marriage of the emperor with Isabella (1214-1241), daughter of John, king of England, was celebrated. A general peace (*Landfrieden*), which became the basis of all such paces in the future, was sworn to; a new office, that of imperial justiciar, was created, and a permanent judicial record was first instituted. Otto of Brunswick, grandson of Henry the Lion, duke of Saxony, was made duke of Brunswick-Lüneburg; and war was declared against the Lombards.

Frederick was now at the height of his power. His second son, Conrad, was invested with the duchy of Swabia, and the claim of Wenceslaus, king of Bohemia, to some lands which had belonged to the German king Philip was bought off. The attitude of Frederick II. (the Quarrelsome), duke of Austria, had been considered by the emperor so suspicious that during a visit paid by Frederick to Italy a war against him was begun. Compelled to return by the ill-fortune which attended this campaign, the emperor took command of his troops, seized Austria, Styria and Carinthia, and declared these territories to be immediately dependent on the Empire. In January 1237 he secured the election of his son Conrad as German king at Vienna; and in September went to Italy to prosecute the war which had broken out with the Lombards in the preceding year. Pope Gregory attempted to mediate, but the cities refused to accept the insulting terms offered by Frederick. The emperor gained a great victory over their forces at Cortenuova in November 1237, but though he met with some further successes, his failure to take Brescia in October 1238, together with the changed attitude of Gregory, turned the fortune of war. The pope had become alarmed when the emperor brought about a marriage between the heiress of Sardinia, Adelasia, and his natural son Enzo, who afterwards assumed the title of king of Sardinia. But as his warnings had been disregarded, he issued a document after the emperor's retreat from Brescia, teeming with complaints against Frederick, and followed it up by an open alliance with the Lombards, and by the excommunication of the emperor on the 20th of March 1239. A violent war of words ensued. Frederick, accused of heresy, blasphemy and other crimes, called upon all kings and princes to unite against the pope, who on his side made vigorous efforts to arouse opposition in Germany, where his emissaries, a crowd of wandering friars, were actively preaching rebellion. It was, however, impossible to find an anti-king. In Italy, Spoleto and Ancona were declared part of the imperial dominions, and Rome itself, faithful on this occasion to the pope, was threatened. A number of ecclesiastics proceeding to a council called by Gregory were captured by Enzo at the sea-fight of Meloria, and the emperor was about to undertake the siege of Rome, when the pope died (August 1241). Germany was at this time menaced by the Mongols; but Frederick contented himself with issuing directions for a campaign against them, until in 1242 he was able to pay a short visit to Germany, where he gained some support from the towns by grants of extensive privileges.

The successor of Gregory was Pope Celestine IX. But this pontiff died soon after his election; and after a delay of eighteen months, during which Frederick marched against Rome on two occasions and devastated the lands of his opponents, one of his

partisans, Sinibaldo Fiesco, was chosen pope, and took the name of Innocent IV. Negotiations for peace were begun, but the relations of the Lombard cities to the Empire could not be adjusted, and when the emperor began again to ravage the papal territories Innocent fled to Lyons. Hither he summoned a general council, which met in June 1245; but although Frederick sent his justiciar, Thaddeus of Suessa, to represent him, and expressed his willingness to treat, sentence of excommunication and deposition was pronounced against him. Once more an interchange of recriminations began, charged with all the violent hyperbole characteristic of the controversial style of the age. Accused of violating treaties, breaking oaths, persecuting the church and abetting heresy, Frederick replied by an open letter rebutting these charges, and in equally unmeasured terms denounced the arrogance and want of faith of the clergy from the pope downwards. The source of all the evil was, he declared, the excessive wealth of the church, which, in retaliation for the sentence of excommunication, he threatened to confiscate. In vain the mediation of the saintly king of France, Louis IX., was invoked. Innocent surpassed his predecessors in the ferocity and unscrupulousness of his attacks on the emperor (see INNOCENT IV.). War soon became general in Germany and Italy. Henry Raspe, landgrave of Thuringia, was chosen German king in opposition to Frederick in May 1246, but neither he nor his successor, William II., count of Holland, was successful in driving the Hohenstaufen from Germany. In Italy, during the emperor's absence, his cause had been upheld by Enzo and by the ferocious Eccellino da Romano. In 1246 a formidable conspiracy of the discontented Apulian barons against the emperor's power and life, fomented by papal emissaries, was discovered and crushed with ruthless cruelty. The emperor's power seemed more firmly established than ever, when suddenly the news reached him that Parma, a stronghold of the imperial authority in the north, had been surprised, while the garrison was off its guard, by the Guelphs. To recover the city was a matter of prime importance, and in 1247 Frederick concentrated his forces round it, building over against it a wooden town which, in anticipation of the success that astrologers had predicted, he named Vittoria. The siege, however, was protracted, and finally, in February 1248, during the absence of the emperor on a hunting expedition, was brought to an end by a sudden sortie of the men of Parma, who stormed the imperial camp. The disaster was complete. The emperor's forces were destroyed or scattered; the treasury, with the imperial insignia, together with Frederick's harem and some of the most trusted of his ministers, fell into the hands of the victors. Thaddeus of Suessa was hacked to pieces by the mob; the imperial crown was placed in mockery on the head of a hunch-backed beggar, who was carried back in triumph into the city.

Frederick struggled hard to retrieve his fortunes, and for a while with success. But his old confidence had left him, he had grown moody and suspicious, and his temper gave a ready handle to his enemies. Pier della Vigna, accused of treasonable designs, was disgraced; and the once all-powerful favourite and minister, blinded now and in rags, was dragged in the emperor's train, as a warning to traitors, till in despair he dashed out his brains. Then, in May 1248, came the tidings of Enzo's capture by the Bolognese, and of his hopeless imprisonment, the captors refusing all offers of ransom. This disaster to his favourite son broke the emperor's spirit. He retired to southern Italy, and after a short illness died at Fiorentino on the 13th of December 1250, after having been loosed from the ban by the archbishop of Palermo. He was buried in the cathedral of that city, where his splendid tomb may still be seen. By his will he appointed his son Conrad to succeed him in Germany and Sicily, and Henry, his son by Isabella of England, to be king of Jerusalem or Arles, neither of which kingdoms, however, he obtained. Frederick left several illegitimate children: Enzo has already been referred to; Frederick, who was made the imperial vicar in Tuscany; and Manfred, his son by the beloved Bianca Lancia or Lanzia, who was legitimized just before his father's death, and was appointed by his will prince of Tarento and regent of Sicily.

acter of Frederick is one of extraordinary interest and contemporary opinion is expressed in the words *et immulator mirabilis*. Licentious and luxurious in , cultured and catholic in his tastes, he united in his most diverse qualities. His Sicilian court was a centre of activity. Michael Scott, the translator of some Aristotle and of the commentaries of Averroes, Pisa, who introduced Arabic numerals and algebra to other scholars, Jewish and Mahomedan as well as were welcome at his court. Frederick himself had a of six languages, was acquainted with mathematics, and natural history, and took an interest in medicine ture. In 1224 he founded the university of Naples, a liberal patron of the medical school at Salerno. a menagerie of strange animals, and wrote a treatise (*De arte venandi cum avibus*) which is remarkable for observation of the habits of birds.¹ It was at his that—as Dante points out—Italian poetry had its della Vigna there wrote the first sonnet, and Italian nderick himself are preserved to us. His wives were ed in oriental fashion; a harem was maintained at eunuchs were a prominent feature of his household. s ideas have been the subject of much controversy. of M. Huillard-Bréholles that he wished to unite to the emperor those of a spiritual pontiff, and aspired to be : of a new religion, is insufficiently supported by b credible. Although at times he persecuted great cruelty, he tolerated Mahomedans and Jews, ts appear rather to have been the outcome of political us than of religious belief. His jests, which were used ies as a charge against him, seem to have originated indifference, or perhaps in a spirit of inquiry which the ideas of a later age. Frederick's rule in Germany as a failure, but this fact may be accounted for by the f the time and the inevitable conflict with the papacy. r the enactments of 1220 and 1231 contributed to the m of the Empire and the fall of the Hohenstaufen, ting interests made the government of Italy a problem al difficulty. In Sicily Frederick was more successful. disorder, and under his rule the island was prosperous ted. His ideas of government were those of an arch, and he probably wished to surround himself f the pomp which had encircled the older emperors of chief claim to fame, perhaps, is as a lawgiver. The s which he gave to Sicily in 1231 bears the impress of ity, and has been described as "the fullest and most dy of legislation promulgated by any western ruler emagne." Without being a great soldier, Frederick killful in warfare, but was better acquainted with the macy. In person he is said to have been "red, bald sighted," but with good features and a pleasing e. It was seriously believed in Germany for about a r his death that Frederick was still alive, and many attempted to personate him. A legend, afterwards to Frederick Barbarossa, told how he sat in a cavern häusser before a stone table through which his beard waiting for the time for him to awake and restore to the golden age of peace.

morary documents relating to the reign of Frederick II. merous. Among the most important are: Richard of o. *Chronica regni Siciliae; Annales Placentini; Gibellini; ade, Annales; Matthew Paris, Historia major Angliae; hronicon Urspergensis*. All these are in the *Monumenta istorica. Scriptores* (Hanover and Berlin, 1826-1892). *Italicarum scriptores*, edited by L. A. Muratori (Milan), contains *Annales Mediolanenses; Nicholas of Jamsilla, abus gestis Frederici II., and Vita Gregorii IX. pontificis*. Iso the *Epistolarum libri* of Peter della Vigna, edited in (Basel, 1740); and Salimbene of Parma's *Chronik*, : Parma (1857). Many of the documents concerning f the time are found in the *Historia diplomatica Frederici* by M. Huillard-Bréholles (Paris, 1852-1861); *Acta*

nted at Augsburg in 1596; a German edition was publin in 1896.

imperii selecta. Urkunden deutscher Könige und Kaiser, edited by J. F. Böhmer and J. Ficker (Innsbruck, 1870); *Acta imperii inedia seculi XIII. Urkunden und Briefe zur Geschichte des Kaiserreichs und des Königreichs Sicilien*, edited by E. Winkelmann (Innsbruck, 1880); *Epistolae seculi XIII. selecta e regestis pontificum Romanorum*, edited by C. Rodenberg, tome I. (Berlin, 1883); P. Pressutti, *Regesta Honorii papae III.* (Rome, 1888); L. Auvray, *Les Registres de Grégoire IX* (Paris, 1890).

The best modern authorities are W. von Giesebrecht, *Geschichte der deutschen Kaiserzeit*, Band v. (Leipzig, 1888); J. Jastrow, *Deutsche Geschichte im Zeitalter der Hohenstaufen* (Berlin, 1893); F. W. Schirrmacher, *Kaiser Friedrich der Zweite* (Göttingen, 1859-1865); "Beiträge zur Geschichte Kaiser Friedrichs II." in the *Forschungen zur deutschen Geschichte*, Band xi. (Göttingen, 1862-1886), and *Die letzten Hohenstaufen* (Göttingen, 1871); E. Winkelmann, *Geschichte Kaiser Friedrichs II und seiner Reiche* (Berlin, 1865) and *Kaiser Friedrich II.* (Leipzig, 1889); G. Blondel, *Étude sur la politique de l'empereur Frédéric II. en Allemagne* (Paris, 1892); M. Halbe, *Friedrich II. und der päpstliche Stuhl* (Berlin, 1888); R. Röhrich, *Die Kreuzfahrt des Kaisers Friedrich II.* (Berlin, 1874); C. Köhler, *Das Verhältnis Kaiser Friedrichs II. zu den Päpsten seiner Zeit* (Breslau, 1888); J. Felten, *Papst Gregor IX.* (Freiburg, 1886); C. Rodenberg, *Innocenz IV. und das Königreich Sicilien* (Halle, 1892); K. Lamprecht, *Deutsche Geschichte*, Band iii. (Berlin, 1891); M. Huillard-Bréholles, *Vie et correspondance de Pierre de la Figue* (Paris, 1865); A. del Vecchio, *La legislazione de Federico II* (Turin, 1874); and K. Hampe, *Kaiser Friedrich II.* (Munich, 1899). (A. W. H. *)

FREDERICK III. (1415-1493), Roman emperor,—as Frederick IV., German king, and as Frederick V., archduke of Austria,—son of Ernest of Habsburg, duke of Styria and Carinthia, was born at Innsbruck on the 21st of September 1415. After his father's death in 1424 he passed his time at the court of his uncle and guardian, Frederick IV., count of Tirol. In 1435, together with his brother, Albert the Prodigal, he undertook the government of Styria and Carinthia, but the peace of these lands was disturbed by constant feuds between the brothers, which lasted until Albert's death in 1463. In 1439 the deaths of the German king Albert II. and of Frederick of Tirol left Frederick the senior member of the Habsburg family, and guardian of Sigismund, count of Tirol. In the following year he also became guardian of Ladislaus, the posthumous son of Albert II., and heir to Bohemia, Hungary and Austria, but these responsibilities brought only trouble and humiliation in their train. On the 2nd of February 1440 Frederick was chosen German king at Frankfurt, but, owing to his absence from Germany, the coronation was delayed until the 17th of June 1442, when it took place at Aix-la-Chapelle.

Disregarding the neutral attitude of the German electors towards the papal schism, and acting under the influence of Aeneas Sylvius Piccolomini, afterwards Pope Pius II., Frederick in 1445 made a secret treaty with Pope Eugenius IV. This developed into the Concordat of Vienna, signed in 1448 with the succeeding pope, Nicholas V., by which the king, in return for a sum of money and a promise of the imperial crown, pledged the obedience of the German people to Rome, and so checked for a time the rising tide of liberty in the German church. Taking up the quarrel between the Habsburgs and the Swiss cantons, Frederick invited the Armagnacs to attack his enemies, but after meeting with a stubborn resistance at St Jacob on the 26th of August 1444, these allies proved faithless, and the king soon lost every vestige of authority in Switzerland. In 1451 Frederick, disregarding the revolts in Austria and Hungary, travelled to Rome, where, on the 16th of March 1452, his marriage with Leonora, daughter of Edward, king of Portugal, was celebrated, and three days later he was crowned emperor by pope Nicholas. On his return he found Germany seething with indignation. His capitulation to the pope was not forgotten; his refusal to attend the diets, and his apathy in the face of Turkish aggressions, constituted a serious danger; and plans for his deposition failed only because the electors could not unite upon a rival king. In 1457 Ladislaus, king of Hungary and Bohemia, and archduke of Austria, died; Frederick failed to secure either kingdom, but obtained lower Austria, from which, however, he was soon driven by his brother Albert, who occupied Vienna. On Albert's death in 1463 the emperor united upper and lower Austria under his rule, but these possessions were constantly ravaged by George

Poděbrad, king of Bohemia, and by Matthias Corvinus, king of Hungary. A visit to Rome in 1468 to discuss measures against the Turks with Pope Paul II. had no result, and in 1470 Frederick began negotiations for a marriage between his son Maximilian and Mary, daughter and heiress of Charles the Bold, duke of Burgundy. The emperor met the duke at Treves in 1473, when Frederick, desiring to bestow the title of king upon Charles, left the city secretly, but brought about the marriage after the duke's death in 1477. Again attacked by Matthias, the emperor was driven from Vienna, and soon handed over the government of his lands to Maximilian, whose election as king of the Romans he vainly opposed in 1486. Frederick then retired to Linz, where he passed his time in the study of botany, alchemy and astronomy, until his death on the 19th of August 1493.

Frederick was a listless and incapable ruler, lacking alike the qualities of the soldier and of the diplomatist, but possessing a certain cleverness in evading difficulties. With a fine presence, he had many excellent personal qualities, is spoken of as mild and just, and had a real love of learning. He had a great belief in the future greatness of his family, to which he contributed largely by arranging the marriage of Maximilian with Mary of Burgundy, and delighted to inscribe his books and other articles of value with the letters A.E.I.O.U. (*Austriae est imperare orbi universo*; or in German, *Alles Erdrreich ist Oesterreich unterthan*). His personality counts for very little in German history. One chronicler says: "He was a useless emperor, and the nation during his long reign forgot that she had a king." His tomb, a magnificent work in red and white marble, is in the cathedral of St. Stephen at Vienna.

See Aeneas Sylvius Piccolomini, *De rebus et gestis Friderici III.* (trans. Th. Ilgen, Leipzig, 1889); J. Chmel, *Geschichte Kaiser Friedrichs IV. und seines Sohnes Maximilians I.* (Hamburg, 1840); A. Bachmann, *Deutsche Reichsgeschichte im Zeitalter Friedrichs III. und Maximilians I.* (Leipzig, 1884); A. Huber, *Geschichte Oesterreichs* (Gotha, 1885-1892); and E. M. Fürst von Lichnowsky, *Geschichte des Hauses Habsburg* (Vienna, 1836-1844).

FREDERICK III. (c. 1286-1330), surnamed "the Fair," German king and duke of Austria, was the second son of the German king, Albert I., and consequently a member of the Habsburg family. In 1298, when his father was chosen German king, Frederick was invested with some of the family lands, and in 1306, when his elder brother Rudolph became king of Bohemia, he succeeded to the duchy of Austria. In 1307 Rudolph died, and Frederick sought to obtain the Bohemian throne; but an expedition into that country was a failure, and his father's murder in May 1308 deprived him of considerable support. He was equally unsuccessful in his efforts to procure the German crown at this time, and the relations between the new king, Henry VII., and the Habsburgs were far from friendly. Frederick asked not only to be confirmed in the possession of Austria, but to be invested with Moravia, a demand to which Henry refused to accede; but an arrangement was subsequently made by which the duke agreed to renounce Moravia in return for a payment of 50,000 marks. Frederick then became involved in a quarrel with his cousin Louis IV., duke of Upper Bavaria (afterwards the emperor Louis IV.), over the guardianship of Henry II., duke of Lower Bavaria. Hostilities broke out, and on the 9th of November 1313 he was defeated by Louis at the battle of Gamelsdorf and compelled to renounce his claim.

Meanwhile the emperor Henry VII. had died in Italy, and a stubborn contest ensued for the vacant throne. After a long delay Frederick was chosen German king at Frankfurt by a minority of the electors on the 19th of October 1314, while a majority elected Louis of Bavaria. Six days later Frederick was crowned at Bonn by the archbishop of Cologne, and war broke out at once between the rivals. During this contest, which was carried on in a desultory fashion, Frederick drew his chief strength from southern and eastern Germany, and was supported by the full power of the Habsburgs. The defeat of his brother Leopold by the Swiss at Morgarten in November 1315 was a heavy blow to him, but he prolonged the struggle for seven years. On the 28th of September 1322 a decisive battle was fought at Mühldorf; Frederick was defeated and sent as a

prisoner to Trausnitz. Here he was retained until three years later a series of events induced Louis to come to terms. By the treaty of Trausnitz, signed on the 13th of March 1325, Frederick acknowledged the kingship of Louis in return for freedom, and promised to return to captivity unless he could induce his brother Leopold to make a similar acknowledgment. As Leopold refused to take this step, Frederick, although released from his oath by Pope John XXII., travelled back to Bavaria, where he was treated by Louis rather as a friend than as a prisoner. A suggestion was then made that the kings should rule jointly, but as this plan aroused some opposition it was agreed that Frederick should govern Germany while Louis went to Italy for the imperial crown. But this arrangement did not prove generally acceptable, and the death of Leopold in 1326 deprived Frederick of a powerful supporter. In these circumstances he returned to Austria broken down in mind and body, and on the 13th of January 1330 he died at Gutenstein, and was buried at Mauerbach, whence his remains were removed in 1783 to the cathedral of St. Stephen at Vienna. He married Elizabeth, daughter of James I., king of Aragon, and left two daughters. His voluntary return into captivity is used by Schiller in his poem *Deutsche Treue*, and by J. L. Uhland in the drama *Ludwig der Bayer*.

The authorities for the life of Frederick are found in the *Fontes rerum Germanicarum*. Band I., edited by J. F. Böhmner (Stuttgart, 1843-1868), and in the *Fontes rerum Austriacarum*, part i. (Vienna, 1855). Modern works which may be consulted are: E. M. Fürst von Lichnowsky, *Geschichte des Hauses Habsburg* (Vienna, 1836-1844); Th. Lindner, *Deutsche Geschichte unter den Habsburgern und Luxemburgern* (Stuttgart, 1888-1893). R. Döhner, *Die Auseinandersetzung zwischen Ludwig IV. dem Bayer und Friedrich dem Schönen von Oesterreich* (Göttingen, 1875); F. Kurx, *Oesterreich unter König Friedrich dem Schönen* (Linz, 1818); F. Krones, *Handbuch der Geschichte Oesterreichs* (Berlin, 1876-1879); H. Schroeber, *Der Kampf der Gegenkönige Ludwig und Friedrich* (Berlin, 1902); W. Friedensburg, *Ludwig IV. der Bayer und Friedrich von Oesterreich* (Göttingen, 1877); B. Gebhardt, *Handbuch der deutschen Geschichte* (Berlin, 1901).

FREDERICK II. (1534-1588), king of Denmark and Norway, son of Christian III., was born at Hadersleben on the 1st of July 1534. His mother, Dorothea of Saxe-Lauenburg, was the elder sister of Catherine, the first wife of Gustavus Vasa and the mother of Eric XIV. The two little cousins, born the same year, were destined to be lifelong rivals. At the age of two Frederick was proclaimed successor to the throne at the *Rigsdag* of Copenhagen (October 30th, 1536), and homage was done to him at Oslo for Norway in 1548. The choice of his governor, the patriotic historiographer Hans Svanning, was so far fortunate that it ensured the devotion of the future king of Denmark to everything Danish; but Svanning was a poor pedagogue, and the wild and wayward lad suffered all his life from the defects of his early training. Frederick's youthful, innocent attachment to the daughter of his former tutor, Anna Hardenberg, indisposed him towards matrimony at the beginning of his reign (1558). After the hands of Elizabeth of England, Mary of Scotland and Renata of Lorraine had successively been sought for him, the council of state grew anxious about the succession, but he finally married his cousin, Sophia of Mecklenburg, on the 20th of July 1572.

The reign of Frederick II. falls into two well-defined divisions: (1) a period of war, 1559-1570; and (2) a period of peace, 1570-1588. The period of war began with the Ditmarsh expedition, when the independent peasant-republic of the Ditmarsers of West Holstein, which had stoutly maintained its independence for centuries against the counts of Holstein and the Danish kings, was subdued by a Dano-Holstein army of 20,000 men in 1559. Frederick and his uncles John and Adolphus, dukes of Holstein, dividing the land between them. Equally triumphant was Frederick in his war with Sweden, though here the contest was much more severe, lasting as it did for seven years; whence it is generally described in northern history as the Scandinavian Seven Years' War. The tension which had prevailed between the two kingdoms during the last years of Gustavus Vasa reached breaking point on the accession of Gustavus's eldest son Eric XIV. There were many causes of quarrel between the two ambitious young monarchs, but the detention at Copenhagen in 1563 of a splendid matrimonial embassy on its way to Germany,

to negotiate a match between Eric and Christina of Hesse, which King Frederick for political reasons was determined to prevent, precipitated hostilities. During the war, which was marked by extraordinary ferocity throughout, the Danes were generally victorious on land owing to the genius of Daniel Rantzau, but at sea the Swedes were almost uniformly triumphant. By 1570 the strife had degenerated into a barbarous devastation of border provinces; and in July of the same year both countries accepted the mediation of the Emperor, and peace was finally concluded at Stettin on Dec. 13, 1570. During the course of this Seven Years' War Frederick II. had narrowly escaped the fate of his deposed cousin Eric XIV. The war was very unpopular in Denmark, and the closing of the Sound against foreign shipping, in order to starve out Sweden, had exasperated the maritime powers and all the Baltic states. On New Year's Day 1570 Frederick's difficulties seemed so overwhelming that he threatened to abdicate; but the peace of Stettin came in time to reconcile all parties, and though Frederick had now to relinquish his ambitious dream of re-establishing the Union of Kalmar, he had at least succeeded in maintaining the supremacy of Denmark in the north. After the peace Frederick's policy became still more imperial. He aspired to the dominion of all the seas which washed the Scandinavian coasts, and before he died he succeeded in suppressing the pirates who so long had haunted the Baltic and the German Ocean. He also erected the stately fortress of Kronborg, to guard the narrow channel of the Sound. Frederick possessed the truly royal gift of discovering and employing great men, irrespective of personal preferences and even of personal injuries. With infinite tact and admirable self-denial he gave free scope to ministers whose superiority in their various departments he frankly recognized, rarely interfering personally unless absolutely called upon to do so. His influence, always great, was increased by his genial and unaffected manners as a host. He is also remarkable as one of the few kings of the house of Oldenburg who had no illicit *liaison*. He died at Antvorskov on the 4th of April 1588. No other Danish king was ever so beloved by his people.

See *Lund (Troels), Danmarks og Norges Historie & Stabningen af det XVI. Aarh.* (Copenhagen, 1879); *Danmarks Riges Historie* (Copenhagen, 1897-1905), vol. 3; Robert Niabet Bain, *Scandinavia*, cap. 4 (Cambridge, 1905).

FREDERICK III. (1609-1670), king of Denmark and Norway, son of Christian IV. and Anne Catherine of Brandenburg, was born on the 18th of March 1609 at Hadersleben. His position as a younger son profoundly influenced his future career. In his youth and early manhood there was no prospect of his ascending the Danish throne, and he consequently became the instrument of his father's schemes of aggrandizement in Germany. While still a lad he became successively bishop of Bremen, bishop of Verden and coadjutor of Halberstadt, while at the age of eighteen he was the chief commandant of the fortress of Stade. Thus from an early age he had considerable experience as an administrator, while his general education was very careful and thorough. He had always a pronounced liking for literary and scientific studies. On the 1st of October 1643 Frederick wedded Sophia Amelia of Brunswick Lüneburg, whose energetic, passionate and ambitious character was profoundly to affect not only Frederick's destiny but the destiny of Denmark. During the disastrous Swedish War of 1643-1645 Frederick was appointed generalissimo of the duchies by his father, but the laurels he won were scanty, chiefly owing to his quarrels with the Earl-Marshal Anders Bille, who commanded the Danish forces. This was Frederick's first collision with the Danish nobility, who ever afterwards regarded him with extreme distrust. The death of his elder brother Christian IV. first opened to him the prospect of succeeding to the Danish throne, but the question was still unsettled when Christian IV. died on the 28th of February 1648. Not till the 6th of July in the same year did Frederick III. receive the homage of his subjects, and only after he had signed a *Haandfaestning* or charter, by which the already diminished royal prerogative was still further curtailed. It had been doubtful at first whether he would be allowed to inherit his ancestral

throne at all; but Frederick removed the last scruples of the *Rigsraad* by unhesitatingly accepting the conditions imposed upon him.

The new monarch was a reserved; enigmatical prince, who seldom laughed, spoke little and wrote less—a striking contrast to Christian IV. But if he lacked the brilliant qualities of his impulsive, jovial father, he possessed in a high degree the compensating virtues of moderation, sobriety and self-control. But with all his good qualities Frederick was not the man to take a clear view of the political horizon, or even to recognize his own and his country's limitations. He rightly regarded the accession of Charles X. of Sweden (June 6th, 1654) as a source of danger to Denmark. He felt that temperament and policy would combine to make Charles an aggressive warrior-king: the only uncertainty was in which direction he would turn his arms first. Charles's invasion of Poland (July 1654) came as a distinct relief to the Danes, though even the Polish War was full of latent peril to Denmark. Frederick was resolved upon a rupture with Sweden at the first convenient opportunity. The *Rigsdag* which assembled on the 23rd of February 1657 willingly granted considerable subsidies for mobilization and other military expenses; on the 15th of April Frederick III. desired, and on the 23rd of April he received, the assent of the majority of the *Rigsraad* to attack Sweden's German provinces; in the beginning of May the still pending negotiations with that power were broken off, and on the 1st of June Frederick signed the manifesto justifying a war which was never formally declared. The Swedish king traversed all the plans of his enemies by his passage of the frozen Belts, in January and February 1658 (see CHARLES X. of Sweden). The effect of this unheard-of achievement on the Danish government was crushing. Frederick III. at once sued for peace; and, yielding to the persuasions of the English and French ministers, Charles finally agreed to be content with mutilating instead of annihilating the Danish monarchy (treaties of Taastrup, February 18th, and of Roskilde, February 26th, 1658). The conclusion of peace was followed by a remarkable episode. Frederick expressed the desire to make the personal acquaintance of his conqueror; and Charles X. consented to be his guest for three days (March 3-5) at the castle of Fredriksborg. Splendid banquets lasting far into the night, private and intimate conversations between the princes who had only just emerged from a mortal struggle, seemed to point to nothing but peace and friendship in the future. But Charles's insatiable lust for conquest, and his ineradicable suspicion of Denmark, induced him, on the 17th of July, without any reasonable cause, without a declaration of war, in defiance of all international equity, to endeavour to despatch an inconvenient neighbour.

Terror was the first feeling produced at Copenhagen by the landing of the main Swedish army at Korsør in Zealand. None had anticipated the possibility of such a sudden and brutal attack, and every one knew that the Danish capital was very inadequately fortified and garrisoned. Fortunately Frederick had never been deficient in courage. "I will die in my nest" were the memorable words with which he rebuked those counsellors who advised him to seek safety in flight. On the 8th of August representatives from every class in the capital urged the necessity of a vigorous resistance; and the citizens of Copenhagen, headed by the great burgomaster Hans Nansen (*q.v.*), protested their unshakable loyalty to the king, and their determination to defend Copenhagen to the uttermost. The Danes had only three days' warning of the approaching danger; and the vast and dilapidated line of defence had at first but 2000 regular defenders. But the government and the people displayed a memorable and exemplary energy, under the constant supervision of the king, the queen, and burgomaster Nansen. By the beginning of September all the breaches were repaired, the walls bristled with cannon, and 7000 men were under arms. So strong was the city by this time that Charles X., abandoning his original intention of carrying the place by assault, began a regular siege; but this also he was forced to abandon when, on the 29th of October, an auxiliary Dutch fleet, after reinforcing and reprovisioning the garrison, defeated, in conjunction with the Danish fleet, the

Swedish navy of 44 liners in the Sound. Thus the Danish capital had saved the Danish monarchy. But it was Frederick III. who profited most by his spirited defence of the common interests of the country and the dynasty. The traditional loyalty of the Danish middle classes was transformed into a boundless enthusiasm for the king personally, and for a brief period Frederick found himself the most popular man in his kingdom. He made use of his popularity by realizing the dream of a lifetime and converting an elective into an absolute monarchy by the Revolution of 1660 (see DENMARK: *History*). Frederick III. died on the 6th of February 1670 at the castle of Copenhagen.

See R. Nisbet Bain, *Scandinavia*, caps. ix. and x. (Cambridge, 1905).

FREDERICK VIII. (1843—), king of Denmark, eldest son of King Christian IX., was born at Copenhagen on the 3rd of June 1843. As crown prince of Denmark he took part in the war of 1864 against Austria and Prussia, and subsequently assisted his father in the duties of government, becoming king on Christian's death in January 1906. In 1869 Frederick married Louise (b. 1851), daughter of Charles XV., king of Sweden, by whom he had a family of four sons and four daughters. His eldest son Christian, crown prince of Denmark (b. 1870), was married in 1898 to Alexandrina (b. 1879), daughter of Frederick Francis III., grand-duke of Mecklenburg-Schwerin; and his second son, Charles (b. 1872), who married his cousin Maud, daughter of Edward VII. of Great Britain, became king of Norway as Haakon VII. in 1905.

FREDERICK I. (1657–1713), king of Prussia, and (as Frederick III.) elector of Brandenburg, was the second son of the great elector, Frederick William, by his first marriage with Louise Henriette, daughter of Frederick Henry of Orange. Born at Königsberg on the 11th of July 1657, he was educated and greatly influenced by Eberhard Danckelmann, and became heir to the throne of Brandenburg through the death of his elder brother, Charles Emil, in 1674. He appears to have taken some part in public business before the death of his father; and the court at Berlin was soon disturbed by quarrels between the young prince and his stepmother, Dorothea of Holstein-Glücksburg. In 1686 Dorothea persuaded her husband to bequeath outlying portions of his lands to her four sons; and Frederick, fearing he would be poisoned, left Brandenburg determined to prevent any diminution of his inheritance. By promising to restore Schwiebus to Silesia after his accession he won the support of the emperor Leopold I.; but eventually he gained his end in a peaceable fashion. Having become elector of Brandenburg in May 1688, he came to terms with his half-brothers and their mother. In return for a sum of money these princes renounced their rights under their father's will, and the new elector thus secured the whole of Frederick William's territories. After much delay and grumbling he fulfilled his bargain with Leopold and gave up Schwiebus in 1695. At home and abroad Frederick continued the policy of the great elector. He helped William of Orange to make his descent on England; added various places, including the principality of Neuchâtel, to his lands; and exercised some influence on the course of European politics by placing his large and efficient army at the disposal of the emperor and his allies (see BRANDENBURG). He was present in person at the siege of Bonn in 1689, but was not often in command of his troops. The elector was very fond of pomp, and, striving to model his court upon that of Louis XIV., he directed his main energies towards obtaining for himself the title of king. In spite of the assistance he had given to the emperor his efforts met with no success for some years; but towards 1700 Leopold, faced with the prospect of a new struggle with France, was inclined to view the idea more favourably. Having insisted upon various conditions, prominent among them being military aid for the approaching war, he gave the imperial sanction to Frederick's request in November 1700; whereupon the elector, hurrying at once to Königsberg, crowned himself with great ceremony king of Prussia on the 18th of January 1701. According to his promise the king sent help to the emperor; and during the War of the Spanish Succession the troops of Brandenburg-Prussia rendered great assistance to the

allies, fighting with distinction at Blenheim and elsewhere. Frederick, who was deformed through an injury to his spine, died on the 25th of February 1713. By his extravagance the king exhausted the treasure amassed by his father, burdened his country with heavy taxes, and reduced its finances to chaos. His constant obligations to the emperor drained Brandenburg of money which might have been employed more profitably at home, and prevented her sovereign from interfering in the politics of northern Europe. Frederick, however, was not an unpopular ruler, and by making Prussia into a kingdom he undoubtedly advanced it several stages towards its future greatness. He founded the university of Halle, and the Academy of Sciences at Berlin; welcomed and protected Protestant refugees from France and elsewhere; and lavished money on the erection of public buildings.

The king was married three times. His second wife, Sophie Charlotte (1668–1705), sister of the English king George I., was the friend of Leibnitz and one of the most cultured princesses of the age; she bore him his only son, his successor, King Frederick William I.

See W. Hahn, *Friedrich I., König in Preussen* (Berlin, 1876); J. G. Droysen, *Geschichte der preussischen Politik*, Band iv. (Leipzig, 1872); E. Heyck, *Friedrich I. und die Begründung des preussischen Königthums* (Bielefeld, 1901); C. Graf von Dohna, *Mémoires originaux sur le règne et la cour de Frédéric I^{er}* (Berlin, 1883); *Aus dem Briefwechsel König Friedrichs I. von Preussen und seiner Familie* (Berlin, 1901); and T. Carlyle, *History of Frederick the Great*, vol. I. (London, 1872).

FREDERICK II., known as "the Great" (1712–1786), king of Prussia, born on the 24th of January 1712, was the eldest son of Frederick William I. He was brought up with extreme rigour, his father devising a scheme of education which was intended to make him a hardy soldier, and prescribing for him every detail of his conduct. So great was Frederick William's horror of everything which did not seem to him practical, that he strictly excluded Latin from the list of his son's studies. Frederick, however, had free and generous impulses which could not be restrained by the sternest system. Encouraged by his mother, and under the influence of his governess Madame de Roucoulle, and of his first tutor Duhan, a French refugee, he acquired an excellent knowledge of French and a taste for literature and music. He even received secret lessons in Latin, which his father invested with all the charms of forbidden fruit. As he grew up he became extremely dissatisfied with the dull and monotonous life he was compelled to lead; and his discontent was heartily shared by his sister, Wilhelmina, a bright and intelligent young princess for whom Frederick had a warm affection.

Frederick William, seeing his son apparently absorbed in frivolous and effeminate amusements, gradually conceived for him an intense dislike, which had its share in causing him to break off the negotiations for a double marriage between the prince of Wales and Wilhelmina, and the princess Amelia, daughter of George II., and Frederick; for Frederick had been so indiscreet as to carry on a separate correspondence with the English court and to vow that he would marry Amelia or no one. Frederick William's hatred of his son, openly avowed, displayed itself in violent outbursts and public insults, and so harsh was his treatment that Frederick frequently thought of running away and taking refuge at the English court. He at last resolved to do so during a journey which he made with the king to south Germany in 1730, when he was eighteen years of age. He was helped by his two friends, Lieutenant Katte and Lieutenant Keith; but by the imprudence of the former the secret was found out. Frederick was placed under arrest, deprived of his rank as crown prince, tried by court-martial, and imprisoned in the fortress of Cöstrin. Warned by Frederick, Keith escaped; but Katte delayed his flight too long, and a court-martial decided that he should be punished with two years' fortress arrest. But the king was determined by a terrible example to wake Frederick once for all to a consciousness of the heavy responsibility of his position. He changed the sentence on Katte to one of death and ordered the execution to take place in Frederick's presence;

himself arranging its every detail, Frederick's own fate would depend upon the effect of this terrible object-lesson and the response he should make to the exhortations of the chaplain sent to reason with him. On the morning of the 7th of November Katte was beheaded before Frederick's window, after the crown prince had asked his pardon and received the answer that there was nothing to forgive. On Frederick himself lay the terror of death, and the chaplain was able to send to the king a favourable report of his orthodoxy and his changed disposition. Frederick William, whose temper was by no means so ruthlessly Spartan as tradition has painted it, was overjoyed, and commissioned the clergyman to receive from the prince an oath of filial obedience, and in exchange for this proof of "his intention to improve in real earnest" his arrest was to be lightened, pending the earning of a full pardon. "The whole town shall be his prison," wrote the king; "I will give him employment, from morning to night, in the departments of war, and agriculture, and of the government. He shall work at financial matters, receive accounts, read minutes and make extracts . . . But if he kicks or rears again, he shall forfeit the succession to the crown, and even, according to circumstances, life itself."

For about fifteen months Frederick lived in Cüstrin, busy according to the royal programme with the details of the Prussian administrative system. He was very careful not to "kick or rear," and his good conduct earned him a further stage in the restoration to favour. During this period of probation he had been deprived of his status as a soldier and refused the right to wear uniform, while officers and soldiers were forbidden to give him the military salute; in 1733 he was made colonel in command of the regiment at Neuruppin. In the following year he married, in obedience to the king's orders, the princess Elizabeth Christina, daughter of the duke of Brunswick-Bevern. He was given the estate of Rheinsberg in the neighbourhood of Neuruppin, and there he lived until he succeeded to the throne. These years were perhaps the happiest of his life. He discharged his duties with so much spirit and so conscientiously that he ultimately gained the esteem of Frederick William, who no longer feared that he would leave the crown to one unworthy of wearing it. At the same time the crown prince was able to indulge to the full his personal tastes. He carried on a lively correspondence with Voltaire and other French men of letters, and was a diligent student of philosophy, history and poetry. Two of his best-known works were written at this time—*Considérations sur l'état présent du corps politique de l'Europe* and his *Anti-Macchiavel*. In the former he calls attention to the growing strength of Austria and France, and insists on the necessity of some third power, by which he clearly means Prussia, counterbalancing their excessive influence. The second treatise, which was issued by Voltaire in Hague in 1740, contains a generous exposition of some of the favourite ideas of the 18th-century philosophers respecting the duties of sovereigns, which may be summed up in the famous sentence: "the prince is not the absolute master, but only the first servant of his people."

On the 31st of May 1740 he became king. He maintained all the forms of government established by his father, but ruled in a far more enlightened spirit; he tolerated every form of religious opinion, abolished the use of torture, was most careful to secure an exact and impartial administration of justice, and, while keeping the reins of government strictly in his own hands, allowed every one with a genuine grievance free access to his presence. The Potsdam regiment of giants was disbanded, but the real interests of the army were carefully studied, for Frederick realized that the two pillars of the Prussian state were sound finances and a strong army. On the 20th of October 1740 the emperor Charles VI. died. Frederick at once began to make extensive military preparations, and it was soon clear to all the world that he intended to enter upon some serious enterprise. He had made up his mind to assert the ancient claim of the house of Brandenburg to the three Silesian duchies, which the Austrian rulers of Bohemia had ever denied, but the Hohenzollerns had never abandoned. Projects for the assertion of this claim by force of arms had been formed by more than one of Frederick's

predecessors, and the extinction of the male line of the house of Habsburg may well have seemed to him a unique opportunity for realizing an ambition traditional in his family. For this resolution he is often abused still by historians, and at the time he had the approval of hardly any one out of Prussia. He himself, writing of the scheme in his *Mémoires*, laid no claim to lofty motives, but candidly confessed that "it was a means of acquiring reputation and of increasing the power of the state." He firmly believed, however, in the lawfulness of his claims; and although his father had recognized the Pragmatic Sanction, whereby the hereditary dominions of Charles VI. were to descend to his daughter, Maria Theresa, Frederick insisted that this sanction could refer only to lands which rightfully belonged to the house of Austria. He could also urge that, as Charles VI. had not fulfilled the engagements by which Frederick William's recognition of the Pragmatic Sanction had been secured, Prussia was freed from her obligation.

Frederick sent an ambassador to Vienna, offering, in the event of his rights in Silesia being conceded, to aid Maria Theresa against her enemies. The queen of Hungary, who regarded the proposal as that of a mere robber, haughtily declined; whereupon Frederick immediately invaded Silesia with an army of 30,000 men. His first victory was gained at Mollwitz on the 10th of April 1741. Under the impression, in consequence of a furious charge of Austrian cavalry, that the battle was lost, he rode rapidly away at an early stage of the struggle—a mistake which gave rise for a time to the groundless idea that he lacked personal courage. A second Prussian victory was gained at Chotusitz, near Caslau, on the 17th May 1742; by this time Frederick was master of all the fortified places of Silesia. Maria Theresa, in the heat of her struggle with France and the elector of Bavaria, now Charles VII., and pressed by England to rid herself of Frederick, concluded with him, on the 11th of June 1742, the peace of Breslau, conceding to Prussia, Upper and Lower Silesia as far as the Oppa, together with the county of Glatz. Frederick made good use of the next two years, fortifying his new territory, and repairing the evils inflicted upon it by the war. By the death of the prince of East Friesland without heirs, he also gained possession of that country (1744). He knew well that Maria Theresa would not, if she could help it, allow him to remain in Silesia; accordingly, in 1744, alarmed by her victories, he arrived at a secret understanding with France, and pledged himself, with Hesse-Cassel and the palatinate, to maintain the imperial rights of Charles VII., and to defend his hereditary Bavarian lands. Frederick began the second Silesian War by entering Bohemia in August 1744 and taking Prague. By this brilliant but rash venture he put himself in great danger, and soon had to retreat; but in 1745 he gained the battles of Hohenfriedberg, Soor and Hennersdorf; and Leopold of Dessau ("Der alte Dessauer") won for him the victory of Kesselsdorf in Saxony. The latter victory was decisive, and the peace of Dresden (December 25, 1745) assured to Frederick a second time the possession of Silesia. (See AUSTRIAN SUCCESSION, WAR OF THE.)

Frederick had thus, at the age of thirty-three, raised himself to a great position in Europe, and henceforth he was the most, conspicuous sovereign of his time. He was a thoroughly absolute ruler, his so-called ministers being mere clerks whose business was to give effect to his will. To use his own famous phrase, however, he regarded himself as but "the first servant of the state"; and during the next eleven years he proved that the words expressed his inmost conviction and feeling. All kinds of questions were submitted to him, important and unimportant; and he is frequently censured for having troubled himself so much with mere details. But in so far as these details related to expenditure he was fully justified, for it was absolutely essential for him to have a large army, and with a small state this was impossible unless he carefully prevented unnecessary outlay. Being a keen judge of character, he filled the public offices with faithful, capable, energetic men, who were kept up to a high standard of duty by the consciousness that their work might at any time come under his strict supervision. The Academy of Sciences, which had fallen into contempt during

his father's reign, he restored, infusing into it vigorous life; and he did more to promote elementary education than any of his predecessors. He did much too for the economic development of Prussia, especially for agriculture; he established colonies, peopling them with immigrants, extended the canal system, drained and diked the great marshes of the Oderbruch, turning them into rich pasturage, encouraged the planting of fruit trees and of root crops; and, though in accordance with his ideas of discipline he maintained serfdom, he did much to lighten the burdens of the peasants. All kinds of manufacture, too, particularly that of silk, owed much to his encouragement. To the army he gave unremitting attention, reviewing it at regular intervals, and sternly punishing negligence on the part of the officers. Its numbers were raised to 160,000 men, while fortresses and magazines were always kept in a state of readiness for war. The influence of the king's example was felt far beyond the limits of his immediate circle. The nation was proud of his genius, and displayed something of his energy in all departments of life. Lessing, who as a youth of twenty came to Berlin in 1740, composed enthusiastic odes in his honour, and Gleim, the Halberstadt poet, wrote of him as of a kind of demi-god. These may be taken as fair illustrations of the popular feeling long before the Seven Years' War.

He despised German as the language of bores, although it is remarkable that at a later period, in a French essay on German literature, he predicted for it a great future. He habitually wrote and spoke French, and had a strong ambition to rank as a distinguished French author. Nobody can now read his verses, but his prose writings have a certain calm simplicity and dignity, without, however, giving evidence of the splendid mental qualities which he revealed in practical life. To this period belong his *Mémoires pour servir à l'histoire de Brandebourg* and his poem *L'Art de la guerre*. The latter, judged as literature, is intolerably dull; but the former is valuable, throwing as it does considerable light on his personal sympathies as well as on the motives of important epochs in his career. He continued to correspond with French writers, and induced a number of them to settle in Berlin, Maupertuis being president of the Academy. In 1752 Voltaire, who had repeatedly visited him, came at Frederick's urgent entreaty, and received a truly royal welcome. The famous Hirsch trial, and Voltaire's vanity and caprice, greatly lowered him in the esteem of the king, who, on his side, irritated his guest by often requiring him to correct bad verses, and by making him the object of rude banter. The publication of *Doctor Akakia*, which brought down upon the president of the Academy a storm of ridicule, finally alienated Frederick; while Voltaire's wrongs culminated in the famous arrest at Frankfurt, the most disagreeable elements of which were due to the misunderstanding of an order by a subordinate official.

The king lived as much as possible in a retired mansion, to which he gave the name of Sanssouci—not the palace so called, which was built after the Seven Years' War, and was never a favourite residence. He rose regularly in summer at five, in winter at six, devoting himself to public business till about eleven. During part of this time, after coffee, he would aid his reflections by playing on the flute, of which he was passionately fond, being a really skilful performer. At eleven came parade, and an hour afterwards, punctually, dinner, which continued till two, or later, if conversation happened to be particularly attractive. After dinner he glanced through and signed cabinet orders written in accordance with his morning instructions, often adding marginal notes and postscripts, many of which were in a caustic tone. These disposed of, he amused himself for a couple of hours with literary work; between six and seven he would converse with his friends or listen to his reader (a post held for some time by La Mettrie); at seven there was a concert; and at half-past eight he sat down to supper, which might go on till midnight. He liked good eating and drinking, although even here the cost was sharply looked after, the expenses of his kitchen amounting to no higher figure than £1800 a year. At supper he was always surrounded by a number of his most intimate friends, mainly Frenchmen; and he insisted on the conversation being perfectly

free. His wit, however, was often cruel, and any one who responded with too much spirit was soon made to feel that the licence of talk was to be complete only on one side.

At Frederick's court ladies were seldom seen, a circumstance that gave occasion to much scandal for which there seems to have been no foundation. The queen he visited only on rare occasions. She had been forced upon him by his father, and he had never loved her; but he always treated her with marked respect, and provided her with a generous income, half of which she gave away in charity. Although without charm, she was a woman of many noble qualities; and, like her husband, she wrote French books, some of which attracted a certain attention in their day. She survived him by eleven years, dying in 1797.

Maria Theresa had never given up hope that she would recover Silesia; and as all the neighbouring sovereigns were bitterly jealous of Frederick, and somewhat afraid of him, she had no difficulty in inducing several of them to form a scheme for his ruin. Russia and Saxony entered into it heartily, and France, laying aside her ancient enmity towards Austria, joined the empress against the common object of dislike. Frederick, meanwhile, had turned towards England, which saw in him a possible ally of great importance against the French. A convention between Prussia and Great Britain was signed in January 1756, and it proved of incalculable value to both countries, leading as it did to a close alliance during the administration of Pitt. Through the treachery of a clerk in the Saxon foreign office Frederick was made aware of the future which was being prepared for him. Seeing the importance of taking the initiative, and if possible, of securing Saxony, he suddenly, on the 24th of August 1756, crossed the frontier of that country, and shut in the Saxon army between Pirna and Königstein, ultimately compelling it, after a victory gained over the Austrians at Lobositz, to surrender. Thus began the Seven Years' War, in which, supported by England, Brunswick and Hesse-Cassel, he had for a long time to oppose Austria, France, Russia, Saxony and Sweden. Virtually the whole Continent was in arms against a small state which, a few years before, had been regarded by most men as beneath serious notice. But it happened that this small state was led by a man of high military genius, capable of infusing into others his own undaunted spirit, while his subjects had learned both from him and his predecessors habits of patience, perseverance and discipline. In 1757, after defeating the Austrians at Prague, he was himself defeated by them at Kolin; and by the shameful convention of Closter-Seven, he was freely exposed to the attack of the French. In November 1757, however, when Europe looked upon him as ruined, he rid himself of the French by his splendid victory over them at Rossbach, and in about a month afterwards, by the still more splendid victory at Leuthen, he drove the Austrians from Silesia. From this time the French were kept well employed in the west by Prince Ferdinand of Brunswick, who defeated them at Crefeld in 1758, and at Minden in 1759. In the former year Frederick triumphed, at a heavy cost, over the Russians at Zorndorf; and although, through lack of his usual foresight, he lost the battle of Hochkirch, he prevented the Austrians from deriving any real advantage from their triumph, Silesia still remaining in his hands at the end of the year. The battle of Kunersdorf, fought on the 12th of August 1759, was the most disastrous to him in the course of the war. He had here to contend both with the Russians and the Austrians; and although at first he had some success, his army was in the end completely broken. "All is lost save the royal family," he wrote to his minister Friesenstein; "the consequences of this battle will be worse than the battle itself. I shall not survive the ruin of the Fatherland. Adieu for ever!" But he soon recovered from his despair, and in 1760 gained the important victories of Liegnitz and Torgau. He had now, however, to act on the defensive, and fortunately for him, the Russians, on the death of the empress Elizabeth, not only withdrew in 1762 from the compact against him, but for a time became his allies. On the 29th of October of that year he gained his last victory over the Austrians at Freiberg. Europe was by that time sick of war, every power being more or less exhausted.

The result was that, on the 15th of February 1763, a few days after the conclusion of the peace of Paris, the treaty of Hubertusburg was signed, Austria confirming Prussia in the possession of Silesia. (See SEVEN YEARS' WAR.)

It would be difficult to overrate the importance of the contribution thus made by Frederick to the politics of Europe. Prussia was now universally recognized as one of the great powers of the Continent, and she definitely took her place in Germany as the rival of Austria. From this time it was inevitable that there should be a final struggle between the two nations for predominance, and that the smaller German states should group themselves around one or the other. Frederick himself acquired both in Germany and Europe the indefinable influence which springs from the recognition of great gifts that have been proved by great deeds.

His first care after the war was, as far as possible, to enable the country to recover from the terrific blows by which it had been almost destroyed; and he was never, either before or after, seen to better advantage than in the measures he adopted for this end. Although his resources had been so completely drained that he had been forced to melt the silver in his palaces and to debase the coinage, his energy soon brought back the national prosperity. Pomerania and Neumark were freed from taxation for two years, Silesia for six months. Many nobles whose lands had been wasted received corn for seed; his war horses were within a few months to be found on farms all over Prussia; and money was freely spent in the re-erection of houses which had been destroyed. The coinage was gradually restored to its proper value, and trade received a favourable impulse by the foundation of the Bank of Berlin. All these matters were carefully looked into by Frederick himself, who, while acting as generously as his circumstances would allow, insisted on everything being done in the most efficient manner at the least possible cost. Unfortunately, he adopted the French ideas of excise, and the French methods of imposing and collecting taxes—a system known as the *Regie*. This system secured for him a large revenue, but it led to a vast amount of petty tyranny, which was all the more intolerable because it was carried out by French officials. It was continued to the end of Frederick's reign, and nothing did so much to injure his otherwise immense popularity. He was quite aware of the discontent the system excited, and the good-nature with which he tolerated the criticisms directed against it and him is illustrated by a well-known incident. Riding along the Jäger Strasse one day, he saw a crowd of people. "See what it is," he said to the groom who was attending him. "They have something posted up about your Majesty," said the groom, returning. Frederick, riding forward, saw a caricature of himself: "King in very melancholy guise," says Preuss (as translated by Carlyle), "seated on a stool, a coffee-mill between his knees, diligently grinding with the one hand, and with the other picking up any bean that might have fallen. 'Hang it lower,' said the king, beckoning his groom with a wave of the finger; 'lower, that they may not have to hurt their necks about it.' No sooner were the words spoken, which spread instantly, than there rose from the whole crowd one universal huzzah of joy. They tore the caricature into a thousand pieces, and rolled after the king with loud '*Lebe Hoch*, our Frederick for ever,' as he rode slowly away." There are scores of anecdotes about Frederick, but not many so well authenticated as this.

There was nothing about which Frederick took so much trouble as the proper administration of justice. He disliked the formalities of the law, and in one instance, "the miller Arnold case," in connexion with which he thought injustice had been done to a poor man, he dismissed the judges, condemned them to a year's fortress arrest, and compelled them to make good out of their own pockets the loss sustained by their supposed victim—not a wise proceeding, but one springing from a generous motive. He once defined himself as "*l'avocat du pauvre*," and few things gave him more pleasure than the famous answer of the miller whose windmill stood on ground which was wanted for the king's garden. The miller sturdily refused to sell it. "Not at any price?" said the king's agent; "could not the king take it

from you for nothing, if he chose?" "Have we not the *Kammergericht* at Berlin?" was the answer, which became a popular saying in Germany. Soon after he came to the throne Frederick began to make preparations for a new code. In 1747 appeared the *Codex Fridericianus*, by which the Prussian judicial body was established. But a greater monument of Frederick's interest in legal reform was the *Allgemeines preussisches Landrecht*, completed by the grand chancellor Count Johann H. C. von Carmer (1721–1801) on the basis of the *Project des Corporis Juris Fridericiani*, completed in the year 1749–1751 by the eminent jurist Samuel von Cocceji (1679–1755). The *Landrecht*, a work of vast labour and erudition, combines the two systems of German and Roman law supplemented by the law of nature; it was the first German code, but only came into force in 1794, after Frederick's death.

Looking ahead after the Seven Years' War, Frederick saw no means of securing himself so effectually as by cultivating the goodwill of Russia. In 1764 he accordingly concluded a treaty of alliance with the empress Catherine for eight years. Six years afterwards, unfortunately for his fame, he joined in the first partition of Poland, by which he received Polish Prussia, without Danzig and Thorn, and Great Poland as far as the river Netze. Prussia was then for the first time made continuous with Brandenburg and Pomerania.

The emperor Joseph II. greatly admired Frederick, and visited him at Neisse, in Silesia, in 1769, a visit which Frederick returned, in Moravia, in the following year. The young emperor was frank and cordial; Frederick was more cautious, for he detected under the respectful manner of Joseph a keen ambition that might one day become dangerous to Prussia. Ever after these interviews a portrait of the emperor hung conspicuously in the rooms in which Frederick lived, a circumstance on which some one remarked. "Ah yes," said Frederick, "I am obliged to keep that young gentleman in my eye." Nothing came of these suspicions till 1777, when, after the death of Maximilian Joseph, elector of Bavaria, without children, the emperor took possession of the greater part of his lands. The elector palatine, who lawfully inherited Bavaria, came to an arrangement, which was not admitted by his heir, Charles, duke of Zweibrücken. Under these circumstances the latter appealed to Frederick, who, resolved that Austria should gain no unnecessary advantage, took his part, and brought pressure to bear upon the emperor. Ultimately, greatly against his will, Frederick felt compelled to draw the sword, and in July 1778 crossed the Bohemian frontier at the head of a powerful army. No general engagement was fought, and after a great many delays the treaty of Teschen was signed on the 13th of May 1779. Austria received the circle of Burgau, and consented that the king of Prussia should take the Franconian principalities. Frederick never abandoned his jealousy of Austria, whose ambition he regarded as the chief danger against which Europe had to guard. He seems to have had no suspicion that evil days were coming in France. It was Austria which had given trouble in his time; and if her pride were curbed, he fancied that Prussia at least would be safe. Hence one of the last important acts of his life was to form, in 1785, a league of princes (the "*Fürstenbund*") for the defence of the imperial constitution, believed to be imperilled by Joseph's restless activity. The league came to an end after Frederick's death; but it is of considerable historical interest, as the first open attempt of Prussia to take the lead in Germany.

Frederick's chief trust was always in his treasury and his army. By continual economy he left in the former the immense sum of 70 million thalers; the latter, at the time of his death, numbered 200,000 men, disciplined with all the strictness to which he had throughout life accustomed his troops. He died at Sanssouci on the 17th of August 1786; his death being hastened by exposure to a storm of rain, stoically borne, during a military review. He passed away on the eve of tremendous events, which for a time obscured his fame; but now that he can be impartially estimated, he is seen to have been in many respects one of the greatest figures in modern history.

He was rather below the middle size, in youth inclined to

stoutness, lean in old age, but of vigorous and active habits. An expression of keen intelligence lighted up his features, and his large, sparkling grey eyes darted penetrating glances at every one who approached him. In his later years an old blue uniform with red facings was his usual dress, and on his breast was generally some Spanish snuff, of which he consumed large quantities. He shared many of the chief intellectual tendencies of his age, having no feeling for the highest aspirations of human nature, but submitting all things to a searching critical analysis. Of Christianity he always spoke in the mocking tone of the "enlightened" philosophers, regarding it as the invention of priests; but it is noteworthy that after the Seven Years' War, the trials of which steadied his character, he sought to strengthen the church for the sake of its elevating moral influence. In his judgments of mankind he often talked as a misanthrope. He was once conversing with Sulzer, who was a school inspector, about education. Sulzer expressed the opinion that education had of late years greatly improved. "In former times, your Majesty," he said, "the notion being that mankind were naturally inclined to evil, a system of severity prevailed in schools; but now, when we recognize that the inborn inclination of men is rather to good than to evil, schoolmasters have adopted a more generous procedure." "Ah, my dear Sulzer," replied the king, "you don't know this damned race" ("Ach, mein lieber Sulzer, er kennt nicht diese verdammte Race"). This fearful saying unquestionably expressed a frequent mood of Frederick's; and he sometimes acted with great harshness, and seemed to take a malicious pleasure in tormenting his acquaintances. Yet he was capable of genuine attachments. He was beautifully loyal to his mother and his sister Wilhelmina; his letters to the duchess of Gotha are full of a certain tender reverence; the two Keiths found him a devoted friend. But the true evidence that beneath his misanthropic moods there was an enduring sentiment of humanity is afforded by the spirit in which he exercised his kingly functions. Taking his reign as a whole, it must be said that he looked upon his power rather as a trust than as a source of personal advantage; and the trust was faithfully discharged according to the best lights of his day. He has often been condemned for doing nothing to encourage German literature; and it is true that he was supremely indifferent to it. Before he died a tide of intellectual life was rising all about him; yet he failed to recognize it, declined to give Lessing even the small post of royal librarian, and thought *Göts von Berlichingen* a vulgar imitation of vulgar English models. But when his taste was formed, German literature did not exist; the choice was between Racine and Voltaire on the one hand and Göttsched and Gellert on the other. He survived into the era of Kant, Goethe and Schiller, but he was not of it, and it would have been unreasonable to expect that he should in old age pass beyond the limits of his own epoch. As Germans now generally admit, it was better that he let his literature alone, since, left to itself, it became a thoroughly independent product. Indirectly he powerfully promoted it by deepening the national life from which it sprang. At a time when there was no real bond of cohesion between the different states, he stirred among them a common enthusiasm; and in making Prussia great he laid the foundation of a genuinely united empire.

BIBLIOGRAPHICAL NOTE.—The main sources for the biography of Frederick the Great are his own works, which, in the words of Leopold von Ranke, "deal with the politics and wars of the period with the greatest possible objectivity, i.e. truthfulness, and form an imperishable monument of his life and opinions." A magnificent edition of Frederick's complete works was issued (1846-1857), at the instance of Frederick William IV., under the supervision of the historian Johann D. E. Preuss (1785-1868). It is in thirty volumes, of which six contain verse, seven are historical, two philosophical, and three military, twelve being made up of correspondence. So long as the various state archives remained largely inaccessible, scribe historians relied upon this as their chief authority. Among works belonging to this period may be mentioned Thomas Carlyle, *History of Frederick II. of Prussia* (6 vols., London, 1838-1865); J. G. Droysen, *Friedrich der Grosse* (2 vols., Leipzig, 1874-1876, forming part V. of his *Geschichte der preussischen Politik*); Ranke, *Friedrich II. König von Preussen* (*Werke*, vols. li. and lii.). A great stimulus

to the study of Frederick's history has since been given by the publication of collections of documents preserved in various archives. Of these the most important is the great official edition of Frederick's political correspondence (Berlin, 1879), of which the thirty-first vol. appeared in 1906. Of later works, based on modern research, may be mentioned R. Koser, *König Friedrich der Grosse*, Bd. 2 (Stuttgart, 1893 and 1903; 3rd ed., 1905); Bourdeau, *Le Grand Frédéric* (2 vols., Paris, 1900-1902); L. Paul-Dubois, *Frédéric le Grand, d'après sa correspondance politique* (Paris, 1903); W. F. Reddaway, *Frederick the Great and the Rise of Prussia* (London, 1904). Of the numerous special studies may be noticed E. Zeller, *Friedrich der Grosse als Philosoph* (Berlin, 1886); H. Piège, *Die Staatstheorie Friedrichs des Grossen* (Münster, 1904); T. von Bernhardt, *Friedrich der Grosse als Feldherr* (2 vols., Berlin, 1881); Ernest Lavisse, *La Jeunesse de Grand Frédéric* (Paris, 1891, 3rd ed., 1899; Eng. transl., London, 1891); R. Brode, *Friedrich der Grosse und der Konflikt mit seinem Vater* (Leipzig, 1904); W. von Bremen, *Friedrich der Grosse* (Bd. ii. of *Erzieher des preussischen Heeres*, Berlin, 1905); G. Winter, *Friedrich der Grosse* (3 vols. in *Geisteshelden* series, Berlin, 1906); *Dreissig Jahre am Hofe Friedrichs des Grossen. Aus dem Tagebüchern des Reichsgrafen Ahasuerus Heinrich von Lehndorff, Kammerherrn der Königin Elisabeth Christine von Preussen* (Gotha, 1907). The great work on the wars of Frederick is that issued by the Prussian General Staff: *Die Kriege Friedrichs des Grossen* (12 vols. in three parts, Berlin, 1890-1904). For a full list of other works see Dahlgmann-Waitz, *Quellenkunde* (Leipzig, 1906). (J. St.; W. A. P.)

FREDERICK III. (1831-1888), king of Prussia and German emperor, was born at Potsdam on the 18th of October 1831, being the eldest son of Prince William of Prussia, afterwards first German emperor, and the princess Augusta. He was carefully educated, and in 1849-1850 studied at the university of Bonn. The next years were spent in military duties and in travels, in which he was accompanied by Moltke. In 1851 he visited England on the occasion of the Great Exhibition, and in 1855 became engaged to Victoria, princess royal of Great Britain, to whom he was married in London on the 25th of January 1858. On the death of his uncle in 1861 and the accession of his father, Prince Frederick William, as he was then always called, became crown prince of Prussia. His education, the influence of his mother, and perhaps still more that of his wife's father, the Prince Consort, had made him a strong Liberal, and he was much distressed at the course of events in Prussia after the appointment of Bismarck as minister. He was urged by the Liberals to put himself into open opposition to the government; this he refused to do, but he remonstrated privately with the king. In June 1863, however, he publicly dissociated himself from the press ordinances which had just been published. He ceased to attend meetings of the council of state, and was much away from Berlin. The opposition of the crown prince to the ministers was increased during the following year, for he was a warm friend of the prince of Augustenburg, whose claims to Schleswig-Holstein Bismarck refused to support. During the war with Denmark he had his first military experience, being attached to the staff of Marshal von Wrangel; he performed valuable service in arranging the difficulties caused by the disputes between the field marshal and the other officers, and was eventually given a control over him. After the war he continued to support the prince of Augustenburg and was strongly opposed to the war with Austria. During the campaign of 1866 he received the command of an army consisting of four army corps; he was assisted by General von Blumenthal, as chief of the staff, but took a very active part in directing the difficult operations by which his army fought its way through the mountains from Silesia to Bohemia, fighting four engagements in three days, and showed that he possessed genuine military capacity. In the decisive battle of Königgrätz the arrival of his army on the field of battle, after a march of nearly 20 m., secured the victory. During the negotiations which ended the war he gave valuable assistance by persuading the king to accept Bismarck's policy as regards peace with Austria. From this time he was very anxious to see the king of Prussia unite the whole of Germany, with the title of emperor, and was impatient of the caution with which Bismarck proceeded. In 1866 he paid a visit to Italy, and in the same year was present at the opening of the Suez Canal; on his way he visited the Holy Land.

He played a conspicuous part in the year 1870-1871, being appointed to command the armies of the Southern States,

General Blumenthal again being his chief of the staff; his troops won the victory of Wörth, took an important part in the battle of Sedan, and later in the siege of Paris. The popularity he won was of political service in preparing the way for the union of North and South Germany, and he was the foremost advocate of the imperial idea at the Prussian court. During the years that followed, little opportunity for political activity was open to him. He and the crown princess took a great interest in art and industry, especially in the royal museums; and the excavations conducted at Olympia and Pergamon with such great results were chiefly due to him. The crown princess was a keen advocate of the higher education of women, and it was owing to her exertions that the Victoria Lyceum at Berlin (which was named after her) was founded. In 1878, when the emperor was incapacitated by the shot of an assassin, the prince acted for some months as regent. His palace was the centre of all that was best in the literary and learned society of the capital. He publicly expressed his disapproval of the attacks on the Jews in 1878; and the coalition of Liberal parties founded in 1884 was popularly known as the "crown prince's party," but he scrupulously refrained from any act that might embarrass his father's government. For many reasons the accession of the prince was looked forward to with great hope by a large part of the nation. Unfortunately he was attacked by cancer in the throat; he spent the winter of 1887-1888 at San Remo; in January 1888 the operation of tracheotomy had to be performed. On the death of his father, which took place on the 9th of March, he at once journeyed to Berlin, but his days were numbered, and he came to the throne only to die. In these circumstances his accession could not have the political importance which would otherwise have attached to it, though it was disfigured by a vicious outburst of party passion in which the names of the emperor and the empress were constantly misused. While the Liberals hoped the emperor would use his power for some signal declaration of policy, the adherents of Bismarck did not scruple to make bitter attacks on the empress. The emperor's most important act was a severe reprimand addressed to Herr von Puttkamer, the reactionary minister of the interior, which caused his resignation; in the distribution of honours he chose many who belonged to classes and parties hitherto excluded from court favour. A serious difference of opinion with the chancellor regarding the proposal for a marriage between Prince Alexander of Battenberg and the princess Victoria of Prussia was arranged by the intervention of Queen Victoria, who visited Berlin to see her dying son-in-law. He expired at Potsdam on the 15th of June 1888, after a reign of ninety-nine days.

After the emperor's death Professor Geffcken, a personal friend, published in the *Deutsche Rundschau* extracts from the diary of the crown prince containing passages which illustrated his differences with Bismarck during the war of 1870. The object was to injure Bismarck's reputation, and a very unseemly dispute ensued. Bismarck at first, in a letter addressed to the new emperor, denied the authenticity of the extracts on the ground that they were unworthy of the crown prince. Geffcken was then arrested and imprisoned. He had undoubtedly shown that he was an injudicious friend, for the diary proved that the prince, in his enthusiasm for German unity, had allowed himself to consider projects which would have seriously compromised the relations of Prussia and Bavaria. The treatment of the crown prince's illness also gave rise to an acrimonious controversy. It arose from the fact that as early as May 1887 the German physicians recognized the presence of cancer in the throat, but Sir Morell Mackenzie, the English specialist who was also consulted, disputed the correctness of this diagnosis, and advised that the operation for removal of the larynx, which they had recommended, should not be undertaken. His advice was followed, and the differences between the medical men were made the occasion for a considerable display of national and political animosity.

The empress VICTORIA, who, after the death of her husband, was known as the empress Frederick, died on the 5th of August 1901 at the castle of Friedrichskron, Cronberg, near Homburg

v. d. H., where she spent her last years. Of the emperor's children two, Prince Sigismund (1864-1866) and Prince Waldemar (1860-1879), died in childhood. He left two sons, William, his successor as emperor, and Henry, who adopted a naval career. Of his daughters, the princess Charlotte was married to Bernard, hereditary prince of Meiningen; the princess Victoria to Prince Adolf of Schaumburg-Lippe; the princess Sophie to the duke of Sparta, crown prince of Greece; and the princess Margaretha to Prince Friedrich Karl of Hesse.

AUTHORITIES.—M. von Poschinger, *Kaiser Friedrich* (3 vols., Berlin, 1898-1900). Adapted into English by Sidney Whitman, *Life of the Emperor Frederick* (1901). See also Bismarck, *Reflections and Reminiscences*; Rennell Rodd, *Frederick, Crown Prince and Emperor* (1888); Gustav Freytag, *Der Kronprinz und die deutsche Kaiserkrone* (1889); English translation, 1890; Otto Richter, *Kaiser Friedrich III.* (2nd ed., Berlin, 1903). For his illness, the official publications, published both in English and German: *Die Krankheit Kaiser Friedrichs III.* (Berlin, 1888), and Morell Mackenzie, *The Fatal Illness of Frederick the Noble* (1888). Most of the copies of the *Deutsche Rundschau* containing the extracts from the crown prince's diary were confiscated, but there is an English edition, published in 1889. (J. W. H.)

FREDERICK III. (1272-1337), king of Sicily, third son of King Peter of Aragon and Sicily, and of Constance, daughter of Manfred. Peter died in 1285, leaving Aragon to his eldest son Alphonso, and Sicily to his second son James. When Alphonso died in 1291 James became king of Aragon, and left his brother Frederick as regent of Sicily. The war between the Angevins and the Aragonese for the possession of Sicily was still in progress, and although the Aragonese were successful in Italy James's position in Spain became very insecure to internal troubles and French attacks. Peace negotiations were begun with Charles II. of Anjou, but were interrupted by the successive deaths of two popes; at last under the auspices of Boniface VIII. James concluded a shameful treaty, by which, in exchange for being left undisturbed in Aragon and promised possession of Sardinia and Corsica, he gave up Sicily to the Church, for whom it was to be held by the Angevins (1295). The Sicilians refused to be made over once more to the hated French whom they had expelled in 1282, and found a national leader in the regent Frederick. In vain the pope tried to bribe him with promises and dignities; he was determined to stand by his subjects, and was crowned king by the nobles at Palermo in 1296. Young, brave and handsome, he won the love and devotion of his people, and guided them through the long years of storm and stress with wisdom and ability. Although the second Frederick of Sicily, he called himself third, being the third son of King Peter. He reformed the administration and extended the powers of the Sicilian parliament, which was composed of the barons, the prelates and the representatives of the towns.

His refusal to comply with the pope's injunctions led to a renewal of the war. Frederick landed in Calabria, where he seized several towns, encouraged revolt in Naples, negotiated with the Ghibellines of Tuscany and Lombardy, and assisted the house of Colonna against Pope Boniface. In the meanwhile James, who received many favours from the Church, married his sister Yolanda to Robert, the third son of Charles II. Unfortunately for Frederick, a part of the Aragonese nobles of Sicily favoured King James, and both John of Procida and Ruggiero di Lauria, the heroes of the war of the Vespers, went over to the Angevins, and the latter completely defeated the Sicilian fleet off Cape Orlando. Charles's sons Robert and Philip landed in Sicily, but after capturing Catania were defeated by Frederick, Philip being taken prisoner (1299), while several Calabrian towns were captured by the Sicilians. For two years more the fighting continued with varying success, until Charles of Valois, who had been sent by Boniface to invade Sicily, was forced to sue for peace, his army being decimated by the plague, and in August 1302 the treaty of Caltabellotta was signed, by which Frederick was recognized king of Trinacria (the name Sicily was not to be used) for his lifetime, and was to marry Eleonora, the daughter of Charles II.; at his death the kingdom was to revert to the Angevins (this clause was inserted chiefly to save Charles's face), and his children would receive

compensation elsewhere. Boniface tried to induce King Charles to break the treaty, but the latter was only too anxious for peace, and finally in May 1303 the pope ratified it, Frederick agreeing to pay him a tribute.

For a few years Sicily enjoyed peace, and the kingdom was reorganized. But on the descent of the emperor Henry VII., Frederick entered into an alliance with him, and in violation of the pact of Caltabellotta made war on the Angevins again (1313) and captured Reggio. He set sail for Tuscany to co-operate with the emperor, but on the latter's death (1314) he returned to Sicily. Robert, who had succeeded Charles II. in 1309, made several raids into the island, which suffered much material injury. A truce was concluded in 1317, but as the Sicilians helped the north Italian Ghibellines in the attack on Genoa, and Frederick seized some Church revenues for military purposes, the pope (John XXII.) excommunicated him and placed the island under an interdict (1321) which lasted until 1335. An Angevin fleet and army, under Robert's son Charles, was defeated at Palermo by Giovanni da Chiaramonte in 1325, and in 1326 and 1327 there were further Angevin raids on the island, until the descent into Italy of the emperor Louis the Bavarian distracted their attention. The election of Pope Benedict XII. (1334), who was friendly to Frederick, promised a respite; but after fruitless negotiations the war broke out once more, and Chiaramonte went over to Robert, owing to a private feud. In 1337 Frederick died at Paternone, and in spite of the peace of Caltabellotta his son Peter succeeded. Frederick's great merit was that during his reign the Aragonese dynasty became thoroughly national and helped to weld the Sicilians into a united people.

BIBLIOGRAPHY.—G. M. Mira, *Bibliografia Siciliana* (Palermo, 1875); of the contemporary authorities N. Speciale's "Historia Sicula" (in Muratori's *Script. rer. ital. x.*) is the most important; for the first years of Frederick's reign see M. Amari, *La Guerra dei Vespri Siciliani* (Florence, 1876), and F. Lanzani, *Storia dei Comuni Italiani* (Milan, 1882); for the latter years C. Cipolla, *Storia della signoria italiana* (Milan, 1881); also Testa, *Vita di Federico di Sicilia*. (L. V.)

FREDERICK I. (c. 1371–1440), elector of Brandenburg, founder of the greatness of the House of Hohenzollern, was a son of Frederick V., burgrave of Nuremberg, and first came into prominence by saving the life of Sigismund, king of Hungary, at the battle of Nicopolis in 1396. In 1397 he became burgrave of Nuremberg, and after his father's death in 1398 he shared Ansbach, Bayreuth, and the smaller possessions of the family, with his only brother John, but became sole ruler after his brother's death in 1420. Loyal at first to King Wenceslaus, the king's neglect of Germany drove Frederick to take part in his deposition in 1400, and in the election of Rupert III., count palatine of the Rhine, whom he accompanied to Italy in the following year. In 1401 he married Elizabeth, or Elsa, daughter of Frederick, duke of Bavaria-Landshut (d. 1393), and after spending some time in family and other feuds, took service again with King Sigismund in 1409, whom he assisted in his struggle with the Hungarian rebels. The double election to the German throne in 1410 first brought Frederick into relation with Brandenburg. Sigismund, anxious to obtain a other vote in the electoral college, appointed Frederick to exercise the Brandenburg vote on his behalf, and it was largely through his efforts that Sigismund was chosen German king. Frederick then passed some time as administrator of Brandenburg, where he restored a certain degree of order, and was formally invested with the electorate and margravate by Sigismund at Constance on the 18th of April 1417 (see **BRANDENBURG**). He took part in the war against the Hussites, but became estranged from Sigismund when in 1423 the king invested Frederick of Wettin, margrave of Meissen, with the vacant electoral duchy of Saxe-Wittenberg. In 1427 he sold his rights as burgrave to the town of Nuremberg, and he was a prominent member of the band of electors who sought to impose reforms upon Sigismund. After having been an unsuccessful candidate for the German throne in 1438, Frederick was chosen king of Bohemia in 1440, but declined the proffered honour. He took part in the election of Frederick III.

as German king in 1440, and died at Radolzburg on the 21st of September in the same year. In 1902 a bronze statue was erected to his memory at Friesack, and there is also a marble one of the elector in the "Siegesallee" at Berlin.

See A. F. Riedel, *Zehn Jahre aus der Geschichte der Almherrn des preussischen Königshauses* (Berlin, 1851); E. Brandenburg, *König Sigismund und Kurfürst Friedrich I. von Brandenburg* (Berlin, 1891); and O. Franklin, *Die deutsche Politik Friedrichs I. Kurfürsten von Brandenburg* (Berlin, 1851).

FREDERICK I. (1425–1476), elector palatine of the Rhine, surnamed "the Victorious," and called by his enemies "wicked Fritz," second son of the elector palatine Louis III., was born on the 1st of August 1425. He inherited a part of the Palatinate on his father's death in 1439, but soon surrendered this inheritance to his elder brother, the elector Louis IV. On his brother's death in 1449, however, he became guardian of the young elector Philip, and ruler of the land. In 1451 he persuaded the nobles to recognize him as elector, on condition that Philip should be his successor, a scheme which was disliked by the emperor Frederick III. The elector was successful in various wars with neighbouring rulers, and was a leading member of the band of princes who formed plans to secure a more efficient government for Germany, and even discussed the deposition of Frederick III. Frederick himself was mentioned as a candidate for the German throne, but the jealousies of the princes prevented any decisive action, and soon became so acute that in 1450 they began to fight among themselves. In alliance with Louis IX., duke of Bavaria-Landshut, Frederick gained several victories during the struggle, and in 1462 won a decisive battle at Seckenheim over Ulrich V., count of Württemberg. In 1472 the elector married Clara Tott, or Dett, the daughter of an Augsburg citizen, and by her he had two sons, Frederick, who died during his father's lifetime, and Louis (d. 1524), who founded the line of the counts of Löwenstein. He died at Heidelberg on the 12th of December 1476, and was succeeded, according to the compact, by his nephew Philip. Frederick was a cultured prince, and, in spite of his warlike career, a wise and intelligent ruler. He added largely to the area of the Palatinate, and did not neglect to further its internal prosperity.

See N. Feeser, *Friedrich der Siegreiche, Kurfürst von der Pfalz* (Neuburg, 1880); C. J. Kremer, *Geschichte des Kurfürsten Friedrichs I. von der Pfalz* (Leipzig, 1765); and K. Meusel, *Kurfürst Friedrich der Siegreiche von der Pfalz* (Munich, 1861).

FREDERICK II. (1482–1556), surnamed "the Wise," elector palatine of the Rhine, fourth son of the elector Philip, was born on the 9th of December 1482. Of an active and adventurous temperament, he fought under the emperor Maximilian I. in 1508, and afterwards served the Habsburgs loyally in other ways. He worked to secure the election of Charles, afterwards the emperor Charles V., as the successor of Maximilian in 1519; fought in two campaigns against the Turks; and being disappointed in his hope of obtaining the hand of one of the emperor's sisters, married in 1535 Dorothea (d. 1580), daughter of Christian II., who had been driven from the Danish throne. The Habsburgs promised their aid in securing this crown for Frederick, but, like many previous promises made to him, this came to nothing. Having spent his time in various parts of Europe, and incurred heavy debts on account of his expensive tastes, Frederick became elector palatine by the death of his brother, Louis V., in March 1544. With regard to the religious troubles of Germany, he took up at first the rôle of a mediator, but in 1545 he joined the league of Schmalkalden, and in 1546 broke definitely with the older faith. He gave a little assistance to the league in its war with Charles, but soon submitted to the emperor, accepted the *Interim* issued from Augsburg in May 1548, and afterwards acted in harmony with Charles. The elector died on the 26th of February 1556, and as he left no children was succeeded by his nephew, Otto Henry (1502–1559). He was a great benefactor to the university of Heidelberg.

Frederick's life, *Annales de vita et rebus gestis Friderici II. electoris palatini* (Frankfurt, 1624), was written by his secretary Hubert Thomas Leodius; this has been translated into German by E. von Bilow (Breslau, 1849). See also Rott, *Friedrich II. von der Pfalz und die Reformation* (Heidelberg, 1904).

FREDERICK III. (1515-1576), called "the Pious," elector palatine of the Rhine, eldest son of John II., count palatine of Simmern, was born at Simmern on the 14th of February 1515. In 1537 he married Maria (d. 1567), daughter of Casimir, prince of Bayreuth, and in 1546, mainly as a result of this union, adopted the reformed doctrines, which had already made considerable progress in the Palatinate. He lived in comparative obscurity and poverty until 1557, when he became count palatine of Simmern by his father's death, succeeding his kinsman, Otto Henry (1502-1559), as elector palatine two years later. Although inclined to the views of Calvin rather than to those of Luther, the new elector showed great anxiety to unite the Protestants; but when these efforts failed, and the breach between the followers of the two reformers became wider, he definitely adopted Calvinism. This form of faith was quickly established in the Palatinate; in its interests the "Heidelberg Catechism" was drawn up in 1563; and Catholics and Lutherans were persecuted alike, while the churches were denuded of all their ornaments. The Lutheran princes wished to root out Calvinism in the Palatinate, but were not willing to exclude the elector from the benefits of the religious peace of Augsburg, which were confined to the adherents of the confession of Augsburg, and the matter came before the diet in 1566. Boldly defending his position, Frederick refused to give way an inch, and as the Lutherans were unwilling to proceed to extremities the emperor Maximilian II. could only warn him to mend his ways. The elector was an ardent supporter of the Protestants abroad, whom, rather than the German Lutherans, he regarded as his co-religionists. He aided the Huguenots in France and the insurgents in the Netherlands with men and money; one of his sons, John Casimir (1543-1592), took a prominent part in the French wars of religion, while another, Christopher, was killed in 1574 fighting for the Dutch at Mooker Heath. In his later years Frederick failed in his efforts to prevent the election of a member of the Habsburg family as Roman king, to secure the abrogation of the "ecclesiastical reservation" clause in the peace of Augsburg, or to obtain security for Protestants in the territories of the spiritual princes. He was assiduous in caring for the material, moral and educational welfare of his electorate, and was a benefactor to the university of Heidelberg. The elector died at Heidelberg on the 26th of October 1576, and was succeeded by his elder surviving son, Louis (1530-1583), who had offended his father by adopting Lutheranism.

See A. Kluckhohn, *Friedrich der Fromme* (Nördlingen, 1877-1879); and *Briefe Friedrichs des Frommen*, edited by Kluckhohn (Brunswick, 1868-1872).

FREDERICK IV. (1574-1610), elector palatine of the Rhine, only surviving son of the elector Louis VI., was born at Amberg on the 5th of March 1574. His father died in October 1583, when the young elector came under the guardianship of his uncle John Casimir, an ardent Calvinist, who, in spite of the wishes of the late elector, a Lutheran, had his nephew educated in his own form of faith. In January 1592, on the death of John Casimir, Frederick undertook the government of the Palatinate, and continued the policy of his uncle, hostility to the Catholic Church and the Habsburgs, and co-operation with foreign Protestants. He was often in communication with Henry of Navarre, afterwards Henry IV. of France, and like him was unremitting in his efforts to conclude a league among the German Protestants, while he sought to weaken the Habsburgs by refusing aid for the Turkish War. After many delays and disappointments the Union of Evangelical Estates was actually formed in May 1608, under the leadership of the elector, and he took a prominent part in directing the operations of the union until his death, which occurred on the 19th of September 1610. Frederick was very extravagant, and liked to surround himself with pomp and luxury. He married in 1593 Louise, daughter of William the Silent, prince of Orange, and was succeeded by Frederick, the elder of his two sons.

See M. Ritter, *Geschichte der deutschen Union* (Schaffhausen, 1867-1873); and L. Häusser, *Geschichte der rheinischen Pfalz* (Heidelberg, 1859).

FREDERICK V. (1596-1632), elector palatine of the Rhine and king of Bohemia, son of the elector Frederick IV. by his wife, Louisa Juliana, daughter of William the Silent, prince of Orange, was born at Amberg on the 26th of August 1596. He became elector on his father's death in September 1610, and was under the guardianship of his kinsman, John II., count palatine of Zweibrücken (d. 1635), until he was declared of age in July 1614. Having received a good education, Frederick had married Elizabeth, daughter of the English king James I., in February 1613, and was the recognized head of the Evangelical Union founded by his father to protect the interests of the Protestants. In 1619 he stepped into a larger arena. Before this date the estates of Bohemia, Protestant in sympathy and dissatisfied with the rule of the Habsburgs, had been in frequent communication with the elector palatine, and in August 1619, a few months after the death of the emperor Matthias, they declared his successor, Ferdinand, afterwards the emperor Ferdinand II., deposed, and chose Frederick as their king. After some hesitation the elector yielded to the entreaties of Christian I., prince of Anhalt (1568-1630), and other sanguine supporters, and was crowned king of Bohemia at Prague on the 4th of November 1619. By this time the emperor Ferdinand was able to take the aggressive, while Frederick, disappointed at receiving no assistance either from England or from the Union, had few soldiers and little money. Consequently on the 8th of November, four days after his coronation, his forces were easily routed by the imperial army under Tilly at the White Hill, near Prague, and his short reign in Bohemia ended abruptly. Soon afterwards the Palatinate was overrun by the Spaniards and Bavarians, and after a futile attempt to dislodge them, Frederick, called in derision the "Winter King," sought refuge in the Netherlands. Having been placed under the imperial ban his electorate was given in 1623 to Maximilian I. of Bavaria, who also received the electoral dignity.

The remainder of Frederick's life was spent in comparative obscurity, although his restoration was a constant subject of discussion among European diplomatists. He died at Mainz on the 29th of November 1632, having had a large family, among his children being Charles Louis (1617-1680), who regained the Palatinate at the peace of Westphalia in 1648, and Sophia, who married Ernest Augustus, afterwards elector of Hanover, and was the mother of George I., king of Great Britain. His third son was Prince Rupert, the hero of the English civil war, and another son was Prince Maurice (1620-1652), who also assisted his uncle Charles I. during the civil war. Having sailed with Rupert to the West Indies, Maurice was lost at sea in September 1652.

In addition to the numerous works which treat of the outbreak of the Thirty Years' War see A. Gindely, *Friedrich V. von der Pfalz* (Prague, 1884); J. Kreba, *Die Politisch der evangelischen Union im Jahre 1618* (Breslau, 1890-1901); M. Ritter, "Friedrich V.," in the *Allgemeine deutsche Biographie*, Band vii. (Leipzig, 1878); and *Deutsche Lieder auf den Winterkönig*, edited by R. Wolkan (Prague, 1899).

FREDERICK I. (1369-1428), surnamed "the Warlike," elector and duke of Saxony, was the eldest son of Frederick "the Stern," count of Osterland, and Catherine, daughter and heiress of Henry VIII., count of Coburg. He was born at Altenburg on the 29th of March 1369, and was a member of the family of Wettin. When his father died in 1381 some trouble arose over the family possessions, and in the following year an arrangement was made by which Frederick and his brothers shared Meissen and Thuringia with their uncles Balthasar and William. Frederick's brother George died in 1402, and his uncle William in 1407. A further dispute then arose, but in 1410 a treaty was made at Naumburg, when Frederick and his brother William added the northern part of Meissen to their lands; and in 1425 the death of William left Frederick sole ruler. In the German town war of 1388 he assisted Frederick V. of Hohenzollern, burgrave of Nuremberg, and in 1391 did the same for the Teutonic Order against Ladislaus V., king of Poland and prince of Lithuania. He supported Rupert III., elector palatine of the Rhine, in his struggle with King Wenceslaus for the German

throne, probably because Wenceslaus refused to fulfil a promise to give him his sister Anna in marriage. The danger to Germany from the Hussites induced Frederick to ally himself with the German and Bohemian king Sigismund; and he took a leading part in the war against them, during the earlier years of which he met with considerable success. In the prosecution of this enterprise Frederick spent large sums of money, for which he received various places in Bohemia and elsewhere in pledge from Sigismund, who further rewarded him in January 1423 with the vacant electoral duchy of Saxe-Wittenberg; and Frederick's formal investiture followed at Ofen on the 1st of August 1425. Thus spurred to renewed efforts against the Hussites, the elector was endeavouring to rouse the German princes to aid him in prosecuting this war when the Saxon army was almost annihilated at Aussig on the 16th of August 1426. Returning to Saxony, Frederick died at Altenburg on the 4th of January 1428, and was buried in the cathedral at Meissen. In 1402 he married Catherine of Brunswick, by whom he left four sons and two daughters. In 1409, in conjunction with his brother William, he founded the university of Leipzig, for the benefit of German students who had just left the university of Prague. Frederick's importance as an historical figure arises from his having obtained the electorate of Saxe-Wittenberg for the house of Wettin, and transformed the margraviate of Meissen into the territory which afterwards became the kingdom of Saxony. In addition to the king of Saxony, the sovereigns of England and of the Belgians are his direct descendants.

There is a life of Frederick by G. Spalatin in the *Scriptores rerum Germanicarum præcipue Saxoniarum*, Band ii., edited by J. B. Mencke (Leipzig, 1728-1730). See also C. W. Böttiger and Th. Fische, *Geschichte des Kurfürsten und Königreichs Sachsen* (Gotha, 1867-1873); and J. G. Horn, *Lebens- und Heldengeschichte Friedrichs des Streibaren* (Leipzig, 1733).

FREDERICK II. (1411-1464), called "the Mild," elector and duke of Saxony, eldest son of the elector Frederick I., was born on the 22nd of August 1411. He succeeded his father as elector in 1428, but shared the family lands with his three brothers, and was at once engaged in defending Saxony against the attacks of the Hussites. Freed from these enemies about 1432, and turning his attention to increasing his possessions, he obtained the burgraviate of Meissen in 1439, and some part of Lower Lusatia after a struggle with Brandenburg about the same time. In 1438 it was decided that Frederick, and not his rival, Bernard IV., duke of Saxe-Lauenburg, was entitled to exercise the Saxon electoral vote at the elections for the German throne; and the elector then aided Albert II. to secure this dignity, performing a similar service for his own brother-in-law, Frederick, afterwards the emperor Frederick III., two years later. Family affairs, meanwhile, occupied Frederick's attention. One brother, Henry, having died in 1435, and another, Sigismund (d. 1463), having entered the church and become bishop of Würzburg, Frederick and his brother William (d. 1482) were the heirs of their childless cousin, Frederick "the Peaceful," who ruled Thuringia and other parts of the lands of the Wettins. On his death in 1440 the brothers divided Frederick's territory, but this arrangement was not satisfactory, and war broke out between them in 1446. Both combatants obtained extraneous aid, but after a desolating struggle peace was made in January 1451, when William received Thuringia, and Frederick Altenburg and other districts. The remainder of the elector's reign was uneventful, and he died at Leipzig on the 7th of September 1464. By his wife, Margaret (d. 1486), daughter of Ernest, duke of Styria, he left two sons and four daughters. In July 1455 occurred the celebrated *Prinzenraub*, the attempt of a knight named Kunz von Kaufungen (d. 1455) to abduct Frederick's two sons, Ernest and Albert. Having carried them off from Altenburg, Kunz was making his way to Bohemia when the plot was accidentally discovered and the princes restored.

See W. Schäfer, *Der Montag vor Kiliani* (1855); J. Gersdorf, *Einige Aitenstücke zur Geschichte des sächsischen Prinzenraubes* (1855); and T. Carlyle, *Critical and Miscellaneous Essays*, vol. iv. (London, 1899).

FREDERICK III. (1463-1525), called "the Wise," elector of Saxony, eldest son of Ernest, elector of Saxony, and Elizabeth,

daughter of Albert, duke of Bavaria-Munich (d. 1508), was born at Torgau, and succeeded his father as elector in 1486. Retaining the government of Saxony in his own hands, he shared the other possessions of his family with his brother John, called "the Stedfast" (1468-1532). Frederick was among the princes who pressed the need of reform upon the German king Maximilian I. in 1495, and in 1500 he became president of the newly-formed council of regency (*Reichsregiment*). He took a genuine interest in learning; was a friend of Georg Spalatin; and in 1502 founded the university of Wittenberg, where he appointed Luther and Melancthon to professorships. In 1493 he had gone as a pilgrim to Jerusalem, and had been made a knight of the Holy Sepulchre; but, although he remained throughout life an adherent of the older faith, he seems to have been drawn into sympathy with the reformers, probably through his connexion with the university of Wittenberg. In 1520 he refused to put into execution the papal bull which ordered Luther's writings to be burned and the reformer to be put under restraint or sent to Rome; and in 1521, after Luther had been placed under the imperial ban by the diet at Worms, the elector caused him to be conveyed to his castle at the Wartburg, and afterwards protected him while he attacked the enemies of the Reformation. In 1519, Frederick, who alone among the electors refused to be bribed by the rival candidates for the imperial throne, declined to be a candidate for this high dignity himself, and assisted to secure the election of Charles V. He died unmarried at Langau, near Annaberg, on the 5th of May 1525.

See G. Spalatin, *Das Leben und die Zeitgeschichte Friedrichs des Weisen*, edited by C. G. Neudecker and L. Preller (Jena, 1851); M. M. Tutzschmann, *Friedrich der Weise, Kurfürst von Sachsen* (Grimma, 1838); and T. Kolde, *Friedrich der Weise und die Anfänge der Reformation* (Erlangen, 1881).

FREDERICK, a city and the county-seat of Frederick county, Maryland, U.S.A., on Carroll's Creek, a tributary of the Monocacy, 61 m. by rail W. by N. from Baltimore and 45 m. N.W. from Washington. Pop. (1890) 8193; (1900) 9296, of whom 1535 were negroes; (1910 census) 10,411. It is served by the Baltimore & Ohio and the Northern Central railways, and by two interurban electric lines. Immediately surrounding it is the rich farming land of the Monocacy valley, but from a distance it appears to be completely shut in by picturesque hills and mountains; to the E., the Linga ore Hills; to the W., Catocin Mountain; and to the S., Sugar Loaf Mountain. It is built for the most part of brick and stone. Frederick is the seat of the Maryland school for the deaf and dumb and of the Woman's College of Frederick (1893; formerly the Frederick Female Seminary, opened in 1843), which in 1907-1908 had 212 students, 121 of whom were in the Conservatory of Music. Francis Scott Key and Roger Brooke Taney were buried here, and a beautiful monument erected to the memory of Key stands at the entrance to Mount Olivet cemetery. Frederick has a considerable agricultural trade and is an important manufacturing centre, its industries including the canning of fruits and vegetables, and the manufacture of flour, bricks, brushes, leather goods and hosiery. The total value of the factory product in 1905 was \$1,037,921, being 34.7% more than in 1900. The municipality owns and operates its water-works and electric-lighting plant. Frederick, so named in honour of Frederick Calvert, son and afterward successor of Charles, Lord Baltimore, was settled by Germans in 1733, and was laid out as a town in 1745, but was not incorporated until 1817. Here in 1755 General Braddock prepared for his disastrous expedition against the French at Fort Duquesne (Pittsburg). During the Civil War the city was occupied on different occasions by Unionists and Confederates, and was made famous by Whittier's poem "Barbara Frietche."

FREDERICK AUGUSTUS I. (1750-1827), king of Saxony, son of the elector Frederick Christian, was born at Dresden on the 23rd of December 1750. He succeeded his father under the guardianship of Prince Xavier in 1763, and was declared of age in 1768. In the following year (January 17, 1769) he married Princess Maria Amelia, daughter of Duke Frederick of Zweibrücken, by whom he had only one child, Princess Augusta (born June 21, 1782). One of his chief aims was the reduction

of taxes and imposts and of the army. He was always extremely methodical and conscientious, and a good example to all his officials, whence his surname "the Just." On account of the claims of his mother on the inheritance of her brother, the elector of Bavaria, he sided with Frederick the Great in the short Bavarian succession war of 1778 against Austria. At the peace of Teschen, which concluded the war, he received 6 million florins, which he employed partly in regaining those parts of his kingdom which had been lost, and partly in favour of his relatives. In 1785 he joined the league of German princes (*Deutscher Fürstentbund*) formed by Prussia, but without prejudice to his neutrality. Thus he remained neutral during the quarrel between Austria and Prussia in 1790. In the following year he declined the crown of Poland. He refused to join the league against France (February 7, 1792), but when war was declared his duty to the Empire necessitated his taking part in it. Even after the peace of Basel (April 5, 1795) he continued the war. But when the French army, during the following year, advanced into the heart of Germany, he was compelled by General Jourdan to retreat (August 13, 1796). He maintained his neutrality during the war between France and Austria in 1805, but in the following year he joined Prussia against France. After the disastrous battle of Jena he concluded a treaty of peace with Napoleon at Posen (December 11, 1806), and, assuming the title of king, he joined the Confederation of the Rhine. But he did not alter the constitution and administration of his new kingdom. After the peace of Tilsit (July 9, 1807) he was created by Napoleon grand-duke of Warsaw, but his sovereignty of Poland was little more than nominal. There was a kind of friendship between Frederick Augustus and Napoleon. In 1809 Frederick Augustus fought with him against Austria. On several occasions (1807, 1812, 1813) Napoleon was entertained at Dresden, and when, on his return from his disastrous Russian campaign, he passed through Saxony by Dresden (December 16, 1812), Frederick Augustus remained true to his friend and ally. It was only during April 1813 that he made overtures to Austria, but he soon afterwards returned to the side of the French. He returned to Dresden on the 10th of May and was present at the terrible battle of August 26 and 27, in which Napoleon's army and his own were defeated. He fell into the hands of the Allies after their entry into Leipzig on the 10th of October 1813; and, although he regained his freedom after the congress of Vienna, he was compelled to give up the northern part—three-fifths—of his kingdom to Prussia (May 21, 1814). He entered Dresden on the 7th of July, and was enthusiastically welcomed by his people. The remainder of his life was spent in repairing the damages caused by the Napoleonic wars, in developing the agricultural, commercial and industrial resources of his kingdom, reforming the administration of justice, establishing hospitals and other charitable institutions, encouraging art and science and promoting education. He had a special interest in botany, and originated the beautiful park at Pillnitz. His reign throughout was characterized by justice, probity, moderation and prudence. He died on the 5th of May 1827.

BIBLIOGRAPHY.—The earlier lives, by C. E. Weisse (1811), A. L. Herrmann (1827), Politz (1830), are mere panegyrics. On the other side see Flathe in *Allgemeine deutsche Biographie*, and Böttiger-Flathe, *History of Saxony* (2nd ed., 1867 ff.), vols. ii. and iii.; A. Bonnelons, *Un Allié de Napoléon, Frédéric Auguste, premier roi de Saxe* . . . (Paris, 1902); Fritz Friedrich, *Politik Sachsens 1801-1803* (1898); P. Rühlmann, *Öffentliches Meinungs* . . . 1806-1813 (1902). There are many pamphlets bearing on the Saxon question and on Frederick Augustus during the years 1814 and 1815. (J. HN.)

FREDERICK AUGUSTUS II. (1797-1854), king of Saxony, eldest son of Prince Maximilian and of Caroline Maria Theresa of Parma, was born on the 18th of May 1797. The unsettled times in which his youth was passed necessitated his frequent change of residence, but care was nevertheless taken that his education should not be interrupted, and he also acquired, through his journeys in foreign states (Switzerland 1818, Montenegro 1838, England and Scotland 1844) and his intercourse with men of eminence, a special taste for art and for natural science. He was himself a good landscape-painter and had a fine

collection of engravings on copper. He was twice married—in 1819 (October 7) to the duchess Caroline, fourth daughter of the emperor Francis I. of Austria (d. May 22, 1832), and in 1833 (April 4) to Maria, daughter of Maximilian I. of Bavaria. There were no children of either marriage. During the government of his uncles (Frederick Augustus I. and Anthony) he took no part in the administration of the country, though he was the sole heir to the crown. In 1830 a rising in Dresden led to his being named joint regent of the kingdom along with King Anthony on the 13th of September; and in this position his popularity and his wise and liberal reforms (for instance, in arranging public audiences) speedily quelled all discontent. On the 6th of June 1836 he succeeded his uncle. Though he administered the affairs of his kingdom with enlightened liberality Saxony did not escape the political storms which broke upon Germany in 1848. He elected Liberal ministers, and he was at first in favour of the programme of German unity put forward at Frankfort, but he refused to acknowledge the democratic constitution of the German parliament. This attitude led to the insurrection at Dresden in May 1849, which was suppressed by the help of Prussian troops. From that time onward his reign was tranquil and prosperous. Later Count Beust, leader of the Austrian and feudal party in Saxony, became his principal minister and guided his policy on most occasions. His death occurred accidentally through the upsetting of his carriage near Brennöhel, between Imst and Wemms in Tirol (August 9, 1854). Frederick Augustus devoted his leisure hours chiefly to the study of botany. He made botanical excursions into different countries, and *Flora Marienbadensis, oder Pflanzen und Gebirgsarten, gesammelt und beschrieben*, written by him, was published at Prague by Kedler, 1837.

See Böttiger-Flathe, *History of Saxony*, vol. iii.; R. Freiherr von Friesen, *Erinnerungen* (2 vols., Dresden, 1881); F. F. Graf von Beust, *Aus drei-vierel Jahrhunderten* (2 vols., 1887); Flathe, in *Allg. deutsche Biogr.* (J. HN.)

FREDERICK CHARLES (FRIEDRICH KARL NIKOLAUS), PRINCE (1828-1885), Prussian general field marshal, son of Prince Charles of Prussia and grandson of King Frederick William III., was born in Berlin on the 20th of March 1828. He was educated for the army, which he entered on his tenth birthday as second lieutenant in the 14th Foot Guards. He became first lieutenant in 1844, and in 1846 entered the university of Bonn, where he stayed for two years, being accompanied throughout by Major von Roon, afterwards the famous war minister. In 1848 he became a company commander in his regiment, and soon afterwards served in the Schleswig-Holstein War on the staff of Marshal von Wrangel, being present at the battle of Schleswig (April 23, 1848). Later in 1848 he became *Rittmeister* in the *Garde du Corps* cavalry regiment, and in 1849 major in the Guard Hussars. In this year the prince took part in the campaign against the Baden insurgents, and was wounded at the action of Wiesenthal while leading a desperate charge against entrenched infantry. After this experience the wild courage of his youth gave place to the unshakable resolution which afterwards characterized the prince's generalship. In 1852 he became colonel, and in 1854 major-general and commander of a cavalry brigade. In this capacity he was brought closely in touch with General von Reyher, the chief of the general staff, and with Moltke. He married, in the same year, Princess Marie Anne of Anhalt. In 1857 he became commander of the 1st Guard Infantry division, but very shortly afterwards, on account of disputes concerned with the training methods then in force, he resigned the appointment.

In 1858 he visited France, where he minutely investigated the state of the French army, but it was not long before he was recalled, for in 1859, in consequence of the Franco-Austrian War, Prussia mobilized her forces, and Frederick Charles was made a divisional commander in the II. army corps. In this post he was given the liberty of action which had previously been denied to him. About this time (1860) the prince gave a lecture to the officers of his command on the French army and its methods, the substance of which (*Eine militärische Denkschrift*

1808 P. F. K., Frankfort on Main, 1866) was circulated more widely than the author intended, and in the French translation gave rise to much indignation in France. In 1861 Frederick Charles became general of cavalry. He was then commander of the III. (Brandenburg) army corps. This post he held from 1860 to 1870, except during the campaigns of 1864 and 1866, and in it he displayed his real qualities as a troop leader. His self-imposed task was to raise the military spirit of his troops to the highest possible level, and ten years of his continuous and thorough training brought the III. corps to a pitch of real efficiency which the Guard corps alone, in virtue of its special recruiting powers, slightly surpassed. Prince Frederick Charles' work was tested to the full when von Alvensleben and the III. corps engaged the whole French army on the 16th of August 1870. In 1864 the prince once more fought against the Danes under his old leader "Papa" Wrangel. The Prussian contingent under Frederick Charles formed a corps of the allied army, and half of it was drawn from the III. corps. After the storming of the Düppel lines the prince succeeded Wrangel in the supreme command, with Lieutenant-General Freiherr von Moltke as his chief of staff. These two great soldiers then planned and brilliantly carried out the capture of the island of Alsens, after which the war came to an end.

In 1866 came the Seven Weeks' War with Austria. Prince Frederick Charles was appointed to command the I. Army, which he led through the mountains into Bohemia, driving before him the Austrians and Saxons to the upper Elbe, where on the 3rd of July took place the decisive battle of Königgrätz or Sadowa. This was brought on by the initiative of the leader of the I. Army, which had to bear the brunt of the fighting until the advance of the II. Army turned the Austrian flank. After the peace he returned to the III. army corps, which he finally left, in July 1870, when appointed to command the II. German Army in the war with France. In the early days of the advance the prince's ruthless energy led to much friction between the I. and II. Armies (see FRANCO-GERMAN WAR), while his strategical mistakes seriously embarrassed the great headquarters staff. The advance of the II. Army beyond the Saar to the Moselle and from that river to the Meuse displayed more energy than careful strategy, but herein at least the "Red Prince" (as he was called from the colour of his favourite hussar uniform) was in thorough sympathy with the king's headquarters on the one hand and the feelings of the troops on the other. Then came the discovery that the French were not in front, but to the right rear of the II. Army (August 16). Alvensleben with the III. corps held the French to their ground at Vionville while the prince hurried together his scattered forces. He himself directed with superb tactical skill the last efforts of the Germans at Vionville, and the victory of St Privat on the 18th was due to his leadership (see MERZ), which shone all the more by contrast with the failures of the I. Army at Gravelotte. The prince was left in command of the forces which blockaded Bazaine in Metz, and received the surrender of that place and of the last remaining field army of the enemy. He was promoted at once to the rank of general field marshal, and shortly afterwards the II. Army was despatched to aid in crushing the newly organized army of the French republic on the Loire. Here again he retrieved strategical errors by energy and tactical skill, and his work was in the end crowned by the victory of Le Mans on the 12th of January 1871. Of all the subordinate leaders on the German side none enjoyed a greater and a better deserved reputation than the Red Prince.

He now became inspector-general of the 3rd "army inspection," and a little later inspector of cavalry, and in the latter post he was largely instrumental in bringing the German cavalry to the degree of perfection in manœuvre and general training which it gradually attained in the years after the war. He never ceased to improve his own soldierly qualities by further study and by the conduct of manœuvres on a large scale. His sternness of character kept him aloof from the court and from his own family, and he spent his leisure months chiefly on his various country estates. In 1872 and in 1882 he travelled in the Mediterranean and the Near East. He died on the 15th of June 1885 at Klein-Glienicke

near Berlin, and was buried at the adjacent church of Nikolskoe. His third daughter, Princess Louise Margareta, was married, in March 1879, to the duke of Connaught.

FREDERICK HENRY (1584-1647), prince of Orange, the youngest child of William the Silent, was born at Delft about six months before his father's assassination on the 29th of January 1584. His mother, Louise de Coligny, was daughter of the famous Huguenot leader, Admiral de Coligny, and was the fourth wife of William the Silent. The boy was trained to arms by his elder brother, Maurice of Nassau, one of the first generals of his age. On the death of Maurice in 1625, Frederick Henry succeeded him in his paternal dignities and estates, and also in the stadtholderates of the five provinces of Holland, Zealand, Utrecht, Overysel and Gelderland, and in the important posts of captain and admiral-general of the Union. Frederick Henry proved himself scarcely inferior to his brother as a general, and a far more capable statesman and politician. During twenty-two years he remained at the head of affairs in the United Provinces, and in his time the power of the stadtholderate reached its highest point. The "Period of Frederick Henry," as it is usually styled by Dutch writers, is generally accounted the golden age of the republic. It was marked by great military and naval triumphs, by world-wide maritime and commercial expansion, and by a wonderful outburst of activity in the domains of art and literature. The chief military exploits of Frederick Henry were the sieges and captures of Hertogenbosch in 1629, of Maastricht in 1632, of Breda in 1637, of Sas van Ghent in 1644, and of Hulst in 1645. During the greater part of his administration the alliance with France against Spain had been the pivot of Frederick Henry's foreign policy, but in his last years he sacrificed the French alliance for the sake of concluding a separate peace with Spain, by which the United Provinces obtained from that power all the advantages for which they had for eighty years been contending. Frederick Henry died on the 14th of March 1647, and was buried with great pomp beside his father and brother at Delft. The treaty of Münster, ending the long struggle between the Dutch and the Spaniards, was not actually signed until the 30th of January 1648, the illness and death of the stadtholder having caused a delay in the negotiations. Frederick Henry was married in 1625 to Amalia von Solms, and left one son, William II. of Orange, and four daughters.

Frederick Henry left an account of his campaigns in his *Mémoires de Frédéric Henri* (Amsterdam, 1743). See *Cambridge Mod. Hist.* vol. iv. chap. 24, and the bibliography on p. 931.

FREDERICK LOUIS (1707-1751), prince of Wales, eldest son of George II., was born at Hanover on the 20th of January 1707. After his grandfather, George I., became king of Great Britain and Ireland in 1714, Frederick was known as duke of Gloucester¹ and made a knight of the Garter, having previously been betrothed to Wilhelmina Sophia Dorothea (1709-1758), daughter of Frederick William I., king of Prussia, and sister of Frederick the Great. Although he was anxious to marry this lady, the match was rendered impossible by the dislike of George II. and Frederick William for each other. Soon after his father became king in 1727 Frederick took up his residence in England and in 1729 was created prince of Wales; but the relations between George II. and his son were very unfriendly, and there existed between them the jealousy which Stubbs calls the "incurable bane of royalty." The faults were not all on one side. The prince's character was not attractive, and the king refused to make him an adequate allowance. In 1735 Frederick wrote, or inspired the writing of, the *Histoire du prince Tili*, a book containing offensive caricatures of both king and queen; and losing no opportunity of irritating his father, "he made," says Lecky, "his court the special centre of opposition to the government, and he exerted all his influence for the ruin of Walpole." After a marriage between the prince and Lady Diana Spencer, afterwards the wife of John, 4th duke of Bedford, had been frustrated by Walpole, Frederick was married in April 1736 to

¹ Frederick was never actually created duke of Gloucester, and when he was raised to the peerage in 1736 it was as duke of Edinburgh only. See G. E. C. (okayno), *Complete Peerage*, sub "Gloucester."

Augusta (1719-1772), daughter of Frederick II., duke of Saxe-Gotha, a union which was welcomed by his parents, but which led to further trouble between father and son. George proposed to allow the prince £50,000 a year; but this sum was regarded as insufficient by the latter, whose appeal to parliament was unsuccessful. After the birth of his first child, Augusta, in 1737, Frederick was ordered by the king to quit St James' Palace, and the foreign ambassadors were requested to refrain from visiting him. The relations between the two were now worse than before. In 1745 George II. refused to allow his son to command the British army against the Jacobites. On the 20th of March 1751 the prince died in London, and was buried in Westminster Abbey. He left five sons and two daughters. The sons were George afterwards King George III., Edward Augustus, duke of York and Albany (1739-1767), William Henry, duke of Gloucester and Edinburgh (1743-1805), Henry Frederick, duke of Cumberland (1745-1790), and Frederick William (1750-1765); the daughters were Augusta (1737-1813), wife of Charles William Ferdinand, duke of Brunswick, and Caroline Matilda (1751-1775), wife of Christian VII., king of Denmark.

See Lord Hervey of Ickworth, *Memoirs of the Reign of George II.*, edited by J. W. Croker (London, 1884); Horace Walpole, *Memoirs of the Reign of George II.* (London, 1847); and Sir N. W. Wraxall, *Memoirs*, edited by H. B. Wheatley, vol. i. (London, 1884).

FREDERICK WILLIAM I. (1688-1740), king of Prussia, son of Frederick I. by his second marriage was born on the 15th of August 1688. He spent a considerable time in early youth at the court of his grandfather, the elector Ernest Augustus of Hanover. On his return to Berlin he was placed under General von Dohna and Count Finkenstein, who trained him to the energetic and regular habits which ever afterwards characterized him. He was soon imbued with a passion for military life, and his was deepened by acquaintance with the duke of Marlborough (1709), Prince Eugene, whom he visited during the siege of Turin, and Prince Leopold of Anhalt (the "Old Dessauer"). In nearly every respect he was the opposite of his father, having rugged, simple tastes, a passionate temper and a determined will. Throughout his life he was always the protector of the church and of religion. But he detested religious quarrels and was very tolerant towards his Catholic subjects, except the Jesuits. His life was simple and puritanical, being founded on the teaching of the Bible. He was, however, fond of hunting and somewhat given to drinking. He intensely disliked the French, and highly disapproved of the imitation of their manners by his father and his court. When he came to the throne (February 25, 1713) his first act was to dismiss from the palace every unnecessary official and to regulate the royal household on principles of the strictest economy. The greater part of the beautiful furniture was sold. His importance for Prussia is twofold: in internal politics he laid down principles which continued to be followed long after his death. This was a province peculiarly suited to his genius; he was one of the greatest administrators who have ever worn the Prussian crown. His foreign policy was less successful, though under his rule the kingdom acquired some extension of territory.

Thus at the peace of Utrecht (April 11, 1713), after the War of the Spanish Succession, he acquired the greater part of the duchy of Gelderland. By the treaty of Schwedt, concluded with Russia on the 6th of October, he was assured of an important influence in the solution of the Baltic question, which during the long absence of Charles XII. had become burning; and Swedish Pomerania, as far as the Peene, was occupied by Prussia. At Charles XII. on his return turned against the king, though without success, for the Pomeranian campaign of 1715 ended in favour of Prussia (fall of Stralsund, December 22). This enabled Frederick William I. to maintain a more independent attitude towards the tsar; he refused, for example, to provide him with troops for a campaign (in Schonen) against the Swedes. When on the 28th of May 1718, in view of the disturbances in Mecklenburg, he signed at Havelberg the alliance with Russia, he confined himself to taking up a defensive attitude, and, on the other hand, on the 14th of August 1719 he also entered into relations with his former enemies, England and Hanover. And so, by the treaty of Stockholm (February 1, 1720), Frederick William

succeeded in obtaining the consent of Sweden to the cession of that part of Pomerania which he had occupied (Usedom, Wollin, Stettin, Hither Pomerania, east of the Peene) in return for a payment of 2,000,000 thalers.

While Frederick William I. succeeded in carrying his wishes into effect in this direction, he was unable to realize another project which he had much at heart, namely, the Prussian succession to the Lower Rhine duchies of Jülich and Berg. The treaty concluded in 1725 at Vienna between the emperor and Spain brought the whole of this question up again, for both sides had pledged themselves to support the Palatinate-Sulzbach succession (in the event of the Palatinate-Neuberg line becoming extinct). Frederick William turned for help to the western powers, England and France, and secured it by the treaty of alliance signed at Herrenhausen on the 3rd of September 1725 (League of Hanover). But since the western powers soon sought to use the military strength of Prussia for their own ends, Frederick again turned towards the east, strengthened above all his relations with Russia, which had continued to be good, and finally, by the treaty of Wüsterhausen (October 12, 1726; ratified at Berlin, December 23, 1728), even allied himself with his former adversary, the court of Vienna; though this treaty only imperfectly safeguarded Prussian interests, inasmuch as Frederick William consented to renounce his claims to Jülich. But as in the following years the European situation became more and more favourable to the house of Habsburg, the latter began to try to withdraw part of the concessions which it had made to Frederick William. As early as 1728 Düsseldorf, the capital, was excluded from the guarantee of Berg. Nevertheless, in the War of the Polish Succession against France (1734-1735), Frederick William remained faithful to the emperor's cause, and sent an auxiliary force of 10,000 men. The peace of Vienna, which terminated the war, led to a reconciliation between France and Austria, and so to a further estrangement between Frederick William and the emperor. Moreover, in 1738 the western powers, together with the emperor, insisted in identical notes on the recognition of the emperor's right to decide the question of the succession in the Lower Rhine duchies. A breach with the emperor was now inevitable, and this explains why in a last treaty (April 5, 1739) Frederick William obtained from France a guarantee of a part, at least, of Berg (excluding Düsseldorf).

But Frederick William's failures in foreign policy were more than compensated for by his splendid services in the internal administration of Prussia. He saw the necessity of rigid economy not only in his private life but in the whole administration of the state. During his reign Prussia obtained for the first time a centralized and uniform financial administration. It was he who composed and wrote in the year 1722 the famous instruction for the general directory (*Generaldirektorium*) of war, finance and domains. When he died the income of the state was about seven million thalers (£1,050,000). The consequence was that he paid off the debts incurred by his father, and left to his successor a well filled treasury. In the administration of the domains he made three innovations: (1) the private estates of the king were turned into domains of the crown (August 13, 1713); (2) the freeing of the serfs on the royal domains (March 22, 1719); (3) the conversion of the hereditary lease into a short-term lease on the basis of productiveness. His industrial policy was inspired by the mercantile spirit. On this account he forbade the importation of foreign manufactures and the export of raw materials from home, a policy which had a very good effect on the growth of Prussian industries.

The work of internal colonization he carried on with especial zeal. Most notable of all was his *rétablissement* of East Prussia, to which he devoted six million thalers (c. £900,000). His policy in respect of the towns was motivated largely by fiscal considerations, but at the same time he tried also to improve their municipal administration; for example, in the matter of buildings, of the letting of domain lands and of the collection of the excise in towns. Frederick William had many opponents among the nobles because he pressed on the abolition of the old feudal rights, introduced in East Prussia and Lithuania a general land tax (the *General-*

kufenschoss), and finally in 1739 attacked in a special edict the *Legen*, i.e. the expropriation of the peasant proprietors. He did nothing for the higher learning, and even banished the philosopher Christian Wolff at forty-eight hours' notice "on pain of the halter," for teaching, as he believed, fatalist doctrines. Afterwards he modified his judgment in favour of Wolff, and even, in 1739, recommended the study of his works. He established many village schools, which he often visited in person; and after the year 1717 (October 23) all Prussian parents were obliged to send their children to school (*Schulzwang*). He was the especial friend of the *Franchische Stiftungen* at Halle on the Saale. Under him the people flourished; and although it stood in awe of his vehement spirit it respected him for his firmness, his honesty of purpose and his love of justice. He was devoted also to his army, the number of which he raised from 38,000 to 83,500, so that under him Prussia became the third military power in the world, coming next after Russia and France. There was not a more thoroughly drilled or better appointed force. The Potsdam guard, made up of giants collected from all parts of Europe, sometimes kidnapped, was a sort of toy with which he amused himself. The reviewing of his troops was his chief pleasure. But he was also fond of meeting his friends in the evening in what he called his Tobacco-College, where amid clouds of tobacco smoke he not only discussed affairs of state but heard the newest "guard-room jokes." He died on the 31st of May 1740, leaving behind him his widow, Sophia Dorothea of Hanover, whom he had married on the 26th of November 1706. His son was Frederick the Great, who was the opposite of Frederick William. This opposition became so strong in 1730 that the crown prince fled from the court, and was later arrested and brought before a court-martial. A reconciliation was brought about, at first gradually. In later years the relations between father and son came to be of the best (see FREDERICK II., king of Prussia).

BIBLIOGRAPHY.—D. Fassmann, *Leben und Thaten Friedrich Wilhelm's* (2 vols., Hamburg and Breslau, 1735, 1744); F. Förster, *Friedrich Wilhelm I.* (3 vols., Potsdam, 1834 and 1835); C. v. Noorden, *Historische Vorträge* (Leipzig, 1884); O. Krauske, "Vom Hofe Friedrich Wilhelm's I.," *Hohenzollernjahrbuch*, v. (1902); R. Koser, *Friedrich der Grosse als Kronprinz* (2nd ed., Stuttgart, 1909); W. Oncken, "Sir Charles Hotham and Friedrich Wilhelm I. im Jahre 1730," *Forschungen zur brandenburgischen Geschichte*, vol. vii. et seq.; J. G. Droysen in the *Allgemeine deutsche Biographie*, vii. (1878), and in *Geschichte der preussischen Politik*, section iv., vols. ii.-iv. (2nd ed., 1868 et seq.); L. v. Ranke, *Zwölf Bücher preussischer Geschichte* (1874 et seq.); Stenzel, *Geschichte des preussischen Staates*, iii. (1841); F. Holke, "Strafrechtspflege unter Friedrich Wilhelm I.," *Beiträge zur brandenburgischen Rechtsgeschichte*, iii. (1894); V. Loewe, "Alloifikation der Leben unter Friedrich Wilhelm I.," *Forschungen zur brandenburgischen Geschichte*, xi.; G. Schmoller, "Epochen der preuss. Finanzpolitik," *Umriss und Untersuchungen* (Leipzig, 1898); "Innere Verwaltung unter Friedrich Wilhelm I.," *Preuss. Jahrbücher*, xxvi.; "Städtewesen unter Friedrich Wilhelm I.," *Zeitschrift für preussische Geschichte*, x. et seq.; B. Reuter, "König Friedrich Wilhelm I. und das General-Direktorium," *ibid.* xii.; V. Loewe, "Zur Gründungsgeschichte des General-Direktoriums," *Forschungen*, &c., xiii.; R. Stadelmann, *Preussens Könige in ihrer Tätigkeit für die Landeskultur*, vol. i. "Friedrich Wilhelm I." (1878); M. Beheim-Schwarzbach, *Hohenzollern'sche Kolonisationen* (Leipzig, 1874); W. Naude, "Die merkantilistische Wirtschaftspolitik Friedrich Wilhelm's I.," *Historische Zeitschrift*, xc.; M. Lehmann, "Werbung, &c., im Heere Friedrich Wilhelm's I.," *ibid.* lxxv.; Isaacson, "Erbpachtsystem in der preussischen Domänenverwaltung," *Zeitschrift für preuss. Gesch.* xi. Cf. also *Hohenzollernjahrbuch*, viii. (1905), for particulars of his education and death; letters to Prince Leopold of Anhalt-Dessau in the *Acta Borussica* (1905). English readers will find a picturesque account of him in Thomas Carlyle's *Frederick the Great*. (J. H.S.)

FREDERICK WILLIAM II. (1744-1797), king of Prussia, son of Augustus William, second son of King Frederick William I. and of Louise Amalie of Brunswick, sister of the wife of Frederick the Great, was born at Berlin on the 25th of September 1744, and became heir to the throne on his father's death in 1757. The boy was of an easy-going and pleasure-loving disposition, averse from sustained effort of any kind, and sensual by nature. His marriage with Elisabeth Christine, daughter of Duke Charles of Brunswick, contracted in 1765, was dissolved in 1769, and he soon afterwards married Frederika Louisa, daughter of the land-

grave Louis IX. of Hesse-Darmstadt. Although he had a numerous family by his wife, he was completely under the influence of his mistress, Wilhelmine Enke, afterwards created Countess Lichtenau, a woman of strong intellect and much ambition. He was a man of singularly handsome presence, not without mental qualities of a high order; he was devoted to the arts—Beethoven and Mozart enjoyed his patronage and his private orchestra had a European reputation. But an artistic temperament was hardly that required of a king of Prussia on the eve of the Revolution; and Frederick the Great, who had employed him in various services—notably in an abortive confidential mission to the court of Russia in 1780—openly expressed his misgivings as to the character of the prince and his surroundings.

The misgivings were justified by the event. Frederick William's accession to the throne (August 17, 1786) was, indeed, followed by a series of measures for lightening the burdens of the people, reforming the oppressive French system of tax-collecting introduced by Frederick, and encouraging trade by the diminution of customs dues and the making of roads and canals. This gave the new king much popularity with the mass of the people; while the educated classes were pleased by his removal of Frederick's ban on the German language by the admission of German writers to the Prussian Academy, and by the active encouragement given to schools and universities. But these reforms were vitiated in their source. In 1781 Frederick William, then prince of Prussia, inclined, like many sensual natures, to mysticism, had joined the Rosicrucians, and had fallen under the influence of Johann Christof Wöllner (1732-1800), and by him the royal policy was inspired. Wöllner, whom Frederick the Great had described as a "treacherous and intriguing priest," had started life as a poor tutor in the family of General von Itzenplitz, a noble of the mark of Brandenburg, had, after the general's death and to the scandal of king and nobility, married the general's daughter, and with his mother-in-law's assistance settled down on a small estate. By his practical experiments and by his writings he gained a considerable reputation as an economist; but his ambition was not content with this, and he sought to extend his influence by joining first the Freemasons and afterwards (1779) the Rosicrucians. Wöllner, with his impressive personality and easy if superficial eloquence, was just the man to lead a movement of this kind. Under his influence the order spread rapidly, and he soon found himself the supreme director (*Oberhauptdirektor*) of some 26 "circles," which included in their membership princes, officers and high officials. As a Rosicrucian Wöllner dabbled in alchemy and other mystic arts, but he also affected to be zealous for Christian orthodoxy, imperilled by Frederick II.'s patronage of "enlightenment," and a few months before Frederick's death wrote to his friend the Rosicrucian Johann Rudolph von Bischoffswerder (1742-1803) that his highest ambition was to be placed at the head of the religious department of the state "as an unworthy instrument in the hand of Ormesus" (the prince of Prussia's Rosicrucian name) "for the purpose of saving millions of souls from perdition and bringing back the whole country to the faith of Jesus Christ."

Such was the man whom Frederick William II., immediately after his accession, called to his counsels. On the 26th of August 1786 he was appointed privy councillor for finance (*Geheimer Oberfinanzrath*), and on the end of October was ennobled. Though not in name, in fact he was prime minister; in all internal affairs it was he who decided; and the fiscal and economic reforms of the new reign were the application of his theories. Bischoffswerder, too, still a simple major, was called into the king's counsels; by 1789 he was already an adjutant-general. These were the two men who enmeshed the king in a web of Rosicrucian mystery and intrigue, which hampered whatever healthy development of his policy might have been possible, and led ultimately to disaster. The opposition to Wöllner was, indeed, at the outset strong enough to prevent his being entrusted with the department of religion; but this too in time was overcome, and on the 3rd of July 1788 he was appointed active privy councillor of state and of justice and head of the spiritual

department for Lutheran and Catholic affairs. War was at once declared on what—to use a later term—we may call the “modernists.” The king, so long as Wöllner was content to condone his immorality (which Bischoffswerder, to do him justice, condemned), was eager to help the orthodox crusade. On the 9th of July was issued the famous religious edict, which forbade Evangelical ministers to teach anything not contained in the letter of their official books, proclaimed the necessity of protecting the Christian religion against the “enlighteners” (*Aufklärer*), and placed educational establishments under the supervision of the orthodox clergy. On the 18th of December a new censorship law was issued, to secure the orthodoxy of all published books, and finally, in 1791, a sort of Protestant Inquisition was established at Berlin (*Immedial-Examinations-commission*) to watch over all ecclesiastical and scholastic appointments. In his zeal for orthodoxy, indeed, Frederick William outstripped his minister, he even blamed Wöllner’s “idleness and vanity” for the inevitable failure of the attempt to regulate opinion from above, and in 1794 deprived him of one of his secular offices in order that he might have more time “to devote himself to the things of God”, in edict after edict the king continued to the end of his reign to make regulations “in order to maintain in his states a true and active Christianity, as the path to genuine fear of God.”

The effects of this policy of blind obscurantism far outweighed any good that resulted from the king’s well-meant efforts at economic and financial reform, and even this reform was but spasmodic and partial, and awoke ultimately more discontent than it allayed. But far more fateful for Prussia was the king’s attitude towards the army and foreign policy. The army was the very foundation of the Prussian state, a truth which both Frederick William I. and the great Frederick had fully realized; the army had been their first care, and its efficiency had been maintained by their constant personal supervision. Frederick William, who had no taste for military matters, put his authority as “War-Lord” into commission under a supreme college of war (*Oberkriegs-Collegium*) under the duke of Brunswick and General von Müllendorff. It was the beginning of the process that ended in 1806 at Jena.

In the circumstances Frederick William’s intervention in European affairs was not likely to prove of benefit to Prussia. The Dutch campaign of 1787, entered on for purely family reasons, was indeed successful, but Prussia received not even the cost of her intervention. An attempt to intervene in the war of Russia and Austria against Turkey failed of its object, Prussia did not succeed in obtaining any concessions of territory from the allies, and the dismissal of Hertzberg in 1791 marked the final abandonment of the anti-Austrian tradition of Frederick the Great. For, meanwhile, the French Revolution had entered upon alarming phases, and in August 1791 Frederick William, at the meeting at Pillnitz, arranged with the emperor Leopold to join in supporting the cause of Louis XVI. But neither the king’s character, nor the confusion of the Prussian finances due to his extravagance, gave promise of any effective action. A formal alliance was indeed signed on the 7th of February 1792, and Frederick William took part personally in the campaigns of 1792 and 1793. He was hampered, however, by want of funds, and his counsels were distracted by the affairs of Poland, which promised a richer booty than was likely to be gained by the anti-revolutionary crusade into France. A subsidy treaty with the sea powers (April 10, 1794) filled his coffers, but the insurrection in Poland that followed the partition of 1793, and the threat of the isolated intervention of Russia, hurried him into the separate treaty of Basel with the French Republic (April 5, 1795), which was regarded by the great monarchies as a betrayal, and left Prussia morally isolated in Europe on the eve of the titanic struggle between the monarchical principle and the new political creed of the Revolution. Prussia had paid a heavy price for the territories acquired at the expense of Poland in 1793 and 1795, and when, on the 16th of November 1797, Frederick William died, he left the state in bankruptcy and confusion, the army decayed and the monarchy discredited.

Frederick William II. was twice married: (1) in 1765 to Elizabeth of Brunswick (d. 1841), by whom he had a daughter, Frederika, afterwards duchess of York, and from whom he was divorced in 1769; (2) in 1769 to Frederika Louisa of Hesse-Darmstadt, by whom he had four sons, Frederick William III., Louis (d. 1796), Henry and William, and two daughters, Wilhelmina, wife of William of Orange, afterwards William I., king of the Netherlands, and Augusta, wife of William II., elector of Hesse. Besides his relations with his *maîtresse en titre*, the countess Lichtenu, the king—who was a frank polygamist—contracted two “marriages of the left hand” with Fräulein von Voss and the countess Dönhoff.

See article by von Hartmann in *Allgem. deutsche Biog.* (Leipzig, 1878); Stadelmann, *Preussens Könige in ihrer Tätigkeit für die Landeskultur*, vol. iii. “Friedrich Wilhelm II.” (Leipzig, 1885); Pautig, *Friedrich Wilhelm II., sein Privatleben u. seine Regierung* (Frankfurt-an-der-Oder, 1896).

FREDERICK WILLIAM III. (1770–1840), king of Prussia, eldest son of King Frederick William II., was born at Potsdam on the 3rd of August 1770. His father, then prince of Prussia, was out of favour with Frederick the Great and entirely under the influence of his mistress; and the boy, handed over to tutors appointed by the king, lived a solitary and repressed life which tended to increase the innate weakness of his character. But though his natural defects of intellect and will-power were not improved by the pedantic tutoring to which he was submitted, he grew up pious, honest and well-meaning; and had fate cast him in any but the most stormy times of his country’s history he might well have left the reputation of a model king. As a soldier he received the usual training of a Prussian prince, obtained his lieutenantancy in 1784, became a colonel commanding in 1790, and took part in the campaigns of 1792–94. In 1793 he married Louise, daughter of Prince Charles of Mecklenburg-Strelitz, whom he had met and fallen in love with at Frankfurt (see LOUISE, queen of Prussia). He succeeded to the throne on the 16th of November 1797 and at once gave earnest of his good intentions by cutting down the expenses of the royal establishment, dismissing his father’s ministers, and reforming the most oppressive abuses of the late reign. Unfortunately, however, he had all the Hohenzollern tenacity of personal power without the Hohenzollern genius for using it. Too distrustful to delegate his responsibility to his ministers, he was too infirm of will to strike out and follow a consistent course for himself.

The results of this infirmity of purpose are written large on the history of Prussia from the treaty of Lunéville in 1801 to the downfall that followed the campaign of Jena in 1806. By the treaty of Tilsit (July 9th, 1807) Frederick William had to surrender half his dominions, and what remained to him was exhausted by French exactions and liable at any moment to be crushed out of existence by some new whim of Napoleon. In the dark years that followed it was the indomitable courage of Queen Louise that helped the weak king not to despair of the state. She seconded the reforming efforts of Stein and the work of Scharnhorst and Gneisenau in reorganizing the army, by which the resurrection of Prussia became a possibility. When Stein was dismissed at the instance of Napoleon, Hardenberg succeeded him as chancellor (June 1810). In the following month Queen Louise died, and the king was left alone to deal with circumstances of ever-increasing difficulty. He was forced to join Napoleon in the war against Russia; and even when the disastrous campaign of 1812 had for the time broken the French power, it was not his own resolution, but the loyal disloyalty of General York in concluding with Russia the convention of Taurigen that forced him into line with the patriotic fervour of his people.

Once committed to the Russian alliance, however, he became the faithful henchman of the emperor Alexander, whose fascinating personality exercised over him to the last a singular power, and began that influence of Russia at the court of Berlin which was to last till Frederick William IV.’s supposed Liberalism was to shatter the cordiality of the *entente*. That during and after the settlement of 1815 Frederick William played a very secondary part in European affairs is explicable as well by his character as

by the absorbing character of the internal problems of Prussia. He was one of the original co-signatories of the Holy Alliance, though, in common with most, he signed it with reluctance; and in the counsels of the Grand Alliance he allowed himself to be practically subordinated to Alexander and later to Metternich. In a ruler of his character it is not surprising that the Revolution and its developments had produced an unconquerable suspicion of constitutional principles and methods, which the Liberal agitations in Germany tended to increase. At the various congresses, from Aix-la-Chapelle (1818) to Verona (1822), therefore, he showed himself heartily in sympathy with the repressive policy formulated in the Troppau Protocol. The promise of a constitution, which in the excitement of the War of Liberation he had made to his people, remained unfulfilled partly owing to this mental attitude, partly, however, to the all but insuperable difficulties in the way of its execution. But though reluctant to play the part of a constitutional king, Frederick William maintained to the full the traditional character of "first servant of the state." Though he chastised Liberal professors and turbulent students, it was in the spirit of a benevolent *Landesvater*; and he laboured assiduously at the enormous task of administrative reconstruction necessitated by the problem of welding the heterogeneous elements of the new Prussian kingdom into a united whole. He was sincerely religious; but his well-meant efforts to unite the Lutheran and Reformed Churches, in celebration of the tercentenary of the Reformation (1817), revealed the limits of his paternal power; eleven years passed in vain attempts to devise common formulae; a stubborn Lutheran minority had to be coerced by military force, the confiscation of their churches and the imprisonment or exile of their pastors; not till 1834 was outward union secured on the basis of common worship but separate symbols, the opponents of the measure being forbidden to form communities of their own. With the Roman Church, too, the king came into conflict on the vexed question of "mixed marriages," a conflict in which the Vatican gained an easy victory (see BUNSEN, C. C. J., BARON VON).

The revolutions of 1830 strengthened Frederick William in his reactionary tendencies; the question of the constitution was indefinitely shelved; and in 1831 Prussian troops concentrated on the frontier helped the task of the Russians in reducing the military rising in Poland. Yet, in spite of all, Frederick William was beloved by his subjects, who valued him for the simplicity of his manners, the goodness of his heart and the memories of the dark days after 1806. He died on the 7th of June 1840. In 1824 he had contracted a morganatic marriage with the countess Auguste von Harrach, whom he created Princess von Liegnitz. He wrote *Luther in Bezug auf die Kirchenagenda von 1822 und 1823* (Berlin, 1827), *Rominsensens aus der Kampagne 1792 in Frankreich*, and *Journal meiner Brigade in der Kampagne am Rhein 1793*.

The correspondence (*Briefwechsel*) of King Frederick William III. and Queen Louise with the emperor Alexander I. has been published (Leipzig, 1900) and also that between the king and queen (*ib.* 1903), both edited by P. Baillou. See W. Hahn, *Friedrich Wilhelm III. und Louise* (3rd ed., Leipzig, 1877); M. W. Duncker, *Aus der Zeit Friedrichs des Grossen und Friedrich Wilhelms III.* (Leipzig, 1876); Bishop R. F. Eylert, *Charakterzüge aus dem Leben des Königs von Preussen Friedrich Wilhelm III.* (3 vols., Magdeburg, 1843-1846).

FREDERICK WILLIAM IV. (1795-1861), king of Prussia, eldest son of Frederick William III., was born on the 15th of October 1795. From his first tutor, Johann Delbrück, he imbibed a love of culture and art, and possibly also the dash of Liberalism which formed an element of his complex habit of mind. But after a time Delbrück, suspected of inspiring his charge with a dislike of the Prussian military caste and even of belonging to a political secret society, was dismissed, his place being taken by the pastor and historian Friedrich Ancillon, while a military governor was also appointed. By Ancillon he was grounded in religion, in history and political science, his natural taste for the antique and the picturesque making it easy for his tutor to impress upon him his own hatred of the Revolution and its principles. This hatred was confirmed by the sufferings of his country and family

in the terrible years after 1806, and his first experience of active soldiering was in the campaigns that ended in the occupation of Paris by the Allies in 1814. In action his reckless bravery had earned him rebuke, and in Paris he was remarked for the exact performance of his military duties, though he found time to whet his appetite for art in the matchless collections gathered by Napoleon as the spoil of all Europe. On his return to Berlin he studied art under the sculptor Christian Daniel Rauch and the painter and architect Karl Friedrich Schinkel (1781-1841), proving himself in the end a good draughtsman, a born architect and an excellent landscape gardener. At the same time he was being tutored in law by Savigny and in finance by a series of distinguished masters. In 1823 he married the princess Elizabeth of Bavaria, who adopted the Lutheran creed. The union, though childless, was very happy. A long tour in Italy in 1828 was the beginning of his intimacy with Bunsen and did much to develop his knowledge of art and love of antiquity.

On his accession to the throne in 1840 much was expected of a prince so variously gifted and of so amiable a temper, and his first acts did not belie popular hopes. He reversed the unfortunate ecclesiastical policy of his father, allowing a wide liberty of dissent, and releasing the imprisoned archbishop of Cologne; he modified the strictness of the press censorship; above all he undertook, in the presence of the deputations of the provincial diets assembled to greet him on his accession, to carry out the long-deferred project of creating a central constitution, which he admitted to be required alike by the royal promises, the needs of the country and the temper of the times. The story of the evolution of the Prussian parliament belongs to the history of Prussia. Here it must suffice to notice Frederick William's personal share in the question, which was determined by his general attitude of mind. He was an idealist; but his idealism was of a type the exact reverse of that which the Revolution in arms had sought to impose upon Europe. The idea of the sovereignty of the people was to him utterly abhorrent, and even any delegation of sovereign power on his own part would have seemed a betrayal of a God-given trust. "I will never," he declared, "allow to come between Almighty God and this country a blotched parchment, to rule us with paragraphs, and to replace the ancient, sacred bond of loyalty." His vision of the ideal state was that of a patriarchal monarchy, surrounded and advised by the traditional estates of the realm—nobles, peasants, burghers—and cemented by the bonds of evangelical religion, but in which there should be no question of the sovereign power being vested in any other hands than those of the king by divine right. In Prussia, with its traditional loyalty and its old-world caste divisions, he believed that such a conception could be realized, and he took up an attitude half-way between those who would have rejected the proposal for a central diet altogether as dangerous "thin end of the wedge," and those who would have approximated it more to the modern conception of a parliament. With a charter, or a representative system based on population, he would have nothing to do. The united diet which was opened on the 3rd of February 1847 was no more than a congregation of the diets instituted by Frederick William III. in the eight provinces of Prussia. Unrepresentative though it was—for the industrial working-classes had no share in it—it at once gave voice to the demand for a constitutional system.

This demand gained overwhelmingly in force with the revolutionary outbreaks of 1848. To Frederick William these came as a complete surprise, and, rudely awakened from his medieval dreamings, he even allowed himself to be carried away for a while by the popular tide. The loyalty of the Prussian army remained inviolate; but the king was too tender-hearted to use military force against his "beloved Berliners," and when the victory of the populace was thus assured his impressionable temper yielded to the general enthusiasm. He paraded the streets of Berlin wrapped in a scarf of the German black and gold, symbol of his intention to be the leader of the united Germany; and he even wrote to the indignant tsar in praise of "the glorious German revolution." The change of sentiment was, however, apparent rather than real. The shadow of venerable institutions, past or

passing, still darkened his counsels. The united Germany which he was prepared to champion was not the democratic state which the theorists of the Frankfurt national parliament were evolving on paper with interminable debate, but the old Holy Roman Empire, the heritage of the house of Habsburg, of which he was prepared to constitute himself the guardian so long as its lawful possessors should not have mastered the forces of disorder by which they were held captive. Finally, when Austria had been excluded from the new empire, he replied to the parliamentary deputation that came to offer him the imperial crown that he might have accepted it had it been freely offered to him by the German princes, but that he would never stoop "to pick up a crown out of the gutter."

Whatever may be thought of the manner of this refusal, or of its immediate motives, it was in itself wise, for the German empire would have lost immeasurably had it been the cause rather than the result of the inevitable struggle with Austria, and Bismarck was probably right when he said that, to weld the heterogeneous elements of Germany into a united whole, what was needed was, not speeches and resolutions, but a policy of "blood and iron." In any case Frederick William, uneasy enough as a constitutional king, would have been impossible as a constitutional emperor. As it was, his refusal to play this part gave the deathblow to the parliament and to all hope of the immediate creation of a united Germany. For Frederick William the position of leader of Germany now meant the employment of the military force of Prussia to crush the scattered elements of revolution that survived the collapse of the national movement. His establishment of the northern confederacy was a reversion to the traditional policy of Prussia in opposition to Austria, which, after the emperor Nicholas had crushed the insurrection in Hungary, was once more free to assert her claims to dominance in Germany. But Prussia was not ripe for a struggle with Austria, even had Frederick William found it in his conscience to turn his arms against his ancient ally, and the result was the humiliating convention of Olmütz (November 30th, 1850), by which Prussia agreed to surrender her separatist plans and to restore the old constitution of the confederation. Yet Frederick William had so far profited by the lessons of 1848 that he consented to establish (1850) a national parliament, though with a restricted franchise and limited powers. The House of Lords (*Herrenhaus*) justified the king's insistence in calling it into being by its support of Bismarck against the more popular House during the next reign.

In religious matters Frederick William was also largely swayed by his love for the ancient and picturesque. In concert with his friend Bunsen he laboured to bring about a rapprochement between the Lutheran and Anglican churches, the first-fruits of which was the establishment of the Jerusalem bishopric under the joint patronage of Great Britain and Prussia; but the only result of his efforts was to precipitate the secession of J. H. Newman and his followers to the Church of Rome. In general it may be said that Frederick William, in spite of his talents and his wide knowledge, lived in a dream-land of his own, out of touch with actuality. The style of his letters reveals a mind enthusiastic and ill-balanced. In the summer of 1857 he had a stroke of paralysis, and a second in October. From this time, with the exception of brief intervals, his mind was completely clouded, and the duties of government were undertaken by his brother William (afterwards emperor), who on the 7th of October 1858 was formally recognized as regent. Frederick William died on the 2nd of January 1861.

Selections from the correspondence (*Briefwechsel*) of Frederick William IV. and Bunsen were edited by Ranke (Leipzig, 1873); his proclamations, speeches, &c., from the 6th of March 1848 to the 31st of May 1851 have been published (Berlin, 1851); also his correspondence with Bettina von Arnim, *Bettina von Arnim und Friedrich Wilhelm IV., ungedruckte Briefe und Aktenstücke*, ed. L. Geiger (Frankfurt-on-Main, 1902). See L. von Ranke, *Friedrich Wilhelm IV., König von Preussen* (works 51, 52 also in *Allgem. deutsche Biog.* vol. vii.), especially for the king's education and the inner history of the debates leading up to the united diet of 1847; H. von Petersdorff, *König Friedrich Wilhelm IV.* (Stuttgart, 1900); F. Rastbach, *Deutschland, König Friedrich Wilhelm IV. und die*

Berliner Märzrevolution (Halle, 1901); H. von Pasching (ed.), *Unter Friedrich Wilhelm IV. Denkwürdigkeiten des Ministers Otto Frhr. von Manteuffel, 1848-1858* (3 vols., Berlin, 1900-1901); and *Preussens auswärtige Politik, 1850-1858* (3 vols., ib., 1902), documents selected from those left by Manteuffel; E. Friedberg, *Die Grundlagen der preussischen Kirchenpolitik unter Friedrich Wilhelm IV.* (Leipzig, 1882).

FREDERICK WILLIAM (1620-1688), elector of Brandenburg, usually called the "Great Elector," was born in Berlin on the 16th of February 1620. His father was the elector George William, and his mother was Elizabeth Charlotte, daughter of Frederick IV., elector palatine of the Rhine. Owing to the disorders which were prevalent in Brandenburg he passed part of his youth in the Netherlands, studying at the university of Leiden and learning something of war and statecraft under Frederick Henry, prince of Orange. During his boyhood a marriage had been suggested between him and Christina, afterwards queen of Sweden; but although the idea was revived during the peace negotiations between Sweden and Brandenburg, it came to nothing, and in 1646 he married Louise Henriette (d. 1667), daughter of Frederick Henry of Orange, a lady whose counsel was very helpful to him and who seconded his efforts for the welfare of his country.

Having become ruler of Brandenburg and Prussia by his father's death in December 1640, Frederick William set to work at once to repair the extensive damage wrought during the Thirty Years' War, still in progress. After some difficulty he secured his investiture as duke of Prussia from Wladislaus, king of Poland, in October 1641, but was not equally successful in crushing the independent tendencies of the estates of Cleves. It was in Brandenburg, however, that he showed his supreme skill as a diplomatist and administrator. His disorderly troops were replaced by an efficient and disciplined force; his patience and perseverance freed his dominions from the Swedish soldiers; and the restoration of law and order was followed by a revival of trade and an increase of material prosperity. After a tedious struggle he succeeded in centralizing the administration, and controlling and increasing the revenue, while no department of public life escaped his sedulous care (see **BRANDENBURG**). The area of his dominions was largely increased at the peace of Westphalia in 1648, and this treaty and the treaty of Oliva in 1660 alike added to his power and prestige. By a clever but unscrupulous use of his intermediate position between Sweden and Poland he procured his recognition as independent duke of Prussia from both powers, and eventually succeeded in crushing the stubborn and lengthened opposition which was offered to his authority by the estates of the duchy (see **PRUSSIA**). After two checks he made his position respected in Cleves, and in 1666 his title to Cleves, Jülich and Ravensberg was definitely recognized. His efforts, however, to annex the western part of the duchy of Pomerania, which he had conquered from the Swedes, failed owing to the insistence of Louis XIV. at the treaty of St Germain-en-Laye in 1679, and he was unable to obtain the Silesian duchies of Liegnitz, Brieg and Wohlau from the emperor Leopold I. after they had been left without a ruler in 1675.

Frederick William played an important part in European politics. Although found once or twice on the side of France, he was generally loyal to the interests of the empire and the Habsburgs, probably because his political acumen scented danger to Brandenburg from the aggressive policy of Louis XIV. He was a Protestant in religion, but he supported Protestant interests abroad on political rather than on religious grounds, and sought, but without much success, to strengthen Brandenburg by allaying the fierce hostility between Lutherans and Calvinists. His success in founding and organizing the army of Brandenburg-Prussia was amply demonstrated by the great victory which he gained over the Swedes at Fehrbellin in June 1675, and by the eagerness with which foreign powers sought his support. He was also the founder of the Prussian navy. The elector assisted trade in every possible way. He made the canal which still bears his name between the Oder and the Spree; established a trading company; and founded colonies on the west coast of Africa. He encouraged Flemings to settle in Brandenburg,

and both before and after the revocation of the edict of Nantes in 1685 welcomed large numbers of Huguenots, who added greatly to the welfare of the country. Education was not neglected; and if in this direction some of his plans were abortive, it was from lack of means and opportunity rather than effort and inclination. It is difficult to overestimate the services of the great elector to Brandenburg and Prussia. They can only be properly appreciated by those who compare the condition of his country in 1640 with its condition in 1688. Both actually and relatively its importance had increased enormously; poverty had given place to comparative wealth, and anarchy to a system of government which afterwards made Prussia the most centralized state in Europe. He had scant sympathy with local privileges, and in fighting them his conduct was doubtless despotic. His aim was to make himself an absolute ruler, as he regarded this as the best guarantee for the internal and external welfare of the state.

The great elector died at Potsdam from dropsy on the 9th of May 1688, and was succeeded by his eldest surviving son, Frederick. His personal appearance was imposing, and although he was absolutely without scruples when working for the interests of Brandenburg, he did not lack a sense of justice and generosity. At all events he deserves the eulogy passed upon him by Frederick the Great, "*Messieurs; celui-ci a fait de grandes choses.*" His second wife, whom he married in 1668, was Dorothea (d. 1689), daughter of Philip, duke of Holstein-Glücksburg, and widow of Christian Louis, duke of Brunswick-Lüneburg; she bore him four sons and three daughters. His concluding years were troubled by differences between his wife and her step-son, Frederick; and influenced by Dorothea he bequeathed portions of Brandenburg to her four sons, a bequest which was annulled under his successor.

See S. de Pufendorf, *De rebus gestis Friderici Wilhelmi Magni* (Leipzig and Berlin, 1733); L. von Orlich, *Frédéric Wilhelm der grosse Kurfürst* (Berlin, 1836); K. H. S. Rodenbeck, *Zur Geschichte Friedrich Wilhelms des grossen Kurfürsten* (Berlin, 1851); B. Erdmannsdorfer, *Der grosse Kurfürst* (Leipzig, 1879); J. G. Droysen, *Geschichte der preussischen Politik* (Berlin, 1845-1886); M. Philippson, *Der grosse Kurfürst* (Berlin, 1897-1903); E. Heyck, *Der grosse Kurfürst* (Bielefeld, 1902); Spahn, *Der grosse Kurfürst* (Mainz, 1902); H. Landwehr, *Die Kirchenpolitik des grossen Kurfürsten* (Berlin, 1894); H. Prutz, *Aus des grossen Kurfürsten letzten Jahren* (Berlin, 1897). Also *Urkunden und Astenstücke zur Geschichte des Kurfürsten Friedrich Wilhelm von Brandenburg* (Berlin, 1865-1902); T. Carlyle, *History of Frederick the Great*, vol. i. (London, 1858); and A. Waddington, *Le Grand Electeur et Louis XIV* (Paris, 1905).

FRÉDÉRIC-LEMAÎTRE, ANTOINE LOUIS PROSPER (1800-1876) French actor, the son of an architect, was born at Havre on the 28th of July 1800. He spent two years at the Conservatoire, and made his first appearance at a variety performance in one of the basement restaurants at the Palais Royal. At the Ambigu on the 12th of July 1823 he played the part of Robert Macaire in *L'Auberge des Adrets*. The melodrama was played seriously on the first night and was received with little favour, but it was changed on the second night to burlesque, and thanks to him had a great success. All Paris came to see it, and from that day he was famous. He created a number of parts that added to his popularity, especially Cardillac, Cagliostro and Cartouche. His success in the last led to an engagement at the Porte St Martin, where in 1827 he produced *Trente ans, ou la vie d'un joueur*, in which his vivid acting made a profound impression. Afterwards at the Odéon and other theatres he passed from one success to another, until he put the final touch to his reputation as an artist by creating the part of Ruy Blas in Victor Hugo's play. On his return to the Porte St Martin he created the title-rôle in Balzac's *Vautrin*, which was forbidden a second presentation, on account, it is said, of the resemblance of the actor's wig to the well-known *loupet* worn by Louis Philippe. His last appearance was at this theatre in 1873 as the old Jew in *Marie Tudor*, and he died at Paris on the 26th of January 1876.

FREDERICKSBURG, a city of Spottsylvania county, Virginia, U.S.A., on the Rappahannock river, at the head of tide-water

navigation, about 60 m. N. of Richmond and about 55 m. S.S.W. of Washington. Pop. (1890) 4528; (1900) 5068 (1621 negroes), (1910) 5874. It is served by the Potomac, Fredericksburg & Piedmont, and the Richmond, Fredericksburg & Potomac railways, and by several coasting steamship lines. The city is built on a series of terraces between the river and hills of considerable height. The river is here spanned by iron bridges, and just above the city is a dam 900 ft long and 18 ft high. By means of this dam and a canal good water-power is furnished, and the city's manufactures include flour, leather, shoes, woollens, silks, wagons, agricultural implements and excelsior (fine wood-shavings for packing or stuffing). The water-works, gas and electric-lighting plants are owned and operated by the municipality. At Fredericksburg are Fredericksburg College (founded in 1893; co-educational), which includes the Kenmore school for girls and the Saunders memorial school for boys (both preparatory); a Confederate and a National cemetery (the latter on Marye's Heights), a monument (erected in 1906) to General Hugh Mercer (c. 1720-1777), whose home for several years was here and who fell in the battle of Princeton, and a monument to the memory of Washington's mother, who died here in 1789 and whose home is still standing. Other buildings of interest are the old Rising Sun Hotel, a popular resort during Washington's time, and "Kenmore," the home of Colonel Fielding Lewis, who married a sister of Washington. The city was named in honour of Frederick, father of George III., and was incorporated in 1727, long after its first settlement; in 1871 it was re-chartered by act of the General Assembly of Virginia.

The battle of Fredericksburg in the American Civil War was fought on the 13th of December 1862 between the Union forces (Army of the Potomac) under Major-General A. E. Burnside and the Confederates (Army of Northern Virginia) under General R. E. Lee. In the middle of November, Burnside, newly appointed to command the Army of the Potomac, had manoeuvred from the neighbourhood of Warrenton with a view to beginning an offensive move from Fredericksburg and, as a preliminary, to seizing a foothold beyond the Rappahannock at or near that place. On arriving near Falmouth, however, he found that the means of crossing that he had asked for had not been forwarded from Washington, and he sat down to wait for them, while, on the other side, the Confederate army gradually assembled south of the Rappahannock in a strong position with the left on the river above Fredericksburg and the right near Hamilton's Crossing on the Richmond railway. On the 10th of December Burnside, having by now received his pontoons, prepared to cross the river and to attack the Confederate entrenched position on the heights beyond the town. The respective forces were Union 122,000, Confederate 79,000. Major-General E. V. Sumner, commanding the Federal right wing (II. and IX. corps), was to cross at Fredericksburg, Major-General W. B. Franklin with the left (I. and VI. corps) some miles below, while the centre (III. and V. corps) under Major-General Joseph Hooker was to connect the two attacks and to reinforce either at need. The Union artillery took position along the heights of the north bank to cover the crossing, and no opposition was encountered opposite Franklin's command, which formed up on the other side during the 11th and 12th. Opposite Sumner, however, the Confederate riflemen, hidden in the gardens and houses of Fredericksburg, caused much trouble and considerable losses to the Union pioneers, and a forlorn hope of volunteers from the infantry had to be rowed across under fire before the enemy's skirmishers could be dislodged. Sumner's two corps crossed on the 12th. The battle took place next morning.

Controversy has raged round Burnside's plan of action and in particular round his orders to Franklin, as to which it can only be said that whatever chance of success there was in so formidable an undertaking as attacking the well-posted enemy was thrown away through misunderstandings, and that nothing but misunderstandings could be expected from the vague and bewildering orders issued by the general in command. The actual battle can be described in a few words. Jackson held the right of Lee's line, Longstreet the left, both entrenched. Franklin, tied by

his instructions, attacked with one division only, which a little later he supported by two more (I. corps, Major-General J. F. Reynolds) out of eight or nine available. His left flank was harassed by the Confederate horse artillery under the young and brilliant Captain John Pelham, and after breaking the first line of Stonewall Jackson's corps the assailants were in the end driven back with heavy losses. On the other flank, where part of Longstreet's corps held the low ridge opposite Fredericksburg called Marye's Heights, Burnside ordered in the II. corps under Major-General D. N. Couch about 11 A.M., and thenceforward division after division, on a front of little more than 800 yds., was sent forward to assault with the bayonet. The "Stone Wall" along the foot of Marye's was lined with every rifle of Longstreet's corps that could find room to fire, and above them the Confederate guns fired heavily on the assailants, whose artillery, on the height beyond the river, was too far off to assist them. Not a man of the Federals reached the wall, though the bravest were killed a few paces from it, and Sumner's and most of Hooker's brigades were broken one after the other as often as they tried to assault. At night the wrecks of the right wing were withdrawn. Burnside proposed next day to lead the IX. corps, which he had formerly commanded, in one mass to the assault of the Stone Wall, but his subordinates dissuaded him, and on the night of the 15th the Army of the Potomac withdrew to its camps about Falmouth. The losses of the Federals were 12,650 men, those of the Confederates 4,200, little more than a third of which fell on Longstreet's corps.

See F. W. Pallfrey, *Antietam and Fredericksburg* (New York, 1881); G. W. Redway, *Fredericksburg* (London, 1906); and G. F. R. Henderson, *Fredericksburg* (London, 1889).

FREDERICTON, a city and port of entry of New Brunswick, Canada, capital of the province, situated on the St John river, 84 m. from its mouth, and on the Canadian Pacific railway. It stands on a plain bounded on one side by the river, which is here 4 m. broad, and on the other by a range of hills which almost encircle the town. It is regularly built with long and straight streets, and contains the parliament buildings, government house, the Anglican cathedral, the provincial university and several other educational establishments. Fredericton is the chief commercial centre in the interior of the province, and has also a large trade in lumber. Its industries include canneries, tanneries and wooden ware factories. The river is navigable for large steamers up to the city, and above it by vessels of lighter draught. Two bridges, passenger and railway, unite the city with the towns of St Marye's and Gibson on the east side of the river, at its junction with the Nashwaak. The city was founded in 1785 by Sir Guy Carleton, and made the capital of the province, in spite of the jealousy of St John, on account of its superior strategical position. Pop. (1901) 7117.

FREDONIA, a village of Chautauqua county, New York, U.S.A., about 45 m. S.W. of Buffalo, and 3 m. from Lake Erie. Pop. (1900) 4127; (1905, state census) 5148; (1910 census) 5285. Fredonia is served by the Dunkirk, Allegheny Valley & Pittsburg railway, which connects at Dunkirk, 3 m. to the N., with the Erie, the Lake Shore & Michigan Southern, the New York, Chicago & St Louis, and the Pennsylvania railways; and by electric railway to Erie, Buffalo and Dunkirk. It is the seat of a State Normal School. The Darwin R. Barker public library contained 9700 volumes in 1908. Fredonia is situated in the grape-growing region of western New York, is an important shipping point for grapes, and has large grape-vine and general nurseries. The making of wine and of unfermented grape-juice are important industries of the village. Among other manufactures are canned goods, coal dealers' supplies, and patent medicines. The first settlement here was made in 1804, and the place was called Canandaway until 1817, when the present name was adopted. The village was incorporated in 1820. Fredonia was one of the first places in the United States, if not the first, to make use of natural gas for public purposes. Within the village limits, near a creek, whose waters showed the presence of gas, a well was sunk in 1821, and the supply of gas thus tapped was sufficient to light the streets of the village. Another well was sunk within the

village limits in 1858. About 1905 natural gas was again obtained by deep drilling near Fredonia and came into general use for heat, light and power. In the Fredonia Baptist church on the 14th of December 1873 a Woman's Temperance Union was organized, and from this is sometimes dated the beginning of the Woman's Christian Temperance Union movement.

FREDRIKSHALD (FREDERIKSHALD, FRIEDRICHSHALL), a seaport and garrison town of Norway, in Smaalenene amt (county), 85 m. by rail S. by E. of Christiania. Pop. (1900) 11,948. It is picturesquely situated on both banks of the Tistedal river at its outflow to the Ide fjord, surrounded by several rocky eminences. The chief of these is occupied by the famous fortress Fredriksten, protected on three sides by precipices, founded by Frederick III. (1661), and mainly showing, in its present form, the works of Frederick V. (1766) and Christian VII. (1808). Between it and the smaller Gyldenløve fort a monument marks the spot where Charles XII. was shot in the trenches while besieging the town (1718). The siege, which was then raised, is further commemorated by a monument to the brave defence of the brothers Peter and Hans Kolbjørnsen. Fredrikshald is close to the Swedish frontier, and had previously (1660) withstood invasion, after which its name was changed from Halden to the present form in 1665 in honour of Frederick III. The town was almost totally destroyed by fire in 1759 and 1826. The castle surrendered to the Swedish crown prince Bernadotte in 1814, and its capture was speedily followed by the conquest of the kingdom and its union with Sweden. Fredrikshald is one of the principal ports of the kingdom for the export of timber. Marble of very fine quality and grain is extensively quarried and exported for architectural ornamentation and for furniture-making. Wood-pulp is also exported. The industries embrace granite quarries, wood-pulp factories, and factories for sugar, tobacco, curtains, travelling-bags, boots, &c. There are railway communications with Gothenburg and all parts of Sweden and regular coastal and steamer services.

FREDRIKSTAD (FREDERIKSTAD), a seaport and manufacturing town of Norway in Smaalenene amt (county), 58 m. S. by E. of Christiania by the Christiania-Gothenburg railway. Pop. (1900) 14,553. It lies at the mouth and on the eastern shore of Christiania fjord, occupying both banks of the great river Glommen, which, descending from the richly-wooded district of Østerdal, floats down vast quantities of timber. The new town on the right bank is therefore a centre of the timber export trade, this place being the principal port in Norway for the export of pit-props, planed boards, and other varieties of timber. There is also a great industry in the making of red bricks, owing to the expansion of Christiania, Gothenburg and other towns. Granite is quarried and exported. Besides the large number of saw and planing mills, there are shipbuilding yards, engine and boiler works, cotton and woollen mills, and factories for acetic acid and naphtha. The harbour, which can be entered by vessels drawing 14 ft., is kept open in winter by an ice-breaker. In the vicinity is the island Hankø, the most fashionable Norwegian seaside resort. The old town on the left bank was founded by Frederick II. in 1567. It was for a long time strongly fortified, and in 1716 Charles XII. of Sweden made a vain attempt to capture it.

FREE BAPTISTS, formerly called (but no longer officially) **FREEWILL BAPTISTS**, an American denomination holding anti-paedobaptist and anti-Calvinistic doctrines, and practically identical in creed with the General Baptists of Great Britain. Many of the early Baptist churches in Rhode Island and throughout the South were believers in "general redemption" (hence called "general" Baptists); and there was a largely attended conference of this Arminian branch of the church at Newport in 1720. But the denomination known as "Free-willers" had its rise in 1779-1780, when anti-Calvinists in Loudon, Barrington and Canterbury, New Hampshire, seceded and were organized by Benjamin Randall (1740-1808), a native of New Hampshire. Randall was an itinerant missionary, who had been preaching for two years before his ordination in 1780; in the same year he was censured for "heterodox" teaching. The work of the church suffered a relapse after his death, and a movement to join

the Freewill Baptists with the "Christians," who were led by Elias Smith (1769-1846) and had been bitterly opposed by Randall, was nearly successful. Between 1820 and 1830 the denomination made considerable progress, especially in New England and the Middle West. The Freewill Baptists were joined in 1841 by many "open-communion Baptists"—those in the Carolinas who did not join the larger body distinguishing themselves by the name of Original Freewill Baptists—and soon afterwards by some of the General Baptists of North Carolina and some of the Six Principle Baptists of Rhode Island (who had added the "laying on of hands" to the Five Principles hitherto held); and the abbreviation of the denominational name to "Free Baptists" suggests their liberal policy—indeed open communion is the main if not the only hindrance to union with the "regular" Baptist Church.

Colleges founded by the denomination, all co-educational, are: Hillsdale College, opened at Spring Harbor as Michigan Central College in 1844, and established at Hillsdale, Michigan, in 1855; Bates College, Lewiston, Maine, 1863, now non-sectarian; Rio Grande College, Rio Grande, Ohio, 1876; and Parker College, Winnebago City, Minnesota, opened in 1888. At the close of 1909 there were 1294 ministers, 1303 churches, and 73,536 members of the denomination in the United States. *The Morning Star* of Boston, established in 1826, is the most prominent journal published by the church. In British North America, according to a Canadian census bulletin of 1902, there were, in 1901, 24,229 Free Baptists, of whom 15,502 were inhabitants of New Brunswick, 8355 of Nova Scotia, 246 of Ontario, and 87 of Quebec. The United Societies of Free Baptist Young People, an international organization founded in 1888, had in 1907 about 15,000 members. At the close of 1907 the "Original Freewill Baptists" had 120 ministers, 167 churches, and 12,000 members, practically all in the Carolinas.

See I. D. Stewart, *History of the Free Will Baptists* (Dover, N. H., 1862) for 1780-1830, and his edition of the *Minutes of the General Conference of the Free Will Baptist Connexion* (Boston, 1887); James B. Taylor, *The Centennial Record of the Free Will Baptists* (Dover, 1881); John Buzzell, *Memoir of Elder Benjamin Randall* (Parsonfield, Maine, 1827); and P. Richardson, "Randall and the Free Will Baptists," in *The Christian Review*, vol. xxiii. (Baltimore, 1858).

FREEBENCH, in English law, the interest which a widow has in the copyhold lands of her husband, corresponding to dower in the case of freeholds. It depends upon the custom of the manor, but as a general rule the widow takes a third for her life of the lands of which her husband dies seised, but it may be an estate greater or less than a third. If the husband surrenders his copyhold and the surrender is admitted, or if he contracts for a sale, it will defeat the widow's freebench. As freebench is regarded as a continuation of the husband's estate, the widow does not (except by special custom) require to be admitted.

FREE CHURCH FEDERATION, a voluntary association of British Nonconformist churches for co-operation in religious, social and civil work. It was the outcome of a unifying tendency displayed during the latter part of the 19th century. About 1890 the proposal that there should be a Nonconformist Church Congress analogous to the Anglican Church Congress was seriously considered, and the first was held in Manchester on the 7th of November 1892. In the following year it was resolved that the basis of representation should be neither personal (as in the Anglican Church Congress) nor denominational, but territorial. England and Wales have since been completely covered with a network of local councils, each of which elects its due proportion of representatives to the national gathering. This territorial arrangement eliminated all sectarian distinctions, and also the possibility of committing the different churches as such to any particular policy. The representatives of the local councils attend not as denominationalists but as Evangelical Free Churchmen. The name of the organization was changed from Congress to National Council as soon as the assembly ceased to be a fortuitous concourse of atoms, and consisted of duly appointed representatives from the local councils of every part of England. The local councils consist of representatives of the Congregational and Baptist Churches, the Methodist Churches,

the Presbyterian Church of England, the Free Episcopal Churches, the Society of Friends, and such other Evangelical Churches as the National Council may at any time admit. The constitution states the following as the objects of the National Council: (a) To facilitate fraternal intercourse and co-operation among the Evangelical Free Churches; (b) to assist in the organization of local councils; (c) to encourage devotional fellowship and mutual counsel concerning the spiritual life and religious activities of the Churches; (d) to advocate the New Testament doctrine of the Church, and to defend the rights of the associated Churches; (e) to promote the application of the law of Christ in every relation of human life. Although the objects of the Free Church councils are thus in their nature and spirit religious rather than political, there are occasions on which action is taken on great national affairs. Thus a thorough-going opposition was offered to the Education Act of 1902, and whole-hearted support accorded to candidates at the general election of 1906 who pledged themselves to altering that measure.

A striking feature of the movement is the adoption of the parochial system for the purpose of local work. Each of the associated churches is requested to look after a parish, not of course with any attempt to exclude other churches, but as having a special responsibility for those in that area who are not already connected with some existing church. Throughout the United Kingdom local councils are formed into federations, some fifty in number, which are intermediate between them and the national council. The local councils do what is possible to prevent overlapping and excessive competition between the churches. They also combine the forces of the local churches for evangelistic and general devotional work, open-air services, efforts on behalf of Sunday observance, and the prevention of gambling. Services are arranged in connexion with workhouses, hospitals and other public institutions. Social work of a varied character forms a large part of the operations of the local councils, and the Free Church Girls' Guild has a function similar to that of the Anglican Girls' Friendly Society. The national council engages in mission work on a large scale, and a considerable number of periodicals, hymn-books for special occasions, and works of different kinds explaining the history and ideals of the Evangelical Free Churches have been published. The churches represented in the National Council have 9966 ministers, 55,828 local preachers, 407,991 Sunday-school teachers, 3,416,377 Sunday scholars, 2,178,221 communicants, and sitting accommodation for 8,555,460.

A remarkable manifestation of this unprecedented reunion was the fact that a committee of the associated churches prepared and published a catechism expressing the positive and fundamental agreement of all the Evangelical Free Churches on the essential doctrines of Christianity (see *The Contemporary Review*, January 1899). The catechism represents substantially the creed of not less than 80,000,000 Protestants. It has been widely circulated throughout Great Britain, the British Colonies and the United States of America, and has also been translated into Welsh, French and Italian.

The movement has spread to all parts of Australia, New Zealand, South Africa, Jamaica, the United States of America and India. It is perhaps necessary to add that it differs essentially from the Evangelical Alliance, inasmuch as its unit is not an individual, private Christian, but a definitely organized and visible Church. The essential doctrine of the movement is a particular doctrine of churchmanship which, as explained in the catechism, regards the Lord Jesus Christ as the sole and Divine Head of every branch of the Holy Catholic Church throughout the world. For this reason those who do not accept the deity of Christ are necessarily excluded from the national council and its local constituent councils.

FREE CHURCH OF ENGLAND, a Protestant episcopal church "essentially one with the established church of England, but free to go into any parish, to use a revised edition of the Book of Common Prayer, to associate the laity with the clergy in the government and work of the church, and to hold communion with Christians of other denominations." It was founded in 1844

in opposition to the Tractarian movement, and embodies the distinctively evangelical elements of the Reformation. It preserves and maintains to the letter all that is Protestant and evangelical in the liturgy and services of the Anglican church, while its free constitution and revised formularies meet the needs of members of that communion who resent sacerdotal and ritualistic tendencies. There are two dioceses (northern and southern) each with a bishop, about 30 churches and ministers, and about 1300 members.

FREE CHURCH OF SCOTLAND. In one sense the Free Church of Scotland dated its existence from the Disruption of 1843, in another it claimed to be the rightful representative of the National Church of Scotland (see SCOTLAND, CHURCH OF) as it was reformed in 1560.¹ In the ecclesiastical history of Scotland the Free Churchman sees three great reforming periods. In his view these deserve to be called reforming on many accounts, but most especially because in them the independence of the church, her inherent scriptural right to exercise a spiritual jurisdiction in which she is responsible to her Divine Head alone, was both earnestly asserted and practically maintained. The first reformation extended from 1560, when the church freely held her first General Assembly, and of her own authority acted on the First Book of Discipline, to 1592, when her Presbyterian order was finally and fully ratified by the parliament. The second period began in 1638, when, after 20 years of suspended animation, the Assembly once more shook off Episcopacy, and terminated in 1649, when the parliament of Scotland confirmed the church in her liberties in a larger and ampler sense than before. The third period began in 1834, when the Assembly made use of what the church believed to be her rights in passing the Veto and Chapel Acts. It culminated in the Disruption of 1843.

The fact that the Church, as led first by John Knox and afterwards by Andrew Melville, claimed an inherent right to exercise a spiritual jurisdiction is notorious. More apt to be overlooked is the comparative freedom with which that right was actually used by the church irrespective of state recognition. That recognition was not given until after the queen's resignation in 1567;² but, for several years before it came, the church had been holding her Assemblies and settling all questions of discipline, worship, and administration as they arose, in accordance with the first book of polity or discipline which had been drawn up in 1560. Further, in 1581 she, of her own motion, adopted a second book of a similar character, in which she expressly claimed an independent and exclusive jurisdiction or power in all matters ecclesiastical, "which flows directly from God and the Mediator Jesus Christ, and is spiritual, not having a temporal head on earth, but only Christ, the only king and governor of his church"; and this claim, though directly negated in 1584 by the "Black Acts," which included an Act of Supremacy over estates spiritual and temporal, continued to be asserted by the Assemblies, until at last it also was practically allowed in the act of 1592.³ This legislation of 1592, however, did not long remain in force. An act of parliament in 1606, which "reposed, restored and reintegrated" the estate of bishops to their ancient dignities, prerogatives and privileges, was followed by several acts of various subservient assemblies, which, culminating in that of 1618, practically amounted to a complete surrender of jurisdiction by the church itself. For twenty years no Assemblies whatever were held. This interval must necessarily be regarded from the Presbyterian point of view as having been one of very deep depression. But a second reformation, characterized by great

¹ "It is her being free, not her being established, that constitutes the real historical and hereditary identity of the Reformed National Church of Scotland." See *Act and Declaration, &c.*, of Free Assembly, 1851.

² In the act *Anent the true and holy Kirk, and of those that are declared not to be of the same.* This act was supplemented by that of 1579, *Anent the Jurisdiction of the Kirk.*

³ The Second Book of Discipline was not formally recognized in that act; but all former acts against "the jurisdiction and discipline of the true Kirk as the same is used and exercised within the realm" were abolished; and all "liberties, privileges, immunities and freedoms whatsoever" previously granted were ratified and approved.

energy and vigour, began in 1638. The proceedings of the Assembly of that year, afterwards tardily and reluctantly acquiesced in by the state, finally issued in the acts of parliament of 1649, by which the Westminster standards were ratified, lay-patronage was abolished, and the coronation oath itself framed in accordance with the principles of Presbyterian church government. Another period of intense reaction soon set in. No Assemblies were permitted by Cromwell after 1653; and, soon after the Restoration, Presbytery was temporarily overthrown by a series of rescissory acts. Nor was the Revolution Settlement of 1690 so entirely favourable to the freedom of the church as the legislation of 1649 had been. Prelacy was abolished, and various obnoxious statutes were repealed, but the acts rescissory were not cancelled; presbyterianism was re-established, but the statutory recognition of the Confession of Faith took no notice of certain qualifications under which that document had originally been approved by the Assembly of 1647;⁴ the old rights of patrons were again discontinued, but the large powers which had been conferred on congregations by the act of 1649 were not wholly restored. Nevertheless the great principle of a distinct ecclesiastical jurisdiction, embodied in the Confession of Faith, was accepted without reservation, and a Presbyterian polity effectively confirmed both then and at the ratification of the treaty of Union. This settlement, however, did not long subsist unimpaired. In 1712 the act of Queen Anne, restoring patronage to its ancient footing, was passed in spite of the earnest remonstrances of the Scottish people. For many years afterwards (until 1784) the Assembly continued to instruct each succeeding commission to make application to the king and the parliament for redress of the grievance. But meanwhile a new phase of Scottish ecclesiastical politics commonly known as Moderatism had been inaugurated, during the prevalence of which the church became even more indifferent than the lay patrons themselves to the rights of her congregations with regard to the "calling" of ministers. From the Free Church point of view, the period from which the secessions under Ebenezer Erskine and Thomas Gillespie are dated was also characterized by numerous other abuses on the Church's part which amounted to a practical surrender of the most important and distinctive principles of her ancient Presbyterian polity.⁵ Towards the beginning of the present century there were many circumstances, both within and without the church, which conspired to bring about an evangelical and popular reaction against this reign of "Moderatism." The result was a protracted struggle, which is commonly referred to as the Ten Years' Conflict, and which has been aptly described as the last battle in the long war which for nearly 300 years had been waged within the church itself, between the friends and the foes of the doctrine of an exclusive ecclesiastical jurisdiction. That final struggle may be said to have begun with the passing in 1834 of the "Veto" Act, by which it was declared to be a fundamental law of the church that no pastor should be intruded on a congregation contrary to the will of the people,⁶ and by which it was provided that the simple dissent of a majority of heads of families in a parish should be enough to warrant a presbytery in rejecting a presentee. The question of the legality of this measure soon came to be tried in the civil courts; and it was ultimately answered in a sense unfavourable to the church by the decision (1838) of the court of session in the Auchterarder case, to the effect that a presbytery had no right to reject a presentee simply because the parishioners protested against his settlement, but was bound to disregard the veto (see CHALMERS, THOMAS). This decision elicited from the Assembly

⁴ The most important of these had reference to the full right of a constituted church to the enjoyment of an absolutely unrestricted freedom in convening Assemblies. This very point on one occasion at least threatened to be the cause of serious misunderstandings between William and the people of Scotland. The difficulties were happily smoothed, however, by the wisdom and tact of William Carstairs.

⁵ See *Act and Declaration of Free Assembly, 1851.*

⁶ This principle had been asserted even by an Assembly so late as that of 1736, and had been invariably presupposed in the "call," which had never ceased to be regarded as an indispensable prerequisite for the settlement of a minister.

of that year a new declaration of the doctrine of the spiritual independence of the church. The "exclusive jurisdiction of the civil courts in regard to the civil rights and emoluments secured by law to the church and the ministers thereof" was acknowledged without qualification; and continued implicit obedience to their decisions with reference to these rights and emoluments was pledged. At the same time it was insisted on "that, as is declared in the Confession of Faith of this National Established Church, 'the Lord Jesus Christ, as King and Head of the church, hath therein appointed a government in the hand of church officers distinct from the civil magistrate'; and that in all matters touching the doctrine, discipline and government of the church her judicatories possess an exclusive jurisdiction, founded on the Word of God, which power ecclesiastical" (in the words of the Second Book of Discipline) "flows immediately from God and the Mediator the Lord Jesus Christ, and is spiritual, not having a temporal head on earth, but only Christ, the only spiritual King and Governor of His Kirk." And it was resolved to assert, and at all hazards defend, this spiritual jurisdiction, and firmly to enforce obedience to the same upon the office-bearers and members of the church. The decision of the court of session having been confirmed by the House of Lords early in 1839, it was decided in the Assembly of that year that the church, while acquiescing in the loss of the temporalities at Auchterarder, should reaffirm the principle of non-intrusion as an integral part of the constitution of the Reformed Church of Scotland, and that a committee should be appointed to confer with the government with a view to the prevention, if possible, of any further collision between the civil and ecclesiastical authorities. While the conference with the government had no better result than an unsuccessful attempt at compromise by means of Lord Aberdeen's Bill, which embodied the principle of a dissent with reasons, still graver complications were arising out of the Marnoch and other cases.¹ In the circumstances it was resolved by the Assembly of 1842 to transmit to the queen, by the hands of the lord high commissioner, a "claim, declaration, and protest," complaining of the encroachments of the court of session,² and also an address praying for the abolition of patronage. The home secretary's answer (received in January 1843) gave no hope of redress. Meanwhile the position of the

¹ According to the Free Church "Protest" of 1843 it was in these cases decided (1) that the courts of the church were liable to be compelled to intrude ministers on reclaiming congregations; (2) that the civil courts had power to interfere with and interdict the preaching of the gospel and administration of ordinances as authorized and enjoined by the church; (3) that the civil courts had power to suspend spiritual censures pronounced by the courts of the church, and to interdict their execution as to spiritual effects, functions and privileges; (4) that deposed ministers, and probationers deprived of their licence, could be restored by the mandate of the civil courts to the spiritual office and status of which the church courts had deprived them; (5) that the right of membership in ecclesiastical courts could be determined by the civil courts; (6) that the civil courts had power to supersede the majority of a church court of the Establishment in regard to the exercise of its spiritual functions as a church court, and to authorize the minority to exercise the said functions in opposition to the court itself and to the superior judicatories of the church; (7) that processes of ecclesiastical discipline could be arrested by the civil courts; and (8) that without the sanction of the civil courts no increased provision could be made for the spiritual care of a parish, although such provision left all civil rights and patrimonial interests untouched.

² The narrative and argument of this elaborate and able document cannot be reproduced here. In substance it is a claim "as of right" on behalf of the church and of the nation and people of Scotland that the church shall freely possess and enjoy her liberties, government, discipline, rights and privileges according to law, and that she shall be protected therein from the foresaid unconstitutional and illegal encroachments of the said court of session, and her people secured in their Christian and constitutional rights and liberties. This claim is followed by the "declaration" that the Assembly cannot intrude ministers on reclaiming congregations, or carry on the government of Christ's church subject to the coercion of the court of session; and by the "protest" that all acts of the parliament of Great Britain passed without the consent of the Scottish church and nation, in alteration or derogation of the government, discipline, rights and privileges of the church, as also all sentences of courts in contravention of said government, discipline, rights and privileges, "are and shall be in themselves void and null, and of no legal force or effect."

evangelical party had been further hampered by the decision of the court of session declaring the ministers of chapels of ease to be unqualified to sit in any church court. A final appeal to parliament by petition was made in March 1843, when, by a majority of 135 (211 against 76), the House of Commons declined to attempt any redress of the grievances of the Scottish Church.³ At the first session of the following General Assembly (18th May 1843) the reply of the non-intrusion party was made in a protest, signed by upwards of 200 commissioners, to the effect that since, in their opinion, the recent decisions of the civil courts, and the still more recent sanction of these decisions by the legislature, had made it impossible at that time to hold a free Assembly of the church as by law established, they therefore "protest that it shall be lawful for us, and such other commissioners as may concur with us, to withdraw to a separate place of meeting, for the purpose of taking steps for ourselves and all who adhere to us—maintaining with us the Confession of Faith and standards of the Church of Scotland as heretofore understood—for separating in an orderly way from the Establishment, and thereupon adopting such measures as may be competent to us, in humble dependence on God's grace and the aid of His Holy Spirit, for the advancement of His glory, the extension of the gospel of our Lord and Saviour, and the administration of the affairs of Christ's house according to His holy word." The reading of this document was followed by the withdrawal of the entire non-intrusion party to another place of meeting, where the first Assembly of the Free Church was constituted, with Dr Thomas Chalmers as moderator. This Assembly sat from the 18th to the 30th of May, and transacted a large amount of important business. On Tuesday the 23rd, 396⁴ ministers and professors publicly adhibited their names to the Act of Separation and deed of demission by which they renounced all claim to the benefices they had held in connexion with the Establishment, declaring them to be vacant, and consenting to their being dealt with as such. By this impressive proceeding the signatories voluntarily surrendered an annual income amounting to fully £100,000.

The first care of the voluntarily disestablished church was to provide incomes for her clergy and places of worship for her people. As early as 1841 indeed the leading principle of a "sustentation fund" for the support of the ministry had been announced by Dr Robert Smith Candlish; and at "Convocation," a private unofficial meeting of the members of the evangelical or non-intrusion party held in November 1842, Dr Chalmers was prepared with a carefully matured scheme according to which "each congregation should do its part in sustaining the whole, and the whole should sustain each congregation." Between November 1842 and May 1843, 647 associations had been formed; and at the first Assembly it was announced that upwards of £17,000 had already been contributed. At the close of the first financial year (1843-1844) it was reported that the fund had exceeded £61,000. It was participated in by 583 ministers; and 470 drew the full equal dividend of £105. Each successive year showed a steady increase in the gross amount of the fund; but owing to an almost equally rapid increase of the number of new ministerial charges participating in its benefits, the stipend payable to each minister did not for many years reach the sum of £150 which had been aimed at as a minimum. Thus in 1844-1845 the fund had risen to £76,180, but the ministers had also increased to 627, and the equal dividend therefore was only £122. During the first ten years the annual income averaged £84,057; during the next decade £108,643; and during the third £130,246. The minimum of £150 was reached at last in 1868; and subsequently the balance remaining after that minimum had been provided was treated as a surplus fund, and distributed among those ministers whose congregations have contributed at certain specified rates per member. In 1878 the total amount received for this fund was upwards of £177,000; in this 1075 ministers participated. The full equal dividend of £157 was paid to 766 ministers; and additional grants of £36 and £18

³ The Scottish members voted with the minority in the proportion of 25 to 12.

⁴ The number ultimately rose to 474.

were paid out of the surplus fund to 632 and 129 ministers respectively.

To provide for the erection of the buildings which, it was foreseen, would be necessary, a general building fund, in which all should share alike, was also organized, and local building funds were as far as possible established in each parish, with the result that at the first Assembly a sum of £104,776 was reported as already available. By May 1844 a further sum of £123,060 had been collected, and 470 churches were reported as completed or nearly so. In the following year £131,737 was raised and 60 additional churches were built. At the end of four years considerably more than 700 churches had been provided.

During the winter session 1843-1844 the divinity students who had joined the Free Church continued their studies under Dr Chalmers and Dr David Welsh (1793-1845); and at the Assembly of 1844 arrangements were made for the erection of suitable collegiate buildings. The New College, Edinburgh, was built in 1847 at a cost of £46,506; and divinity halls were subsequently set up also in Glasgow and Aberdeen. In 1878 there were 13 professors of theology, with an aggregate of 230 students,—the numbers at Edinburgh, Glasgow and Aberdeen respectively being 129, 69 and 32.

A somewhat unforeseen result of the Disruption was the necessity for a duplicate system of elementary schools. At the 1843 Assembly it was for the first time announced by Dr Welsh that "schools to a certain extent must be opened to afford a suitable sphere of occupation for parochial and still more for private teachers of schools, who are threatened with deprivation of their present office on account of their opinions upon the church question." The suggestion was taken up with very great energy, with the result that in May 1845, 280 schools had been set up, while in May 1847 this number had risen to 523, with an attendance of upwards of 44,000 scholars. In 1869 it was stated in an authoritative document laid before members of parliament that at that time there were connected with and supported by the Free Church 598 schools (including two normal schools), with 633 teachers and 64,115 scholars. The school buildings had been erected at a cost of £220,000, of which the committee of privy council had contributed £35,000, while the remainder had been raised by voluntary effort. Annual payments made to teachers, &c., as at 1869, amounted to £16,000. In accordance with certain provisions of the Education Act of 1872 most of the schools of the Free Church were voluntarily transferred, without compensation, to the local school boards. The normal schools are now transferred to the state.

It has been seen already that during the period of the Ten Years' Conflict the non-intrusion party strenuously denied that in any one respect it was departing from acknowledged principles of the National Church. It continued to do so after the Disruption. In 1846, however, it was found to have become necessary, "in consequence of the late change in the outward condition of the church," to amend the "questions and formula" to be used at the licensing of probationers and the ordination of office-bearers. These were amended accordingly; and at the same time it was declared that, "while the church firmly maintains the same scriptural principles as to the duties of nations and their rulers in reference to true religion and the Church of Christ for which she has hitherto contended, she disclaims intolerant or persecuting principles, and does not regard her Confession of Faith, or any portion thereof when fairly interpreted, as favouring intolerance or persecution, or consider that her office-bearers by subscribing it profess any principles inconsistent with liberty of conscience and the right of private judgment." The main difference between the "formula" of the Free Church and that of the Established Church (as at the year 1900) was that the former referred to the Confession of Faith simply as "approved by General Assemblies of this Church," while the latter described it as "approved by the General Assemblies of this National Church, and ratified by law in the year 1690, and frequently confirmed by divers Acts of Parliament since that time." The former inserted an additional clause,—“I also approve of the general principles respecting the jurisdiction of the church,

and her subjection to Christ as her only Head, which are contained in the Claim of Right and in the Protest referred to in the questions already put to me"; and also added the words which are here distinguished by italics,—“And I promise that through the grace of God I shall firmly and constantly adhere to the same, and to the utmost of my power shall in my station assert, maintain, and defend the said doctrine, worship, discipline and government of this church by kirk-sessions, presbyteries, provincial synods, and general assemblies, *together with the liberty and exclusive jurisdiction thereof*; and that I shall, in my practice, conform myself to the said worship and submit to the said discipline [and] government, *and exclusive jurisdiction*, and not endeavour directly or indirectly the prejudice or subversion of the same." In the year 1851 an act and declaration anent the publication of the subordinate standards and other authoritative documents of the Free Church of Scotland was passed, in which the historical fact is recalled that the Church of Scotland had formally consented to adopt the Confession of Faith, catechisms, directory of public worship, and form of church government agreed upon by the Westminster Assembly; and it is declared that "these several formularies, as ratified, with certain explanations, by divers Acts of Assembly in the years 1645, 1646, and particularly in 1647, this church continues till this day to acknowledge as her subordinate standards of doctrine, worship and government."¹

In 1858 circumstances arose which, in the opinion of many, seemed fitted to demonstrate to the Free Church that her freedom was an illusion, and that all her sacrifices had been made in vain. John Macmillan, minister of Cardross, accused of immorality, had been tried and found guilty by the Free Presbytery of Dumbarton. Appeal having been taken to the synod, an attempt was there made to revive one particular charge, of which he had been finally acquitted by the presbytery; and this attempt was successful in the General Assembly. That ultimate court of review did not confine itself to the points appealed, but went into the merits of the whole case as it had originally come before the presbytery. The result was a sentence of suspension. Macmillan, believing that the Assembly had acted with some irregularity, applied to the court of session for an interdict against the execution of that sentence; and for this act he was summoned to the bar of the Assembly to say whether or not it was the case that he had thus appealed. Having answered in the affirmative, he was deposed on the spot. Forthwith he raised a new action (his previous application for an interdict had been refused) concluding for reduction of the spiritual sentence of deposition and for substantial damages. The defences lodged by the Free Church were to the effect that the civil courts had no right to review and reduce spiritual sentences, or to decide whether the General Assembly of the Free Church had acted irregularly or not. Judgments adverse to the defenders were delivered on these points; and appeals were taken to the House of Lords. But before the case could be heard there, the lord president took an opportunity in the court of session to point out to the pursuer that, inasmuch as the particular General Assembly against which the action was brought had ceased to exist, it could not therefore be made in any circumstances to pay damages, and that the action of reduction of the spiritual sentence, being only auxiliary to the claim of damages, ought therefore to be dismissed. He further pointed out that Macmillan might obtain redress in another way, should he be able to prove malice against individuals. Very soon after this deliverance of the lord president, the case as it had stood against the Free Church was withdrawn, and Macmillan gave notice of an action of a wholly different kind. But this last was not persevered in. The appeals which had been taken to the House of Lords were, in these circumstances, also departed from by the Free Church. The case did not advance sufficiently to show

¹ By this formal recognition of the qualifications to the Confession of Faith made in 1647 the scruples of the majority of the Associate Synod of Original Seceders were removed, and 27 ministers, along with a considerable number of their people, joined the Free Church in the following year.

how far the courts of law would be prepared to go in the direction of recognizing voluntary tribunals and a kind of secondary exclusive jurisdiction founded on contract.¹ But, whether recognized or not, the church for her part continued to believe that she had an inherent spiritual jurisdiction, and remained unmoved in her determination to act in accordance with that resolution "notwithstanding of whatsoever trouble or persecution may arise."²

In 1863 a motion was made and unanimously carried in the Free Church Assembly for the appointment of a committee to confer with a corresponding committee of the United Presbyterian Synod, and with the representatives of such other disestablished churches as might be willing to meet and deliberate with a view to an incorporating union. Formal negotiations between the representatives of these two churches were begun shortly afterwards, which resulted in a report laid before the following Assembly. From this document it appeared that the committees of the two churches were not at one on the question as to the relation of the civil magistrate to the church. While on the part of the Free Church it was maintained that he "may lawfully acknowledge, as being in accordance with the Word of God, the creed and jurisdiction of the church," and that "it is his duty, when necessary and expedient, to employ the national resources in aid of the church, provided always that in doing so, while reserving to himself full control over the temporalities which are his own gift, he abstain from all authoritative interference in the internal government of the church," it was declared by the committee of the United Presbyterian Church that, "inasmuch as the civil magistrate has no authority in spiritual things, and as the employment of force in such matters is opposed to the spirit and precepts of Christianity, it is not within his province to legislate as to what is true in religion, to prescribe a creed or form of worship to his subjects, or to endow the church from national resources." In other words, while the Free Church maintained that in certain circumstances it was lawful and even incumbent on the magistrate to endow the church and on the church to accept his endowment, the United Presbyterians maintained that in no case was this lawful either for the one party or for the other. Thus in a very short time it had been made perfectly evident that a union between the two bodies, if accomplished at all, could only be brought about on the understanding that the question as to the lawfulness of state endowments should be an open one. The Free Church Assembly, by increasing majorities, manifested a readiness for union, even although unanimity had not been attained on that theoretical point. But there was a minority which did not sympathize in this readiness, and after ten years of fruitless effort it was in 1873 found to be expedient that the idea of union with the United Presbyterians should for the time be abandoned. Other negotiations, however, which had been entered upon with the Reformed Presbyterian Church at a somewhat later date proved more successful; and a majority of the ministers of that church with their congregations were united with the Free Church in 1876.

(J. S. Bz.)

In the last quarter of the 19th century the Free Church continued to be the most active, theologically, of the Scottish Churches. The College chairs were almost uniformly filled by advanced critics or theologians, inspired more or less by Professor A. B. Davidson. Dr A. B. Bruce, author of *The Training of the Twelve*, &c., was appointed to the chair of apologetics and New Testament exegesis in the Glasgow College in 1875; Henry Drummond (author of *Natural Law in the Spiritual World*, &c.) was made lecturer in natural science in the same college in 1877 and became professor in 1884; and Dr George Adam Smith (author of *The Twelve Prophets*, &c.) was called to the Hebrew chair in 1892. Attempts were made between 1890 and 1895 to bring all these professors except Davidson (similar attacks were also made on Dr Marcus Dods, afterwards principal of the

New College, Edinburgh) to the bar of the Assembly for unsound teaching or writing; but in every case these were abortive, the Assembly never taking any step beyond warning the accused that their primary duty was to teach and defend the church's faith as embodied in the confession. In 1892 the Free Church, following the example of the United Presbyterian Church and the Church of Scotland (1889), passed a Declaratory Act relaxing the stringency of subscription to the confession, with the result that a small number of ministers and congregations, mostly in the Highlands, severed their connexion with the church and formed the Free Presbyterian Church of Scotland, on strictly and straitly orthodox lines. In 1907 this body had twenty congregations and twelve ministers.

The Free Church always regarded herself as a National Church, and during this period she sought actively to be true to that character by providing church ordinances for the increasing population of Scotland and applying herself to the new problems of non-church-going, and of the changing habits of the people. Her Assembly's committee on religion and morals worked toward the same ends as the similar organization of the Established Church, and in her, as in the other churches, the standard of parochial and congregational activity was raised and new methods of operation devised. She passed legislation on the difficult problem of ridding the church of inefficient ministers. The use of instrumental music was sanctioned in Free Churches during this period. An association was formed in 1891 to promote the ends of edification, order and reverence in the public services of the church, and published in 1898 *A New Directory for Public Worship* which does not provide set forms of prayer, but directions as to the matter of prayer in the various services. The Free Church took a large share in the study of hymnology and church music, which led to the production of *The Church Hymnary*. From 1885 to 1895 much of the energy of all the Presbyterian churches was absorbed by the disestablishment agitation. In the former year the Free Church, having almost entirely shed the establishment principle on which it was founded, began to rival the United Presbyterian Church in its resolutions calling for the disestablishment of the Church of Scotland. In spite of the offers of the Establishment Assembly to confer with the dissenting churches about union, the assaults upon its status waxed in vigour, till in 1893 the Free Church hailed the result of the general election as a verdict of the constituencies in favour of disestablishment, and insisted upon the government of the day taking up Sir Charles Cameron's bill.

During the last four or five years of the century the Free and United Presbyterian churches, which after the failure of their union negotiations in 1873 had been connected together by a Mutual Eligibility Act enabling a congregation of one church to call a minister from the other, devoted their energy to the arrangement of an incorporating union. The Synod of the United Presbyterian Church resolved in 1896 to "take steps towards union," and in the following year the Free Assembly responded by appointing a committee to confer with a committee of the other church. The joint committee discovered a "remarkable and happy agreement" between the doctrinal standards, rules and methods of the two bodies, and with very little concessions on either side a common constitution and common "questions and formula" for the admission of ministers and office-bearers were arranged. A minority, always growing smaller, of the Free Church Assembly, protested against the proposed union, and threatened if it were carried through to test its legality in the courts. To meet this opposition, the suggestion is understood to have been made that an act of parliament should be applied for to legalize the union; but this was not done, and the union was carried through on the understanding that the question of the lawfulness of church establishments should be an open one.

The supreme courts of the churches met for the last time in their respective places of meeting on the 30th of October 1900, and on the following day the joint meeting took place at which the union was completed, and the United Free Church of Scotland (q.v.) entered on its career. The protesting and

¹ See Taylor Innes, *Law of Creeds in Scotland*, p. 258 seq.

² The language of Dr Buchanan, for example, in 1860 was (*mutatis mutandis*) the same as that which he had employed in 1838 in moving the Independence resolution already referred to.

dissenting minority at once claimed to be the Free Church. They met outside the Free Assembly Hall on the 31st of October, and, failing to gain admission to it, withdrew to another hall, where they elected Mr Colin Bannatyne their moderator and held the remaining sittings of the Assembly. It was reported that between 16,000 and 17,000 names had been received of persons adhering to the anti-unionist principle. At the Assembly of 1901 it was stated that the Free Church had twenty-five ministers and at least sixty-three congregations. The character of the church is indicated by the fact that its office-bearers were the faithful survivors of the decreasing minority of the Old Free Church, which had protested against the disestablishment resolutions, against the relaxation of subscription, against toleration of the teaching of the Glasgow professors, and against the use in worship of organs or of human hymns. Her congregations were mostly in the Gaelic-speaking districts of Scotland. She was confronted with a very arduous undertaking; her congregations grew in number, but were far from each other and there were not nearly enough ministers. The Highlands were filled, by the Union, with exasperation and dispeace which could not soon subside. The church met with no sympathy or assistance at the hands of the United Free Church, and her work was conducted at first under considerable hardships, nor was her position one to appeal to the general popular sentiment of Scotland. But the little church continued her course with indomitable courage and without any compromise of principle. The Declaratory Act of 1802 was repealed after a consultation of presbyteries, and the old principles as to worship were declared. A professor was obliged to withdraw a book he had written, in which the results of criticism, with regard to the Synoptic Gospels, had been accepted and applied. The desire of the Church of Scotland to obtain relaxation of her formula was declared to make union with her impossible. Along with this unbending attitude, signs of material growth were not wanting. The revenue of the church increased; the grant from the sustentation fund was in 1901 only £75, but from 1903 onwards it was £167.

The decision of the House of Lords in 1904 did not bring the trials of the Free Church to an end. In the absence of any arrangement with the United Free Church, she could only gain possession of the property declared to belong to her by an application in each particular case to the Court of Session, and a series of law-suits began which were trying to all parties. In the year 1905 the Free Church Assembly met in the historic Free Church Assembly Hall, but it did not meet there again. Having been left by the awards of the commission without any station in the foreign mission field, the Free Church resolved to start a foreign mission of her own. The urgent task confronting the church was that of supplying ordinances to her congregations. The latter numbered 200 in 1907, and the church had as yet only 74 ordained ministers, so that many of the mansees allocated to her by the commissioners were not yet occupied, and catechists and elders were called to conduct services where possible. The gallant stand this little church had made for principles which were no longer represented by any Presbyterian church outside the establishment attracted to her much interest and many hopes that she might be successful in her endeavours to do something for the religious life of Scotland.

See SCOTLAND, CHURCH OF, for bibliography and statistics. (A.M. *)

FREEDMEN'S BUREAU (officially the BUREAU OF FREEDMEN, REFUGEES AND ABANDONED LANDS), a bureau created in the United States war department by an act of Congress, 3rd of March 1865, to last one year, but continued until 1872 by later acts passed over the president's veto. Its establishment was due partly to the fear entertained by the North that the Southerners if left to deal with the blacks would attempt to re-establish some form of slavery, partly to the necessity for extending relief to needy negroes and whites in the lately conquered South, and partly to the need of creating some commission or bureau to take charge of lands confiscated in the South. During the Civil War a million negroes fell into the hands of the Federals and had to be cared for. Able-bodied blacks were enlisted in the army, and the women, children and old men were settled in large

camp on confiscated Southern property, where they were cared for alternately by the war department and by the treasury department until the organization of the Freedmen's Bureau. At the head of the bureau was a commissioner, General O. O. Howard, and under him in each Southern state was an assistant commissioner with a corps of local superintendents, agents and inspectors. The officials had the broadest possible authority in all matters that concerned the blacks. The work of the bureau may be classified as follows: (1) distributing rations and medical supplies among the blacks; (2) establishing schools for them and aiding benevolent societies to establish schools and churches; (3) regulating labour and contracts; (4) taking charge of confiscated lands; and (5) administering justice in cases in which blacks were concerned. For several years the ex-slaves were under the almost absolute control of the bureau. Whether this control had a good or bad effect is still disputed, the Southern whites and many Northerners holding that the results of the bureau's work were distinctly bad, while others hold that much good resulted from its work. There is now no doubt, however, that while most of the higher officials of the bureau were good men, the subordinate agents were generally without character or judgment and that their interference between the races caused permanent discord. Much necessary relief work was done, but demoralization was also caused by it, and later the institution was used by its officials as a means of securing negro votes. In educating the blacks the bureau made some progress, but the instruction imparted by the missionary teachers resulted in giving the ex-slaves notions of liberty and racial equality that led to much trouble, finally resulting in the hostility of the whites to negro education. The secession of the blacks from the white churches was aided and encouraged by the bureau. The whole field of labour and contracts was covered by minute regulations, which, good in theory, were absurd in practice, and which failed altogether, but not until labour had been disorganized for several years. The administration of justice by the bureau agents amounted simply to a ceaseless persecution of the whites who had dealings with the blacks, and bloody conflicts sometimes resulted. The law creating the bureau provided for the division of the confiscated property among the negroes, and though carried out only in parts of South Carolina, Florida and Georgia, it caused the negroes to believe that they were to be cared for at the expense of their former masters. This belief made them subject to swindling schemes perpetrated by certain bureau agents and others who promised to secure lands for them. When negro suffrage was imposed by Congress upon the Southern States, the bureau aided the Union League (q.v.) in organizing the blacks into a political party opposed to the whites. A large majority of the bureau officials secured office through their control of the blacks. The failure of the bureau system and its continuance in the midst of reconstruction without harm to the blacks, and the intense hostility of the Southern whites to the institution caused by the irritating conduct of bureau officials, are indications that the institution was not well conceived nor wisely administered.

See P. S. Pierce, *The Freedmen's Bureau* (Iowa City, 1904); *Report of the Joint Committee on Reconstruction* (Washington, 1866); W. L. Fleming (ed.), *Documents relating to Reconstruction* (Cleveland, O., 1906); W. L. Fleming, *Civil War and Reconstruction in Alabama* (New York, 1905); and James W. Garner, *Reconstruction in Mississippi* (New York, 1901). (W. L. F.)

FREEHOLD, a town and the county-seat of Monmouth county, New Jersey, U.S.A., in the township of Freehold, about 25 m. E. by N. of Trenton. Pop. (1890) 2932; (1900) 2934, of whom 215 were foreign-born and 126 were negroes; (1905) 3064; (1910) 3233. Freehold is served by the Pennsylvania and the Central of New Jersey railways. It is the trade centre of one of the most productive agricultural districts of the state and has various manufactures, including carriages, carpets and rugs, files, shirts, underwear, and canned beans and peas. The town is the seat of two boarding schools for boys: the Freehold Military School and the New Jersey Military Academy (chartered, 1900; founded in 1844 as the Freehold Institute). One of the residences in the town dates from 1755. A settlement was made in the township about 1650, and the township was incorporated

in 1693. In 1715 the town was founded and was made the county-seat; it was long commonly known (from the county) as Monmouth Court-House, but afterwards took (from the township) the name Freehold, and in 1869 it was incorporated as the Town of Freehold. An important battle of the War of Independence, known as the battle of Monmouth, was fought near the court-house on the 28th of June 1778. A short distance N.W. of the court-house is a park in which there is a monument, unveiled on the 13th of November 1884 in commemoration of the battle; the base is of Quincy granite and the shaft is of Concord granite. Surmounting the shaft is a statue representing "Liberty Triumphant" (the height to the top of which is about 100 ft.). The monument is adorned with five bronze reliefs, designed and modelled by James E. Kelly (b. 1855); one of these reliefs represents "Molly Pitcher" (d. 1832), a national heroine, who, when her husband (John C. Hays), an artilleryman, was rendered insensible during the battle, served the gun in his place and prevented its capture by the British.¹ Joel Parker (1816-1888), governor of New Jersey in 1863-1866 and 1872-1875, was long a resident of Freehold, and the erection of the monument was largely due to his efforts. A bronze tablet on a boulder in front of the present court-house, commemorating the old court-house, used as a hospital in the battle of Monmouth, was unveiled in 1907. Freehold was the birthplace and home of Dr Thomas Henderson (1743-1824), a Whig or Patriot leader in New Jersey, an officer in the War of Independence, and a member of the Continental Congress in 1779-1780 and of the national House of Representatives in 1795-1797.

The name Freehold was first used of a Presbyterian church established about 1692 by Scottish exiles who came to East Jersey in 1682-1685 and built what was called the "Old Scots' Church" near the present railway station of Wickatunk in Marlboro' township, Monmouth county. In this church, in December 1706, John Boyd (d. 1709) was ordained—the first recorded Presbyterian ordination in America. The church was the first regularly constituted Presbyterian church. No trace of the building now remains in the burying-ground where Boyd was interred, and where the Presbyterian Synod of New Jersey in 1900 raised a granite monument to his memory; his tombstone is preserved by the Presbyterian Historical Society in Philadelphia. John Tennent (1706-1732) became pastor of the Freehold church in 1730, when a new church was built by the Old Scots congregation on White Hill in the present township of Manalapan (then a part of Freehold township), near the railway station and village called Tennent; his brother William (1705-1777), whose trance, in which he thought he saw the glories of heaven, was a matter of much discussion in his time, was pastor in 1733-1777. In 1751-1753 the present "Old Tennent Church," then called the Freehold Church, was erected on (or near) the same site as the building of 1730; in it Whitefield preached and in the older building David Brainerd and his Indian converts met. In 1859 this church (whose corporate name is "The First Presbyterian Church of the County of Monmouth") adopted the name of Tennent, partly to distinguish it from the Presbyterian church organized at Monmouth Court-House (now Freehold) in 1838.

See Frank R. Symmes, *History of the Old Tennent Church* (2nd ed., Cranbury, New Jersey, 1904).

FREEHOLD, in the English law of real property, an estate in land, not being less than an estate for life. An estate for a term of years, no matter how long, was considered inferior in dignity to an estate for life, and unworthy of a freeman (see **ESTATE**). "Some time before the reign of Henry II., but apparently not so early as Domesday, the expression *liberum tenementum* was introduced to designate land held by a freeman by a free tenure. This freehold tenure is the sum of the rights and duties which constitute the relation of a free tenant to his lord."² In this

¹ Her maiden name was Mary Ludwig. "Molly Pitcher" was a nickname given to her by the soldiers in reference to her carrying water to soldiers overcome by heat in the battle of Monmouth. She married Hays in 1769; Hays died soon after the war, and later she married one George McCauley. She lived for more than forty years at Carlisle, Penn., where a monument was erected to her memory in 1876.

² *Digby's History of the Law of Real Property.*

sense freehold is distinguished from copyhold, which is a tenure having its origin in the relation of lord and vassal (see **COPYHOLD**). Freehold is also distinguished from leasehold, which is an estate for a fixed number of years only. By analogy the interest of a person who holds an office for life is sometimes said to be a freehold interest. The term *customary freeholds* is applied to a kind of copyhold tenure in the north of England, viz. tenure by copy of court-roll, but not, as in other cases, expressed to be at the will of the lord.

FREELAND, a borough of Luzerne county, Pennsylvania, U.S.A., about 20 m. S. of Wilkes-Barre, in the E. part of the state. Pop. (1890) 1730; (1900) 5254 (1339 foreign-born, many being Slavs); (1910) 6197. Freeland is served by the Lehigh Valley railway and by electric railway to Upper Lehigh (1 m. distant, served by the Central Railroad of New Jersey) and to other neighbouring places. The borough is built on Broad Mountain, nearly 2000 ft. above sea-level, and the chief industry is the mining of coal at the numerous surrounding collieries. Freeland is the seat of the Mining and Mechanical Institute of the Anthracite Region, chartered in 1894, modelled after the German *Steigerschulen*, with elementary and secondary departments and a night school for workmen. The borough has foundries and machine shops of considerable importance, and manufactures silk, overalls, beer and hames. Freeland was first settled about 1842, was laid out in 1870, and was incorporated in 1876.

FREEMAN, EDWARD AUGUSTUS (1823-1892), English historian, was born at Harborne, Staffordshire, on the 2nd of August 1823. He lost both his parents in infancy, was brought up by a grandmother, and was educated at private schools and by a private tutor. He was a studious and precocious boy, more interested in religious matters, history and foreign politics than in boyish things. He obtained a scholarship at Trinity College, Oxford, and a second class in the degree examination, and was elected fellow of his college (1845). While at Oxford he was much influenced by the High Church movement, and thought seriously of taking orders, but abandoned the idea. He married a daughter of his former tutor, the Rev. R. Gutch, in 1847, and entered on a life of study. Ecclesiastical architecture attracted him strongly. He visited many churches and began a practice, which he pursued throughout his life, of making drawings of buildings on the spot and afterwards tracing them over in ink. His first book, save for his share in a volume of English verse, was a *History of Architecture* (1849). Though he had not then seen any buildings outside England, it contains a good sketch of the development of the art. It is full of youthful enthusiasm and is written in florid language. After some changes of residence he bought a house called Somerleaze, near Wells, Somerset, and settled there in 1860.

Freeman's life was one of strenuous literary work. He wrote many books, and countless articles for reviews, newspapers and other publications, and was a constant contributor to the *Saturday Review* until 1878, when he ceased to write for it for political reasons. His *Saturday Review* articles corrected many errors and raised the level of historical knowledge among the educated classes, but as a reviewer he was apt to forget that a book may have blemishes and yet be praiseworthy. For some years he was an active county magistrate. He was deeply interested in politics, was a follower of Mr Gladstone, and approved the Home Rule Bill of 1886, but objected to the later proposal to retain the Irish members at Westminster. To be returned to Parliament was one of his few ambitions, and in 1868 he unsuccessfully contested Mid-Somerset. Foreign rather than domestic politics had the first place with him. Historical and religious sentiment combined with his distaste of all that was tyrannical to inspire him with hatred of the Turk and sympathy with the smaller and subject nationalities of eastern Europe. He took a prominent part in the agitation which followed "the Bulgarian atrocities"; his speeches were intemperate, and he was accused of uttering the words "Perish India!" at a public meeting in 1876. This, however, was a misrepresentation of his words. He was made a knight commander

of the order of the Saviour by the king of Greece, and also received an order from the prince of Montenegro.

Freeman advanced the study of history in England in two special directions, by insistence on the unity of history, and by teaching the importance and right use of original authorities. History is not, he urges, to be divided "by a middle wall of partition" into ancient and modern, nor broken into fragments as though the history of each nation stood apart. It is more than a collection of narratives; it is a science, "the science of man in his political character." The historical student, then, cannot afford to be indifferent to any part of the record of man's political being; but as his abilities for study are limited, he will, while reckoning all history to be within his range, have his own special range within which he will master every detail (*Rede Lecture*). Freeman's range included Greek, Roman and the earlier part of English history, together with some portions of foreign medieval history, and he had a scholarly though general knowledge of the rest of the history of the European world. He regarded the abiding life of Rome as "the central truth of European history," the bond of its unity, and he undertook his *History of Sicily* (1801-1804) partly because it illustrated this unity. Further, he urges that all historical study is valueless which does not take in a knowledge of original authorities, and he teaches both by example and precept what authorities should be thus described, and how they are to be weighed and used. He did not use manuscript authorities, and for most of his work he had no need to do so. The authorities which he needed were already in print, and his books would not have been better if he had disinterred a few more facts from unprinted sources.

His reputation as a historian will chiefly rest on his *History of the Norman Conquest* (1867-1876), his longest completed book. In common with his works generally, it is distinguished by exhaustiveness of treatment and research, critical ability, a remarkable degree of accuracy, and a certain insight into the past which he gained from his practical experience of men and institutions. He is almost exclusively a political historian. His saying that "history is past politics and politics are present history" is significant of this limitation of his work, which left on one side subjects of the deepest interest in a nation's life. In dealing with constitutional matters he sometimes attaches too much weight to words and formal aspects. This gives certain of his arguments an air of pedantry, and seems to lead him to find evidences of continuity in institutions which in reality and spirit were different from what they once had been. As a rule his estimates of character are remarkably able. It is true that he is sometimes swayed by prejudice, but this is the common lot of great historians; they cannot altogether avoid sharing in the feelings of the past, for they live in it, and Freeman did so to an extraordinary degree. Yet if he judges too favourably the leaders of the national party in England on the eve of the Norman Conquest, that is a small matter to set against the insight which he exhibits in writing of Aratus, Sulla, Nicias, William the Conqueror, Thomas of Canterbury, Frederick the Second and many more. In width of view, thoroughness of investigation and honesty of purpose he is unsurpassed by any historian. He never conceals nor wilfully misrepresents anything, and he reckoned no labour too great which might help him to draw a truthful picture of the past. When a place had any important connexion with his work he invariably visited it. He travelled much, always to gain knowledge, and generally to complete his historical equipment. His collected articles and essays on places of historical interest are perhaps the most pleasing of his writings, but they deal exclusively with historical associations and architectural features. The quantity of work which he turned out is enormous, for the fifteen large volumes which contain his *Norman Conquest*, his unfinished *History of Sicily*, his *William Rufus* (1882), and his *Essays* (1872-1879), and the crowd of his smaller books, are matched in amount by his uncollected contributions to periodicals. In respect of matter his historical work is uniformly excellent. In respect of form and style the case is different. Though his sentences themselves are not wordy, he is extremely diffuse in treatment, habitually repeating an idea

in successive sentences of much the same import. While this habit was doubtless aggravated by the amount of his journalistic work, it seems originally to have sprung from what may be called a professorial spirit, which occasionally appears in the tone of his remarks. He was anxious to make sure that his readers would understand his exact meaning, and to guard them against all possible misconceptions. His lengthy explanations are the more grievous because he insists on the same points in several of his books. His prolixity was increased by his unwillingness, when writing without prescribed limits, to leave out any detail, however unimportant. His passion for details not only swelled his volumes to a portentous size, but was fatal to artistic construction. The length of his books has hindered their usefulness. They were written for the public at large, but few save professed students, who can admire and value his exhaustiveness, will read the many hundreds of pages which he devotes to a short period of history. In some of his smaller books, however, he shows great powers of condensation and arrangement, and writes tersely enough. His style is correct, lucid and virile, but generally nothing more, and his endeavour to use as far as possible only words of Teutonic origin limited his vocabulary and makes his sentences somewhat monotonous. While Froude often strayed away from his authorities, Freeman kept his authorities always before his eyes, and his narrative is here and there little more than a translation of their words. Accordingly, while it has nothing of Froude's carelessness and inaccuracy, it has nothing of his charm of style. Yet now and again he rises to the level of some heroic event, and parts of his chapter on the "Campaign of Hastings" and of his record of the wars of Syracuse and Athens, his reflections on the visit of Basil the Second to the church of the Virgin on the Acropolis, and some other passages in his books, are fine pieces of eloquent writing.

The high quality of Freeman's work was acknowledged by all competent judges. He was made D.C.L. of Oxford and LL.D. of Cambridge *honoris causa*, and when he visited the United States on a lecturing tour was warmly received at various places of learning. He served on the royal commission on ecclesiastical courts appointed in 1881. In 1884 he was appointed regius professor of modern history at Oxford. His lectures were thinly attended, for he did not care to adapt them to the requirements of the university examinations, and he was not perhaps well fitted to teach young men. But he exercised a wholesome influence over the more earnest students of history among the resident graduates. From 1886 he was forced by ill-health to spend much of his time abroad, and he died of smallpox at Alicante on the 16th of March 1892, while on a tour in Spain. Freeman had a strongly marked personality. Though impatient in temper and occasionally rude, he was tender-hearted and generous. His rudeness to strangers was partly caused by shyness and partly by a childlike inability to conceal his feelings. Eminently truthful, he could not understand that some verbal insincerities are necessary to social life. He had a peculiar faculty for friendship, and his friends always found him sympathetic and affectionate. In their society he would talk well and showed a keen sense of humour. He considered it his duty to expose careless and ignorant writers, and certainly enjoyed doing so. He worked hard and methodically, often had several pieces of work in hand, and kept a daily record of the time which he devoted to each of them. His tastes were curiously limited. No art interested him except architecture, which he studied throughout his life; and he cared little for literature which was not either historical or political. In later life he ceased to hold the theological opinions of his youth, but remained a devout churchman.

See W. R. W. Stephens, *Life and Letters of E. A. Freeman* (London, 1895); Frederic Harrison, *Tennyson, Ruskin, Mill and other Literary Estimates* (London, 1899); James Bryce, "E. A. Freeman," *Eng. Hist. Rev.*, July 1892. (W. Hu.)

FREEMAN, primarily one who is free, as opposed to a slave or serf (see FEUDALISM; SLAVERY). The term is more specifically applied to one who possesses the freedom of a city, borough or company. Before the passing of the Municipal Corporations

Act 1835, each English borough admitted freemen according to its own peculiar custom and by-laws. The rights and privileges of a freeman, though varying in different boroughs, generally included the right to vote at a parliamentary election of the borough, and exemption from all tolls and dues. The act of 1835 respected existing usages, and every person who was then an admitted freeman remained one, retaining at the same time all his former rights and privileges. The admission of freemen is now regulated by the Municipal Corporations Act 1882. By section 201 of that act the term "freeman" includes any person of the class whose rights and interests were reserved by the act of 1835 under the name either of freemen or of burgesses. By section 202 no person can be admitted a freeman by gift or by purchase; that is, only birth, servitude or marriage are qualifications. The Honorary Freedom of Boroughs Act 1885, however, makes an exception, as by that act the council of every borough may from time to time admit persons of distinction to be honorary freemen of the borough. The town clerk of every borough keeps a list, which is called "the freeman's roll," and when any person claims to be admitted a freeman in respect of birth, servitude or marriage, the mayor examines the claim, and if it is established the claimant's name is enrolled by the town clerk.

A person may become a freeman or freewoman of one of the London livery companies by (1) apprenticeship or servitude; (2) patrimony; (3) redemption; (4) gift. This last is purely honorary. The most usual form of acquiring freedom was by serving apprenticeship to a freeman, free both of a company and of the city of London. By an act of common council of 1836 apprenticeship was permitted to freemen of the city who had not taken up the freedom of a company. By an act of common council of 1889 the term of service was reduced from seven years to four years. Freedom by patrimony is always granted to children of a person who has been duly admitted to the freedom. Freedom by redemption or purchase requires the payment of certain entrance fees, which vary with the standing of the company. In the Grocers' Company freedom by redemption does not exist, and in such companies as still have a trade, e.g. the Apothecaries and Stationers, it is limited to members of the trade. See W. C. Hazlitt, *The Livery Companies of the City of London* (1892).

FREEMASONRY. According to an old "Charge" delivered to initiates, Freemasonry is declared to be an "ancient and honourable institution: ancient no doubt it is, as having subsisted from time immemorial; and honourable it must be acknowledged to be, as by a natural tendency it conduces to make those so who are obedient to its precepts . . . to so high an eminence has its credit been advanced that in every age Monarchs themselves have been promoters of the art, have not thought it derogatory from their dignity to exchange the sceptre for the trowel, have patronised our mysteries and joined in our Assemblies." For many years the craft has been conducted without respect to clime, colour, caste or creed.

History.—The precise origin of the society has yet to be ascertained, but is not likely to be, as the early records are lost; there is, however, ample evidence remaining to justify the claim for its antiquity and its honourable character. Much has been written as to its eventful past, based upon actual records, but still more which has served only to amuse or repel inquirers, and led not a few to believe that the fraternity has no trustworthy history. An unfavourable opinion of the historians of the craft generally may fairly have been held during the 18th and early in the 19th centuries, but happily since the middle of the latter century quite a different principle has animated those brethren who have sought to make the facts of masonic history known to the brotherhood, as well as worth the study of students in general. The idea that it would require an investigator to be a member of the "mystic tie" in order to qualify as a reader of masonic history has been exploded. The evidences collected concerning the institution during the last five hundred years, or more, may now be examined and tested in the most severe manner by literary and critical experts (whether opposed or

favourable to the body), who cannot fail to accept the claims made as to its great antiquity and continuity, as the lineal descendant of those craftsmen who raised the cathedrals and other great English buildings during the middle ages.

It is only needful to refer to the old works on freemasonry, and to compare them with the accepted histories of the present time, to be assured that such strictures as above are more than justified. The premier work on the subject was published in London in 1723, the Rev. James Anderson being the author of the historical portion, introductory to the first "Book of Constitutions" of the original Grand Lodge of England. Dr Anderson gravely states that "Grand Master Moses often marshalled the Israelites into a regular and general lodge, whilst in the wilderness. . . . King Solomon was Grand Master of the lodge at Jerusalem. . . . Nebuchadnezzar became the Grand Master Mason," &c., devoting many more pages to similar absurdities, but dismissing the important modern innovation (1716-1717) of a Grand Lodge with a few lines noteworthy for their brief and indefinite character.

In 1738 a second edition was issued, dedicated to the prince of Wales ("a Master Mason and master of a lodge"), and was the work of the same brother (as respects the historical part), the additions being mainly on the same lines as the former volume, only, if possible, still more ridiculous and extravagant; e.g. Cyrus constituted Jerubbabel "provincial grand master in Judah"; Charles Martel was "the Right Worshipful Grand Master of France, and Edward I. being deeply engaged in wars left the craft to the care of several successive grand masters" (duly enumerated). Such loose statements may now pass unheeded, but unfortunately they do not exhaust the objections to Dr Anderson's method of writing history. The excerpt concerning St Alban (apparently made from Cole's *Ancient Constitutions*, 1728-1729) has the unwarranted additional title of Grand Master conferred on that saint, and the extract concerning King Æthelstan and Prince Edwin from the "Old MS. Charges" (given in the first edition) contains still more unauthorized modern terms, with the year added of 926; thus misleading most seriously those who accept the volumes as trustworthy, because written by the accredited historian of the Grand Lodge, Junior Grand Warden in 1723. These examples hardly increase our confidence in the author's accuracy when Dr Anderson comes to treat of the origin of the premier Grand Lodge; but he is our only informant as to that important event, and if his version of the occurrence is declined, we are absolutely without any information.

In considering the early history of Freemasonry, from a purely matter-of-fact standpoint, it will be well to settle as a necessary preliminary what the term did and does now include or mean, and how far back the inquiry should be conducted, as well as on what lines. If the view of the subject herein taken be correct, it will be useless to load the investigation by devoting considerable space to a consideration of the laws and customs of still older societies which may have been utilized and imitated by the fraternity, but which in no sense can be accepted as the actual forbears of the present society of Free and Accepted Masons. They were predecessors, or possibly prototypes, but not near relatives or progenitors of the Freemasons.²

The Mother Grand Lodge of the world is that of England, which was inaugurated in the metropolis on St John Baptist's day 1717 by four or more old lodges, three of which still flourish. There were other lodges also in London and the country at the time, but whether they were invited to the meeting is not now known. Probably not, as existing records of the period preserve a sphinx-like silence thereon. Likewise there were many scores of lodges at work in Scotland, and undoubtedly in Ireland the craft was widely patronized. Whatever the ceremonies may have been which were then known as Freemasonry in Great Britain and Ireland, they were practically alike, and the venerable *Old Charges* or MS. constitutions, dating back several centuries, were rightly held by them as the title-deeds of their masonic inheritance.

It was a bold thing to do, thus to start a governing body for the fraternity quite different in many respects to all preceding organizations, and to brand as irregular all lodges which declined

¹ If history be no ancient Fable

Free Masons came from Tower of Babel.

("The Freemasons; an Hudibrastic poem," London, 1733.)

² *The Early History and Antiquities of Freemasonry and Medieval Builders*, by Mr G. F. Fort (U.S.A.), and the *Cathedral Builders: The Magistri Comacini*, by "Leader Scott" (the late Mrs Baxter), take rather a different view on this point and ably present their arguments. The Rev. C. Kingsley in *Roman and Teuton* writes of the *Comacini*, "Perhaps the original germ of the great society of Freemasons."

to accept such authority; but the very originality and audacity of its promoters appears to have led to its success, and it was not long before most of the lodges of the pre-Grand-Lodge era joined and accepted "constitution" by warrant of the Grand Master. Not only so, but Ireland quickly followed the lead, so early as 1725 there being a Grand Lodge for that country which must have been formed even still earlier, and probably by lodges started before any were authorized in the English counties. In Scotland the change was not made until 1736, many lodges even then holding aloof from such an organization. Indeed, out of some hundred lodges known to have been active then, only thirty-three responded and agreed to fall into line, though several joined later; some, however, kept separate down to the end of the 19th century, while others never united. Many of these lodges have records of the 17th century though not then newly formed; one in particular, the oldest (the Lodge of Edinburgh, No. 1), possesses minutes so far back as the year 1599.

It is important to bear in mind that all the regular lodges throughout the world, and likewise all the Grand Lodges, directly or indirectly, have sprung from one or other of the three governing bodies named; Ireland and Scotland following the example set by their masonic mother of England in having Grand Lodges of their own. It is not proved how the latter two became acquainted with Freemasonry as a secret society, guided more or less by the operative MS. *Constitutions or Charges* common to the three bodies, not met with elsewhere; but the credit of a Grand Lodge being established to control the lodges belongs to England.

It may be a startling declaration, but it is well authenticated, that there is no other Freemasonry, as the term is now understood, than what which has been so derived. In other words, the lodges and Grand Lodges in both hemispheres trace their origin and authority back to England for working what are known as the Three Degrees, controlled by regular Grand Lodges. That being so, a history of modern Freemasonry, the direct offspring of the British parents aforesaid, should first of all establish the descent of the three Grand Lodges from the Freemasonry of earlier days; such continuity, of five centuries or more, being a *sine qua non* of antiquity and regularity.

It will be found that from the early part of the 18th century back to the 16th century existing records testify to the assemblies of lodges, mainly operative, but partly speculative, in Great Britain, whose guiding stars and common heritage were the *Old Charges*, and that when their actual minutes and transactions cease to be traced by reason of their loss, these same MS. *Constitutions* furnish testimony of the still older working of such combinations of freemasons or masons, without the assistance, countenance or authority of any other masonic body; consequently such documents still preserved, of the 14th and later centuries (numbering about seventy, mostly in form of rolls), with the existing lodge minutes referred to of the 16th century, down to the establishment of the premier Grand Lodge in 1717, prove the continuity of the society. Indeed so universally has this claim been admitted, that in popular usage the term *Freemason* is only now applied to those who belong to this particular fraternity, that of *mason* being applicable to one who follows that trade, or honourable calling, as a builder.

There is no evidence that during this long period any other organization of any kind, religious, philosophical, mystical or otherwise, materially or even slightly influenced the customs of the fraternity, though they may have done so; but so far as is known the lodges were of much the same character throughout, and consisted really of operatives (who enjoyed practically a monopoly for some time of the trade as masons or freemasons), and, in part, of "speculatives," i.e. noblemen, gentlemen and men of other trades, who were admitted as honorary members.

Assuming then that the freemasons of the present day are the sole inheritors of the system arranged at the so-called "Revival of 1717," which was a development from an operative body to one partly speculative, and that, so far back as the MS. Records extend and furnish any light, they must have worked in Lodges in secret throughout the period noted, a history of Freemasonry

should be mainly devoted to giving particulars, as far as possible, of the lodges, their traditions, customs and laws, based upon actual documents which can be tested and verified by members and non-members alike.

It has been the rule to treat, more or less fully, of the influence exerted on the fraternity by the Ancient Mysteries, the *Esenes*, Roman Colleges, *Culdees*, Hermeticism, *Fehm-Gerichte et hoc genus omne*, especially the *Steinmetzen*, the Craft Guilds and the Companions of France, &c.; but in view of the separate and independent character of the freemasons, it appears to be quite unnecessary, and the time so employed would be better devoted to a more thorough search after additional evidences of the activity of the craft, especially during the crucial period overlapping the second decade of the 18th century, so as to discover information as to the transmitted secrets of the mediæval masons, which, after all, may simply have been what Gaspard Monge felicitously entitles "Descriptive Geometry, or the Art and Science of Masonic Symbolism."

The rules and regulations of the masons were embodied in what are known as the *Old Charges*; the senior known copy being the *Regius MS.* (British Museum Bibl. Reg. 17 A, 1), which, however, is not so exclusively devoted to masonry as the later copies. David Casley, in his catalogue of the MSS. in the King's Library (1734), unfortunately styled the little gem *A Poem of Moral Duties*; and owing to this misdescription its true character was not recognized until the year 1830, and then by a non-mason (Mr Halliwell-Phillips), who had it reproduced in 1840 and brought out an improved edition in 1844. Its date has been approximately fixed at 1390 by Casley and other authorities.

The curious legend of the craft, therein made known, deals first of all with the number of unemployed in early days and the necessity of finding work, "that they myght gete here lyvynge therby." Euclid was consulted, and recommended the "onest craft of good masonry," and the genesis of the society is found "yn Egypte lande." By a rapid transition, but "mony erys afterwarde," we are told that the "Craft com ynto England yn tyme of good kynge Adelstonus (Æthelstan) day," who called an assembly of the masons, when fifteen articles and as many more points were agreed to for the government of the craft, each being duly described. Each brother was instructed that—

"He must love wel God, and holy Church algate
And hys mayster also, that he ys wythe."

"The thrydde poynt must be severle
With the prentes knowe hyt wele,
Hys mayster counsel he kepe and close,
And hys felows by hys goode purpose;
The prevetyse of the chamber telle he no mon,
Ny yn the logge whatsoever they done,
Whatsoever thou heryst, or syste hem do,
Telle hyt no mon, wheresoever thou go."

The rules generally, besides referring to trade regulations, are as a whole suggestive of the Ten Commandments in an extended form, winding up with the legend of the *Ars quatuor coronatorum*, as an incentive to a faithful discharge of the numerous obligations. A second part introduces a more lengthy account of the origin of masonry, in which Noah's flood and the Tower of Babylon are mentioned as well as the great skill of Euclid, who—

"Through hys grace of Crist yn heven,
He commensed yn the syens seven";

The "seven sciences" are duly named and explained. The compiler apparently was a priest, line 629 reading "And, when ye gospel me rede schal," thus also accounting for the many religious injunctions in the MS.; the last hundred lines are evidently based upon *Urbanitatis* (Cott. MS. Caligula A 11, fol. 88) and *Instructions for a Parish Priest* (Cott. MS. Claudius A 12, fol. 27), instructions such as lads and even men would need who were ignorant of the customs of polite society, correct deportment at church and in the presence of their social superiors.

The recital of the legend of the *Quatuor Coronati* has been held by Herr Findel in his *History of Freemasonry* (*Allgemeine Geschichte der Freimaurerei*, 1862; English editions, 1866-1869) to prove that British Freemasonry was derived from Germany,

but without any justification, the legend being met with in England centuries prior to the date of the *Regius MS.*, and long prior to its incorporation in masonic legends on the Continent.

The next MS., in order, is known as the "Cooke" (Ad. MS. 23,108, British Museum), because Matthew Cooke published a fair reproduction of the document in 1861; and it is deemed by competent paleographers to date from the first part of the 13th century. There are two versions of the *Old Charges* in this little book, purchased for the British Museum in 1859. The compiler was probably a mason and familiar with several copies of these MS. *Constitutions*, two of which he utilizes and comments upon; he quotes from a MS. copy of the *Policronicon* in the manner in which a written account of the sciences was preserved in the two historic stones at the time of the Flood, and generally makes known the traditions of the society as well as the laws which were to govern the members.

Its introduction into England through Egypt is noted (where the Children of Israel "lernyd ye craft of Masonry"), also the "lande of behest" (Jerusalem) and the Temple of Solomon (who "confirmed ye chargys yt David his Fadir" had made). Then masonry in France is interestingly described; and St Alban and "Æthelstane with his youngest sone" (the Edwin of the later MSS.) became the chosen mediums subsequently, as with the other *Charges*, portions of the Old Testament are often cited in order to convey a correct idea to the neophyte, who is to hear the document read, as to these sciences which are declared to be free in themselves (*fre in hem seffe*). Of all crafts followed by man in this world "Masonry hath the moste notabilitie," as confirmed by "Elders that were bi for us of masons [who] had these chargys wryten," and "as is write and taught in ye boke of our charges."

Until quite recently no representative or survival of this particular version had been traced, but in 1890 one was discovered of 1687 (since known as the *William Watson MS.*). Of some seventy copies of these old scrolls which have been unearthed, by far the greater proportion have been made public since 1860. They have all much in common, though often curious differences are to be detected; are of English origin, no matter where used; and when complete, as they mostly are, whether of the 16th or subsequent centuries, are noteworthy for an invocation or prayer which begins the recital:—

"The mighte of the ffather of heaven
And the wysdome of the glorious Sonne
through the grace and the goodnes of the holly
ghoste yt been three p'sons and one God
be with us at or beginning and give us grace
so to gou'ne us here in or lyving that wee maye
come to his blisse that nevr shall have ending.—Amen."
(*Grand Lodge MS. No. 1, A.D. 1583.*)

They are chiefly of the 17th century and nearly all located in England; particulars may be found in Hughan's *Old Charges of the British Freemasons* (1872, 1895 and supplement 1906).¹ The chief scrolls, with some others, have been reproduced in facsimile in six volumes of the *Qualwor Coronatorum Antigrapha*; and the collection in Yorkshire has been published separately, either in the *West Yorkshire Reprints* or the *Ancient York Masonic Rolls*. Several have been transcribed and issued in other works.

These scrolls give considerable information as to the traditions and customs of the craft, together with the regulations for its government, and were required to be read to apprentices long after the peculiar rules ceased to be acted upon, each lodge apparently having one or more copies kept for the purpose. The old Lodge of Aberdeen ordered in 1670 that the Charge was to be "read at ye entering of everie entered prentise"; another at Alnwick in 1701 provided:—

"Noe Mason shall take any apprentice [but he must]
Enter him and give him his Charge, within one whole
year after":

¹ The service rendered by Dr W. Begemann (Germany) in his "Attempt to Classify the Old Charges of the British Masons" (vol. 1 *Trans. of the Qualwor Coronati Lodge*, London) has been very great, and the researches of the Rev. A. F. A. Woodford and G. W. Speth have also been of the utmost consequence.

and still another at Swallowwell (now No. 48 Gateshead) demanded that "the Apprentices shall have their Charge given at the time of Registering, or within thirty days after"; the minutes inserting such entries accordingly even so late as 1754, nearly twenty years after the lodge had cast in its lot with the Grand Lodge of England.

Their Christian character is further emphasized by the "First Charge that you shall be true men to God and the holy Church"; the *York MS. No. 6* beseeches the brethren "at every meeting and assembly they pray heartily for all Christians"; the *Melross MS. No. 2* (1674) mentions "Merchants and all other Christian men," and the *Aberdeen MS.* (1670) terms the invocation "A Prayer before the Meeting." Until the Grand Lodge era, Freemasonry was thus wholly Christian. The *York MS. No. 4* of 1693 contains a singular error in the admonitory lines:—

"The [n] one of the elders taking the Booke and that hee or shee that is to be made mason, shall lay their hands thereon and the charge shall be given."

This particular reading was cited by Hughan in 1871, but was considered doubtful; Findel,² however, confirmed it, on his visit to York under the guidance of the celebrated masonic student the late Rev. A. F. A. Woodford. The mistake was due possibly to the transcriber, who had an older roll before him, confusing "they," sometimes written "the," with "she," or reading that portion, which is often in Latin, as *ille vel illa*, instead of *ille vel illi*.

In some of the *Codices*, about the middle of the 17th century and later, New Articles are inserted, such as would be suitable for an organization similar to the Masons' Company of London, which had one, at least, of the *Old Charges* in its possession according to inventories of 1665 and 1676; and likewise in 1722, termed *The Book of the Constitutions of the Accepted Masons*. Save its mention ("Book wrote on parchment") by Sir Francis Palgrave in the *Edinburgh Review* (April 1839) as being in existence "not long since," this valuable document has been lost sight of for many years.

That there were signs and other secrets preserved and used by the brethren throughout this mainly operative period may be gathered from discreet references in these old MSS. The *Institutions in parchment* (22nd of November 1696) of the Dumfries Kilwinning Lodge (No. 53, Scotland) contains a copy of the oath taken "when any man should be made":—

"These Charges which we now rehearse to you and all others ye secrets and misterys belonging to free masons you shall faithfully and truly keep, together with ye Counsell of ye assembly or lodge, or any other lodge, or brother, or fellow."
"Then after ye oath taken and the book kissed" (*i.e.* the Bible) the "precepts" are read, the first being:—

"You shall be true men to God and his holy Church, and that you do not countenance or maintaine any error, faction, schism or heresie, in ye church to ye best of your understanding." (*History of No. 53*, by James Smith.)

The *Grand Lodge MS. No. 2* provides that "You shall keep secret ye obscure and intricate pts. of ye science, not disclosing them to any but such as study and use ye same."

The *Harleian MS. No. 2054* (Brit. Mus.) is still more explicit, termed *The free Masons Orders and Constitutions*, and is in the handwriting of Randle Holme (author of the *Academie of Armory*, 1688), who was a member of a lodge in Cheshire. Following the MS. *Constitutions*, in the same handwriting, about 1650, is a scrap of paper with the obligation:—

"There is severall words and signes of a free Mason to be revealed to yu wch as yu will answr. before God at the Great and terrible day of Judgmt. yu keep secret and not to reveale the same to any in the heeres of any p'son; but to the Mrs and fellows of the Society of Free Masons, so helpe me God, &c." (W. H. Rylands, *Mag. Mag.*, 1882.)

² Findel claims that his *Treatise* on the society was the cause which "first impelled England to the study of masonic history and ushered in the intellectual movement which resulted in the writings of Bros. Hughan, Lyon, Gould and others." Great credit was due to the late German author for his important work, but before its advent the Rev. A. F. A. Woodford, D. Murray Lyon and others in Great Britain were diligent masonic students on similar lines.

It is not yet settled who were the actual designers or architects the grand old English cathedrals. Credit has been claimed : church dignitaries, to the exclusion more or less of the master sons, to whom presumably of right the distinction belonged. early days the title "architect" is not met with, unless the m "Ingenator" had that meaning, which is doubtful. As to is interesting question, and as to the subject of building nerally, an historical account of Master and Free Masons *Discourses upon Architecture in England*, by the Rev. James ulaway, 1833), and *Notes on the Superintendents of English ildings in the Middle Ages* (by Wyatt Papworth, 1887), should onsulted. Both writers were non-masons. The former serves: "The honour due to the original founders of these ifices is almost invariably transferred to the ecclesiastics der whose patronage they rose, rather than to the skill and sign of the master mason, or professional architect, because the ly historians were monks. . . . They were probably not so ll versed in geometrical science as the master masons, for thematics formed a part of monastic learning in a very limited ree." In the *Journal of Proceedings R.I.B.A.* vol. iv. (1887), iful critic (W.H. White) declares that Papworth, in that valu- le collection of facts, has contrived to annihilate all the profes- al idols of the century, setting up in their place nothing ept the master mason. The brotherhood of Bridge-builders,¹ t travelled far and wide to build bridges, and the travelling dies of Freemasons,² he believes never existed; nor was illiam of Wykeham the designer of the colleges attributed to n. It seems well-nigh impossible to disprove the statements ide by Papworth, because they are all so well grounded on ested facts; and the attempt to connect the Abbey of Cluny, men trained at Cluny, with the original or preliminary designs the great buildings erected during the middle ages, at least ring the 12th and 13th centuries, is also a failure. The whole stion is ably and fully treated in the *History of Freemasonry* Robert Freke Gould (1886-1887), particularly in chapter vi. "Medieval Operative Masonry," and in his *Concise History* 03).

The lodge is often met with, either as the *tabulatum domicialem* oo, at St Alban's Abbey) or actually so named in the *Fabric* *Us of York Minster* (1370), *ye loge* being situated close to the e in course of erection; it was used as a place in which the nes were prepared in private for the structure, as well as upied at meal-time, &c. Each mason was required to "swere n ye boke yt he sall trewly ande byslyl at his power hold and e hoely all ye poyntes of yis forsayde ordinance" (*Ordinacio mentanorum*).

As to the term *free-mason*, from the 14th century, it is held some authorities that it described simply those men who rked "freestone," but there is abundant evidence to prove t, whatever may have been intended at first, *free-mason* soon la much wider signification, the prefix *free* being also employed carpenters (1666), sewers (15th century, tailors at Exeter) and ers, presumably to indicate they were free to follow their des in certain localities. On this point Mr Gould well observes: The class of persons from whom the Freemasons of Warrington 146), Staffordshire (1686), Chester, York, London and their igenous in the 17th century derived the descriptive title, ich became the inheritance of the Grand Lodge of England, *re free men*, and masons of Guilds or Companies" (*History*, l. ii. p. 160). Dr Brentano may also be cited: "Wherever e Craft Guilds were legally acknowledged, we find foremost, at the right to exercise their craft, and sell their manufactures, pended upon the freedom of their city" (*Development of ilds*, &c., p. 65). In like manner, the privilege of working a mason was not conferred before candidates had been "made e." The regular free-masons would not work with men, even they had a knowledge of their trade, "if *unfree*," but styled ¹ It is not considered necessary to refer at length to the *Fratres* *milis*, or other imaginary bodies of freemasons, as such questions y well be left to the curious and interested student.

² "No distinct trace of the general employment of large migratory nds of masons, going from place to place as a guild, or company, brotherhood" (Prof. T. Hayter-Lewis, *Brit. Arch. Assoc.*, 1889).

them "Cowans," a course justified by the king's "Maister of Work," William Schaw, whose *Statutis and Ordinacis* (28th December 1598) required that "Na maister or fellow of craft ressaue any *cowanis* to wirlk in his societe or compayne, nor send name of his servants to wirlk wt. *cowanis*, under the pane of twentie pounds." Gradually, however, the rule was relaxed, in time such monopoly practically ceased, and the word "cowan" is only known in connexion with speculative Freemasonry. Sir Walter Scott, as a member of Lodge St David (No. 36), was familiar with the word and used it in *Rob Roy*. In 1707 a cowan was described in the minutes of Mother Lodge Kilwinning, as a mason "without the word," thus one who was not a *free mason* (*History of the Lodge of Edinburgh No. 1*, by D. Murray Lyon, 1900).

In the *New English Dictionary* (Oxford, vol. iv., 1897) under "Freemason" it is noted that three views have been propounded:—(1) "The suggestion that *free-mason* stands for *free-stone-mason* would appear unworthy of attention, but for the curious fact that the earliest known instances of any similar appellation are *maistre mason de franche peer* (Act 25 Edw. III., 1350), and *sculptores lapidum liberorum*, alleged to occur in a document of 1217; the coincidence, however, seems to be merely accidental. (2) The view most generally held is that freemasons were those who were free of the masons' guild. Against this explanation many forcible objections have been brought by Mr G. W. Speth, who suggests (3) that the itinerant masons were called *free* because they claimed exemption from the control of the local guilds of the towns in which they temporarily settled. (4) Perhaps the best hypothesis is that the term refers to the medieval practice of emancipating skilled artisans, in order that they might be able to travel and render their services wherever any great building was in process of construction." The late secretary of the Quatuor Coronati Lodge (No. 2076, London) has thus had his view sanctioned by "the highest tribunal in the Republic of Letters so far as Philology is concerned" (Dr W. J. Chetwode Crawley in *Ars Quatuor Coronatorum*, 1898). Still it cannot be denied that members of lodges in the 16th and following centuries exercised the privilege of making *free* masons and denied the freedom of working to cowans (also called *un-free* men) who had not been so made free; "the *Masownys* of the luge" being the only ones recognized as *freemasons*. As to the prefix being derived from the word *frere*, a sufficient answer is the fact that frequent reference is made to "Brother freemasons," so that no ground for that supposition exists (cf. articles by Mr Gould in the *Freemason* for September 1898 on "Free and Freemasonry").

There are numerous indications of masonic activity in the British lodges of the 17th century, especially in Scotland; the existing records, however, of the southern part of the United Kingdom, though few, are of importance, some only having been made known in recent years. These concern the Masons' Company of London, whose valuable minutes and other documents are ably described and commented upon by Edward Conder, jr., in his *Hale Crafts and Fellowship of Masons* (1894), the author then being the Master of that ancient company. It was incorporated in 1677 by Charles II., who graciously met the wishes of the members, but as a company the information "that is to be found in the Corporation Records at Guildhall proves very clearly that in 1376 the Masons' Company existed and was represented in the court of common council." The title then favoured was "Masons," the entry of the term "Freemasons" being crossed out. Herbert erroneously overlooked the correction, and stated in his *History of the Twelve Great Livery Companies* (vol. i.) that the Freemasons returned two, and the Masons four members, but subsequently amalgamated; whereas the revised entry was for the "Masons" only. The Company obtained a grant of arms in 1472 (12th year Hen. VIII.), one of the first of the kind, being thus described:—"A feld of Sablys A Cheveron silver grailed thre Castellis of the same garnysshed wt. dores and wyndows of the feld in the Cheveron or Cuppas of Black of Blak"; it is the authority (if any) for all later armorial bearings having a chevron and castles, assumed by other masonic

organizations. This precious document was only discovered in 1871, having been missing for a long time, thus doubtless accounting for the erroneous representations met with, not having the correct blazon to follow. The oldest masonic motto known is "God is our Guide" on Kerwin's tomb in St Helen's church, Bishopgate, of 1504; that of "In the Lord is all our trust" not being traced until the next century. Supporters consisting of two doric columns are mentioned in 1688 by Randle Holme, but the Grand Lodge of England in the following century used Beavers as operative builders. Its first motto was "In the beginning was the Word" (in Greek), exchanged a few years onward for "Relief and Truth," the rival Grand Lodge (Atholl Masons) selecting "Holiness to the Lord" (in Hebrew), and the final selection at the "Union of December 1813" being *Audi Vide Tace*.

Mr Conder's discovery of a lodge of "Accepted Masons" being held under the wing of the Company was a great surprise, dating as the records do from 1620 to 1621 (the earliest of the kind yet traced in England), when seven were made masons, all of whom were free of the Company *before*, three being of the Livery; the entry commencing "Att the making masons." The meetings were entitled the "Acception," and the members of the lodge were called *Accepted Masons*, being those so *accepted* and initiated, the term never otherwise being met with in the Records. An additional fee had to be paid by a member of the Company to join the "Acception," and any not belonging thereto were mulct in twice the sum; though even then such "acceptance" did not qualify for membership of the superior body; the fees for the "Acception" being £1 and £2 respectively. In 1638-1639, when Nicholas Stone entered the lodge (he was Master of the Company 1632-1633) the banquet cost a considerable sum, showing that the number of brethren present must have been large.

Elias Ashmole (who according to his diary was "made a Free Mason of Warrington with Colonel Henry Mainwaring," seven brethren being named as in attendance at the lodge, 16th of October 1646) states that he "received a summons to appear at a Lodge to be held next day at Masons' Hall, London." Accordingly on the 11th of March 1682 he attended and saw six gentlemen "admitted into the Fellowship of Free Masons," of whom three only belonged to the Company; the Master, however, Mr Thomas Wise, the two wardens and six others being present on the occasion as members in their *dual* capacity. Ashmole adds: "We all dined at the Halfe Moone Tavern in Cheapside at a noble dinner prepared at the charge of the new-accepted Masons."

It is almost certain that there was not an operative mason present at the Lodge held in 1646, and at the one which met in 1682 there was a strong representation of the speculative branch. Before the year 1654 the Company was known as that of the Freemasons for some time, but after then the old title of Masons was reverted to, the terms "Acception" and "Accepted" belonging to the speculative Lodge, which, however, in all probability either became independent or ceased to work soon after 1682. It is very interesting to note that subsequently (but never before) the longer designation is met with of "Free and Accepted Masons," and is thus a combination of operative and speculative usage.

Mr Conder is of opinion that in the Records "there is no evidence of any particular ceremony attending the position of Master Mason, possibly it consisted of administering a different oath from the one taken by the apprentices on being entered." There is much to favour this supposition, and it may provide the key to the *rezata quaestio* as to the plurality of degrees prior to the Grand Lodge era. The fellow-crafts were recruited from those apprentices who had served their time and had their essay (or sufficient trial of their skill) duly passed; they and the Masters, by the *Schaw Statutes* of 1598, being only admitted in the presence of "sex Maisteris and *two enteril prentissis*." As a rule a master mason meant one who was master of his trade, *i.e.* duly qualified; but it sometimes described employers as distinct from journeymen Freemasons; being also a compliment con-

ferred on honorary members during the 17th century in particular.

In Dr Plot's *History of Staffordshire* (1686) is a remarkable account of the "Society of Freemasons," which, being by an unfriendly critic, is all the more valuable. He states that the custom had spread "more or less all over the nation"; persons of the most eminent quality did not disdain to enter the Fellowship; they had "a large parchment *volum* containing the History and Rules of the Craft of Masonry"; St Amphibal, St Alban, King Athelstan and Edwin are mentioned, and these "charges and manners" were "after perusal approved by King Hen. 6 and his council, both as to Masters and Fellows of this right Worshipfull craft." It is but fair to add that notwithstanding the service he rendered the Society by his lengthy description, that credulous historian remarks of its history that there is nothing he ever "met with more false or incoherent."

The author of the *Academie of Armory*, previously noted, knew better what he was writing about in that work of 1683 in which he declares: "I cannot but Honor the Fellowship of the Masons because of its Antiquity; and the more, as being a member of that Society, called *Free Masons*." Mr Rylands states that in *Harl. M.S. 9955* is a collection of the engraved plates for a second volume of this important work, one being devoted to the Arms of the Society, the columns, as supporters, having globes thereon, from which possibly are derived the two pillars, with such ornaments or additions seen in lodge rooms at a later period.

In the same year "A Tripos or Speech delivered at a commencement in the University of Dublin held there July 11, 1688, by John Jones, then A.B., afterwards D.D.," contained "notable evidence concerning Freemasonry in Dublin." The Tripos was included in Sir Walter Scott's edition of Deap Swift's works (1814), but as Dr Chetwode Crawley points out, though noticed by the Rev. Dr George Oliver (the voluminous Masonic author), he failed to realize its historical importance. The satirical and withal amusing speech was partly translated from the Latin by Dr Crawley for his scholarly introduction to the *Masonic Reprints*, &c., by Henry Sadler. "The point seems to be that Ridley (reputed to have been an informer against priests under the barbarous penal laws) was, or ought to have been, hanged; that his carcase, anatomized and stuffed, stood in the library; and that *frath scouidrellius* discovered on his remains the Freemasons' Mark." The importance of the references to the craft in Ireland is simply owing to the year in which they were made, as illustrative of the influence of the Society at that time, of which records are lacking.

It is primarily to Scotland, however, that we have to look for such numerous particulars of the activity of the fraternity from 1599 to the establishment of its Grand Lodge in 1736, for an excellent account of which we are indebted to Lyon, the Scottish masonic historian. As early as 1600 (8th of June) the attendance of John Boswell, Esq., the laird of Auchinleck, is entered in the minutes of the Lodge of Edinburgh; he attested the record and added his mark, as did the other members; so it was not his first appearance. Many noblemen and other gentlemen joined this ancient *atelier*, notably Lord Alexander, Sir Anthony Alexander and Sir Alexander Strachan in 1634, the king's Master of Work (Herrie Alexander) in 1638, General Alexander Hamilton in 1640, Dr Hamilton in 1647, and many other prominent and distinguished men later; "James Neilson, Master Sklatter to His Majesty," who was "entered and past in the Lodge of Linlithgow, being elected a joining member," 2nd March 1654. Quarter-Master General Robert Moray (or Murray) was initiated by members of the Lodge of Edinburgh at Newcastle on the 20th of May 1641, while the Scottish army was in occupation. On due report to their Alma Mater such reception was allowed, the occurrence having been considered the first of its kind in England until the ancient Records of the Masons' Company were published.

The minute-books of a number of Scottish Lodges, which are still on the register, go back to the 17th century, and abundantly confirm the frequent admission of speculatives as members and officers, especially those of the venerable "Mother Lodge

Kilwinning," of which the earl of Cassillis was the deacon in 1672, who was succeeded by Sir Alexander Cunningham, and the earl of Eglinton, who like the first of the trio was but an apprentice. There were three Head Lodges according to the Scottish Code of 1599, Edinburgh being "the first and principall," Kilwinning "the second," and Stirling "the third lodge."

The Aberdeen Lodge (No. 1 *tris*) has records preserved from 1670, in which year what is known as the *Mark Book* begins, containing the oldest existing roll of members, numbering 49, all of whom have their marks registered, save two, though only ten were operatives. The names of the earls of Finlater, Erroll and Dunfermline, Lord Forbes, several ministers and professional men are on the list, which was written by a glazier, all of whom had been enlightened as to the "benefit of the measson word," and inserted in order as they "were made fellow craft." The *Charter (Old Charges)* had to be read at the "entering of everie prentise," and the officers included a master and two wardens.

The lodge at Melrose (No. 1 *bis*) with records back to 1674 did not join the Grand Lodge until 1891, and was the last of those working (possibly centuries before that body was formed) to accept the modern system of government. Of the many noteworthy lodges mention should be made of that of "Canongate Kilwinning No. 2," Edinburgh, the first of the numerous pendicles of "Mother Lodge Kilwinning, No. 0," Ayrshire, started in 1677; and of the Journeymen No 8, formed in 1707, which was a secession from the Lodge of Edinburgh; the Fellow Crafts or Journeymen not being satisfied with their treatment by the Freeman Masters of the Incorporation of Masons, &c. This action led to a trial before the Lords of Council and Session, when finally a "Decreet Arbitral" was subscribed to by both parties, and the junior organization was permitted "to give the mason word as it is called" in a separate lodge. The presbytery of Kelso¹ in 1652 sustained the action of the Rev. James Ainslie in becoming a Freemason, declaring that "there is neither sinne nor scandale in that word" (i.e. the "Mason Word"), which is often alluded to but never revealed in the old records already referred to.² One Scottish family may be cited in illustration of the continuous working of Freemasonry, whose membership is enshrined in the records of the ancient Lodge of "Scoon and Perth No. 3" and others. A venerable document, lovingly cared for by No. 3, bears date 1658, and recites how John Mylne came to Perth from the "North Countrie," and was the king's Master Mason and W.M. of the Lodge, his successor being his son, who entered "King James the sixt as fireman meassone and fellow craft"; his third son John was a member of Lodge No. 1 and Master Mason to Charles I., 1631-1636, and his eldest son was a deacon of No. 1 eleven times during thirty years. To him was apprenticed his nephew, who was warden in 1663-1664 and deacon several times. William Mylne was a warden in 1695, Thomas (eldest son) was Master in 1735, and took part in the formation of the Grand Lodge of Scotland. Others of the family continued to join the Lodge No. 1, until Robert, the last of the Mylnes as Freemasons, was initiated in 1754, died in 1811, and "was buried in St Paul's cathedral, having been Surveyor to that Edifice for fifty years," and the last of the masonic Mylnes for five generations. The "St John's Lodge," Glasgow (No. 3 *bis*), has some valuable old records and a "Charter Chest" with the words carved thereon "God save the King and Masons Craft, 1684." *Loyalty and Charity* are the watchwords of the Society.

The Craft Guilds (*Corps d'Etat*) of France, and their progeny the *Companionage*, have been fully described by Mr Gould, and the *Steinmetzen* of Germany would require too detailed notice if we were to particularize its rules, customs and general character, from about the 12th century onward. Much as there was in common between the Stonemasons of Germany and the Freemasons of Great Britain and Ireland, it must be conceded that the two societies never united and were all through this long period wholly separate and independent; a knowledge of Freemasonry and authority to hold lodges in Germany being derived from the Grand Lodge of England during the first half of the 18th century. The theory of the derivation of the Freemasons from the *Steinmetzen* was first propounded in 1779 by the abbé Grandidier, and has been maintained by more modern writers, such as Fallou, Heideloff and Schneider, but a thorough examination of their statements has resulted in such an origin being generally discredited. Whether the *Steinmetzen* had secret signs of recognition or not, is not quite clear, but that the Freemasons had, for centuries, cannot be doubted, though precisely what they were may be open to question, and also what portions of the existing ceremonies are reminiscent of the craft anterior to the Revival of 1717. Messrs Speth and Gould favour the notion that there were two distinct and separate degrees prior to the third decade of the 18th century (*Ars Q.C.*, 1898 and 1903), while other authorities have either supported the *One degree* theory, or consider there is not sufficient evidence to warrant a decision. Recent discoveries, however, tend in favour of the first view noted, such as the *Trinity College M.S.*, Dublin ("Free Masonry, Feb. 1711"), and the invaluable³ *Chetwode Crawley M.S.* (Grand Lodge Library, Dublin); the second being read in connexion with the Haughtfoot Lodge Records, beginning 1702 (*Hist. of Freemasonry*, by W. F. Vernon, 1893).

Two of the most remarkable lodges at work during the period of transition (1712-1723), out of the many then existing in England, assembled at Alnwick and at York. The origin of the first noted is not known, but there are minutes of the meetings from 1703, the Rules are of 1701, signed by quite a number of members, and a transcript of the *Old Charges* begins the volume. In 1708-1709 a minute provided for a masonic procession, at which the brethren were to walk "with their aprons on and Comon Square." The Lodge consisted mainly of operative "free Brothers," and continued for many years, a code of by-laws being published in 1763, but it never united with the Grand Lodge, giving up the struggle for existence a few years further on.

The other lodge, the most noteworthy of all the English predecessors of the Grand Lodge of England, was long held at York, the Mecca of English Freemasons.⁴ Its origin is unknown, but there are traces of its existence at an early date, and possibly it was a survival of the Minster Lodge of the 14th century. Assuming that the *York M.S. No. 4* of 1693 was the property of the lodge in that year (which Roll was presented by George Walker of Wetherby in 1777), the entry which concludes that Scroll is most suggestive, as it gives "The names of the Lodge" (members) and the "Lodge Ward(en)." Its influence most probably may be also noted at Scarborough, where "A private Lodge" was held on the 10th of July 1705, at which the president "William Thompson, Esq., and severall others brethren free Masons" were present, and six gentlemen (named) "were then admitted into the said fraternity." These particulars are endorsed on the *Scarborough M.S.* of the Old Charges, now owned by the Grand Lodge of Canada at Toronto. "A narrow folio manuscript Book beginning 7th March 1705-1706," which was quoted from in 1778, has long been missing, which is much to be regretted, as possibly it gave particulars of the lodge which assembled at Bradford, Yorkshire, "when 18 Gentlemen of the first families in that neighbourhood were made Masons." There is, however, another roll of records from 1712 to 1730 happily preserved of this "Ancient Honble. Society and Fraternity of Free Masons," sometimes styled "Company" or "Society of Free and Accepted Masons."

Not to be behind the London fratres, the York brethren formed a Grand Lodge on the 27th of December 1725 (the "Grand

¹ The *Chetwode Crawley M.S.* by W. J. Hughan (*Ars Q.C.*, 1904).

² The *York Grand Lodge*, by Messrs. Hughan and Whythead (*Ars Q.C.*, 1900), and *Masonic Sketches and Reprints* (1871), by the former.

³ The *Chetwode Crawley M.S.* by W. J. Hughan (*Ars Q.C.*, 1904).

⁴ The *York Grand Lodge*, by Messrs. Hughan and Whythead (*Ars Q.C.*, 1900), and *Masonic Sketches and Reprints* (1871), by the former.

Two of the most remarkable lodges at work during the period of transition (1712-1723), out of the many then existing in England, assembled at Alnwick and at York. The origin of the first noted is not known, but there are minutes of the meetings from 1703, the Rules are of 1701, signed by quite a number of members, and a transcript of the *Old Charges* begins the volume. In 1708-1709 a minute provided for a masonic procession, at which the brethren were to walk "with their aprons on and Comon Square." The Lodge consisted mainly of operative "free Brothers," and continued for many years, a code of by-laws being published in 1763, but it never united with the Grand Lodge, giving up the struggle for existence a few years further on.

The other lodge, the most noteworthy of all the English predecessors of the Grand Lodge of England, was long held at York, the Mecca of English Freemasons.⁴ Its origin is unknown, but there are traces of its existence at an early date, and possibly it was a survival of the Minster Lodge of the 14th century. Assuming that the *York M.S. No. 4* of 1693 was the property of the lodge in that year (which Roll was presented by George Walker of Wetherby in 1777), the entry which concludes that Scroll is most suggestive, as it gives "The names of the Lodge" (members) and the "Lodge Ward(en)." Its influence most probably may be also noted at Scarborough, where "A private Lodge" was held on the 10th of July 1705, at which the president "William Thompson, Esq., and severall others brethren free Masons" were present, and six gentlemen (named) "were then admitted into the said fraternity." These particulars are endorsed on the *Scarborough M.S.* of the Old Charges, now owned by the Grand Lodge of Canada at Toronto. "A narrow folio manuscript Book beginning 7th March 1705-1706," which was quoted from in 1778, has long been missing, which is much to be regretted, as possibly it gave particulars of the lodge which assembled at Bradford, Yorkshire, "when 18 Gentlemen of the first families in that neighbourhood were made Masons." There is, however, another roll of records from 1712 to 1730 happily preserved of this "Ancient Honble. Society and Fraternity of Free Masons," sometimes styled "Company" or "Society of Free and Accepted Masons."

Not to be behind the London fratres, the York brethren formed a Grand Lodge on the 27th of December 1725 (the "Grand

Lodge of all England" was its modest title), and was flourishing for years, receiving into their company many county men of great influence. Some twenty years later there was a brief period of somnolence, but in 1761 a revival took place, with Francis Drake, the historian, as Grand Master, ten lodges being chartered in Yorkshire, Cheshire and Lancashire, 1762-1790, and a Grand Lodge of England, south of the Trent, in 1779, at London, which warranted two lodges. Before the century ended all these collapsed or joined the Grand Lodge of England, so there was not a single representative of "York Masonry" left on the advent of the next century.

The premier Grand Lodge of England soon began to constitute new Lodges in the metropolis, and to reconstitute old ones that applied for recognition, one of the earliest of 1720-1721 being still on the Roll as No. 6, thus having kept company ever since with the three "time immemorial Lodges," Nos. 2, 4 and 12. Applications for constitution kept coming in, the provinces being represented from 1723 to 1724, before which time it is likely the Grand Lodge of Ireland¹ had been started, about which the most valuable *Caementaria Hibernica* by Dr Chetwode Crawley may be consulted with absolute confidence. Provincial Grand Lodges were formed to ease the authorities at headquarters, and, as the society spread, also for the Continent, and gradually throughout the civilized globe. Owing to the custom prevailing before the 18th century, a few brethren were competent to form lodges on their own initiative anywhere, and hence the registers of the British Grand Lodges are not always indicative of the first appearance of the craft abroad. In North America² lodges were held before what is known as the first "regular" lodge was formed at Boston, Mass., in 1733, and probably in Canada³ likewise. The same remark applies to Denmark, France, Germany, Holland, Italy, Portugal, Russia, Spain, Sweden and other countries. Of the many scores of military lodges, the first warrant was granted by Ireland in 1732. To no other body of Freemasons has the craft been so indebted for its prosperity in early days as to their military brethren. There were rivals to the Grand Lodge of England during the 18th century, one of considerable magnitude being known as the Ancients or Atholl Masons, formed in 1751, but in December 1813 a junction was effected, and from that time the prosperity of the United Grand Lodge of England, with few exceptions, has been extraordinary.

Nothing but a volume to itself could possibly describe the main features of the English Craft from 1717, when Anthony Sayer was elected the first Grand Master of a brilliant galaxy of rulers. The first nobleman to undertake that office was the duke of Montagu in 1721, the natural philosopher J. T. Desaguliers being his immediate predecessor, who has been credited (and also the Rev. James Anderson) with the honour of starting the premier Grand Lodge; but like the fable of Sir Christopher Wren having been Grand Master, evidence is entirely lacking. Irish and Scottish peers share with those of England the distinction of presiding over the Grand Lodge, and from 1782 to 1813 their Royal Highnesses the duke of Cumberland, the prince of Wales, or the duke of Sussex occupied the masonic throne. From 1753 to 1813 the rival Grand Lodge had been busy, but ultimately a desire for a united body prevailed, and under the "ancient" Grand Master, H.R.H. the duke of Kent, it was decided to amalgamate with the original ruling organization, H.R.H. the duke of Sussex becoming the Grand Master of the United Grand Lodge. On the decease of the prince in 1843 the earl of Zetland succeeded, followed by the marquis of Ripon in 1874, on whose resignation H.R.H. the prince of Wales became the Grand Master. Soon after succeeding to the throne,

¹The celebrated "Lady Freemason," the Hon. Mrs Aldworth (née Miss St Leger, daughter of Lord Doneraile), was initiated in Ireland, but at a much earlier date than popularly supposed; certainly not later than 1713, when the venturesome lady was twenty. All early accounts of the occurrence must be received with caution, as there are no contemporary records of the event.

²*History of Freemasonry*, by Dr A. G. Mackey (New York, 1898), and the *History of the Fraternity Publishing Company*, Boston, Mass., give very full particulars as to the United States.

³See *History of Freemasonry in Canada* (Toronto, 1899), by J. Ross Robertson.

King Edward VII. ceased to govern the English craft, and was succeeded by H.R.H. the duke of Connaught. From 1737 to 1907 some sixteen English princes of the royal blood joined the brotherhood.

From 1723 to 1813 the number of lodges enrolled in England amounted to 1626, and from 1814 to the end of December 1909 as many as 3352 were warranted, making a grand total of 4978, of which the last then granted was numbered 3185. There were in 1909 still 2876 on the register, notwithstanding the many vacancies created by the foundation of new Grand Lodges in the colonies and elsewhere.

Distribution and Organization.—The advantage of the cosmopolitan basis of the fraternity generally (though some Grand Lodges still preserve the original Christian foundation) has been conspicuously manifested and appreciated in India and other countries where the votaries of numerous religious systems congregate; but the unalterable basis of a belief in the Great Architect of the Universe remains, for without such a recognition there can be no Freemasonry, and it is now, as it always has been, entirely free from party politics. The charities of the Society in England, Ireland and Scotland are extensive and well organized, their united cost per day not being less than £500, and with those of other Grand Lodges throughout the world must amount to a very large sum, there being over two millions of Freemasons. The vast increase of late years, both of lodges and members, however, calls for renewed vigilance and extra care in selecting candidates, that numbers may not be a source of weakness instead of strength.

In its internal organization, the working of Freemasonry involves an elaborate system of symbolic ritual,⁴ as carried out at meetings of the various lodges, uniformity as to essentials being the rule. The members are classified in numerous degrees, of which the first three are "Entered Apprentice," "Fellow Craft" and "Master Mason," each class of which, after initiation, can only be attained after passing a prescribed ordeal or examination, as a test of proficiency, corresponding to the "essays" of the operative period.

The lodges have their own by-laws for guidance, subject to the *Book of Constitutions* of their Grand Lodge, and the regulations of the provincial or district Grand Lodge if located in counties or held abroad.

It is to be regretted that on the continent of Europe Freemasonry has sometimes developed on different lines from that of the "Mother Grand Lodge" and Anglo-Saxon Grand Lodges generally, and through its political and anti-religious tendencies has come into contact or conflict with the state authorities⁵ or the Roman Catholic church. The "Grand Orient of France" (but not the Supreme Council 33^o, and its Grand Lodge) is an example of this retrograde movement, by its elimination of the paragraph referring to a belief in the "Great Architect of the Universe" from its *Statuts et règlements généraux*. This deplorable action has led to the withdrawal of all regular Grand Lodges from association with that body, and such separation must continue until a return is made to the ancient and inviolable landmark of the society, which makes it impossible for an atheist either to join or continue a member of the fraternity.

The Grand Lodge of England constituted its first lodge in Paris in the year 1732, but one was formed still earlier on the continent at Gibraltar 1728-1729. Others were also opened in Germany 1733, Portugal 1735, Holland 1735, Switzerland 1740, Denmark 1745, Italy 1763, Belgium 1765, Russia 1771, and

⁴*The Masonic Records 1717-1804*, by John Lane, and the excellent *Masonic Yearbook*, published annually by the Grand Lodge of England, are the two standard works on Lodge enumeration, localization and nomenclature. For particulars of the Grand Lodges, and especially that of England, Gould's History is most useful and trustworthy; and for an original contribution to the history of the rival Grand Lodge or Atholl Masons, Sadler's *Masonic Facts and Fictions*.

⁵A peculiar system of Morality, veiled in Allegory and illustrated by Symbols (old definition of Freemasonry).

⁶The British House of Commons in 1799 and 1817, in acts of parliament, specifically recognized the laudable character of the society and provided for its continuance on definite lines.

Sweden 1773. In most of these countries Grand Lodges were subsequently created and continue to this date, save that in Austria (not Hungary) and Russia no masonic lodges have for some time been permitted to assemble. There is a union of Grand Lodges of Germany, and an annual Diet is held for the transaction of business affecting the several masonic organizations in that country, which works well. H.R.H. Prince Frederick Leopold was in 1909 Protector, or the "Wise Master" (Vicarius Salomonis). King Gustav V. was the Grand Master of the freemasons in Sweden, and the sovereign of the "Order of Charles XIII.," the only one of the kind confined to members of the fraternity.

Lodges were constituted in India from 1730 (Calcutta), 1752 (Madras), and 1758 (Bombay); in Jamaica 1742, Antigua 1738, and St Christopher 1739; soon after which period the Grand Lodges of England, Ireland and Scotland had representatives at work throughout the civilized world.

In no part, however, outside Great Britain has the craft flourished so much as in the United States of America, where the first "regular" lodge (i.e. according to the new regime) was opened in 1733 at Boston, Mass. Undoubtedly lodges had been meeting still earlier, one of which was held at Philadelphia, Penna., with records from 1731, which blossomed into a Grand Lodge, but no authority has yet been traced for its proceedings, save that which may be termed "time immemorial right," which was enjoyed by all lodges and brethren who were at work prior to the Grand Lodge era (1716-1717) or who declined to recognize the autocratic proceedings of the premier Grand Lodge of England, just as the brethren did in the city of York. A "deputation" was granted to Daniel Coxe, Esq. of New Jersey, by the duke of Norfolk, Grand Master, 5th of June 1730, as Prov. Grand Master of the "Provinces of New York, New Jersey and Pennsylvania," but there is no evidence that he ever constituted any lodges or exercised any masonic authority in virtue thereof. Henry Price as Prov. Grand Master of New England, and his lodge, which was opened on the 31st of August 1733, in the city of Boston, so far as is known, began "regular" Freemasonry in the United States, and the older and independent organization was soon afterwards "regularized." Benjamin Franklin (an Initiate of the lodge of Philadelphia) printed and published the *Book of Constitutions*, 1723 (of London, England), in the "City of Brotherly Love" in 1734, being the oldest masonic work in America. English and Scottish Grand Lodges were soon after petitioned to grant warrants to hold lodges, and by the end of the 18th century several Grand Lodges were formed, the Craft becoming very popular, partly no doubt by reason of so many prominent men joining the fraternity, of whom the chief was George Washington, initiated in a Scottish lodge at Fredericksburg, Virginia, in 1752-1753. In 1907 there were fifty Grand Lodges assembling in the United States, with considerably over a million members.

In Canada in 1909 there were eight Grand Lodges, having about 64,000 members. Freemasonry in the Dominion is believed to date from 1740. The Grand Lodges are all of comparatively recent organization, the oldest and largest, with 40,000 members, being for Ontario; those of Manitoba, Nova Scotia and Quebec numbering about 5000 each. There are some seven Grand Lodges in Australia; South Australia coming first as a "sovereign body," followed closely by New South Wales and Victoria (of 1884-1889 constitution), the whole of the lodges in the Commonwealth probably having fully 50,000 members on the registers.

There are many additional degrees which may be taken or not (being quite optional), and dependent on a favourable ballot; the difficulty, however, of obtaining admission increases as progress is made, the numbers accepted decreasing rapidly with each advancement. The chief of these are arranged in separate classes and are governed either by the "Grand Chapter of the Royal Arch," the "Mark Grand Lodge," the "Great Priory of Knights Templars" or the "Ancient and Accepted Rite," these being mutually complementary and intimately connected as respects England, and more or less so in Ireland, Scotland,

North America and wherever worked on a similar basis; the countries of the continent of Europe have also their own *Hauts Grades*. (W. J. H. *)

FREEPORT, a city and the county-seat of Stephenson county, Illinois, in the N.W. part of the state, on the Peconica river, 30 m. from its mouth and about 100 m. N.W. of Chicago. Pop. (1890) 10,189; (1900) 13,258, of whom 2264 were foreign-born; (1910 census) 17,567. The city is served by the Chicago & North-Western, the Chicago, Milwaukee & St Paul, and the Illinois Central railways, and by the Rockford & Interurban electric railway. The Illinois Central connects at South Freeport, about 3 m. S. of Freeport, with the Chicago Great Western railway. Among Freeport's manufactures are foundry and machine shop products, carriages, hardware specialties, patent medicines, windmills, engines, incubators, organs, beer and shoes. The Illinois Central has large railway repair shops here. The total value of the city's factory product in 1905 was \$3,100,302, an increase of 14.8% since 1900. In the surrounding country cereals are grown, and swine and poultry are raised. Dairying is an important industry also. The city has a Carnegie library (1901). In the Court House Square is a monument, 80 ft. high, in memory of the soldiers who died in the Civil War. At the corner of Douglas Avenue and Mechanic Street a granite boulder commemorates the famous debate between Abraham Lincoln and Stephen A. Douglas, held in Freeport on the 27th of August 1858. In that debate Lincoln emphasized the differences between himself and the radical anti-slavery men, and in answer to one of Lincoln's questions Douglas declared that the people of a territory, through "unfriendly" laws or denial of legislative protection, could exclude slavery, and that "it matters not what way the Supreme Court may hereafter decide on the abstract question whether slavery may or may not go into a territory under the Constitution." This, the so-called "Freeport doctrine," greatly weakened Douglas in the presidential election of 1860. Freeport was settled in 1835, was laid out and named Winneshiek in 1836, and in 1837 under its present name was made the county-seat of Stephenson county. It was incorporated as a town in 1850 and chartered as a city in 1855.

FREE PORTS, a term, strictly speaking, given to localities where no customs duties are levied, and where no customs supervision exists. In these ports (subject to payment for specific services rendered, wharfage, storage, &c., and to the observance of local police and sanitary regulations) ships load and unload, cargoes are deposited and handled, industries are exercised, manufactures are carried on, goods are bought and sold, without any action on the part of fiscal authorities. Ports are likewise designated "free" where a space or zone exists within which commercial operations are conducted without payment of import or export duty, and without active interference on the part of customs authorities. The French and German designations for these two descriptions of ports are—for the former *La Ville franche, Freihafen*; for the latter *Le Port franc, Freibezirk or Freilager*. The English phrase free port applies to both.¹ The leading conditions under which free ports in Europe derived their origin were as follows:—(1) When public order became re-established during the middle ages, trading centres were gradually formed. Marts for the exchange and purchase of goods arose in different localities. Many Italian settlements, constituting free zones, were established in the Levant. The Hanseatic towns arose in the 12th century. Great fairs became recognized—the Leipzig charter was granted in 1268. These localities were free as regards customs duties, although dues of the nature of octroi charges were often levied. (2) Until the 19th century European states were numerous, and often of small size. Accordingly uniform customs tariffs of wide application did not exist.

¹ In China at the present time (1902) certain ports are designated "free and open." This phrase means that the ports in question are (1) open to foreign trade, and (2) that vessels engaged in overseas voyages may freely resort there. Exemption from payment of customs duties is not implied, which is a matter distinct from the permission granted under treaty engagements to foreign vessels to carry cargoes to and from the "treaty ports."

Uniform rates of duty were fixed in England by the Subsidy Act of 1660. In France, before the Revolution (besides the free ports), Alsace and the Lorraine Bishoprics were in trade matters treated as foreign countries. The unification of the German customs tariff began in 1834 with the *Steuerverein* and the *Zollverein*. The Spanish fiscal system did not include the Basque provinces until about 1850. The uniform Italian tariff dates from 1861. Thus until very recent times on the Continent free ports were compatible with the fiscal policy and practice of different countries. (3) Along the Mediterranean coast, up to the 19th century, convenient shelter was needed from corsairs. In other continental countries the prevalent colonial and mercantile policy sought to create trans-oceanic trade. Free ports were advantageous from all these points of view.

In following the history of these harbours in Europe, it is to be observed that in Great Britain free ports have never existed. In 1552 it was contemplated to place Hull and Southampton on this footing, but the design was abandoned. Subsequently the bonding and not the free port system was adopted in the United Kingdom.

Austria-Hungary.—Fiume and Trieste were respectively free ports during the periods 1722-1893 and 1719-1893.

Belgium.—The emperor Joseph II, during his visit to the Austrian Netherlands in June 1781 endeavoured to create a direct trade between that country and India. Ostend was made a free port, and large bonding facilities were afforded at Bruges, Brussels, Ghent and Louvain. In 1796, however, the revolutionary government abolished the Ostend privileges.

Denmark.—In November 1894 an area of about 150 acres at Copenhagen was opened as a free port, and great facilities are afforded for shipping and commercial operations in order that the Baltic trade may centre there.

France.—Marseilles was a free port in the middle ages, and so was Dunkirk when it formed part of Flanders. In 1669 these privileges were confirmed, and extended to Bayonne. In 1784 there was a fresh confirmation, and Lorient and St Jean de Luz were included in the *ordonnance*. The National Assembly in 1790 maintained this policy, and created free ports in the French West India. In 1795, however, all such privileges were abolished, but large bonding facilities were allowed at Marseilles to favour the Levant trade. The government of Louis XVIII. in 1814 restored, and in 1871 again revoked, the free port privileges of Marseilles. There are now no free ports in France or in French possessions; the bonding system is in force.

Germany.—Bremen, Hamburg and Lübeck were reconstituted free towns and ports under the treaties of 1814-1815. Certain minor ports, and several landing-stages on the Rhine and the Neckar, were also designated free. As the *Zollverein* policy became accepted throughout Germany, previous privileges were gradually lessened, and since 1888 only Hamburg remains a free port. There an area of about 2500 acres is exempt from customs duties and control, and is largely used for shipping and commercial purposes. Bremerhaven has a similar area of nearly 700 acres. Brake, Bremen, Cuxhaven, Emden, Geestemünde, Neufahrwasser and Stettin possess *Freibeirke* areas, portions of the larger port. Heligoland is outside the *Zollverein*—practically a foreign country.

In Italy free ports were numerous and important, and possessed privileges which varied at different dates. They were—Ancona, during the period 1696-1868; Brindisi, 1845-1862; Leghorn (in the 17th and 18th centuries a very important Mediterranean harbour), 1675-1867; Messina, 1695-1879; Senigallia, 1821-1868, during the month of the local fair. Venice possessed warehouses, equivalent to bonded stores, for German and Turkish trade during the Republic, and was a free port 1851-1873. Genoa was a free port in the time of the Republic and under the French Empire, and was continued as such by the treaties of 1814-1815. The free port was, however, changed into a *deposito franco* by a law passed in 1865, and only storing privileges now remain.

Rumania.—Braila, Galatz and Kustenji were free ports (for a period of about forty years) up to 1883, when bonded warehouses were established by the Rumanian government. Sulina remains free.

Russia.—Archangel was a free port, at least for English goods, from 1553 to 1648. During this period English products were admitted into Russia via Archangel without any customs payment for internal consumption, and also in transit to Persia. The tsar Alexis revoked this grant on the execution of Charles I. Free ports were opened in 1895 at Kola, in Russian Lapland. Dalny, adjoining Port Arthur, was a free port during the Russian occupation; and Japan after the war decided to renew this privilege as soon as practicable.

The number of free ports outside Europe has also lessened. The administrative policy of European countries has been gradually adopted in other parts of the world, and customs duties have become almost universal, conjoined with bonding and transhipment facilities. In British colonies and possessions, under an act of parliament passed in 1766, and repealed in 1867, two ports in Dominica and four in Jamaica were free, Malacca, Penang and Singapore have been

free ports since 1824, Hong-Kong since 1842, and Weihaiwei since it was leased to Great Britain in 1898. Zanzibar was a free port during 1892-1899. Aden, Gibraltar, St Helena and St Thomas (West Indies) are sometimes designated free ports. A few duties are, however, levied, which are really octroi rather than customs charges. These places are mainly stations for coaling and awaiting orders.

Some harbours in the Netherlands East Indies were free ports between 1829 and 1899; but these privileges were withdrawn by laws passed in 1898-1899, in order to establish uniformity of customs administration. Harbours where custom houses are not maintained will be practically closed to foreign trade, though the governor-general may in special circumstances vary the application of the new regulations.

Macao has been a free port since 1845. Portugal has no other harbour of this character.

The American Republics have adopted the bonding system. In 1896 a free wharf was opened at New Orleans in imitation of the recent European plan. Livingstone (Guatemala) was a free port during the period 1882-1888.

The privileges enjoyed under the old free port system benefited the towns and districts where they existed; and their abolition has been, locally, injurious. These places were, however, "foreign" to their own country, and their inland intercourse was restricted by the duties levied on their products, and by the precautions adopted to prevent evasion of these charges. With fiscal usages involving preferential and differential treatment of goods and places, the drawbacks thus arising did not attract serious attention. Under the limited means of communication within and beyond the country, in former times, these conveniences were not much felt. But when finance departments became more completely organized, the free port system fell out of favour with fiscal authorities: it afforded opportunities for smuggling, and impeded uniformity of action and practice. It became, in fact, out of harmony with the administrative and financial policy of later times. Bonding and entrepot facilities, on a scale commensurate with local needs, now satisfy trade requirements. In countries where high customs duties are levied, and where fiscal regulations are minute and rigid, if an extension of foreign trade is desired, and the competition which it involves is a national aim, special facilities must be granted for this purpose. In these circumstances a free zone sufficiently large to admit of commercial operations and transshipments on a scale which will fulfil these conditions (watched but not interfered with by the customs) becomes indispensable. The German government have, as we have seen, maintained a free zone of this nature at Hamburg. And when the free port at Copenhagen was opened, counter measures were adopted at Danzig and Stettin. An agitation has arisen in France to provide at certain ports free zones similar to those at Copenhagen and Hamburg, and to open free ports in French possessions. A bill to this effect was submitted to the chamber of deputies on the 12th of April 1905. Colonial free ports, such as Hong-Kong and Singapore, do not interfere with the uniformity of the home customs and excise policy. These two harbours in particular have become great shipping resorts and distributing centres. The policy which led to their establishment as free ports has certainly promoted British commercial interests.

See the Parliamentary Paper on "Continental Free Ports," 1904.

(C. M. K.)

FREE REED VIBRATOR (Fr. *anche libre*, Ger. *durchschlagende Zunge*, Ital. *ancia* or *lingua libera*), in musical instruments, a thin metal tongue fixed at one end and vibrating freely either in surrounding space, as in the accordion and concertina, or enclosed in a pipe or channel, as in certain reed stops of the organ or in the harmonium. The enclosed reed, in its typical and theoretical form, is fixed over an aperture of the same shape but just large enough to allow it to swing freely backwards and forwards, alternately opening and closing the aperture, when driven by a current of compressed air. We have to deal with air under three different conditions in considering the phenomenon of the sound produced by free reeds. (1) The stationary column or stratum in pipe or channel containing the reed, which is normally at rest. (2) The wind or current of air fed from the bellows with a variable velocity and pressure, which is broken up into periodic air puffs as its entrance into pipe or channel is

alternately checked or allowed by the vibrator. (3) The disturbed condition of No. 1 when acted upon by the metal vibrator and by No. 2, whereby the air within the pipe is forced into alternate pulses of condensation and rarefaction. The free reed is therefore not the tone-producer but only the exciting agent, that is to say, the sound is not produced by the communication of the free reed's vibrations to the surrounding air,¹ as in the case of a vibrating string, but by the series of air puffs punctuated by infinitesimal pauses, which it produces by alternately opening and almost closing the aperture.² A musical sound is thus produced the pitch of which depends on the length and thickness of the metal tongue; the greater the length, the slower the vibrations and the lower the pitch, while on the contrary, the thicker the reed near the shoulder at the fixed end, the higher the pitch. It must be borne in mind that the periodic vibrations of the reed determine the pitch of the sound solely by the frequency per second they impose upon the pulses of rarefaction and condensation within the pipe.

The most valuable characteristic of the free reed is its power of producing all the delicate gradations of tone between forte and

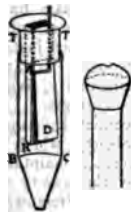

From J B Biol. *Traité de Musique expérimentale.*

FIG. 1.—Grenie's organ pipe fitted with free-reed vibrator.
A, Tuning wire.
B, Free reed.
C, Reed-box.
D, Feed pipe with conical foot.
E, Part of resonating pipe, the upper end with cap and vent hole being shown separately at the side.

of Europe (in England the reed pipes are generally provided with beating reeds, see REED INSTRUMENTS and CLARINET). (2) Free reeds vibrating in reed compartments and reinforced by air chambers of various shapes and sizes as in the harmonium (*q.v.*). (3) Instruments like the accordion and concertina having the free reed set in vibration through a valve, but having no reinforcing medium.

The arrangement of the free reed in an organ pipe is simple, and does not differ greatly from that of the beating reed shown in fig. 2 for the purpose of comparison. The reed-box, a rectangular wooden pipe, is closed at the bottom and covered on one face with a thin plate of copper having a rectangular slit over which is fixed the thin metal vibrating tongue or reed as described above. The reed-box, itself open at the top, is enclosed in a feed pipe having a conical foot pierced with a small hole through which the air current is forced by the action of the bellows. The impact of the incoming compressed air against the reed tongue sets it swinging through the slit, thus causing a disturbance or series of pulsations within the reed-box. The air then finds an escape through the resonating medium of a pipe fitting over the reed-box and terminating in an inverted cone covered with a cap in the top of which is pierced a small hole or vent.

The quality of tone of free reeds is due to the tendency of air set

¹ See H. Helmholz, *Die Lehre von den Tonempfindungen* (Brunswick, 1877), p. 166.
² See also Ernst Heinrich and Wilhelm Weber, *Wellenlehre* (Leipzig, 1825), where a particularly lucid explanation of the phenomenon is given, pp. 526-530.

in periodic pulsations to divide into aliquot vibrations or loops, producing the phenomenon known as harmonic overtones or upper partials, which may, in the highly composite clang of free reeds, be discerned as far as the 16th or 20th of the series. The more intermittent and interrupted the air current becomes, the greater the number of the upper partials produced.³ The power of the overtones and their relation to the fundamental note depend greatly upon the form of the tongue, its position and the amount of the clearance left as it swings through the aperture.

Free reeds not associated with resonating media as in the concertina are peculiarly rich in harmonics, but as the higher harmonics lie very close together, disagreeable dissonances and a harsh tone result. The resonating pipe or chamber when suitably accommodated to the reed greatly modifies the tone by reinforcing the harmonics proper to itself, the others sinking into comparative insignificance. In order to produce a full rich tone, a resonator should be chosen whose deepest note coincides with the fundamental tone of the reed. The other upper partials will also be reinforced thereby, but to a less degree the higher the harmonics.⁴

For the history of the application of the free reed to keyboard instruments see HARMONIUM. (K. S.)

FREESIA, in botany, a genus of plants belonging to the Iris family (Iridaceae), and containing a single species, *F. refracta*, native at the Cape of Good Hope. The plants grow from a corm (a solid bulb, as in *Gladiolus*) which sends up a tuft of long narrow leaves and a slightly branched stem bearing a few leaves and loose one-sided spikes of fragrant narrowly funnel-shaped flowers. Several varieties are known in cultivation, differing in the colour of the flower, which is white, cream or yellow. They form pretty greenhouse plants which are readily increased from seed. They are extensively grown for the market in Guernsey, England and America. By potting successively throughout the autumn a supply of flowers is obtained through winter and spring. Some very fine large-flowered varieties, including rose-coloured ones, are now being raised by various growers in England, and are a great improvement on the older forms.

FREE SOIL PARTY, a political party in the United States, which was organized in 1847-1848 to oppose the extension of slavery into the Territories. It was a combination of the political abolitionists—many of whom had formerly been identified with the more radical Liberty party—the anti-slavery Whigs, and the faction of the Democratic party in the state of New York, called "Barnburners," who favoured the prohibition of slavery, in accordance with the "Wilmot Proviso" (see WILMOT, DAVID), in the territory acquired from Mexico. The party was prominent in the presidential campaigns of 1848 and 1852. At the national convention held in Buffalo, N.Y., on the 9th and 10th of August 1848, they secured the nomination to the presidency of ex-President Martin Van Buren, who had failed to secure nomination by the Democrats in 1844 because of his opposition to the annexation of Texas, and of Charles Francis Adams, of Massachusetts, for the vice-presidency, taking as their "platform" a Declaration that Congress, having "no more power to make a slave than to make a king," was bound to restrict slavery to the slave states, and concluding, "we inscribe on our banner 'Free Soil, Free Speech, Free Labor and Free Man,' and under it we will fight on and fight ever, until a triumphant victory shall reward our exertions." The Liberty party had previously, in November 1847, nominated

³ See Helmholz, *op. cit.* p. 167.

⁴ These phenomena are clearly explained at greater length by Seeley Taylor in *Sound and Music* (London, 1896), pp. 134-153 and pp. 74-86. See also Friedrich Zammmer, *Die Musik und die musikalischen Instrumente*, &c. (Giessen, 1835), p. 261.



FIG. 2.—Organ pipe fitted with beating reed.
AL, Beating reed.
R, Reed box.
F, Tuning wire.
TV, Feed pipe.
VV, Conical foot.
S, Hole through which compressed air is fed.

John P. Hale and Leicester King as president and vice-president respectively, but in the spring of 1848 it withdrew its candidates and joined the "free soil" movement. Representatives of eighteen states, including Delaware, Maryland and Virginia, attended the Buffalo convention. In the ensuing presidential election Van Buren and Adams received a popular vote of 291,263, of which 120,510 were cast in New York. They received no electoral votes, all these being divided between the Whig candidate, Zachary Taylor, who was elected, and the Democratic candidate, Lewis Cass. The "free soilers," however, succeeded in sending to the thirty-first Congress two senators and fourteen representatives, who by their ability exercised an influence out of proportion to their number.

Between 1848 and 1852 the "Barnburners" and the "Hunkers," their opponents, became partially reunited, the former returning to the Democratic ranks, and thus greatly weakening the Free Soilers. The party held its national convention at Pittsburg, Pennsylvania, on the 11th of August 1852, delegates being present from all the free states, and from Delaware, Maryland, Virginia and Kentucky; and John P. Hale, of New Hampshire, and George W. Julian of Indiana, were nominated for the presidency and the vice-presidency respectively, on a platform which declared slavery "a sin against God and a crime against man," denounced the Compromise Measures of 1850, the fugitive slave law in particular, and again opposed the extension of slavery in the Territories. These candidates, however, received no electoral votes and a popular vote of only 156,149, of which but 25,329 were polled in New York. By 1856 they abandoned their separate organization and joined the movement which resulted in the formation of the powerful Republican party (*q.v.*), of which the Free Soil party was the legitimate precursor.

FREE-STONE (a translation of the O. Fr. *franche pere* or *pierre*, i.e. stone of good quality; the modern French equivalent is *pierre de taille*, and Ital. *pietra molle*), stone used in architecture for mouldings, tracery and other work required to be worked with the chisel. The oolitic stones are generally so called, although in some countries soft sandstones are used; in some churches an indurated chalk called "clunch" is employed for internal lining and for carving.

FREETOWN, capital of the British colony of Sierra Leone, West Africa, on the south side of the Sierra Leone estuary, about 5 m. from the cape of that name, in 8° 29' N., 13° 10' W. Pop. (1901) 34,463. About 500 of the inhabitants are Europeans. Freetown is picturesquely situated on a plain, closed in behind by a succession of wooded hills, the Sierra Leone, rising to a height of 1700 ft. As nearly every house is surrounded by a courtyard or garden, the town covers an unusually large area for the number of its inhabitants. It possesses few buildings of architectural merit. The principal are the governor's residence and government offices, the barracks, the cathedral, the missionary institutions, the fruit market, Wilberforce Hall, courts of justice, the railway station and the grammar school. Several of these institutions are built on the slopes of the hills, and on the highest point, Sugar Loaf Mountain, is a sanatorium. The botanic gardens form a pleasant and favourite place of resort. The roads are wide but badly kept. Horses do not live, and all wheeled traffic is done by manual labour—hammocks and sedan-chairs are the customary means of locomotion. Notwithstanding that Freetown possesses an abundant and pure water-supply, drawn from the adjacent hills, it is enervating and unhealthy, and it was particularly to the capital, often spoken of as Sierra Leone, that the designation "White Man's Grave" applied. Since the beginning of the 20th century strenuous efforts have been made to improve the sanitary condition by a new system of drainage, a better water service, the filling up of marshes wherein the malarial mosquito breeds, and in other directions. A light railway 6 m. long, opened in 1904, has been built to Hill Station (900 ft. high), where, on a healthy site, are the residences of the government officials and of other Europeans. As a consequence the public health has improved, the highest death-rate in the years 1901-1907 being 29.6 per 1000. The town is governed

by a municipality (created in 1893) with a mayor and councillors, the large majority being elective. Freetown was the first place in British West Africa granted local self-government.

Both commercially and strategically Freetown is a place of importance. Its harbour affords ample accommodation for the largest fleets, it is a coaling station for the British navy, the headquarters of the British military forces in West Africa, the sea terminus of the railway to the rich oil-palm regions of Mendiland, and a port of call for all steamers serving West Africa. Its inhabitants are noted for their skill as traders; the town itself produces nothing in the way of exports.

In consequence of the character of the original settlement (see SIERRA LEONE), 75% of the inhabitants are descended from non-indigenous Negro races. As many as 150 different tribes are represented in the Sierra Leonis of to-day. Their semi-Europeanization is largely the result of missionary endeavour. The only language of the lower class is pidgin-English—quite incomprehensible to the newcomer from Great Britain,—but a large proportion of the inhabitants are highly educated men who excel as lawyers, clergymen, clerks and traders. Many members of the upper, that is, the best-educated, class have filled official positions of great responsibility. The most noted citizens are Bishop Crowther and Sir Samuel Lewis, chief justice of Sierra Leone 1882-1894. Both were full-blooded Africans. The Kru-men form a distinct section of the community, living in a separate quarter and preserving their tribal customs.

Since 1861-1862 there has been an independent Episcopal Native Church; but the Church Missionary Society, which in 1804 sent out the first missionaries to Sierra Leone, still maintains various agencies. Furah Bay College, built by the society on the site of General Charles Turner's estate (1½ m. E. of Freetown), and opened in 1828 with six pupils, one of whom was Bishop Crowther, was affiliated in 1876 to Durham University and has a high-class curriculum. The Wesleyans have a high school, a theological college, and other educative agencies. The Moslems, who are among the most law-abiding and intelligent citizens of Freetown, have several state-aided primary schools.

FREE TRADE, an expression which has now come to be appropriated to the economic policy of encouraging the greatest possible commercial intercourse, unrestricted by "protective" duties (see PROTECTION), between any one country and its neighbours. This policy was originally advocated in France, and it has had its adherents in many countries, but Great Britain stands alone among the great commercial nations of the world in having adopted it systematically from 1846 onwards as the fundamental principle of her economic policy.

In the economic literature of earlier periods, it may be noted that the term "free trade" is employed in senses which have no relation to modern usage. The term conveyed no suggestion of unrestricted trade or national liberty when it first appeared in controversial pamphlets; it stood for a freedom conferred and maintained by authority—like that of a free town. The merchants desired to have good regulations for trade so that they might be free from the disabilities imposed upon them by foreign princes or unscrupulous fellow-subjects. After 1640 the term seems to have been commonly current in a different sense. When the practice which had been handed down from the middle ages—of organizing the trade with particular countries by means of privileged companies, which professed to regulate the trade according to the state of the market so as to secure its steady development in the interest of producers and traders—was seriously called in question under the Stuarts and at the Revolution, the interlopers and opponents of the companies insisted on the advantages of a "Free Trade"; they meant by this that the various branches of commerce should not be confined to particular persons or limited in amount, but should be thrown open to be pursued by any Englishman in the way he thought most profitable himself.¹ Again, in the latter half of the 18th

¹ E. Misselden, *Free Trade or the Means to make Trade Flourish* (1622), p. 68; G. Malynes, *The Maintenance of Free Trade* (1622), p. 105.

² H. Parker, *Of a Free Trade* (1648), p. 8.

century, till Pitt's financial reforms¹ were brought into operation, the English customs duties on wine and brandy were excessive; and those who carried on a remunerative business by evading these duties were known as Fair Traders or Free Traders.² Since 1846 the term free trade has been popularly used, in England, to designate the policy of Cobden (*q.v.*) and others who advocated the abolition of the tax on imported corn (see CORN LAWS); this is the only one of the specialized senses of the term which is at all likely to be confused with the economic doctrine. The Anti-Corn Law movement was, as a matter of fact, a special application of the economic principle; but serious mistakes have arisen from the blunder of confusing the part with the whole, and treating the remission of one particular duty as if it were the essential element of a policy in which it was only an incident. W. E. Gladstone, in discussing the effect of improvements in locomotion on British trade, showed what a large proportion of the stimulus to commerce during the 19th century was to be credited to what he called the "liberalizing legislation" of the free-trade movement in the wide sense in which he used the term. "I rank the introduction of cheap postage for letters, documents, patterns and printed matter, and the abolition of all taxes on printed matter, in the category of Free Trade Legislation. Not only thought in general, but every communication, and every publication, relating to matters of business, was thus set free. These great measures, then, may well take their place beside the abolition of prohibitions and protective duties, the simplifying of revenue laws, and the repeal of the Navigation Act, as forming together the great code of industrial emancipation. Under this code, our race, restored to freedom in mind and hand, and braced by the powerful stimulus of open competition with the world, has upon the whole surpassed itself and every other, and has won for itself a commercial primacy more evident, more comprehensive, and more solid than it had at any previous time possessed."³ In this large sense free trade may be almost interpreted as the combination of the doctrines of the division of labour and of *laissez-faire* in regard to the world as a whole. The division of labour between different countries of the world—so that each concentrates its energies in supplying that for the production of which it is best fitted—appears to offer the greatest possibility of production; but this result cannot be secured unless trade and industry are treated as the primary elements in the welfare of each community, and political considerations are not allowed to hamper them.

Stated in its simplest form, the principle which underlies the doctrine of free trade is almost a truism; it is directly deducible from the very notion of exchange (*q.v.*). Adam Smith and his successors have demonstrated that in every case of voluntary exchange each party gains something that is of greater value-in-use to him than that with which he parts, and that consequently in every exchange, either between individuals or between nations, both parties are the gainers. Hence it necessarily follows that, since both parties gain through exchanging, the more facilities there are for exchange the greater will be the advantage to every individual all round.⁴ There is no difficulty in translating this principle into the terms of actual life, and stating the conditions in which it holds good absolutely. If, at any given moment, the mass of goods in the world were distributed among the consumers with the minimum of restriction on interchange, each competitor would obtain the largest possible share of the things he procures in the world's market. But the argument is less conclusive when the element of time is taken into account; what is true of each moment separately is not necessarily true of any period in which the conditions of production, or the requirements of communities, may possibly change. Each individual is likely to act with reference to his own future, but

it may often be wise for the statesman to look far ahead, beyond the existing generation.⁵ Owing to the neglect of this element of time, and the allowance which must be made for it, the reasoning as to the advantages of free trade, which is perfectly sound in regard to the distribution of goods already in existence, may become sophistical,⁶ if it is put forward as affording a complete demonstration of the benefits of free trade as a regular policy. After all, human society is very complex, and any attempt to deal with its problems off-hand by appealing to a simple principle raises the suspicion that some important factor may have been left out of account. When there is such mistaken simplification, the reasoning may seem to have complete certainty, and yet it fails to produce conviction, because it does not profess to deal with the problem in all its aspects. When we concentrate attention on the phenomena of exchange, we are viewing society as a mechanism in which each acts under known laws and is impelled by one particular force—that of self-interest; now, society is, no doubt, in this sense a mechanism, but it is also an organism,⁷ and it is only for very short periods, and in a very limited way, that we can venture to neglect its organic character without running the risk of falling into serious mistakes.

The doctrine of free trade maintains that in order to secure the greatest possible mass of goods in the world as a whole, and the greatest possibility of immediate comfort for the consumer, it is expedient that there should be no restriction on the exchange of goods and services either between individuals or communities. The controversies in regard to this doctrine have not turned on its certainty as a hypothetical principle, but on the legitimacy of the arguments based upon it. It certainly supplies a principle in the light of which all proposed trade regulations should be criticized. It gives us a basis for examining and estimating the expense at which any particular piece of trade restriction is carried out; but thus used, the principle does not necessarily condemn the expenditure; the game may be worth the candle or it may not, but at least it is well that we should know how fast the candle is being burnt. It was in this critical spirit that Adam Smith examined the various restrictions and encouragements to trade which were in vogue in his day; he proved of each in turn that it was expensive, but he showed that he was conscious that the final decision could not be taken from this standpoint, since he recognized in regard to the Navigation Acts that "defence is more than opulence."⁸ In more recent times, the same sort of attitude was taken by Henry Sidgwick,⁹ who criticizes various protective expedients in turn, in the light of free trade, but does not treat it as conveying an authoritative decision on their merits.

But other exponents of the doctrine have not been content to employ it in this fashion. They urge it in a more positive manner, and insist that free trade pure and simple is the foundation on which the economic life of the community ought to be based. By men who advocate it in this way, free trade is set forward as an ideal which it is a duty to realize, and those who hold aloof from it or oppose it have been held up to scorn as if they were almost guilty of a crime.¹⁰ The development of the material resources of the world is undoubtedly an important element in the welfare of mankind; it is an aim which is common to the whole race, and may be looked upon as contributing to the greatest happiness of the greatest number. Competition in the open market seems to secure that each consumer shall obtain the best possible terms; and again, since all men are consumers whether they produce or not, or whatever they produce, the greatest measure of comforts for each seems likely to be attainable on these lines. For those who are frankly cosmopolitan, and who regard material prosperity as at all events the prime object at which public policy should aim, the free-trade doctrine is readily

¹ Schmoller, *Grundriss der allgemeinen Volkswirtschaftslehre* (1904), ii. 607.

² Byles, *Sophisms of Free Trade*; L. S. Amery, *Fundamental Fallacies of Free Trade*, 13.

³ W. Cunningham, *Rise and Decline of the Free Trade Movement*, pp. 5-11.

⁴ *Wealth of Nations*, book iv. chap. ii.

⁵ *Principles of Political Economy*, 483.

⁶ J. Morley, *Life of Cobden*, i. 230.

¹ (1787), 27 Geo. III. c. 13.

² Sir Walter Scott, *Guy Mannering*, chapter v.

³ Gladstone, "Free Trade, Railways and Commerce," in *Nineteenth Century* (Feb. 1880), vol. vii. p. 370.

⁴ Parker states a similar argument in the form in which it suited the special problem of his day. "If merchandise be good for the commonweal, then the more common it is made, the more open it is laid, the more good it will convey to us." *Op. cit.* 20.

transformed, from a mere principle of criticism, till it comes to be regarded as the harbinger of a possible Utopia. It was in this fashion that it was put forward by French economists and proved attractive to some leading American statesmen in the 18th century. Turgot regarded the colonial systems of the European countries as at once unfair to their dependencies and dangerous to the peace of the world. "It will be a wise and happy thing for the nation which shall be the first to modify its policy according to the new conditions, and be content to regard its colonies as if they were allied provinces and not subjects of the mother country." It will be a wise and happy thing for the nation which is the first to be convinced that the secret of "success, so far as commercial policy is concerned, consists in employing all its land in the manner most profitable for the proprietary, all the hands in the manner most advantageous to the workman personally, that is to say, in the manner in which each would employ them, if we could let him be simply directed by his own interest, and that all the rest of the mercantile policy is vanity and vexation of spirit. When the entire separation of America shall have forced the whole world to recognize this truth and purged the European nations of commercial jealousy there will be one great cause of war less in the world."¹ Pitt, under the influence of Adam Smith, was prepared to admit the United States to the benefit of trade with the West Indian Colonies; and Jefferson, accepting the principles of his French teachers, would (in contradistinction to Alexander Hamilton) have been willing to see his country renounce the attempt to develop manufactures of her own.² It seemed as if a long step might be taken towards realizing the free-trade ideal for the Anglo-Saxon race; but British shipowners insisted on the retention of their privileges, and the propitious moment passed away with the failure of the negotiations of 1783.³ Free trade ceased to be regarded as a gospel, even in France, till the ideal was revived in the writings of Bastiat, and helped to mould the enthusiasm of Richard Cobden.⁴ Through his zealous advocacy, the doctrine secured converts in almost every part of the world; though it was only in Great Britain that a great majority of the citizens became so far satisfied with it that they adopted it as the foundation of the economic policy of the country.

It is not difficult to account for the conversion of Great Britain to this doctrine; in the special circumstances of the first half of the 19th century it was to the interest of the most vigorous factors in the economic life of the country to secure the greatest possible freedom for commercial intercourse. Great Britain had, through her shipping, access to all the markets of the world; she had obtained such a lead in the application of machinery to manufactures that she had a practical monopoly in textile manufactures and in the hardware trades; by removing every restriction, she could push her advantage to its farthest extent, and not only undersell native manufactures in other lands, but secure food, and the raw materials for her manufactures, on the cheapest possible terms. Free trade thus seemed to offer the means of placing an increasing distance between Britain and her rivals, and of rendering the industrial monopoly which she had attained impregnable. The capitalist employer had superseded the landowner as the mainstay of the resources and revenue of the realm, and insisted that the prosperity of manufactures was the primary interest of the community as a whole. The expectation, that a thoroughgoing policy of free trade would not only favour an increase of employment, but also the cheapening of food, could only have been roused in a country which was

¹ "Mémoire," 6 April 1776, in *Cœuvres*, viii. 460.

² Jefferson, *Notes on Virginia*, 275. See also the articles on JEFFERSON and HAMILTON, ALEXANDER.

³ One incidental effect of the failure to secure free trade was that the African slave trade, with West Indies as a depot for supplying the American market, ceased to be remunerative, and the opposition to the abolition of the trade was very much weaker than it would otherwise have been; see Hochstetter, "Die wirtschaftlichen und politischen Motive für die Abschaffung des britischen Sklavenhandels," in Schmoller, *Staats und Sozialwissenschaftliche Forschungen*, xiv. i. 37.

⁴ J. Welsford, "Cobden's Foreign Teacher," in *National Review* (December 1905).

obliged to import a considerable amount of corn. The exceptional weakness, as well as the exceptional strength, of Great Britain, among European countries, made it seem desirable to adopt the principle of unrestricted commercial intercourse, not merely in the tentative fashion in which it had been put in operation by Huskisson, but in the thoroughgoing fashion in which it at last commended itself to the minds of Peel and Gladstone. The "Manchester men" saw clearly where their interest lay; and the fashionable political economy was ready to demonstrate that in pursuing their own interest they were conferring the benefit of cheap clothing on all the most poverty-stricken races of mankind. It seemed probable, in the 'forties and early 'fifties, that other countries would take a similar view of their own interests and would follow the example which Great Britain had set.⁵ That they have not done so, is partly due to the fact that none of them had such a direct, or such a widely diffused, interest in increased commercial intercourse as existed in Great Britain; but their reluctance has been partly the result of the criticism to which the free-trade doctrine has been subjected. The principles expressed in the writings of Friedrich List have taken such firm hold, both in America and in Germany, that these countries have preferred to follow on the lines by which Great Britain successfully built up her industrial prosperity in the 17th and 18th century, rather than on those by which they have seen her striving to maintain it since 1846.

Free trade was attractive as an ideal, because it appeared to offer the greatest production of goods to the world as a whole, and the largest share of material goods to each consumer; it is cosmopolitan, and it treats consumption, and the interest of the consumer, as such, as the end to be considered. Hence it lies open to objections which are partly political and partly economic.

As cosmopolitan, free-trade doctrine is apt to be indifferent to national tradition and aspiration. In so far indeed as patriotism is a mere aesthetic sentiment, it may be tolerated, but in so far as it implies a genuine wish and intention to preserve and defend the national habits and character to the exclusion of alien elements, the cosmopolitan mind will condemn it as narrow and mischievous. In the first half of the 19th century there were many men who believed that national ambitions and jealousies of every kind were essentially dynamic, and that if monarchies were abolished there would be fewer occasions of war, so that the expenses of the business of government would be enormously curtailed. For Cobden and his contemporaries it was natural to regard the national administrative institutions as maintained for the benefit of the "classes" and without much advantage to the "masses." But in point of fact, modern times have shown the existence in democracies of a patriotic sentiment which is both exclusive and aggressive; and the burden of armaments has steadily increased. It was by means of a civil war that the United States attained to a consciousness of national life; while such later symptoms as the recent interpretations of the Monroe doctrine, or the war with Spain, have proved that the citizens of that democratic country cannot be regarded as destitute of self-aggrandizing national ambition.

In Germany the growth of militarism and nationalism have gone on side by side under constitutional government, and certainly in harmony with predominant public opinion. Neither of these communities is willing to sink its individual conception of progress in those of the world at large; each is jealous of the intrusion of alien elements which cannot be reconciled with its own political and social system. And a similar recrudescence of patriotic feeling has been observable in other countries, such as Norway and Hungary; the growth of national sentiment is shown, not only in the attempts to revive and popularize the use of a national language, but still more decidedly in the determination to have a real control over the economic life of the country. It is here that the new patriotism comes into direct conflict with the political principles of free trade as advocated by Bastiat and Cobden; for them the important point was that countries, by becoming dependent on one another, would be prevented from engaging in hostilities. The new nations are

⁵ *Compatriot Club Lectures* (1905), p. 306.

determined that they will not allow other countries to have such control over their economic condition, as to be able to exercise a powerful influence on their political life. Each is determined to be the master in his own house, and each has rejected free trade because of the cosmopolitanism which it involves.

Economically, free trade lays stress on consumption as the chief criterion of prosperity. It is, of course, true that goods are produced with the object of being consumed, and it is plausible to insist on taking this test; but it is also true that consumption and production are mutually interdependent, and that in some ways production is the more important of the two. Consumption looks to the present, and the disposal of actual goods; production looks to the future, and the conditions under which goods can continue to be regularly provided and thus become available for consumption in the long run. As regards the prosperity of the community in the future it is important that goods should be consumed in such a fashion as to secure that they shall be replaced or increased before they are used up; it is the amount of production rather than the amount of consumption that demands consideration, and gives indication of growth or of decadence. In these circumstances there is much to be said for looking at the economic life of a country from the point of view which free-traders have abandoned or ignore. It is not on the possibilities of consumption in the present, but on the prospects of production in the future, that the continued wealth of the community depends; and this principle is the only one which conforms to the modern conception of the essential requirements of sociological science in its wider aspect (see SOCIOLOGY). This is most obviously true in regard to countries of which the resources are very imperfectly developed. If their policy is directed to securing the greatest possible comfort for each consumer in the present, it is certain that progress will be slow; the planting of industries for which the country has an advantage may be a tedious process; and in order to stimulate national efficiency temporary protection—involving what is otherwise unnecessary immediate cost to the consumer—may seem to be abundantly justified. Such a free trader as John Stuart Mill himself admits that a case may be made out for treating "infant industries" as exceptions;¹ and if this exception be admitted it is likely to establish a precedent. After all, the various countries of the world are all in different stages of development; some are old and some are new; and even the old countries differ greatly in the progress they have made in distinct arts. The introduction of machinery has everywhere changed the conditions of production, so that some countries have lost and others have gained a special advantage. Most of the countries of the world are convinced that the wisest economy is to attend to the husbanding of their resources of every kind, and to direct their policy not merely with a view to consumption in the present, but rather with regard to the possibilities of increased production in the future.

This deliberate rejection of the doctrine of free trade between nations, both in its political and economic aspects, has not interfered, however, with the steady progress of free commercial intercourse within the boundaries of a single though composite political community. "Internal free trade," though the name was not then current in this sense, was one of the burning questions in England in the 17th century; it was perhaps as important a factor as puritanism in the fall of Charles I. Internal free trade was secured in France in the 18th century; thanks to Hamilton,² it was embodied in the constitution of the United States; it was introduced into Germany by Bismarck; and was firmly established in the Dominion of Canada and the Commonwealth of Australia. It became in consequence, where practicable, a part of the modern federal idea as usually interpreted. There are thus great areas, externally self-protecting, where free trade, as between internal divisions, has been introduced with little, if any, political difficulty, and with considerable economic advantage. These cases are sometimes quoted as justifying the expectation that the same principle is likely to be adopted sooner or later in regard to external trading relations. There

¹ J. S. Mill, *Principles of Political Economy*, book v. chapter x. § 1.

² F. S. Oliver, *Alexander Hamilton*, 142.

is some reason, however, for raising the question whether free trade has been equally successful, not only in its economic, but in its social results, in all the large political communities where it has been introduced. In a region like the United States of America, it is probably seen at its best; there is an immense variety of different products throughout that great zone of the continent, so that the mutual co-operation of the various parts is most beneficial, while the standard of habit and comfort is so far uniform³ throughout the whole region, and the facilities for the change of employment are so many, that there is little injurious competition between different districts. In the British empire the conditions are reversed; but though the great self-governing colonies have withdrawn from the circle, in the hope of building up their own economic life in their own way, free trade is still maintained over a very large part of the British empire. Throughout this area, there are very varied physical conditions; there is also an extraordinary variety of races, each with its own habits, and own standard of comfort; and in these circumstances it may be doubted whether the free competition, involved in free trade, is really altogether wholesome. Within this sphere the ideal of Bastiat and his followers is being realized. England, as a great manufacturing country, has more than held her own; India and Ireland are supplied with manufactured goods by England, and in each case the population is forced to look to the soil for its means of support, and for purchasing power. In each case the preference for tillage, as an occupation, has rendered it comparatively easy to keep the people on the land; but there is some reason to believe that the law of diminishing returns is already making itself felt, at all events in India, and is forcing the people into deeper poverty.⁴ It may be doubtful in the case of Ireland how far the superiority of England in industrial pursuits has prevented the development of manufactures; the progress in the last decades of the 18th century was too short-lived to be conclusive; but there is at least a strong impression in many quarters that the industries of Ireland might have flourished if they had had better opportunities allowed them.⁵ In the case of India we know that the hereditary artistic skill, which had been built up in bygone generations, has been stamped out. It seems possible that the modern unrest in India, and the discontent in Ireland, may be connected with the economic conditions in these countries, on which free trade has been imposed without their consent. So far the population which subsists on the cheaper food, and has the lower standard of life, has been the sufferer; but the mischief might operate in another fashion. The self-governing colonies at all events feel that competition in the same market between races with different standards of comfort has infinite possibilities of mischief. It is easy to conjure up conditions under which the standard of comfort of wage-earners in England would be seriously threatened.

Since the 9th edition of the *Encyclopaedia Britannica* was published it has become clear that the free-trade doctrines of Bastiat and Cobden have not been gaining ground in the world at large, and at the opening of the 20th century it could hardly be said with confidence that the question was "finally settled" so far as England was concerned. As to whether the interests of Great Britain still demanded that she should continue on the line she adopted in the exceptional conditions of the middle of the 19th century, expert opinion was conspicuously divided;⁶ but there remained no longer the old enthusiasm for free trade as

³ The standard is, of course, lower among the negroes and mean whites in the South than in the North and West.

⁴ F. Beaucerik, "Free Trade in India," in *Economic Review* (July 1907), xvii, 284.

⁵ A. E. Murray, *History of the Commercial and Financial Relations between England and Ireland*, 294.

⁶ For the tariff reform movement in English politics see the article on CHAMBERLAIN, J. Among continental writers G. Schmoller (*Grundriss der allgemeinen Volkswirtschaftslehre*, ii. 641) and A. Wagner (Preface to M. Schwab's *Chamberlains Handelspolitik*) pronounce in favour of a change, as Fuchs did by anticipation. Schulze-Gaevernitz (*Britischer Imperialismus und englischer Freihandel*), Aubry (*Étude critique de la politique commerciale de l'Angleterre à l'égard de ses colonies*), and Blondel (*La politique Protectionniste en Angleterre un nouveau danger pour la France*) are against it.

the harbinger of an Utopia. The old principles of the bourgeois manufacturers had been taken up by the proletariat and shaped to suit themselves. Socialism, like free trade, is cosmopolitan in its aims, and is indifferent to patriotism and hostile to militarism. Socialism, like free trade, insists on material welfare as the primary object to be aimed at in any policy, and, like free trade, socialism tests welfare by reference to possibilities of consumption. In one respect there is a difference; throughout Cobden's attack on the governing classes there are signs of his jealousy of the superior status of the landed gentry, but socialism has a somewhat wider range of view and demands "equality of opportunity" with the capitalist as well.

BIBLIOGRAPHY.—Reference has already been made to the principal works which deal critically with the free-trade policy. Professor Fawcett's *Free Trade* is a good exposition of free-trade principles; so also is Professor Bastable's *Commerce of Nations*. Among authors who have restated the principles with special reference to the revived controversy on the subject may be mentioned Professor W. Smart, *The Return to Protection, being a Re-statement of the Case for Free Trade* (2nd ed., 1906), and A. C. Figou, *Protective and Preferential Import Duties* (1906). (W. Cu.)

FREGELLAE, an ancient town of Latium adiectum, situated on the Via Latina, 11 m. W. N. W. of Aquinum, near the left branch of the Liris. It is said to have belonged in early times to the Opici or Oscans, and later to the Volscians. It was apparently destroyed by the Samnites a little before 330 B.C., in which year the people of Fabratia Vetus (mod. Ceccano) besought the help of Rome against them, and in 328 B.C. a Latin colony was established there. The place was taken in 320 B.C. by the Samnites, but re-established by the Romans in 313 B.C. It continued henceforward to be faithful to Rome; by breaking the bridges over the Liris it interposed an obstacle to the advance of Hannibal on Rome in 212 B.C., and it was a native of Fregellae who headed the deputation of the non-revolting colonies in 209 B.C. It appears to have been a very important and flourishing place owing to its command of the crossing of the Liris, and to its position in a fertile territory, and it was here that, after the rejection of the proposals of M. Fulvius Flaccus for the extension of Roman burgess-rights in 125 B.C., a revolt against Rome broke out. It was captured by treachery in the same year and destroyed; but its place was taken in the following year by the colony of Fabratia Nova, 3 m. to the S.E. on the opposite bank of the Liris, while a post station Fregellanum (mod. Ceprano) is mentioned in the itineraries; Fregellae itself, however, continued to exist as a village even under the empire. The site is clearly traceable about $\frac{1}{2}$ m. E. of Ceprano, but the remains of the city are scanty.

See G. Colasanti, *Fregellae, storia e topografia* (1906). (T. As.)

FREIBERG, or **FREYBERG**, a town of Germany in the kingdom of Saxony, on the Müntzbach, near its confluence with the Mulde, 19 m. S.W. of Dresden on the railway to Chemnitz, with a branch to Nossen. Pop. (1905) 30,896. Its situation, on the rugged northern slope of the Erzgebirge, is somewhat bleak and uninviting, but the town is generally well built and makes a prosperous impression. A part of its ancient walls still remains; the other portions have been converted into public walks and gardens. Freiberg is the seat of the general administration of the mines throughout the kingdom, and its celebrated mining academy (*Bergakademie*), founded in 1765, is frequented by students from all parts of the world. Connected with it are extensive collections of minerals and models, a library of 50,000 volumes, and laboratories for chemistry, metallurgy and assaying. Among its distinguished scholars it reckons Abraham Gottlob Werner (1750-1817), who was also a professor there, and Alexander von Humboldt. Freiberg has extensive manufactures of gold and silver lace, woollen cloths, linen and cotton goods, iron, copper and brass wares, gunpowder and white-lead. It has also several large breweries. In the immediate vicinity are its famous silver and lead mines, thirty in number, and of which the principal ones passed into the property of the state in 1886. The castle of Freudenstein or Freistein, as rebuilt by the elector Augustus in 1572, is situated in one of the suburbs and is now used as a military magazine. In its grounds a monument was erected to Werner in 1851. The cathedral, rebuilt in late Gothic style

after its destruction by fire in 1484 and restored in 1893, was founded in the 12th century. Of the original church a magnificent German Romanesque doorway, known as the Golden Gate (*Goldene Pforte*), survives. The church contains numerous monuments, among others one to Prince Maurice of Saxony. Adjoining the cathedral is the mausoleum (*Begräbniskapelle*), built in 1504 in the Italian Renaissance style, in which are buried the remains of Henry the Pious and his successors down to John George IV., who died in 1694. Of the other four Protestant churches the most noteworthy is the Peterskirche which, with its three towers, is a conspicuous object on the highest point of the town. Among the other public buildings are the old town-hall, dating from the 15th century, the antiquarian museum, and the natural history museum. There are a classical and modern, a commercial and an agricultural school, and numerous charitable institutions.

Freiberg owes its origin to the discovery of its silver mines (c. 1163). The town, with the castle of Freudenstein, was built by Otto the Rich, margrave of Meissen, in 1175, and its name, which first appears in 1221, is derived from the extensive mining franchises granted to it about that time. In all the partitions of the territories of the Saxon house of Wettin, from the latter part of the 13th century onward, Freiberg always remained common property, and it was not till 1485 (the mines not till 1537) that it was definitively assigned to the Albertine line. The Reformation was introduced into Freiberg in 1536 by Henry the Pious, who resided here. The town suffered severely during the Thirty Years' War, and again during the French occupation from 1806 to 1814, during which time it had to support an army of 700,000 men and find forage for 200,000 horses.

See H. Gerlach, *Kleine Chronik von Freiberg* (2nd ed., Freiberg, 1898); H. Ermisch, *Das Freiburger Stadtrecht* (Leipzig, 1889); Ermisch and O. Posse, *Urkundenbuch der Stadt Freiberg*, in *Codex diplom. Sax. reg.* (3 vols., Leipzig, 1883-1891); *Freibergs Berg- und Hüttenwesen*, published by the Bergmännischer Verein (Freiberg, 1883); Ledebur, *Über die Bedeutung der Freiburger Bergakademie* (ib. 1903); Steche, *Bau- und Kunstdenkmäler der Amtshauptmannschaft Freiberg* (Dresden, 1884).

FREIBURG, a town of Germany in Prussian Silesia, on the Polnitz, 35 m. S.W. of Breslau, on the railway to Halbstadt. Pop. (1905) 9917. It has an Evangelical and Roman Catholic church, and its industries include watch-making, linen-weaving and distilling. In the neighbourhood are the old and modern castles of the Fürstenstein family, whence the town is sometimes distinguished as Freiburg unter dem Fürstenstein. At Freiburg, on the 22nd of July 1762, the Prussians defended themselves successfully against the superior forces of the Austrians.

FREIBURG IM BREISGAU, an archiepiscopal see and city of Germany in the grand duchy of Baden, 12 m. E. of the Rhine, beautifully situated on the Dreisam at the foot of the Schlossberg, one of the heights of the Black Forest range, on the railway between Basel and Mannheim, 40 m. N. of the former city. Pop. (1905) 76,285. The town is for the most part well built, having several wide and handsome streets and a number of spacious squares. It is kept clean and cool by the waters of the river, which flow through the streets in open channels; and its old fortifications have been replaced by public walks, and, what is more unusual, by vineyards. It possesses a famous university, the Ludovica Albertina, founded by Albert VI., archduke of Austria, in 1457, and attended by about 2000 students. The library contains upwards of 250,000 volumes and 600 MSS., and among the other auxiliary establishments are an anatomical hall and museum and botanical gardens. The Freiburg minster is considered one of the finest of all the Gothic churches of Germany, being remarkable alike for the symmetry of its proportions, for the taste of its decorations, and for the fact that it may more correctly be said to be finished than almost any other building of the kind. The period of its erection probably lies for the most part between 1122 and 1252; but the choir was not built till 1513. The tower, which rises above the western entrance, is 386 ft. in height, and it presents a skilful transition from a square base into an octagonal superstructure, which in its turn is surmounted by a pyramidal spire of the most

exquisite open work in stone. In the interior of the church are some beautiful stained glass windows, both ancient and modern, the tombstones of several of the dukes of Zähringen, statues of archbishops of Freiburg, and paintings by Holbein and by Hans Baldung (c. 1470-1545), commonly called Grün. Among the other noteworthy buildings of Freiburg are the palaces of the grand duke and the archbishop, the old town-hall, the theatre, the *Kaufhaus* or merchants' hall, a 16th-century building with a handsome façade, the church of St Martin, with a graceful spire restored 1880-1881, the new town-hall, completed 1901, in Renaissance style, and the Protestant church, formerly the church of the abbey of Thennenbach, removed hither in 1839. In the centre of the fish-market square is a fountain surmounted by a statue of Duke Berthold III. of Zähringen; in the Franziskaner Platz there is a monument to Berthold Schwarz, the traditional discoverer here, in 1259, of gunpowder; the Rotteck Platz takes its name from the monument of Karl Wenzeslaus von Rotteck (1775-1840), the historian, which formerly stood on the site of the Schwarz statue; and in Kaiser Wilhelm Strasse a bronze statue was erected in 1876 to the memory of Herder, who in the early part of the 19th century founded in Freiburg an institute for draughtsmen, engravers and lithographers, and carried on a famous bookselling business. On the Schlossberg above the town there are massive ruins of two castles destroyed by the French in 1744; and about 2 m. to the N.E. stands the castle of Zähringen, the original seat of the famous family of the counts of that name. Situated on the ancient road which runs by the Höllenpass between the valleys of the Danube and the Rhine, Freiburg early acquired commercial importance, and it is still the principal centre of the trade of the Black Forest. It manufactures buttons, chemicals, starch, leather, tobacco, silk thread, paper, and hempen goods, as well as beer and wine.

Freiburg is of uncertain foundation. In 1120 it became a free town, with privileges similar to those of Cologne; but in 1210 it fell into the hands of a branch of the family of Urach. After it had vainly attempted to throw off the yoke by force of arms, it purchased its freedom in 1366; but, unable to reimburse the creditors who had advanced the money, it was, in 1368, obliged to recognize the supremacy of the house of Hapsburg. In the 17th and 18th centuries it played a considerable part as a fortified town. It was captured by the Swedes in 1632, 1634 and 1638; and in 1644 it was seized by the Bavarians, who shortly after, under General Mercy, defeated in the neighbourhood the French forces under Enghien and Turenne. The French were in possession from 1677 to 1697, and again in 1713-1714 and 1744; and when they left the place in 1748, at the peace of Aix-la-Chapelle, they dismantled the fortifications. The Baden insurgents gained a victory at Freiburg in 1848, and the revolutionary government took refuge in the town in June 1849, but in the following July the Prussian forces took possession and occupied it until 1851. Since 1821 Freiburg has been the seat of an archbishop with jurisdiction over the sees of Mainz, Rottenberg and Limburg.

See Schreiber, *Geschichte und Beschreibung des Münsters zu Freiburg* (1820 and 1825); *Geschichte der Stadt und Universität Freiburg* (1857-1859); *Der Schlossberg bei Freiburg* (1860); and Albert, *Die Geschichtsschreibung der Stadt Freiburg* (1902).

Battles of Freiburg, 3rd, 5th and 10th of August 1644.—During the Thirty Years' War the neighbourhood of Freiburg was the scene of a series of engagements between the French under Louis de Bourbon, duc d'Enghien (afterwards called the great Condé), and Henri de la Tour d'Auvergne, vicomte de Turenne, and the Bavarians and Austrians commanded by Franz, Freiherr von Mercy.

At the close of the campaign of 1643 the French "Army of Weimar," having been defeated and driven into Alsace by the Bavarians, had there been reorganized under the command of Turenne, then a young general of thirty-two and newly promoted to the marshalate. In May 1644, he opened the campaign by recrossing the Rhine and raiding the enemy's posts as far as Überlingen on the lake of Constance and Donaueschingen on

the Danube. The French then fell back with their booty and prisoners to Breisach, a strong garrison being left in Freiburg. The Bavarian commander, however, revenged himself by besieging Freiburg (June 27th), and Turenne's first attempt to relieve the place failed. During July, as the siege progressed, the French government sent the duc d'Enghien, who was ten years younger still than Turenne, but had just gained his great victory of Rocroy, to take over the command. Enghien brought with him a veteran army, called the "Army of France," Turenne remaining in command of the Army of Weimar. The armies met at Breisach on the 2nd of August, by which date Freiburg had surrendered. At this point most commanders of the time would have decided not to fight, but to manoeuvre Mercy away from Freiburg; Enghien, however, was a fighting general, and Mercy's entrenched lines at Freiburg seemed to him a target rather than an obstacle. A few hours after his arrival, therefore, without waiting for the rearmost troops of his columns, he set the combining armies in motion for Krozingen, a village on what was then the main road between Breisach and Freiburg. The total force immediately available numbered only 16,000 combatants. Enghien and Turenne had arranged that the Army of France was to move direct upon Freiburg by Wolfenweiler, while the Army of Weimar was to make its way by hillside tracks to Wittnau and thence to attack the rear of Mercy's lines while Enghien assaulted them in front. Turenne's march (August 3rd, 1644) was slow and painful, as had been anticipated, and late in the afternoon, on passing Wittnau, he encountered the enemy. The Weimarians carried the outer lines of defence without much difficulty, but as they pressed on towards Merzhausen the resistance became more and more serious. Turenne's force was little more than 6000, and these were wearied with a long day of marching and fighting on the steep and wooded hillsides of the Black Forest. Thus the turning movement came to a standstill far short of Uffingen, the village on Mercy's line of retreat that Turenne was to have seized, nor was a flank attack possible against Mercy's main line, from which he was separated by the crest of the Schönberg. Meanwhile, Enghien's army had at the prearranged hour (4 P.M.) attacked Mercy's position on the Ebringen spur. A steep slope, vineyards, low stone walls and abatis had all to be surmounted, under a galling fire from the Bavarian musketeers, before the Army of France found itself, breathless and in disorder, in front of the actual entrenchments of the crest. A first attack failed, as did an attempt to find an unguarded path round the shoulder of the Schönberg. The situation was grave in the extreme, but Enghien resolved on Turenne's account to renew the attack, although only a quarter of his original force was still capable of making an effort. He himself and all the young nobles of his staff dismounted and led the infantry forward again, the prince threw his baton into the enemy's lines for the soldiers to retrieve, and in the end, after a bitter struggle, the Bavarians, whose reserves had been taken away to oppose Turenne in the Merzhausen defile, abandoned the entrenchments and disappeared into the woods of the adjoining spur. Enghien hurriedly re-formed his troops, fearing at every moment to be hurled down the hill by a counterstroke; but none came. The French bivouacked in the rain, Turenne making his way across the mountain to confer with the prince, and meanwhile Mercy quietly drew off his army in the dark to a new set of entrenchments on the ridge on which stood the Loretto Chapel. On the 4th of August the Army of France and the Army of Weimar met at Merzhausen, the rearmost troops of the Army of France came in, and the whole was arranged by the major-generals in the plain facing the Loretto ridge. This position was attacked on the 5th. Enghien had designed his battle even more carefully than before, but as the result of a series of accidents the two French armies attacked prematurely and straight to their front, one brigade after another, and though at one moment Enghien, sword in hand, broke the line of defence with his last intact reserve, a brilliant counterstroke, led by Mercy's brother Kaspar (who was killed), drove out the assailants. It is said that Enghien lost half his men on this day and Mercy one-third of his, so severe was the battle. But the result could

not be gainsaid; it was for the French a complete and costly failure.

For three days after this the armies lay in position without fighting, the French well supplied with provisions and comforts from Breisach, the Bavarians suffering somewhat severely from want of food, and especially forage, as all their supplies had to be hauled from Villingen over the rough roads of the Black Forest. Enghien then decided to make use of the Glotter Tal to interrupt altogether this already unsatisfactory line of supply, and thus to force the Bavarians either to attack him at a serious disadvantage, or to retreat across the hills with the loss of their artillery and baggage and the disintegration of their army by famine and desertion. With this object, the Army of Weimar was drawn off on the morning of the 9th of August and marched round by Betzenhausen and Lehen to Langen Denzling. The infantry of the Army of France, then the trains, followed, while Enghien with his own cavalry faced Freiburg and the Loretto position.

Before dawn on the 10th the advance guard of Turenne's army was ascending the Glotter Tal. But Mercy had divined his



adversary's plan, and leaving a garrison to hold Freiburg, the Bavarian army had made a night march on the 9/10th to the Abbey of St Peter, whence on the morning of the 10th Mercy fell back to Graben, his nearest magazine in the mountains. Turenne's advanced guard appeared from the Glotter Tal only to find a stubborn rearguard of cavalry in front of the abbey. A sharp action began, but Mercy hearing the drums and fifes of the French infantry in the Glotter Tal broke it off and continued his retreat in good order. Enghien thus obtained little material result from his manoeuvre. Only two guns and such of Mercy's wagons that were unable to keep up fell into the hands of the French. Enghien and Turenne did not continue the chase farther than Graben, and Mercy fell back unmolested to Rothenburg on the Tauber.

The moral results of this sanguinary fighting were, however, important and perhaps justified the sacrifice of so many valuable soldiers. Enghien's pertinacity had not achieved a decision with the sword, but Mercy had been so severely punished that he was unable to interfere with his opponent's new plan of campaign. This, which was carried out by the united armies and by reinforcements from France, while Turenne's cavalry screened them by bold demonstrations on the Tauber, led to nothing less than the conquest of the Rhine Valley from Basel to Coblenz, a task which was achieved so rapidly that the Army of France and its victorious young leader were free to return to France in two months from the time of their appearance in Turenne's quarters at Breisach.

FREIDANK (FREIDANC), the name by which a Middle High German didactic poet of the early 13th century is known. It has been disputed whether the word, which is equivalent to "free-thought," is to be regarded as the poet's real name or only as a pseudonym; the latter is probably the case. Little is known of Freidank's life. He accompanied Frederick II. on his crusade to the Holy Land, where, in the years 1228-1229, a portion at least of his work was composed; and it is said that on his tomb (if indeed it was not the tomb of another Freidank) at Treviso, there was inscribed, with allusion to the character of his style, "he always spoke and never sang." Wilhelm Grimm originated the hypothesis that Freidank was to be identified with Walther von der Vogelweide; but this is no longer tenable. Freidank's work bears the name of *Bescheidenheit*, i.e. "practical wisdom," "correct judgment," and consists of a collection of proverbs, pithy sayings, and moral and satirical reflections, arranged under general heads. Its popularity till the end of the 16th century is shown by the great number of MSS. extant.

Sebastian Brant published the *Bescheidenheit* in a modified form in 1508. Wilhelm Grimm's edition appeared in 1834 (2nd ed. 1860). H. F. Bezzenberger's in 1872. A later edition is by F. Sandvoß (1877). The old Latin translation, *Freidanki Discretio*, was printed by C. Lemcke in 1868; and there are two translations into modern German, A. Bacmeister's (1861) and K. Simrock's (1867). See also F. Pfeiffer, *Über Freidank (Zur deutschen Literaturgeschichte)*, 1855, and H. Paul, *Über die ursprüngliche Anordnung von Freidank's Bescheidenheit* (1870).

FREIENWALDE, a town of Germany, in the kingdom of Prussia, on the Oder, 28 m. N.E. of Berlin, on the Frankfort-Angermünde railway. Pop. (1905) 7995. It has a small palace, built by the Great Elector, an Evangelical and a Roman Catholic church, and manufactures of furniture, machinery, &c. The neighbouring forests and its medicinal springs make it a favourite summer resort of the inhabitants of Berlin. A new tower commands a fine view of the Oderbruch (see ODER). Freienwalde, which must be distinguished from the smaller town of the same name in Pomerania, first appears as a town in 1364.

FREISELEBENITE, a rare mineral consisting of sulphantimonite of silver and lead, $(Pb, Ag)_2Sb_2Si_3$. The monoclinic crystals are prismatic in habit, with deeply striated prism and dome faces. The colour is steel-grey, and the lustre metallic; hardness 2½, specific gravity 6.2. It occurs with argentite, chalybite and galena in the silver veins of the Himmelsfurst mine at Freiberg, Saxony, where it has been known since 1720. The species was named after J. K. Freiesleben, who had earlier called it *Schiff-Glaser*. Other localities are Hiendelaencina near Guadalajara in Spain, Kapnik-Bánya in Hungary, and Guanajuato in Mexico. A species separated from freieslebenite by V. von Zepharovich in 1871, because of differences in crystalline form, is known as diaphorite (from *διαφορά*, "difference"); it is very similar to freieslebenite in appearance and has perhaps the same chemical composition (or possibly $Ag_2PbSb_2Si_3$), but is orthorhombic in crystallization. A third mineral also very similar to freieslebenite in appearance is the orthorhombic andorite, $AgPbSb_2Si_3$, which is mined as a silver ore at Oruro in Bolivia.

FREIGHT, (pronounced like "weight"; derived from the Dutch *wacht* or *wrecht*, in Fr. *fret*, the Eng. "fraught" being the same word, and formerly used for the same thing, but now only as an adjective = "laden"), the lading or cargo of a ship, and the hire paid for their transport (see AFFREIGHTMENT); from the original sense of water-transport of goods the word has also come to be used for land-transit (particularly in America, by railroad), and by analogy for any load or burden.

FREILIGRATH, FERDINAND (1810-1876), German poet, was born at Detmold on the 17th of June 1810. He was educated at the gymnasium of his native town, and in his sixteenth year was sent to Soest, with a view to preparing him for a commercial career. Here he had also time and opportunity to acquire a taste for French and English literature. The years from 1831 to 1836 he spent in a bank at Amsterdam, and 1837 to 1839 in a business house at Barmen. In 1838 his *Gedichte* appeared and met with such extraordinary success that he gave up the

idea of a commercial life and resolved to devote himself entirely to literature. His repudiation of the political poetry of 1841 and its revolutionary ideals attracted the attention of the king of Prussia, Frederick William IV., who, in 1842, granted him a pension of 300 talers a year. He married, and, to be near his friend Emanuel Geibel, settled at St. Goar. Before long, however, Freiligrath was himself carried away by the rising tide of liberalism. In the poem *Ein Glaubensbekenntnis* (1844) he openly avowed his sympathy with the political movement led by his old adversary, Georg Herwegh; the day, he declared, of his own poetic trifling with Romantic themes was over; Romanticism itself was dead. He laid down his pension, and, to avoid the inevitable political persecution, took refuge in Switzerland. As a sequel to the *Glaubensbekenntnis* he published *Ça ira!* (1846), which strained still further his relations with the German authorities. He fled to London, where he resumed the commercial life he had broken off seven years before. When the Revolution of 1848 broke out, it seemed to Freiligrath, as to all the liberal thinkers of the time, the dawn of an era of political freedom; and, as may be seen from the poems in his collection of *Politische und soziale Gedichte* (1849-1851), he welcomed it with unbounded enthusiasm. He returned to Germany and settled in Düsseldorf; but it was not long before he had again called down upon himself the ill-will of the ruling powers by a poem, *Die Töten an die Lebenden* (1848). He was arrested on a charge of *lèse-majesté*, but the prosecution ended in his acquittal. New difficulties arose; his association with the democratic movement rendered him an object of constant suspicion, and in 1851 he judged it more prudent to go back to London, where he remained until 1868. In that year he returned to Germany, settling first in Stuttgart and in 1875 in the neighbouring town of Cannstatt, where he died on the 18th of March 1876.

As a poet, Freiligrath was the most gifted member of the German revolutionary group. Coming at the very close of the Romantic age, his own purely lyric poetry re-echoes for the most part the familiar thoughts and imagery of his Romantic predecessors; but at an early age he had been attracted by the work of French contemporary poets, and he reinvigorated the German lyric by grafting upon it the orientalism of Victor Hugo. In this reconciliation of French and German romanticism lay Freiligrath's significance for the development of the lyric in Germany. His remarkable power of assimilating foreign literatures is also to be seen in his translations of English and Scottish ballads, of the poetry of Burns, Mrs Hemans, Longfellow and Tennyson (*Englische Gedichte aus neuerer Zeit*, 1846; *The Rose, Thisle and Shamrock*, 1853, 6th ed. 1887); he also translated Shakespeare's *Cymbeline*, *Winter's Tale* and *Venus and Adonis*, as well as Longfellow's *Hiawatha* (1857). Freiligrath's most original in his revolutionary poetry. His poems of this class suffer, it is true, under the disadvantage of all political poetry—purely temporary interest and the unavoidable admixture of much that has no claim to be called poetry at all—but the agitator Freiligrath, when he is at his best, displays a vigour and strength, a power of direct and cogent poetic expression, not to be found in any other political singer of the age.

Freiligrath's *Gedichte* have passed through some fifty editions, and his *Gesammelte Dichtungen*, first published in 1870, have reached a sixth edition (1898). *Nachgelassenes* (including a translation of Byron's *Manfred*) was published in 1883. A selection of Freiligrath's best-known poems in English translation was edited by his daughter, Mrs Freiligrath-Kroeker, in 1869; also *Songs of a Revolutionary Epoch* were translated by J. L. Joyces in 1888. Cf. E. Schmidt-Weissenfels, *F. Freiligrath, eine Biographie* (1876); W. Beckner, *F. Freiligrath, ein Dichterleben in Briefen* (2 vols., 1881); G. Freiligrath, *Erinnerungen an F. Freiligrath* (1889); P. Besson, *Freiligrath* (Paris, 1899); K. Richter, *Freiligrath als Übersetzer* (1899). (J. G. R.)

FREIND, JOHN (1675-1728), English physician, younger brother of Robert Friend (1667-1751), headmaster of Westminster school, was born in 1675 at Croton in Northamptonshire. He made great progress in classical knowledge under Richard Busby at Westminster, and at Christ Church, Oxford, under Dean Aldrich, and while still very young, produced, along with Peter Foulkes, an excellent edition of the speeches of Aeschines

and Demosthenes on the affair of Ctesiphon. After this he began the study of medicine, and having proved his scientific attainments by various treatises was appointed a lecturer on chemistry at Oxford in 1704. In the following year he accompanied the English army, under the earl of Peterborough, into Spain, and on returning home in 1707, wrote an account of the expedition, which attained great popularity. Two years later he published his *Prelectiones chemicæ*, which he dedicated to Sir Isaac Newton. Shortly after his return in 1713 from Flanders, whither he had accompanied the British troops, he took up his residence in London, where he soon obtained a great reputation as a physician. In 1716 he became fellow of the college of physicians, of which he was chosen one of the censors in 1718, and Harveian orator in 1720. In 1722 he entered parliament as member for Launceston in Cornwall, but, being suspected of favouring the cause of the exiled Stuarts, he spent half of that year in the Tower. During his imprisonment he conceived the plan of his most important work, *The History of Physic*, of which the first part appeared in 1725, and the second in the following year. In the latter year he was appointed physician to Queen Caroline, an office which he held till his death on the 26th of July 1728.

A complete edition of his Latin works, with a Latin translation of the *History of Physic*, edited by Dr John Wigan, was published in London in 1732.

FREINSHHEIM [FREINSHHEIMUS], JOHANN (1608-1660), German classical scholar and critic, was born at Ulm on the 16th of November 1608. After studying at the universities of Marburg, Giessen and Strassburg, he visited France, where he remained for three years. He returned to Strassburg in 1637, and in 1642 was appointed professor of eloquence at Upsala. In 1647 he was summoned by Queen Christina to Stockholm as court librarian and historiographer. In 1650 he resumed his professorship at Upsala, but early in the following year he was obliged to resign on account of ill-health. In 1656 he became honorary professor at Heidelberg, and died on the 31st of August 1660. Freinshheim's literary activity was chiefly devoted to the Roman historians. He first introduced the division into chapters and paragraphs, and by means of carefully compiled indexes illustrated the lexical peculiarities of each author. He is best known for his famous supplements to Quintus Curtius and Livy, containing the missing books written by himself. He also published critical editions of Curtius and Florus.

FREIRE, FRANCISCO JOSÉ (1719-1773), Portuguese historian and philologist, was born at Lisbon on the 3rd of January 1719. He belonged to the monastic society of St Philip Neri, and was a zealous member of the literary association known as the Academy of Arcadians, in connexion with which he adopted the pseudonym of Candido Lusitano. He contributed much to the improvement of the style of Portuguese prose literature, but his endeavour to effect a reformation in the national poetry by a translation of Horace's *Ars poetica* was less successful. The work in which he set forth his opinions regarding the vicious taste pervading the current Portuguese prose literature is entitled *Maximas sobre a Arte Oratoria* (1745) and is preceded by a chronological table forming almost a social and physical history of Portugal. His best known work, however, is his *Vida do Infante D. Henrique* (1758), which has given him a place in the first rank of Portuguese historians, and has been translated into French (Paris, 1781). He also wrote a poetical dictionary (*Dicionario poetico*) and a translation of Racine's *Atthalie* (1762), and his *Reflexões sur la langue portugaise* was published in 1842 by the Lisbon society for the promotion of useful knowledge. He died at Mafra on the 5th of July 1773.

FREISCHÜTZ, in German folklore, a marksman who by a compact with the devil has obtained a certain number of bullets destined to hit without fail whatever object he wishes. As the legend is usually told, six of the *Freikugeln* or "free bullets" are thus subservient to the marksman's will, but the seventh is at the absolute disposal of the devil himself. Various methods were adopted in order to procure possession of the marvellous missiles. According to one the marksman, instead of swallowing the sacramental host, kept it and fixed it on a tree, shoot at it

and caused it to bleed great drops of blood, gathered the drops on a piece of cloth and reduced the whole to ashes, and then with these ashes added the requisite virtue to the lead of which his bullets were made. Various vegetable or animal substances had the reputation of serving the same purpose. Stories about the Freischütts were especially common in Germany during the 14th, 15th and 16th centuries; but the first time that the legend was turned to literary profit is said to have been by Apel in the *Gespensterbuch* or "Book of Ghosts." It formed the subject of Weber's opera *Der Freischütz* (1821), the libretto of which was written by Friedrich Kind, who had suggested Apel's story as an excellent theme for the composer. The name by which the Freischütts is known in French is Robin des Bois.

See Kind, *Freyschützbuch* (Leipzig, 1843); *Revue des deux mondes* (February 1855); Græse, *Die Quelle des Freischütts* (Dresden, 1875).

FREISING, a town of Germany, in the kingdom of Bavaria, on the Isar, 16 m. by rail N.N.E. of Munich. Pop. (1905) 13,538. Among its eight Roman Catholic churches the most remarkable is the cathedral, which dates from about 1160 and is famous for its curious crypt. Noteworthy also are the old palace of the bishops, now a clerical seminary, the theological lyceum and the town-hall. There are several schools in the town, and there is a statue to the chronicler, Otto of Freising, who was bishop here from 1138 to 1158. Freising has manufactures of agricultural machinery and of porcelain, while printing and brewing are carried on. Near the town is the site of the Benedictine abbey of Weihenstephan, which existed from 725 to 1803. This is now a model farm and brewery. Freising is a very ancient town and is said to have been founded by the Romans. After being destroyed by the Hungarians in 955 it was fortified by the emperor Otto II. in 976 and by Duke Welf of Bavaria in 1082. A bishopric was established here in 724 by St Corbinianus, whose brother Erimbart was consecrated second bishop by St Boniface in 739. Later on the bishops acquired considerable territorial power and in the 17th century became princes of the Empire. In 1802 the see was secularized, the bulk of its territories being assigned to Bavaria and the rest to Salzburg, of which Freising had been a suffragan bishopric. In 1817 an archbishopric was established at Freising, but in the following year it was transferred to Munich. The occupant of the see is now called archbishop of Munich and Freising.

See C. Meichelbeck, *Historia Frisingensis* (Augsburg, 1724-1729, new and enlarged edition 1854).

FRÉJUS, a town in the department of the Var in S.E. France. Pop. (1906) 3430. It is 28½ m. S.E. of Draguignan (the chief town of the department), and 22½ m. S.W. of Cannes by rail. It is only important on account of the fine Roman remains that it contains, for it is now a mile from the sea, its harbour having been silted up by the deposits of the Argens river. Since the 4th century it has been a bishop's see, which is in the ecclesiastical province of Aix en Provence. In modern times the neighbouring fishing village at St Raphaël (2½ m. by rail S.E., and on the seashore) has become a town of 4865 inhabitants (in 1901); in 1799 Napoleon disembarked there on his return from Egypt, and re-embarked for Elba in 1814, while nowadays it is much frequented as a health resort, as is also Valescure (2 m. N.W. on the heights above). The cathedral church in part dates from the 12th century, but only small portions of the old medieval episcopal palace are now visible, as it was rebuilt about 1823. The ramparts of the old town can still be traced for a long distance, and there are fragments of two moles, of the theatre and of a gate. The amphitheatre, which seated 12,000 spectators, is in a better state of preservation. The ruins of the great aqueduct which brought the waters of the Siagnole, an affluent of the Siagne, to the town, can still be traced for a distance of nearly 10 m. The original hamlet was the capital of the tribe of the Oxybi, while the town of Forum Julii was founded on its site by Julius Caesar in order to secure to the Romans a harbour independent of that of Marseilles. The buildings of which ruins exist were mostly built by Caesar or by Augustus, and show that it was an important naval station and arsenal. But the town suffered much at the hands of the Arabs, of Barbary pirates, and of its inhabitants,

who constructed many of their dwellings out of the ruined Roman buildings. The ancient harbour (really but a portion of the lagoons, which had been deepened) is now completely silted up. Even in early times a canal had to be kept open by perpetual digging, while about 1700 this was closed, and now a sandy and partly cultivated waste extends between the town and the seashore.

See J. A. Aubenas, *Histoire de Fréjus* (Fréjus, 1881); Ch. Lenthéric, *La Provence Maritime ancienne et moderne* (Paris, 1880), chap. vii. (W. A. B. C.)

FRELINGHUYSEN, FREDERICK THEODORE (1817-1885), American lawyer and statesman, of Dutch descent, was born at Millstone, New Jersey, on the 4th of August 1817. His grandfather, Frederick Frelinghuysen (1753-1804), was an eminent lawyer, one of the framers of the first New Jersey constitution, a soldier in the War of Independence, and a member (1778-1779 and 1782-1783) of the Continental Congress from New Jersey, and in 1793-1796 of the United States senate; and his uncle, Theodore (1787-1862), was attorney-general of New Jersey from 1817 to 1829, was a United States senator from New Jersey in 1829-1835, was the Whig candidate for vice-president on the Clay ticket in 1844, and was chancellor of the university of New York in 1839-1850 and president of Rutgers College in 1850-1862. Frederick Theodore, left an orphan at the age of three, was adopted by his uncle, graduated at Rutgers in 1836, and studied law in Newark with his uncle, to whose practice he succeeded in 1839, soon after his admission to the bar. He became attorney for the Central Railroad of New Jersey, the Morris Canal and Banking Company, and other corporations, and from 1861 to 1867 was attorney-general of New Jersey. In 1861 he was a delegate to the peace congress at Washington, and in 1866 was appointed by the governor of New Jersey, as a Republican, to fill a vacancy in the United States senate. In the winter of 1867 he was elected to fill the unexpired term, but a Democratic majority in the legislature prevented his re-election in 1869. In 1870 he was nominated by President Grant, and confirmed by the senate, as United States minister to England to succeed John Lothrop Motley, but declined the mission. From 1871 to 1877 he was again a member of the United States senate, in which he was prominent in debate and in committee work, and was chairman of the committee on foreign affairs during the Alabama Claims negotiations. He was a strong opponent of the reconstruction measures of President Johnson, for whose conviction he voted (on most of the specific charges) in the impeachment trial. He was a member of the Joint committee which drew up and reported (1877) the Electoral Commission Bill, and subsequently served as a member of the commission. On the 12th of December 1881 he was appointed secretary of state by President Arthur to succeed James G. Blaine, and served until the inauguration of President Cleveland in 1885. Retiring, with his health impaired by overwork, to his home in Newark, he died there on the 20th of May, less than three months after relinquishing the cares of office.

FREMANTLE, a seaport of Swan county, Western Australia, at the mouth of the Swan river, 12 m. by rail S.W. of Perth. It is the terminus of the Eastern railway, and is a town of some industrial activity, shipbuilding, soap-boiling, saw-milling, smelting, iron-founding, furniture-making, flour-milling, brewing and tanning being its chief industries. The harbour, by the construction of two long moles and the blasting away of the rocks at the bar, has been rendered secure. The English, French and German mail steamers call at the port. Fremantle became a municipality in 1871; but there are now three separate municipalities—Fremantle, with a population in 1901 of 14,704; Fremantle East (2494); and Fremantle North (3246). At Roitnest Island, off the harbour, there are government salt-works and a residence of the governor, also penal and reformatory establishments.

FRÉMIET, EMMANUEL (1824-), French sculptor, born in Paris, was a nephew and pupil of Rude; he chiefly devoted himself to animal sculpture and to equestrian statues in armour. His earliest work was in scientific lithography (osteology), and

for a while he served in times of adversity in the gruesome office of "painter to the Morgue." In 1843 he sent to the Salon a study of a "Gazelle," and after that date was very prolific in his works. His "Wounded Bear" and "Wounded Dog" were produced in 1850, and the Luxembourg Museum at once secured this striking example of his work. From 1855 to 1859 Frémont was engaged on a series of military statuettes for Napoleon III. He produced his equestrian statue of "Napoleon I." in 1868, and of "Louis d'Orléans" in 1869 (at the Château de Pierrefonds) and in 1874 the first equestrian statue of "Joan of Arc," erected in the Place des Pyramides, Paris; this he afterwards (1889) replaced with another and still finer version. In the meanwhile he had exhibited his masterly "Gorilla and Woman" which won him a medal of honour at the Salon of 1887. Of the same character, and even more remarkable, is his "Ourang-Outangs and Borneo Savage" of 1895, a commission from the Paris Museum of Natural History. Frémont also executed the statue of "St Michael" for the summit of the spire of the Église St Michel, and the equestrian statue of Velasquez for the Jardin de l'Infante at the Louvre. He became a member of the Académie des Beaux-Arts in 1892, and succeeded Barye as professor of animal drawing at the Natural History Museum of Paris.

FRÉMONT, JOHN CHARLES (1813-1890), American explorer, soldier and political leader, was born in Savannah, Georgia, on the 21st of January 1813. His father, a native of France, died when the boy was in his sixth year, and his mother, a member of an aristocratic Virginia family, then removed to Charleston, South Carolina. In 1828, after a year's special preparation, young Frémont entered the junior class of the college of Charleston, and here displayed marked ability, especially in mathematics; but his irregular attendance and disregard of college discipline led to his expulsion from the institution, which, however, conferred upon him a degree in 1836. In 1833 he was appointed teacher of mathematics on board the sloop of war "Natchez," and was so engaged during a cruise along the South American coast which was continued for about two and a half years. Soon after returning to Charleston he was appointed professor of mathematics in the United States navy, but he chose instead to serve as assistant engineer of a survey undertaken chiefly for the purpose of finding a pass through the mountains for a proposed railway from Charleston to Cincinnati. In July 1838 he was appointed second lieutenant of Topographical Engineers in the United States army, and for the next three years he was assistant to the French explorer, Jean Nicholas Nicollet (1786-1843), employed by the war department to survey and map a large part of the country lying between the upper waters of the Mississippi and Missouri rivers. In 1841 Frémont surveyed, for the government, the lower course of the Des Moines river. In the same year he married Jessie, the daughter of Senator Thomas H. Benton of Missouri, and it was in no small measure through Benton's influence with the government that Frémont was enabled to accomplish within the next few years the exploration of much of the territory between the Mississippi Valley and the Pacific Ocean.

When the claim of the United States to the Oregon territory was being strengthened by occupation, Frémont was sent, at his urgent request, to explore the frontier beyond the Missouri river, and especially the Rocky Mountains in the vicinity of the South Pass, through which the American immigrants travelled. Within four months (1842) he surveyed the Pass and ascended to the summit of the highest of the Wind River Mountains, since known as Frémont's Peak, and the interest aroused by his descriptions was such that in the next year he was sent on a second expedition to complete the survey across the continent along the line of travel from Missouri to the mouth of the Columbia river. This time he not only carried out his instructions but, by further explorations together with interesting descriptions, dispelled general ignorance with respect to the main features of the country W. of the Rocky Mountains: the Great Salt Lake, the Great Basin, the Sierra Nevada Mountains, and the fertile river basins of the Mexican province of California.

His report of this expedition upon his return to Washington, D.C., in 1844, aroused much solicitude for California, which, it was feared, might, in the event of war then threatening between the United States and Mexico, be seized by Great Britain. In the spring of 1845 Frémont was despatched on a third expedition for the professed purposes of further exploring the Great Basin and the Pacific Coast, and of discovering the easiest lines of communication between them, as well as for the secret purpose of assisting the United States, in case of war with Mexico, to gain possession of California. He and his party of sixty-two arrived there in January 1846. Owing to the number of American immigrants who had settled in California, the Mexican authorities there became suspicious and hostile, and ordered Frémont out of the province. Instead of obeying he pitched his camp near the summit of a mountain overlooking Monterey, fortified his position, and raised the United States flag. A few days later he was proceeding toward the Oregon border when new instructions from Washington caused him to retrace his steps and, perhaps, to consider plans for provoking war. The extent of his responsibility for the events that ensued is not wholly clear, and has been the subject of much controversy; his defenders have asserted that he was not responsible for the seizure of Sonoma or for the so-called "Bear-Flag War"; and that he played a creditable part throughout. (For an opposite view see CALIFORNIA.) Commodore John D. Sloat, after seizing Monterey, transferred his command to Commodore Robert Field Stockton (1795-1866), who made Frémont major of a battalion; and by January 1847 Stockton and Frémont completed the conquest of California. In the meantime General Stephen Watts Kearny (1794-1848) had been sent by the Government to conquer it and to establish a government. This created a conflict of authority between Stockton and Kearny, both of whom were Frémont's superior officers. Stockton, ignoring Kearny, commissioned Frémont military commandant and governor. But Kearny's authority being confirmed about the 1st of April, Frémont, for repeated acts of disobedience, was sent under arrest to Washington, where he was tried by court-martial, found guilty (January 1847) of mutiny, disobedience and conduct prejudicial to military discipline, and sentenced to dismissal from the service. President Polk approved of the verdict except as to mutiny, but remitted the penalty, whereupon Frémont resigned.

With the mountain-traversed region he had been exploring acquired by the United States, Frémont was eager for a railway from the Atlantic to the Pacific, and in October 1848 he set out at his own and Senator Benton's expense to find passes for such a railway along a line westward from the headwaters of the Rio Grande. But he had not gone far when he was led astray by a guide, and after the loss of his entire outfit and several of his men, and intense suffering of the survivors from cold and hunger, he turned southward through the valley of the Rio Grande and then westward through the valley of the Gila into southern California. Late in the year 1853, however, he returned to the place where the guide had led him astray, found passes through the mountains to the westward between latitudes 37° and 38° N., and arrived in San Francisco early in May 1854. From the conclusion of his fourth expedition until March 1855, when he removed to New York city, he lived in California, and in December 1849 was elected one of the first two United States senators from the new state. But as he drew the short term, he served only from the 10th of September 1850 to the 3rd of March 1851. Although a candidate for re-election, he was defeated by the pro-slavery party. His opposition to slavery, however, together with his popularity—won by the successes, hardships and dangers of his exploring expeditions, and by his part in the conquest of California—led to his nomination, largely on the ground of "availability," for the presidency in 1856 by the Republicans (this being their first presidential campaign), and by the National Americans or "Know-Nothings." In the ensuing election he was defeated by James Buchanan by 174 to 114 electoral votes. Soon after the Civil War began, Frémont was appointed major-general and placed in command of the western department.

with headquarters at St Louis, but his lack of judgment and of administrative ability soon became apparent, the affairs of his department fell into disorder, and Frémont seems to have been easily duped by dishonest contractors whom he trusted. On the 30th of August 1861 he issued a proclamation in which he declared the property of Missourians in rebellion confiscated and their slaves emancipated. For this he was applauded by the radical Republicans, but his action was contrary to an act of congress of the 6th of August and to the policy of the Administration. On the 11th of September President Lincoln, who regarded the action as premature and who saw that it might alienate Kentucky and other border states, whose adherence he was trying to secure, annulled these declarations. Impelled by serious charges against Frémont, the president sent Montgomery Blair, the postmaster-general, and Montgomery C. Meigs, the quartermaster-general, to investigate the department; they reported that Frémont's management was extravagant and inefficient; and in November he was removed. Out of consideration for the "Radicals," however, Frémont was placed in command of the Mountain Department of Virginia, Kentucky and Tennessee. In the spring and summer of 1862 he co-operated with General N. P. Banks against "Stonewall" Jackson in the Shenandoah Valley, but showed little ability as a commander, was defeated by General Ewell at Cross Keys, and when his troops were united with those of Generals Banks and McDowell to form the Army of Virginia, of which General John Pope was placed in command, Frémont declined to serve under Pope, whom he outranked, and retired from active service. On the 31st of May 1864 he was nominated for the presidency by a radical faction of the Republican party, opposed to President Lincoln, but his following was so small that on the 21st of September he withdrew from the contest. From 1878 to 1881 he was governor of the territory of Arizona, and in the last year of his life he was appointed by act of congress a major-general and placed on the retired list. He died in New York on the 13th of July 1890.

See J. C. Frémont, *Report of the Exploring Expedition to the Rocky Mountains, 1842, and to Oregon and North California, 1843-1844* (Washington, 1845); Frémont's *Memoirs of my Life* (New York, 1887); and J. Bigelow, *Memoirs of the Life and Public Services of John C. Frémont* (New York, 1896).

FREMONT, a city and the county-seat of Dodge county, Nebraska, U.S.A., about 37 m. N.W. of Omaha, on the N. bank of the Platte river, which here abounds in picturesque bluffs and wooded islands. Pop. (1890) 6747; (1900) 7241 (1303 foreign-born); (1910) 8718. It is on the main line of the Union Pacific railway, on a branch of the Chicago, Burlington & Quincy system, and on the main western line of the Chicago & North-Western railway, several branches of which (including the formerly independent Fremont, Elkhorn & Missouri Valley and the Sioux City & Pacific) converge here. The city has an attractive situation and is beautifully shaded. It has a public library and is the seat of the Fremont College, Commercial Institute and School of Pharmacy (1875), a private institution. There is considerable local trade with the rich farming country of the Platte and Elkhorn valleys; and the wholesale grain interests are especially important. Among the manufactures are flour, carriages, saddlery, canned vegetables, furniture, incubators and beer. The city owns and operates its electric-lighting plant and water-works. Fremont was founded in 1856, and became the county-seat in 1860. It was chartered as a city (second-class) in 1871, and became a city of the first class in 1901.

FREMONT, a city and the county-seat of Sandusky county, Ohio, U.S.A., on the Sandusky river, 30 m. S.E. of Toledo. Pop. (1890) 7141; (1900) 8439, of whom 1074 were foreign-born; (1910 census) 9939. Fremont is served by the Lake Shore & Michigan Southern, the Lake Shore Electric, the Lake Erie & Western, and the Wheeling & Lake Erie railways. The river is navigable to this point. Spiegel Grove, the former residence of Rutherford B. Hayes, is of interest, and the city has a public library (1873) and parks, in large measure the gifts of his uncle, Sardis Birchard. Fremont is situated in a good agricultural region; oil and natural gas abound in the vicinity; and the city has various manufactures, including boilers, electro-carbons,

cutlery, bricks, agricultural implements, stoves and ranges, safety razors, carriage irons, sash, doors, blinds, furniture, beet sugar, canned vegetables, malt extract, garters and suspenders. The total factory product was valued at \$2,833,385 in 1905, an increase of 23.4% over that of 1900. Fremont is on the site of a favourite abode of the Indians, and a trading post was at times maintained here; but the place is best known in history as the site of Fort Stephenson, erected during the War of 1812, and on the 2nd of August 1813 gallantly and successfully defended by Major George Croghan (1791-1849), with 160 men, against about 1000 British and Indians under Brigadier-General Henry A. Proctor. In 1906 Croghan's remains were re-interred on the site of the old fort. Until 1849, when the present name was adopted in honour of J. C. Frémont, the place was known as Lower Sandusky; it was incorporated as a village in 1829 and was first chartered as a city in 1867.

FREMY, EDMOND (1814-1894), French chemist, was born at Versailles on the 29th of February 1814. Entering Gay-Lussac's laboratory in 1831, he became *préparateur* at the École Polytechnique in 1834 and at the Collège de France in 1837. His next post was that of *répétiteur* at the École Polytechnique, where in 1846 he was appointed professor, and in 1850 he succeeded Gay-Lussac in the chair of chemistry at the *Muséum d'Histoire Naturelle*, of which he was director, in succession to M. E. Chevreul, from 1879 to 1891. He died at Paris on the 3rd of February 1894. His work included investigations of osmic acid, of the ferrates, stannates, plumbates, &c., and of ozone, attempts to obtain free fluorine by the electrolysis of fused fluorides, and the discovery of anhydrous hydrofluoric acid and of a series of *acides sulphazoïles*, the precise nature of which long remained a matter of discussion. He also studied the colouring matters of leaves and flowers, the composition of bone, cerebral matter and other animal substances, and the processes of fermentation, in regard to the nature of which he was an opponent of Pasteur's views. Keenly alive to the importance of the technical applications of chemistry, he devoted special attention as a teacher to the training of industrial chemists. In this field he contributed to our knowledge of the manufacture of iron and steel, sulphuric acid, glass and paper, and in particular worked at the saponification of fats with sulphuric acid and the utilization of palmitic acid for candle-making. In the later years of his life he applied himself to the problem of obtaining alumina in the crystalline form, and succeeded in making rubies identical with the natural gem not merely in chemical composition but also in physical properties.

FRENCH, DANIEL CHESTER (1850-), American sculptor, was born at Exeter, New Hampshire, on the 20th of April 1850, the son of Henry Flagg French, a lawyer, who for a time was assistant-secretary of the United States treasury. After a year at the Massachusetts Institute of Technology, French spent a month in the studio of John Q. A. Ward, then began to work on commissions, and at the age of twenty-three received from the town of Concord, Massachusetts, an order for his well-known statue "The Minute Man," which was unveiled (April 19, 1875) on the centenary of the battle of Concord. Previously French had gone to Florence, Italy, where he spent a year with Thomas Ball. French's best-known work is "Death Staying the Hand of the Sculptor," a memorial for the tomb of the sculptor Martin Milmore, in the Forest Hills cemetery, Boston; this received a medal of honour at Paris, in 1900. Among his other works are: a monument to John Boyle O'Reilly, Boston; "Gen. Cam," National Hall of Statuary, Washington; "Dr Gallaudet and his First Deaf-Mute Pupil," Washington; the colossal "Statue of the Republic," for the Columbian Exposition at Chicago; statues of Rufus Choate (Boston), John Harvard (Cambridge, Mass.), and Thomas Starr King (San Francisco, California), a memorial to the architect Richard M. Hunt, in Fifth Avenue, opposite the Lenox library, New York, and a large "Alma Mater," near the approach to Columbia University, New York. In collaboration with Edward C. Potter he modelled the "Washington," presented to France by the Daughters of the American Revolution; the "General Grant" in Fairmount Park,

Philadelphia, and the "General Joseph Hooker" in Boston. French became a member of the National Academy of Design (1901), the National Sculpture Society, the Architectural League, and the Accademia di San Luca, of Rome.

FRENCH, NICHOLAS (1604-1678), bishop of Ferns, was an Irish political pamphleteer, who was born at Wexford. He was educated at Louvain, and returning to Ireland became a priest at Wexford, and before 1646 was appointed bishop of Ferns. Having taken a prominent part in the political disturbances of this period, French deemed it prudent to leave Ireland in 1651, and the remainder of his life was passed on the continent of Europe. He acted as coadjutor to the archbishops of Santiago de Compostella and Paris, and to the bishop of Ghent, and died at Ghent on the 23rd of August 1678. In 1676 he published his attack on James Butler, marquis of Ormonde, entitled "The Unkinde Deserter of Loyall Men and True Frinds," and shortly afterwards "The Bleeding Iphigenia." The most important of his other pamphlets is the "Narrative of the Earl of Clarendon's Settlement and Sale of Ireland" (Louvain, 1668).

The *Historical Works* of Bishop French, comprising the three pamphlets already mentioned and some letters, were published by S. H. Bindon at Dublin in 1846. See T. D. McGee, *Irish Writers of the 17th Century* (Dublin, 1846); Sir J. T. Gilbert, *Contemporary History of Affairs in Ireland, 1641-1652* (Dublin, 1879-1880); and T. Carte, *Life of James, Duke of Ormonde* (new ed., Oxford, 1851).

FRENCH CONGO, the general name of the French possessions in equatorial Africa. They have an area estimated at 700,000 sq. m., with a population, also estimated, of 6,000,000 to 10,000,000. The whites numbered (1906) 1278, of whom 502 were officials. French Congo, officially renamed **FRENCH EQUATORIAL AFRICA** in 1910, comprises—(1) the Gabun Colony, (2) the Middle Congo Colony, (3) the Ubangi-Shari Circumscription, (4) the Chad Circumscription. The two last-named divisions form the Ubangi-Shari-Chad Colony.

The present article treats of French Congo as a unit. It is of highly irregular shape. It is bounded W. by the Atlantic, N. by the (Spanish) Muni River Settlements, the German colony of Cameroon and the Sahara, E. by the Anglo-Egyptian Sudan, and S. by Belgian Congo and the Portuguese territory of Kabinda. In the greater part of its length the southern frontier is the middle course of the Congo and the Ubangi and Mbomu, the chief northern affluents of that stream, but in the south-west the frontier keeps north of the Congo river, whose navigable lower course is partitioned between Belgium and Portugal. The coast line, some 600 m. long, extends from 5° S. to 1° N. The northern frontier, starting inland from the Muni estuary, after skirting the Spanish settlements follows a line drawn a little north of 2° N. and extending east to 16° E. North of this line the country is part of Cameroon, German territory extending so far inland from the Gulf of Guinea as to approach within 130 m. of the Ubangi. From the intersection of the lines named, at which point French Congo is at its narrowest, the frontier runs north and then east until the Shari is reached in 10° 40' N. The Shari then forms the frontier up to Lake Chad, where French Congo joins the Saharan regions of French West Africa. The eastern frontier, separating the colony from the Anglo-Egyptian Sudan, is the water-parting between the Nile and the Congo. The Mahomedan sultanates of Wadai and Bagirmi occupy much of the northern part of French Congo (see **WADAI** and **BAGIRMI**).

Physical Features.—The coast line, beginning in the north at Corisco Bay, is shortly afterwards somewhat deeply indented by the estuary of the Gabun, south of which the shore runs in a nearly

straight line until the delta of the Ogowé is reached, where Cape Lopez projects N.W. From this point the coast trends uniformly S.E. without presenting any striking features, though the Bay of Mayumba, the roadstead of Loango, and the Pointe Noire may be mentioned. A large proportion of the coast region is occupied by primeval forest, with trees rising to a height of 150 and 200 ft., but there is a considerable variety of scenery—open lagoons, mangrove swamps, scattered clusters of trees, park-like meadows, dense walls of tangled underwood along the rivers, prairies of tall grass and patches of cultivation. Behind the coast region is a ridge which rises from 3000 to 4500 ft., called the Crystal Mountains, then a plateau with an elevation varying from 1500 to 2800 ft., cleft with deep river-



valleys, the walls of which are friable, almost vertical, and in some places 760 ft. high.

The coast rivers flowing into the Atlantic cross four terraces. On the higher portion of the plateau their course is over bare sand; on the second terrace, from 1200 to 2000 ft. high, it is over wide grassy tracts; then, for some 100 m., the rivers pass through virgin forest, and, lastly, they cross the shore region, which is about 10 m. broad. The rivers which fall directly into the Atlantic are generally unnavigable. The most important, the Ogowé (q.v.), is, however, navigable from its mouth to N'Jole, a distance of 335 m. Rivers to the south of the Ogowé are the Nyanga, 120 m. long, and the Kwilu. The latter, 320 m. in length, is formed by the Kiasi and the Luté; it has a very winding course, flowing by turns from north to south, from east to west, from south to north-west and from north to south-west. It is encumbered with rocks and eddies, and is navigable only over 38 m., and for five months in the year. The mouth is 1100 ft. wide. The Muni river, the northernmost in the colony, is obstructed by cataracts in its passage through the escarpment to the coast.

Nearly all the upper basin of the Shari (q.v.) as well as the right bank of the lower river is within French Congo. The greater part of the country belongs, however, to the drainage area of the Congo river. In addition to the northern banks of the Mbomu and Ubangi, 330 m. of the north shore of the Congo itself are in the French protectorate as well as numerous subsidiary streams. For some 100 m. however, the right bank of the Sanga, the most important of these subsidiary streams, is in German territory (see **CONGO**).

Geology.—Three main divisions are recognized in the French Congo:—(1) the littoral zone, covered with alluvium and superficial deposits and underlain by Tertiary and Cretaceous rocks; (2) the mountain zone of the Crystal Mountains, composed of granite, metamorphic and ancient sediments; (3) the plateau of the northern portion of the Congo basin, occupied by Karroo sandstones. The core of the Crystal Mountains consists of granite and schists.

infolded with them, and on the flanks, are three rock systems ascribed to the Silurian, Devonian and Carboniferous. These are unfossiliferous, but fossils of Devonian age occur on the Congo (see CONGO FAUNA STATE). Granite covers wide areas north-west of the Crystal Mountains. The plateau sandstones lie horizontally and consist of a lower red sandstone group and an upper white sandstone group. They have not yielded fossils. Limestones of Lower Cretaceous age, with *Schloenbachia inflata*, occur north of the Gabun and in the Ogowé basin. Marls and limestones with fossils of an Eocene facies overlie the Cretaceous rocks on the Gabun. A superficial iron-cemented sand, erroneously termed laterite, covers large areas in the littoral zone, on the flanks of the mountains and on the high plateau.

Climate.—The whole of the country being in the equatorial region, the climate is everywhere very hot and dangerous for Europeans. On the coast four seasons are distinguished: the dry season (15th of May to 15th of September), the rainy season (15th of September to 15th of January), then a second dry season (15th of January to 1st of March), and a second rainy season (1st of March to 15th of May). The rainfall at Libreville is about 96 in. a year.

Flora and Fauna.—The elephant, the hippopotamus, the crocodile and several kinds of apes—including the chimpanzee and the rare gorilla—are the most noteworthy larger animals; the birds are various and beautiful—grey parrots, shrikes, fly-catchers, rhinoceros birds, weaver birds (often in large colonies on the palm-trees), ice-birds, from the *Ceryle Sharpii* to the dwarfish *Alcedo cristata*, butterfly finches, and helmet-birds (*Turacus giganteus*), as well as more familiar types. Snakes are extremely common. The curious climbing-fish, which frequents the mangroves, the *Protapterus* or lung-fish, which lies in the mud in a state of lethargy during the dry season, the strange and poisonous *Tetraodon guttifer*, and the herring-like *Pelona africana*, often caught in great shoals—are the more remarkable of the fishes. Oysters are got in abundance from the lagoons, and the huge *Cardisoma armatum* or heart-crab is fattened for table. Fireflies, mosquitoes and sandflies are among the most familiar forms of insect life. A kind of ant builds very striking bent-house or umbrella-shaped nests rising on the tree trunks one above the other.

Among the more characteristic forms of vegetation are baobabs, silk-cotton trees, screw-pines and palms—especially *Hyphaene guineensis* (a fan-palm), *Raphia* (the wine-palm), and *Elaeis guineensis* (the oil-palm). Anonaceous plants (notably *Anona senegalensis*, and the *palakanda*, an olive-myrtle-like tree, are common in the prairies; the papaya (roots up to a height of 20 ft. along the rivers; the banks are fringed by the cottony *Ibiscus tiliaceus*, ipomeas and fragrant jasmynes; and the thickets are bountiful together in one inextricable mass by lianas of many kinds. In the upper Shari region and that of the Kotto tributary of the Ubangi, are species of the coffee tree, one species attaining a height of over 60 ft. Its bean resembles that of Abyssinian coffee of medium quality. Among the fruit trees are the mango and the papaw, the orange and the lemon. Negro-pepper (a variety of capsicum) and ginger grow wild.

Inhabitants and Chief Towns.—A census, necessarily imperfect, taken in 1906 showed a total population, exclusive of Wadai, of 3,652,000, divided in districts as follows:—Gabun, 376,000; Middle Congo, 259,000; Ubangi-Shari, 2,130,000; Chad, 885,000. The country is peopled by diverse negro races, and, in the regions bordering Lake Chad and in Wadai, by Fula, Hausa, Arabs and semi-Arab tribes. Among the best-known tribes living in French Congo are the Fang (Fangs), the Bakalia, the Batekes and the Zandeh or Niam-Niam. Several of the tribes are cannibals and among many of them the fetish worship characteristic of the West African negroes prevails. Their civilization is of a low order. In the northern regions the majority of the inhabitants are Mahomedans, and it is only in those districts that organized and powerful states exist. Elsewhere the authority of a chief or "king" extends, ordinarily, little beyond the village in which he lives. (An account of the chief tribes is given under their names.) The European inhabitants are chiefly of French nationality, and are for the most part traders, officials and missionaries.

The chief towns are Libreville (capital of the Gabun colony) with 3000 inhabitants; Brazzaville, on the Congo on the north side of Stanley Pool (opposite the Belgian capital of Leopoldville), the seat of the governor-general; Franceville, on the upper Ogowé; Loango, an important seaport in 4° 39' S.; N'Jole, a busy trading centre on the lower Ogowé; Chelka, capital of Bagirmi, which forms part of the Chad territory; Abeshr, the capital of Wadai, Bangi on the Ubangi river, the administrative capital of the Ubangi-Shari-Chad colony. Kounde, Lame and Binder are native trading centres near the Cameroon frontier.

Communications.—The rivers are the chief means of internal communication. Access to the greater part of the colony is obtained by ocean steamers to Matadi on the lower Congo, and thence round the falls by the Congo railway to Stanley Pool. From Brazzaville on Stanley Pool there is 680 m. of uninterrupted steam navigation N.E. into the heart of Africa, 330 m. being on the Congo and 350 m. on the Ubangi. The farthest point reached in Zongo, where rapids block the river, but beyond that port there are several navigable stretches of the Ubangi, and for small vessels access to the Nile is possible by means of the Bahr-el-Ghazal tributaries. The Sanga, which joins the Congo, 270 m. above Brazzaville, can be

navigated by steamers for 350 m., i.e. up to and beyond the S.E. frontier of the German colony of Cameroon. The Shari is also navigable for a considerable distance and by means of its affluent, the Logone connects with the Benue and Niger, affording a waterway between the Gulf of Guinea and Lake Chad. Stores for government posts in the Chad territory are forwarded by this route. There is, however, no connecting link between the coast rivers—Gabun, Ogowé and Kwilu and the Congo system. A railway, about 500 m. long, from the Gabun to the Sanga is projected and the surveys for the purpose made. Another route surveyed for a railway is that from Loango to Brazzaville. A narrow-gauge line, 75 m. long, from Brazzaville to Mindule in the cataracts region was begun in November 1908, the first railway to be built in French Congo. The district served by the line is rich in copper and other minerals. From Wadai a caravan route across the Sahara leads to Bengazi on the shores of the Mediterranean. Telegraph lines connect Loango with Brazzaville and Libreville, and there is telegraphic communication with Europe by submarine cable, and steamship communication between Loango and Libreville and Marseilles, Bordeaux, Liverpool and Hamburg.

Trade and Agriculture.—The chief wealth of the colony consists in the products of its forests and in ivory. The natives, in addition to manioc, their principal food, cultivate bananas, ground nuts and tobacco. On plantations owned by European coffee, cocoa and vanilla are grown. European vegetables are raised locally. Gold, iron and copper are found. Copper ores have been exported from Mindule since 1905. The chief exports are rubber and ivory, next in importance coming palm nuts and palm oil, ebony and other woods, coffee, cocoa and copal. The imports are mainly cotton and metal goods, spirits and foodstuffs. In the Gabun and in the basin of the Ogowé the French customs tariff, with some modifications, prevails, but in the Congo basin, that is, in the greater part of the country, by virtue of international agreements, no discrimination can be made between French and other merchandise, whilst customs duties must not exceed 10% *ad valorem*.¹ In the Shari basin and in Wadai the Anglo-French declaration of March 1899 accorded for thirty years equal treatment to British and French goods. The value of the trade rose in the ten years 1896-1905 from £360,000 to £850,000, imports and exports being nearly equal. The bulk of the export trade is with Great Britain, which takes most of the rubber, France coming second and Germany third. The imports are in about equal proportions from France and foreign countries.

Land Tenure. The Concessions Regime.—Land held by the natives is governed by tribal law, but the state only recognizes native ownership in land actually occupied by the aborigines; the greater part of the country is considered a state domain. Land held by Europeans is subject to the Civil Code of France except such estates as have been registered under the terms of a decree of the 28th of March 1899, when, registration having been effected, the title to the land is guaranteed by the state. Nearly the whole of the colony has been divided since 1899 into large estates held by limited liability companies to whom has been granted the sole right of exploiting the land leased to them. The companies holding concessions numbered in 1904 about forty, with a combined capital of over £2,000,000, whilst the concessions varied in size from 425 sq. m. to 54,000 sq. m. One effect of the granting of concessions was the rapid decline in the business of non-concessionaire traders, of whom the most important were Liverpool merchants established in the Gabun before the advent of the French. As by the Act of Berlin of 1885, to which all the European powers were signatories, equality of treatment in commercial affairs was guaranteed to all nations in the Congo basin, protests were raised against the terms of the concessions. The reply was that the critics confused the exercise of the right of proprietorship with the act of commerce, and that in no country was the landowner who farmed his land and sold the produce regarded as a merchant. Various decisions by the judges of the colony during 1902 and 1903 and by the French *cour de cassation* in 1905 confirmed that contention. The action of the companies was, however, in most cases, neither beneficial to the country nor financially successful, whilst the native cultivators resented the prohibition of their trading direct with their former customers. The case of the Liverpool traders was taken up by the British government and it was agreed that the dispute should be settled by arbitration. In September 1908 the French government issued a decree reorganizing and rendering more stringent the control exercised by the local authorities over the concession companies, especially in matters concerning the rights of natives and the liberty of commerce.

History.—The Gabun was visited in the 15th century by the Portuguese explorers, and it became one of the chief seats of the slave trade. It was not, however, till well on in the 19th century that Europeans made any more permanent settlement than was absolutely necessary for the maintenance of their commerce. In 1839 Captain (afterwards Admiral) Bouët-Willauze obtained for France the right of residence on the left bank, and in 1842 he secured better positions on the right bank. The primary object of the French settlement was to secure a

¹ Berlin Act of 1885; Brussels conference of 1890 (see *AFRICA: History*).

port wherein men-of-war could revictual. The chief establishment, Libreville, was founded in 1849, with negroes taken from a slave ship. The settlement in time acquired importance as a trading port. In 1867 the troops numbered about 1000, and the civil population about 5000, while the official reports about the same date claimed for the whole colony an area of 8000 sq. m. and a population of 186,000. Cape Lopez had been ceded to France in 1862, and the colony's coast-line extended, nominally, to a length of 200 m. In consequence of the war with Germany the colony was practically abandoned in 1871, the establishment at Libreville being maintained as a coaling depot merely. In 1875, however, France again turned her attention to the Gabun estuary, the hinterland of which had already been partly explored. Paul du Chaillu penetrated (1855-1859 and 1863-1865) to the south of the Ogowé; Walker, an English merchant, explored the Ngunye, an affluent of the Ogowé, in 1866. In 1872-1873 Alfred Marche, a French naturalist, and the marquis de Compiègne¹ explored a portion of the Ogowé basin, but it was not until the expedition of 1875-1878 that the country east of the Ogowé was reached. This expedition was led by Savorgnan de Brazza (*q.v.*), who was accompanied by Dr Noel Eugène Ballay, and, for part of the time, by Marche. De Brazza's expedition, which was compelled to remain for many months at several places, ascended the Ogowé over 400 m., and beyond the basin of that stream discovered the Alima, which was, though the explorers were ignorant of the fact, a tributary of the Congo. From the Alima, de Brazza and Ballay turned north and finally reached the Gabun in November 1878, the journey being less fruitful in results than the time it occupied would indicate. Returning to Europe, de Brazza learned that H. M. Stanley had revealed the mystery of the Congo, and in his next journey, begun December 1879, the French traveller undertook to find a way to the Congo above the rapids via the Ogowé. In this he was successful, and in September 1880 reached Stanley Pool, on the north side of which Brazzaville was subsequently founded. Returning to the Gabun by the lower Congo, de Brazza met Stanley. Both explorers were nominally in the service of the International African Association (see CONGO FREE STATE), but de Brazza in reality acted solely in the interests of France and concluded treaties with Makoko, "king of the Batekes," and other chieftains, placing very large areas under the protection of that country. The conflicting claims of the Association (which became the Congo Free State) and France were adjusted by a convention signed in February 1885.² In the meantime de Brazza and Ballay had more fully explored the country behind the coast regions of Gabun and Loango, the last-named seaport being occupied by France in 1883. The conclusion of agreements with Germany (December 1885 and February-March 1894) and with Portugal (May 1886) secured France in the possession of the western portion of the colony as it now exists, whilst an arrangement with the Congo Free State in 1887 settled difficulties which had arisen in the Ubangi district.

The extension of French influence northward towards Lake Chad and eastward to the verge of the basin of the Nile followed, though not without involving the country in serious disputes with the other European powers possessing rights in those regions. By creating the posts of Bangi (1890), Wesso and Abiras (1891), France strengthened her hold over the Ubangi and the Sanga. But at the same time the Congo Free State passed the parallel of 4° N.—which, after the compromise of 1887, France had regarded as the southern boundary of her possessions—and, occupying the sultanate of Bangasso (north of the Ubangi river), pushed on as far as 0° N. The dispute which ensued was only settled in 1894 and after

¹ Louis Eugène Henri Dupont, marquis de Compiègne (1846-1877), on his return from the West coast replaced Georg Schweinfurth at Cairo as president of the geographical commission. Arising out of this circumstance de Compiègne was killed in a duel by a German named Mayer.

² A Franco-Belgian agreement of the 23rd of Dec. 1908 defined precisely the frontier in the lower Congo. Bamu Island in Stanley Pool was recognized as French.

the signature of the convention between Great Britain and the Congo State of the 12th of May of that year, against which both the German and the French governments protested, the last named because it erected a barrier against the extension of French territory to the Nile valley. By a compromise of the 14th of August the boundary was definitely drawn and, in accordance with this pact, which put the frontier back to about 4° N., France from 1895 to 1897 took possession of the upper Ubangi, with Bangasso, Rafai and Zemio. Then began the French encroachment on the Bahr-el-Ghazal; the Marchand expedition, despatched to the support of Victor Liotard, the lieutenant-governor of the upper Ubangi, reached Tambura in July 1897 and Fashoda in July 1898. A dispute with Great Britain arose, and it was decided that the expedition should evacuate Fashoda. The declaration of the 21st of March 1899 finally terminated the dispute, fixing the eastern frontier of the French colony as already stated. Thus, after the Franco-Spanish treaty of June 1900 settling the limits of the Spanish territory on the coast, the boundaries of the French Congo on all its frontiers were determined in broad outline. The Congo-Cameroon frontier was precisely defined by another Franco-German agreement in April 1908, following a detailed survey made by joint commissioners in 1905 and 1906. For a comprehensive description of these international rivalries see AFRICA, § 5, and for the conquest of the Chad regions see BAGIRMI and RABAH ZUBEIR. In the other portions of the colony French rule was accepted by the natives, for the most part, peaceably. For the relations of France with Wadai see that article.

Following the acquisitions for France of de Brazza, the ancient Gabun colony was joined to the Congo territories. From 1886 to 1889 Gabun was, however, separately administered. By decree of the 11th of December 1888 the whole of the French possessions were created one "colony" under the style of Congo français, with various subdivisions; they were placed under a commissioner-general (de Brazza) having his residence at Brazzaville. This arrangement proved detrimental to the economic development of the Gabun settlements, which being outside the limits of the free trade conventional basin of the Congo (see AFRICA, § 5) enjoyed a separate tariff. By decree of the 29th of December 1903 (which became operative in July 1904) Congo français was divided into four parts as named in the opening paragraph. The first commissioner-general under the new scheme was Emile Gentil, the explorer of the Shari and Chad. In 1905 de Brazza was sent out from France to investigate charges of cruelty and maladministration brought against officials of the colony, several of which proved well founded. De Brazza died at Dakar when on his way home. The French government, after considering the report he had drawn up, decided to retain Gentil as commissioner-general, making however (decree of 15th of February 1906) various changes in administration with a view to protect the natives and control the concession companies. Gentil, who devoted the next two years to the reorganization of the finances of the country and the development of its commerce, resigned his post in February 1908. He was succeeded by M. Merlin, whose title was changed (June 1908) to that of governor-general.

Administration and Revenue.—The governor-general has control over the whole of French Congo, but does not directly administer any part of it; the separate colonies being under lieutenant-governors. The Gabun colony includes the Gabun estuary and the whole of the coast-line of French Congo, together with the basin of the Ogowé river. The inland frontier is so drawn as to include all the hinterland not within the Congo free-trade zone (the Chad district excepted). The Middle Congo has for its western frontier the Gabun colony and Cameroon, and extends inland to the easterly bend of the Ubangi river; the two circumscriptions extend east and north of the Middle Congo. There is a general budget for the whole of French Congo; each colony has also a separate budget and administrative autonomy. As in other French colonies the legislative power is in the French chambers only, but in the absence of specific legislation presidential decrees have the force of law. A judicial system independent of the executive exists, but the district administrators also exercise judicial functions. Education is in the hands of the missionaries, upwards of 50 schools being established by 1909. The military force maintained consists of natives offered by Europeans.

Revenue is derived from taxes on land, rent paid by concession companies, a capitation or hut tax on natives, and customs receipts, supplemented by a subvention from France. In addition to defraying the military expenses, about £100,000 a year, a grant of £28,000 yearly was made up to 1906 by the French chambers towards the civil expense. In 1907 the budget of the Congo balanced at about £250,000 without the aid of this subvention. In 1909 the chambers sanctioned a loan for the colony of £840,000, guaranteed by France and to be applied to the establishment of administrative stations and public works.

BIBLIOGRAPHY.—Fernand Rouget, *L'Expansion coloniale au Congo français* (Paris, 1906), a valuable monograph, with bibliography and maps; A. Chevalier, *L'Afrique centrale française* (Paris, 1907). For special studies see Lacroix, *Résultats minéralogiques et zoologiques des récentes explorations de l'Afrique occidentale française et de la région du Tchad* (Paris, 1905); M. Barrat, *Sur la géologie du Congo français* (Paris, 1895), and *Ann. des mines*, sér. q. t. vii. (1895); J. Cornet, "Les Formations post-primaires du bassin du Congo," *Ann. soc. géol. belg.* vol. xxi. (1895). The Paris *Bulletin du Muséum* for 1903 and 1904 contains papers on the zoology of the country. For flora see numerous papers by A. Chevalier in *Comptes rendus de l'Académie des sciences* (1902-1904), and the *Journal d'agriculture pratique des pays chauds* (1901, &c.). For history, besides Rouget's book, see J. Ancel, "Étude historique. La formation de la colonie du Congo français, 1842-1888," containing an annotated bibliography, in *Bull. Com. l'Afrique française*, vol. xii. (1902), the works cited under BRAZZA; and E. Gentil, *La Chute de l'empire de Robah* (Paris, 1902). Of earlier books of travels the most valuable are:—Paul du Chaillu, *Explorations and Adventures in Equatorial Africa* (London, 1861); *A Journey to Ashonga Land* (London, 1867); and Sir R. Burton, *Two Trips to Gorilla Land* (London, 1876). Of later works see Mary H. Kingsley, *Travels in West Africa* (London, 1897); A. B. de Mézières, *Rapport de mission sur le Haut Oubangui, le M'Bomou et le Bahr-el-Ghazal* (Paris, 1903); and C. Maistre, *A travers l'Afrique centrale du Congo au Niger, 1862-1891* (Paris, 1895). For the story of the concession companies see E. D. Morel, *The British Case in French Congo* (London, 1903). (F. R. C.)

FRENCH GUINEA, a French colony in West Africa, formerly known as Rivières du Sud. It is bounded W. by the Atlantic, N. by Portuguese Guinea and Senegal, E. by Upper Senegal and the Ivory Coast, and S. by Liberia and Sierra Leone. With a sea-board running N.N.W. and S.S.E. from 10° 50' N. to 6° 2' N., a distance, without reckoning the indentations, of 170 m., the colony extends eastward 450 m. in a straight line and attains a maximum width N. to S. of nearly 300 m., covering fully 100,000 sq. m., and containing a population estimated at 2,000,000 to 2,500,000.

Physical Features.—Though in one or two places rocky headlands jut into the sea, the coast is in general sandy, low, and much broken by rivers and deep estuaries, dotted with swampy islands, giving it the appearance of a vast delta. In about 9° 30' N., off the promontory of Konakry, lie the Los Islands (q.v.), forming part of the colony. The coast plain, formed of alluvial deposits, is succeeded about 30 m. inland by a line of cliffs, the Susu Hills, which form the first step in the terrace-like formation of the interior, culminating in the massif of Futa Jallon, composed chiefly of Archean and granite rocks. While the coast lands are either densely forested or covered with savannas or park-like country, the Futa Jallon tableland is mainly covered with short herbage. This tableland, the hydrographic centre of West Africa, is most elevated in its southern parts, where heights of 3000 ft. are found. Near the Sierra Leone frontier this high land is continued westward to within 20 m. of the sea, where Mount Kakulima rises over 3300 ft. East and south of Futa Jallon the country slopes to the basin of the upper Niger, the greater part of which is included in French Guinea. The southern frontier is formed by the escarpments which separate the Niger basin from those of the coast rivers of Liberia. Besides the Niger, Gambia and Senegal, all separately noticed, a large number of streams running direct to the Atlantic rise in Futa Jallon. Among them are the Great and Little Scarcies, whose lower courses are in Sierra Leone, and the Rio Grande which enters the sea in Portuguese Guinea. Those whose courses are entirely in French Guinea include the Cogon (or Componi), the Rio Nuñez, the Fatalla (which reaches the sea through an estuary named Rio Pongo), the Konkure, whose estuary is named Rio Bramaya, the Forekaria and the Melakori. The Cogon, Fatallah and Konkure are all large rivers which descend from the plateaus through deep, narrow valleys in rapids and cataracts, and are only navigable for a few miles from their mouth.

Climate.—The climate of the coast district is hot, moist and unhealthy, with a season of heavy rain lasting from May to November, during which time variable winds, calms and tornadoes succeed one another. The mean temperature in the dry season, when the "harmattan" is frequent, is 62° Fahr., in the wet season 86°. Throughout the year the humidity of the air is very great. There is much rain in the Futa Jallon highlands, but the Niger basin is somewhat drier. In that region and in the highlands the climate is fairly healthy for Europeans and the heat somewhat less than on the coast.

Flora and Fauna.—The seashore and the river banks are lined with mangroves, but the most important tree of the coast belt is the oil-palm. The dense forests also contain many varieties of lianas or rubber vines, huge banyan and bamboos. Gum-producing and kola trees are abundant, and there are many fruit trees, the orange and citron growing well in the Susu and Futa Jallon districts. The cotton and coffee plants are indigenous; banana plantations surround the villages. The baobab and the karite (shea butter tree) are found only in the Niger districts. The fauna is not so varied as was formerly the case, large game having been to a great extent driven out of the coast regions. The elephant is rare save in the Niger regions. The lion is now only found in the northern parts of Futa Jallon; panthers, leopards, hyenas and wild cats are more common and the civet is found. Hippopotamus, otter and the wild boar are numerous; a species of wild ox of small size with black horns and very agile is also found. The forests contain many kinds of monkeys, including huge chimpanzees; antelope are widespread but rather rare. Serpents are very common, both venomous and non-venomous; the pythons attain a great size. Fights between these huge serpents and the crocodiles which infest all the rivers are said to be not uncommon. Turtles are abundant along the coasts and in the Los Islands. Oysters are found in large numbers in the estuaries and fixed to the submerged parts of the mangroves. Fresh-water oysters, which attain a large size, are also found in the rivers, particularly in the Niger. Fish are abundant, one large-headed species, in the Susu tongue called *khokon*, is so numerous as to have given its name to a province, Kokuina. Birds are very numerous; they include various eagles, several kinds of heron, the egret, the marabout, the crane and the pelican; turacos or plantain-eaters, are common, as are other brilliantly plumaged birds. Green and grey parrots, ravens, swallows and magpies are also common.

Inhabitants.—On the banks of the Cogon dwell the Tendas and Iolas, primitive Negro tribes allied to those of Portuguese Guinea (q.v.). All other inhabitants of French Guinea are regarded as comparatively late arrivals from the interior who have displaced the aborigines.¹ Among the earliest of the new comers are the Baga, the Nalu, the Landuman and the Timni, regarded as typical Negroes (q.v.). This migration southward appears to have taken place before the 17th century. To day the Baga occupy the coast land between the Cogon and the Rio Pongo, and the Landuman the country immediately behind that of the Baga. The other tribes named are but sparsely represented in French Guinea, the coast region south of the Nuñez and all the interior up to Futa Jallon being occupied by the Susu, a tribe belonging to the great Mandingian race, which forced its way seaward about the beginning of the 18th century and pressed back the Timni into Sierra Leone. Futa Jallon is peopled principally by Fula (q.v.), and the rest of the country by Malinké and other tribes of Mandingo (q.v.). The Mandingo, the Fula and the Susu are Mahomedans, though the Susu retain many of their ancient rites and beliefs—those associated with spirit worship and fetish, still the religion of the Baga and other tribes. In the north-west part of Futa Jallon are found remnants of the aborigines, such as the Tiapi, Koniagi and the Bassari, all typical Negro tribes. The white inhabitants number a few hundreds only and are mainly French. Many of the coast peoples show, however, distinct traces of white blood, the result chiefly of the former presence of European slave traders. Thus at the Rio Pongo there are numerous mulattos. South of that river the coast tribes speak largely pidgin English.

Towns.—The principal towns are Konakry the capital, Boké, on the Rio Nuñez, Dubreka, on the coast, a little north of Konakry, Benty, on the Melakori, Timbo and Labe, the chief towns of Futa Jallon, Heremakono and Kindia, on the main road to the Niger, Kurussa and Siguri, on a navigable stretch of that river, and Bissandugu, formerly Samory's capital, an important military station east of the Niger. Konakry, in 9° 30' N., 13° 46' W., population about 20,000, is the one port of entry on the coast. It is built on the little island of Tombo which lies off the promontory of Konakry, the town being joined to the mainland by an iron bridge. During the administration of Noël Ballay (1848-1902), governor of the colony 1890-1900, Konakry was transformed from a place of small importance to one of the chief ports on the west coast of Africa and a serious rival to Freetown, Sierra Leone. It has since grown considerably, and is provided with wharves and docks and a jetty 1066 ft. long. There is an ample supply of good water, and a large public garden in the centre of the town. In front of Government House is a statue of M. Ballay. Konakry is a port of call for French, British and German steamship companies, and is in telegraphic communication with Europe. It is the starting-point of a railway to the Niger (see below). The retail trade is in the hands of Syrians. The town is governed by a municipality.

Products and Industry.—French Guinea possesses a fertile soil, and is rich in tropical produce. The chief products are rubber, brought from the interior, and palm oil and palm kernels, obtained in the coast regions. Cotton is cultivated in the Niger basin. Gum copal, ground-nuts and sesame are largely cultivated, partly for

¹ Numerous remains of a stone age have been discovered, both on the coast and in the hinterland. See L. Desplagnes, "L'Archéologie préhistorique en Guinée française," in *Bull. Soc. Géol. Com. de Bordeaux*, March 1907, and the authorities there cited.

export. Among minor products are coffee, wax and ivory. Large herds of cattle and flocks of sheep are raised in Futa Jallon; these are sent in considerable numbers to Sierra Leone, Liberia and French Congo. The trade in hides is also of considerable value. The chief grain raised is millet, the staple food of the people. The rubber is mainly exported to England, the palm products to Germany, and the ground-nuts to France.

The principal imports are cotton goods, of which 80% come from Great Britain, rice, kola nuts, chiefly from Liberia, spirits, tobacco, milling material, and arms and ammunition, chiefly "trade guns." The average annual value of the trade for the period 1900-1907 was about £1,250,000, the annual export of rubber alone being worth 400,000 or more. The great bulk of the trade of the colony is with France and Great Britain, the last-named country taking about 5% of the total; Germany comes third. Since April 1905 a surtax of 7% has been imposed on all goods of other than French origin.

Communications.—The railway from Konakry to the Niger at Kurussa, by the route chosen a distance of 342 m., was begun in 1900, and from 1902 has been built directly by the colony. The first section to Kindia, 93 m., was opened, in 1904. The second section, to near Timbo in Futa Jallon, was completed in 1907, and the rails reached Kurussa in 1910. From Kurussa the Niger is navigable at high water all the way to Bamako in Upper Senegal, whence there is communication by rail and river with St. Louis and Timbuktu. Besides the railway there is an excellent road, about 100 m. long, from Konakry to Kurussa, the road in its lower part lying close to the Sierra Leone frontier, with the object of diverting trade from that British colony. Several other main roads have been built by the French, and there is a very complete telegraphic system, the lines having been connected with those of Senegal in 1899.

History.—This part of the Guinea coast was made known by the Portuguese voyagers of the 15th century. In consequence, largely, of the dangers attending its navigation, it was not visited by the European traders of the 16th-18th centuries so frequently as other regions north and east, but in the Rio Pongo, at Matatong (a diminutive island near the mouth of the Forekaria), and elsewhere, slave traders established themselves, and ruins of their strongholds they built, and defended with cannon, still exist. When driven from other parts of Guinea the slavers made this difficult and little known coast one of their last resorts, and many barracoons were built in the late years of the 18th century. It was not until after the restoration of Goree to her at the close of the Napoleonic wars that France evinced any marked interest in this region. At that time the British, from their bases at the Gambia and Sierra Leone, were devoting considerable attention to these Rivières du Sud (i.e. south of Senegal) and also to Futa Jallon. René Caillié, who started his journey to Timbuktu from Boké in 1827, did much to quicken French interest in the district, and from 1838 onward French naval officers, Bouët-Willamez and his successors, made detailed studies of the coast. About the time that the British government became wearied of its efforts to open up the interior of West Africa, General Faidherbe was appointed governor of Senegal (1854), and under his direction vigorous efforts were made to consolidate French influence. Already in 1848 treaty relations had been entered into with the Nahr, and between that date and 1865 treaties of protectorate were signed with several of the coast tribes. During 1876-1880 new treaties were concluded with the chief tribes, and in 1881 the almanj (or emir) of Futa Jallon placed his country under French protection, the French thus effectually preventing the junction, behind the coast lands, of the British colonies of the Gambia and Sierra Leone. The right of France to the littoral as far south as the basin of the Melakori was recognized by Great Britain in 1882; Germany (which had made some attempt to acquire a protectorate at Konakry) abandoned its claims in 1885, while in 1886 the northern frontier was settled in agreement with Portugal, which had ancient settlements in the same region (see PORTUGUESE GUINEA). In 1899 the limits of the colony were extended, on the dismemberment of the French Sudan, to include the upper Niger districts. In 1904 the Los Islands were ceded by Great Britain to France, in part return for the abandonment of French fishing rights in Newfoundland waters. (See also SENEGAL: History.)

French Guinea was made a colony independent of Senegal in 1891, but in 1895 came under the supreme authority of the newly constituted governor-generalship of French West Africa. Guinea has a considerable measure of autonomy and a separate budget.

It is administered by a lieutenant-governor, assisted by a nominated council. Revenue is raised principally from customs and a capitation tax, which has replaced a hut tax. The local budget for 1907 balanced at £205,000. Over the greater part of the country the native princes retain their sovereignty under the superintendence of French officials. The development of agriculture and education are objects of special solicitude to the French authorities. In general the natives are friendly towards their white masters.

See M. Famechon, *Notice sur la Guinée française* (Paris, 1900); J. Chautard, *Étude géographique et géologique sur le Fouta-Djallon* (Paris, 1905); André Arcin, *La Guinée française* (Paris, 1906), a valuable monograph; J. Machat, *Les Rivières du Sud et la Fouta-Djallon* (Paris, 1906), another valuable work, containing exhaustive bibliographies. Consult also F. Rouget, *La Guinée* (Paris, 1908), an official publication, the annual *Annuaire* on French West Africa, published by the British Foreign Office, and the *Carte de la Guinée française* by A. Méunier in 4 sheets on the scale 1: 500,000 (Paris, 1902).

FRENCH LANGUAGE. I. Geography.—French is the general name of the north-north-western group of Romanic dialects, the modern Latin of northern Gaul (carried by emigration to some places—as lower Canada—out of France). In a restricted sense it is that variety of the Parisian dialect which is spoken by the educated, and is the general literary language of France. The region in which the native language is termed French consists of the northern half of France (including Lorraine) and parts of Belgium and Switzerland; its boundaries on the west are the Atlantic Ocean and the Celtic dialects of Brittany; on the north-west and north, the English Channel; on the north-east and east the Teutonic dialects of Belgium, Germany and Switzerland. In the south-east and south the boundary is to a great extent conventional and ill-defined, there being originally no linguistic break between the southern French dialects and the northern Provençal dialects of southern France, north-western Italy and south-western Switzerland. It is formed partly by spaces of intermediate dialects (some of whose features are French, others Provençal), partly by spaces of mixed dialects resulting from the invasion of the space by more northern and more southern settlers, partly by lines where the intermediate dialects have been suppressed by more northern (French) and more southern (Provençal) dialects without these having mixed. Starting in the west at the mouth of the Gironde, the boundary runs nearly north soon after passing Bordeaux; a little north of Angoulême it turns to the east, and runs in this direction into Switzerland to the north of Geneva.

II. External History.—(a) *Political.*—By the Roman conquests the language of Rome was spread over the greater part of southern and western Europe, and gradually supplanted the native tongues. The language introduced was at first nearly uniform over the whole empire, Latin provincialisms and many more or less general features of the older vulgar language being suppressed by the preponderating influence of the educated speech of the capital. As legions became stationary, as colonies were formed, and as the natives adopted the language of their conquerors, this language split up into local dialects, the distinguishing features of which are due, as far as can be ascertained (except, to some extent, as to the vocabulary), not to speakers of different nationalities mispeaking Latin, each with the peculiarities of his native language, but to the fact that linguistic changes, which are ever occurring, are not perfectly uniform over a large area, however homogeneous the speakers. As Gaul was not conquered by Caesar till the middle of the first century before our era, its Latin cannot have begun to differ from that of Rome till after that date; but the artificial retention of classical Latin as the literary and official language after the popular spoken language had diverged from it, often renders the chronology of the earlier periods of the Romanic languages obscure. It is, however, certain that the popular Latin of Gaul had become differentiated from that of central Italy before the Teutonic conquest of Gaul, which was not completed till the latter half of the 5th century; the invaders gradually adopted the language of their more civilized subjects, which remained unaffected, except in its vocabulary. Probably by this time it had diverged

so widely from the artificially preserved literary language that it could no longer be regarded merely as mispronounced Latin; the Latin documents of the next following centuries contain many clearly popular words and forms, and the literary and popular languages are distinguished as *latino* and *romano*. The term *gallica*, at first denoting the native Celtic language of Gaul, is found applied to its supplanter before the end of the 9th century, and survives in the Breton *gallek*, the regular term for "French." After the Franks in Gaul had abandoned their native Teutonic language, the term *francisca*, by which this was denoted, came to be applied to the Romanic one they adopted, and, under the form *françoise*, remains its native name to this day; but this name was confined to the Romanic of northern Gaul, which makes it probable that this, at the time of the adoption of the name *francisca*, had become distinct from the Romanic of southern Gaul. *Francisca* is the Teutonic adjective *fränkisch*, which occurs in Old English in the form *frænise*, this word, with its unlauded *e* from *a* with following *i*, survives under the form *French*, which, though purely Teutonic in origin and form, has long been exclusively applied to the Romanic language and inhabitants of Gaul. The German name *framose*, with its accent on, and *o* in, the second syllable, comes from *françois*, a native French form older than *françois*, but later than the Early Old French *francisc*. The Scandinavian settlers on the north-west coast of France early in the 10th century quickly lost their native speech, which left no trace except in some contributions to the vocabulary of the language they adopted. The main feature since is the growth of the political supremacy of Paris, carrying with it that of its dialect; in 1539 Francis I. ordered that all public documents should be in French (of Paris), which then became the official language of the whole kingdom, though it is still foreign to nearly half its population.

The conquest of England in 1066 by William, duke of Normandy, introduced into England, as the language of the rulers and (for a time) most of the writers, the dialects spoken in Normandy (see also ANGLONORMAN LITERATURE). Confined in their native country to definite areas, these dialects, following their speakers, became mixed in England, so that their forms were used to some extent indifferently; and the constant communication with Normandy maintained during several reigns introduced also later forms of continental Norman. As the conquerors learned the language of the conquered, and as the more cultured of the latter learned that of the former, the Norman of England (including that of the English-speaking Lowlands of Scotland) became anglicized; instead of following the changes of the Norman of France, it followed those of English. The accession in 1154 of Henry II. of Anjou disturbed the Norman character of Anglo-French, and the loss of Normandy under John in 1204 gave full play to the literary importance of the French of Paris, many of whose forms afterwards penetrated to England. At the same time English, with a large French addition to its vocabulary, was steadily recovering its supremacy, and is officially employed (for the first time since the Conquest) in the Proclamation of Henry III., 1258. The semi-artificial result of this mixture of French of different dialects and of different periods, more or less anglicized according to the date or education of the speaker or writer, is generally termed "the Anglo-Norman dialect"; but the term is misleading for a great part of its existence, because while the French of Normandy was not a single dialect, the later French of England came from other French provinces besides Normandy, and being to a considerable extent in artificial conditions, was checked in the natural development implied by the term "dialect." The disuse of Anglo-French as a natural language is evidenced by English being substituted for it in legal proceedings in 1362, and in schools in 1387, but law reports were written in it up to about 1600, and, converted into modern literary French, it remains in official use for giving the royal assent to bills of parliament.

(b) *Literary*.—Doubtless because the popular Latin of northern Gaul changed more rapidly than that of any other part of the empire, French was, of all the Romanic dialects, the first to be

recognized as a distinct language, and the first to be used in literature; and though the oldest specimen now extant is probably not the first, it is considerably earlier than any existing documents of the allied languages. In 813 the council of Tours ordered certain homilies to be translated into Rustic Roman or into German; and in 842 Louis the German, Charles the Bald, and their armies confirmed their engagements by taking oaths in both languages at Strassburg. These have been preserved to us by the historian Nithard (who died in 853); and though, in consequence of the only existing manuscript (at Paris) being more than a century later than the time of the author, certain alterations have occurred in the text of the French oaths, they present more archaic forms (probably of North-Eastern French) than any other document. The next memorials are a short poem, probably North-Eastern, on St Eulalia, preserved in a manuscript of the 10th century at Valenciennes, and some autograph fragments (also at Valenciennes) of a homily on the prophet Jonah, in mixed Latin and Eastern French, of the same period. To the same century belong a poem on Christ's Passion, apparently in a mixed (not intermediate) language of French and Provençal and one, probably in South-Eastern French, on St Leger; both are preserved, in different handwritings, in a MS. at Clermont-Ferrand, whose scribes have introduced many Provençal forms. After the middle of the 11th century literary remains are comparatively numerous; the chief early representative of the main dialects are the following, some of them preserved in several MSS., the earliest of which, however (the only ones here mentioned), are in several cases a generation or two later than the works themselves. In Western French are a verse life of St Alexis (Alexis), probably Norman, in an Anglo-Norman MS. at Hildesheim; the epic poem of Roland, possibly also Norman, in an A.-N. MS. at Oxford; a Norman verbal translation of the Psalms, in an A.-N. MS. also at Oxford; another later one, from a different Latin version, in an A.-N. MS. at Cambridge; a Norman translation of the Four Books of Kings, in a probably A.-N. MS. at Paris. The earliest work in the Parisian dialect is probably the Travels of Charlemagne, preserved in a late Anglo-Norman MS. with much altered forms. In Eastern French, of rather later date, there are translations of the Dialogues of Pope Gregory, in a MS. at Paris, containing also fragments of Gregory's Moralities, and (still later) of some Sermons of St Bernard, in a MS. also in Paris. From the end of the 12th century literary and official documents, often including local charters, abound in almost every dialect, until the growing influence of Paris caused its language to supersede in writing the other local ones. This influence, occasionally apparent about the end of the 12th century, was overpowering in the 15th, when authors, though often displaying provincialisms, almost all wrote in the dialect of the capital, the last dialect to lose its literary independence was the North-Eastern, which, being the Romanic language of Flanders, had a political life of its own, and (modified by Parisian) was used in literature after 1400.

III. *Internal History*.—Though much has been done in recent years, in the scientific investigation of the sounds, inflections, and syntax of the older stages and dialects of French, much still remains to be done, and it must suffice here to give a sketch, mainly of the dialects which were imported into England by the Normans—in which English readers will probably take most interest, and especially of the features which explain the forms of English words of French origin. Dates and places are only approximations, and many statements are liable to be modified by further researches. The primitive Latin forms given are often not classical Latin words, but derivatives from these; and reference is generally made to the Middle English (Chaucerian) pronunciation of English words, not the modern.

(a) *Vocabulary*.—The fundamental part of the vocabulary of French is the Latin imported into Gaul, the French words being simply the Latin words themselves, with the natural changes undergone by all living speech, or derivatives formed at various dates. Comparatively few words were introduced from the Celtic language of the native inhabitants (*bee*, *fiaw* from the Celtic words given by Latin writers as *beccus*, *leuca*), but the number

adopted from the language of the Teutonic conquerors of Gaul is large (*guerre*=*werra*; *laid*=*laidd*; *choisir*=*kausjan*). The words were imported at different periods of the Teutonic supremacy, and consequently show chronological differences in their sounds (*hair*=*hatan*; *français*=*frankish*; *brevisse*=*krebis*; *échine*=*skina*). Small separate importations of Teutonic words resulted from the Scandinavian settlement in France, and the commercial intercourse with the Low German nations on the North Sea (*friper*=Norse *kripa*; *chalonpe*=Dutch *sloop*; *est*=Old English *east*). In the meantime, as Latin (with considerable alterations in pronunciation, vocabulary, &c.) continued in literary, official and ecclesiastical use, the popular language borrowed from time to time various more or less altered classical Latin words; and when the popular language came to be used in literature, especially in that of the church, these importations largely increased (*virginiet* Eulalia = *virginildem*; *imagena* Alexia = *imagineum*—the popular forms would probably have been *vergedel*, *emain*). At the Renaissance they became very abundant, and have continued since, stilling to some extent the developmental power of the language. Imported words, whether Teutonic, classical Latin or other, often receive some modification at their importation, and always take part in all subsequent natural phonetic changes in the language (Early Old French *adversarie*, Modern French *adversaire*). Those French words which appear to contradict the phonetic laws were mostly introduced into the language after the taking place (in words already existing in the language) of the changes formulated by the laws in question; compare the late imported *laïque* with the inherited *lai*, both from Latin *laicum*. In this and many other cases the language possesses two forms of the same Latin word, one descended from it, the other borrowed (*meuble* and *mobile* from *mobilis*). Some Oriental and other foreign words were brought in by the crusaders (*amiral* from *amir*); in the 16th century, wars, royal marriages and literature caused a large number of Italian words (*soldat*=*soldato*; *brave*=*bravo*; *caresser*=*carezzare*) to be introduced, and many Spanish ones (*alcebe*=*alcoba*; *habler*=*hablar*). A few words have been furnished by Provençal (*abeille*, *codenas*), and several have been adopted from other dialects into the French of Paris (*esquiver* Norman or Picard for the Paris-French *eschiver*). German has contributed a few (*bloch*=*bloch*; *choucroute*=*stürkrut*); and recently a considerable number have been imported from England (*drain*, *confortable*, *firter*). In Old French, new words are freely formed by derivation, and to a less extent by composition; in Modern French, borrowing from Latin or other foreign languages is the more usual course. Of the French words now obsolete some have disappeared because the things they express are obsolete; others have been replaced by words of native formation, and many have been superseded by foreign words generally of literary origin; of those which survive, many have undergone considerable alterations in meaning. A large number of Old French words and meanings, now extinct in the language of Paris, were introduced into English after the Norman Conquest; and though some have perished, many have survived—*strife* from Old French *estrif* (Teutonic *strit*); *quaint* from *cointe* (*cognitum*); *remember* from *rememorer* (*rememorare*); *chaplet* (garland) from *chapelet* (Modern French "chaplet of beads"); *appointment* (rendezvous) from *appointement* (now "salary"). Many also survive in other French dialects.

(b) *Dialects*.—The history of the French language from the period of its earliest extant literary memorials is that of the dialects composing it. But as the popular notion of a dialect as the speech of a definite area, possessing certain peculiarities confined to and extending throughout that area, is far from correct, it will be advisable to drop the misleading divisions into "Norman dialect," "Picard dialect" and the like, and take instead each important feature in the chronological order (as far as can be ascertained) of its development, pointing out roughly the area in which it exists, and its present state. The local terms used are intentionally vague, and it does not, for instance, at all follow that because "Eastern" and "Western" are used to denote the localities of more than one dialectal feature, the

boundary line between the two divisions is the same in each case. It is, indeed, because dialectal differences as they arise do not follow the same boundary lines (much less the political divisions of provinces), but cross one another to any extent, that to speak of the dialect of a large area as an individual whole, unless that area is cut off by physical or alien linguistic boundaries, creates only confusion. Thus the Central French of Paris, the ancestor of classical Modern French, agrees with a more southern form of Romanic (Limousin, Auvergne, Forez, Lyonnais, Dauphiné) in having *ts*, not *tsh*, for Latin *t* (*c*) before *i* and *e*; *tsh*, not *t*, for *k* (*c*) before *a*; and with the whole South in having *gs*, not *w*, for Teutonic *w*; while it belongs to the East in having *ei* for earlier *ei*; and to the West in having *é*, not *ei*, for Latin *a*; and *i*, not *ei*, from Latin *e+i*. It may be well to denote that Southern French does not correspond to southern France, whose native language is Provençal. "Modern French" means ordinary educated Parisian French.

(c) *Phonology*.—The history of the sounds of a language is, to a considerable extent, that of its inflections, which, no less than the body of a word, are composed of sounds. This fact, and the fact that unconscious changes are much more reducible to law than conscious ones, render the phonology of a language by far the surest and widest foundation for its dialectology, the importance of the sound-changes in this respect depending, not on their prominence, but on the earliness of their date. For several centuries after the divergence between spoken and written Latin, the history of these changes has to be determined mainly by reasoning, aided by a little direct evidence in the misspellings of inscriptions the semi-popular forms in glossaries, and the warnings of Latin grammarians against vulgarities. With the rise of Romanic literature the materials for tracing the changes become abundant, though as they do not give us the sounds themselves, but only their written representations, much difficulty, and some uncertainty, often attach to deciphering the evidence. Fortunately, early Romanic orthography, that of Old French included (for which see next section), was phonetic, as Italian orthography still is; the alphabet was imperfect, as many new sounds had to be represented which were not provided for in the Roman alphabet from which it arose, but writers aimed at representing the sounds they uttered, not at using a fixed combination of letters for each word, however they pronounced it.

The characteristics of French as distinguished from the allied languages and from Latin, and the relations of its sounds, inflections and syntax to those of the last-named language, belong to the general subject of the Romanic languages. It will be well, however, to mention here some of the features in which it agrees with the closely related Provençal, and some in which it differs. As to the latter, it has already been pointed out that the two languages glide insensibly into one another, there being a belt of dialects which possess some of the features of each. French and Provençal of the 10th century—the earliest date at which documents exist in both—agree to a great extent in the treatment of Latin final consonants and the vowels preceding them, a matter of great importance for inflections (numerous French examples occur in this section). (1) They reject all vowels, except *a*, of Latin final (unaccented) syllables, unless preceded by certain consonant combinations or followed by *nt* (here, as elsewhere, certain exceptions cannot be noticed); (2) they do not reject a similarly situated; (3) they reject final (unaccented) *m*; (4) they retain final *s*. French and Northern Provençal also agree in changing Latin *g* from a labio-guttural to a labio-palatal vowel; the modern sound (German *ü*) of the accented vowel of French *lune*, Provençal *luna*, contrasting with that in Italian and Spanish *luna*, appears to have existed before the earliest extant documents. The final vowel laws generally apply to the unaccented vowel preceding the accented syllable, if it is preceded by another syllable, and followed by a single consonant—*main* (*māitūnum*), *dortoir* (*dormitōrium*), with *yowel* dropped; *canevas* (*cannabaccum*), *armature*, later *armēure*, now *armūram*), with *e=2*, as explained below.

On the other hand, French differs from Provençal: (1) in uniformly preserving (in Early Old French) Latin final *t*, which

is generally rejected in Provençal—French *aimet* (Latin *amat*), Provençal *ama*; *aiment* (*amant*), Prov. *aman*; (2) in always rejecting, absorbing or consonantizing the vowel of the last syllable but one, if unaccented; in such words as *angele* (often spelt *angle*), the *e* after the *g* only serves to show its soft sound—French *veindre* (now *vaincre*, Latin *vincere*), Prov. *veucer*, with accent on first syllable; French *escandire* (*scandalum*), Prov. *escandol*; French *olie* (dissyllabic, *i=y* consonant, now *huile*), Prov. *oli* (*oleum*); (3) in changing accented *a* not in position into *ai* before nasals and gutturals and not after a palatal, and elsewhere into *é* (West French) or *ei* (East French), which develops an *i* before it when preceded by a palatal—French *main* (Latin *manum*), Prov. *man*; *aigre* (*acrem*), *agre*; *de* (*alam*), East French *cile*, Prov. *ala*; *meitié* (*medietatem*), East French *moitié*, Prov. *meiat*; (4) in changing *a* in unaccented final syllables into the vowel *ɛ*, intermediate to *a* and *e*; this vowel is written *a* in one or two of the older documents, elsewhere *e*—French *aimé* (Latin *amā*), Prov. *ama*; *aimés* (*amās*), Prov. *amas*; *aimet* (*amat*), Prov. *ama*; (5) in changing original *au* into *ō*—French *our* (*aurum*), Prov. *aur*; *rober* (Teutonic *raubōn*), Prov. *raubar*; (6) in changing general Romanic *ē*, from accented *e* and *i* not in position, into *ei*—French *veine* (*vēnam*), Prov. *veno*; *peil* (*pīlum*), Prov. *pel*.

As some of the dialectal differences were in existence at the date of the earliest extant documents, and as the existing materials, till the latter half of the 11th century, are scanty and of uncertain locality, the chronological order (here adopted) of the earlier sound-changes is only tentative.

(1) Northern French has *tsh* (written *c* or *ch*) for Latin *k* (*c*) and *t* before palatal vowels, where Central and Southern French have *t* (written *c* or *z*)—North Norman and Picard *chire* (*cīram*), *brach* (*brāchium*), *plache* (*plateam*); Parisian, South Norman, &c., *cire*, *brax*, *place*. Before the close of the Early Old French period (12th century) *t* loses its initial consonant, and the same happened to *tsh* a century or two later; with this change the old distinction is maintained—Modern Guernsey and Picard *chire*, Modern Picard *plache* (in ordinary Modern French spelling); usual French *cire*, *place*. English, having borrowed from North and South Norman (and later Parisian), has instances of both *tsh* and *t*: the former in comparatively small number—*chisel* (Modern French *ciseau* = (?) *caesellum*), *escutcheon* (*écusson*, *scutūnem*); *city* (*ciē*, *ciuitātem*), *place*. (2) Initial Teutonic *w* is retained in the north-east and along the north coast; elsewhere, as in the other Romance languages, was prefixed—Picard, &c., *wardé* (Teutonic *warda*), *werre* (*werro*); Parisian, &c., *garde*, *guarde*. In the 12th century the *u* or *o* of *w* dropped, giving the Modern French *garde*, *guerre* (with *gu=g*); *w* remains in Picard and Walloon, but in North Normandy it becomes *u*—Modern Guernsey *uason*, Walloon *wason*, Modern French *gazon* (Teutonic *wason*). English has both forms, sometimes in words originally the same—*wage* and *gage* (Modern French *gage*, Teutonic *wadi*); *warden* and *guardian* (*gardien*, *warding*). (3) Latin *b* after accented *a* in the imperfect of the first conjugation, which becomes *v* in Eastern French, in Western French further changes to *w*, and forms the diphthong *ou* with the preceding vowel—Norman *amoué* (*amābam*), *portout* (*portābat*); Burgundian *amece*, *portevet*. *-eve* is still retained in some places, but generally the imperfect of the first conjugation is assimilated to that of the others—*amoi*, like *avoit* (*habēbat*). (4) The palatalization of every then existing *k* and *g* (hard) when followed by *a*, *i* or *e*, after having caused the development of *i* before the *e* (East French *ei*) derived from *a* not in position, is abandoned in the north, the consonants returning to ordinary *k* or *g*, while in the centre and south they are assimilated to *tsh* or *tsh-ſ*—North Norman and Picard *cachier* (*captiāre*), *hier* (*cīrum*), *ose* (*causam*), *eschier* (Teutonic *schinban*), *wiket* (Teutonic *wik-i-tūm*), *gal* (*gallum*), *gardin* (from Teutonic *gard*); South Norman and Parisian *chacier*, *chier*, *chase*, *eschier*, *güchet*, *jul*, *jardin*. Probably in the 14th century the initial consonant of *tsh*, *dsh* disappeared, giving the modern French *chasse*, *jardin* with *ch=sh* and *j=sh*; but *tsh* is retained in Walloon, and *dsh* in Lorraine. The Northern forms survive—Modern Guernsey *cachier*, *gardin*; Picard *cachier*, *gardin*. English possesses numerous examples of both forms, sometimes in related words—*catch* and *chase*; *wicket*, *eschew*; *garden*, *jaundice* (*juvnisce*, from *galbanum*). (5) For Latin accented *a* not in position Western French usually has *é*, Eastern French *ei*, both of which take an *i* before them when a palatal precedes—Norman and Parisian *per* (*perem*), *oies* (*audiātis*); Lorraine *peir*, *oies*. In the 17th and 18th centuries close *é* changed to open *è*, except when final or before a silent consonant—*amer* (*amārum*) now having *è*, *aimer* (*amāre*) retaining *é*. English shows the Western close *é*—*peir* (Modern French *pair*, Old French *per*), *chief* (*chef*, *caput*); Middle High German the Eastern *ei*—*lameir* (Modern French *Famer*, *Faimer*, *la mer*=Latin *mare*). (6) Latin accented *a* not in position, when it came to be followed in Old French by *i* unites with *i* thus to form *ai* in the Western dialects, while the Eastern have the

diphthongs *ei*—Picard, Norman and Parisian *peire* (*peior*), *pis* (*pectus*); Burgundian *peire*, *peis*. The distinction is still preserved—Modern French *pire*, *pis*; Modern Burgundian *peire*, *pei*. English words show always *i*—*price* (*pris*, *pretium*) *spite* (*dēpit*, *dēspetium*). (7) The nasalization of vowels followed by a nasal consonant did not take place simultaneously with all the vowels. *a* and *e* before *ſ* (guttural *n*, as in *sing*), *ñ* (palatal *n*), *n* and *m* were nasal in the 11th century, such words as *lant* (*tantum*) and *gent* (*genium*) forming in the Alexis assonances to themselves, distinct from the assonances with *a* and *e* before non-nasal consonants. In the Roland *umbre* (*ombre*, *umbra*) and *culchet* (*couche*, *collocat*), *ſier* (*ſerum*) and *chiens* (*canēs*), *dil* (*dictum*) and *vint* (*venit*), *ceinte* (*cinclum*) and *veie* (*noie*, *viem*), *brun* (Teutonic *brūn*) and *ſut* (*ſuit*) assonate freely, though *a* (*u*) before nasals shows a tendency to separation. The nasalization of *i* and *a* (= Modern French *ai*) did not take place till the 16th century; and in all cases the loss of the following nasal consonant is quite modern, the older pronunciation of *lant*, *umbre* being *lant*, *ūmbra*, not as now *lā*, *ōbra*. The nasalization took place whether the nasal consonant was or was not followed by a vowel, *femme* (*fēminam*), *honneur* (*hōndrem*) being pronounced with nasal vowels in the first syllable till after the 16th century, as indicated by the doubling of the nasal consonant in the spelling and by the phonetic change (in *femme* and other words) next to be mentioned. English generally has *ax* (now often reduced to *a*) for Old French *ā*—*vanter* (*vantrē*, *vāntiāre*), *lazy* (*lānzē* (?) Celtic). (8) The assimilation of *ē* (nasal *e*) to *ā* (nasal *a*) did not begin till the middle of the 11th century, and is not yet universal, in France, though generally a century later. In the Alexis nasal *a* (as in *tant*) is never confounded with nasal *e* (as in *gent*) in the assonances, though the copyist (a century later) often writes *a* for nasal *e* in unaccented syllables, as in *amfant* (*enfant*, *infantem*); in the Roland there are several cases of mixture in the assonances, *gent*, for instance, occurring in *ant* stanzas, *lant* in *ent* ones. English has several words with *a* for *e* before nasals—*vanē* (*raug*, Old French *reuc*, Teutonic *hringō*), *pansy* (*pēnsēe*, *pēnsālam*); but the majority show *e*—*entier* (*entirē*, *intrāre*), *flam* (*flāme*, Old French *ſteme*, *pūctōtumum*). The distinction is still preserved in the Norman of Guernsey, where *an* and *en*, though both nasal, have different sounds—*lānchier* (*lancer*, *lançāre*), but *mētrie* (Old French *mēnerie*, from *mēntrī*). (9) The loss of *s*, or rather *z*, before voiced consonants began early, *z* being often omitted or wrongly inserted in 12th century MSS.—Earliest Old French *masle* (*masculum*), *sisdre* (*sticram*); Modern French *māle*, *cidre*. In English it has everywhere disappeared—*maie*, *cidre*; except in two words, where it appears, as occasionally in Old French, as *d*—*meddle* (*māler*, *miscādre*), *medlar* (*mēſler*, Old French also *meslier*, *mesplārium*). The loss of *z* before voiceless consonants (except *ſ*) is about two centuries later, and it is not universal even in Parisian—Early Old French *ſeste* (*festam*), *escuier* (*scūtiārum*); Modern French *ſic*, *écuyer*, but *espérer* (*spērāre*). In the north-east *s* before *t* is still retained—Walloon *cheſtat* (*chēteau*, *castellum*), *fiess* (*ſſie*). English shows *s* regularly—*ſeant*, *ſquire*. (10) Medial *dh* (*soft th*, as in *thien*), and final *th* from Latin *t* or *d* before vowels, do not begin to disappear till the latter half of the 11th century. In native French MSS, *dh* is generally written *d*, and *th* written *t*; but the German scribe of the Oaths writes *adjudha* (*adjudāre*), *codhuna* (Greek *katā* and *ūnam*); and the English one of the Alexis *contreſha* (*contrētām*), *lohet* (*laudātum*), and that of the Cambridge Psalter *heriteth* (*herēditātē*). Medial *dh* often drops even in the last-named MSS, and soon disappears; the same is true for final *th* in Western French—Modern French *contrée*, *loué*. But in Eastern French final *th*, to which Latin *t* between vowels had probably been reduced through *d* and *dh*, appears in the 12th century and later as *t*, rhyming on ordinary French final *t*—Picard and Burgundian *pechiet* (*peccātum*) *apeleit* (*appellātum*). In Western French some final *th* were saved by being changed to *f*—Modern French *soif* (*sitim*), *maif* (obsolete, *modum*). English has one or two instances of final *th*, none of medial *dh*—*ſaith* (*ſoi*, *ſidem*); Middle English *caritep* (*charitē*, *cariātē*), *drūſ* (Old French *drū*, Teutonic *drūd*); generally the consonant is lost—*country*, *charity*. Middle High German shows the Eastern French final consonant—*moralitēt* (*moralitē*, *mōrālītātē*). (11) *T* from Latin final *t*, if in an Old French unaccented syllable, begins to disappear in the Roland, where sometimes *aimet* (*amat*), sometimes *aimē*, is required by the metre, and soon drops in all dialects. The Modern French *t* of *aimet-t-il* and similar forms is an analogical insertion from such forms as *dort-il* (*dormit*), where the *t* has always existed. (12) The change of the diphthong *ai* to *ē* and afterwards to *è* (the doubling indicates length) had not taken place in the earliest French documents, words with *ai* assonating only on words with *a*; in the Roland such assonances occur, but those of *ai* on *è* are more frequent—*ſaire* (*ſacere*) assonating on *parastre* (*patraſter*) and on *eſtes* (*eſtis*); and the MS. (half a century later than the poem) occasionally has *ei* and *e* for *ai*—*reclēimē* (*reclāmat*), *deſſere* (*diſſacere*), the latter agreeing with the Modern French sound. Before nasals (as in *laine*=*lānam*) and *iē* (as in *payē*=*pāclum*), *ai* remained a diphthong up to the 16th century, being apparently *ei*, whose fate in this situation it has followed. English shows *ai* regularly before nasals and when final, and in a few other words—*vain* (*vāin*, *vānum*), *pay* (*payē*, *pācre*), *wait* (*quēter*, Teutonic *wahēn*); but before most consonants it has usually *è*—*poſſe* (*poſſi*, *pācum*), *ſeat* (*ſeſi*, *ſacum*). (13) The loss or transposition

of *i* (=y-consonant) following the consonant ending an accented syllable begins in the 12th century—Early Old French *gloire* (*glōriam*), *estude* (*studium*), *olie* (*oleum*); Modern French *gloire*, *étude*, *huile*. English sometimes shows the earlier form—*glory*, *study*; sometimes the later—*dowre* (*dowaire*, Early Old French *dowaire*, *dōwāriam*), *oil* (*huile*). (14) The vocalization of *l* preceded by a vowel and followed by a consonant becomes frequent at the end of the 12th century; when preceded by open *è*, an *è* developed before the *l* while this was a consonant—11th century *sauce* (*salsa*), *bellet* (*bellitatem*), *solder* (*solidāre*); Modern French *sauce*, *beauté*, *souder*. In Parisian, final *èl* followed the fate of *èl* before a consonant, becoming the triphthong *œs*, but in Norman the vocalization did not take place, and the *l* was afterwards rejected—Modern French *ruisseau*, Modern Guernsey *ruess* (*ruicellum*). English words of French origin sometimes show *l* before a consonant, but the general form is *w*—*scald* (*schauder*, *escalidāre*), *Walter* (*Gautier*, Teutonic *Waldhari*); *sauce*, *beauty*, *soder*. Final *èl* is kept—*veal* (*veau*, *vitellum*), *seal* (*secau*, *sigillum*). (15) In the east and centre *è* changes to *oi*, while the older sound is retained in the north-west and west—Norman *estrei* (*estroi*, *strictum*), *preis* (*proie*, *praedam*), 12th century Picard, Parisian, &c., *estroi*, *proie*. But the earliest (10th century) specimens of the latter group of dialects have *èi*—*pleier* (*player*, *placāre*) Eulalia, *meitriest* (*meitrai*, *mittere habebat*) Jonah. Parisian *oi*, whether from *èi* or from Old French *oi*, *oi*, became in the 15th century *oi* (spellings with *ou* or *oe* are not uncommon—*mivouer* for *mivour*, *miralōrium*), and in the following, in certain words, *è*, now written *ai*—*français*, *conscience*, from *françois* (*francus*, *francium*), *conscience* (*conscience*, *conscientia*), where it did not undergo the latter change it is now *ui* or *oi*—*roi* (*rei*, *rēgem*), *croix* (*crux*, *crucem*). Before nasals and palatal *l*, *è* (now = *è*) was kept—*seine* (*seina*), *veille* (*vigilia*), and it everywhere survives unalialized in Modern Norman—Guernsey *helle* (*helle*, *stella*) with *è*, *ser* (*soir*, *sērum*) with *è*. English shows generally *ei* (or *ai*) for original *èi*—*strait* (*estrai*), *prey* (*preis*); but in several words the later Parisian *oi*—*coy* (*col*, *quidam*), *loyal* (*loyal*, *legalem*). (16) The splitting of the vowel-sound from accented Latin *o* or *u* not in position, represented in Old French by *o* and *u* indifferently, into *u*, *o* (before nasals), and *eu* (the latter at first a diphthong, now = German *ö*), is unknown to Western French till the 12th century, and is not general in the east. The sound in 11th century Norman was much nearer to *u* (Modern French *ou*) than to *ö* (Modern French *ö*), as the words borrowed by English show *uu* (at first written *u*, afterwards *ou* or *ow*), never *öu*; but was probably not quite *u*, as Modern Norman shows the same splitting of the sound as Parisian. Examples are—Early Old French *époise* or *époise* (*spōsām*), *nom* or *nam* (*nōmem*), *flor* or *flur* (*flōrem*); Modern French *époise*, *nom*, *flour*; Modern Guernsey *soie* (*gūide*, *gūidam*), *som*, *flour*. Modern Picard also shows *u*, which is the regular sound before *r*—*flour*; but Modern Burgundian often keeps the original Old French *ö*—*no* (*nōs*, *nōs*). English shows almost always *uu*—*spouse*, *noun*, *flower* (Early Middle English *spuse*, *nan*, *flur*); but *nephew* with *eu* (*neveu*, *nepōtem*). (17) The loss of the *u* (or *ö*) of *qu* dates from the end of the 12th century—Old French *quart* (*quartum*), *quiter* (*quittere*) with *qu* = *kw*, Modern French *quart*, *quitter* with *qu* = *k*. In Walloon the *u* is preserved—*coudr* (*quart*), *cuitier*; as is the case in English—*quart*, *quilt*. The *w* of *gw* seems to have been lost rather earlier, English having simple *g*—*page* (*page*, older *guage*, Teutonic *wadi*), *guise* (*guise*, Teutonic *wisa*). (18) The change of the diphthong *ou* to *u* did not take place till after the 12th century, such words as *Anjou* (*Andegavum*) assonating in the Roland or *fort* (*fortem*); and did not occur in Picardy, where *ou* became *au* *caus* from older *éous*, *éols* (*caus*, *collōs*) coinciding with *caus* from *caus* (*causā*, *causās*). English keeps *ou* distinct from *uu*—*would* for *uu* (Modern French *voile*, *vōliam*), *soder* (*soder*, *solidāre*). (19) The change of the diphthong *ie* to simple *è* is specially Anglo-Norman in Old French of the Continent these sounds never rhyme, in that of England they constantly do, and English words show, with rare exceptions, the simple vowel—*ferce* (Old French *fiers*, *ferus*), *chief* (*chief*, *caput*), with *ie* = *è*; but *pannier* (*panier*, *panārium*). At the beginning of the modern period, Parisian dropped the *è* of *ie* when preceded by *ch* or *j*—*chef*, *abrégier* (Old French *abregier*, *abbreviare*); elsewhere (except in verbs) it is retained—*fer* (*ferum*), *pitie* (*pietatem*) Modern Guernsey retains it after *ch*—*ap'rchier* (*approcher adpropere*). (20) Some of the Modern French changes have found their places under older ones; those remaining to be noticed are so recent that English examples of the older forms are superfluous. In the 16th century the diphthong *au* changed to *oo* and then to *ö*, its present sound, rendering, for instance, *māux* (Old French *mals*, *malōs*) identical with *mots* (*mutōs*). The *au* of *eau* underwent the same change, but its *e* was still sounded as *è* (the *e* of *que*); in the next century this was dropped, making *seaux* (Old French *veils*, *vitellōs*) identical with *saux* (*sals*, *vollēs*). (21) A more general and very important change began much earlier than the last; this is the loss of many final consonants. In Early Old French every consonant was pronounced as written; by degrees many of them disappeared when followed by another consonant, whether in the same word (in which case they were generally omitted in writing) or in a following one. This was the state of things in the 16th century; those final consonants which are usually silent in Modern French were still sounded, if before a vowel or at the end of a sentence or a line of poetry, but generally not elsewhere. Thus a large number of

French words had two forms; the Old French *fort* appeared as *fōr* (though still written *fort*) before a consonant, *fort* elsewhere. At a later period, final consonants were lost (with certain exceptions) when the word stood at the end of a sentence or of a line of poetry; but they are generally kept when followed by a word beginning with a vowel. (22) A still later change is the general loss of the vowel (written *e*) of unaccented final syllables; this vowel is preserved in the 16th century the sound *è*, which it had in Early Old French. In later Anglo-Norman final *è* (like every other sound) was treated exactly as the same sound in Middle English; that is, it came to be omitted or retained at pleasure, and in the 15th century disappeared. In Old French the loss of final *è* is confined to a few words and forms; the 10th century *saviet* (*sapēbat* for *sapēbat*) became in the 11th *savēt*, and *ore* (*ad hōram*), *ele* (*illam*) develop the abbreviated *or*, *el*. In the 15th century *è* before a vowel generally disappears—*mūr*, Old French *mūr* (*mūrūm*); and in the 16th, though still written, *è* after an unaccented vowel, and in the syllable *ent* after a vowel, does the same—*vraiment*, Old French *vraiment* (*vērācū mente*); *avoient* two syllables, as now (*avaient*), in Old French three syllables (as *habēbant*). These phenomena occur much earlier in the anglicized French of England—13th century *aveint* (Old French *aveient*). But the universal loss of final *e*, which has clipped a syllable from half the French vocabulary, did not take place till the 18th century, after the general loss of final consonants; *fort* and *forte*, distinguished at the end of a sentence or line in the 5th century as *fōr* and *fōrt*, remain distinguished, but as *fōr* and *fōrt*. The metre of poetry is still constructed on the obsolete pronunciation, which is even revived in singing; "dit, la jeune belle," actually four syllables (*dī*, *la* *zhan* *bē*), is considered as seven, fitted with music accordingly, and sung to fit the music (*dī*, *la* *zhan* *bē*). (23) In Old French, as in the other Romanic languages, the stress (force; accent) is on the syllable which was accented in Latin; compare the treating of the accented and unaccented vowels in *latrō*, *amās*, giving *lère*, *dīme*, and in *latrōnem*, *amāns*, giving *larōn*, *amēs*, the accented vowels being those which rhyme or assonate. At present, stress in French is much less marked than in English, German or Italian, and is to a certain extent variable; which is partly the reason why most native French scholars find no difficulty in maintaining that the stress in living Modern French is on the same syllable as in Old French. The fact that stress in the French of to-day is independent of length (quantity) and pitch (tone) largely aids the confusion; for though the final and originally accented syllable (not counting the silent *e* as a syllable) is now generally pronounced with less force, it very often has a long vowel with raised pitch. In actual pronunciation the chief stress is usually on the first syllable (counting according to the sounds, not the spelling), but in many polysyllables it is on the last but one; thus in *caution* the accented (strong) syllable *cau*, in *occasion* it is *ca*. Poetry is still written according to the original place of the stress; the rhyme-syllables of *larōn*, *amēs* are still *roh* and *mez*, which when set to music receive an accented (strong) note, and are sung accordingly, though in speech the *la* and *amē* as generally have the principal stress. In reading poetry, as distinguished from singing, the modern pronunciation is used, both as to the loss of the final *è* and the displacement of the stress, the result being that the theoretical metre in which the poetry is written disappears. (24) In certain cases accented vowels were lengthened in Old French, as before a lost *z*; this was indicated in the 16th century by a circumflex—*bête*, Old French *bestē* (*bestiam*), *âme*, Old French *āme* (*anima*). The same occurred in the plural of many nouns, where a consonant was lost before the *z* of the flexion; thus singular *coe* with short vowel, plural *coz* with long. The plural *coz*, though spelt *coz* instead of *coō* (= *hōō*), is still sometimes to be heard, but, like other similar ones, is generally refashioned after the singular, becoming *hōō*. In present French, except where a difference of quality has resulted, as in *côte* (Old French *costam*) with *ō* and *colte* (Old French *colt*), with *ō*, short and long vowels generally run together, quantity being now variable and uncertain; but at the beginning of this century the Early Modern distinctions appear to have been generally preserved.

(d) Orthography.—The history of French spelling is based on that of French sounds; as already stated, the former (apart from a few Latinisms in the earliest documents) for several centuries faithfully followed the latter. When the popular Latin of Gaul was first written, its sounds were represented by the letters of the Roman alphabet; but these were employed, not in the values they had in the time of Caesar, but in those they had acquired in consequence of the phonetic changes that had meantime taken place. Thus, as the Latin sound *u* had become *ö* (close *o*) and *è* had become *y* (French *u*, German *ü*), the letter *u* was used sometimes to denote the sound *ö*, sometimes the sound *y*; as Latin *k* (written *c*) had become *tsh* or *ts*, according to dialect, before *e* and *i*, *c* was used to represent those sounds as well as that of *k*. The chief features of early French orthography (apart from the specialities of individual MSS., especially the earliest) are therefore these:—*c* stood for *k* and *tsh* or *ts*; *ö* for *ö*

and *dh* (soft *th*); *e* for *é*, *è*, and *9*; *g* for *g* and *gsh*; *h* was often written in words of Latin origin where not sounded; *i* (*j*) stood for *i*, *y* consonant, and *dsh*; *o* for *ô* (Anglo-Norman *u*) and *ô*; *s* for *s* and *z*; *t* for *t* and *th*; *u* (*v*) for *û* (Anglo-Norman *u*), *y* and *v*; *y* (rare) for *j*; *s* for *ds* and *ts*. Some new sounds had also to be provided for: where *tsk* had to be distinguished from non-final *ts*, *ch*—at first, as in Italian, denoting *k* before *i* and *e* (*chi* = *ki* from *got*)—was used for it; palatal *l* was represented by *ill*, which when final usually lost one *l*, and after *i* dropped its *s*; palatal *n* by *gn*, *ng* or *ngw*, to which *i* was often prefixed; and the new letter *w*, originally *ww* (*vv*), and sometimes representing merely *w* or *va*, was employed for the consonant-sound still denoted by it in English. All combinations of vowel-letters represented diphthongs; thus *ai* denoted *a* followed by *i*, *ou* either *ôu* or *ôw*, *ui* either *ôi* (Anglo-Norman *ui*) or *yi*, and similarly with the others—*ei*, *eu*, *oi*, *iu*, *ie*, *ue* (and *oe*), and the triphthong *ieu*. Silent letters, except initial *h* in Latin words, are very rare; though MSS. copied from older ones often retain letters whose sounds, though existing in the language of the author, had disappeared from that of the more modern scribe. The subsequent changes in orthography are due mainly to changes of sound, and find their explanation in the phonology. Thus, as Old French progresses, *s*, having become silent before voiced consonants, indicates only the length of the preceding vowel; *e* before nasals, from the change of *ê* (nasal *e*) to *è* (nasal *a*), represents *â*; *c*, from the change of *ts* to *s*, represents *s*; *qu* and *gw*, from the loss of the *w* of *kw* and *gw*, represent *k* and *g* (hard); *ai*, from the change of *ai* to *è*, represents *è*; *ou*, from the change of *ôu* and *ôw* to *u*, represents *u*; *ch* and *g*, from the change of *tsk* and *dsh* to *sh* and *zh*, represent *sh* and *zh*; *eu* and *ue*, originally representing diphthongs, represent *æ* (German *ê*); *s*, from the change of *ts* and *ds* to *s* and *z*, represents *s* and *z*. The new values of some of these letters were applied to words not originally spelt with them: Old French *k* before *i* and *e* was replaced by *qu* (*vesque*, *veske*, Latin *episcopum*); Old French *w* and *o* for *ô*, after this sound had split into *eu* and *u*, were replaced in the latter case by *ou* (*rous*, for *ras* or *rus*, Latin *russum*); *s* was accidentally inserted to mark a long vowel (*paste*, *pale*, Latin *pellidum*); *eu* replaced *ue* and *oe* (*neuf*, *nuel*, Latin *novum* and *novem*); *s* replaced *s* after *ê* (*nes*, *nes*, *nâsum*). The use of *s* for final *s* is due to an orthographical mistake; the MS. contraction of *us* being something like *x* was at last confused with it (*ies* for *tens*, *oculds*), and, its meaning being forgotten, *u* was inserted before the *x* (*yeux*) which thus meant no more than *s*, and was used for it after other vowels (*voix* for *vois*, *vôcem*). As literature came to be extensively cultivated, traditional as distinct from phonetic spelling began to be influential; and in the 14th century, the close of the Old French period, this influence, though not overpowering, was strong—stronger than in England at that time. About the same period there arose etymological as distinct from traditional spelling. This practice, the alteration of traditional spelling by the insertion or substitution of letters which occurred (or were supposed to occur) in the Latin (or supposed Latin) originals of the French words, became very prevalent in the three following centuries, when such forms as *débovir* (*débère*) for *dévoir*, *faulx* (*falsum*) for *faus*, *aukeur* (*audârem*, supposed to be *authôrem*) for *aukeur*, *poids* (supposed to be from *pondus*, really from *pensum*) for *pois*, were the rule. But besides the etymological, there was a phonetic school of spelling (Ramus, in 1562, for instance, writes *ème*, *émales*—with *e = ê*, *è = è*, and *ç = ç*—for *aimai*, *aimastes*), which, though unsuccessful on the whole, had some effect in correcting the excesses of the other, so that in the 17th century most of these inserted letters began to drop; of those which remain, some (*ège* for *femme* or *fecume*, Latin *phlegma*) have corrupted the pronunciation. Some important reforms—as the dropping of silent *s*, and its replacement by a circumflex over the vowel when this was long; the frequent distinction of close and open *e* by acute and grave accents; the restriction of *i* and *u* to the vowel sound, of *j* and *v* to the consonant; and the introduction from Spain of the cedilla to distinguish *c = s* before *e*, *u* and *o*—are due to the 16th century. The replacement of *oi*, where it had assumed the

value *è*, by *ai*, did not begin till the last century, and was not the rule till the present one. Indeed, since the 16th century the changes in French spelling have been small, compared with the changes of the sounds; final consonants and final *e* (unaccented) are still written, though the sounds they represent have disappeared.

Still, a marked effort towards the simplification of French orthography was made in the third edition of the *Dictionary* of the French Academy (1740), practically the work of the Abbé d'Olivet. While in the first (1694) and second (1718) editions of this dictionary words were overburdened with silent letters, supposed to represent better the etymology, in the third edition the spelling of about 5000 words (out of about 18,000) was altered and made more in conformity with the pronunciation. So, for instance, *c* was dropped in *beisfaicteur* and *objet*, *ç* in *çavoir*, *d* in *advocat*, *s* in *accroître*, *albastr*, *aspre* and *bastard*, *e* in the past part. *creu*, *deu*, *veu*, and in such words as *alléure*, *souilleure*; *y* was replaced by *i* in *cecy*, *celuy*, *gay*, *joye*, &c. But those changes were not made systematically, and many pedantic spellings were left untouched, while many inconsistencies still remain in the present orthography (*siffier* and *parisifier*, *souffler* and *doursouffler*, &c.). The consequence of those efforts in contrary directions is that French orthography is now quite as traditional and unphonetic as English, and gives an even false notion than this of the actual state of the language it is supposed to represent. Many of the features of Old French orthography, early and late, are preserved in English orthography; to it we owe the use of *c* for *s* (Old English *c = k* only), of *j* (*s*) for *sh*, of *v* (*w*) for *ð* (in Old English written *f*), and probably of *ch* for *tsk*. The English *w* is purely French, the Old English letter being the runic *ƿ*. When French was introduced into England, *kw* had not lost its *w*, and the French *qu*, with that value, replaced the Old English *cp* (*queen* for *cpen*). In Norman, Old French *sh* had become very like *s*, and in England went entirely into it; *e*, which was one of its French signs, thus came to be often used for *w* in English (*come* for *cume*). *U*, having often in Old French its Modern French value, was so used in England, and replaced the Old English *y* (*busy* for *bysi*, Middle English *brud* for *brýð*), and *y* was often used for *i* (*day* for *dai*). In the 13th century, when *ou* had come to represent *w* in France, it was borrowed by English, and used for the long sound of that vowel (*son* for *shw*); and *gw*, which had come to mean simply *g* (hard), was occasionally used to represent the sound *g* before *i* and *e* (*guess* for *geue*). Some of the Early Modern etymological spellings were imitated in England; *steam* and *amour* were replaced by *phlegm* and *auhour*, the latter spelling having corrupted the pronunciation.

(c) *Infections*.—In the earliest Old French extant, the influence of analogy, especially in verbal forms, is very marked when these are compared with Latin (thus the present participles of all conjugations take *ant*, the ending of the first, Latin *antem*), and becomes stronger as the language progresses. Such isolated inflectional changes as *sareit* into *savoit*, which are cases of regular phonetic changes, are not noticed here.

(i) *Verbs*.—(1) In the oldest French texts the Latin pluperfect (with the sense of the perfect) occasionally occurs—*avret* (*habuerat*), *voeret* (*rogaverat*); it disappears before the 12th century. (2) The *w* of the ending of the 1st pers. plur. *mus* drops in Old French, except in the perfect, where its presence (as *è*) is not yet satisfactorily explained—*amoms* (*amamus*, influenced by *simus*), but *amomes* (*amavimus*). In Picard the atonic ending *mes* is extended to all tenses, giving *amomes*, &c. (3) In the present indicative, 2nd person plur., the ending *es* of the first conjugation (Latin *atis*) extends, even in the earliest documents, to all verbs—*avees*, *vecees*, *vees* (*habetis*, *recipitis*, *auditis*) like *amees* (*amatis*); such forms as *aites*, *fautes* (*dicitis*, *facitis*) being exceptional archaisms. This levelling of the conjugation does not appear at such an early time in the future (formed from the infinitive and from *habētis* reduced to *hētis*); in the Roland both forms occur, *portereis* (*portare habētis*) answering on *rei* (*rai*, *régem*), and the younger *porterez* on *riés* (*cih*, *ciuitatem*), but about the end of the 13th century the older form *-eis*, *-ois*, is dropped, and *-ez* becomes gradually the uniform ending for this 2nd person of the plural in the future tense. (4) In Eastern French the 1st plur., when preceded by *i*, has *e*, not *o*, before the nasal, while Western French has *w* (*o*), as in the present; *possivoms* (*possedimus*) in the Jonah homily makes it probable that the latter is the older form—Picard *avomes*, Burgundian *avoms*, Norman

amimus (*habēdumus*). (5) The subjunctive of the first conjugation has at first in the singular no final *e*, in accordance with the final vowel laws—*plur. plus. pluri* (*plōrem, plōrēs, plōrē*). The forms are gradually assimilated to those of the other conjugations, which, deriving from Latin *am, as, at*, have *e, es, et* (*l*). Modern French *plēne, plēurs, plēure*, like *perde, perdēs, perde* (*perdum, perdās, perdāt*). (6) In Old French the present subjunctive and the 1st sing. pres. ind. generally show the influence of the *i* or *e* of the Latin *iam, eam, it, ē*.—Old French *muire* or *moire* (*morial* for *moridūm*), *tiēne* or *tiēne* (*tenet*), *muir* or *moer* (*moris* for *morior*), *tieng* or *tieng* (*tenet*). By degrees these forms are levelled under the other present forms.—Modern French *meure* and *meurs* following *meurt* (*morit* for *moritur*), *tiēne* and *tiens* following *tient* (*tenet*). A few of the older forms remain—the vowel of *aie* (*habeam*) and *ai* (*habed*) contrasting with that of *a* (*habet*). (7) A levelling of which instances occur in the 11th century, but which is not yet complete, is that of the accented and unaccented stem-syllables of verbs. In Old French many verb-stems with shifting accent vary in accordance with phonetic laws—*parler* (*parabolāre*), *amer* (*amāre*) have in the present indicative *parol* (*parabolā*), *paroles* (*parabolās*), *parolet* (*parabolāt*), *parlums* (*parabolāmus*), *parles* (*parabolās*), *parolet* (*parabolāt*); *aime* (*amā*), *aimes* (*amās*), *aime* (*amā*), *amuns* (*amāmus*), *amēz* (*amās*), *amēt* (*amāt*). In the first case the unaccented, in the second the accented form has prevailed.—Modern French *parle, parler; aime, aimer*. In several verbs, as *tenir* (*tenēre*), the distinction is retained—*tiens, tiens, tiens, tenons, tenez, tenuent*. (8) In Old French, as stated above, if instead of *t* from *d* occurs after a palatal (which, if a consonant, often split into *s* with a dental); the diphthong thus appears in several forms of many verbs of the 1st conjugation—*preser* (= *preiser, preāre*), *venier* (*vindicare*), *laissier* (*lassāre*), *aider* (*adiūtāre*). At the close of the Old French period, those verbs in which the stem ends in a dental replace *ie* by the *e* of other verbs—Old French *laisser, aider, laisser* (*luxātis*), *aidez* (*adiūtātis*); Modern French *laisser, aider, laissez, aidez*, by analogy of *aimer, aime*. The older forms generally remain in Picard—*laissier, aidier*. (9) The addition of *e* to the 1st sing. pres. ind. of all verbs of the first conjugation is rare before the 13th century, but is usual in the 15th; it is probably due to the analogy of the third person—Old French *chant* (*cantō*), *aim* (*amū*); Modern French *chantē, aime*. (10) In the 13th century *s* is occasionally added to the 1st pers. sing., except those ending in *e* (= *?*) and *ai*, and to the 2nd sing. of imperatives; at the close of the 16th century this becomes the rule, and extends to imperfects and conditionals in *oie* after the loss of their *e*. It appears to be due to the influence of the 2nd pers. sing.—Old French *vend* (*vendō* and *vendē*), *vendōie* (*vendebam*), *parli* (*parlōi*), *tieng* (*tenōi*); Modern French *vend, vendais, parlai, tins; and donne* (*dōnā*) in certain cases becomes *donnes*. (11) The 1st and 2nd plur. of the pres. subj., which in Old French were generally similar to those of the indicative, gradually take an *i* before the *on*, which is the rule after the 16th century—Old French *perdōns* (*perdāmus*), *perdez* (*perdātis*); Modern French *perdōns, perdez*, apparently by analogy of the imp. ind. (12) The loss in Late Old French of final *s, t, &c.*, when preceding another consonant, caused many words to have in reality (though often concealed by orthography) double forms of inflection—one without termination, the other with. Thus in the 16th century the 2nd sing. pres. ind. *dors* (*dormis*) and the 3rd *dort* (*dormit*) were distinguished as *dōrz* and *dōrt* when before a vowel, as *dōrs* and *dōrt* at the end of a sentence or line of poetry, but ran together as *dōr* when followed by a consonant. Still later, the loss of the final consonant when not followed by a vowel further reduced the cases in which the forms were distinguished, so that the actual French conjugation is considerably simpler than is shown by the customary spellings, except when, in consequence of an immediately following vowel, the old terminations occasionally appear. Even here the antiquity is to a considerable extent artificial or delusive, some of the insertions being due to analogy, and the popular language often omitting the traditional consonant or inserting a different one. (13) The subsequent general loss of *e* in unaccented final syllables has still further reduced the inflections, but not the distinctive forms—*perd* (*perdit*) and *perde* (*perdat*) being generally distinguished as *pēr* and *pērd*, and before a vowel as *pōrt* and *pōrd*.

(ii) *Substantives*.—(1) In Early Old French (as in Provençal) there are two main declensions, the masculine and the feminine; with a few exceptions the former distinguishes nominative and accusative in both numbers, the latter in neither. The nom. and acc. sing. and acc. plur. masc. correspond to those of the Latin 2nd or 3rd declension, the nom. plur. to that of the 2nd declension. The sing. fem. corresponds to the nom. and acc. of the Latin 1st declension, or to the acc. of the 3rd; the plur. fem. to the acc. of the 1st declension, or to the nom. and acc. of the 3rd. Thus masc. *lors* (*laurūs*), *lors* (*laurō*); *lor* (*laurum*), *loron* (*laurōnem*); *lor* (*laurū*), *loron* (*laurōnt* for *laurōs*); *lors* (*laurōs*), *lorons* (*laurōnēs*); but fem. only *ele* (*dōla* and *dōm*), *flor* (*flōrem*); *eles* (*dōlās*), *flors* (*flōrēs* nom. and acc.). About the end of the 11th century feminines not ending in *e* (= *?*) take, by analogy of the masculines, *s* in the nom. sing., thus distinguishing *nom. flors* from acc. *flor*. A century later, masculines without *s* in the nom. sing. take this consonant by analogy of the other masculines, giving *leres* as nom. similar to *lors*. In Anglo-Norman the accusative forms very early begin to replace the nominative, and

soon supersede them, the language following the tendency of contemporaneous English. In continental French the declension-system was preserved much longer, and did not break up till the 13th century, though acc. forms are occasionally substituted for nom. (rarely nom. for acc.) before that date. It must be noticed, however, that in the current language the reduction of the declension to one case (generally the accusative) per number appears much earlier than in the language of literature proper and poetry; Froissart, for instance, c. 1400, in his poetical works is much more careful of the declension than in his Chronicles. In the 15th century the modern system of one case is fully established; the form kept is almost always the accusative (sing. without *s*, plural with *s*), but in a few words, such as *flis* (*filius*), *saur* (*sonor*), *paste* (*pastor*), and in proper names such as *Georges, Gilles, &c.*, often used as vocative (therefore with the form of nom.); the nom. survives in the sing. Occasionally both forms exist, in different senses—*sire* (*senior*) and *seigneur* (*seniorem*), *on* (*homo*) and *homme* (*hominem*). (2) Latin neuters are generally masculine in Old French, and inflected according to their analogy, as *ciel* (*caelus* for *caelum* nom.), *ciel* (*caelum* acc.), *ciel* (*caeli* for *caela* nom.), *ciels* (*caelūs* for *caela* acc.); but in some cases the form of the Latin neuter is preserved, as in *cors*, *now corps*, Lat. *corpus*; *lens*, *now lemps*, Lat. *tempus*. Many neuter lose their singular form and treat the plural as a feminine singular, as in the related languages—*merveille* (*mirābilis*), *feuille* (*folium*). But in a few words the neuter plural termination is used, as in Italian, in its primitive sense—*erre* (*error*, which exists as well as *carri*), *paire* (*lat. paria*); Modern French *chans, paires*. (3) In Old French the inflectional *s* often causes phonetic changes in the stem; thus palatal *l* before *s* takes *t* after it, and becomes dental *l*, which afterwards changes to *w* or drops—*fil* (*filium* and *filii*) with palatal *l*, *hīc* (*filius* and *filios*), afterwards *fi*, with *z* (= *s*) preserved in English *fitz*, and then *fs*, as now (*spl* *fil*). Many consonants before *s*, as the *t* of *fi*, disappear, and *l* is vocalized—*soif* (*situm*), *mulum*), nominative sing. and acc. plur. *vis*, *maux* (earlier *mal*). These forms of the plural are retained in the 16th century, though often etymologically split with the consonant of the singular, as in *vifs*, pronounced *vis*; but in Late Modern French many of them disappear, *vifs*, with *f* sounded as in the singular, being the plural of *vis*, *bals* (formerly *baux*) that of *bal*. In many words, as *chant* (*cantūs*) and *champs* (*campūs*) with silent *t* and *p* (Old French *chans* in both cases), *maux* (Old French *mal*, sing. *mal*), *yeux* (*oculūs*, Old French *œz*, sing. *œil*) the old change in the stem is kept. Sometimes, as in *cieux* (*caelūs*) and *ciels*, the old traditional and the modern analogical forms coexist, with different meanings. (4) The modern loss of final *s* (except when kept as *s* before a vowel) has seriously modified the French declension, the singulars *fort* (*fort*) and *forte* (*fortē*) being generally undistinguishable from their plurals *forts* and *fortes*. The subsequent loss of *z* in finals has not affected the relation between sing. and plur. forms; but with the frequent receding of the plural forms on the singular present in Modern French has very often no distinction between sing. and plur., except before a vowel. Such plurals as *maux* have always been distinct from their singular *mal*; in those whose singular ends in *s* there never was any distinction, Old French *fas* (now *spl* *lacs*) corresponding to *lagrues*, *lagrueum*, *lagrōt* and *lagrōes*.

(iii) *Adjectives*.—(1) The terminations of the cases and numbers of adjectives are the same as those of substantives, and are treated in the preceding paragraph. The feminine generally takes no *e* if the masc. has none, and if there is no distinction in Latin—fem. sing. *fort* (*fortem*), *grant* (*grātem*), fem. plur. *forts* (*fortēs*), *grans* (*grātes*), like the acc. masc. Certain adjectives of this class, and among them all the adjectives formed with the Latin suffix *-ennis*, take regularly, even in the oldest French, the feminine ending *e*, in Provençal a *courtis*, fem. *courtisē*; *commun*, fem. *commune*). To these must not be added *dous* (Mod. Fr. *dolc*, *dous*), fem. *douce*, which probably comes from a Low Latin *dulcis*, *dulcia*. In the 11th century some other feminines, originally without *e*, begin in Norman to take this termination—*grande* (in a feminine association in the Alexiad), plur. *grandes*; but other dialects generally preserve the original forms till the 14th century. In the 16th century the *e* is general in the feminine, and is now universal, except in a few expressions—*grand-mère* (with erroneous apostrophe, *grandem-māitrem*), *lettres royales* (*litterās regālīs*), and most adverbs from adjectives in *-ant, -ant-couramment* (*curante* for *ente mente*), *sciement* (*sciēte mente*). (2) Several adjectives have in Modern French replaced the masc. by the feminine—Old French masc. *roit* (*rigidum*), fem. *roide* (*rigidam*); Modern French *roide* for both genders. (3) In Old French several Latin simple comparatives are preserved—*maior* (*maiorē*), nom. *maura* (*maior*); *graignur* (*grandiorem*), nom. *graindre* (*grandior*); only a few of these now survive—*pire* (*pejor*), *meilleur* (*meliorē*), with their adverbial neuter *pis* (*pejūs*), *mieux* (*melius*). The few simple superlatives found in Old French, as *merme* (*minimum*), *pesme* (*pessimus*), *proisme* (*proximum*), *haultisme* (*altissimum*), this last one being clearly a literary word, are now extinct, and, when they existed, had hardly the meaning of a superlative. (4) The modern loss of many final consonants when not before vowels, and the subsequent loss of final *z*, have greatly affected the distinction between the masc. and fem. of adjectives—*fort* and *forte* are still distinguished as *fir* and *fort*, but *amer* (*amārum*) and *amere* (*amāram*), with their plurals *amers* and *amères*, have run together.

(f) *Derivation*.—Most of the Old French prefixes and suffixes are descendants of Latin ones, but a few are Teutonic (*ard = hard*), and some are later borrowings from Latin (*arie*, afterwards *aire*, from *arium*). In Modern French many old affixes are hardly used for forming new words; the inherited *ier (arium)* is yielding to the borrowed *aire*, the popular *contre (contra)* to the learned *anti* (Greek), and the native *ée (dium)* to the Italian *ade*. The suffixes of many words have been assimilated to more common ones; thus *scugler (singularem)* is now *sanglier*.

(g) *Syntax*.—Old French syntax, gradually changing from the 10th to the 14th century, has a character of its own, distinct from that of Modern French; though when compared with Latin syntax it appears decidedly modern.

(1) The general formal distinction between nominative and accusative is the chief feature which causes French syntax to resemble that of Latin and differ from that of the modern language; and as the distinction had to be replaced by a comparatively fixed word-order, a serious loss of freedom ensued. If the forms are modernized while the word-order is kept, the Old French *archevesque ne peut flechir li reis Henris* (Latin *archiepiscopus non potest flectere rex Henricus*) assumes a totally different meaning—*l'archeveque ne peut flechir le roi Henri*. (2) The replacement of the nominative form of nouns by the accusative is itself a syntactical feature, though treated above under inflection. A more modern instance is exhibited by the personal pronouns, which, when not immediately the subject of a verb, occasionally take even in Old French, and regularly in the 16th century, the accusative form; the Old French *je qui sui (ego qui sum)* becomes *moi qui suis*, though the older usage survives in the legal phrase *je, soussigné*. . . . (3) The definite article is now required in many cases where Old French dispenses with it—*je cunquis Engleterre, souffrir mort* (as Modern French *avoir faim*); Modern French *l'Angleterre, la mort*. (4) Old French had distinct pronouns for "this" and "that"—*cest (ecce istum)* and *cel (ecce illum)*, with their cases. Both exist in the 16th century, but the present language employs *cel* as adjective, *cel* as substantive, in both meanings, marking the old distinction by affixing the adverbs *ci* and *là*—*cel homme-ci, cel homme-là; celui-ci, celui-là*. (5) In Old French, the verbal terminations being clear, the subject pronoun is usually not expressed—*si ferai (sic facere habebis), est durs (durus est), que feras (quid facere habes)?* In the 16th century the use of the pronoun in general, and is now universal, except in one or two impersonal cases, as *n'importe, peu s'en faut*. (6) The present participle in Old French in its uninflected form coincided with the gerund (*amant = amantem and amando*), and in the modern language has been replaced by the latter, except where it has become adjectival; the Old French *complainçans leur dolours* (Latin *plangentis*) is now *plaignant leurs dolours* (Latin *plangentis*). The now extinct use of *estre* with the participle present for the simple verb is not uncommon in Old French down to the 16th century—*sont disans (sunt dicentes)* = Modern French *ils disent* (as English *they are saying*). (7) In present Modern French the preterite participle when used with *avoir* to form verb-tenses is invariable, except when the object precedes (an exception now vanishing in the conversational language)—*j'ai écrit les lettres, les lettres que j'ai écrites*. In Old French down to the 16th century, formal concord was more common (though by no means necessary), partly because the object preceded the participle much oftener than now—*ad la culur miée (habet colorem miltam), ad faïte sa vençance, les turs ad vendues*. (8) The sentences just quoted will serve as specimens of the freedom of Old French word-order—the object standing either before verb and participle, between them, or after both. The predicative adjective can stand before or after the verb—*hals sunt li pas (Latin postus), e lambras e grant*. (9) In Old French *ne* (Early Old French *nen*, Latin *non*) suffices for the negation without *pas (passum), point (punctum)* or *mie (micam, now obsolete)*, though these are frequently used—*je ne sui sis sire (je ne suis pas ton seigneur), autre feme nen ara (il n'aura pas autre femme)*. In principal sentences Modern French uses *ne* by itself only in certain cases—*je ne puis marcher, je n'as rien*. The slight weight as a negation usually attached to *ne* has caused several originally positive words to take a negative meaning—*rien (Latin rem)* now meaning "nothing" as well as "something". (10) In Old French interrogation was expressed with substantives as with pronouns by putting them after the verb—*est Saul entre les prophètes?* In Modern French the pronominal inversion (the substantive being prefixed) or a verbal periphrasis must be used—*Saul est-il? or est-ce que Saul est?*

(k) *Summary*.—Looking at the internal history of the French language as a whole, there is no such strongly marked division as exists between Old and Middle English, or even between Middle and Modern English. Some of the most important changes are quite modern, and are concealed by the traditional orthography; but, even making allowance for this, the difference between French of the 11th century and that of the 16th is less than that between English of the same dates. The most important change in itself and for its effects is probably that which is usually made the division between Old and Modern French, the loss of the formal distinction

between nominative and accusative; next to this are perhaps the gradual loss of many final consonants, the still recent loss of the vowel of unaccented final syllables, and the extension of analogy in conjugation and declension. In its construction Old French is distinguished by a freedom strongly contrasting with the strictness of the modern language, and bears, as might be expected, a much stronger resemblance than the latter to the other Romanic dialects. In many features, indeed, both positive and negative, Modern French forms a class by itself, distinct in character from the other modern representatives of Latin.

IV. *BIBLIOGRAPHY*.—The few works which treat of French philology as a whole are now in many respects antiquated, and the important discoveries of recent years, which have revolutionized our ideas of Old French phonology and dialectology, are scattered in various editions, periodicals, and separate treatises. For many things Diez's *Grammatik der romanischen Sprachen* (4th edition—a reprint of the 3rd—Bonn, 1876-1877; French translation, Paris, 1872-1875) is still very valuable; Burguy's *Grammaire de la Langue d'Oïl* (2nd edition—a reprint of the 1st—Berlin, 1869-1870) is useful only as a collection of examples. Schwab's *Grammatik des Altfranzösischen*, as revised by Behrens in the 3rd edition (Leipzig, 1898; French translation, Leipzig and Paris, 1900), is by far the best Old French grammar we possess. For the history of French language in general see F. Brunot, *Histoire de la langue française des origines à 1900* (Paris, 1905, 1906, &c.). For the history of spelling, A. F. Didot, *Observations sur l'orthographe ou ortographe française suivies d'une histoire de la réforme orthographique depuis le XV^e siècle jusqu'à nos jours* (2nd ed., Paris, 1868). For the history of French sounds: Ch. Thurot, *De la prononciation française depuis le commencement du XVI^e siècle, d'après les témoignages des grammairiens* (2 vols., Paris, 1891-1893). For the history of syntax, apart from various grammatical works of a general character, much is to be gathered from Ad. Tobler's *Vermischte Beiträge zur französischen Grammatik* (3 parts, 1886, 1894, 1899, parts I. and II. in second editions, 1902, 1906). G. Paris's edition of *La Vie de S. Alexis* (Paris, 1872) was the pioneer of, and retains an important place among, the recent original works on Old French. Darmesteter and Hatfield's *Le seizième Siècle* (Paris, 1878) contains the first good account of Early Modern French. Littre's *Dictionnaire de la langue française* (4 vols., Paris, 1863-1869, and a Supplement, 1877); and Hatfield, Darmesteter and Thomas, *Dict. général de la langue française*, more condensed (2 vols., Paris, 1888-1900), contain much useful and often original information about the etymology and history of French words. For the etymology of many French (and also Provençal) words, reference must be made to Ant. Thomas's *Essais de philologie française* (Paris, 1897) and *Nouveaux essais de philologie française* (Paris, 1904). But there is no French dictionary properly historical. A *Dictionnaire historique de la langue française* was begun by the Académie française (4 vols., 1859-1894), but it was, from the first, antiquated. It contains only one letter (A) and has not been continued. The leading periodicals now in existence are the *Romania* (Paris), founded (in 1872) and edited by P. Meyer and G. Paris (with Ant. Thomas since the death of G. Paris in 1903), and the *Zeitschrift für romanische Philologie* (Halle), founded (in 1877) and edited by G. Gröber. To these reference should be made for information as to the very numerous articles, treatises and editions by the many and often distinguished scholars who, especially in France and Germany, now prosecute the scientific study of the language. It may be well to mention that, Old French philology especially being complicated, and as yet incompletely investigated, these publications, the views in which are of various degrees of value, require not mere acquiescent reading, but critical study. The dialects of France in their present state (*patois*) are now being scientifically investigated. The special works on the subject (dictionaries, grammars, &c.) cannot be fully indicated here; we must limit ourselves to the mention of Behrens's *Bibliographie des patois gallo-romans* (2nd ed., revised Berlin, 1893), and of Gillieron and Edmont's *Atlas linguistique de la France* (1902 et seq.), a huge publication planned to contain about 1800 maps. (H. N.; P.M.)

FRENCH LITERATURE. Origins.—The history of French literature in the proper sense of the term can hardly be said to extend farther back than the 11th century. The actual manuscripts which we possess are seldom of older date than the century subsequent to this. But there is no doubt that by the end at least of the 11th century the French language, as a completely organized medium of literary expression, was in full, varied and constant use. For many centuries previous to this, literature had been composed in France, or by natives of that country, using the term France in its full modern acceptance; but until the 9th century, if not later, the written language of France, so far as we know, was Latin; and despite the practice of not a few literary historians, it does not seem reasonable to notice Latin writings in a history of French literature. Such a history properly busies itself only with the monuments of French itself from the time when the so-called *Lingua Romana Rustica*

ed a sufficiently independent form to deserve to be called ' language. This time it is indeed impossible exactly to nine, and the period at which literary compositions, as quished from mere conversation, began to employ the new e is entirely unknown. As early as the 7th century the a Romana, as distinguished from Latin and from Teutonic ts, is mentioned, and this Lingua Romana would be of ity used for purposes of clerical admonition, especially in untry districts, though we need not suppose that such es had a very literary character. On the other hand, ention, at early dates, of certain *cantilenæ* or songs com- in the vulgar language has served for basis to a super- ure of much ingenious argument with regard to the highly sting problem of the origin of the *Chansons de Geste*, the t and one of the greatest literary developments of northern h. It is sufficient in this article, where speculation would : of place, to mention that only two such *cantilenæ* actually and that neither is French. One of the 9th century, the of Saucourt," is in a Teutonic dialect; the other, the "Song Faron," is of the 7th century, but exists only in Latin the construction and style of which present traces of trans- lation from a poetical and vernacular original. As far as facts go, the most ancient monuments of the written

French language consist of a few documents of very various character, ranging in date from the 9th to the century. The oldest gives us the oaths interchanged at burg in 842 between Charles the Bald and Louis the German. ext probably in date and the first in literary merit is a short celebrating the martyrdom of St Eulalia, which may be as the end of the 9th century, and is certainly not younger be beginning of the 10th. Another, the *Life of St Leger*, in trosyllabic lines, is dated by conjecture about 975. The sion indeed of these short and fragmentary pieces is of philological than literary interest, and belongs rather to ad of French language. They are, however, evidence of ogress which, continuing for at least four centuries, built up ary instrument out of the decomposed and reconstructed of the Roman conquerors, blended with a certain limited at of contributions from the Celtic and Iberian dialects of iginal inhabitants, the Teutonic speech of the Franks, and ional tongue of the Moors who pressed upwards from Spain. l these foreign elements bear a very small proportion to the at of Latin; and as Latin furnished the greater part of the ularly and the grammar, so did it also furnish the principal s and helps to literary composition. The earliest French cation is evidently inherited from that of the Latin hymns church, and for a certain time Latin originals were followed choice of literary forms. But by the 11th century it is bly certain that dramatic attempts were already being in the vernacular, that lyric poetry was largely cultivated, ws, charters, and such-like documents were written, and ommentators and translators busied themselves with re- subjects and texts. The most important of the extant ents, outside of the epics presently to be noticed, has of late been held to be the *Life of Saint Alexis*, a poem of 625 decasyllabic lines, arranged in five-line stanzas, each of one assonance or vowel-rhyme, which may be ly as 1050. But the most important development of the entury, and the one of which we are most certain, is that ch we have evidence remaining in the famous *Chanson de f*, discovered in a manuscript at Oxford and first published 7. This poem represents the first and greatest development ch literature, the chansons de geste (this form is now red to that with the plural *gestes*). The origin of these has been hotly debated, and it is only recently that the tance which they really possess has been accorded to them, ct the less remarkable in that, until about 1820, the epics ient France were unknown, or known only through late sfigured prose versions. Whether they originated in the or the south is a question on which there have been more ne or two revolutions of opinion, and will probably be still, but which need not be dealt with here. We possess

in round numbers a hundred of these chansons. Three only of them are in Provençal. Two of these, *Ferabras* and *Belionnet d'Hanstonne*, are obviously adaptations of French originals. The third, *Girart de Rossilho* (Gerard de Roussillon), is undoubtedly Provençal, and is a work of great merit and originality, but its dialect is strongly tinged with the characteristics of the Langue d'Oïl, and its author seems to have been a native of the debatable land between the two districts. To suppose under these circumstances that the Provençal originals of the hundred others have perished seems gratuitous. It is sufficient to say that the chanson de geste, as it is now extant, is the almost exclusive property of northern France. Nor is there much authority for a supposition that the early French poets merely versified with amplifications the stories of chroniclers. On the contrary, chroniclers draw largely from the chansons, and the question of priority between *Roland* and the pseudo-Turpin, though a hard one to determine, seems to resolve itself in favour of the former. At most we may suppose, with much probability, that personal and family tradition gave a nucleus for at least the earliest.

Chansons de Geste.—Early French narrative poetry was divided by one of its own writers, Jean Bodel, under three heads —poems relating to French history, poems relating to ancient history, and poems of the Arthurian cycle *Chansons de Geste.* (*Matières de France, de Bretagne, et de Rome*). To the first only is the term chansons de geste in strictness applicable. The definition of it goes partly by form and partly by matter. A chanson de geste must be written in verses either of ten or twelve syllables, the former being the earlier. These verses have a regular caesura, which, like the end of a line, carries with it the licence of a mute *e*. The lines are arranged, not in couplets or in stanzas of equal length, but in *lisses* or *trades*, consisting of any number of lines from half a dozen to some hundreds. These are, in the earlier examples assonanced,—that is to say, the vowel sound of the last syllables is identical, but the consonants need not agree. Thus, for instance, the final words of a tirade of *Amis et Amiles* (ll. 199-206) are *erbe, nouvelle, selles, nouvelles, traversent, arrestent, guerre, cortège*. Sometimes the tirade is completed by a shorter line, and the later chansons are regularly rhymed. As to the subject, a chanson de geste must be concerned with some event which is, or is supposed to be, historical and French. The tendency of the *trouvères* was constantly to affiliate their heroes on a particular *geste* or family. The three chief *gestes* are those of Charlemagne himself, of Doon de Mayence, and of Garin de Monglane; but there are not a few chansons, notably those concerning the Lorrainers, and the remarkable series sometimes called the *Chevalier au Cygne*, and dealing with the crusades, which lie outside these groups. By this joint definition of form and subject the chansons de geste are separated from the romances of antiquity, from the romances of the Round Table, which are written in octosyllabic couplets, and from the *romans d'aventures* or later fictitious tales, some of which, such as *Brun de la Montaigne*, are written in pure chanson form.

Not the least remarkable point about the chansons de geste is their vast extent. Their number, according to the strictest definition, exceeds 100, and the length of each chanson *Vahano* varies from 1000 lines, or thereabouts, to 20,000 or *and* *changes of* *early epics.* even 30,000. The entire mass, including, it may be supposed, the various versions and extensions of each chanson, is said to amount to between two and three million lines; and when, under the second empire, the publication of the whole Carolingian cycle was projected, it was estimated, taking the earliest versions alone, at over 300,000. The successive developments of the chansons de geste may be illustrated by the fortunes of *Huon de Bordeaux*, one of the most lively, varied and romantic of the older epics, and one which is interesting from the use made of it by Shakespeare, Wieland and Weber. In the oldest form now extant, though even this is probably not the original, *Huon* consists of over 10,000 lines. A subsequent version contains 4000 more; and lastly, in the 14th century, a later poet has amplified the legend to the extent of 30,000 lines.

When this point had been reached, *Huon* began to be turned into prose, was with many of his fellows published and republished during the 15th and subsequent centuries, and retains, in the form of a roughly printed chap-book, the favour of the country districts of France to the present day. It is not, however, in the later versions that the special characteristics of the chansons de geste are to be looked for. Of those which we possess, one and one only, the *Chanson de Roland*, belongs in its present form to the 11th century. Their date of production extends, speaking roughly, from the 11th to the 14th century, their palmy days were the 11th and the 12th. After this latter period the Arthurian romances, with more complex attractions, became their rivals, and induced their authors to make great changes in their style and subject. But for a time they reigned supreme, and no better instance of their popularity can be given than the fact that manuscripts of them exist, not merely in every French dialect, but in many cases in a strange macaronic jargon of mingled French and Italian. Two classes of persons were concerned in them. There was the *trouvère* who composed them, and the *jongleur* who carried them about in manuscript or in his memory from castle to castle and sang them, intermixing frequent appeals to his auditory for silence, declarations of the novelty and the strict copyright character of the chanson, revilings of rival minstrels, and frequently requests for money in plain words. Not a few of the manuscripts which we now possess appear to have been actually used by the jongleur. But the names of the authors, the *trouvères* who actually composed them, are in very few cases known, those of copyists, continuators, and mere possessors of manuscripts having been often mistaken for them.

The moral and poetical peculiarities of the older and more authentic of these chansons are strongly marked, though perhaps not quite so strongly as some of their encomiasts have contended, and as may appear to a reader of the most famous of them, the *Chanson de Roland*, alone. In that poem, indeed, war and religion are the sole motives employed, and its motto might be two lines from another of the finest chansons (*Aliscans*, 161-162):—

"Dist à Bertran : ' N'avons mais nul loir.
Tant ke vivons alons paiens ferir."

In *Roland* there is no love-making whatever, and the hero's betrothed "la belle Aude" appears only in a casual gibe of her brother Oliver, and in the incident of her sudden death at the news of *Roland's* fall. M. Léon Gautier and others have drawn the conclusion that this stern and masculine character was a feature of all the older chansons, and that imitation of the Arthurian romance is the cause of its disappearance. This seems rather a hasty inference. In *Amis et Amiles*, admittedly a poem of old date, the parts of Bellicent and Lubias are prominent, and the former is demonstrative enough. In *Aliscans* the part of the Countess Guibourc is both prominent and heroic, and is seconded by that of Queen Blancheflor and her daughter Aelis. We might also mention Oriabel in *Jourdans de Blaivies* and others. But it may be admitted that the sex which fights and counsels plays the principal part, that love adventures are not introduced at any great length, and that the lady usually spares her knight the trouble and possible indignities of a long wooing. The characters of a chanson of the older style are somewhat uniform. There is the hero who is unjustly suspected of guilt or sore beset by Saracens, the heroine who falls in love with him, the traitor who accuses him or delays help, who is almost always of the lineage of Ganelon, and whose ways form a very curious study. There are friendly paladins and subordinate traitors; there is Charlemagne (who bears throughout the marks of the epic king common to Arthur and Agamemnon, but is not in the earlier chanson the incapable and venal dotard which he becomes in the later), and with Charlemagne generally the duke Naimes of Bavaria, the one figure who is invariably wise, brave, loyal and generous. In a few chansons there is to be added to these a very interesting class of personages who, though of low birth or condition, yet rescue the high-born knights from their enemies. Such are *Rainoart* in *Aliscans*, *Gautier* in *Guydon*, *Robastre* in *Taufrey*, *Varocher* in *Maccuire*. These subjects, uniform rather

than monotonous, are handled with great uniformity if not monotony of style. There are constant repetitions, and it sometimes seems, and may sometimes be the case, that the text is a mere cento of different and repeated verses. But the verse is generally harmonious and often stately. The recurrent assonances of the endless tirade soon impress the ear with a grateful music, and occasionally, and far more frequently than might be thought, passages of high poetry, such as the magnificent *Grans doel par la mort de Rollant*, appear to diversify the course of the story. The most remarkable of the chansons are *Roland*, *Aliscans*, *Gerard de Roussillon*, *Amis et Amiles*, *Raoul de Combrai*, *Garin le Lohereain* and its sequel *Les quatre Fils Aymon*, *Les Seintes* (recounting the war of Charlemagne with Wittekind), and lastly, *Le Chevalier au Cygne*, which is not a single poem but a series, dealing with the earlier crusades. The most remarkable group is that centring round William of Orange, the historical or half-historical defender of the south of France against Mahomedan invasion. Almost all the chansons of this group, from the long-known *Aliscans* to the recently printed *Chanson de Willame*, are distinguished by an unwonted *personality* of interest, as well as by an intensified dose of the rugged and martial poetry which pervades the whole class. It is noteworthy that one chanson and one only, *Floovant*, deals with Merovingian times. But the chronology, geography, and historic facts of nearly all are, it is hardly necessary to say, mainly arbitrary.

Arthurian Romances.—The second class of early French epic consists of the Arthurian cycle, the *Maître de Bratagne*, the earliest known compositions of which are at least a century junior to the earliest chanson de geste, but which soon succeeded the chansons in popular favour, and obtained a vogue both wider and far more enduring. It is not easy to conceive a greater contrast in form, style, subject and sentiment than is presented by the two classes. In both the religious sentiment is prominent, but the religion of the chansons is of the simplest, not to say of the most savage character. To pray to God and to kill his enemies constitutes the whole duty of man. In the romances the mystical element becomes on the contrary prominent, and furnishes, in the Holy Grail, one of the most important features. In the Carolingian knight the courtesy and clemency which we have learnt to associate with chivalry are almost entirely absent. The *genix ber* contradicts, jeers at, and execrates his sovereign and his fellows with the utmost freedom. He thinks nothing of striking his *cortoise moultier* so that the blood runs down her *cler vis*. If a servant or even an equal offends him, he will throw the offender into the fire, knock his brains out, or set his whiskers ablaze. The Arthurian knight is far more of the modern model in these respects. But his chief difference from his predecessor is undoubtedly in his amorous devotion to his beloved, who, if not morally superior to Bellicent, Floripas, Esclairmonde, and the other Carolingian heroines, is somewhat less forward. Even in minute details the difference is strongly marked. The romances are in octosyllabic couplets or in prose, and their language is different from that of the chansons, and contains much fewer of the usual epic repetitions and stock phrases. A voluminous controversy has been held respecting the origin of these differences, and of the story or stories which were destined to receive such remarkable attention. Reference must be made to the article ARTHURIAN LEGEND for the history of this controversy and for an account of its present state. This state, however, and all subsequent states, are likely to be rather dependent upon opinion than upon actual knowledge. From the point of view of the general historian of literature it may not be improper here to give a caution against the frequent use of the word "proven" in such matters. Very little in regard to early literature, except the literary value of the texts, is ever susceptible of *proof*; although things may be made more or less *probable*. What we are at present concerned with, however, is a body of verse and prose composed in the latter part of the 12th century and later. The earliest romances, the *Saint Graal*, the *Quête du Saint Graal*, *Joseph d'Arimathe* and *Merlin* bear the names of Walter Map and Robert de Borron. *Artus* and part at least of *Lancelot du Lac* (the whole of which has been by turns attributed and denied to

Walter Map) appear to be due to unknown authors. *Tristan* came later, and has a stronger mixture of Celtic tradition. At the same time as Walter Map, or a little later, Chrétien (or Chrestien) de Troyes threw the legends of the Round Table into octosyllabic verse of a singularly spirited and picturesque character. The chief poems attributed to him are the *Chevalier au Lyon* (Sir Ewain of Wales), the *Chevalier à la Charette* (one of the episodes of *Lancelot*), *Eric et Enide*, *Tristan* and *Percivale*. These poems, independently of their merit, which is great, had an extensive literary influence. They were translated by the German minnesingers, Wolfram von Eschenbach, Gottfried of Strassburg, and others. With the romances already referred to, which are mostly in prose, and which by recent authorities have been put later than the verse tales which used to be post-posed to them, Chrétien's poems complete the early forms of the Arthurian story, and supply the matter of it as it is best known to English readers in Malory's book. Nor does that book, though far later than the original forms, convey a very false impression of the characteristics of the older romances. Indeed, the Arthurian knight, his character and adventures, are so much better known than the heroes of the Carolingian chanson that there is less need to dwell upon them. They had, however, as has been already pointed out, great influence upon their rivals, and their comparative fertility of invention, the much larger number of their *dramatis personae*, and the greater variety of interests to which they appealed, sufficiently explain their increased popularity. The ordinary attractions of poetry are also more largely present in them than in the chansons; there is more description, more life, and less of the mere chronicle. They have been accused of relaxing morality, and there is perhaps some truth in the charge. But the change is after all one rather of manners than of morals, and what is lost in simplicity is gained in refinement. *Doon de Mayence* is a late chanson, and *Lancelot du Lac* is an early romance. But the two beautiful scenes, in the former between Doon and Nicolette, in the latter between Lancelot, Galahault, Guinevere, and the Lady of Malchaut, may be compared as instances of the attitude of the two classes of poets towards the same subject.

Romances of Antiquity.—There is yet a third class of early narrative poems, differing from the two former in subject, but agreeing, sometimes with one sometimes with the other in form. These are the classical romances—the *Matière de Rome*—which are not much later than those of Charlemagne and Arthur. The chief subjects with which their authors busied themselves were the conquests of Alexander and the siege of Troy, though other classical stories come in. The most remarkable of all is the romance of *Alixandre* by Lambert the Short and Alexander of Bernay. It has been said that the excellence of the twelve-syllabled verse used in this romance was the origin of the term alexandrine. The Trojan romances, on the other hand, are chiefly in octosyllabic verse, and the principal poem which treats of them is the *Roman de Troie* of Benoit de Sainte More. Both this poem and *Alixandre* are attributed to the last quarter of the 12th century. The authorities consulted for these poems were, as may be supposed, none of the best. Dares Phrygius, Dictys Cretensis, the pseudo-Callisthenes supplied most of them. But the inexhaustible invention of the trouvères themselves was the chief authority consulted. The adventures of Medea, the wanderings of Alexander, the Trojan horse, the story of Thebes, were quite sufficient to spur on to exertion the minds which had been accustomed to spin a chanson of some 10,000 lines out of a casual allusion in some preceding poem. It is needless to say that anachronisms did not disturb them. From first to last the writers of the chansons had not in the least troubled themselves with attention to any such matters. Charlemagne himself had his life and exploits accommodated to the need of every poet who treats of him, and the same is the case with the heroes of antiquity. Indeed, Alexander is made in many respects a prototype of Charlemagne. He is regularly knighted, he has twelve peers, he holds tournaments, he has relations with Arthur, and comes in contact with fairies, he takes fights in the air, dives in the sea and so forth. There is perhaps more avowed imagination

in these classical stories than in either of the other divisions of French epic poetry. Some of their authors even confess to the practice of fiction, while the trouvères of the chansons invariably assert the historical character of their facts and personages, and the authors of the Arthurian romances at least start from facts vouched for, partly by national tradition, partly by the authority of religion and the church. The classical romances, however, are important in two different ways. In the first place, they connect the early literature of France, however loosely, and with links of however dubious authenticity, with the great history and literature of the past. They show a certain amount of scholarship in their authors, and in their hearers they show a capacity of taking an interest in subjects which are not merely those directly connected with the village or the tribe. The chansons de geste had shown the creative power and independent character of French literature. There is, at least about the earlier ones, nothing borrowed, traditional or scholarly. They smack of the soil, and they rank France among the very few countries which, in this matter of indigenous growth, have yielded more than folk-songs and fireside tales. The Arthurian romances, less independent in origin, exhibit a wider range of view, a greater knowledge of human nature, and a more extensive command of the sources of poetical and romantic interest. The classical epics superadd the only ingredient necessary to an accomplished literature—that is to say, the knowledge of what has been done by other peoples and other literatures already, and the readiness to take advantage of the materials thus supplied.

Romans d'Avantures.—These are the three earliest developments of French literature on the great scale. They led, however, to a fourth, which, though later in date than all except their latest forms and far more loosely associated as a group, is so closely connected with them by literary and social considerations that it had best be mentioned here. This is the *roman d'aventures*, a title given to those almost avowedly fictitious poems which connect themselves, mainly and centrally, neither with French history, with the Round Table, nor with the heroes of antiquity. These began to be written in the 13th century, and continued until the prose form of fiction became generally preferred. The later forms of the chansons de geste and the Arthurian poems might indeed be well called romans d'aventures themselves. *Hugues Capet*, for instance, a chanson in form and class of subject, is certainly one of this latter kind in treatment; and there is a larger class of semi-Arthurian romance, which so to speak branches off from the main trunk. But for convenience sake the definition we have given is preferable. The style and subject of these romans d'aventures are naturally extremely various. *Guillaume de Palerne* deals with the adventures of a Sicilian prince who is befriended by a were-wolf; *Le Roman de l'esconfite*, with a heroine whose ring is carried off by a sparrow-hawk (*esconfite*), like Prince Camaralzaman's talisman; *Guy of Warwick*, with one of the most famous of imaginary heroes; *Meraugis de Portluc* is a sort of branch or offshoot of the romances of the Round Table; *Clomadès*, the work of the trouvère Adenès le Roi, who also rehandled the old chanson subjects of *Ogier* and *Berle aux grans piés*, connects itself once more with the *Arabian Nights* as well as with Chaucer forwards in the introduction of a flying mechanical horse. There is, in short, no possibility of classifying their subjects. The habit of writing in gestes, or of necessarily connecting the new work with an older one, had ceased to be binding, and the instinct of fiction writing was free; yet those romans d'aventures do not rank quite as high in literary importance as the classes which preceded them. This under-valuation arises rather from a lack of originality and distinctness of savour than from any shortcomings in treatment. Their versification, usually octosyllabic, is pleasant enough; but there is not much distinctness of character about them, and their incidents often strike the reader with something of the sameness, but seldom with much of the naïveté, of those of the older poems. Nevertheless some of them attained to a very high popularity, such, for instance, as the *Partenope de Blois* of Denis Pyramus, which has a motive drawn from the story of *Cupid and Psyche* and the charming *Floire et Blanchefleur*, giving the woe of a

Christian prince and a Saracen slave-girl. With them may be connected a certain number of early romances and fictions of various dates in prose, none of which can vie in charm with *Aucassin et Nicolette* (13th century), an exquisite literary presentment of medieval sentiment in its most delightful form.

In these classes may be said to be summed up the literature of feudal chivalry in France. They were all, except perhaps the last,

General characteristics of early narrative.

composed by one class of persons, the trouvères, and performed by another, the jongleurs. The latter, indeed, sometimes presumed to compose for himself, and was denounced as a *trouwer balard* by the indignant members of the superior caste. They were all originally intended to be performed in the *palais marbrin* of the baron to an audience of knights and ladies, and, when reading became more common, to be read by such persons. They dealt therefore chiefly, if not exclusively, with the class to whom they were addressed. The bourgeois and the villain, personages of political nonentity at the time of their early composition, come in for far slighter notice, although occasionally in the few curious instances we have mentioned, and others, persons of a class inferior to the seigneur play an important part. The habit of private wars and of insurrection against the sovereign supply the motives of the chanson de geste, the love of gallantry, adventure and foreign travel those of the romances Arthurian and miscellaneous. None of these motives much affected the lower classes, who were, with the early developed temper of the middle- and lower-class Frenchman, already apt to think and speak cynically enough of tournaments, courts, crusades and the other occupations of the nobility. The communal system was springing up, the towns were receiving royal encouragement as a counterpoise to the authority of the nobles. The corruptions and maladministration of the church attracted the satire rather of the citizens and peasantry who suffered by them, than of the nobles who had less to fear and even something to gain.

Spread of literary taste.

On the other hand, the gradual spread of learning, inaccurate and ill-digested perhaps, but still learning, not only opened up new classes of subjects, but opened them to new classes of persons. The thousands of students who flocked to the schools of Paris were not all princes or nobles. Hence there arose two new classes of literature, the first consisting of the embodiment of learning of one kind or other in the vulgar tongue. The other, one of the most remarkable developments of sportive literature which the world has seen, produced the second indigenous literary growth of which France can boast, namely, the fabliaux, and the almost more remarkable work which is an immense conglomerate of fabliaux, the great beast-epic of the *Roman de Renart*.

Fabliaux.—There are few literary products which have more originality and at the same time more diversity than the fabliau. The epic and the drama, even when they are independently produced, are similar in their main characteristics all the world over. But there is nothing in previous literature which exactly corresponds to the fabliau. It comes nearest to the Aesopic fable and its eastern origins or parallels. But differs from these in being less allegorical, less obviously moral (though a moral of some sort is usually if not always enforced), and in having a much more direct personal interest. It is in many degrees further removed from the parable, and many degrees nearer to the novel. The story is the first thing, the moral the second, and the latter is never suffered to interfere with the former. These observations apply only to the fabliaux, properly so called, but the term has been used with considerable looseness. The collectors of those interesting pieces, Barbazan, Méon, Le Grand d'Aussy, have included in their collections large numbers of miscellaneous pieces such as *dis* (rhymed descriptions of various objects, the most famous known author of which was Baudouin de Condé, 13th century), and *débats* (discussions between two persons or contrasts of the attributes of two things), sometimes even short romances, farces and mystery plays. Not that the fable proper—the prose classical beast-story of "Aesop"—was neglected. Marie de France—the poetess to be mentioned again for her more strictly poetical work—is the most literary

of not a few writers who composed what were often, after the mysterious original poet, named *Ysopète*. Aesop, Phaedrus, Babrius were translated and imitated in Latin and in the vernacular by this class of writer, and some of the best known of "fablers" date from this time. The fabliau, on the other hand, according to the best definition of it yet achieved, is "the recital, generally comic, of a real or possible incident occurring in ordinary human life." The comedy, it may be added, is usually of a satiric kind, and occupies itself with every class and rank of men, from the king to the villain. There is no limit to the variety of these lively verse-tales, which are invariably written in eight-syllabled couplets. Now the subject is the misadventure of two Englishmen, whose ignorance of the French language makes them confuse donkey and lamb; now it is the fortunes of an exceedingly foolish knight, who has an amiable and ingenious mother-in-law; now the deserved sufferings of an avaricious or ill-behaved priest; now the bringing of an ungrateful son to a better mind by the wisdom of babes and sucklings. Not a few of the *Canterbury Tales* are taken directly from fabliaux; indeed, Chaucer, with the possible exception of Prior, is our nearest approach to a fabliau-writer. At the other end of Europe the prose novels of Boccaccio and other Italian tale-tellers are largely based upon fabliaux. But their influence in their own country was the greatest. They were the first expression of the spirit which has since animated the most national and popular developments of French literature. Simple and unpretending as they are in form, the fabliaux announce not merely the *Cent Nouvelles Nouvelles* and the *Heptameron*, *L'Avocat Patelin*, and *Pantagruel*, but also *L'Avare* and the *Roman comique*, *Gil Blas* and *Candide*. They indeed do more than merely prophesy the spirit of these great performances—they directly lead to them. The prose-tale and the farce are the direct outcomes of the fabliau, and the prose-tale and the farce once given, the novel and the comedy inevitably follow.

The special period of fabliau composition appears to have been the 12th and 13th centuries. It signifies on the one side the growth of a lighter and more sportive spirit than had yet prevailed, on another the rise in importance of other and lower orders of men than the priest and the noble, on yet another the consciousness on the part of these lower orders of the defects of the two privileged classes, and of the shortcomings of the system of polity under which these privileged classes enjoyed their privileges. There is, however, in the fabliau proper not so very much of direct satire, this being indeed excluded by the definition given above, and by the thoroughly artistic spirit in which that definition is observed. The fabliaux are so numerous and so various that it is difficult to select any as specially representative. We may, however, mention, both as good examples and as interesting from their subsequent history, *Le Vair Falzroi*, treated in English by Leigh Hunt and by Peacock; *Le Vilain Miré*, the original consciously or unconsciously followed in *Le Médecin malgré lui*; *Le Roi d'Angleterre et le jongleur d'Éli*; *La houce partie*; *Le Seiz Chevalier*, an indecorous but extremely amusing story; *Las deux barbens ribaus*, a dialogue between two jongleurs of great literary interest, containing allusions to the chansons de geste and romances most in vogue; and *Le vilain qui conquist paradis par plaisir*, one of the numerous instances of what has unnecessarily puzzled moderns, the association in medieval times of sincere and unfeigned faith with extremely free handling of its objects. This lightheartedness in other subjects sometimes bubbled over into the *fabrisse*, an almost pure nonsense-piece, parent of the later *amphigouri*.

Roman de Renart.—If the fabliaux are not remarkable for direct satire, that element is supplied in more than compensating quantity by an extraordinary composition which is closely related to them. *Le Roman de Renart*, or *History of Reynard the Fox*, is a poem, or rather series of poems, which, from the end of the 12th to the middle of the 14th century, served the citizen poets of northern France, not merely as an outlet for literary expression, but also as a vehicle of satirical comment,—now on the general vices and weaknesses of humanity, now on the usual corruptions in church and state, now on the various historical

Social importance of fabliaux.

events which occupied public attention from time to time. The enormous popularity of the subject is shown by the long vogue which it had, and by the empire which it exercised over generations of writers who differed from each other widely in style and temper. Nothing can be farther from the allegorical erudition, the political diatribes and the sermonizing moralities of the authors of *Renart le Contre-fait* than the sly naïveté of the writers of the earlier branches. Yet these and a long and unknown series of intermediate bards the fox-king pressed into his service, and it is scarcely too much to say that, during the two centuries of his reign, there was hardly a thought in the popular mind which, as it rose to the surface, did not find expression in an addition to the huge cycle of *Renart*.

We shall not deal with the controversies which have been raised as to the origin of the poem and its central idea. The latter may have been a travesty of real persons and actual events, or it may (and much more probably) have been an expression of thoughts and experiences which recur in every generation. France, the Netherlands and Germany have contended for the honour of producing *Renart*; French, Flemish, German and Latin for the honour of first describing him. It is sufficient to say that the spirit of the work seems to be more that of the borderland between France and Flanders than of any other district, and that, wherever the idea may have originally arisen, it was incomparably more fruitful in France than in any other country. The French poems which we possess on the subject amount in all to nearly 100,000 lines, independently of mere variations, but including the different versions of *Renart le Contre-fait*. This vast total is divided into four different poems. The most ancient and remarkable is that edited by Méon under the title of *Roman du Renart*, and containing, with some additions made by M. Chabaille, 37 branches and about 32,000 lines. It must not, however, be supposed that this total forms a continuous poem like the *Aeneid* or *Paradise Lost*. Part was pretty certainly written by Pierre de Saint-Cloud, but he was not the author of the whole. On the contrary, the separate branches are the work of different authors, hardly any of whom are known, and, but for their community of subject and to some extent of treatment, might be regarded as separate poems. The history of *Renart*, his victories over Isengrim, the wolf, Brain, the bear, and his other unfortunate rivals, his family affection, his outwittings of King Noble the Lion and all the rest, are too well known to need fresh description here. It is perhaps in the subsequent poems, though they are far less known and much less amusing, that the hold which the idea of *Renart* had obtained on the mind of northern France, and the ingenious uses to which it was put, are best shown. The first of these is *Le Couronnement Renart*, a poem of between 3000 and 4000 lines, attributed, on no grounds whatever, to the poetess Marie de France, and describing how the hero by his ingenuity got himself crowned king. This poem already shows signs of direct moral application and generalizing. These are still more apparent in *Renart le Nouvel*, a composition of some 8000 lines, finished in the year 1288 by the Fleming Jacquemart Gielée. Here the personification, of which, in noticing the *Roman de la rose*, we shall soon have to give extended mention, becomes evident. Instead of or at least beside the lively personal *Renart* who used to steal sausages, set Isengrim fishing with his tail, or make use of Chanticleer's comb for a purpose for which it was certainly never intended, we have *Renardie*, an abstraction of guile and hypocrisy, triumphantly prevailing over other and better qualities. Lastly, as the *Roman de la rose* of William of Lorris is paralleled by *Renart le Nouvel*, so its continuation by Jean de Meung is paralleled by the great miscellany of *Renart le Contre-fait*, which, even in its existing versions, extends to fully 50,000 lines. Here we have, besides floods of miscellaneous erudition and discourse, political argument of the most direct and important kind. The wrongs of the lower orders are bitterly urged. They are almost openly incited to revolt; and it is scarcely too much to say, as M. Lenient has said, that the closely following *Jacquerie* is but a practical carrying out of the doctrines of the anonymous satirists of *Renart le Contre-fait*, one of whom (if

indeed there was more than one) appears to have been a clerk of Troyes.

Early Lyric Poetry.—Side by side with these two forms of literature, the epics and romances of the higher classes, and the fabliau, which, at least in its original, represented rather the feelings of the lower, there grew up a third kind, consisting of purely lyrical poetry. The song literature of medieval France is extremely abundant and beautiful. From the 12th to the 15th century it received constant accessions, some signed, some anonymous, some purely popular in their character, some the work of more learned writers, others again produced by members of the aristocracy. Of the latter class it may fairly be said that the catalogue of royal and noble authors boasts few if any names superior to those of Thibaut de Champagne, king of Navarre at the beginning of the 13th century, and Charles d'Orléans, the father of Louis XII., at the beginning of the 15th. Although much of this lyric poetry is anonymous, the more popular part of it almost entirely so, yet M. Paulin Paris was able to enumerate some hundreds of French chansonniers between the 11th and the 13th century. The earliest song literature, chiefly known in the delightful collection of Bartsch (*Altfranzösische Romansen und Pastourelles*), is mainly sentimental in character. The collector divides it under the two heads of romances and pastourelles, the former being usually the celebration of the loves of a noble knight and maiden, and recounting how Belle Doette or Eglantine or Orour sat at her windows or in the tourney gallery, or embroidering silk and samite in her chamber, with her thoughts on Gerard or Guy or Henry,—the latter somewhat monotonous but naïve and often picturesque recitals, very often in the first person, of the meeting of an errant knight or minstrel with a shepherdess, and his cavalier but not always successful wooing. With these, some of which date from the 12th century, may be contrasted, at the other end of the medieval period, the more varied and popular collection dating in their present form from the 15th century, and published in 1875 by M. Gaston Paris. In both alike, making allowance for the difference of their age and the state of the language, may be noticed a charming lyrical faculty and great skill in the elaboration of light and suitable metres. Especially remarkable is the abundance of refrains of an admirably melodious kind. It is said that more than 500 of these exist. Among the lyric writers of these four centuries whose names are known may be mentioned Audefroi le Bastard (12th century), the author of the charming song of *Belle Idoine*, and others no way inferior, Quesnes de Bethune, ^{Audefroi le Bastard.} the ancestor of Sully, whose song-writing inclines to a satirical cast in many instances, the Vidame de Chartres, Charles d'Anjou, King John of Brienne, the châtelain de Coucy, Gace Bruslé, Colin Muset, while not a few writers mentioned elsewhere—Guyot de Provins, Adam de la Halle, Jean Bodel and others—were also lyricists. But none of them, except perhaps Audefroi, can compare with Thibaut IV. (1202-1253), ^{Thibaut de Champagne.} who united by his possessions and ancestry a connexion with the north and the south, and who employed the methods of both districts but used the language of the north only. Thibaut was supposed to be the lover of Blanche of Castile, the mother of St Louis, and a great deal of his verse is concerned with his love for her. But while knights and nobles were thus employing lyric poetry in courtly and sentimental verse, lyric forms were being freely employed by others, both of high and low birth, for more general purposes. Blanche and Thibaut themselves came in for contemporary lampoons, and both at this time and in the times immediately following, a cloud of writers composed light verse, sometimes of a lyric sometimes of a narrative kind, and sometimes in a mixture of both. By far the most remarkable of these is Rutebœuf (a name which ^{Rutebœuf.} is perhaps a nickname), the first of a long series of French poets to whom in recent days the title Bohemian has been applied, who passed their lives between gaiety and misery, and celebrated their lot in both conditions with copious verse. Rutebœuf is among the earliest French writers who tell us their personal history and make personal appeals. But he does not confine himself to these. He discusses the history of his times

upbraids the nobles for their desertion of the Latin empire of Constantinople, considers the expediency of crusading, inveighs against the religious orders, and takes part in the disputes between the pope and the king. He composes pious poetry too, and in at least one poem takes care to distinguish between the church which he venerates and the corrupt churchmen whom he lampoons. Besides Rutebœuf the most characteristic figure of his class and time (about the middle of the 13th century) is

Adam de la Halle, commonly called the Hunchback of Arras. The earlier poems of Adam are of a sentimental character, the later ones satirical and somewhat

ill-tempered. Such, for instance, is his invective against his native city. But his chief importance consists in his *jeux*, the *Jeu de la feuillie*, the *Jeu de Robin et Marion*, dramatic compositions which led the way to the regular dramatic form. Indeed the general tendency of the 13th century is to satire, fable and *farce*, even more than to serious or sentimental poetry. We

should perhaps except the *lais*, the chief of which are known under the name of Marie de France. These *lais* are exclusively Breton in origin, though not in application, and the term seems originally to have had reference rather to the music to which they were sung than to the manner or matter of the pieces. Some resemblance to these *lais* may perhaps be traced in the genuine Breton songs published by M. Luzel. The subjects of the *lais* are indifferently taken from the Arthurian cycle, from ancient story, and from popular tradition, and, at any rate in Marie's hands, they give occasion for some passionate, and in the modern sense really romantic, poetry. The most famous of all is the *Lay of the Honeysuckle*, traditionally assigned to Sir Tristram.

Satiric and Didactic Works.—Among the direct satirists of the middle ages, one of the earliest and foremost is Guyot de Provins, a monk of Clairvaux and Cluny, whose *Bible*, as he calls it, contains an elaborate satire on the time (the beginning of the 13th century), and who was imitated by others, especially Hugues de Brégy. The same spirit soon betrayed itself in curious travesties of the romances of chivalry, and sometimes invades the later specimens of these romances themselves. One of the earliest examples of this travesty is the remarkable composition entitled *Audigier*. This poem, half fabliau and half romance, is not so much an instance of the hero-comic poems which afterwards found so much favour in Italy and elsewhere, as a direct and ferocious parody of the Carolingian epic. The hero Audigier is a model of cowardice and disloyalty; his father and mother, Turgibus and Rainberge, are deformed and repulsive. The exploits of the hero himself are coarse and hideous failures, and the whole poem can only be taken as a counterblast to the spirit of chivalry. Elsewhere a *trouvère*, prophetic of Rabelais, describes a vast battle between all the nations of the world, the quarrel being suddenly atoned by the arrival of a holy man bearing a huge flagon of wine. Again, we have the history of a solemn crusade undertaken by the citizens of a country town against the neighbouring castle. As erudition and the fancy for allegory gained ground, satire naturally availed itself of the opportunity thus afforded it; the disputes of Philippe le Bel with the pope and the Templars had an immense literary influence, partly in the concluding portions of the *Renart*, partly in the *Roman de la rose*, still to be mentioned, and partly in other satiric allegories of which the chief is the romance of *Fauvel*, attributed to François de Rues. The hero of this is an allegorical personage, half man and half horse, signifying the union of bestial degradation with human ingenuity and cunning. *Fauvel* (the name, it may be worth while to recall, occurs in Langland) is a divinity in his way. All the personages of state, from kings and popes to mendicant friars, pay their court to him.

But this serious and discontented spirit betrays itself also in compositions which are not parodies or travesties in form.

One of the latest, if not absolutely the latest (for *Baudouin de Sebourg*, Cuvelier's still later *Chronique de Du Guesclin* is only a most interesting imitation of the *chanson* form adapted to recent events), of the *chansons de geste* is *Baudouin de Sebourg*, one of the members of the great romance or cycle of

romances dealing with the crusades, and entitled *Le Chevalier au Cygne*. *Baudouin de Sebourg* dates from the early years of the 14th century. It is strictly a *chanson de geste* in form, and also in the general run of its incidents. The hero is dispossessed of his inheritance by the agency of traitors, fights his battle with the world and its injustice, and at last prevails over his enemy Gaufrois, who has succeeded in obtaining the kingdom of Friesland and almost that of France. Gaufrois has as his assistants two personages who were very popular in the poetry of the time,—viz., the Devil, and Money. These two sinister figures pervade the fabliaux, tales and fantastic literature generally of the time. M. Lenient, the historian of French satire, has well remarked that a romance as long as the *Renart* might be span out of the separate short poems of this period which have the Devil for hero, and many of which form a very interesting transition between the fabliau and the mystery. But the Devil is in one respect a far inferior hero to Renart. He has an adversary in the Virgin, who constantly upsets his best-laid schemes, and who does not always treat him quite fairly. The abuse of usury at the time, and the exactions of the Jews and Lombards, were severely felt, and Money itself, as personified, figures largely in the popular literature of the time.

Roman de la Rose.—A work of very different importance from all of these, though with seeming touches of the same spirit, a work which deserves to take rank among the most important of the middle ages, is the *Roman de la rose*,^{William de Lorris.}—one of the few really remarkable books which is

the work of two authors, and that not in collaboration but in continuation one of the other. The author of the earlier part was Guillaume de Lorris, who lived in the first half of the 13th century; the author of the later part was Jean de Meung, who was born about the middle of that century, and whose part in the *Roman* dates at least from its extreme end. This great poem exhibits in its two parts very different characteristics, which yet go to make up a not inharmonious whole. It is a love poem, and yet it is satire. But both gallantry and railery are treated in an entirely allegorical spirit; and this allegory, while it makes the poem tedious to hasty appetites of to-day, was exactly what gave it its charm in the eyes of the middle ages. It might be described as an *Ars amoris* crossed with a *Quodlibet*. This mixture exactly hit the taste of the time, and continued to hit it for two centuries and a half. When its obvious and gallant meaning was attacked by moralists and theologians, it was easy to quote the example of the Canticles, and to furnish esoteric explanations of the allegory. The writers of the 16th century were never tired of quoting and explaining it. Antoine de Baif, indeed, gave the simple and obvious meaning, and declared that "La rose c'est d'amours le guerdon gracieux"; but Marot, on the other hand, gives us the choice of four mystical interpretations,—the rose being either the state of wisdom, the state of grace, the state of eternal happiness or the Virgin herself. We cannot here analyse this celebrated poem. It is sufficient to say that the lover meets all sorts of obstacles in his pursuit of the rose, though he has for a guide the metaphorical personage Bel-Accueil. The early part, which belongs to William of Lorris, is remarkable for its gracious and fanciful descriptions. Forty years after Lorris's death, Jean de Meung completed it in an entirely different spirit. He keeps the allegorical form, and

indeed introduces two new personages of importance, Nature and Faux-semblant. In the mouths of these personages and of another, Raison, he puts the most extraordinary mixture of erudition and satire. At one time we have the history of classical heroes, at another theories against the hoarding of money, about astronomy, about the duty of mankind to increase and multiply. Accounts of the origin of loyalty, which would have cost the poet his head at some periods of history, and even communistic ideas, are also to be found here. In Faux-semblant we have a real creation of the theatrical hypocrite. All this miscellaneous and apparently incongruous material in fact explains the success of the poem. It has the one characteristic which has at all times secured the popularity of great works of literature. It holds the mirror up firmly and fully to its age. As we find in Rabelais

the characteristics of the Renaissance, in Montaigne those of a sceptical reaction from Renaissance and reform alike, in Colière those of the society of France after Richelieu had tamed and levelled it, in Voltaire and Rousseau respectively the two aspects of the great revolt,—so there are to be found in the *Roman de la rose* the characteristics of the later middle age, its gallantry, its mysticism, its economical and social troubles and problems, its scholastic methods of thought, its naïve acceptance as science of everything that is written, and at the same time its shrewd and indiscriminate criticism of much that the age of criticism is accepted without doubt or question. The *Roman de la rose*, might be supposed, set the example of an immense literature of allegorical poetry, which flourished more and more until the Renaissance. Some of these poems we have already mentioned; some will have to be considered under the head of the 15th century. But, as usually happens in such cases and was certain to happen in this case, the allegory which has seemed tedious to any, even in the original, became almost intolerable in the majority of the imitations.

We have observed that, at least in the later section of the *romans de la rose*, there is observable a tendency to import into the poem indiscriminate erudition. This tendency is now remote from our poetical habits; but in its own day it was only the natural result of the use of poetry for all literary purposes. It was many centuries before prose became recognized as the proper vehicle for instruction, and at a very early date verse was used as well for educational and moral as for recreative and artistic purposes. French verse was the first born of all literary mediums in modern European speech, and the resources of ancient learning were certainly at less accessible in France than in any other country. Dante, in his *De vulgari eloquio*, acknowledges the excellence of the didactic writers of the Langue d'Oïl. We have already alluded to the *Bestiary* of Philippe de Thauan, a Norman (trouvère) who lived and wrote in England during the reign of Henry Beauclerc. Besides the *Bestiary*, which from its dedication to Queen Adela has been conjectured to belong to the third decade of the 12th century, Philippe wrote also in French a *Liber de creaturis*, both works being translated from the Latin. These works of mystical and apocryphal physics and zoology became extremely popular in the succeeding centuries, and were frequently imitated. A moralizing turn was also given to them, which was much aided by the importation of several miscellanies of Oriental origin, partly tales, partly didactic in character, the most celebrated of which is the *Roman des sept sages*, which, under that title and the variant of *Dolopathos*, received repeated treatment from French writers both in prose and verse. The odd notion of an *Ovide moralisé* used to be ascribed to Philippe de Vitry, bishop of Meaux (1291?—1301?), a person complimented by Petrarch, but is now assigned to a certain Chrétien Legonaire. It, too, soon demanded exposition in verse, as well as science. The favourite pastime of the chase was repeatedly dealt with, notably in the *Roi Modus* (1325), mixed prose and verse; and the *Jeux de la chasso* (1387), of Gaston de Foix, prose; and the *Preneur de Venarie* of Hardouin (1394), verse. Very soon didactic verse extended itself to all the arts and sciences. Vegetius and his military precepts had found a home in French octosyllables as early as the 12th century; the end of the same age saw the ceremonies of knighthood solemnly versified, and *mapes* (maps) *le monde* also soon appeared. At last, in 1245, Gautier of Metz translated from various Latin works into French verse a sort of encyclopaedia, while another, incongruous but known as *l'Image du monde*, exists from the same century. Profane knowledge was not the only subject which exercised didactic poets at this time. Religious handbooks and commentaries on the scriptures were common in the 13th and following centuries, and, under the title of *Castoiments*, *Enseignements* and *Doctrines*, moral treatises became common. The most famous of these, the *Castoiment d'un père à son fils*, falls under the class, already mentioned, of works due to oriental influence, being derived from the Indian *Panchatantra*. In the 14th century the influence of the *Roman de la rose* helped to render moral verse

frequent and popular. The same century, moreover, which witnessed these developments of well-intentioned if not always judicious erudition witnessed also a considerable change in lyrical poetry. Hitherto such poetry had chiefly been composed in the melodious but unconstrained forms of the romance and the pastourelle. In the 14th century the writers of northern France subjected themselves to severer rules. In this age arose the forms which for so long a time were to occupy French singers,—the ballade, the rondeau, the rondel, the triolet, the chant royal and others. These received considerable alterations as time went on. We possess not a few *Artes poeticae*, such as that of Eustache Deschamps at the end of the 14th century, that formerly ascribed to Henri de Croy and now to Molinet at the end of the 15th, and that of Thomas Sibilet in the 16th, giving particulars of them, and these particulars show considerable changes. Thus the term rondeau, which since Villon has been chiefly limited to a poem of 15 lines, where the 9th and 15th repeat the first words of the first, was originally applied both to the rondel, a poem of 13 or 14 lines, where the first two are twice repeated integrally, and to the triolet, one of 8 only, where the first line occurs three times and the second twice. The last is an especially popular metre, and is found where we should least expect it, in the dialogue of the early farces, the speakers making up triolets between them. As these three forms are closely connected, so are the ballade and the chant royal, the latter being an extended and more stately and difficult version of the former, and the characteristic of both being the identity of rhyme and refrain in the several stanzas. It is quite uncertain at what time these fashions were first cultivated, but the earliest poets who appear to have practised them extensively were born at the close of the 13th and the beginning of the 14th centuries. Of these Guillaume de Machault (c. 1300—1380) is the oldest. He has left us 80,000 verses, never yet completely printed. Eustache Deschamps (c. 1340—c. 1410) was nearly as prolific, but more fortunate as more meritorious, the Société des anciens Textes having at last provided a complete edition of him. Froissart the historian (1333—1410) was also an agreeable and prolific poet. Deschamps, the most famous as a poet of the three, has left us nearly 1200 ballades and nearly 200 rondeaux, besides much other verse all manifesting very considerable poetical powers. Less known but not less noteworthy, and perhaps the earliest of all, is Jehannot de Lescurel, whose personality is obscure, and most of whose works are lost, but whose remains are full of grace. Froissart appears to have had many countrymen in Hainault and Brabant who devoted themselves to the art of versification; and the *Liwe des cent ballades* of the Marshal Boucicault (1366—1421) and his friends—c. 1390—shows that the French gentleman of the 14th century was as apt at the ballade as his Elizabethan peer in England was at the sonnet.

Early Drama.—Before passing to the prose writers of the middle ages, we have to take some notice of the dramatic productions of those times—productions of an extremely interesting character, but, like the immense majority of medieval literature, poetic in form. The origin or the revival of dramatic composition in France has been hotly debated, and it has been sometimes contended that the tradition of Latin comedy was never entirely lost, but was handed on chiefly in the convents by adaptations of the Terentian plays, such as those of the nun Hrosowitha. There is no doubt that the mysteries (subjects taken from the sacred writings) and miracle plays (subjects taken from the legends of the saints and the Virgin) are of very early date. The mystery of the *Foolish Virgins* (partly French, partly Latin), that of *Adam* and perhaps that of *Daniel*, are of the 12th century, though due to unknown authors. Jean Bodel and Ruteboeuf, already mentioned, gave, the one that of *Saint Nicolas* at the confines of the 12th and 13th, the other that of *Théophile* later in the 13th itself. But the later moralities, soties, and farces seem to be also in part a very probable development of the simpler and earlier forms of the fabliau and of the tenson or jeu-parti, a poem in simple dialogue much used by both troubadours

Artificial forms of verse.

Mysteries and miracles.

and trouvères. The fabliau has been sufficiently dealt with already. It chiefly supplied the subject; and some miracle-plays and farces are little more than fabliaux thrown into dialogue. Of the jeux-partis there are many examples, varying from very simple questions and answers to something like regular dramatic dialogue; even short romances, such as *Aucassin et Nicolette*, were easily susceptible of dramatization. But the *Jeu de la fenille* (or *fenille*) of Adam de la Halle seems to be the earliest piece, profane in subject, containing something more than mere dialogue. The poet has not indeed gone far for his subject, for he brings in his own wife, father and friends, the interest being complicated by the introduction of stock characters (the doctor, the monk, the fool), and of certain fairies—personages already popular from the later romances of chivalry. Another piece of Adam's, *Le Jeu de Robin et Marion*, also already alluded to, is little more than a simple throwing into action of an ordinary pastourelle with a considerable number of songs to music. Nevertheless later criticism has seen, and not unreasonably, in these two pieces the origin in the one case of farce, and thus indirectly of comedy proper, in the other of comic opera.

For a long time, however, the mystery and miracle-plays remained the staple of theatrical performance, and until the 13th century actors as well as performers were more or less taken from the clergy. It has, indeed, been well pointed out that the offices of the church were themselves dramatic performances, and required little more than development at the hands of the mystery writers. The occasional festive outbursts, such as the Feast of Fools, that of the Boy Bishop and the rest, helped on the development. The variety of mysteries and miracles was very great. A single manuscript contains forty miracles of the Virgin, averaging from 1200 to 1500 lines each, written in octosyllabic couplets, and at least as old as the 14th century, most of them perhaps much earlier. The mysteries proper, or plays taken from the scriptures, are older still. Many of these are exceedingly long. There is a *Mystère de l'Ancien Testament*, which extends to many volumes, and must have taken weeks to act in its entirety. The *Mystère de la Passion*, though not quite so long, took several days, and recounts the whole history of the gospels. The best apparently of the authors of these pieces, which are mostly anonymous, were two brothers, Arnoul and Simon Gréban (authors of the *Actes des apôtres*, and in the first case of the *Passion*), c. 1450, while a certain Jean Michel (d. 1493) is credited with having continued the *Passion* from 30,000 lines to 50,000. But these performances, though they held their ground until the middle of the 16th century and extended their range of subject from sacred to profane history—legendary as in the *Destruction de Troie*, contemporary as in the

Siege d'Orléans—were soon rivalled by the more profane performances of the moralities, the farces and the soties. The palmy time of all these three kinds is the 15th century, while the Confrérie de la Passion itself, the special performers of the sacred drama, only obtained the licence constituting it by an ordinance of Charles VI. in 1402. In order, however, to take in the whole of the mediæval theatre at a glance, we may anticipate a little. The Confraternity was not itself the author or performer of the profaner kind of dramatic performance. This latter was due to two other bodies, the clerks of the Bazoche and the *Enfans sans Souci*. As the Confraternity was chiefly composed of tradesmen and persons very similar to Peter Quince and his associates, so the clerks of the Bazoche were members of the legal profession of Paris, and the *Enfans sans Souci* were mostly young men of family. The morality was the special property of the first, the sottie of the second. But as the moralities were sometimes decidedly tedious plays, though by no means brief, they were varied by the introduction of farces, of which the *jeux* already mentioned were the early germ, and of which *L'Avocat Patelin*, dated by some about 1465 and certainly about 200 years subsequent to Adam de la Halle, is the most famous example.

The morality was the natural result on the stage of the immense literary popularity of allegory in the *Roman de la rose* and its imitations. There is hardly an abstraction, a virtue, a vice, a

disease, or anything else of the kind, which does not figure in these compositions. There is *Bien Advisé* and *Mal Advisé*, the good boy and the bad boy of nursery stories, who fall in respectively with Faith, Reason and Humility, and *Moultin* with Rashness, Luxury and Folly. There is the hero *Mange-Tout*, who is invited to dinner by Banquet, and meets after dinner very unpleasant company in Colique, Goutte and Hydro-pisie. *Honte-de-dire-ses-Péchés* might seem an anticipation of Puritan nomenclature to an English reader who did not remember the contemporary or even earlier *personas* of Langland's poem. Some of these moralities possess distinct dramatic merit; among these is mentioned *Les Blasphémateurs*, an early and remarkable presentation of the Don Juan story. But their general character appears to be gravity, not to say dullness. The *Enfans sans Souci*, on the other hand, were definitely satirical, and nothing if not amusing. The chief of the society was entitled *Prince des Sots*, and his crown was a hood decorated with asses' ears. The sottie was directly satirical, and only assumed the guise of folly as a stalking-horse for shooting wit. It was more Aristophanic than any other modern form of comedy, and like its predecessor, it perished as a result of its political application. Encouraged for a moment as a political engine at the beginning of the 16th century, it was soon absolutely forbidden and put down, and had to give place in one direction to the lampoon and the prose pamphlet, in another to forms of comic satire more general and vague in their scope. The farce, on the other hand, having neither moral purpose nor political intention, was a purer work of art, enjoyed a wider range of subject, and was in no danger of any permanent extinction. Farcical interludes were interpolated in the mysteries themselves; short farces introduced and rendered palatable the moralities, while the sottie was itself but a variety of farce, and all the kinds were sometimes combined in a sort of tetralogy. It was a short composition, 500 verses being considered sufficient, while the morality might run to at least 1000 verses, the miracle-play to nearly double that number, and the mystery to some 40,000 or 50,000, or indeed to any length that the author could find in his heart to bestow upon the audience, or the audience in their patience to suffer from the author. The number of persons and societies who acted these performances grew to be very large, being estimated at more than 5000 towards the end of the 15th century. Many fantastic personages came to join the *Princes des Sots*, such as the *Empereur de Galilée*, the *Princes de l'Érille*, and des *Nouveaux Mariés*, the *Roi de l'ÉpINETTE*, the *Recteur des Fous*. Of the pieces which these societies represented one only, that of *Maitre Patelin*, is now much known; but many are almost equally amusing. *Patelin* itself has an immense number of versions and editions. Other farces are too numerous to attempt to classify; they bear, however, in their subjects, as in their manner, a remarkable resemblance to the fabliaux, their source. Conjugal disagreements, the unpleasantness of mothers-in-law, the shifty or, in the earlier stages, clumsy valet and chambermaid, the mishaps of too loosely given ecclesiastics, the abuses of relics and pardons, the extortion, violence, and sometimes cowardice of the seigneur and the soldiery, the corruption of justice, its delays and its pompous apparatus, supply the subjects. The treatment is rather narrative than dramatic in most cases, as might be expected, but makes up by the liveliness of the dialogue for the deficiency of elaborately planned action and interest. All these forms, it will be observed, are directly or indirectly comic. Tragedy in the middle ages is represented only by the religious drama, except for a brief period towards the decline of that form, when the "profane" mysteries referred to above came to be represented. These were, however, rather "histories," in the Elizabethan sense, than tragedies proper.

Prose History.—In France, as in all other countries of whose literary developments we have any record, literature in prose is considerably later than literature in verse. We have certain glosses or vocabularies possibly dating as far back as the 8th or even the 7th century; we have the *Early chronicles* Strassburg oaths, already described, of the 9th, and a commentary

on the prophet Jonas which is probably as early. In the 10th century there are some charters and muniments in the vernacular; of the 11th the laws of William the Conqueror are the most important document; while the *Assises de Jérusalem* of Godfrey of Bouillon date, though not in the form in which we now possess them, from the same age. The 12th century gives us certain translations of the Scriptures, and the remarkable Arthurian romances already alluded to; and thenceforward French prose, though long less favoured than verse, begins to grow in importance. History, as is natural, was the first subject which gave it a really satisfactory opportunity of developing its powers. For a time the French chroniclers contented themselves with Latin prose or with French verse, after the fashion of Wace and the Belgian, Philippe Mouskés (1215-1283). These, after a fashion universal in medieval times, began from fabulous or merely literary origins, and just as Wytoun later carries back the history of Scotland to the terrestrial paradise, so does Mouskés start that of France from the rape of Helen. But soon prose chronicles, first translated, then original, became common; the earliest of all is said to have been that of the pseudo-Turpin, which thus recovered in prose the language which had originally clothed it in verse, and which, to gain a false appearance of authenticity, it had exchanged still earlier for Latin. Then came French selections and versions from the great series of historical compositions undertaken by the monks of St Denys, the so-called *Grandes Chroniques de France* from the date of 1274, when they first took form in the hands of a monk styled Primat, to the reign of Charles V., when they assumed the title just given. But the first really remarkable author who used French prose as a vehicle of historical expression is Geoffroi de Villehardouin, marshal of Champagne, who was born rather after the middle of the 12th century, and died in Greece in 1212. Under the title of *Conquête*

de Constantinoble Villehardouin has left us a history of the fourth crusade, which has been accepted by all competent judges as the best picture extant of feudal chivalry in its prime. The *Conquête de Constantinoble* has been well called a *chanson de geste* in prose, and indeed in the surprising nature of the feats it celebrates, in the abundance of detail, and in the vivid and picturesque poetry of the narration, it equals the very best of the chansons. Even the repetition of the same phrases which is characteristic of epic poetry repeats itself in this epic prose; and as in the chansons so in Villehardouin, few motives appear but religious fervour and the love of fighting, though neither of these excludes a lively appetite for booty and a constant tendency to disunion and disorder. Villehardouin was continued by Henri de Valenciennes, whose work is less remarkable, and has more the appearance of a rhymed chronicle thrown into prose, a process which is known to have been actually applied in some cases. Nor is the transition from Villehardouin to Jean de Joinville (considerable in point of time, for Joinville was not born till ten years after Villehardouin's death) in point of literary history immediate. The rhymed chronicles of Philippe Mouskés and Guillaume Guiart belong to this interval; and in prose the most remarkable works are the *Chronique de Reims*, a well-written history, having the interesting characteristics of taking the lay and popular side, and the great compilation edited (in the modern sense) by Baudouin d'Avesnes (1213-1289). Joinville (? 1224-1317), whose special subject is the Life of St Louis, is far more modern than even the half-century which separates him from Villehardouin would lead us to suppose. There is nothing of the knight-errant about him personally, notwithstanding his devotion to his hero. Our Lady of the Broken Lances is far from being his favourite saint. He is an admirable writer, but far less simple than Villehardouin; the good King Louis tries in vain to make him share his own rather high-flown devotion. Joinville is shrewd, practical, there is even a touch of the Voltairian about him; but he, unlike his predecessor, has political ideas and antiquarian curiosity, and his descriptions are often very creditable pieces of deliberate literature.

It is very remarkable that each of the three last centuries of feudalism should have had one specially and extraordinarily

gifted chronicler to describe it. What Villehardouin is to the 12th and Joinville to the 13th century, that Jean Froissart (1337-1410) is to the 14th. His picture is the most famous as it is the most varied of the three, but it has special drawbacks as well as special merits. French critics have indeed been scarcely fair to Froissart, because of his early partiality to our own nation in the great quarrel of the time, forgetting that there was really no reason why he as a Hainaulter should take the French side. But there is no doubt that if the duty of an historian is to take in all the political problems of his time, Froissart certainly comes short of it. Although the feudal state in which knights and churchmen were alone of estimation was at the point of death, and though new orders of society were becoming important, though the distress and confusion of a transition state were evident to all, Froissart takes no notice of them. Society is still to him all knights and ladies, tournaments, skirmishes and feasts. He depicts these, not like Joinville, still less like Villehardouin, as a sharer in them, but with the facile and picturesque pen of a sympathizing literary onlooker. As the comparison of the *Conquête de Constantinoble* with a *chanson de geste* is inevitable, so is that of Froissart's *Chronique* with a roman d'aventures.

For Provençal Literature see the separate article under that heading.

15th Century.—The 15th century holds a peculiar and somewhat disputed position in the history of French literature, as, indeed, it does in the history of the literature of all Europe, except Italy. It has sometimes been regarded as the final stage of the medieval period, sometimes as the earliest of the modern, the influence of the Renaissance in Italy already filtering through. Others again have taken the easy step of marking it as an age of transition. There is as usual truth in all these views. Feudality died with Froissart and Eustache Deschamps. The modern spirit can hardly be said to arise before Rabelais and Ronsard. Yet the 15th century, from the point of view of French literature, is much more remarkable than its historians have been wont to confess. It has not the strongly marked and compact originality of some periods, and it furnishes only one name of the highest order of literary interest; but it abounds in names of the second rank, and the very difference which exists between their styles and characters testifies to the existence of a large number of separate forces working in their different manners on different persons. Its theatre we have already treated by anticipation, and to it we shall afterwards recur. It was the palmy time of the early French stage, and all the dramatic styles which we have enumerated then came to perfection. Of no other kind of literature can the same be said. The century which witnessed the invention of printing naturally devoted itself at first more to the spreading of old literature than to the production of new. Yet as it perfected the early drama, so it produced the prose tale. Nor, as regards individual and single names, can the century of Charles d'Orléans, of Alain Chartier, of Christine de Pisan, of Coquillart, of Comines, and, above all, of Villon, be said to lack illustrations.

First among the poets of the period falls to be mentioned the shadowy personality of Olivier Basselin. Modern criticism has attacked the identity of the jovial miller, who was once supposed to have written and perhaps invented the songs called *vaux de vire*, and to have also carried on a patriotic warfare against the English. But though Jean le Houx may have written the poems published under Basselin's name two centuries later, it is taken as certain that an actual Olivier wrote actual *vaux de vire* at the beginning of the 15th century. About Christine de Pisan (1363-1430) and Alain Chartier (1392-c. 1430) there is no such doubt. Christine was the daughter of an Italian astrologer who was patronized by Charles V. She was born in Italy but brought up in France, and she enriched the literature of her adopted country with much learning, good sense and patriotism. She wrote history, devotional works and poetry; and though her literary merit is not of the highest, it is very far from despicable. Alain Chartier, best known to modern readers by

Froissart.

Christine de Pisan.

Alain Chartier.

the story of *Margaret of Scotland's Kiss*, was a writer of a somewhat similar character. In both Christine and Chartier there is a great deal of rather heavy moralizing, and a great deal of rather pedantic erudition. But it is only fair to remember that the intolerable political and social evils of the day called for a good deal of moralizing, and that it was the function of the writers of this time to fill up as well as they could the scantily filled vessels of medieval science and learning. A very different

person is Charles d'Orléans (1392-1465), one of the greatest of *grands seigneurs*, for he was the father of a king of France, and heir to the duchies of Orléans and Milan. Charles, indeed, if not a Roland or a Bayard, was an admirable poet. He is the best-known and perhaps the best writer of the graceful poems in which an artificial versification is strictly observed, and helps by its recurrent lines and modulated rhymes to give to poetry something of a musical accompaniment even without the addition of music properly so called. His ballades are certainly inferior to those of Villon, but his rondels are unequalled. For fully a century and a half these forms engrossed the attention of French lyrical poets. Exercises in them were produced in enormous numbers, and of an excellence which has only recently obtained full recognition even in France. Charles d'Orléans is himself sufficient proof of what can be done in them in the way of elegance, sweetness, and grace which some have unjustly called effeminacy. But that this effeminacy was no natural or inevitable fault of the ballades and the rondeaux was fully proved by the most remarkable literary figure of the 15th century in France. To François Villon (1431-1463?), as to other great single writers, no attempt can be made to do justice in this place. His remarkable life and character especially lie outside our subject. But he is universally recognized as the most important single figure of French literature before the Renaissance. His work is very strange in form, the undoubtedly genuine part of it consisting merely of two compositions, known as the great and little Testament, written in stanzas of eight lines of eight syllables each, with lyrical compositions in ballade and rondeau form interspersed. Nothing in old French literature can compare with the best of these, such as the "Ballade des dames du temps jadis," the "Ballade pour sa mère," "La Grosse Margot," "Les Regrets de la belle Heulmière," and others; while the whole composition is full of poetical traits of the most extraordinary vigour, picturesqueness and pathos. Towards the end of the century the poetical production of the time became very large. The artificial measures already alluded to, and others far more artificial and infinitely less beautiful, were largely practised. The typical poet of the end of the 15th century is Guillaume Crétin (d. 1525), who distinguished himself by writing verses with punning rhymes, verses ending with double or treble repetitions of the same sound, and many other tasteless absurdities, in which, as Pasquier remarks, "il perdit toute la grâce et la liberté de la composition." The other favourite direction of the poetry of the time was a vein of allegorical moralizing drawn from the *Roman de la rose* through the medium of Chartier and Christine, which produced "Castles of Love," "Temples of Honour," and such like. The combination of these drifts in verse-writing produced a school known in literary history, from a happy phrase of the satirist Coquillart (v. *inf.*), as the "Grands Rhétoriciens." The chief of these besides Crétin were Jean Molinet (d. 1507); Jean Meschinot (c. 1420-1491), author of the *Lunettes des princesses*; Florimond Robertet (d. 1522); Georges Chastellain (1404-1475), to be mentioned again; and Octavien de Saint-Gelais (1466-1502), father of a better poet than himself. Yet some of the minor poets of the time are not to be despised. Such are Henri Baude (1430-1490), a less pedantic writer than most, Martial d'Auvergne (1440-1508), whose principal work is *L'Amant rendu cordelier au service de l'amour*, and others, many of whom formed part of the poetical court which Charles d'Orléans kept up at Blois after his release.

While the serious poetry of the age took this turn, there was no lack of lighter and satirical verse. Villon, indeed, were it not for the depth and pathos of his poetical sentiment, might

be claimed as a poet of the lighter order, and the patriotic diatribes against the English to which we have alluded easily passed into satire. The political quarrels of the latter part of the century also provoked much satirical composition. The disputes of the Bien Public and those between Louis XI and Charles of Burgundy employed many pens. The most remarkable piece of the light literature of the first is "Lea Anes Volants," a ballad on some of the early favourites of Louis. The battles of France and Burgundy were waged on paper between Gilles des Ormes and the above-named Georges Chastellain, typical representatives of the two styles of 15th-century poetry already alluded to—Des Ormes being the lighter and more graceful writer, Chastellain a pompous and learned allegorist. The most remarkable representative of purely light poetry outside the theatre is Guillaume Coquillart (1421-1510), a lawyer of Champagne, who resided for the greater part of his life in Reims. This city, like others, suffered from the pitiless tyranny of Louis XI. The beginnings of the standing army which Charles VII. had started were extremely unpopular, and the use to which his son put them by no means removed this unpopularity. Coquillart described the military man of the period in his *Monologue du gendarme cassé*. Again, when the king entertained the idea of unifying the taxes and laws of the different provinces, Coquillart, who was named commissioner for this purpose, wrote on the occasion a satire called *Les Droits nouveaux*. A certain kind of satire, much less good-tempered than the earlier forms, became indeed common at this epoch. M. Lenient has well pointed out that a new satirical personification dominates this literature. It is no longer Renart with his cynical gaiety, or the curiously travestied and almost amiable Devil of the Middle Ages. Now it is Death as an incident ever present to the imagination, celebrated in the thousand repetitions of the *Danse Macabre*, sculptured all over the buildings of the time, even frequently performed on holidays and in public. With the usual tendency to follow pattern, the idea of the "dance" seems to have been extended, and we have a *Danst aux aveugles* (1464) from Pierre Michaut, where the teachers are fortune, love and death, all blind. All through the century, too, anonymous verse of the lighter kind was written, some of it of great merit. The folk-songs already alluded to, published by Gaston Paris, show one side of this composition, and many of the pieces contained in M. de Montaiglon's extensive *Recueil des anciennes poésies françaises* exhibit others.

The 15th century was perhaps more remarkable for its achievements in prose than in poetry. It produced, indeed, no prose writer of great distinction, except Comines; but it witnessed serious, if not extremely successful, efforts at prose composition. The invention of printing finally substituted the reader for the listener, and when this substitution has been effected, the main inducement to treat unsuitable subjects in verse is gone. The study of the classics at first hand contributed to the same end. As early as 1458 the university of Paris had a Greek professor. But long before this time translations in prose had been made. Pierre Bercheure (Bersuire) (1290-1352) had already translated Livy. Nicholas Oresme (c. 1334-1382), the tutor of Charles V., gave a version of certain Aristotelian works, which enriched the language with a large number of terms, then strange enough, now familiar. Raoul de Presles (1316-1383) turned into French the *De civitate Dei* of St Augustine. These writers or others composed *Le Songe du veigier*, an elaborate discussion of the power of the pope. The famous chancellor, Jean Chartier or Gerson (1363-1429), to whom the *Imitation* has among so many others been attributed, spoke constantly and wrote often in the vulgar tongue, though he attacked the most famous and popular work in that tongue, the *Roman de la rose*. Christine de Pisan and Alain Chartier were at least as much prose writers as poets; and the latter, while he, like Gerson, dealt much with the reform of the church, used in his *Quadrilogue invectif* really forcible language for the purpose of spurring on the nobles of France to put an end to her sufferings and evils. These moral and didactic treatises were but continuations of others, which for convenience sake we have hitherto left unnoticed. Though

was in the centuries prior to the 15th the favourite medium of literary composition, it was by no means the only one; and in the 16th and 17th centuries it was almost entirely superseded by the novel and educational treatises—some referred to above—already in vogue in the 15th century. Certain household books (*Livres de cheville*) have been preserved, some of which date as far back as the 13th century. These contain not merely accounts, but also chronicles, receipts and the like. Accounts of travel, especially to the Holy Land, culminated in the famous *Voyage de Jehan de Mandeville* which, though it has never been of so much importance in French as in English, perhaps first took vernacular form in the French tongue. Of the 14th century, we have a *gier de Paris*, intended for the instruction of a young wife, and a large number of miscellaneous treatises of art, science and morality, while private letters, mostly as yet unpublished, in considerable numbers, and are generally of the moralizing character; books of devotion, too, are naturally frequent. The most important divisions of medieval energy in prose composition are the spoken exercises of the pulpit and the bar.

The beginnings of French sermons have been much discussed, especially the question whether St Bernard, whose discourses we possess in ancient, but doubtfully contemporary French, pronounced them in that language or in Latin. Towards the end of the 12th century, the sermons of Maurice de Sully (1160-1196) present not undoubted examples of homiletics in the vernacular, but are followed by many others—so many indeed that the 13th century alone counts 261 sermon-writers, besides a large number of anonymous work. These sermons were, as might indeed be expected, chiefly cast in a somewhat scholastic form—theme, argument, development, example and peroration following a regular order. The 14th-century sermons, on the other hand, as yet been little investigated. It must, however, be observed that this age was the most famous of all for its artistic illustrations, and for the early vigour of the Dominican and Franciscan orders. With the end of the century and the beginning of the 15th, the importance of the pulpit begins to decline.

The early years of the new age have Gerson for their representative, while the end of the century sees the still more famous names of Michel Menot (1450-1518), Olivier Maillard (1500-1502), and Jean Rahn (1443-1514), all remarkable for their practice of a vigorous and homely style of oratory, and for their freedom from that which we should nowadays style buffoonery, manifesting a creditable indifference to the indignation of palatines and powers. Louis XI. is said to have threatened Olivier Maillard into the Seine, and many instances of the boldness of these preachers and the rough vigour of their oratory have been preserved. Froissart had been followed as a chronicler by Guérard de Monstrelet (c. 1390-1453) and by the historians of the Burgundian court, Chastelain, already mentioned, and the interesting *Chronique de Jacques de Lalaing* is much the most attractive part of his work, and Olivier de la Marche. The French and chronicle writers, who were to be of so much importance in French literature, also begin to be numerous at this time. Juvenal des Ursins (1388-1473), an anonymous bourgeois (two such indeed), and the author of the *Chronique de France*, may be mentioned as presenting the character of the observer and recorder which has distinguished the French historian since. Jean le Maire de (not des) Belges (1473-c. 1525) is a historiographer to Louis XII. and wrote *Illustrations des Rois de France*. But Comines (1445-1509) is no imitator of Froissart or of any one else. The last of the quartette of great French medieval historians, he does not yield to any of his three predecessors in originality or merit, but he is very far from them. He fully represents the mania of the time for the study of the past, and his book has long ranked with that of Machiavelli as a manual of the art, though he has not the absolutely moral character of the Italian. His memoirs, considered as literature, show a style well suited to their purport,—indeed, brilliant or picturesque, but clear, terse and admirably well suited to the expression of the acuteness, observation and common sense of their author.

French medieval historians, he does not yield to any of his three predecessors in originality or merit, but he is very far from them. He fully represents the mania of the time for the study of the past, and his book has long ranked with that of Machiavelli as a manual of the art, though he has not the absolutely moral character of the Italian. His memoirs, considered as literature, show a style well suited to their purport,—indeed, brilliant or picturesque, but clear, terse and admirably well suited to the expression of the acuteness, observation and common sense of their author.

prose was not content with the domain of serious literature.

It had already long possessed a respectable position as a vehicle of romance, and the end of the 14th and the beginning of the 15th centuries were pre-eminently the time when the epics of chivalry were re-edited and extended into prose. Few, however, of these extensions offer much literary interest. On the other hand, the best prose of the century, and almost the earliest which deserves the title of a satisfactory literary medium, was employed for the telling of romances in miniature. The *Cent Nouvelles Nouvelles* is undoubtedly the first work of prose belles-lettres in French, and the first, moreover, of a long and most remarkable class of literary work in which French writers may challenge all comers with the certainty of victory—the short prose tale of a comic character. This remarkable work has usually been attributed, like the somewhat similar but later *Heptaméron*, to a knot of literary courtiers gathered round a royal personage, in this case the dauphin Louis, afterwards Louis XI. Some evidence has recently been produced which seems to show that this tradition, which attributed some of the tales to Louis himself, is erroneous, but the question is still undecided. The subjects of the *Cent Nouvelles Nouvelles* are by no means new. They are simply the old themes of the fabliaux treated in the old way. The novelty is in the application of prose to such a purpose, and in the crispness, the fluency and the elegance of the prose used. The fortunate author or editor to whom these admirable tales have of late been attributed is Antoine de la Salle (1398-1461), who, if this attribution and certain others be correct, must be allowed to be one of the most original and fertile authors of early French literature. La Salle's one acknowledged work is the story of *Petit Jehan de Saintré*, a short romance exhibiting great command of character and abundance of delicate draughtsmanship. To this not only the authorship, part-authorship or editorship of the *Cent Nouvelles Nouvelles* has been added; but the still more famous and important work of *L'Avocat Patelin* has been assigned by respectable, though of course conjecturing, authority to the same paternity. The generosity of critics towards La Salle has not even stopped here. A fourth masterpiece of the period, *Les Quinze Joies de mariage*, has also been assigned to him. This last work, like the other three, is satirical in subject, and shows for the time a wonderful mastery of the language. Of the fifteen joys of marriage, or, in other words, the fifteen miseries of husbands, each has a chapter assigned to it, and each is treated with the peculiar mixture of gravity and ridicule which it requires. All who have read the book confess its infinite wit and the grace of its style. It is true that it has been reproached with cruelty and with a lack of the moral sentiment. But humanity and morality were not the strong point of the 15th century. There is, it must be admitted, about most of its productions a lack of poetry and a lack of imagination, produced, it may be, partly by political and other conditions outside literature, but very observable in it. The old forms of literature itself had lost their interest, and new ones possessing strength to last and power to develop themselves had not yet appeared. It was impossible, even if the taste for it had survived, to spin out the old themes any longer. But the new forces required some time to set to work, and to avail themselves of the tremendous weapon which the press had put into their hands. When these things had adjusted themselves, literature of a varied and vigorous kind became once more possible and indeed necessary, nor did it take long to make its appearance.

16th Century.—In no country was the literary result of the Renaissance more striking and more manifold than in France. The double effect of the study of antiquity and the religious movement produced an outburst of literary developments of the most diverse kinds, which even the fierce and sanguinary civil dissensions of the Reformation did not succeed in checking. While the Renaissance in Italy had mainly exhausted its effects by the middle of the 16th century, while in Germany those effects only paved the way for a national literature, and did not themselves greatly contribute thereto, while in England it was not

The Cent
Nouvelles
Nouvelles.

Antoine
de la
Salle.

Influence
de la
Renaissance.

till the extreme end of the period that a great literature was forthcoming—in France almost the whole century was marked by the production of capital works in every branch of literary effort. Not even the 17th century, and certainly not the 18th, can show such a group of prose writers and poets as is formed by Calvin, St Francis de Sales, Montaigne, du Vair, Bodin, d'Aubigné, the authors of the *Satire Ménippée*, Mouluc, Brantôme, Pasquier, Rabelais, des Periers, Herberay des Essarts, Amyot, Garnier, Marot, Ronsard and the rest of the "Pléiade," and finally Regnier. These great writers are not merely remarkable for the vigour and originality of their thoughts, the freshness, variety and grace of their fancy, the abundance of their learning and the solidity of their arguments in the cases where argument is required. Their great merit is the creation of a language and a style able to give expression to these good gifts. The foregoing account of the mediæval literature of France will have shown sufficiently that it is not lawful to despise the literary capacities and achievements of the older French. But the old language, with all its merits, was ill-suited to be a vehicle for any but the simpler forms of literary composition. Pleasant or affecting tales could be told in it with interest and pathos. Songs of charming *naïveté* and grace could be sung; the requirements of the epic and the chronicle were suitably furnished. But it was barren of the terms of art and science; it did not readily lend itself to sustained eloquence, to impassioned poetry or to logical discussion. It had been too long accustomed to leave these things to Latin as their natural and legitimate exponent, and it bore marks of its original character as a *lingua rustica*, a tongue suited for homely conversation, for folk-lore and for ballads, rather than for the business of the forum and the court, the speculations of the study, and the declamation of the theatre. Efforts had indeed been made, culminating in the heavy and tasteless erudition of the schools of Chartier and Crétin, to supply the defect; but it was reserved for the 16th century completely to efface it. The series of prose writers from Calvin to Montaigne, of poets from Marot to Regnier, elaborated a language yielding to no modern tongue in beauty, richness, flexibility and strength, a language which the reactionary purism of succeeding generations defaced rather than improved, and the merits of which have in still later days been triumphantly vindicated by the confession and the practice of all the greatest writers of modern France.

16th-Century Poetry.—The first few years of the 16th century were naturally occupied rather with the last developments of the mediæval forms than with the production of the new model. The clerks of the Bazoche and the Confraternity of the Passion still produced and acted mysteries, moralities and farces. The poets of the "Grands Rhétoriciens" school still wrote elaborate allegorical poetry. Chansons de geste, rhymed romances and fabliaux had long ceased to be written. But the press was multiplying the contents of the former in the prose form which they had finally assumed, and in the *Cent Nouvelles Nouvelles* there already existed admirable specimens of the short prose tale. There even were signs, as in some writers already mentioned and in Roger de Colléry, a lackpenny but light-hearted singer of the early part of the century, of definite enfranchisement in verse. But the first note of the new literature was sounded by Marot. Clément Marot (1496/7–1544). The son of an elder poet, Jehan des Mares called Marot (1463–1523), Clément at first wrote, like his father's contemporaries, allegorical and mythological poetry, afterwards collected in a volume with a charming title, *L'Adolescence clémentine*. It was not till he was nearly thirty years old that his work became really remarkable. From that time forward till his death, about twenty years afterwards, he was much involved in the troubles and persecutions of the Huguenot party to which he belonged; nor was the protection of Marguerite d'Angoulême, the chief patroness of Huguenots and men of letters, always efficient. But his troubles, so far from harming, helped his literary faculties; and his epistles, epigrams, *blasons* (descendants of the mediæval *dist*), and *coq-à-l'âne* became remarkable for their easy and polished style, their *light and graceful wit*, and a certain elegance which had not as yet been even attempted in any modern tongue, though the

Italian humanists had not been far from it in some of their Latin compositions. Around Marot arose a whole school of disciples and imitators, such as Victor Brodeau (1470?–1540), the great authority on rondeaux, Maurice Scève, a fertile author of blasons, Salel, Marguerite herself (1492–1549), of whom more hereafter, and Mellin de Saint Gelais (1491–1558). The last, son of the bishop named above, is a courtly writer of occasional pieces, who sustained as well as he could the *style marotique* against Ronsard, and who has the credit of introducing the regular sonnet into French. But the inventive vigour of the age was so great that one school had hardly become popular before another pushed it from its stool, and even of the Marotists just mentioned Scève and Salel are often regarded as chief and member respectively of a Lyonnese coterie, intermediate between the schools of Marot and of Ronsard, containing other members of repute such as Antoine Herodet and Charles Fontaine and claiming Louise Labé (*v. inf.*) herself. Pierre de Ronsard (1524–1585) was the chief of this latter. At first a courtier and a diplomatist, physical disqualification made him change his career. He began to study the classics under Jean Daurat (1508–1588), and with his master and five other writers, Étienne Jodelle (1532–1573), Rémy Belleau (1528–1577), Joachim du Bellay (1525–1560), Jean Antoine de Baif (1532–1580), and Pontus de Tyard (d. 1605, bishop of Châlons-sur-Saône), composed the famous "Pléiade." The object of this band was to bring the French language, in vocabulary, constructions and application, on a level with the classical tongues by borrowings from the latter. They would have imported the Greek licence of compound words, though the genius of the French language is but little adapted thereto; and they wished to reproduce in French the regular tragedy, the Pindaric and Horatian ode, the Virgilian epic, &c. But it is an error (though one which until recently was very common, and which perhaps requires pretty thorough study of their work completely to extirpate it) to suppose that they advocated or practised indiscriminate borrowing. On the contrary both in du Bellay's famous manifesto, the *Deffense et illustration de la langue française*, and in Ronsard's own work, caution and attention to the genius and the tradition of French are insisted upon. Being all men of the highest talent, and not a few of them men of great genius, they achieved much that they designed, and even where they failed exactly to achieve it, they very often indirectly produced results as important and more beneficial than those which they intended. Their ideal of a separate poetical language distinct from that intended for prose use was indeed a doubtful if not a dangerous one. But it is certain that Marot, while setting an example of elegance and grace not easily to be imitated, set also an example of trivial and, so to speak, pedestrian language which was only too imitable. If France was ever to possess a literature containing something besides fabliaux and farces, the tongue must be enriched and strengthened. This accession of wealth and vigour it received from Ronsard and the Ronsardists. Doubtless they went too far and provoked to some extent the reaction which Malherbe led. Their importations were sometimes unnecessary. It is almost impossible to read the *Franciade* of Ronsard, and not too easy to read the tragedies of Jodelle and Garnier, fine as the latter are in parts. But the best of Ronsard's sonnets and odes, the finest of du Bellay's *Antiquités de Rome* (translated into English by Spenser), the exquisite *Vanneur* of the same author, and the *Avril* of Belleau, even the finer passages of d'Aubigné and du Bartas, are not only admirable in themselves, and of a kind not previously found in French literature, but are also such things as could not have been previously found, for the simple reason that the medium of expression was wanting. They constructed that medium for themselves, and no force of the reaction which they provoked was able to undo their work. Adverse criticism and the natural course of time rejected much that they had added. The charming diminutives they loved so much went out of fashion; their compounds (sometimes it must be confessed, justly) had their letters of naturalization promptly cancelled; many a gorgeous adjective, including some which could trace

pedigree to the earliest ages of French literature, but bore an unfortunate likeness to the new-comers, was fabled. But for all that no language has ever had its destiny traced more powerfully and more beneficially by a small clique than the language of France was influenced by the *Maîtres* and disciples of that Ronsard whom for two centuries the fashion to deride and decry.

A sketch such as the present it is impossible to give a true account of individual writers, the more important of whom will be found treated under their own names.

The effort of the "Pliade" proper was continued and shared by a considerable number of minor poets, of whom, as has been already noted, belonging to different schools. Olivier de Magny (d. 1560) and Louise (b. 1526) were poets and lovers, the lady deserving far the rank in literature. There is more depth of passion in the *Œuvres* of "La Belle Cordière," as this Lyonnese poetess called, than in almost any of her contemporaries. Jacques Sadeau (1527-1555) scarcely deserves to be called a minor poet.

It is less than the usual hyperbole in the contemporary criticism of him to Catullus, and he reminds an Englishman of the school represented nearly a century later by Carew, Suckling, and others. The title of a part of his poem—*Œuvres amoureuses de l'admiration*—is characteristic both of the end of the time. Jean Doublet (c. 1528-c. 1580), Amadis (c. 1530-1585), and Jean de la Taille (1540-1608) deserve to be at least as poets, but two other writers require a longer notice. Guillaume de Salluste, seigneur du Bartas (1544-1590), whom Sylvester's translation, Milton's imitation, and the copious citations of Southey's *Doctor*, have known if not familiar in England, was partly a disciple and partly a rival of Ronsard. His poem of *Judith* was eclipsed by the better-known *La Divine Sepmaine* or epic of the Creation.

Bartas was a great user and abuser of the double compounds of *la* to above, but his style possesses much stateliness, and has a clear solemn eloquence which he shared with the other Calvinists, and which was derived from the study partly in Latin and partly of the Bible. Théodore Agrippa d'Aubigné (1552-1630), like du Bartas, was a Calvinist. His genius was of a more varied character. He wrote sonnets and odes as became a Ronsardist, but his chief poetical work was the satirical poem of *Les Tragiques*, in which the author is the factions, corruptions and persecutions of the time, in which there are to be found alexandrines of a strength, and original cadence hardly to be discovered elsewhere, in Corneille and Victor Hugo. Towards the end of the 16th century, Philippe Desportes (1546-1606) and Jean Bertaut (1611), with much enfeebled strength, but with a certain continuity of the Ronsardizing tradition. Among their contemporaries must be noticed Jean Passerat (1534-1602), a writer of wit and vigour and rather resembling Marot than Ronsard, and Vauquelin de la Fresnaye (1536-1607), the author of the *Œuvres poétiques* and of the first French satires which bear that title. Jean le Houx (fl. c. 1600) continued, and invented the *vaux de vire*, commonly known as the *Œuvres* of Olivier Basselin, and already alluded to, while a still more and more eccentric verse style was cultivated by Étienne Jodelle (1549-1590), whose epigrams and other were collected under odd titles, *Les Bigarrures*, *Les Touches*. A curious pair are Guy du Faur de Pibrac (1529-1584) and Mathieu (b. 1563), authors of moral quatrains, which were by heart in the schools of the time, replacing the distichs of the grammarians, which, translated into French, had the same purpose in the middle ages.

At the end, and at the same time perhaps the climax, of the 16th century poetry of the century. A descendant at once of the older Gallic spirit of Villon and Marot, in virtue of his innate acuteness, terseness and wit, of the school of Ronsard, and of his erudition, his command of language, and his scholarship, he is perhaps the best representative of French poetry at the close of the 16th century when it had got together all its materials, had

lost none of its native vigour and force, and had not yet submitted to the cramping and numbing rules and restrictions which the next century introduced. The satirical poems of Regnier, and especially the admirable epistle to Rapin, in which he denounces and rebuts the critical dogmas of Malherbe, are models of nervous strength, while some of the elegies and odes contain expression not easily to be surpassed of the softer feelings of affection and regret. No poet has had more influence on the revival of French poetry in the last century than Regnier, and he had imitators in his own time, the chief of whom was Courval-Sonnet (Thomas Sonnet, sieur de Courval) (1577-1635), author of satires of some value for the history of manners.

16th-Century Drama.—The change which dramatic poetry underwent during the 16th century was at least as remarkable as that undergone by poetry proper. The first half of the period saw the end of the religious mysteries, the licence of which had irritated both the parliament and the clergy. Louis XII., at the beginning of the century, was far from discouraging the disorderly but popular and powerful theatre in which the Confraternity of the Passion, the clerks of the Bazouche, and the *Enfants sans souci* enacted mysteries, moralities, *soies* and farces. He made them, indeed, an instrument in his quarrel with the papacy, just as Philippe le Bel had made use of the allegorical poems of Jehan de Meung and his fellows. Under his patronage were produced the chief works of Gringore or Gringoire (c. 1480-1547), by far the most remarkable writer of this class of composition. His *Prince des soies* and his *Mystère de St Louis* are among the best of their kind. An enormous volume of composition of this class was produced between 1500 and 1550. One morality by itself, *L'Homme juste et l'Homme mondain*, contains some 36,000 lines. But in 1548, when the Confraternity was formally established at the Hôtel de Bourgogne, leave to play sacred subjects was expressly refused it. Moralities and *soies* dragged on under difficulties till the end of the century, and the farce, which is immortal, continually affected comedy. But the effect of the Renaissance was to sweep away all other vestiges of the medieval drama, at least in the capital. An entirely new class of subjects, entirely new modes of treatment, and a different kind of performers were introduced. The change naturally came from Italy. In the close relationship with that country which France had during the early years of the century, Italian translations of the classical masterpieces were easily imported. Soon French translations were made afresh of the *Electra*, the *Hecuba*, the *Iphigenia in Aulis*, and the French humanists hastened to compose original tragedies on the classical model, especially as exhibited in the Latin tragedian Seneca. It was impossible that the "Pliade" should not eagerly seize such an opportunity of carrying out its principles, and one of its members, Jodelle (1538-1573), devoting himself mainly to dramatic composition, fashioned at once the first tragedy, *Œdipe à Colonne*, and the first comedy, *Eugène*, thus setting the example of the style of composition which for two centuries and a half Frenchmen were to regard as the highest effort of literary ambition. The amateur performance of these dramas by Jodelle and his friends was followed by a Bacchic procession after the manner of the ancients, which caused a great deal of scandal, and was represented by both Catholics and Protestants as a pagan orgy. The *Cleopâtre* is remarkable as being the first French tragedy, nor is it destitute of merit. It is curious that in this first instance the curt antithetic *συναυλία*, which was so long characteristic of French plays and plays imitated from them, and which Butler ridicules in his *Dialogue of Cat and Puss*, already appears. There appears also the grandiose and smooth but stilted declamation which came rather from the imitation of Seneca than of Sophocles, and the tradition of which was never to be lost. *Cleopâtre* was followed by *Didon*, which, unlike its predecessor, is entirely in alexandrines, and observes the regular alternation of masculine and feminine rhymes. Jodelle was followed by Jacques Grévin (1540?-1570) with a *Mort de César*, which shows an improvement in tragic art, and two still better comedies, *Les Ébénistes* and *La Torsion* by Jean de la Taille (1540-1608), who made still further progress

towards the accepted French dramatic pattern in his *Sauvage furieux* and his *Corrivaux*, Jacques, his brother (1541-1562), and Jean de la Péruse (1529-1554), who wrote a *Médée*. A very different poet from all these is Robert Garnier (1545-1601).

Garnier is the first tragedian who deserves a place not too far below Rotrou, Corneille, Racine, Voltaire and Hugo, and who may be placed in the same class with them. He chose his subjects indifferently from classical, sacred and medieval literature. *Sédécie*, a play dealing with the capture of Jerusalem by Nebuchadnezzar, is held to be his masterpiece, and *Bradamante* deserves notice because it is the first tragi-comedy of merit in French, and because the famous confidant here makes his first appearance. Garnier's successor, Antoine de Montchrestien or Montchrestien (c. 1576-1621), set the example of dramatizing contemporary subjects. His masterpiece is *L'Écossaise*, the first of many dramas on the fate of Mary, queen of Scots. While tragedy thus clings closely to antique models, comedy, as might be expected in the country of the fabliaux, is more independent. Italy had already a comic school of some originality, and the French farce was too vigorous and lively a production to permit of its being entirely overlooked. The first comic writer of great merit was Pierre Larivey (c. 1550-c. 1612), an Italian

Larivey, by descent. Most if not all of his plays are founded on Italian originals, but the translations or adaptations are made with the greatest freedom, and almost deserve the title of original works. The style is admirable, and the skillful management of the action contrasts strongly with the languor, the awkward adjustment, and the lack of dramatic interest found in contemporary tragedians. Even Molière found something to use in Larivey.

16th-Century Prose Fiction.—Great as is the importance of the 16th century in the history of French poetry, its importance in the history of French prose is greater still. In poetry the middle ages could fairly hold their own with any of the ages that have succeeded them. The epics of chivalry, whether of the cycles of Charlemagne, Arthur, or the classic heroes, not to mention the miscellaneous romans d'aventures, have indeed more than held their own. Both relatively and absolutely the *Henriade* of the 16th century, the *Pucelle* of the 17th, the *Franciade* of the 18th, cut a very poor figure beside *Roland* and *Percivale*, *Gerard de Roussillon*, and *Parthenopées de Blois*. The romances, ballads and pastourelles, signed and unsigned, of medieval France were not merely the origin, but in some respects the superiors, of the lyric poetry which succeeded them. Thibaut de Champagne, Charles d'Orléans and Villon need not veil their crests in any society of bards. The charming forms of the rondel, the rondeau and the ballade have won admiration from every competent poet and critic who has known them. The fabliaux give something more than promise of La Fontaine, and the two great compositions of the *Roman du Renart* and the *Roman de la rose*, despite their faults and their alloy, will always command the admiration of all persons of taste and judgment who take the trouble to study them. But while poetry had in the middle ages no reason to blush for her French representatives, prose (always the younger and less forward sister) had far less to boast of. With the exception of chronicles and prose romances, no prose works of any real importance can be quoted before the end of the 15th century, and even then the chief if not the only place of importance must be assigned to the *Cent Nouvelles Nouvelles*, a work of admirable prose, but necessarily light in character, and not yet demonstrating the efficacy of the French language as a medium of expression for serious and weighty thought. Up to the time of the Renaissance and the consequent reformation, Latin had, as we have already remarked, been considered the sufficient and natural organ for this expression. In France as in other countries the disturbance in religious thought may undoubtedly claim the glory of having repaired this disgrace of the vulgar tongue, and of having fitted and taught it to express whatever thoughts the theologian, the historian, the philosopher, the politician and the savant had occasion to utter. But the use of prose as a vehicle for lighter themes was more continuous with the literature that preceded,

and serves as a natural transition from poetry and the drama to history and science. Among the prose writers, therefore, of the 16th century we shall give the first place to the novelists and romantic writers.

Among these there can be no doubt of the precedence, in every sense of the word, of François Rabelais (c. 1490-1553), the one French writer (or with Molière one of the two *Rabelais*, whom critics the least inclined to appreciate the characteristics of French literature have agreed to place among the few greatest of the world. With an immense erudition representing almost the whole of the knowledge of his time, with an untiring faculty of invention, with the judgment of a philosopher, and the common sense of a man of the world, with an observation that let no characteristic of the time pass unobserved, and with a tenfold portion of the special Gallic gift of good-humoured satire, Rabelais united a height of speculation and depth of insight and a vein of poetical imagination rarely found in any writer, but altogether portentous when taken in conjunction with his other characteristics. His great work has been taken for an exercise of transcendental philosophy, for a concealed theological polemic, for an allegorical history of this and that personage of his time, for a merely literary utterance, for an attempt to tickle the popular ear and taste. It is all of these, and it is none—all of them in parts, none of them in deliberate and exclusive intention. It may perhaps be called the exposition and commentary of all the thoughts, feelings, aspirations and knowledge of a particular time and nation put forth in attractive literary form by a man who for once combined the practical and the literary spirit, the power of knowledge and the power of expression. The work of Rabelais is the mirror of the 16th century in France, reflecting at once its comeliness and its uncomeliness, its high aspirations, its voluptuous tastes, its political and religious dissensions, its keen criticism, its eager appetite and hasty digestion of learning, its gleams of poetry, and its ferocity of manners. In Rabelais we can divine the "Pléiade" and Marot, the *Cymbalum mundi* and Montaigne, Amyot and the *Amadis*, even Calvin and Duperron.

It was inevitable that such extraordinary works as *Gargantua* and *Pantagruel* should attract special imitators in the direction of their outward form. It was also inevitable that this imitation should frequently fix upon these Rabelaisian characteristics which are least deserving of imitation, and most likely to be depraved in the hands of imitators. It fell within the plan of the master to indulge in what has been called *fatrasie*, the huddling together, that is to say, of a medley of language and images which is best known to English readers in the not always successful following of Sterne. It pleased him also to disguise his naturally terse, strong and nervous style in a burlesque envelope of redundant language, partly ironical, partly the result of superfluous erudition, and partly that of a certain childish wantonness and exuberance, which is one of his raciest and pleasantest characteristics. In both these points he was somewhat corruptly followed. But fortunately the romances of the 16th century had not Rabelais for their sole model, but were also influenced by the simple and straightforward style of the *Cent Nouvelles Nouvelles*. The joint influence gives us some admirable work. Nicholas of Troyes, a saddler of Champagne, came too early (his *Grand Parangon des nouvelles nouvelles* appeared in 1536) to copy Rabelais. But Noël du Fail (d. c. 1585?), a judge at Rennes, shows the double influence in his *Propos rustiques* and *Contes d'Eutrapel*, both of which, especially the former, are lively and well-written pictures of contemporary life and thought, as the country magistrate actually saw and dealt with them. In 1558, however, appeared two works of far higher literary and social interest. These are the *Heptameron* of the queen of Navarre, and the *Contes et joyeux devis* of Bonaventure des Periers (c. 1500-1544).

Des Periers, who was a courtier of Marguerite's, has sometimes been thought to have had a good deal to do with the first-named work as well as with the second, and was also the author of a curious Lucianic satire, strongly sceptical in cast, the *Cymbalum mundi*. Indeed, not merely

een's prose works, but also the poems gracefully entitled *arguerites de la Marguerite*, are often attributed to the y men whom the sister of Francis I. gathered round. However this may be, some single influence of power a to give unity and distinctness of savour evidently presided over the composition of the *Heptaméron*. Composed as it is on the model of Boccaccio, its tone and character are entirely different, and few works more individual charm. The *Tales of des Periers* are simpler and more homely; there is more wit in them refinement. But both works breathe, more powerfully than any others, the peculiar mixture of cultivated oetical voluptuousness with a certain religiosity and a us spirit of action which characterizes the French Renais-

Later in time, but too closely connected with Rabelais and spirit to be here omitted, came the *Moyen de parvenir* salde de Verville (1558-1612?), a singular *farasie*, uniting idiom, learning and indecency, and crammed with anecd which are always amusing though rarely decorous. he same time a fresh vogue was given to the chivalric ce by Herberay's translation of *Amadis de Gaula*. French writers have supposed a French original for the of *Amadis* in some lost roman d'aventures. It is of course impossible to say that this is not the case, but there one tittle of evidence to show that it is. At any rate ventures of Amadis were prolonged in Spanish through tion after generation of his descendants. This vast work ay des Essarts in 1540 undertook to translate or rete, but it was not without the assistance of several followers re task was completed. Southey has charged Herberay corrupting the simplicity of the original, a charge which t concern us here. It is sufficient to say that the French s is an excellent piece of literary work, and that Herberay s no mean place among the fathers of French prose. ok had an immense popularity; it was translated into oreign languages, and for some time it served as a favourite g book for foreigners studying French. Nor is it to be d that the romancers of the Scudéry and Calprenède e next century were much more influenced both for od harm by these Amadis romances than by any of the tales of chivalry.

Century Historians.—As in the case of the tale-tellers, at of the historians, the writers of the 16th century had ns to continue. It is doubtful indeed whether many of an risk comparison as artists with the great names of rdouin and Joinville, Froissart and Comines. The 16th e, however, set the example of dividing the functions chronicler, setting those of the historian proper on one nd of the anecdote-monger and biographer on the other. orts at regular history made in this century were not of best value. But on the other hand the practice of memoir- ; in which the French were to excel every nation in the and of literary correspondence, in which they were to ven their memoirs, was solidly founded.

of the earliest historical writers of the century was Claude ssel (1450-1520), whose history of Louis XII. aims not essfully at style. De Thou (1553-1617) wrote in Latin, rnard de Girard, sieur du Maillan (1537-1610), composed oire de France on Thucydidean principles as transmitted h the successive mediums of Polybius, Guicciardini and .Aemilius. The instance invariably quoted, after Thierry, Haillan's method is his introduction, with appropriate es, of two Merovingian statesmen who argue out the e merits of monarchy and oligarchy on the occasion of ction of Pharamond. Besides du Haillan, la Popelinère 10-1608), who less ambitiously attempted a history of e during his own time, and expended immense labour collection of information and materials, deserves mention. re is no such poverty of writers of memoirs. Robert Mark, du Bellay, Marguerite de Valois (the youngest or Marguerite, first wife of Henri IV., 1553-1615), Villars, nes, La Tour d'Auvergne, and many others composed

commentaries and autobiographies. The well-known and very agreeable *Histoire du gentil seigneur de Bayart* (1524) is by an anonymous "Loyal Serviteur." Vincent Carloix (fl. 1550), the secretary of the marshal de Vielleville, composed some memoirs abounding in detail and incident. The *Lettres* of Cardinal d'Ossat (1536-1604) and the *Négociations* of Pierre Jeannin (1540-1622) have always had a high place among documents of their kind. But there are four collections of memoirs concerning this time which far exceed all others in interest and importance. The turbulent dispositions of the time, the loose dependence of the nobles and even the smaller gentry on any single or central authority, the rapid changes of political situations, and the singularly active appetite, both for pleasure and for business, for learning and for war, which distinguished the French gentleman of the 16th century, place the memoirs of François de Lanoue (1531-1591), Blaise de Montluc (1503-1577), Agrippa d'Aubigné and Pierre de Bourdeille[s] Brantôme (1540-1614) almost at the head of the literature of their class. The name of Brantôme is known to all who have the least tincture of French literature, and the works of the others are not inferior in interest, and perhaps superior in spirit and conception, to the *Dames Galantes*, the *Grands Capitaines* and the *Hommes illustres*. The commentaries of Montluc, which Henri Quatre is said to have called the soldier's Bible, are exclusively military and deal with affairs only. Montluc was governor in Guienne, where he repressed the savage Huguenots of the south with a savagery worse than their own. He was, however, a partisan of order, not of Catholicism. He hung and shot both parties with perfect impartiality, and refused to have anything to do with the massacre of St Bartholomew. Though he was a man of no learning, his style is excellent, being vivid, flexible and straightforward. Lanoue, who was a moderate in politics, has left his principles reflected in his memoirs. D'Aubigné, so often to be mentioned, gives the extreme Huguenot side as opposed to the royalist partisanship of Montluc and the *via media* of Lanoue. Brantôme, on the other hand, is quite free *Brantôme*, from any political or religious prepossessions, and, indeed, troubles himself very little about any such matters. He is the shrewd and somewhat cynical observer, moving through the crowd and taking note of its ways, its outward appearance, its heroisms and its follies. It is really difficult to say whether the recital of a noble deed of arms or the telling of a scandalous story about a court lady gave him the most pleasure, and impossible to say which he did best. Certainly he had ample material for both exercises in the history of his time.

The branches of literature of which we have just given an account may be fairly connected, from the historical point of view, with work of the same kind that went before as well as with work of the same kind that followed them. It was not so with the literature of theology, law, politics and erudition, which the 16th century also produced, and with which it for the first time enlarged the range of composition in the vulgar tongue. Not only had Latin been invariably adopted as the language of composition on such subjects, but the style of the treatises dealing with such matters had been traditional rather than original. In speculative philosophy or metaphysics proper even this century did not witness a great development; perhaps, indeed, such a development was not to be expected until the minds of men had in some degree settled down from their agitation on more practical matters. It is not without significance that Calvin (1509-1564) is the great figure in serious French prose in the first half of the century, Montaigne the corresponding figure in the second half. After Calvin and Montaigne we expect Descartes.

16th-Century Theologians.—In France, as in all other countries, the Reformation was an essentially popular movement, though from special causes, such as the absence of political homogeneity, the nobles took a more active part both with pen and sword in it than was the case in England. But the great textbook of the French Reformation was not the work of any noble. Jean Calvin's *Institution of the Christian Religion*

is a book equally remarkable in matter and in form, in circumstances and in result. It is the first really great composition in argumentative French prose. Its severe logic and careful arrangement had as much influence on the manner of future thought, both in France and the other regions whither its widespread popularity carried it, as its style had on the expression of such thought. It was the work of a man of only seven-and-twenty, and it is impossible to exaggerate the originality of its manner when we remember that hardly any models of French prose then existed except tales and chronicles, which required and exhibited totally different qualities of style. It is indeed probable that had not the *Institution* been first written by its author in Latin, and afterwards translated by him, it might have had less dignity and vigour; but it must at the same time be remembered that this process of composition was at least equally likely, in the hands of any but a great genius, to produce a heavy and pedantic style neither French nor Latin in character. Something like this result was actually produced in some of Calvin's minor works, and still more in the works of many of his followers, whose lumbering language gained for itself, in allusion to their exile from France, the title of "style refugic." Nevertheless, the use of the vulgar tongue on the Protestant side, and the possession of a work of such importance written therein, gave the Reformers an immense advantage which their adversaries were some time in neutralizing. Even before the *Institution*, Lefèvre d'Étaples (1455-1537) and Guillaume Farel (1480-1565) saw and utilized the importance of the vernacular. Calvin (1509-1564) was much helped by Pierre Viret (1511-1571), who wrote a large number of small theological and moral dialogues, and of satirical pamphlets, destined to captivate as well as to instruct the lower people. The more famous Beza (Théodore de Bèze) (1519-1605) wrote chiefly in Latin, but he composed in French an ecclesiastical history of the Reformed churches and some translations of the Psalms. Marnix de Sainte Aldegonde (1530-1593), a gentleman of Brabant, followed Viret as a satirical pamphleteer on the Protestant side. On the other hand, the Catholic champions at first affected to disdain the use of the vulgar tongue, and their pamphleteers, when they did attempt it, were unequal to the task. Towards the end of the century a more decent war was waged with Philippe du Plessis Mornay (1549-1623) on the Protestant side, whose work is at least as much directed against freethinkers and enemies of Christianity in general as against the dogmas and discipline of Rome. His adversary, the redoubtable Cardinal du Perron (1556-1618), who, originally a Calvinist, went over to the other side, employed French most vigorously in controversial works, chiefly with reference to the eucharist. Du Perron was celebrated as the first controversialist of the time, and obtained dialectical victories over all comers. At the same time the bishop of Geneva, St Francis de Sales (1567-1622), supported the Catholic side, partly by controversial works, but still more by his devotional writings. The *Introduction to a Devout Life*, which, though actually published early in the next century, had been written some time previously, shares with Calvin's *Institution* the position of the most important theological work of the period, and is in remarkable contrast with it in style and sentiment as well as in principles and plan. It has indeed been accused of a certain effeminacy, the appearance of which is in all probability mainly due to this very contrast. The 16th century does not, like the 17th, distinguish itself by literary exercises in the pulpit. The furious preachers of the League, and their equally violent opponents, have no literary value.

16th-Century Moralists and Political Writers.—The religious dissensions and political disturbances of the time could not fail to exert an influence on ethical and philosophical thought. Yet, as we have said, the century was not prolific of pure philosophical speculation. The scholastic tradition, though long sterile, still survived, and with it the habit of composing in Latin all works in any way connected with philosophy. The *Logic* of Ramus in 1555 is cited as the first departure from this rule. Other philosophical works are few, and chiefly express the doubt and the freethinking which

were characteristic of the time. This doubt assumes the form of positive religious scepticism only in the *Cymbalum mundi* of Bonaventure des Periers, a remarkable series of dialogues which excited a great storm, and ultimately drove the author to commit suicide. The *Cymbalum mundi* is a curious anticipation of the 18th century. The literature of doubt, however, was to receive its principal accession in the famous essays of Michel Eygquem, seigneur de Montaigne (1533-1592). It would be a mistake to imagine the existence of any sceptical propaganda in this charming and popular book. Its principle is not scepticism but egotism; and as the author was profoundly sceptical, this quality necessarily rather than intentionally appears. We have here to deal only very superficially with this as with other famous books, but it cannot be doubted that it expresses the mental attitude of the latter part of the century as completely as Rabelais expresses the mental attitude of the early part. There is considerably less vigour and life in this attitude. Inquiry and protest have given way to a placid conviction that there is not much to be found out, and that it does not much matter; the erudition though abundant is less indiscriminate, and is taken in and given out with less gusto; exuberant drollery has given way to quiet irony; and though neither business nor pleasure is decried, both are regarded rather as useful pastimes incident to the life of man than with the eager appetite of the Renaissance. From the purely literary point of view, the style is remarkable from its absence of pedantry in construction, and yet for its rich vocabulary and picturesque brilliancy. The follower and imitator of Montaigne, Pierre Charron (1541-1603), carried his master's scepticism to a somewhat more positive degree. His principal book, *De la sagesse*, scarcely deserves the comparative praise which *De la sagesse* has given it. On the other hand Guillaume du Vair (1556-1621), a lawyer and orator, takes the positive rather than the negative side in morality, and regards the vicissitudes in human affairs from the religious and theological point of view in a series of works characterized by the special merit of the style of great orators.

The revolutionary and innovating instinct which showed itself in the 16th century with reference to church government and doctrine spread naturally enough to political matters. The intolerable disorder of the religious wars naturally set the thinkers of the age speculating on the doctrines of government in general. The favourite and general study of antiquity helped this tendency, and the great accession of royal power in all the monarchies of Europe invited a speculative if not a practical reaction. The persecutions of the Protestants naturally provoked a republican spirit among them, and the violent antipathy of the League to the houses of Valois and Bourbon made its partisans adopt almost openly the principles of democracy and tyrannicide.

The greatest political writer of the age is Jean Bodin (1530-1596), whose *République* is founded partly on speculative considerations like the political theories of the ancients, and partly on an extended historical inquiry. Bodin, like most lawyers who have taken the royalist side, is for unlimited monarchy, but notwithstanding this, he condemns religious persecution and discourages slavery. In his speculations on the connexion between forms of government and natural causes, he serves as a link between Aristotle and Montesquieu. On the other hand, the causes which we have mentioned made a large number of writers adopt opposite conclusions. Étienne de la Boétie (1530-1563), the friend of Montaigne's youth, composed the *Contre un* or *Discours de la servitude volontaire*, a protest against the monarchical theory. The boldness of the protest and the affectionate admiration of Montaigne have given la Boétie a much higher reputation than any extant work of his actually deserves. The *Contre un* is a kind of prize essay, full of empty declamation borrowed from the ancients, and showing no grasp of the practical conditions of politics. Not much more historically based, but far more vigorous and original, is the *Franco-Gallia* of François Hotmann (1524-1590), a work which appeared both in Latin and French, which extols the authority of the states-general, represents them as direct successors of the political institutions of Gauls and Franks, and maintains the

right of insurrection. In the last quarter of the century political animosity knew no bounds. The Protestants beheld a divine instrument in Poltrot de Méré, the Catholics in Jacques Clément. The Latin treatises of Hubert Languet (1518-1581) and Buchanan formally vindicated—the first, like Hotmann, the right of rebellion based on an original contract between prince and people, the second the right of tyrannicide. Indeed, as Montaigne confesses, divine authorization for political violence was claimed and denied by both parties according as the possession or the expectancy of power belonged to each, and the excesses of the preachers and pamphleteers knew no bounds.

Every one, however, was not carried away. The literary merits of the chancellor Michel de l'Hôpital (1507-1573) are not very great, but his efforts to promote peace and moderation were unceasing. On the other side Lanoue, with far greater literary gifts, pursued the same ends, and pointed out the ruinous consequences of continued dissension. Du Plessis Mornay took a part in political discussion even more important than that which he bore in religious polemics, and was of the utmost service to Henri Quatre in defending his cause against the League, as was also Hurault, another author of state papers. Du Vair, already mentioned, powerfully assisted the same cause by his successful defence of the Salic law, the disregard of which by the Leaguer states-general was intended to lead to the admission of the Spanish claim to the crown. But the foremost work against

the League was the famous *Satire Ménippée* (1594), in a literary point of view one of the most remarkable of political books. The *Ménippée* was the work of no single author, but was due, it is said, to the collaboration of five, Pierre Leroy, who has the credit of the idea, Jacques Gillot, Florent Chretien, Nicolas Rapin (1541-1596) and Pierre Pithou (1539-1596), with some assistance in verse from Passerat and Gilles Durand. The book is a kind of burlesque report of the meeting of the states-general, called for the purpose of supporting the views of the League in 1593. It gives an account of the procession of opening, and then we have the supposed speeches of the principal characters—the duc de Mayenne, the papal legate, the rector of the university (a ferocious Leaguer) and others. But by far the most remarkable is that attributed to Claude d'Aubray, the leader of the *Tiers Etat*, and said to be written by Pithou, in which all the evils of the time and the malpractices of the leaders of the League are exposed and branded. The satire is extraordinarily bitter and yet perfectly good-humoured. It resembles in character rather than that of Butler, who unquestionably imitated it, than any other. The style is perfectly suited to the purpose, having got rid of almost all vestiges of the cumbrousness of the older tongue without losing its picturesque quaintness. It is no wonder that, as we are told by contemporaries, it did more for Henri Quatre than all other writings in his cause. In connexion with politics some mention of legal orators and writers may be necessary. In 1539 the ordinance of Villers-Cotterets enjoined the exclusive use of the French language in legal procedure. The bar and bench of France during the century produced, however, besides those names already mentioned in other connexions, only one deserving of special notice, that of Etienne Pasquier (1529-1615), author of a celebrated speech against the right of the Jesuits to take part in public teaching. This he inserted in his great work, *Recherches de la France*, a work dealing with almost every aspect of French history whether political, antiquarian or literary.

16th-Century Savants.—One more division, and only one, that of scientific and learned writers pure and simple, remains. Much of the work of this kind during the period was naturally done in Latin, the vulgar tongue of the learned. But in France, as in other countries, the study of the classics led to a vast number of translations, and it so happened that one of the translators deserves as a prose writer a rank among the highest. Many of the authors already mentioned contributed to the literature of translation. Des Periers translated the Platonic dialogue *Lysis*, la Boétie some works of Xenophon and Plutarch, du Vair the *De corona*, the *In Ctesiphontem* and the *Pro Milone*.

Salel attempted the *Iliad*, Belleau the false *Anacreon*, Balif some plays of Plautus and Terence. Besides these Lefèvre d'Étaples gave a version of the Bible, Saliat one of Herodotus, and Louis Leroy (1510-1577), not to be confounded with the part author of the *Ménippée*, many works of Plato, Aristotle and other Greek writers. But while most if not all of these translators owed the merits of their work to their originals, and deserved, much more deserve, to be read only by those to whom those originals are sealed, Jacques Amyot (1513-1593), bishop of Auxerre, takes rank as a French classic by his translations

of Plutarch, Longus and Heliodorus. The admiration which Amyot excited in his own time was immense. Montaigne declares that it was thanks to him that his contemporaries knew how to speak and to write, and the Academy in the next age, though not too much inclined to honour its predecessors, ranked him as a model. His Plutarch, which had an enormous influence at the time, and coloured perhaps more than any classic the thoughts and writings of the 16th century, both in French and English, was then considered his masterpiece. Nowadays perhaps, and from the purely literary standpoint, that position would be assigned to his exquisite version of the exquisite story of Daphnis and Chloë. It is needless to say that absolute fidelity and exact scholarship are not the pre-eminent merits of these versions. They are not philological exercises, but works of art.

On the other hand, Claude Fauchet (1530-1601) in two antiquarian works, *Antiquités gauloises et françoises* and *L'Origine de la langue et de la poésie françoise*, displays a remarkable critical faculty in sweeping away the fables which had encumbered history. Fauchet had the (for his time) wonderful habit of consulting manuscripts, and we owe to him literary notices of many of the trouvères. At the same time François Grudé, sieur de la Croix du Maine (1552-1592), and Antoine Duverdier (1544-1600) founded the study of bibliography in France. Pasquier's *Recherches*, already alluded to, carries out the principles of Fauchet independently, and besides treating the history of the past in a true critical spirit, supplies us with voluminous and invaluable information on contemporary politics and literature. He has, moreover, the merit which Fauchet had not, of being an excellent writer. Henri Estienne [Stephanus] (1528-1598) also deserves notice in this place, both for certain treatises on the French language, full of critical crotchets, and also for his curious *Apologie pour Hérodote*, a remarkable book not particularly easy to class. It consists partly of a defence of its nominal subject, partly of satirical polemics on the Protestant side, and is filled almost equally with erudition and with the buffoonery and *fatrasie* of the time. The book, indeed, was much too Rabelaisian to suit the tastes of those in whose defence it was composed.

The 16th century is somewhat too early for us to speak of science, and such science as was then composed falls for the most part outside French literature. The famous potter, Bernard Palissy (1510-1590), however, was not much less skilful as a fashioner of words than as a fashioner of pots, and his description of the difficulties of his experiments in enamelling, which lasted sixteen years, is well known. The great surgeon Ambrose Paré (c. 1510-1590) was also a writer, and his descriptions of his military experiences at Turin, Metz and elsewhere have all the charm of the 16th-century memoir. The only other writers who require special mention are Olivier de Serres (1539-1619), who composed, under the title of *Théâtre d'agriculture*, a complete treatise on the various operations of rural economy, and Jacques du Fouilloux (1521-1580), who wrote on hunting (*La Vénerie*). Both became extremely popular and were frequently reprinted.

17th-Century Poetry.—It is not always easy or possible to make the end or the beginning of a literary epoch synchronize exactly with historical dates. It happens, however, that for Malherbe, once the beginning of the 17th century coincides almost exactly with an entire revolution in French literature. The change of direction and of critical standard given by François de Malherbe (1556-1628) to poetry was to last for two whole

centuries, and to determine, not merely the language and complexion, but also the form of French verse during the whole of that time. Accidentally, or as a matter of logical consequence (it would not be proper here to attempt to decide the question), poetry became almost synonymous with drama. It is true, as we shall have to point out, that there were, in the early part of the 17th century at least, poets, properly so called, of no contemptible merit. But their merit, in itself respectable, sank in comparison with the far greater merit of their dramatic rivals. Théophile de Viau and Racan, Voiture and Saint-Amant cannot for a moment be mentioned in the same rank with Corneille. It is certainly curious, if it is not something more than curious, that this decline in poetry proper should have coincided with the so-called reforms of Malherbe. The tradition of respect for this elder and more gifted Boileau was at one time all-powerful in France, and, notwithstanding the Romantic movement, is still strong. In rejecting a large number of the importations of the Ronsardists, he certainly did good service. But it is difficult to avoid ascribing in great measure to his influence the origin of the chief faults of modern French poetry, and modern French in general, as compared with the older language. He pronounced against "poetic diction" as such, forbade the overlapping (*enjambement*) of verse, insisted that the middle pause should be of sense as well as sound, and that rhyme must satisfy eye as well as ear. Like Pope, he sacrificed everything to "correctness," and, unluckily for French, the sacrifice was made at a time when no writer of an absolutely supreme order had yet appeared in the language. With Shakespeare and Milton, not to mention scores of writers only inferior to them, safely garnered, Pope and his followers could do us little harm. Corneille and Molière unfortunately came after Malherbe. Yet it would be unfair to this writer, however badly we may think of his influence, to deny him talent, and even a certain amount of poetical inspiration. He had not felt his own influence, and the very influences which he despised and proscribed produced in him much tolerable and some admirable verse, though he is not to be named as a poet with Regnier, who had the courage, the sense and the good taste to oppose and ridicule his innovations. Of Malherbe's school, Honorat de Bueil, marquis de Racan (1589-1679), and François de Maynard (1582-1646) were the most remarkable. The former was a true poet, though not a very strong one. Like his master, he is best when he follows the models whom that master contemned. Perhaps more than any other poet, he set the example of the classical alexandrine, the smooth and melodious but monotonous and rather effeminate measure which Racine was to bring to the highest perfection, and which his successors, while they could not improve its smoothness, were to make more and more monotonous until the genius of Victor Hugo once more broke up its facile polish, supplied its stiff uniformity, and introduced vigour, variety, colour and distinctness in the place of its feeble sameness and its pale indecision. But the vigour, not to say the licence, of the 16th century could not thus die all at once. In Théophile de Viau (1591-1626) the early years of the 17th century had their Villon. The later poet was almost as unfortunate as the earlier, and almost as disreputable, but he had a great share of poetical and not a small one of critical power. The *étoile enragée* under which he complains that he was born was at least kind to him in this respect; and his readers, after he had been forgotten for two centuries, have once more done him justice. Racan and Théophile were followed in the second quarter of the century by two schools which sufficiently well represented the tendencies of each. The first was that of Vincent Voiture (1598-1648), Isaac de Benserade (1612-1691), and other poets such as Claude de Maleville (1597-1647), author of *La Belle Matineuse*, who were connected more or less with the famous literary coterie of the Hôtel de Rambouillet. Théophile was less worthily succeeded by a class, it can hardly be called a school of poets, some of whom, like Gérard Saint-Amant (1594-1660), wrote drinking songs of merit and other light pieces; others, like Paul Scarron (1610-1660) and Sarrasin (1603? 4? 5?-1654), devoted themselves rather to burlesque of serious verse. Most of the great dramatic authors of the time also wrote miscellaneous poetry, and there

was even an epic school of the most singular kind, in ridiculing and discrediting which Boileau for once did undoubtedly good service. The *Pucelle* of Jean Chapelain (1595-1674), the unfortunate author who was deliberately trained and educated for a poet, who enjoyed for some time a sort of dictatorship in French literature on the strength of his forthcoming work, and at whom from the day of its publication every critic of French literature has agreed to laugh, was the most famous and perhaps the worst of these. But Georges de Scudéry (1601-1667) wrote an *Alaric*, the Père le Moine (1602-1671) a *Saint Louis*, Jean Desmarets de Saint-Sorlin (1595-1676), a dramatist and critic of some note, a *Clovis*, and Saint-Amant a *Mossé*, which were not much better, though Théophile Gautier in his *Grotesques* has valiantly defended these and other contemporary versifiers. And indeed it cannot be denied that even the epics, especially *Saint Louis*, contain flashes of finer poetry than France was to produce for more than a century outside of the drama. Some of the lighter poets and classes of poetry just alluded to also produced some remarkable verse. The *Précieuses* of the Hôtel Rambouillet, with all their absurdities, encouraged if they did not produce good literary work. In their society there is no doubt that a great reformation of manners took place, if not of morals, and that the tendency to literature elegant and polished, yet not destitute of vigour, which marks the 17th century, was largely developed side by side with much scandal-mongering and anecdote. Many of the authors whom these influences inspired, such as Voiture, Saint-Evremond and others, have been or will be noticed. But even such poets and wits as Antoine Baudouin de Sencécé (1643-1737), Jean de Segrais (1624-1701), Charles Faulx de Ris, sieur de Charleval (1612-1693), Antoine Godan (1605-1672), Jean Ogier de Gombaud (1590-1666), are not without interest in the history of literature; while if Charles Cotin (1604-1682) sinks below this level and deserves Molière's caricature of him as *Trismotin* in *Les Femmes savantes*, Gilles de Ménage (1630-1692) certainly rises above it, notwithstanding the companion satire of Vadius. Ménage's name naturally suggests the *Ana* which arose at this time and were long fashionable, stores of endless gossip, sometimes providing instruction and often amusement. The *Guilande de Julie*, in which most of the poets of the time celebrated Julie d'Angennes, daughter of the marquise de Rambouillet, is perhaps the best of all such albums, and Voiture, the typical poet of the coterie, was certainly the best writer of *vers de société* who is known to us. The poetical war which arose between the Uranistes, the followers of Voiture, and the Jobistes, those of Benserade, produced reams of sonnets, epigrams and similar verses. This habit of occasional versification continued long. It led as a less important consequence to the rhymed *Gazettes* of Jean Loret (d. 1665), which recount in octosyllabic verse of a light and lively kind the festivals and court events of the early years of Louis XIV. It led also to perhaps the most remarkable non-dramatic poetry of the century, the *Comtes* and *Fables* of Jean de la Fontaine (1621-1695). No French writer is better known than la Fontaine, and there is no need to dilate on his merits. It has been well said that he completes Molière, and that the two together give something to French literature which no other literature possesses. Yet la Fontaine is after all only a writer of *fabliaux*, in the language and with the manners of his own century.

All the writers we have mentioned belong more or less to the first half of the century, and so do Valentin Conrart (1603-1675), Antoine Furetière (1626-1688), Chapelle (Claude Emmanuel) l'Huillier (1626-1686), and others not worth special mention. The latter half of the century is far less productive, and the poetical quality of its production is even lower than the quantity. In it Boileau (1636-1711) is the chief poetical figure. Next to him can only be mentioned Madame Deshoulières (1638-1694), Guillaume de Brébeuf (1618-1661), the translator of Lucan, Philippe Quinault (1635-1688), the composer of opera libretti. Boileau's satire, where it has much merit, is usually borrowed direct from Horace. He had a certain faculty as a critic of the slashing order, and might have profitably used it if he had written in prose. But of his poetry it must be said, not so much that it is

bad, as that it is not, in strictness, poetry at all, and the same is generally true of all those who followed him.

17th-Century Drama.—We have already seen how the medieval theatre was formed, and how in the second half of the 16th century it met with a formidable rival in the classical drama of Jodelle and Garnier. In 1588 mysteries had been prohibited, and with the prohibition of the mysteries the Confraternity of the Passion lost the principal part of its reason for existence. The other bodies and societies of amateur actors had already perished, and at length the Hôtel de Bourgogne itself, the home of the confraternity, had been handed over to a regular troop of actors, while companies of strollers, whose life has been vividly depicted in the *Roman comique* of Scarron and the *Capitaine Fracasse* of Théophile Gautier, wandered all about the provinces. The old farce was for a time maintained or revived by Tabarin, a remarkable figure in dramatic history, of whom but little is known. The great dramatic author of the first quarter of the 17th century was Alexandre Hardy (1569-1631), who surpassed even Heywood

in fecundity, and very nearly approached the portentous productiveness of Lope de Vega. Seven hundred is put down as the modest total of Hardy's pieces, but not much more than a twentieth of these exist in print. From these latter we can judge Hardy. They are hardly up to the level of the worst specimens of the contemporary Elizabethan theatre, to which, however, they bear a certain resemblance. Marston's *Insatiable Countess* and the worst parts of Chapman's *Bussy d'Ambois* may give English readers some notion of them. Yet Hardy was not totally devoid of merit. He imitated and adapted Spanish literature, which was at this time to France what Italian was in the century before and English in the century after, in the most indiscriminate manner. But he had a considerable command of grandiloquent and melodramatic expression, a sound theory if not a sound practice of tragic writing, and that peculiar knowledge of theatrical art and of the taste of the theatrical public which since his time has been the special possession of the French playwright. It is instructive to compare the influence of his irregular and faulty genius with that of the regular and precise Malherbe. From Hardy to Rotrou is, in point of literary interest, a great step, and from Rotrou to Corneille a greater. Yet the theory of Hardy only wanted the genius of Rotrou and Corneille to produce the latter. Jean de Rotrou (1610-1650) has been called the French Marlowe, and there is a curious likeness and yet a curious contrast between

the two poets. The best parts of Rotrou's two best plays, *Venceslas* and *Si Genest*, are quite beyond comparison in respect of anything that preceded them, and the central speech of the last-named play will rank with anything in French dramatic poetry. Contemporary with Rotrou were other dramatic writers of considerable dramatic importance, most of them distinguished by the faults of the Spanish school, its declamatory rodomontade, its conceits, and its occasionally preposterous action. Jean de Schélande (d. 1635) has left us a remarkable work in *Tyr et Sidon*, which exemplifies in practice, as its almost more remarkable preface by François Ogier defends in principle, the English-Spanish model. Théophile de Viau in *Pyrame et Thisbé* and in *Pasiphale* produced a singular mixture of the classicism of Garnier and the extravagancies of Hardy. Scudéry in *L'Amour tyrannique* and other plays achieved a considerable success. The *Marianne* of Tristan (1601-1655) and the *Sophonisbe* of Jean de Mairet (1604-1686) are the chief pieces of their authors. Mairet resembles Marston in something more than his choice of subject. Another dramatic writer of some eminence is Pierre du Ryer (1606-1648). But the fertility of France at this moment in dramatic authors was immense; nearly 100 are enumerated in the first quarter

of the century. The early plays of Pierre Corneille (1606-1684) showed all the faults of his contemporaries combined with merits to which none of them except Rotrou, and Rotrou himself only in part, could lay claim. His first play was *Médée*, a comedy, and in *Cliandre*, a tragedy, he soon produced what may perhaps be not inconveniently taken as the typical piece of the school of Hardy. A full account of Corneille

may be found elsewhere. It is sufficient to say here that his importance in French literature is quite as great in the way of influence and example as in the way of intellectual excellence. The *Cid* and the *Menteur* are respectively the first examples of French tragedy and comedy which can be called modern. But this influence and example did not at first find many imitators. Corneille was a member of Richelieu's band of five poets. Of the other four Rotrou alone deserves the title; the remaining three, the prolific abbé de Boisrobert, Guillaume Colletet (whose most valuable work, a MS. *Lives of Poets*, was never printed, and burnt by the Communards in 1871), and Claude de Lestolle (1597-1651), are as dramatists worthy of no notice, nor were they soon followed by others more worthy. Yet before many years had passed the examples which Corneille had set in tragedy and in comedy were followed up by unquestionably the greatest comic writer, and by one who long held the position of the greatest tragic writer of France. Beginning with mere farces of the Italian type, and passing from these to comedies still of an Italian character, it was in *Les Précieuses ridicules*, acted in 1659, that Molière (1622-1673), in the words of a spectator, hit at last on "la bonne comédie." The next fifteen years

comprise the whole of his best known work, the finest expression beyond doubt of a certain class of comedy that any literature has produced. The tragic masterpieces of Racine (1639-1690) were not far from coinciding with the comic masterpieces of Molière, for, with the exception of the remarkable aftergrowth of *Esther* and *Alhalie*, they were produced chiefly between 1667 and 1677. Both Racine and Molière fall into the class of writers who require separate mention. Here we can only remark that both to a certain extent committed and encouraged a fault which distinguished much subsequent French dramatic literature. This was the too great individualising of one point in a character, and the making the man or woman nothing but a blunderer, a lover, a coxcomb, a tyrant and the like. The very titles of French plays show this influence—they are *Le Grandeur*, *Le Joueur*, &c. The complexity of human character is ignored. This fault distinguishes both Molière and Racine from writers of the very highest order; and in especial it distinguishes the comedy of Molière and the tragedy of Racine from the comedy and tragedy of Shakespeare. In all probability this and other defects of the French drama (which are not wholly apparent in the work of Molière and Corneille, are shown in their most favourable light in those of Racine, and appear in all their deformity in the successors of the latter) arise from the rigid adoption of the Aristotelian theory of the drama with its unities and other restrictions, especially as transmitted by Horace through Boileau. This adoption was very much due to the influence of the French Academy, which was founded unofficially by Conrart in 1629, which received official standing six years later, and which continued the tradition of Malherbe in

attempting constantly to school and correct, as the phrase went, the somewhat disorderly instincts of the early French stage. Even the *Cid* was formally censured for irregularity by it. But it is fair to say that François Hédelin, abbé d'Aubignac (1604-1676), whose *Pratique du théâtre* is the most wooden of the critical treatises of the time, was not an academician. It is difficult to say whether the subordination of all other classes of composition to the drama, which has ever since been characteristic of French literature, was or was not due to the predilection of Richelieu, the main protector if not exactly the founder of the Academy, for the theatre. Among the immediate successors and later contemporaries of the three great dramatists we do not find any who deserve high rank as tragedians, though there are some whose comedies are more than respectable. It is at least significant that the restrictions imposed by the academic theory on the comic drama were far less severe than those which tragedy had to undergo. The latter was practically confined, in respect of sources of attraction, to the dexterous manipulation of the unities; the interest of a plot attenuated as much as possible, and intended to produce, instead of pity a mild sympathy, and instead of terror a mild alarm (for the purists decided against Corneille that "admiration was not

a tragic passion"); and lastly the composition of long tirades of smooth but monotonous verses, arranged in couplets tipped with delicately careful rhymes. Only Thomas Corneille (1625-1709), the inheritor of an older tradition and of a great name, deserves to be excepted from the condemnation to be passed on the lesser tragedians of this period. He was unfortunate in possessing his brother's name, and in being, like him, too voluminous in his compositions; but *Camma*, *Ariane*, *Le Comte d'Essex*, are not tragedies to be despised. On the other hand, the names of Jean de Campistron (1656-1723) and Nicolas Pradon (1632-1698) mainly serve to point injurious comparisons; Joseph François Duché (1668-1704) and Antoine La Fosse (1653-1708) are of still less importance, and Quinault's tragedies are chiefly remarkable because he had the good sense to give up writing them and to take to opera. The general excellence of French comedy, on the other hand, was sufficiently vindicated. Besides the splendid sum of Molière's work, the two great tragedians had each, in *Le Menteur* and *Les Plaideurs*, set a capital example to their successors, which was fairly followed. David Augustin de Brueys (1640-1723) and Jean Palaprat (1650-1721) brought out once more the ever new *Avocat Patelin* besides the capital *Grondeur* already referred to. Quinault and Campistron wrote fair comedies. Florent Carton Dancourt (1661-1726), Charles Rivière Dufresny (c. 1654-1724), Edmond Boursault (1638-1701), were all comic writers of considerable merit. But the chief comic dramatist of the latter period of the 17th century was Jean François Regnard (1655-1709), whose *Joueur* and *Légataire* are comedies almost of the first rank.

17th-Century Fiction.—In the department of literature which comes between poetry and prose, that of romance-writing,

*Heroic
Romance.*

the 17th century, excepting one remarkable development, was not very fertile. It devoted itself to so many new or changed forms of literature that it had no time to anticipate the modern novel. Yet at the beginning of the century one very curious form of romance-writing was diligently cultivated, and its popularity, for the time immense, prevented the introduction of any stronger style. It is remarkable that, as the first quarter of the 17th century was pre-eminently the epoch of Spanish influence in France, the distinctive satire of Cervantes should have been less imitated than the models which Cervantes satirized. However this may be, the romances of 1600 to 1650 form a class of literature vast, isolated, and, perhaps, of all such classes of literature most utterly obsolete and extinct. Taste, affectation or antiquarian diligence have, at one time or another, restored to a just, and sometimes a more than just, measure of reputation most of the literary relics of the past. Romances of chivalry, fabliaux, early drama, Provençal poetry, prose chronicles, have all had, and deservedly, their rehabilitators. But *Polexandre* and *Cléopâtre*, *Clélie* and the *Grand Cyrus*, have been too heavy for all the industry and energy of literary antiquarians. As we have already hinted, the nearest ancestry which can be found for them is the romances of the *Amadis* type. But the *Amadis*, and in a less degree its followers, although long, are long in virtue of incident. The romances of the *Clélie* type are long in virtue of interminable discourse, moralizing and description. Their manner is not unlike that of the *Arcadia* and the *Euphues* which preceded them in England; and they express in point of style the tendency which simultaneously manifested itself all over Europe at this period, and whose chief exponents were Gongora in Spain, Marini in Italy, and Lyly in England. Everybody knows the *Corte de Tendre* which originally appeared in *Clélie*, while most people have heard of the shepherds and shepherdesses who figure in the *Asire* of Honoré D'Urfé (1568-1625), on the borders of the Lignon; but here general knowledge ends, and there is perhaps no reason why it should go much further. It is sufficient to say that Madeleine de Scudéry (1607-1701) principally devotes herself in the books above mentioned to laborious gallantry and heroism, like La Calprédène (1610-1663) in *Cassandre et Cléopâtre* to something which might have been the historical novel if it had been constructed on a less preposterous scale, and *Maxie le Roy de Comberville* (1600-1647) in *Polexandre*

to moralizings and theological discussions on Jansenist principles, while Pierre Camus, bishop of Belley (1582-1652), in *Palombe* and others, approached still nearer to the strictly religious story. In the latter part of the century, the example of La Fontaine, though he himself wrote in poetry, helped to recall the tale-tellers of France to an occupation more worthy of them, more suitable to the genius of the literature, and more likely to last. The reaction against the *Clélie* school produced first Madame de Villiedieu (Cathérine Desjardins) (1632-1692), a fluent and facile novelist, who enjoyed great but not enduring popularity. The form which the prose tale took at this period was that of the fairy story. Perrault (1628-1703) and Madame d'Aulnoy (d. 1705) composed specimens of this kind which have never ceased to be popular since. Hamilton (1646-1720), the author of the well-known *Mémoires du comte de Gramont*, wrote similar stories of extraordinary merit in style and ingenuity. There is yet a third class of prose writing which deserves to be mentioned. It also may probably be traced to Spanish influence, that is to say, to the picaresque romances which the 16th and 17th centuries produced in Spain in large numbers. The most remarkable example of this is the *Roman comique* of the burlesque writer Scarron. The *Roman bourgeois* of Antoine Furetière (1619-1688) also deserves mention as a collection of pictures of the life of the time, arranged in the most desultory manner, but drawn with great vividness, observation and skill. A remarkable writer who had great influence on Molière has also to be mentioned in this connexion rather than in any other. This is Cyrano de Bergerac (1619-1655), who, besides composing doubtful comedies and tragedies, writing political pamphlets, and exercising the task of literary criticism in objecting to Scarron's burlesques, produced in his *Histoires comiques des états et empires de la lune et du soleil*, half romantic and half satirical compositions, in which some have seen the original of *Gulliver's Travels*, in which others have discovered only a not very successful imitation of Rabelais, and which, without attempting to decide these questions, may fairly be ranked in the same class of fiction with the masterpieces of Swift and Rabelais, though of course at an immense distance below them. One other work, and in literary influence perhaps the most remarkable of its kind in the century, remains. Madame de Lafayette, Marie de la Vergne (1634-1692), the friend of La Rochefoucauld and of Madame de Sévigné, though she did not exactly anticipate the modern novel, showed the way to it in her stories, the principal of which are *Zaide* and still more *La Princesse de Clèves*. The latter, though a long way from *Manon Lescaut*, *Clarissa*, or *Tom Jones*, is a longer way still from *Polexandre* or the *Arcadia*. The novel becomes in it no longer a more or less fictitious chronicle, but an attempt at least at the display of character. *La Princesse de Clèves* has never been one of the works widely popular out of their own country, nor perhaps does it deserve such popularity, for it has more grace than strength; but as an original effort in an important direction its historical value is considerable. But with this exception, the art of fictitious prose composition, except on a small scale, is certainly not one in which the century excelled, nor are any of the masterpieces which it produced to be ranked in this class.

17th-Century Prose.—If, however, this was the case, it cannot be said that French prose as a whole was unproductive at this time. On the contrary, it was now, and only now, *J. G. de Balzac* and that it attained the strength and perfection for which *moderne* it has been so long renowned, and which has perhaps, *French* by a curious process of compensation, somewhat *prose.* deteriorated since the restoration of poetry proper

in France. The prose Malherbe of French literature was Jean Guez de Balzac (1594-1654). The writers of the 17th century had practically created the literary language of prose, but they had not created a prose style. The charm of Rabelais, of Amyot, of Montaigne, and of the numerous writers of tales and memoirs whom we have noticed, was a charm of exuberance, of naïveté, of picturesque effect—in short, of a mixture of poetry and prose, rather than of prose proper. Sixteenth-century French prose is a delightful instrument in the hands of men and women of genius, but in the hands of those who have not genius it is full

of defects, and indeed is nearly unreadable. Now, prose is essentially an instrument of all work. The poet who has not genius had better not write at all; the prose writer often may and sometimes must dispense with this qualification. He has need, therefore, of a suitable machine to help him to perform his task, and this machine it is the glory of Balzac to have done more than any other person to create. He produced himself no great work, his principal writings being letters, a few discourses and dissertations, and a work entitled *Le Socrate chrétien*, a sort of treatise on political theology. But if the matter of his work is not of the first importance, its manner is of a very different value. Instead of the endless diffuseness of the preceding century, its ill-formed or rather unformed sentences, and its haphazard periods, we find clauses, sentences and paragraphs distinctly planned, shaped and balanced, a cadence introduced which is rhythmical but not metrical, and, in short, prose which is written knowingly instead of the prose which is unwittingly talked. It has been well said of him that he "écrit pour écrire"; and such a man, it is evident, if he does nothing else, sets a valuable example to those who write because they have something to say. Voiture seconded Balzac without much intending to do so. His prose style, also chiefly contained in letters, is lighter than that of his contemporary, and helped to gain for French prose the tradition of vivacity and sparkle which it has always possessed, as well as that of correctness and grace.

17th-Century History.—In historical composition, especially in the department of memoirs, this period was exceedingly rich. At last there was written, in French, an entire history of France. The author was François Eudes de Mézeray (1610-1683), whose work, though not exhibiting the perfection of style at which some of his contemporaries had already arrived, and though still more or less uncritical, yet deserves the title of history. The example was followed by a large number of writers, some of extended works, some of histories in part. Mézeray himself is said to have had a considerable share in the *Histoire du roi Henri le grand* by the archbishop Péréfixe (1605-1670); Louis Maimbourg (1610-1686) wrote histories of the Crusades and of the League; Paul Pellisson (1624-1693) gave a history of Louis XIV. and a more valuable *Mémoire* in defence of the superintendent Fouquet. Still later in the century, or at the beginning of the next, the Père d'Orléans (1644-1698) wrote a history of the revolutions of England, the Père Daniel (1649-1728), like d'Orléans a Jesuit, composed a lengthy history of France and a shorter one on the French military forces. Finally, at the end of the period, comes the great ecclesiastical history of Claude Fleury (1640-1723), a work which perhaps belongs more to the section of erudition than to that of history proper. Three small treatises, however, composed by different authors towards the middle part of the century, supply remarkable instances of prose style in its application to history. These are the *Conjurations du comte de Fiesque*, written by the famous Cardinal de Retz (1613-1679), the *Conspiration de Walslein* of Sarrasin, and the *Conjuration des Espagnols contre Venise*, composed in 1672 by the abbé de Saint-Réal (1639-1692), the author of various historical and critical works deserving less notice. These three works, whose similarity of subject and successive composition at short intervals leave little doubt that a certain amount of intentional rivalry animated the two later authors, are among the earliest and best examples of the monographs for which French, in point of grace of style and lucidity of exposition, has long been the most successful vehicle of expression among European languages. Among other writers of history, as distinguished from memoirs, need only be noticed Agrippa d'Aubigné, whose *Histoire universelle* closed his long and varied list of works, and Varillas (1624-1696), a historian chiefly remarkable for his extreme untrustworthiness. In point of memoirs and correspondence the period is hardly less fruitful than that which preceded it. The *Régistres-Journaux* of Pierre de l'Étoile (1540-1611) consist of a diary something of the Pepys character, kept for nearly forty years by a person in high official employment. The memoirs of Sully (1560-1641), published under a curious title too long to quote, date also from this time.

Henri IV. himself has left a considerable correspondence, which is not destitute of literary merit, though not equal to the memoirs of his wife. What are commonly called Richelieu's *Memoirs* were probably written to his order; his *Testament politique* may be his own. Henri de Rohan (1579-1638) has not memoirs of the first value. Both this and earlier times found chronicle in the singular *Historiettes* of Gédéon Tallemant des Réaux (1610-1690), a collection of anecdotes, frequently scandalous, reaching from the times of Henri IV. to those of Louis XIV., to which may be joined the letters of Guy Patin (1602-1676). The early years of the latter monarch and the period of the Fronde had the cardinal de Retz himself, than whom no one was certainly better qualified for historian, not to mention a crowd of others, of whom we may mention Madame de Motteville (1621-1689), Jean Hérault de Gourville (1625-1703), Mademoiselle de Montpensier ("La Grande Mademoiselle") (1627-1693), Conrart, Turenne and Mathieu Molé (1584-1663), François du Val, marquis de Fontenay-Mareuil (1594-1655), Arnauld d'Andilly (1588-1670). From this time memoirs and memoir writers were ever multiplying. The queen of them all is Madame de Sevigné (1626-1696), on whom, as on most of the great and better-known writers whom we have had and shall have to mention, it is impossible here to dwell at length. The last half of the century produced crowds of similar but inferior writers. The memoirs of Roger de Bussy-Rabutin (1618-1693) (author of a kind of scandalous chronicle called *Histoire amoureuse des Gaules*) and of Madame de Maintenon (1635-1719) perhaps deserve notice above the others. But this was in truth the style of composition in which the age most excelled. Memoir-writing became the occupation not so much of persons who made history, as was the case from Comines to Retz, as of those who, having culture, leisure and opportunity of observation, devoted themselves to the task of recording the deeds of others, and still more of regarding the incidents of the busy, splendid and cultivated if somewhat frivolous world of the court, in which, from the time of Louis XIV.'s majority, the political life of the nation and almost its whole history were centred. Many, if not most, of these writers were women, who thus founded the celebrity of the French lady for managing her mother-tongue, and justified by results the taste and tendencies of the blue-stockings and précieuses of the Hôtel Rambouillet and similar coteries. The life which these writers saw before them furnished them with a subject to be handled with the minuteness and care to which they had been accustomed in the ponderous romances of the *Clélie* type, but also with the wit and tenderness hereditary in France, and only temporarily absent in those pponderous compositions. The efforts of Balzac and the Academy supplied a suitable language and style, and the increasing tendency towards epigrammatic moralizing, which reached its acme in La Rochefoucauld (1663-1680) and La Bruyère (1639-1696), added in most cases point and attractiveness to their writings.

17th-Century Philosophers and Theologians.—To these moralists we might, perhaps, not inappropriately pass at once. But it seems better to consider first the philosophical and theological developments of the age, which must share with its historical experiences and studies the credit of producing these writers. Philosophy proper, as we have already had occasion to remark, had hitherto made no use of the vulgar tongue. The 16th century had contributed a few vernacular treatises on logic, a considerable body of political and ethical writing, and a good deal of sceptical speculation of a more or less vague character, continued into our present epoch by such writers as François de la Mothe le Vayer (1588-1672), the last representative of the orthodox doubt of Montaigne and Charron. But in metaphysics proper it had not dabbled. The 17th century, on the contrary, was to produce in René Descartes (1596-1650), at once a master of prose style, the greatest of French philosophers, and one of the greatest metaphysicians, not merely of France and of the 17th century, but of all countries and times. Even before Descartes there had been considerable and important developments of metaphysical speculation in France. The first eminent philosopher of French birth was Pierre Gassendi (1592-

1655). Gassendi devoted himself to the maintenance of a modernized form of the Epicurean doctrines, but he wrote mainly, if not entirely, in Latin. Another sceptical philosopher of a less scientific character was the physicist Gabriel Naudé (1600-1653), who, like many others of the philosophers of the time, was accused of atheism. But as none of these could approach Descartes in philosophical power and originality, so also none has even a fraction of his importance in the history of French literature. Descartes stands with Plato, and possibly Berkeley and Malebranche, at the head of all philosophers in respect of style; and in his case the excellence is far more remarkable than in others, inasmuch as he had absolutely no models, and was forced in a great degree to create the language which he used. The *Discours de la méthode* is not only one of the epoch-making books of philosophy, it is also one of the epoch-making books of French style. The tradition of his clear and perfect expression was taken up, not merely by his philosophical disciples, but also by Blaise Pascal (1623-1662) and the school of Port Royal, who will be noticed presently. The very genius of the Cartesian philosophy was intimately connected with this clearness, distinctness and severity of style; and there is something more than a fanciful contrast between these literary characteristics of Descartes, on the one hand, and the elaborate splendour of Bacon, the knotty and crabbed strength of Hobbes, and the commonplace and almost vulgar slovenliness of Locke. Of the followers of Descartes, putting aside the Port Royalists, by far the most distinguished, both in philosophy and in literature, is Nicolas Malebranche (1638-1715). His *Recherche de la vérité*, admirable as it is for its subtlety and its consequentiveness of thought, is equally admirable for its elegance of style. Malbranche cannot indeed, like his great master, claim absolute originality. But his excellence as a writer is as great as, if not greater than, that of Descartes, and the *Recherche* remains to this day the one philosophical treatise of great length and abstruseness which, merely as a book, is delightful to read—not like the works of Plato and Berkeley, because of the adventitious graces of dialogue or description, but from the purity and grace of the language, and its admirable adjustment to the purposes of the argument. Yet, for all this, philosophy hardly flourished in France. It was too intimately connected with theological and ecclesiastical questions, and especially with Jansenism, to escape suspicion and persecution. Descartes himself was for much of his life an exile in Holland and Sweden; and though the unquestionable orthodoxy of Malebranche, the strongly religious cast of his works, and the remoteness of the abstruse region in which he sojourned from that of the controversies of the day, protected him, other followers of Descartes were not so fortunate. Holland, indeed, became a kind of city of refuge for students of philosophy, though even in Holland itself they were by no means entirely safe from persecution. By far the most remarkable of French philosophical sojourners in the Netherlands was Pierre Bayle (1647-1706), a name not perhaps of the first rank in respect of literary value, but certainly of the first as regards literary influence. Bayle, after oscillating between the two confessions, nominally remained a Protestant in religion. In philosophy he in the same manner oscillated between Descartes and Gassendi, finally resting in an equally nominal Cartesianism. Bayle was, in fact, both in philosophy and in religion, merely a sceptic, with a scepticism at once like and unlike that of Montaigne, and differentiated both by temperament and by circumstance—the scepticism of the mere student, exercised more or less in all histories, sciences and philosophies, and intellectually unable or unwilling to take a side. His style is hardly to be called good, being diffuse and often inelegant. But his great dictionary, though one of the most heterogeneous and unmethodical of compositions, exercised an enormous influence. It may be called the Bible of the 18th century, and contains in the germ all the desultory philosophy, the ill-ordered scepticism, and the critical but negatively critical acuteness of the *Aufklärung*.

We have said that the philosophical, theological and moral tendencies of the century, which produced, with the exception

of its dramatic triumphs, all its greatest literary works, are almost inextricably intermingled. Its earliest years, however, bear in theological matters rather the complexion of the previous century. Du Perron and St Francis of Sales ^{Jesuits} survived until nearly the end of its first quarter, and the most remarkable works of the latter bear the dates of 1608 and later. It was not, however, till some years had passed, till the counter-Reformation had reconverted the largest and most powerful portion of the Huguenot party, and till the influence of Jansenius and Descartes had time to work, that the extraordinary outburst of Gallican theology, both in pulpit and in press, took place. The Jansenist controversy may perhaps be awarded the merit of provoking this, as far as writing was concerned. The astonishing eloquence of contemporary pulpit oratory may be set down partly to the zeal for conversion of which du Perron and de Sales had given the example, partly to the same taste of the time which encouraged dramatic performances, for the sermon and the tirade have much in common. Jansenius himself, though a Dutchman by birth, passed much time in France, and it was in France that he found most disciples. These disciples consisted in the first place of the members of the society of Port Royal des Champs, a coterie after the fashion of the time, but one which devoted itself not to sonnets or madrigals but to devotional exercises, study and the teaching of youth. This coterie early adopted the Cartesian philosophy, and the Port Royal *Logic* was the most remarkable popular hand-book ^{Port Royal} of that school. In theology they adopted Jansenism, and were in consequence soon at daggers drawn with the Jesuits, according to the polemical habits of the time. The most distinguished champions on the Jansenist side were Jean Duvergier de Hauranne, abbé de St Cyran (1581-1643), and Antoine Arnauld (1560-1619), but by far the most important literary results of the quarrel were the famous *Provinciales* of Pascal, or, to give them their proper title, *Lettres écrites à un provincial*. ^{Pascal} Their literary importance consists, not merely in their grace of style, but in the application to serious discussion of the peculiarly polished and quiet irony of which Pascal is the greatest master the world has ever seen. Up to this time controversy had usually been conducted either in the mere budgeon fashion of the Scaligers and Saumaises—of which in the vernacular the Jesuit François Garasse (1585-1631) had already contributed remarkable examples to literary and moral controversy—or else in a dull and legal style, or lastly under an envelope of Rabelaisian buffoonery such as survives to a considerable extent in the *Satire Ménippée*. Pascal set the example of combining the use of the most terribly effective weapons with good humour, good breeding and a polished style. The example was largely followed, and the manner of Voltaire and his followers in the 18th century owes at least as much to Pascal as their method and matter do to Bayle. The Jansenists, attacked and persecuted by the civil power, which the Jesuits had contrived to interest, were finally suppressed. But the *Provinciales* had given them an unapproachable superiority in matter of argument and literature. Their other literary works were inferior, though still remarkable. Antoine Arnauld (the younger, often called "the great") (1612-1694) and Pierre Nicole (1625-1695) managed their native language with vigour if not exactly with grace. They maintained their orthodoxy by writings, not merely against the Jesuits, but also against the Protestants such as the *Perpétuité de la foi* due to both, and the *Apologie des Catholiques* written by Arnauld alone. The latter, besides being responsible for a good deal of the *Logic (L'Art de penser)* to which we have alluded, wrote also much of a *Grammaire générale* composed by the Port Royalists for the use of their pupils; but his principal devotion was to theology and theological polemics. To the latter Nicole also contributed *Les Visionnaires*, *Les Imaginaires* and other works. The studious recluses of Port Royal also produced a large quantity of miscellaneous literary work, to which full justice has been done in Sainte-Beuve's well-known volumes.

17th-Century Preachers.—When we think of Gallican theology during the 17th century, it is always with the famous pulpit orators of the period that thought is most busied. Nor is this

unjust, for though the most prominent of them all, Jacques Bénigne Bossuet (1627-1704) was remarkable as a writer of matter intended to be read, not merely as a speaker of matter intended to be heard, this double character is not possessed by most of the orthodox theologians of the time; and even Bossuet, great as is his genius, is more of a rhetorician than of a philosopher or a theologian. In no quarter was the advance of culture more remarkable in France than in the pulpit. We have already had occasion to notice the characteristics of French pulpit eloquence in the 15th and 16th centuries. Though this was very far from destitute of vigour and imagination, the political frenzy of the preachers, and the habit of introducing anecdotic buffoonery, spoil the eloquence of Maillard and of Raulin, of Boucher and of Rosc. The powerful use which the Reformed ministers made of the pulpit stirred up their rivals; the advance in science and classical study added weight and dignity to the matter of their discourses. The improvement of prose style and language provided them with a suitable instrument, and the growth of taste and refinement purged their sermons of grossness and buffoonery, of personal allusions, and even, as the monarchy became more absolute, of direct political purpose. The earliest examples of this improved style were given by St Francis de Sales and by Fenouillet, bishop of Marseilles (d. 1652); but it was not till the latter half of the century, when the troubles of the Fronde had completely subsided, and the church was established in the favour of Louis XIV., that the full efflorescence of theological eloquence took place. There were at the time pulpit orators of considerable excellence in England, and perhaps Jeremy Taylor, assisted by the genius of the language, has wrought a vein more precious than any which the somewhat academic methods and limitations of the French teachers allowed them to reach. But no country has ever been able to show a more magnificent concourse of orators, sacred or profane, than that formed by Bossuet, Fénelon (1651-1715), Esprit Fléchier (1632-1710), Jules Mascaron (1634-1703), Louis Bourdaloue (1632-1704), and Jean Baptiste Massillon (1663-1742), to whom may be justly added the Protestant divines, Jean Claude (1619-1687) and Jacques Saurin (1677-1730).

Bossuet. The characteristics of all these were different. Bossuet, the earliest and certainly the greatest, was also the most universal. He was not merely a preacher; he was, as we have said, a controversialist, indeed somewhat too much of a controversialist, as his battle with Fénelon proved. He was a philosophical or at least a theological historian, and his *Discours sur l'histoire universelle* is equally remarkable from the point of view of theology, philosophy, history and literature. Turning to theological politics, he wrote his *Politique tirée de l'écriture sainte*, to theology proper his *Méditations sur les évangiles* and his *Élévations sur les mystères*. But his principal work, after all, is his *Oraisons funèbres*. The funeral sermon was the special oratorical exercise of the time. Its subject and character invited the gorgeous if somewhat theatrical commonplaces, the display of historical knowledge and parallel, and the moralizing analogies, in which the age specially rejoiced. It must also be noticed, to the credit of the preachers, that such occasions gave them an opportunity, rarely neglected, of correcting the adulation which was but too frequently characteristic of the period. The spirit of these compositions is fairly reflected in the most famous and often quoted of their phrases, the opening "Mes frères, Dieu seul est grand" of Massillon's funeral discourse on Louis XIV.; and though panegyric is necessarily by no means absent, it is rarely carried beyond bounds. While Bossuet made himself chiefly remarkable in his sermons and in his writings by an almost Hebraic grandeur and rudeness, the more special characteristics of Christianity, largely alloyed with a Greek and Platonic spirit, displayed themselves in Fénelon. In pure literature he is not less remarkable than in theology, politics and morals. His practice in matters of style was admirable, as the universally known *Télémaque* sufficiently shows to those who know nothing else of his writing. But his taste, both in its correctness and its audacity, is perhaps more admirable still. Despite of Malherbe, Balzac, Boileau and the traditions

of nearly a century, he dared to speak favourably of Ronsard, and plainly expressed his opinion that the practice of his own contemporaries and predecessors had cramped and impoverished the French language quite as much as they had polished or purified it. The other doctors whom we have mentioned were more purely theological than the accomplished archbishop of Cambray. Fléchier is somewhat more archaic in style than Bossuet or Fénelon, and he is also more definitely a rhetorician than either. Mascaron has the older fault of prodigal and somewhat indiscriminate erudition. But the two latest of the series, Bourdaloue and Massillon, had far the greatest repute in their own time purely as orators, and perhaps deserved this preference. The difference between the two repeated that between du Perron and de Sales. Bourdaloue's great forte was vigorous argument and unsparring denunciation, but he is said to have been lacking in the power of influencing and affecting his hearers. His attraction was purely intellectual, and it is reflected in his style, which is clear and forcible, but destitute of warmth and colour. Massillon, on the other hand, was remarkable for his pathos, and for his power of enlisting and influencing the sympathies of his hearers. Of minor preachers on the same side, Charles de la Rue, a Jesuit (1643-1725), and the Père Cheminais (1652-1680), according to a somewhat idle form of nomenclature, "the Racine of the pulpit," may be mentioned. The two Protestant ministers whom we have mentioned, though inferior to their rivals, yet deserve honourable mention among the ecclesiastical writers of the period. Claude engaged in a controversy with Bossuet, in which victory is claimed for the invincible eagle of Meaux. Saurin, by far the greater preacher of the two, long continued to occupy, and indeed still occupies, in the libraries of French Protestants, the position given to Bossuet and Massillon on the other side.

17th-Century Moralists.—It is not surprising that the works of Montaigne and Charron, with the immense popularity of the former, should have inclined the more thoughtful minds in France to moral reflection, especially as many other influences, both direct and indirect, contributed to produce the same result. The constant tendency of the refinements in French prose was towards clearness, succinctness and precision, the qualities most necessary in the moralist. The characteristics of the prevailing philosophy, that of Descartes, pointed in the same direction. It so happened, too, that the times were more favourable to the thinker and writer on ethical subjects than to the speculator in philosophy proper, in theology or in politics. Both the former subjects exposed their cultivators, as we have seen, to the suspicion of unorthodoxy; and to political speculation of any kind the rule of Richelieu, and still more that of Louis XIV., were in the highest degree unfavourable. No successors to Bodin and du Vair appeared; and even in the domain of legal writings, which comes nearest to that of politics, but few names of eminence are to be found.

Only the name of Omer-Talon (1595-1652) really illustrates the legal annals of France at this period on the bench, and that of Olivier Patru (1604-1681) at the bar. Thus it happened that the interests of many different classes ^{Pascal and} of persons were concentrated upon moralizings, which ^{penance-} ^{writing.} took indeed very different forms in the hands of Pascal and other grave and serious thinkers of the Jansenist complexion in theology, and in those of literary courtiers like Saint-Evremond (1613-1703) and La Rochefoucauld, whose chief object was to depict the motives and characters prominent in the brilliant and not altogether frivolous society in which they moved. Both classes, however, were more or less tempted by the cast of their thoughts and the genius of the language to adopt the tersest and most epigrammatic form of expression possible, and thus to originate the "pensée" in which, as its greatest later writer, Joubert, has said, "the ambition of the author is to put a book into a page, a page into a phrase, and a phrase into a word." The great genius and admirable style of Pascal are certainly not less shown in his *Pensées* than in his *Provinciales*, though perhaps the literary form of the former is less strikingly supreme than that of the latter. The author is more dominated by his

subject and dominates it less. Nicole, a far inferior writer as well as thinker, has also left a considerable number of *Pensées*, which have about them something more of the essay and less of the aphorism. They are, however, though not comparable to Pascal, excellent in matter and style, and go far to justify Bayle in calling their author "l'une des plus belles plumes de l'Europe." In sharp contrast with these thinkers, who are invariably not merely respecters of religion but ardently and avowedly religious, who treat morality from the point of view of the Bible and the church, there arose side by side with them, or only a little later, a very different group of moralists, whose writings have been as widely read, and who have had as great a practical and literary influence as perhaps any other class of authors. The earliest to be born and the last to die of these was Charles de Saint-Denis, seigneur de saint-Evremond (1613-

Saint-Evremond.

1703). Saint-Evremond was long known rather as a conversational wit, some of whose good things were handed about in manuscript, or surreptitiously printed in foreign lands, than as a writer, and this is still to a certain extent his reputation. He was at least as cynical as his still better known contemporary La Rochefoucauld, if not more so, and he had less intellectual force and less nobility of character. But his wit was very great, and he set the example of the brilliant societies of the next century. Many of Saint-Evremond's printed works are nominally works of literary criticism, but the moralizing spirit pervades all of them. No writer had a greater influence on Voltaire, and through Voltaire on the whole course of French literature after him. In direct literary value, however, no comparison can be made between Saint-Evremond and the author of the *Sentences et maximes morales*. François, duc de la Rochefoucauld (1613-1680), has other literary claims besides those of this famous book. His *Mémoires*

La Rochefoucauld.

were very favourably judged by his contemporaries, and they are still held to deserve no little praise even among the numerous and excellent works of the kind which that age of memoir-writers produced. But while the *Mémoires* thus invite comparison, the *Maximes et sentences* stand alone. Even allowing that the mere publication of detached reflections in terse language was not absolutely new, it had never been carried, perhaps has never since been carried, to such a perfection. Beside La Rochefoucauld all other writers are diffuse, vacillating, unfinished, rough. Not only is there in him never a word too much, but there is never a word too little. The thought is always fully expressed, not compressed. Frequently as the metaphor of minting or stamping coin has been applied to the art of managing words, it has never been applied so appropriately as to the maxims of La Rochefoucauld. The form of them is almost beyond praise, and its excellences, combined with their immense and enduring popularity, have had a very considerable share in influencing the character of subsequent French literature. Of hardly less importance in this respect, though of considerably less intellectual and literary individuality, was the translator of Theophrastus and the author of the *Caractères*, La Bruyère.

La Bruyère.

Jean de la Bruyère (1645-1666), though frequently epigrammatic, did not aim at the same incredible terseness as the author of the *Maximes*. His plan did not, indeed, render it necessary. Both in England and in France there had been during the whole of the century a mania for character writing, both of the general and Theophrastic kind, and of the historical and personal order. The latter, of which our own Clarendon is perhaps the greatest master, abound in the French memoirs of the period. The former, of which the naïve sketches of Earle and Overbury are English examples, culminated in those of La Bruyère, which are not only light and easy in manner and matter, but also in style essentially amusing, though instructive as well. Both he and La Rochefoucauld had an enduring effect on the literature which followed them—an effect perhaps superior to that exercised by any other single work in France, except the *Roman de la rose* and the *Essais* of Montaigne.

17th-Century Savants.—Of the literature of the 17th century there only remains to be dealt with the section of those writers who devoted themselves to scientific pursuits or to antiquarian

erudition of one form or another. It was in this century that literary criticism of French and in French first began to be largely composed, and after this time we shall give it a separate heading. It was very far, however, from attaining the excellence or observing the form which it afterwards assumed. The institution of the Academy led to various linguistic works. One of the earliest of these was the *Remarques* of the Savoyard Claude Favre de Vaugelas (1595-1650), afterwards re-edited by Thomas Corneille. Pellisson wrote a history of the Academy itself when it had as yet but a brief one. The famous *Examen du Cid* was an instance of the literary criticism of the time which was afterwards represented by René Rapin (1621-1682), Dominique Bouhours (1628-1702) and René de Bossu (1631-1680), while Adrien Baillet (1649-1706) has collected the largest thesaurus of the subject in his *Jugemens des savants*. Boileau set the example of treating such subjects in verse, and in the latter part of the century *Reflexions, Discourses, Observations*, and the like, on particular styles, literary forms and authors, became exceedingly numerous. In earlier years France possessed a numerous band of classical scholars of the first rank, such as Scaliger and Casaubon, who did not lack followers. But all or almost all this sort of work was done in Latin, so that it contributed little to French literature properly so-called, though the translations from the classics of Nicolas Perrot d'Ablancourt (1606-1664) have always taken rank among the models of French style. On the other hand, mathematical studies were pursued by persons of far other and far greater genius, and, taking from this time forward a considerable position in education and literature in France, had much influence on both. The mathematical discoveries of Pascal and Descartes are well known. Of science proper, apart from mathematics, France did not produce many distinguished cultivators in this century. The philosophy of Descartes was not on the whole favourable to such investigations, which were in the next century to be pursued with ardour. Its tendencies found more congenial vent and are more thoroughly exemplified in the famous quarrel between the Ancients and the Moderns. This, of Italian origin, was mainly started in France by Charles Perrault (1628-1703), who thereby rendered much less service to literature than by his charming fairy tales. The opposite side was taken by Boileau, and the fight was afterwards revived by Antoine Houdar[d, t] de la Motte (1673-1731), a writer of little learning but much talent in various ways, and by the celebrated Madame Dacier, Anne Lefèvre (1654-1720). The discussion was conducted, as is well known, without very much knowledge or judgment among the disputants on the one side or on the other. But at this very time there were in France students and scholars of the most profound erudition. We have already mentioned Fleury and his ecclesiastical history. But Fleury is only the last and the most popular of a race of omnivorous and untiring scholars, whose labours have ever since, until the modern fashion of first-hand investigations came in, furnished the bulk of historical and scholarly references and quotations. To this century belong le Nain de Tillemont (1637-1698), whose enormous *Histoire des empereurs* and *Mémoires pour servir à l'histoire ecclésiastique* served Gibbon and a hundred others as quarry; Charles Dufresne, seigneur de Ducange (1614-1688), whose well-known glossary was only one of numerous productions; Jean Mabillon (1632-1707), one of the most voluminous of the voluminous Benedictines; and Bernard de Montfaucon (1655-1741), chief of all authorities of the dry-as-dust kind on classical archaeology and art.

Controversy between Ancients and Moderns.

Opening of the 18th Century.—The beginning of the 18th century is among the dead seasons of French literature. All the greatest men whose names had illustrated the early reign of Louis XIV. in profane literature passed away long before him, and the last if the least of them, Boileau and Thomas Corneille, only survived into the very earliest years of the new age. The political and military disasters of the last years of the reign were accompanied by a state of things in society unfavourable to literary development. The devotion to pure literature and philosophy proper which Descartes and Corneille had inspired had

died out, and the devotion to physical science, to sociology, and to a kind of free-thinking optimism which was to inspire Voltaire and the Encyclopedists had not yet become fashionable. Fénelon and Malebranche still survived, but they were emphatically men of the last age, as was Massillon, though he lived till nearly the middle of the century. The characteristic literary figures of the opening years of the period are d'Aguesseau, Fontenelle, Saint-Simon, personages in many ways interesting and remarkable, but purely transitional in their characteristics. Bernard le Bovier de Fontenelle (1657-1757) is, indeed, perhaps the most typical figure of the time. He was a dramatist, a moralist, a philosopher, physical and metaphysical, a critic, an historian, a poet and a satirist. The manner of his works is always easy and graceful, and their matter rarely contemptible.

18th-Century Poetry.—The inspiring signs shown during the 17th century by French poetry proper received entire fulfilment in the following age. The two poets who were most prominent at the opening of the period were the abbé de Chaulieu (1639-1720) and the marquis de la Fare (1644-1713), poetical or rather versifying twins who are always quoted together. They were both men who lived to a great age, yet their characteristics are rather those of their later than of their earlier contemporaries. They derive on the one hand from the somewhat trifling school of Voiture, on the other from the Bacchic sect of Saint-Amant; and they succeed in uniting the inferior qualities of both with the cramped and impoverished though elegant style of which Fénelon had complained. Their compositions are as a rule lyrical, as lyrical poetry was understood after the days of Malherbe—that is to say, quatrains of the kind ridiculed by Molière, and Pindaric odes, which have been justly described as made up of alexandrines after the manner of Boileau cut up into shorter or longer lengths. They were followed, however, by the one poet who succeeded in producing something resembling poetry in this artificial style, J. B. Rousseau (1671-1741).

J. B. Rousseau. Rousseau, who in some respects was nothing so little as a religious poet, was nevertheless strongly influenced, as Marot had been, by the Psalms of David. His *Odes* and his *Cantates* are perhaps less destitute of that spirit than the work of any other poet of the century excepting André Chénier. Rousseau was also an extremely successful epigrammatist, having in this respect, too, resemblances to Marot. Le Franc de Pompignan (1709-1784), to whom Voltaire's well-known sarcasms are not altogether just, and Louis Racine (1692-1763), who wrote pious and altogether forgotten poems, belonged to the same poetical school; though both the style and matter of Racine are strongly tinged by his Port Royalist sympathies and education. Lighter verse was represented in the 18th century by the long-lived Saint-Aulaire (1643-1742), by Gentil Bernard (1710-1775), by the abbé (afterwards cardinal) de Bernis (1715-1794), by Claude Joseph Dorat (1734-1780), by Antoine Bertin (1752-1790) and by Evariste de Parny (1753-1814), the last the most vigorous, but all somewhat deserving the term applied to Dorat of *ver luisant du Parnasse*. The jovial traditions of Saint-Amant begat a similar school of anaerotic songsters, which, represented in turn by Charles François Panard (1674-1765), Charles Collé (1709-1783), Armand Gouffé (1775-1845), and Marc-Antoine-Madeleine Desaugiers (1772-1827), led directly to the best of all such writers, Béranger. To this class Rouget de Lisle (1760-1836) perhaps also belongs; though his most famous composition, the *Marseillaise*, is of a different stamp. Nor is the account of the light verse of the 18th century complete without reference to a long succession of fable writers, who, in an unbroken chain, connect La Fontaine in the 17th century with Viennet in the 19th. None of the links, however, of this chain, with the exception of Jean Pierre Florian (1759-1794) deserve much attention. The universal faculty of Voltaire (1694-1778) showed itself in his poetical productions no less than in his other works, and it is perhaps not least remarkable in verse. It is impossible nowadays to regard the *Henriade* as anything but a highly successful prize poem, but the burlesque epic of *La Pucelle*, discreditable as it may be from the moral point of view, is remarkable enough as literature.

Voltaire
(poetry).

The epistles and satires are among the best of their kind, the verse tales are in the same way admirable, and the epigrams, impromptus, and short miscellaneous poems generally are the *ne plus ultra* of verse which is not poetry. The Anglomania of the century extended into poetry, and the *Seasons* of Thomson set the example of a whole library of tedious descriptive verse, which in its turn revenged France upon England by producing or helping to produce English poems of the Darwin school. The first of these descriptive performances was the *Saisons* of Jean François de Saint-Lambert (1716-1803), identical in title with its model, but of infinitely inferior value. Saint-Lambert was followed by Jacques Delille (1738-1813) in *Les Jardins*, Antoine Marin le Mierre (1723-1793) in *Les Fables*, and Jean Antoine Roucher (1745-1794) in *Les Mois*. Indeed, everything that could be described was seized upon by these describers. Delille also translated the *Georgics*, and for a time was the greatest living poet of France, the title being only disputed by Escouchard le Brun (1729-1807), a lyricist and ode writer of the school of J. B. Rousseau, but not destitute of energy. The only other poets until Chénier who deserve notice are Nicolas Gilbert (1751-1780)—the French Chatterton, or perhaps rather the French Oldham, who died in a workhouse at twenty-nine after producing some vigorous satires and, at the point of death, an elegy of great beauty; Jacques Charles Louis Clinchaut de Malfilâtre (1732-1767), another short-lived poet whose "Ode to the Sun" has a certain stateliness; and Jean Baptiste Gresset (1709-1777), the author of *Ver-Vert* and of other poems of the lighter order, which are not far, if at all, below the level of Voltaire. André Chénier (1762-1794) stands far apart from the art of his century, though the strong chain of custom, and his early death by the guillotine, prevented him from breaking finally through the restraints of its language and its versification. Chénier, half a Greek by blood, was wholly one in spirit and sentiment. The manner of his verses, the very air which surrounds them and which they diffuse, are different from those of the 18th century; and his poetry is probably the utmost that its language and versification could produce. To do more, the revolution which followed a generation after his death was required.

18th-Century Drama.—The results of the cultivation of dramatic poetry at this time were even less individually remarkable than those of the attention paid to poetry proper. Here again the astonishing power and literary aptitude of Voltaire gave value to his attempts in a style which, notwithstanding that it counts Racine among its practitioners, was none the less predestined to failure. Voltaire's own efforts in this kind are indisputably as successful as they could be. Foreigners usually prefer *Mahomet* and *Zaire* to *Bajazet* and *Mithridate*, though there is no doubt that no work of Voltaire's comes up to *Polyeucte* and *Rodogune*, as certainly no single passage in any of his plays can approach the best passages of *Cinna* and *Les Horaces*. But the remaining tragic writers of the century, with the single exception of Crébillon *père*, are scarcely third-rate. C. Jolyot de Crébillon (1674-1762) himself had genius, and there are to be found in his work evidences of a spirit which had seemed to die away with *Saint-Genest*, and was hardly to revive until *Hernani*. Of the imitators of Racine and Voltaire, La Motte in *Inès de Castro* was not wholly unsuccessful. François Joseph de la Grange-Chancel (1677-1758) copied chiefly the worst side of the author of *Britannicus*, and Bernard Joseph Saurin (1706-1781) and Pierre-Laurent de Belloy (1727-1775) performed the same service for Voltaire. Le Mierre and La Harpe, mentioned and to be mentioned, were tragedians; but the *Iphigénie en Tauroïde* of Guimond de la Touche (1725-1760) deserves more special mention than anything of theirs. There was an infinity of tragic writers and tragic plays in this century, but hardly any others of them even deserve mention. The muse of comedy was decidedly more happy in her devotees. Molière was a far safer if a more difficult model than Racine, and the inexorable fashion which had bound down tragedy to a feeble imitation of Euripides did not similarly prescribe an undeviating adherence to Terence. Tragedy had never been, has scarcely been since, anything but an exotic in France; comedy was of this

soil and native. Very early in the century Alain René le Sage (1668-1747), in the admirable comedy of *Turcaret*, produced a work not unworthy to stand by the side of all but his master's best. Philippe Destouches (1680-1754) was also a fertile comedy writer in the early years of the century, and in *Le Glorieux* and *Le Philosophe marié* achieved considerable success. As the age went on, comedy, always apt to lay hold of passing events, devoted itself to the great struggle between the Philosophes and their opponents. Curiously enough, the party which engrossed almost all the wit of France had the worst of it in this dramatic portion of the contest, if in no other. The *Méchant* of Gresset and the *Mitromanie* of Alexis Piron (1680-1773) were far superior to anything produced on the other side, and the *Philosophes* of Charles Palissot de Montenoy (1730-1814), though scurrilous and broadly farcical, had a great success. On the other hand, it was to a Philosophe that the invention of a new dramatic style was due, and still more the promulgation of certain ideas on dramatic criticism and construction, which, after being filtered through the German mind, were to return to France and to exercise the most powerful influence on its dramatic productions.

This was Denis Diderot (1713-1784), the most fertile genius of the century, but also the least productive in finished and perfect work. His chief dramas, the *Fils naturel* and the *Père de famille*, are certainly not great successes; the shorter plays, *Est-il bon? est-il méchant?* and *La Pièce et le prologue*, are better. But it was his follower Michel Jean Sedaine (1719-1797) who, in *Le Philosophe sans le savoir* and other pieces, produced the best examples of the bourgeois as opposed to the heroic drama. Diderot is sometimes credited or discredited with the invention of the *Comédie Larmoyante*, a title which indeed his own plays do not altogether refuse, but this special variety seems to be, in its invention, rather the property of Pierre Claude Nivelle de la Chaussée (1692-1754). Comedy sustained itself, and even gained ground towards the end of the century; the *Jeune Indienne* of Nicolas Chamfort (1741-1794), if not quite worthy of its author's brilliant talent in other paths, is noteworthy, and so is the *Bilan perdu* of Joseph François Edouard de Corsembleu Desmahis (1722-1761), while at the extreme limit of our present period there appears the remarkable figure of Pierre Caron de Beaumarchais (1732-1799). The *Mariage de Figaro* and the *Barbier de Séville* are well known as having had attributed to them no mean place among the literary causes and forerunners of the Revolution. Their dramatic and literary value would itself have sufficed to obtain attention for them at any time, though there can be no doubt that their popularity was mainly due to their political appositeness. The most remarkable point about them, as about the school of comedy of which Congreve was the chief master in England at the beginning of the century, was the abuse and superfluity of wit in the dialogue, indiscriminately allotted to all characters alike. It is difficult to give particulars, but would be improper to omit all mention, of such dramatic or quasi-dramatic work as the libretti of operas, farces for performance at fairs and the like. French authors of the time from Le Sage downwards usually managed these with remarkable skill.

18th-Century Fiction.—With prose fiction the case was altogether different. We have seen how the short tale of a few pages had already in the 16th century attained high if not the highest excellence; how at three different periods the fancy for long-winded prose narration developed itself in the prose renderings of the chivalric poems, in the *Amadis* romances, and in the portentous recitals of Gomberville and La Calprenède; how burlesques of these romances were produced from Rabelais to Scarron; and how at last Madame de Lafayette showed the way to something like the novel of the day. If we add the fairy story, of which Perrault and Madame d'Aulnoy were the chief practitioners, and a small class of miniature romances, of which *Aucassin et Nicolette* in the 13th, and the delightful *Jehan de Paris* (of the 15th or 16th, in which a king of England is patriotically sacrificed) are good representatives, we shall have exhausted the list. The 18th century was quick to develop the system of the author of the *Princesse de Clèves*, but it did not abandon

the cultivation of the romance, that is to say, fiction dealing with incident and with the simpler passions, in devoting itself to the novel, that is to say, fiction dealing with the analysis of sentiment and character. Le Sage, its first great novelist, in his *Diable boiteux* and *Gil Blas*, went to Spain not merely for his subject but also for his inspiration and manner, following the lead of the picaresque romance of Rojas and Scarron. Like Fielding, however, whom he much resembles, Le Sage mingled with the romance of incident the most careful attention to character and the most lively portrayal of it, while his style and language are such as to make his work one of the classics of French literature. The novel of character was really founded in France by the abbé Prévost d'Exilles (1697-1763), the author of *Cleveland* and of the incomparable *Manon Lescaut*. The popularity of this style was much helped by the immense vogue in France of the works of Richardson. Side by side with it, however, and for a time enjoying still greater popularity, there flourished a very different school of fiction, of which Voltaire, whose name occupies the first or all but the first place in every branch of literature of his time, was the most brilliant cultivator. This was a direct development of the earlier *conte*, and consisted usually of the treatment, in a humorous, satirical, and not always over-decent fashion, of contemporary foibles, beliefs, philosophies and occupations. These tales are of every rank of excellence and merit both literary and moral, and range from the astonishing wit, grace and humour of *Candide* and *Zadig* to the book which is Diderot's one hardly pardonable sin, and the similar but more lively efforts of Crébillon fils (1707-1777). These latter deeps led in their turn to the still lower depths of La Clos and Louvet. A third class of 18th-century fiction consists of attempts to return to the humorous *satyrasie* of the 16th century, attempts which were as much influenced by Sterne as the sentimental novel was by Richardson. The *Hommes aux quarante écus* of Voltaire has something of this character, but the most characteristic works of the style are the *Jacques le fataliste* of Diderot, which shows it nearly at its best, and the *Compère Mathieu*, sometimes attributed to Pigault-Lebrun (1753-1835), but no doubt in reality due to Jacques du Laurens (1719-1797), which shows it at perhaps its worst. Another remarkable story-teller was Cazotte (1719-1792), whose *Diable amoureux* displays much fantastic power, and connects itself with a singular fancy of the time for occult studies and *diablerie*, manifested later by the patronage shown to Cagliostro, Mesmer, St Germain and others. In this connexion, too, may perhaps also be mentioned most appropriately Bestif de la Bretonne, a remarkably original and voluminous writer, who was little noticed by his contemporaries and successors for the best part of a century. Restif, who was nicknamed the "Rousseau of the gutter," *Rousseau du ruisseau*, presents to an English imagination many of the characteristics of a non-moral Defoe. While these various schools busied themselves more or less with real life seriously depicted or purposely travestied, the great vogue and success of *Télémaque* produced a certain number of didactic works, in which moral or historical information was sought to be conveyed under a more or less thin guise of fiction. Such was the *Voyage du jeune Anacharsis* of Jean Jacques Barthélémy (1716-1795); such the *Numa Pompilius* and *Gonzalve de Cordoue* of Florian (1755-1794), who also deserves notice as a writer of pastorals, fables and short prose tales; such the *Bélisaire* and *Les Incas* of Jean François Marmontel (1733-1799). Between this class and that of the novel of sentiment may perhaps be placed *Paul et Virginie*, and *La Chaumière indienne*; though Bernardin de Saint-Pierre (1737-1814) should more properly be noticed after Rousseau and as a moralist. Diderot's fiction-writing has already been referred to more than once, but his *Religieuse* deserves citation here as a powerful specimen of the novel both of analysis and polemic; while his undoubted masterpiece, the *Nevus de Rameau*, though very difficult to class, comes under this head as well as under any other. There are, however, two of the novelists of this age, and of the most remarkable, who have yet to be noticed, and these are the author of *Marianne* and the author of *Julie*. We do

not mention Pierre de Marivaux (1688-1763) in this connexion as the equal of Jean Jacques Rousseau (1712-1778), but merely as being in his way almost equally original and equally remote from any suspicion of school influence. He began with burlesque writing, and was also the author of several comedies, of which *Les Fausses Confidences* is the principal. But it is in prose fiction that he really excels. He may claim to have, at least in the opinion of his contemporaries, invented a style, though perhaps the term *marivaudage*, which was applied to it, has a not altogether complimentary connotation. He may claim also to have invented the novel without a purpose, which aims simply at amusement, and at the same time does not seek to attain that end by buffoonery or by satire. Gray's definition of happiness, "to lie on a sofa and read endless novels by Marivaux" (it is true that he added Crébillon), is well known, and the production of mere pastime by means more or less harmless has since become so well-recognized a function of the novelist that Marivaux, as one of the earliest to discharge it, deserves notice. The name,

however, of Jean Jacques Rousseau is of far different importance. His two great works, the *Nouvelle Héloïse* and *Émile*, are as far as possible from being perfect as novels. But no novels in the world have ever had such influence as these. To a great extent this influence was due mainly to their attractions as novels, imperfect though they may be in this character, but it was beyond dispute also owing to the doctrines which they contained, and which were exhibited in novel form.

Such are the principal developments of fiction during the century; but it is remarkable that, varied as they were, and excellent as was some of the work to which they gave rise, none of these schools was directly very fertile in results or successors. The period with which we shall next have to deal, that from the outbreak of the Revolution to the death of Louis XVIII., is curiously barren of fiction of any merit. It was not till English influence began again to assert itself in the later days of the Restoration that the prose romance began once more to be written.

18th-Century History.—It is not, however, in any of the departments of *belles-lettres* that the real eminence of the 18th century as a time of literary production in France consists. In all serious branches of study its accomplishments were, from a literary point of view, remarkable, uniting as it did an extraordinary power of popular and literary expression with an ardent spirit of inquiry, a great speculative ability, and even a far more considerable amount of laborious erudition than is generally supposed. The historical studies and results of 18th-century speculation in France are of especial and peculiar importance. There is no doubt that what is called the science of history dates from this time, and though the beginning of it is usually assigned to the Italian Vico, its complete indication may perhaps with equal or greater justice be claimed by the Frenchman Turgot. Before Turgot, however, there were great names in French historical writing, and perhaps the greatest of all is that of Charles Secondat de Montesquieu (1689-1755). The three principal works of this great writer are all historical and at the same time political in character. In the *Lettres persanes* he handled, with wit inferior to the wit of no other writer even in that witty age, the corruptions and dangers of contemporary morals and politics. The literary charm of this book—the plan of which was suggested by a work, the *Amusements sérieux et comiques*, of Dufresny (1648-1724), a comic writer not destitute of merit—is very great, and its plan was so popular as to lead to a thousand imitations, of which all, except those of Voltaire and Goldsmith, only bring out the immense superiority of the original. Few things could be more different from this lively and popular book than Montesquieu's next work, the *Grandeur et décadence des Romains*, in which the same acuteness and knowledge of human nature are united with considerable erudition, and with a weighty though perhaps somewhat grandiloquent and rhetorical style. His third and greatest work, the *Esprit des lois*, is again different both in style and character, and such defects as it has are as nothing when compared with the merits

of its fertility in ideas, its splendid breadth of view, and the felicity with which the author, in a manner unknown before, recognizes the laws underlying complicated assemblages of fact. The style of this great work is equal to its substance; less light than that of the *Lettres*, less rhetorical than that of the *Grandeur des Romains*, it is still a marvellous union of dignity and wit. Around Montesquieu, partly before and partly after him, is a group of philosophical or at least systematic historians, of whom the chief are Jean Baptiste Dubos (1670-1742), and G. Bonnot de Mably (1709-1785). Dubos, whose chief work is not historical but aesthetic (*Réflexions sur la poésie et la peinture*), wrote a so-called *Histoire critique de l'établissement de la monarchie française*, which is as far as possible from being in the modern sense critical, inasmuch as, in the teeth of history, and in order to exalt the *Tiers état*, it pretends an amicable coalition of Franks and Gauls, and not an irruption by the former. Mably (*Observations sur l'histoire de la France*) had a much greater influence than either of these writers, and a decidedly mischievous one, especially at the period of the Revolution. He, more than any one else, is responsible for the ignorant and childish extolling of Greek and Roman institutions, and the still more ignorant depreciation of the middle ages, which was for a time characteristic of French politicians. Montesquieu was, as we have said, followed by Anne Robert Jacques Turgot (1727-1781), whose writings are few in number, and not remarkable for style, but full of original thought. Turgot in his turn was followed by Condorcet (1743-1794), whose tendency is somewhat more sociological than directly historical. Towards the end of the period, too, a considerable number of philosophical histories were written, the usual object of which was, under cover of a kind of allegory, to satirize and attack the existing institutions and government of France. The most famous of these was the *Histoire des Indes*, nominally written by the Abbé Guillaume Thomas François Raynal (1713-1796), but really the joint work of many members of the Philosophie party, especially Diderot. Side by side with this really or nominally philosophical school of history there existed another and less ambitious school, which contented itself with the older and simpler view of the science. The Abbé René de Vertot (1655-1735) belongs almost as much to the 17th as to the 18th century; but his principal works, especially the famous *Histoire des Chevaliers de Malte*, date from the later period, as do also the *Révolutions romaines*. Vertot is above all things a literary historian, and the well-known "Mon siège est fait," whether true or not, certainly expresses his system. Of the same school, though far more comprehensive, was the laborious Charles Rollin (1661-1741), whose works in the original, or translated and continued in the case of the *Histoire romaine* by Jean Baptiste Louis Crévier (1693-1765), were long the chief historical manuals of Europe. The president Charles Jean François Hénault (1685-1770), and Louis Pierre Anquetil (1723-1806) were praiseworthy writers, the first of French history, the second of that and much else. In the same class, too, far superior as is his literary power, must be ranked the historical works of Voltaire, *Charles XII*, *Pierre le Grand*, &c. A very perfect example of the historian who is literary first of all is supplied by Claude Carlotan de Rulhière (1735-1791), whose *Révolution en Russie en 1762* is one of the little masterpieces of history, while his larger and posthumous work on the last days of the Polish kingdom exhibits perhaps some of the defects of this class of historians. Lastly must be mentioned the memoirs and correspondence of the period, the materials of history if not history itself. The century opened with the most famous of all these, the memoirs of the duc de Saint-Simon (1675-1755), an extraordinary series of pictures of the court of Louis XIV. and the Regency, written in an unequal and incorrect style, but with something of the irregular excellence of the great 16th-century writers, and most striking in the sombre bitterness of its tone. The subsequent and less remarkable memoirs of the century are so numerous that it is almost impossible to select a few for reference, and altogether impossible to mention all. Of those bearing on public history the memoirs of Madame de Staël (Mlle Delaunay) (1684-1750), of Fleury

Louis de Voyer, marquis d'Argenson (1694-1757), of Charles Pinot Duclos (1704-1772), of Stephanie Félicité de Saint-Aubin, Madame de Genlis (1746-1830), of Pierre Victor de Bénéval (1722-1791), of Madame Campan (1752-1822) and of the cardinal de Bernis (1715-1794), may perhaps be selected for mention; of those bearing on literary and private history, the memoirs of Madame d'Épinay (1726-1783), those of Mathieu Marais (1664-1737) the so-called *Mémoires secrets* of Louis Petit de Bachaumont (1690-1770), and the innumerable writings having reference to Voltaire and to the Philosophe party generally. Here, too, may be mentioned a remarkable class of literature, consisting of purely private and almost confidential letters, which were written at this time with very remarkable literary excellence. As specimens may be selected those of Mademoiselle Aissé (1694-1757), which are models of easy and unaffected tenderness, and those of Mademoiselle de Lespinasse (1732-1776) the companion of Madame du Deffand and afterwards of d'Alembert. These latter, in their extraordinary fervour and passion, not merely contrast strongly with the generally languid and frivolous gallantry of the age, but also constitute one of its most remarkable literary monuments. It has been said of them that they "burn the paper," and the expression is not exaggerated. Madame du Deffand's (1697-1780) own letters, many of which were written to Horace Walpole, are noteworthy in a very different way. Of lighter letters the charming correspondence of Diderot with Mademoiselle Voland deserves special mention. But the correspondence, like the memoirs of this century, defies justice to be done to it in any cursory or limited mention. In this connexion, however, it may be well to mention some of the most remarkable works of the time, the *Confessions*, *Rêveries*, and *Promenades d'un solitaire* of Rousseau. In these works, especially in the *Confessions*, there is not merely exhibited passion as fervid though perhaps less unaffected than that of Mademoiselle de Lespinasse—there appear in them two literary characteristics which, if not entirely novel, were for the first time brought out deliberately by powers of the first order, were for the first time made the mainspring of literary interest, and thereby set an example which for more than a century has been persistently followed, and which has produced some of the finest results of modern literature. The first of these was the elaborate and unsparing analysis and display of the motives, the weaknesses and the failings of individual character. This process, which Rousseau unflinchingly performed on himself, has been followed usually in respect to fictitious characters by his successors. The other novelty was the feeling for natural beauty and the elaborate description of it, the credit of which latter must, it has been agreed by all impartial critics, be assigned rather to Rousseau than to any other writer. His influence in this direction was, however, soon taken up and continued by Bernardin de Saint-Pierre, the connecting link between Rousseau and Chateaubriand, some of whose works have been already alluded to. In particular the author of *Paul et Virginie* set himself to develop the example of description which Rousseau had set, and his word-paintings, though less powerful than those of his model, are more abundant, more elaborate, and animated by a more amiable spirit.

18th-Century Philosophy.—The Anglomania which distinguished the time was nowhere more stongly shown than in the cast and direction of its philosophical speculations. As Montesquieu and Voltaire had imported into France a vivid theoretical admiration for the British constitution and for British theories in politics, so Voltaire, Diderot and a crowd of others popularized and continued in France the philosophical ideas of Hobbes and Locke and even Berkeley, the theological ideas of Bolingbroke, Shaftesbury and the English deists, and the physical discoveries of Newton. Descartes, Frenchman and genius as he was, and though his principles in physics and philosophy were long clung to in the schools, was completely abandoned by the more adventurous and progressive spirits. At no time indeed, owing to the confusion of thought and purpose to which we have already alluded, was the word philosophy used with greater looseness than at this time. Using it, as we have hitherto used it, in the sense of metaphysics, the majority of the Philosophes have very

little claim to their title. There were some who manifested, however, an aptitude for purely philosophical argument, and one who confined himself strictly thereto. Among these the most remarkable are Julien Offroy de la Mettrie (1709-1751) and Denis Diderot. La Mettrie in his works *L'Homme machine*, *L'Homme plante*, &c., applied a lively and vigorous imagination, a considerable familiarity with physics and medicine, and a brilliant but unequal style, to the task of advocating materialistic ideas on the constitution of man. Diderot, in a series of early works, *Lettre sur les aveugles*, *Promenade d'un sceptique*, *Pensées philosophiques*, &c., exhibited a good acquaintance with philosophical history and opinion, and gave sign in this direction, as in so many others, of a far-reaching intellect. As in almost all his works, however, the value of the thought is extremely unequal, while the different pieces, always written in the hottest haste, and never duly matured or corrected, present but few specimens of finished and polished writing. Charles Bonnet (1720-1793), a Swiss of Geneva, wrote a large number of works, many of which are purely scientific. Others, however, are more psychological, and these, though advocating the materialistic philosophy generally in vogue, were remarkable for uniting materialism with an honest adherence to Christianity. The half mystical writer, Louis Claude de Saint-Martin (1743-1803) also deserves notice. But the French metaphysician of the century is undoubtedly Étienne Bonnot, abbé de Condillac (1714-1780), almost the only writer of the time in France who succeeded in keeping strictly to philosophy without attempting to pursue his system to its results in ethics, politics and theology. In the *Traité des sensations*, the *Essai sur l'origine des connaissances humaines* and other works Condillac elaborated and continued the imperfect sensationalism of Locke. As his philosophical view, though perhaps more restricted, was far more direct, consecutive and uncompromising than that of the Englishman, so his style greatly exceeded Locke's in clearness and elegance and as a good medium of philosophical expression.

18th-Century Theology.—To devote a section to the history of the theological literature of the 18th century in France may seem something of a contradiction; for, indeed, all or most of such literature was anti-theological. The magnificent list of names which the church had been able to claim on her side in the 17th century was exhausted before the end of the second quarter of the 18th with Massillon, and none came to fill their place. Very rarely has orthodoxy been so badly defended as at this time. The literary championship of the church was entirely in the hands of the Jesuits, and of a few disreputable literary free-lances like Elie Fréron (1710-1776) and Pierre Francois Guyot, abbé Desfontaines (1685-1745). The Jesuits were learned enough, and their principal journal, that of Trévoux, was conducted with much vigour and a great deal of erudition. But they were in the first place discredited by the moral taint which has always hung over Jesuitism, and in the second place by the persecutions of the Jansenists and the Protestants, which were attributed to their influence. But one single work on the orthodox side has preserved the least reputation; while, on the other hand, the names of Père Nonotte (1711-1793) and several of his fellows have been enshrined unenviably in the imperishable ridicule of Voltaire, one only of whose adversaries, the abbé Antoine Guénée (1717-1803), was able to meet him in the *Lettres de quelques Juifs* with something like his own weapons. It has never been at all accurately decided how far what may be called the scoffing school of Voltaire represents a direct revolt against Christianity, and how far it was merely a kind of guerrilla warfare against the clergy. It is positively certain that Voltaire was not an atheist, and that he did not approve of atheism. But his *Dictionnaire philosophique*, which is typical of a vast amount of contemporary and subsequent literature, consists of a heterogeneous assemblage of articles directed against various points of dogma and ritual and various characteristics of the sacred records. From the literary point of view, it is one of the most characteristic of all Voltaire's works, though it is perhaps not entirely his. The desultory arrangement, the light

and lively style, the extensive but not always too accurate erudition, and the somewhat captious and quibbling objections, are intensely Voltairian. But there is little seriousness about it, and certainly no kind of rancorous or deep-seated hostility. With many, however, of Voltaire's pupils and younger contemporaries the case was altered. They were distinctively atheists and anti-superaturalists. The atheism of Diderot, unquestionably the greatest of them all, has been keenly debated; but in the case of Étienne Damienville (1723-1768), Jacques André Naigeon (1738-1810), Paul Henri Dietrich, baron d'Holbach, and others there is no room for doubt. By these persons a great mass of atheistic and anti-Christian literature was composed and set afloat. The characteristic work of this school, its last word indeed, is the famous *Système de la nature*, attributed to Holbach (1723-1789), but known to be, in part at least, the work of Diderot. In this remarkable work, which caps the climax of the metaphysical materialism or rather nihilism of the century, the atheistic position is clearly put. It made an immense sensation; and it so flattered not merely the orthodox but the more moderate free-thinkers, that Frederick of Prussia and Voltaire, perhaps the most singular pair of defenders that orthodoxy ever had, actually set themselves to refute it. Its style and argument are very unequal, as books written in collaboration are apt to be, and especially books in which Diderot, the paragon of inequality, had a hand. But there is an almost entire absence of the heterogeneous assemblage of anecdotes, jokes good and bad, scraps of accurate or inaccurate physical science, and other incongruous matter with which the Philosophes were wont to stuff their works; and lastly, there is in the best passages a kind of sombre grandeur which recalls the manner as well as the matter of Lucretius. It is perhaps well to repeat, in the case of so notorious a book, that this criticism is of a purely literary and formal character; but there is little doubt that the literary merits of the work considerably assisted its didactic influence. As the Revolution approached, and the victory of the Philosophes party was declared, there appeared for a brief space a group of cynical and accomplished phrase-makers presenting some similarity to that of which, a hundred years before, Saint-Evremond was the most prominent figure. The chief of this group were

Nicolas Chamfort (1747-1794) on the republican side, and Antoine Rivarol (1753-1801) on that of the royalists.

Like the older writer to whom we have compared them, neither can be said to have produced any one work of eminence, and in this they stand distinguished from moralists like La Rochefoucauld. The floating sayings, however, which are attributed to them, or which occur here and there in their miscellaneous work, yield in no respect to those of the most famous of their predecessors in wit and a certain kind of wisdom, though they are frequently more personal than aphoristic.

18th-Century Moralists and Politicians.—Not the least part, however, of the energy of the period in thought and writing was devoted to questions of a directly moral and political kind. With regard to morality proper the favourite doctrine of the century was what is commonly called the selfish theory, the only one indeed which was suitable to the sensationalism of Condillac and the materialism of Holbach. The pattern book of this doctrine was the *De l'esprit* of Claude Adrien Helvétius

(1715-1771), the most amusing book perhaps which ever pretended to the title of a solemn philosophical treatise. There is some analogy between the principles of this work and those of the *Système de la nature*. With the inconsistency—some would say with the questionable honesty—which distinguished the more famous members of the Philosophes party when their disciples spoke with what they considered imprudent outspokenness, Voltaire and even Diderot attacked Helvétius as the former afterwards attacked Holbach. But whatever may be the general value of *De l'esprit*, it is full of acuteness, though

that acuteness is as desultory and disjointed as its style. As Helvétius may be taken as the representative author of the cynical school, so perhaps Alexandre Gérard Thomas (1732-1785) may be taken as representative of the

votaries of noble sentiment to whom we have also alluded. The works of Thomas chiefly took the form of academic *éloges* or formal panegyrics, and they have all the defects, both in manner and substance, which are associated with that style. Of yet a third school, corresponding in form to La Rochefoucauld and La Bruyère, and possessed of some of the antique vigour of preceding centuries, was Luc de Clapiers, marquis de Vauvenargues (1715-1747). This writer, who died very young, has produced maxims and reflections of considerable mental force and literary finish. From

Vauvenargues.

Voltaire downwards it has been usual to compare him with Pascal, from whom he is chiefly distinguished by a striking but somewhat empty stoicism. Between the moralists, of whom we have taken these three as examples, and the politicians may be placed Rousseau, who in his novels and miscellaneous works is of the first class, in his famous *Contrat social* of the second. All his theories, whatever their originality and whatever their value, were made novel and influential by the force of their statement and the literary beauties of its form. Of direct and avowed political writings there were few during the century, and none of anything like the importance of the *Contrat social*, theoretical acceptance of the established French constitution being a point of necessity with all Frenchmen. Nevertheless it may be said that almost the whole of the voluminous writings of the Philosophes, even of those who, like Voltaire, were sincerely aristocratic and monarchic in predilection, were of more or less veiled political significance. There was one branch of political writing, moreover, which could be indulged in without much fear. Political economy and administrative theories received much attention. The earliest writer of eminence on these subjects was the great engineer Sébastien le Prestre, marquis de Vauban (1633-1707), whose *Orisettes* and *Dame royale* exhibit both great ability and extensive observation. A more utopian economist of the same time was Charles Iréné Castel, abbé de Saint-Pierre (1658-1743), not to be confounded with the author of *Paul et Virginie*. Soon political economy in the hands of François Quesnay (1694-1774) took a regular form, and towards the middle of the century a great number of works on questions connected with it, especially that of free trade in corn, on which Ferdinand Galliani (1728-1787), André Morellet (1727-1819), both abbés, and above all Turgot, distinguished themselves. Of writers on legal subjects and of the legal profession, the century, though not less fertile than in other directions, produced few or none of any great importance from the literary point of view. The chief name which in this connexion is known is that of Chancellor Henri François d'Aguesseau (1668-1751), at the beginning of the century, an estimable writer of the Port Royal school, who took the orthodox side in the great disputes of the time, but failed to display any great ability therein. He was, as became his profession, more remarkable as an orator than a writer, and his works contain valuable testimonies to the especially perturbed and unquiet condition of his century—a disquiet which is perhaps also its chief literary note. There were other French magistrates, such as Montesquieu, Hénault (1685-1770), de Brosses (1706-1773) and others, who made considerable mark in literature; but it was usually (except in the case of Montesquieu) in subjects not even indirectly connected with their profession. The *Esprit des lois* stands alone; but as an example of work barristerial in kind, famous partly for political reasons but of some real literary merit, we may mention the *Mémoire* for Calas written by J. B. J. Élie de Beaumont (1732-1786).

18th-Century Criticism and Periodical Literature.—We have said that literary criticism assumes in this century a sufficient importance to be treated under a separate heading. Contributions were made to it of many different kinds and from many different points of view. Periodical literature, the chief stimulus to its production, began more and more to come into favour. Even in the 17th century the *Journal des sçavants*, the Jesuit *Journal de Trévoux*, and other publications had set the example of different kinds of it. Just before the Revolution the *Gazette de France* was in the hands of J. B. A. Suard (1734-1817), a man who was nothing if not a literary critic. Perhaps, however, the most

remarkable contribution of the century to criticism of the periodical kind was the *Feuilles de Grimm*, a circular sent for many years to the German courts by Frédéric Melchior Grimm (1733-1807), the comrade of Diderot and Rousseau, and containing a *compte rendu* of the ways and works of Paris, literary and artistic as well as social. These *Leaves* not only include much excellent literary criticism by Diderot, but also gave occasion to the incomparable *salons* or accounts of the exhibition of pictures from the same hand, essays which founded the art of picture criticism, and which have hardly been surpassed since. The prize competitions of the Academy were also a considerable stimulus to literary criticism, though the prevailing taste in such compositions rather inclined to elegant themes than to careful studies of analyses. The most characteristic critic of the mid-century was the abbé Charles Batteux (1713-1780) who illustrated a tendency of the time by beginning with a treatise on *Les Beaux Arts réduits à un même principe* (1746); reduced it and others into *Principes de la littérature* (1764) and added in 1771 *Les Quatres Poétiques* (Aristotle, Horace, Vida and Boileau). Batteux is a very ingenious critic and his attempt to conciliate "taste" and "the rules," though inadequate, is interesting. Works on the arts in general or on special divisions of them were not wanting, as, for instance, that of Dubos before alluded to, the *Essai sur la peinture* of Diderot and others. Critically annotated editions of the great French writers also came into fashion, and were no longer written by mere pedants. Of these Voltaire's edition of Corneille was the most remarkable, and his annotations, united separately under the title of *Commentaire sur Corneille*, form not the least important portion of his works. Even older writers, looked down upon though they were by the general taste of the day, received a share of this critical interest. In the earlier portion of the century Nicolas Lenglet-Dufresnoy (1674-1755) and Bernard de la Monnoye (1641-1728) devoted their attention to Rabelais, Regnier, Villon, Marot and others. Étienne Barbazan (1696-1770) and P. J. B. Le Grand d'Aussy (1737-1800) gathered and brought into notice the long scattered and unknown rather than neglected fabliaux of the middle ages. Even the chansons de geste attracted the notice of the Comte de Caylus (1692-1765) and the Comte de Tressan (1705-1783). The latter, in his *Bibliothèque des romans*, worked up a large number of the old epics into a form suited to the taste of the century. In his hands they became lively tales of the kind suited to readers of Voltaire and Crébillon. But in this travestied form they had considerable influence both in France and abroad. By these publications attention was at least called to early French literature, and when it had been once called, a more serious and appreciative study became merely a matter of time. The method of much of the literary criticism of the close of this period was indeed deplorable enough. Jean François de la Harpe (1739-1803), who though a little later in time as to most of his critical productions is perhaps its most representative figure, shows criticism in one of its worst forms. The critic specially abhorred by Sterne, who looked only at the stop-watch, was a kind of prophecy of La Harpe, who lays it down distinctly that a beauty, however beautiful, produced in spite of rules is a "monstrous beauty" and cannot be allowed. But such a writer is a natural enough expression of an expiring principle. The year after the death of La Harpe Sainte-Beuve was born.

18th-Century Savants.—In science and general erudition the 18th century in France was at first much occupied with the mathematical studies for which the French genius is so peculiarly adapted, which the great discoveries of Descartes had made possible and popular, and which those of his supplanter Newton only made more popular still. Voltaire took to himself the credit, which he fairly deserves, of first introducing the Newtonian system into France, and it was soon widely popular—even ladies devoting themselves to the exposition of mathematical subjects, as in the case of Gabrielle de Breteuil, marquise du Châtelet (1706-1749) Voltaire's "divine Émilie." Indeed ladies played a great part in the literary and scientific activity of the century, by actual contribution sometimes, but still more by continuing and extending the tradition of "salons." The duchesse du

Maine, Mesdames de Lambert, de Tencin, Geoffrin, du Deffand, Necker, and above all, the baronne d'Holbach (whose husband, however, was here the principal personage) presided over coteries which became more and more "philosophical." Many of the greatest mathematicians of the age, such as de Moivre and Laplace, were French by birth, while others like Euler belonged to French-speaking races, and wrote in French. The physical sciences were also ardently cultivated, the impulse to them being given partly by the generally materialistic tendency of the age, partly by the Newtonian system, and partly also by the extended knowledge of the world provided by the circumnavigatory voyage of Louis Antoine de Bougainville (1729-1811), and other travels. P. L. de Moreau Maupertuis (1698-1759) and C. M. de la Condamine (1701-1774) made long journeys for scientific purposes and duly recorded their experiences. The former, a mathematician and physicist of some ability but more oddity, is chiefly known to literature by the ridicule of Voltaire in the *Diatrise du Docteur Akakia*. Jean le Rond, called d'Alembert (1717-1783), a great mathematician and a writer of considerable though rather academic excellence, is principally known from his connexion with and introduction to the *Encyclopédie*, of which more presently. Chemistry was also assiduously cultivated, the baron d'Holbach, among others, being a devotee thereof, and helping to advance the science to the point where, at the conclusion of the century, it was illustrated by Berthollet and Lavoisier. During all this devotion to science in its modern acceptance, the older and more literary forms of erudition were not neglected, especially by the illustrious Benedictines of the abbey of St Maur. Dom Augustin Calmet (1672-1757) the author of the well-known *Dictionary of the Bible*, belonged to this order, and to them also (in particular to Dom Rivet) was due the beginning of the immense *Histoire littéraire de la France*, a work interrupted by the Revolution and long suspended, but diligently continued since the middle of the 19th century. Of less orthodox names distinguished for erudition, Nicolas Fréret (1688-1749), secretary of the Academy, is perhaps the most remarkable. But in the consideration of the science and learning in the 18th century from a literary point of view, there is one name and one book which require particular and, in the case of the book, somewhat extended mention. The man is Georges Louis Leclerc, comte de Buffon (1717-1788), the book the *Encyclopédie*. The immense *Natural History* of Buffon, though not entirely his own, is a remarkable monument of the union of scientific tastes with literary ability.

As has happened in many similar instances, there is in parts more literature than science to be found in it; and from the point of view of the latter, Buffon was far too careless in observation and far too solicitous of perfection of style and grandiosity of view. The style of Buffon has sometimes been made the subject of the highest eulogy, and it is at its best admirable; but one still feels in it the fault of all serious French prose in this century before Rousseau—the presence, that is to say, of an artificial spirit rather than of natural variety and power. The *Encyclopédie*, unquestionably on the whole the most important French literary production of the century, if we except the works of Rousseau and Voltaire, was conducted for a time by Diderot and d'Alembert, afterwards by Diderot alone. It numbered among its contributors almost every Frenchman of eminence in letters. It is often spoken of as if, under the guise of an encyclopaedia, it had been merely a *paideia* against religion, but this is entirely erroneous. Whatever anti-ecclesiastical bent some of the articles may have, the book as a whole is simply what it professes to be, a dictionary—that is to say, not merely an historical and critical lexicon, like those of Bayle and Moreri (indeed history and biography were nominally excluded), but a dictionary of arts, sciences, trades and technical terms. Diderot himself had perhaps the greatest faculty of any man that ever lived for the literary treatment in a workman-like manner of the most heterogeneous and in some cases rebellious subjects; and his untiring labour, not merely in writing original articles, but in editing the contributions of others, determined the character of the whole work. There is no doubt that it had,

quite independently of any theological or political influence, an immense share in diffusing and gratifying the taste for general information.

1789-1830—*General Sketch*.—The period which elapsed between the outbreak of the Revolution and the accession of Charles X. has often been considered a sterile one in point of literature. As far as mere productiveness goes, this judgment is hardly correct. No class of literature was altogether neglected during these stirring five-and-thirty years, the political events of which have so engrossed the attention of posterity that it has sometimes been necessary for historians to remind us that during the height of the Terror and the final disasters of the empire the theatres were open and the booksellers' shops patronized. Journalism, parliamentary eloquence and scientific writing were especially cultivated, and the former in its modern sense may almost be said to have been created. But of the higher products of literature the period may justly be considered to have been somewhat barren. During the earlier part of it there is, with the exception of André Chénier, not a single name of the first or even second order of excellence. Towards the midst those of Chateaubriand (1768-1848) and Madame de Staël (1766-1817) stand almost alone; and at the close those of Courier, Béranger and Lamartine are not seconded by any others to tell of the magnificent literary burst which was to follow the publication of *Cromwell*. Of all departments of literature, poetry proper was most represented during this period. André Chénier was silenced at its opening by the guillotine. Le Brun and Delille, favoured by an extraordinary longevity, continued to be admired and followed. It was the palmy time of descriptive poetry. Louis, marquis de Fontanes (1757-1821, who deserves rather more special notice as a critic and an official patron of literature), Castel, Boisjolin, Esmenard, Bérchoux, Ricard, Martin, Gudin, Cournaud, are names which chiefly survive as those of the authors of scattered attempts to turn the Encyclopædia into verse. Charles Julien de Chénédolle (1769-1833) owes his reputation rather to amiability, and to his association with men eminent in different ways, such as Rivarol and Joubert, than to any real power. He has been regarded as a precursor of Lamartine; but the resemblance is chiefly on Lamartine's weakest side; and the stress laid on him recently, as on Lamartine himself and even on Chénier, is part of a passing reaction against the school of Hugo. Even more ambitiously, Luce de Lancival, Campenon, Dumesnil and Parseval de Grand-Maison endeavoured to write epics, and succeeded rather worse than the Chapelains and Desmarests of the 17th century. The characteristic of all this poetry was the description of everything in metaphor and paraphrase, and the careful avoidance of anything like directness of expression; and the historians of the Romantic movement have collected many instances of this absurdity. Lamartine will be more properly noticed in the next division. But about the same time as Lamartine, and towards the end of the present period, there appeared a poet who may be regarded as the last important echo of Malherbe. This was Casimir Delavigne (1793-1843), the author of *Les Messéniennes*, a writer of very great talent, and, according to the measure of J. B. Rousseau and Lebrun, no mean poet. It is usual to reckon Delavigne as transitional between the two schools, but in strictness he must be counted with the classicists. Dramatic poetry exhibited somewhat similar characteristics. The system of tragedy writing had become purely mechanical, and every act, almost every scene and situation, had its regular and appropriate business and language, the former of which the poet was not supposed to alter at all, and the latter only very slightly. Poinset, La Harpe, M. J. Chénier, Raynouard, de Jouy, Briffaut, Baour-Lormian, all wrote in this style. Of these Chénier (1764-1811) had some of the vigour of his brother André, from whom he was distinguished by more popular political principles and better fortune. On the other hand, Jean François Ducis (1733-1816), who passes with Englishmen as a feeble reducer of Shakespeare to classical rules, passed with his contemporaries as an introducer into French poetry of strange and revolutionary novelties. Comedy, on the other hand, fared better, as indeed

it had always fared. Fabre d'Églantine (1755-1794) (the companion in death of Danton), Collin d'Harleville (1755-1806), François G. J. S. Andrieux (1759-1833), Picard, Alexandre Duval, and Népomucène Lemercier (1771-1840) (the most vigorous of all as a poet and a critic of mark) were the comic authors of the period, and their works have not suffered the complete eclipse of the contemporary tragedies which in part they also wrote. If not exactly worthy successors of Molière, they are at any rate not unworthy children of Beaumarchais. In romance writing there is again, until we come to Madame de Staël, a great want of originality and even of excellence in workmanship. The works of Madame de Genlis (1746-1830) exhibit the tendencies of the 18th century to platitude and noble sentiment at their worst. Madame Cottin (1770-1807), Madame de Souza (1761-1836), and Madame de Krudener, exhibited some of the qualities of Madame de Lafayette and more of those of Madame de Genlis. Joseph Fiévée (1767-1830), in *Le Docteur Susette* and other works, showed some power over the domestic story; but perhaps the most remarkable work in point of originality of the time was Xavier de Maistre's (1763-1852) *Voyage autour de ma chambre*, an attempt in quite a new style, which has been happily followed up by other writers. Turning to history we find comparatively little written at this period. Indeed, until quite its close, men were too much occupied in making history to have time to write it. There is, however, a considerable body of memoir writers, especially in the earlier years of the period, and some great names appear even in history proper. Many of Sismondi's (1773-1842) best works were produced during the empire. A. G. P. Brugière, baron de Barante (1782-1866), though his best-known works date much later, belongs partially to this time. On the other hand, the production of philosophical writing, especially in what we may call applied philosophy, was considerable. The sensationalist views of Condillac were first continued as by Destutt de Tracy (1754-1836) and Laromiguière (1756-1837) and subsequently opposed, in consequence partly of a religious and spiritualist revival, partly of the influence of foreign schools of thought, especially the German and the Scotch. The chief philosophical writers from this latter point of view were Pierre Paul Royer Collard (1763-1845), F. P. G. Maine de Biran (1776-1824), and Théodore Simon Jouffroy (1796-1842). Their influence on literature, however, was altogether inferior to that of the reactionist school, of whom Louis Gabriel, vicomte de Bonald (1754-1840), and Joseph de Maistre (1753-1821) were the great leaders. These latter were strongly political in their tendencies, and political philosophy received, as was natural, a large share of the attention of the time. In continuation of the work of the Philosophes, the most remarkable writer was Constantin François Chasseboeuf, comte de Volney (1757-1820), whose *Ruines* are generally known. On the other hand, others belonging to that school, such as Necker and Morellet, wrote from the moderate point of view against revolutionary excesses. Of the reactionists Bonald is extremely royalist, and carries out in his *Législations primitives* somewhat the same patriarchal and absolutist theories as our own Filmer, but with infinitely greater genius. As Bonald is royalist and aristocratic, so Maistre is the advocate of a theocracy pure and simple, with the pope for its earthly head, and a vigorous despotism for its system of government. Pierre Simon Ballanche (1776-1847), often mentioned in the literary memoirs of his time, wrote among other things *Essais de palingénésie sociale*; good in style but vague in substance. Of theology proper there is almost necessarily little or nothing, the clergy being in the earlier period proscribed, in the latter part kept in a strict and somewhat discreditable subjection by the Empire. In moralizing literature there is one work of the very highest excellence, which, though not published till long afterwards, belongs in point of composition to this period. This is the *Pensées* of Joseph Joubert (1754-1824), the most illustrious successor of Pascal and Vauvenargues, and to be ranked perhaps above both in the literary finish of his maxims, and certainly above Vauvenargues in the breadth and depth of thought which

they exhibit. In pure literary criticism more particularly, Joubert, though exhibiting some inconsistencies due to his time, is astonishingly penetrating and suggestive. Of science and erudition the time was fruitful. At an early period of it appeared the remarkable work of Pierre Cabanis (1757-1808), the *Rapports du physique et du morale de l'homme*, a work in which physiology is treated from the extreme materialist point of view but with all the liveliness and literary excellence of the Philosopher movement at its best. Another physiological work of great merit at this period was the *Traité de la vie et de la mort* of Bichat, and the example set by these works was widely followed; while in other branches of science Laplace, Lagrange, Hairy, Berthollet, &c., produced contributions of the highest value. From the literary point of view, however, the chief interest of this time is centred in two individual names, those of Chateaubriand and Madame de Staël, and in three literary developments of a more or less novel character, which were all of the highest importance in shaping the course which French literature has taken since 1824. One of these developments was the reactionary movement of Maistre and Bonald, which in its turn largely influenced Chateaubriand, then Lamennais and Montalembert, and was later represented in French literature in different guises, chiefly by Louis Veuillot (1815-1883) and Mgr Dupanloup (1802-1878). The second and third, closely connected, were the immense advances made by parliamentary eloquence and by political writing, the latter of which, by the hand of Paul Louis Courier (1773-1825), contributed for the first time an undoubted masterpiece to French literature. The influence of the two combined has since raised journalism to even a greater pitch of power in France than in any other country. It is in the development of these new openings for literature, and in the cast and complexion which they gave to its matter, that the real literary importance of the Revolutionary period consists; just as it is in the new elements which they supplied for the treatment of such subjects that the literary value of the authors of *Reub* and *De l'Allemagne* mainly lies. We have already alluded to some of the beginnings of periodical and journalistic letters in France. For some time, in the hands of Bayle, Basnage, Des Maiseaux, Jurieu, Leclerc, periodical literature consisted mainly of a series, more or less disconnected, of pamphlets, with occasional extracts from forthcoming works, critical *adversaria* and the like. Of a more regular kind were the often-mentioned *Journal de Trévoux* and *Mercure de France*, and later the *Année littéraire* of Fréron and the like. The *Correspondance* of Grimm also, as we have pointed out, bore considerable resemblance to a modern monthly review, though it was addressed to a very few persons. Of political news there was, under a despotism, naturally very little. 1789, however, saw a vast change in this respect. An enormous efflorescence of periodical literature at once took place, and a few of the numerous journals founded in that year or soon afterwards survived for a considerable time. A whole class of authors arose who pretended to be nothing more than journalists, while many writers distinguished for more solid contributions to literature took part in the movement, and not a few active politicians contributed. Thus to the original staff of the *Moniteur*, or, as it was at first called, *La Gazette Nationale*, La Harpe, Lacretelle, Andrieux, Dominique Joseph Garat (1749-1833) and Pierre Ginguené (1748-1826) were attached. Among the writers of the *Journal de Paris* André Chénier had been ranked. Fontanes contributed to many royalist and moderate journals. Guizot and Morellet, representatives respectively of the 19th and the 18th century, shared in the *Nouvelles politiques*, while Bertin, Fievé and J. L. Geoffroy (1743-1814), a critic of peculiar acerbity, contributed to the *Journal de l'Empire*, afterwards turned into the still existing *Journal des débats*. With Geoffroy, François Bénédict Hoffman (1760-1828), Jean F. J. Dussault (1769-1824) and Charles F. Dorimond, abbé de Féletz (1765-1850), constituted a quartet of critics sometimes spoken of as "the *Débats* four," though they were by no means all friends. Of active politicians Marat (*L'Ami du peuple*), Mirabeau (*Courrier de Provence*), Barrère (*Journal des débats et des décrets*), Brissot (*Patriote français*), Elbarré (*Père Duchesne*), Robespierre (*Défen-*

seur de la constitution), and Tallien (*Le Sentinella*) were the most remarkable who had an intimate connexion with journalism. On the other hand, the type of the journalist pure and simple is Camille Desmoulins (1759-1794), one of the most brilliant, in a literary point of view, of the short-lived celebrities of the time. Of the same class were Pelletier, Durozoir, Loustalot, Royou. As the immediate daily interest in politics drooped, there were formed periodicals of a partly political and partly literary character. Such had been the *décade philosophique*, which counted Cabanis, Chénier, and De Tracy among its contributors, and this was followed by the *Revue française* at a later period, which was in its turn succeeded by the *Revue des deux mondes*. On the other hand, parliamentary eloquence was even more important than journalism during the early period of the Revolution. Mirabeau naturally stands at the head of orators of this class, and next to him may be ranked the well-known names of Malouet and Meunier among constitutionalists; of Robespierre, Marat and Danton, the triumvirs of the Mountain; of Maury, Cazals and the vicomte de Mirabeau, among the royalists; and above all of the Girondist speakers Barnave, Vergniaud, and Lanjuinais. The last named survived to take part in the revival of parliamentary discussion after the Restoration. But the permanent contributions to French literature of this period of voluminous eloquence are, as frequently happens in such cases, by no means large. The union of the journalist and the parliamentary spirit produced, however, in Paul Louis Courier a master of style. Courier spent the greater part of his life, tragically cut short, in translating the classics and studying the older writers of France, in which study he learnt thoroughly to despise the pseudo-classicism of the 18th century. It was not till he was past forty that he took to political writing, and the style of his pamphlets, and their wonderful irony and vigour, at once placed them on the level of the very best things of the kind. Along with Courier should be mentioned Benjamin Constant (1767-1830), who, though partly a romance writer and partly a philosophical author, was mainly a politician and an orator, besides being fertile in articles and pamphlets. Lamennais, like Lamartine, will best be dealt with later and the same may be said of Béranger; but Chateaubriand and Madame de Staël must be noticed here. The former represents, in the influence which changed the literature of the 18th century into the literature of the 19th, the vague spirit of unrest and "Weltschmerz," the affection for the picturesque qualities of nature, the religious spirit occasionally turning into mysticism, and the respect, sure to become more and more definite and appreciative, for antiquity. He gives in short the romantic and conservative element. Madame de Staël (1766-1817) on the other hand, as became a daughter of Necker, retained a great deal of the Philosopher character and the traditions of the 18th century, especially its liberalism, its *sensibilité*, and its thirst for general information; to which, however, she added a cosmopolitan spirit, and a readiness to introduce into France the literary and social, as well as the political and philosophical, peculiarities of other countries to which the 18th century, in France at least, had been a stranger, and which Chateaubriand himself, notwithstanding his excursions into English literature, had been very far from feeling. She therefore contributed to the positive and liberal side of the future movement. The absolute literary importance of the two was very different. Madame de Staël's early writings were of the critical kind, half aesthetic half ethical, of which the 18th century had been fond, and which their titles, *Lettres sur J. J. Rousseau*, *De l'influence des passions*, *De la littérature considérée dans ses rapports avec les institutions sociales* sufficiently show. Her romances, *Delphine* and *Corinne*, had immense literary influence at the time. Still more was this the case with *De l'Allemagne*, which practically opened up to the rising generation in France the till then unknown treasures of literature and philosophy, which during the most glorious half century of her literary history Germany had, sometimes on hints taken from France herself, been accumulating. The literary importance of Chateaubriand (1768-1848) is far greater, while his literary influence

Courier.

Madame de Staël.

Chateaubriand.

can hardly be exaggerated. Chateaubriand's literary father was Rousseau, and his voyage to America helped to develop the seeds which Rousseau had sown. In *René* and other works of the same kind, the naturalism of Rousseau received a still further development. But it was not in mere naturalism that Chateaubriand was to find his most fertile and most successful theme. It was, on the contrary, in the rehabilitation of Christianity as an inspiring force in literature. The 18th century had used against religion the method of ridicule; Chateaubriand, by genius rather than by reasoning, set up against this method that of poetry and romance. "Christianity," says he, almost in so many words, "is the most poetical of all religions, the most attractive, the most fertile in literary, artistic and social results." This theme he develops with the most splendid language, and with every conceivable advantage of style, in the *Génie des Christianismes* and the *Martyrs*. The splendour of imagination, the summonings of history and literature to supply effective and touching illustrations, analogies and incidents, the rich colouring so different from the peculiarly monotonous and grey tones of the masters of the 18th century, and the fervid admiration for nature which were Chateaubriand's main attractions and characteristics, could not fail to have an enormous literary influence. Indeed he has been acclaimed, with more reason than is usually found in such acclamations, as the founder of comparative and imaginative literary criticism in France if not in Europe. The Romantic school acknowledged, and with justice, its direct indebtedness to him.

Literature since 1830.—In dealing with the last period of the history of French literature and that which was introduced by the literary revolution of 1830 and has continued, in phases of only partial change, to the present day, a slight alteration of treatment is requisite. The subdivisions of literature have lately become so numerous, and the contributions to each have reached such an immense volume, that it is impossible to give more than cursory notice, or indeed allusion, to most of them. It so happens, however, that the purely literary characteristics of this period, though of the most striking and remarkable, are confined to a few branches of literature. The character of the 19th century in France has hitherto been at least as strongly marked as that of any previous period. In the middle ages men of letters followed each other in the cultivation of certain literary forms for long centuries. The *chanson de geste*, the Arthurian legend, the *roman d'aventure*, the *fabliau*, the allegorical poem, the rough dramatic *jeu*, mystery and farce, served successively as moulds into which the thought and writing impulse of generations of authors were successively cast, often with little attention to the suitability of form and subject. The end of the 15th century, and still more the 16th, owing to the vast extension of thought and knowledge then introduced, finally broke up the old forms, and introduced the practice of treating each subject in a manner more or less appropriate to it, and whether appropriate or not, freely selected by the author. At the same time a vast but somewhat indiscriminate addition was made to the actual vocabulary of the language. The 17th and 18th centuries witnessed a process of restriction once more to certain forms and strict imitation of predecessors, combined with attention to purely arbitrary rules, the cramping and impoverishing effect of this (in Fénelon's words) being counterbalanced partly by the efforts of individual genius, and still more by the constant and steady enlargement of the range of thought, the choice of subjects, and the familiarity with other literature, both of the ancient and modern world. The literary work of the 19th century and of the great Romantic movement which began in its second quarter was to repeat on a far larger scale the work of the 16th, to break up and discard such literary forms as had become useless or hopelessly stiff, to give strength, splendor and variety to such as were retained, to invent new ones where necessary, to enrich the language by importations, inventions and revivals, and, above all, to bring into prominence the principle of individualism. Authors and even books, rather than groups and kinds, demand principal attention.

The result of this revolution is naturally most remarkable in

the *belles-lettres* and the kindred department of history. Poetry, not dramatic, has been revived; prose romance and literary criticism have been brought to a perfection previously unknown; and history has produced works more various, if not more remarkable, than at any previous stage of the language. Of all these branches we shall therefore endeavour to give some detailed account. But the services done to the language were not limited to the strictly literary branches of literature. Modern French, if it lacks, as it probably does lack, the statuesque precision and elegance of prose style to which between 1650 and 1800 all else was sacrificed, has become a much more suitable instrument for the accurate and copious treatment of positive and concrete subjects. These subjects have accordingly been treated in an abundance corresponding to that manifested in other countries, though the literary importance of the treatment has perhaps proportionately declined. We cannot even attempt to indicate the innumerable directions of scientific study which this copious industry has taken, and must confine ourselves to those which come more immediately under the headings previously adopted. In philosophy proper France, like other nations, has been more remarkable for attention to the historical side of the matter than for the production of new systems; and the principal exception among her philosophical writers, Auguste Comte (1793-1857), besides inclining, as far as his matter went to the political and scientific rather than to the purely philosophical side (which indeed he regarded as antiquated), was not very remarkable merely as a man of letters. Victor Cousin (1797-1867), on the other hand, almost a brilliant man of letters and for a time regarded as something of a philosophical apostle preaching "eclecticism," betook himself latterly to biographical and other miscellaneous writing, especially on the famous French ladies of the 17th century, and is likely to be remembered chiefly in this department, though not to be forgotten in that of philosophical history and criticism. The same curious declension was observable in the much younger Hippolyte Adolphe Taine (1828-1893), who, beginning with philosophical studies, and always maintaining a strong tincture of philosophical determinism, applied himself later, first to literary history and criticism in his famous *Histoire de la littérature anglaise* (1864), and then to history proper in his still more famous and far more solidly based *Origines de la France contemporaine* (1876). To him, however, we must recur under the head of literary criticism. And not dissimilar phenomena, not so much of inconstancy to philosophy as of a tendency towards the applied rather than the pure branches of the subject, are noticeable in Edgar Quinet (1803-1875), in Charles de Rémusat (1797-1875), and in Ernest Renan (1823-1892), the first of whom began by translating Herder while the second and third devoted themselves early to scholastic philosophy, de Rémusat dealing with Abelard (1843) and Anselm (1856), Renan with Averroes (1852). More single-minded devotion to at least the historical side was shown by Jean Philibert Damiron (1794-1862), who published in 1842 a *Cours de philosophie* and many minor works at different times; but the inconstancy recurs in Jules Simon (1814-1896), who, in the earlier part of his life a professor of philosophy and a writer of authority on the Greek philosophers (especially in *Histoire de l'école d'Alexandrie*, 1844-1845), began before long to take an active and, towards the close of his life-work, all but a foremost part in politics. In theology the chief name of great literary eminence in the earlier part of the century is that of Lamennais, of whom more presently, in the later, that of Renan again. But Charles Forbes de Montalembert (1810-1870), an historian with a strong theological tendency, deserves notice; and among ecclesiastics who have been orators and writers the père Jean Baptiste Henri Lacordaire (1802-1861), a pupil of Lamennais who returned to orthodoxy but always kept to the Liberal side; the père Célestin Joseph Félix (1810-1891), a Jesuit teacher and preacher of eminence; and the père Didon (1840-1900), a very popular preacher and writer who, though thoroughly orthodox, did not escape collision with his superiors. On the Protestant side Athanasie Coquerel (1820-1875) is the most remarkable name. Recently Paul Sabatier (b. 1858) has displayed, especially

in dealing with Saint Francis of Assisi, much power of literary and religious sympathy and a style somewhat modelled on that of Renan, but less unctuous and effeminate. There are strong philosophical tendencies, and at least a revolt against the religious as well as philosophical ideas of the Encyclopédistes, in the *Pensées* of Joubert, while the hybrid position characteristic of the 19th century is particularly noticeable in Étienne Pivert de Sénancour (1770-1846), whose principal work, *Obermann* (1804), had an extraordinary influence on its own and the next generation in the direction of melancholy moralizing. Thistone was notably taken up towards the other end of the century by Amiel (*q.v.*), who, however, does not strictly belong to French literature: while in Ximénès Doudon (1800-1872), author of *Mélanges et lettres* posthumously published, we find more of a return to the attitude of Joubert—literary criticism occupying a very large part of his reflections. Political philosophy and its kindred sciences have naturally received a large share of attention. Towards the middle of the century there was a great development of socialist and fanciful theorizing on politics, with which the names of Claude Henri, comte de Saint-Simon (1760-1825), Charles Fourier (1772-1837), Étienne Cabet (1788-1856), and others are connected. As political economists Frédéric Bastiat (1801-1850), L. G. L. Guilhaud de Lavergne (1809-1880), Louis Auguste Blanqui (1805-1881), and Michel Chevalier (1806-1879) may be noticed. In Alexis de Tocqueville (1805-1859) France produced a political observer of a remarkably acute, moderate and reflective character, and Armand Carrel (1800-1836), whose life was cut short in a duel, was a real man of letters, as well as a brilliant journalist and an honest if rather violent party politician. The name of Jean Louis Eugène Lerminier (1803-1857) is of wide repute for legal and constitutional writings, and that of Henri, baron de Jomini (1779-1869) is still more celebrated as a military historian; while that of François Lenormant (1837-1883) holds a not dissimilar position in archaeology. With the publications devoted to physical science proper we do not attempt to meddle. Philology, however, demands a brief notice. In classical studies France has till recently hardly maintained the position which might be expected of the country of Scaliger and Casaubon. She has, however, produced some considerable Orientalists, such as Champollion the younger, Burnouf, Silvestre de Sacy and Stanislas Julien. The foundation of Romance philology was due, indeed, to the foreigners Wolf and Diez. But early in the century the curiosity as to the older literature of France created by Barbazan, Tressan and others continued to extend. Dominique Martin Méon (1748-1829) published many unprinted fabliaux, gave the whole of the French *Renart* cycle, with the exception of *Renart le contrefait*, and edited the *Roman de la rose*. Charles Claude Faurler (1772-1844) and François Reynouard (1761-1836) dealt elaborately with Provençal poetry as well as partially with that of the trouvères; and the latter produced his comprehensive *Lexique romane*. These examples were followed by many other writers, who edited manuscript works and commented on them, always with zeal and sometimes with discretion. Foremost among these must be mentioned Paulin Paris (1800-1881) who for fifty years served the cause of old French literature with untiring energy, great literary taste, and a pleasant and facile pen. His selections from manuscripts, his *Romancero français*, his editions of *Garin le Loherain* and *Berte aus grans piés*, and his *Romans de la table ronde* may especially be mentioned. Soon, too, the Benedictine *Histoire littéraire*, so long interrupted, was resumed under M. Paris's general management, and has proceeded nearly to the end of the 14th century. Among its contents M. Paris's dissertations on the later *chansons de gestes* and the early song writers, M. Victor le Clerc's on the *fabliaux*, and M. Littré's on the *romans d'aventures* may be specially noticed. For some time indeed the work of French editors was chargeable with a certain lack of critical and philological accuracy. This reproach, however, was wiped off by the efforts of a band of younger scholars, chiefly pupils of the École des Chartes, with M.M. Gaston Paris (1830-1903) and Paul Meyer at their head. Of M. Paris in particular it may be said that no scholar in the subject has ever

combined literary and linguistic competence more admirably. The Société des Anciens Textes Français was formed for the purpose of publishing scholarly editions of inedited works, and a lexicon of the older tongue by M. Godefroy at last supplemented, though not quite with equal accomplishment, the admirable dictionary in which Émile Littré (1801-1881), at the cost of a life's labour, embodied the whole vocabulary of the classical French language. Meanwhile the period between the middle ages proper and the 17th century has not lacked its share of this revival of attention. To the literature between Villon and Regnier especial attention was paid by the early Romantics, and Sainte-Beuve's *Tableaux historique et critique de la poésie et du théâtre au seizième siècle* was one of the manifestoes of the school. Since the appearance of that work in 1828 editions with critical comments of the literature of this period have constantly multiplied, aided by the great fancy for tastefully produced works which exists among the richer classes in France; and there are probably now few countries in which works of old authors, whether in cheap reprints or in *éditions de luxe* can be more readily procured.

The Romantic Movement.—It is time, however, to return to the literary revolution itself, and its more purely literary results. At the accession of Charles X. France possessed three *Bérangers*, writers, and perhaps only three, of already remarkable eminence, if we except Chateaubriand, who was already of a past generation. These three were Pierre Jean de Béranger (1780-1857), Alphonse de Lamartine (1790-1869), and Hugues Félicité Robert Lamennais (1782-1854). The first belongs definitely in manner, despite his striking originality of *essence*, to the past. He has remnants of the old periphrases, the cumbersome mythological allusions, the poetical "properties" of French verse. He has also the older and somewhat narrow limitations of a French poet; foreigners are for him mere barbarians. At the same time his extraordinary lyrical faculty, his excellent wit, which makes him a descendant of Rabelais and La Fontaine, and his occasional touches of pathos made him deserve and obtain something more than successes of occasion. Béranger, moreover, was very far from being the mere improvisatore which those who cling to the inspirationist theory of poetry would fain see in him. His studies in style and composition were persistent, and it was long before he attained the firm and brilliant manner which distinguishes him. Béranger's talent, however, was still too much a matter of individual genius to have great literary influence, and he formed no school. It was different with Lamartine, who was, nevertheless, like Béranger, a typical Frenchman. The *Méditations* and the *Lamartines*. *Harmonies* exhibit a remarkable transition between the old school and the new. In going direct to nature, in borrowing from her striking outlines, vivid and contrasted tints, harmony and variety of sound, the new poet showed himself an innovator of the best class. In using romantic and religious associations, and expressing them in affecting language, he was the Chateaubriand of verse. But with all this he retained some of the vices of the classical school. His versification, harmonious as it is, is monotonous, and he does not venture into the bold lyrical forms which true poetry loves. He has still the horror of the *mot propre*; he is always spiritualizing and idealizing, and his style and thought have a double portion of the feminine and almost flaccid softness which had come to pass for grace in French. The last of the trio, Lamennais, represents an altogether bolder and rougher genius. Strongly influenced by the Catholic reaction, Lamennais also shows the *Lamennais*. strongest possible influence of the revolutionary spirit. His earliest work, the *Essai sur l'indifférence en matière de religion* (1817 and 1818) was a defence of the church on curiously unecclesiastical lines. It was written in an ardent style, full of illustrations, and extremely ambitious in character. The plan was partly critical and partly constructive. The first part disposed of the 18th century; the second, adopting the theory of papal absolutism which Joseph de Maistre had already advocated, proceeded to base it on a supposed universal consent. The after history of Lamennais was perhaps not an unnatural recoil from this; but it is sufficient here to point out that in his prose,

especially as afterwards developed in the apocalyptic *Paroles d'un croyant* (1839) are to be discerned many of the tendencies of the Romantic school, particularly its hardy and picturesque choice of language, and the disdain of established and accepted methods which it professed. The signs of the revolution itself were, as was natural, first given in periodical literature. The feudalist affectations of Chateaubriand and the legitimists excited a sort of aesthetic affection for Gothicism, and Walter Scott became one of the most favourite authors in France. Soon was started the periodical *La Muse française*, in which the names of Hugo, Vigny, Deschamps and Madame de Girardin appear. Almost all the writers in this periodical were eager royalists, and for some time the battle was still fought on political grounds. There could, however, be no special connexion between classical drama and liberalism; and the liberal journal, the *Globe*, with no less a person than Sainte-Beuve among its contributors, declared definite war against classicism in the drama. The chief "classical" organs were the *Constitutionnel*, the *Journal des débats*, and after a time and not exclusively, the *Revue des deux mondes*. Soon the question became purely literary, and the Romantic school proper was born in the famous *éclat* or clique in which Hugo was chief poet, Sainte-Beuve chief critic, and Gautier, Gérard de Nerval, the brothers Émile (1791-1871) and Antony (1800-1869), Deschamps, Petrus Borel (1809-1859) and others were officers. Alfred de Vigny and Alfred de Musset stand somewhat apart, and so does Charles Nodier (1780-1844), a versatile and voluminous writer, the very variety and number of whose works have somewhat prevented the individual excellence of any of them from having justice done to it. The objects of the school, which was at first violently opposed, so much so that certain academicians actually petitioned the king to forbid the admission of any Romantic piece at the Théâtre Français, were, briefly stated, the burning of everything which had been adored, and the adoring of everything which had been burnt. They would have no unities, no arbitrary selection of subjects, no restraints on variety of versification, no academically limited vocabulary, no considerations of artificial-beauty, and, above all, no periphrastic expression. The *mot propre*, the calling of a spade a spade, was the great commandment of Romanticism; but it must be allowed that what was taken away in periphrase was made up in adjectives. Musset, who was very much of a free-lance in the contest, maintained indeed that the *differentia* of the Romantic was the copious use of this part of speech. All sorts of epithets were invented to distinguish the two parties, of which *flamboyant* and *grisâtre* are perhaps the most accurate and expressive pair—the former serving to denote the gorgeous tints and bold attempts of the new school, the latter the grey colour and monotonous outlines of the old. The representation of *Hernani* in 1830 was the culmination of the struggle, and during great part of the reign of Louis Philippe almost all the younger men of letters in France were Romantics. The representation of the *Lucrèce* of François Ponsard (1814-1867) in 1846 is often quoted as the herald or sign of a classical reaction. But this was only apparent, and signified, if it signified anything, merely that the more juvenile excesses of the Romantics were out of date. All the greatest men of letters of France since 1830 have been on the innovating side, and all without exception, whether intentionally or not, have had their work coloured by the results of the movement, and of those which have succeeded it as developments rather than reactions.

Drama and Poetry since 1830.—Although the immediate subject on which the battles of Classics and Romantics arose was dramatic poetry, the dramatic results of the movement have not been those of greatest value or most permanent character. The principal effect in the long run has been the introduction of a species of play called *drame*, as opposed to regular comedy and tragedy, admitting of much freer treatment than either of these two as previously understood in French, and lending itself in some measure to the lengthy and disjointed action, the multiplicity of personages, and the absence of stock characters which characterized the English stage in its palmy days. All Victor Hugo's dramatic works are of this class, and

each, as it was produced or published (*Cromwell*, *Hernani*, *Marion de l'Orme*, *Le Roi s'amuse*, *Lucrèce Borgia*, *Marie Tudor*, *Ruy Blas* and *Les Burgraves*), was a literary event, and excited the most violent discussion—the author's usual plan being to prefix a prose preface of a very militant character to his work. A still more melodramatic variety of *drame* was that chiefly represented by Alexandre Dumas (1802-1870), whose *Henri III* and *Antony*, to which may be added later *La Tour de Nesle* and *Mademoiselle de Belleisle*, were almost as much rallying points for the early Romantics as the dramas of Hugo, despite their inferior literary value. At the same time Alexandre Soumet (1788-1845), in *Norma*, *Une Fête de Néron*, &c., and Casimir Delavigne in *Marino Faliero*, *Louis XI*, &c., maintained a somewhat closer adherence to the older models. The classical or semi-classical reaction of the last years of Louis Philippe was represented in tragedy by Ponsard (*Lucrèce*, *Agnes de Méranie*, *Charlotte Corday*, *Ulysse*, and several comedies), and on the comic side, to a certain extent, by Émile Augier (1820-1889) in *L'Aventurière*, *Le Gendre de M. Poirier*, *Le Fils de Giboyer*, &c. During almost the whole period Eugène Scribe (1791-1861) poured forth innumerable comedies of the vaudeville order, which, without possessing much literary value, attained immense popularity. For the last half-century the realist development of Romanticism has had the upper hand in dramatic composition, its principal representatives being on the one side Victorien Sardou (1831-1909), who in *Nos Intimes*, *La Famille Benoiton*, *Rabagas*, *Dora*, &c., chiefly devoted himself to the satirical treatment of manners, and Alexandre Dumas fils (1824-1895), author in 1852 of the famous *Dame aux camélias*, who in such pieces as *Les Idées de Madame Aubray* and *L'Étrangère* rather busied himself with morals and "problems," while his *Dame aux camélias* (1852) is sometimes ranked as the first of such things in "modern" style. Certain isolated authors also deserve notice, such as Joseph Autran (1813-1877), a poet and academician having some resemblance to Lamartine, whose *Fille d'Eschyle* created for him a dramatic reputation which he did not attempt to follow up, and Gabriel Legouvé (b. 1807), whose *Adrienne Lecouvreur* was assisted to popularity by the admirable talent of Rachel. A special variety of drama of the first literary importance has also been cultivated in this century under the title of *scènes* or *proverbes*, slight dramatic sketches in which the dialogue and style are of even more importance than the action. The best of all of these are those of Alfred de Musset (1810-1857), whose *Il faut qu'une porte soit ouverte ou fermée*, *On ne badine pas avec l'amour*, &c., are models of grace and wit. Among his followers may be mentioned especially Octave Feuillet (1821-1890). Few social dramas of the kind in modern times have attained a greater success than *Le Monde où l'on s'ennuie* (1868) of Édouard Pailleron (1834-1899). (See also DRAMA.)

In poetry proper, as in drama, Victor Hugo showed the way. In him all the Romantic characteristics were expressed and embodied—disregard of arbitrary critical rules, free choice of subject, variety and vigour of metre, splendour and sonorousness of diction, abundant "local colour," and that irrepressible individualism which is one of the chief, though not perhaps the chief, of the symptoms. If the careful attention to form which is also characteristic of the movement is less apparent in him than in some of his followers, it is not because it is absent, but because the enthusiastic conviction with which he attacked every subject somewhat diverts attention from it. As with the merits so with the defects. A deficient sense of the ludicrous which characterized many of the Romantics was strongly apparent in their leader, as was also an equally representative grandiosity, and a fondness for the introduction of foreign and unfamiliar words, especially proper names, which occasionally produces an effect of burlesque. Victor Hugo's earliest poetical works, his chiefly royalist and political *Odes*, were cast in the older and accepted forms, but already displayed astonishing poetical qualities. But it was in the *Ballades* (for instance, the splendid *Pas d'armes du roi Jean*, written in verses of three syllables) and the *Orientales* (of which may be taken for a sample the sixth section of *Navarin*, a perfect

Victor Hugo.

torrent of outlandish terms poured forth in the most admirable verse, or *Les Djinns*, where some of the stanzas have lines of two syllables each) that the grand provocation was thrown to the believers in alexandrines, careful caesuras and strictly separated couplets. *Les Feuilles d'automne*, *Les Chants du crépuscule*, *Les Voix intérieures*, *Les Rayons et les ombres*, the productions of the next twenty years, were quieter in style and tone, but no less full of poetical spirit. The Revolution of 1848, the establishment of the empire and the poet's exile brought about a fresh determination of his genius to lyrical subjects. *Les Châtiments* and *La Légende des siècles*, the one political, the other historical, reach perhaps the high-water mark of French verse; and they were followed by the philosophical *Contemplations*, the lighter *Chansons des rues et des bois*, the *Année terrible*, the second *Légende des siècles*, and the later work to be found noticed *sub nom.* We have been thus particular here because the literary productiveness of Victor Hugo himself has been the measure and sample of the whole literary productiveness of France on the poetical side. At five-and-twenty he was acknowledged as a master, at seventy-five he was a master still. His poetical influence has been represented in three different schools, from which very few of the poetical writers of the century can be excluded. These few we may notice first. Alfred de Musset, a writer of great genius, felt part of the Romantic inspiration very strongly, but was on the whole unfortunately influenced by Byron, and partly out of willfulness, partly from a natural want of persevering industry and vigour, allowed himself to be careless and even slovenly in composition. Notwithstanding this, many of his lyrics are among the finest poems in the language, and his verse, careless as it is, has extraordinary natural grace. Auguste Barbier (1805-1882) whose *Iambes* shows an extraordinary command of nervous and masculine versification, also comes in here; and the Breton poet, Auguste Brizeux (1803-1858), much admired by some, together with Hégésippe Moreau, an unequal writer possessing some talent, Pierre Dupont (1821-1870), one of much greater gifts, and Gustave Nadaud (1820-1893), a follower of Béranger, also deserve mention. Of the school of Lamartine rather than of Hugo are Alfred de Vigny (1799-1865) and Victor de Laprade (1812-1887), the former a writer of little bulk and somewhat over-fastidious, but possessing one of the most correct and elegant styles to be found in French, with a curious restrained passion and a complicated originality, the latter a meditative and philosophical poet, like Vigny an admirable writer, but somewhat deficient in pith and substance, as well as in warmth and colour. Madame Ackermann (1813-1890) is the chief philosophical poetess of France, and this style has recently been very popular; but for actual poetical powers, Marceline Desbordes-Valmore (1786-1859) perhaps excelled her, though in a looser and more sentimental fashion. The poetical schools which more directly derive from the Romantic movement as represented by Hugo are three in number, corresponding in point of time with the first outburst of the movement, with the period of reaction already alluded to, and with the closing years of the second empire. Of the first by far the most distinguished member was Théophile Gautier (1811-1872), the most perfect poet in point of form that France has produced. When quite a boy he devoted himself to the study of 16th-century masters, and though he acknowledged the supremacy of Hugo, his own talent was of an individual order, and developed itself more or less independently. *Albertus* alone of his poems has much of the extravagant and grotesque character which distinguished early romantic literature. The *Comédie de la mort*, the *Poésies diverses*, and still more the *Émaux et camées*, display a distinctly classical tendency—classical, that is to say, not in the party and perverted sense, but in its true acceptation. The tendency to the fantastic and horrible may be taken as best shown by Petrus Borel (1809-1859), a writer of singular power almost entirely wasted. Gerard Labrunie or de Nerval (1808-1855) adopted a manner also fantastic but more idealistic than Borel's, and distinguished himself by his Oriental travels and studies, and by his attention to popular ballads and traditions,

while his style has an exquisite but unaffected strangeness hardly inferior to Gautier's. This peculiar and somewhat quintessenced style is also remarkable in the *Gaspard de la nuit* of Louis Bertrand (1807-1841), a work of rhythmical prose almost unique in its character. One famous sonnet preserves the name of Félix Arvers (1806-1850). The two Deschamps were chiefly remarkable as translators. The next generation produced three remarkable poets, to whom may perhaps be added a fourth. Théodore de Banville (1823-1891), adopting the principles of Gautier, and combining with them a considerable satiric faculty, composed a large amount of verse, faultless in form, delicate and exquisite in shades and colours, but so entirely neutral in moral and political tone that it has found fewer admirers than it deserved. Charles Marie René Leconte de Lisle (1818-1894), carrying out the principle of ransacking foreign literature for subjects, went to Celtic, classical or even Oriental sources for his inspiration, and despite a science in verse not much inferior to Banville's, and a far wider range and choice of subject, diffused an air of erudition, not to say pedantry, over his work which disgusted some readers, and a pessimism which displeased others, but has left poetry only inferior to that of the greatest of his countrymen. Charles Baudelaire (1821-1867), by his choice of unpopular subjects and the terrible truth of his analysis, revolted not a few of those who, in the words of an English critic, cannot take pleasure in the representation if they do not take pleasure in the thing represented, and who thus miss his extraordinary command of the poetical appeal in sound, in imagery and in suggestion generally. Thus, by a strange coincidence, each of the three representatives of the second Romantic generation was for a time disappointed of his due fame. A fourth poet of this time, Joséphin Soulay (1815-1891), produced sonnets of rare beauty and excellence. A fifth, Louis Bouilhet (1822-1866), an intimate friend of Flaubert, pushed even farther the fancy for strange subjects, but showed powers in *Melanis* and other things. In 1866 a collection of poems, entitled after an old French fashion *Le Parnasse contemporain*, appeared. It included contributions by many of the poets just mentioned, but the mass of the contributors were hitherto unknown to fame. A similar collection appeared in 1869, and was interrupted by the German war, but continued after it, and a third in 1876.

The first *Parnasse* had been projected by M.M. Xavier de Ricard (b. 1843) and Catulle Mendès (1841-1909) as a sort of manifesto of a school of young poets: but its contents were largely coloured by the inclusion among them of work by representatives of older generations—Gautier, Laprade, Leconte de Lisle, Banville, Baudelaire and others. The continuation, however, of the title in the later issues, rather than anything else, led to the formation and promulgation of the idea of a "Parnassien" or an "Impassible" school which was supposed to adopt as its watchword the motto of "Art for Art's sake," to pay especial attention to form, and also to aim at a certain objectivity. As a matter of fact the greater poets and the greater poems of the *Parnasse* admit of no such restrictive labelling, which can only be regarded as mischievous, though (or very mainly because) it has been continued. Another school, arising mainly in the later 'eighties and calling itself that of "Symbolism," has been supposed to indicate a reaction against Parnassianism and even against the main or Hugonic Romantic tradition generally; with a throwing back to Lamartine and perhaps Chénier. This idea of successive schools ("Decadents," "Naturalists," "Simplists," &c.) has even been reduced to such an *absurdum* as the statement that "France sees a new school of poetry every fifteen years." Those who have studied literature sufficiently widely, and from a sufficient elevation, know that these systematisings are always more or less delusive. Parnassianism, symbolism and the other things are merely phases of the Romantic movement itself—as may be proved to demonstration by the simple process of taking, say, Hugo and Verlaine on the one hand, Delille or Escouchard Lebrun on the other, and comparing the two first mentioned with each other and with the older poet. The differences in the first case will be found to be

differences at most of individuality: in the other of kind. We shall not, therefore, further refer to these dubious classifications: but specify briefly the most remarkable poets whom they concern, and all the elder of whom, it may be observed, were represented in the *Parnasse* itself. Of these the most remarkable were Sully Prudhomme (1839-1907), François Coppée (1842-1908) and Paul Verlaine (1844-1896). The first (*Stances et poèmes*, 1865, *Vaines Tendresses*, 1875, *Bonneur*, 1888, &c.) is a philosophical and rather pessimistic poet who has very strongly rallied the suffrages of the rather large present public who care for the embodiment of these tendencies in verse; the second (*La Grâce des forgerons*, 1869, *Les Humbles*, 1872, *Contes et vers*, 1881-1887, &c.) a dealer with more generally popular subjects in a more sentimental manner; and the third (*Sagesse*, 1881, *Parallèlement*, 1889, *Poèmes saturniens*, including early work, 1867-1890), by far the most original and remarkable poet of the three, starting with Baudelaire and pushing farther the fancy for forbidden subjects, but treating both these and others with wonderful command of sound and image-suggestion. Verlaine in fact (he was actually well acquainted with English) endeavoured, and to a small extent succeeded in the endeavour, to communicate to French the vague suggestion of visual and audible appeal which has characterized English poetry from Blake through Coleridge. Others of the original Parnassians who deserve mention are Albert Glatigny (1839-1873), a Bohemian poet of great talent who died young; Stéphane Mallarmé (1842-1898), afterwards chief of the Symbolists, also a true poet in his way, but somewhat barren, and the victim of pose and trick; José Maria de Heredia (1842-1905), a very exquisite practitioner of the sonnet but with perhaps more art than matter in him; Henri Cazalis (1840-1909), who long afterwards, under his name of Jean Lahor, appeared as a Symbolist pessimist; A. Villiers de l'Isle-Adam, another eccentric but with a spark of genius; Emmanuel des Essarts; Auguste de Châtillon (1810-1882); Léon Dièrx (b. 1838) who, after producing even less than Mallarmé, succeeded him as Symbolist chief; Jean Aicard (b. 1848), a southern bard of merit; and lastly Catulle Mendès himself, who has been a brilliant writer in verse and prose ever since, and whose *Mouvement poétique français de 1807 à 1900* (1903), an official report largely amplified so that it is in fact a history and dictionary of French poetry during the century, forms an almost unique work of reference on the subject. Among the later recruits the most specially noticeable was Armand Silvestre (1837-1901), whose verse (*La Chanson des heures*, 1878, *Ailes d'or*, 1880, *La Chanson des Voiles*, 1885), of an ethereal beauty, was contrasted with prose admirably written and sometimes most amusing, but "Pantagruelist," and more, in manners and morals. This declension from poetry to prose fiction was also noticeable in Guy de Maupassant, André Theuriot, Anatole France and even Alphonse Daudet.

Yet another flight of poets may be grouped as those specially representing the last quarter of the century and (whether Parnassian, Symbolist or what not) the latest development of French poetry. Verlaine and Mallarmé already mentioned were in a manner the leaders of these. Perhaps something of the influence of Whitman may be detected in the irregular verses of Gustave Kahn (b. 1859), Francis Viéllé Griffin, actually an American by birth (b. 1864), Stuart Merrill, of like origin, and Paul Fort (b. 1872). But the whole tendency of the period has been to relax the stringency of French prosody. Albert Samain (1859-1900), a musical versifier enough; Jean Moreas (1856-1910) who began with a volume called *Les Syrtes* in 1884; Laurent Tailhade (b. 1854) and others are more or less Symbolist, and contributed to the Symbolist periodical (one of many such since the beginning of the Romantic movement which would almost require an article to themselves), the *Mercur de France*. An older man than many of these, M. Jean Richepin (b. 1849), made for a time considerable noise with poetical work of a colour older even than his age, and harking back somewhat to the Jeune-France and "Bousingot" type of early Romanticism—*La Chanson des gueux*, *Les Blasphèmes*, &c. Other writers of note are M. Paul Déroulède (b. 1846), a violently nationalist poet;

M. Maurice Bouchor (b. 1864), who started his serious and respectable work with *Les Symboles* in 1888; while M. Henri de Regnier, born in the same year, has received very high praise for work from *Lendemains* in 1886 and other volumes up to *Les Jeux rustiques et divins* (1897) and *Les Médailles d'argent* (1900). The truth, however, perhaps is that this extraordinary abundance of verse (for we have not mentioned a quarter of the names which present themselves, or a twentieth part of those who figure in M. Mendès's catalogue for the last half-century) reminds the literary historian somewhat too much of similar phenomena in other times. There is undoubtedly a great diffusion of poetical dexterity, and not perhaps a small one of poetical spirit, but it requires the settling, clarifying and distinguishing effects of time to separate the poet from the minor poet. Still more perhaps must we look to time to decide whether the *vers libre* as it is called—that is to say, the verse freed from the minute traditions of the elder prosody, admitting hiatus, neglecting to a greater or less extent *caesura*, and sometimes relying upon mere rhythm to the neglect of strict metre altogether—can hold its ground. It has as yet been practised by no poet at all approaching the first class, except Verlaine, and not by him in its extremest forms. And the whole history of prosody and poetry teaches us that though similar changes often come in as it were unperceived, they scarcely ever take root in the language unless a great poet adopts them. Or rather it should perhaps be said that when they are going to take root in the language a great poet always does adopt them before very long.

Prose Fiction since 1830.—Even more remarkable, because more absolutely novel, was the outburst of prose fiction which followed 1830. Madame de Lafayette, Le Sage, Marivaux, Voltaire, the Abbé Prévost, Diderot, J. J. Rousseau, Bernardin de Saint-Pierre and Fiévée had all of them produced work excellent in its way, and comprising in a more or less rudimentary condition most varieties of the novel. But none of them had, in the French phrase, made a school, and at no time had prose fiction been composed in any considerable quantities. The immense influence which Walter Scott exercised was perhaps the direct cause of the attention paid to prose fiction; the facility, too, with which all the fancies, tastes and beliefs of the time could be embodied in such work may have had considerable importance. But it is difficult on any theory of cause and effect to account for the appearance in less than ten years of such a group of novelists as Hugo, Gautier, Dumas, Mérimée, Balzac, George Sand, Jules Sandeau and Charles de Bernard, names to which might be added others scarcely inferior. There is hardly anything else resembling it in literature, except the great cluster of English dramatists in the beginning of the 17th century, and of English poets at the beginning of the 19th; and it is remarkable that the excellence of the first group was maintained by a fresh generation—Murger, About, Feuillet, Flaubert, Erckmann-Chatrian, Droz, Daudet, Cherbuliez and Gaboriau, forming a company of *diadochi* not far inferior to their predecessors, and being themselves not unworthily succeeded almost up to the present day. The romance-writing of France during the period has taken two different directions—the first that of the novel of incident, the second that of analysis and character. The first, now mainly deserted, was that which, as was natural when Scott was the model, was formerly most trodden; the second required the genius of George Sand and of Balzac and the more problematical talent of Beyle to attract students to it. The novels of Victor Hugo are novels of incident, with a strong infusion of purpose, and considerable but rather ideal character drawing. They are in fact lengthy *prose dramas* rather than romances proper, and they have found no imitators. They display, however, the powers of the master at their fullest. On the other hand, Alexandre Dumas originally com-
Dumas.
posed his novels in close imitation of Scott, and they are much less dramatic than narrative in character, so that they lend themselves to almost indefinite continuation, and there is often no particular reason why they should terminate even at the end of the score or so of volumes to which they sometimes actually extend. Of this purely narrative kind, which hardly

even attempts anything but the boldest character drawing, the best of them, such as *Les Trois Mousquetaires*, *Vingt ans après*, *La Reine Margot*, are probably the best specimens extant. Dumas possesses, almost alone among novelists, the secret of writing interminable dialogue without being tedious, and of telling the story by it. Of something the same kind, but of a far lower stamp, are the novels of Eugène Sue (1804-1857). Dumas and Sue were accompanied and followed by a vast crowd of companions, independent or imitative. Alfred de Vigny had already attempted the historical novel in *Cinq-Mars*. Henri de La Touche (1785-1851) (*Fragoletta*), an excellent critic who formed George Sand, but a mediocre novelist, may be mentioned: and perhaps also Roger de Beauvoir, whose real name was Eugène Auguste Roger de Bully (1806-1866) (*Le Chronique de Saint Georges*), and Frédéric Soulié (*Les Mémoires du diable*) (1800-1847). Paul Féval (*La Fée des grées*) (1817-1877) and Amédée Achard (*Belle-Rose*) (1814-1875) are of the same school, and some of the attempts of Jules Janin (1804-1874), more celebrated as a critic, may also be connected with it. By degrees, however, the taste for the novel of incident, at least of an historical kind, died out till it was revived in another form, and with an admixture of domestic interest, by M. M. Erckmann-Chatrin. The last and one of the most splendid instances of the old style was *Le Capitaine Fracasse*, which Théophile Gautier began early and finished late as a kind of *tour de force*. The last-named writer in his earlier days had modified the incident novel in many short tales, a kind of writing for which French has always been famous, and in which Gautier's sketches are masterpieces. His only other long novel, *Mademoiselle de Maupin*, belongs rather to the class of analysis. With Gautier, as a writer whose literary characteristics even excel his purely tale-telling powers, may be classed Prosper Mérimée (1803-1870), one of the most exquisite 19th-century masters of the language. Already, however, in 1830 the tide was setting strongly in favour of novels of contemporary life and manners. These were of course susceptible of extremely various treatment. For many years Paul de Kock (1793-1871), a writer who did not trouble himself about Classics or Romantics or any such matter, continued the tradition of Marivaux, Crébillon *filz*, and Pigault Lebrun (1753-1835) in a series of not very moral or polished but lively and amusing sketches of life, principally of the bourgeois type. Later Charles de Bernard (1804-1850) (*Gerfaut*) with infinitely greater wit, elegance, propriety and literary skill, did the same thing for the higher classes of French society. But the two great masters of the novel of character and manners as opposed to that of history and incident are Honoré de Balzac (1790-1850) and Aurore Dudevant, commonly called George Sand (1804-1876). Their influence affected the entire body of novelists who succeeded them, with very few exceptions. At the head of these exceptions may be placed Jules Sandeau (1811-1883), who, after writing a certain number of novels in a less individual style, at last made for himself a special subject in a certain kind of domestic novel, where the passions set in motion are less boisterous than those usually preferred by the French novelist, and reliance is mainly placed on minute character drawing and shades of colour sober in hue but very carefully adjusted (*Catherine*, *Mademoiselle de Penarvan*, *Mademoiselle de la Sciglière*). In the same class of the more quiet and purely domestic novelists may be placed X. B. Saintine (1798-1865) (*Picciola*), Madame C. Reybaud (1802-1871) (*Clémentine*, *Le Cadet de Colobrières*), J. T. de Saint-Germain (*Pour en épingle*, *La Feuille de coudrier*), Madame Craven (1808-1891) (*Récit d'une sœur*, *Fleurange*). Henri Beyle (1798-1865), who wrote under the *nom de plume* of Stendhal and belongs to an older generation than most of these, also stands by himself. His chief book in the line of fiction is *La Chartreuse de Parme*, an exceedingly powerful novel of the analytical kind, and he also composed a considerable number of critical and miscellaneous works. Of little influence at first (though he had great power over Mérimée) and never master of a perfect style, he has exercised ever increasing authority as a master of pessimist analysis. Indeed much of his work was never published till towards the close of the century. Last among the independents must be

mentioned Henry Murger (1822-1861), the painter of what is called Bohemian life, that is to say, the struggles, difficulties and amusements of students, youthful artists, and men of letters. In this peculiar style, which may perhaps be regarded as an irregular descendant of the picaresque romance, Murger has no rival; and he is also, though on no extensive scale, a poet of great pathos. But with these exceptions, the influences of the two writers we have mentioned, sometimes combined, more often separate, may be traced throughout the whole of later novel literature. George Sand began with books strongly tinged with the spirit of revolt against moral and social arrangements, and she sometimes diverged into very curious paths of pseudo-philosophy, such as was popular in the second quarter of the century. At times, too, as in *Lucrezia Floriani* and some other works, she did not hesitate to draw largely on her own personal adventures and experiences. But latterly she devoted herself rather to sketches of country life and manners, and to novels involving bold if not very careful sketches of character and more or less dramatic situations. She was one of the most fertile of novelists, continuing to the end of her long life to pour forth fiction at the rate of many volumes a year. Of her different styles may be mentioned as fairly characteristic, *Lélia*, *Lucrezia Floriani*, *Consuelo*, *La Mare au diable*, *La Petite Fadette*, *François le champi*, *Mademoiselle de la Quintinie*. Considering the shorter length of his life the productiveness of Balzac was almost more astonishing, especially if we consider that ^{Balzac the younger.} some of his early work was never reprinted, and that he left great stores of fragments and unfinished sketches. He is, moreover, the most remarkable example in literature of untiring work and determination to achieve success despite the greatest discouragements. His early work was worse than unsuccessful, it was positively bad. After more than a score of unsuccessful attempts, *Les Chouans* at last made its mark, and for twenty years from that time the astonishing productions composing the so-called *Comédie humaine* were poured forth successively. The sub-titles which Balzac imposed upon the different batches, *Scènes de la vie parisienne*, *de la vie de province*, *de la vie intime*, &c., show, like the general title, a deliberate intention on the author's part to cover the whole ground of human, at least of French life. Such an attempt could not succeed wholly, yet the amount of success attained is astonishing. Balzac has, however, with some justice been accused of creating the world which he described, and his personages, wonderful as is the accuracy and force with which many of the characteristics of humanity are exemplified in them, are somehow not altogether human. Since these two great novelists, many others have arisen, partly to tread in their steps, partly to strike out independent paths. Octave Feuillet (1811-1890), beginning his career by apprenticeship to Alexandre Dumas and the historical novel, soon found his way in a very different style of composition, the *roman intime* of fashionable life, in which, notwithstanding some grave defects, he attained much popularity and showed remarkable skill in keeping abreast of his time. The so-called realist side of Balzac was developed (but, as he himself acknowledged, with a double dose of intermixed if somewhat transformed Romanticism) by Gustave Flaubert (1821-1880), who showed culture, scholarship and a literary power over the language inferior to that of no writer of the century. No novelist of his generation has attained a higher literary rank than Flaubert. *Madame Bovary* and *L'Éducation sentimentale* are studies of contemporary life; in *Salammbô* and *La Tentation de Saint Antoine* erudition and antiquarian knowledge furnish the subjects for the display of the highest literary skill. Of about the same date Edmond About (1828-1885), before he abandoned novel-writing, devoted himself chiefly to sketches of abundant but not always refined wit (*L'Homme à l'oreille cassée*, *Le Nez d'un notaire*), and sometimes to foreign scenes (*Tolla*, *Le Roi des montagnes*). Champfleury (Henri Husson, 1829-1880), a prolific critic, deserves notice for stories of the extravaganza kind. During the whole of the Second Empire one of the most popular writers was Ernest Feydeau (1821-1873), a writer of great ability, but morbid and affected in the choice and treatment of his subjects (*Fanky*,

Sylvie, Catherine d'Overmeire). Émile Gaboriau (1833-1873), taking up that side of Balzac's talent which devoted itself to inextricable mysteries, criminal trials, and the like, produced *M. Le Coq, Le Crime d'Orival, La Déglingolade, &c.*; and Adolphe Belot (b. 1829) for a time endeavoured to out-Feydeau Feydeau in *La Femme de feu* and other works. Eugène Fromentin (1820-1876), best known as a painter, wrote a novel, *Dominique*, which was highly appreciated by good judges.

During the last decade of the Second Empire there arose, continuing for varying lengths of time till nearly the end of the century, another remarkable group of novelists, most of whom are dealt with under separate headings, but who must receive combined treatment here; with the warning that even more danger than in the case of the poets is incurred by classing them in "schools." Undoubtedly, however, the "Naturalist" tendency, starting from Balzac and continued through Flaubert, but taking quite a new direction under some of those to be mentioned, is in a manner dominant. Flaubert himself and Feuillet (an exact observer of manners but an anti-Naturalist) have already been mentioned. Victor Cherbuliez (1829-1899), a constant writer in the *Revue des deux mondes* on politics and other subjects, also accomplished a long series of novels from *Le Comte Kostia* (1863) onwards, of which the most remarkable are that just named, *Le Roman d'une honnête femme* (1866), and *Méta Holdenis* (1873). With something of Balzac and more of Feuillet, Cherbuliez mixed with his observation of society a dose of sentimental and popular romance which offended the younger critics of his day, but he had solid merits. Gustave Droz (b. 1832) devoted himself chiefly to short stories sufficiently "free" in subject (*Monsieur, madame et bébé, Entre nous, &c.*) but full of fancy, excellently written, and of a delicate wit in one sense if not in all. André Theuriot (1833-1907) began with poetry but diverged to novels, in which the scenery of France and especially of its great forests is used with much skill; *Le Fils Maugers* (1879) may be mentioned out of many as a specimen. Léon Cladel (1835-1892), whose most remarkable work was *Les Veuves-pieds* (1874), had, as this title of itself shows, Naturalist leanings; but with a quaint Romantic tendency in prose and verse.

The Naturalists proper chiefly developed or seemed to develop one side of Balzac, but almost entirely abandoned his Romantic element. They aimed first at exact and almost photographic delineation of the accidents of modern life, and secondly at still more uncompromising non-suppression of the essential features and functions of that life which are usually suppressed. This school may be represented in chief by four novelists (really three, as two of them were brothers who wrote together till the rather early death of one of them), Émile Zola (1840-1903), Alphonse Daudet (1840-1897), and Edmond (1822-1897) and Jules (1830-1870) de Goncourt. The first, of Italian extraction and Marseillais birth, began by work of undecided kinds and was always a critic as well as a novelist. Of this first stage *Contes à Ninon* (1864) and *Thérèse Raquin* (1867) deserve to be specified. But after 1870 Zola entered upon a huge scheme (suggested no doubt by the *Comédie humaine*) of tracing the fortunes in every branch, legitimate and illegitimate, and in every rank of society of a family, *Les Rougon-Macquart*, and carried it out in a full score of novels during more than as many years. He followed this with a shorter series on places, *Paris, Rome, Lourdes*, and lastly by another of strangely apocalyptic tone, *Fécondité, Travail, Vérité*, the last a story of the Dreyfus case, retrospective and, as it proved, prophetic. The extreme repulsiveness of much of his work, and the overdone detail of almost the whole of it, caused great prejudice against him, and will probably always prevent his being ranked among the greatest novelists; but his power is indubitable, and in passages, if not in whole books, does itself justice.

MM. de Goncourt, besides their work in Naturalist (they would have preferred to call it "Impressionist") fiction, devoted themselves especially to study and collection in the fine arts, and produced many volumes on the historical side of these, volumes distinguished by accurate and careful research. This

quality they carried, and the elder of them after his brother's death continued to carry, into novel-writing (*Renée Mauperin, Germinie Lacerteux, Chérie, &c.*) with the addition of an extraordinary care for peculiar and, as they called it, "personal" diction. On the other hand, Alphonse Daudet (who with the other three, Flaubert to some extent, and the Russian novelist Turgenieff, formed a sort of *club* or literary club) mixed with some Naturalism a far greater amount of fancy and wit than his companions allowed themselves or could perhaps attain; and in the *Tartarin* series (dealing with the extravagances of his fellow-Provençaux) added not a little to the gaiety of Europe. His other novels (*Fromont jeune et Risler aîné, Jack, Le Nabab, &c.*), also very popular, have been variously judged, there being something strangely like plagiarism in some of them, and in others, in fact in most, an excessive use of that privilege of the novelist which consists in introducing real persons under more or less disguise. It should be observed in speaking of this group that the Goncourts, or rather the survivor of them, left an elaborate *Journal* disfigured by spite and bad taste, but of much importance for the appreciation of the personal side of French literature during the last half of the century.

In 1880 Zola, who had by this time formed a regular school of disciples, issued with certain of them a collection of short stories, *Les Soirées de Médan*, which contains one of his own best things, *L'Attaque du moulin*, and also the capital story, *Boule de suif*, by Guy de Maupassant (1850-1893), who in the same year published poems, *Des vers*, of very remarkable if not strictly poetical quality. Maupassant developed during his short literary career perhaps the greatest powers shown by any French novelist since Flaubert (his sponsor in both senses) in a series of longer novels (*Une Vie, Bel Ami, Pierre et Jean, Fort comme la mort*) and shorter stories (*Monsieur Parent, Les Sœurs Rondoli, Le Horla*), but they were distorted by the Naturalist pessimism and grime, and perhaps also by the brain-disease of which their author died. M. J. K. Huysmans (b. 1848), also a contributor to *Les Soirées de Médan*, who had begun a little earlier with *Marthe* (1876) and other books, gave his most characteristic work in 1884 with *Au rebours* and in 1891 with *La-bas*, stories of exaggerated and "satanic" pose, decorated with perhaps the extremest achievements of the school in mere ugliness and nastiness. Afterwards, by an obvious reaction, he returned to Catholicism. Of about the same date as these two are two other novelists of note, Julien Viaud ("Pierre Loti," b. 1850), a naval officer who embodied his experiences of foreign service with a faint dose of story and character interest, and a far larger one of elaborate description, in a series of books (*Asiade, Le Mariage de Loti, Madame Chrysanthème, &c.*), and M. Paul Bourget (b. 1852), an important critic as well as novelist who deflected the Naturalist current into a "psychological" channel, connecting itself higher with Stendhal, and composed in its books very popular in their way—*Cruelle Enigme* (1885), *Le Disciple, Terre promise, Cosmopolis*. As a contrast or complement to Bourget's "psychological" novel may be taken the "ethical" novel of Edouard Rod (1857-1909)—*La Vie priée de Michel Tessier* (1893), *Le Sens de la vie, Les Trois Cœurs*. Contemporary with these as a novelist though a much older man, and occupied at different times of his life with verse and with criticism, came Anatole France (b. 1844), who in *Le Crime de Silvestre Bonnard, La Rôtisserie de la reine Pédauque, Le Lys rouge*, and others, has made a kind of novel as different from the ordinary styles as Pierre Loti's, but of far higher appeal in its wit, its subtle fancy, and its perfect French. Ferdinand Fabre (1830-1898) and René Bazin (b. 1853) represent the union, not too common in the French novel, of orthodoxy in morals and religion with literary ability. Further must be mentioned Paul Hervieu (b. 1857), a dramatist rather than a novelist; the brothers Margueritte (Paul, b. 1860, Victor, b. 1866), especially strong in short stories and passages; another pair of brothers of Belgian origin writing under the name of "J. H. Rosny"—Zolaists partly converted not to religion but to science and a sort of non-Christian virtue; the ingenious and amusing, if not exactly moral, brilliancy of Marcel Prévost (b. 1862); the

series of historical events has ever perhaps received treatment at the same time from so many different points of view, and by writers of such varied literary excellence, among whom it must, however, be said that the purely royalist side is hardly at all represented. One of the earliest of these histories is that of François Mignet (1796-1884), a sober and judicious historian of the older school, also well known for his *Histoire de Marie Stuart*. About the same time was begun the brilliant if not extremely trustworthy work of Adolphe Thiers (1797-1877) on the Revolution, which established the literary reputation of the future president of the French republic, and was at a later period completed by the *Histoire du consulat et de l'empire*. The downfall of the July monarchy and the early years of the empire witnessed the publication of several works of the first importance on this subject. Barante contributed histories of the Convention and the Directory, but the three books of greatest note were those of Lamartine, Jules Michelet (1798-1874), and Louis Blanc (1811-1882). Lamartine's *Histoire des Girondins* is written from the constitutional-republican point of view, and is sometimes considered to have had much influence in producing the events of 1848. It is, perhaps, rather the work of an orator and poet than of an historian. The work of Michelet is of a more original character. Besides his history of the Revolution, Michelet wrote an extended history of France, and a very large number of smaller works on historical, political and social subjects. His imaginative powers are of the highest order, and his style stands alone in French for its strangely broken and picturesque character, its turbid abundance of striking images, and its somewhat sombre magnificence, qualities which, as may easily be supposed, found full occupation in a history of the Revolution. The work of Louis Blanc was that of a sincere but ardent republican, and is useful from this point of view, but possesses no extraordinary literary merit. The principal contributions to the history of the Revolution of the third quarter of the century were those of Quinet, Lanfrey and Taine. Edgar Quinet (1803-1875), like Louis Blanc a devotee of the republic and an exile for its sake, brought to this one of his latest works a mind and pen long trained to literary and historical studies; but *La Révolution* is not considered his best work. P. Lanfrey devoted himself with extraordinary patience and acuteness to the destruction of the Napoleonic legend, and the setting of the character of Napoleon I. in a new, authentic and very far from favourable light. And Taine, after distinguishing himself, as we have mentioned, in literary criticism (*L'histoire de la littérature anglaise*), and attaining less success in philosophy (*De l'intelligence*), turned in *Les Origines de la France moderne* to an elaborate discussion of the Revolution, its causes, character and consequences, which excited some commotion among the more ardent devotees of the principles of '89. To return from this group, we must notice J. F. Michaud (1767-1839), the historian of the crusades, and François Pierre Guillaume Guizot (1787-1874), who, like his rival Thiers, devoted himself much to historical study. His earliest works were literary and linguistic, but he soon turned to political history, and for the last half-century of his long life his contributions to historical literature were almost incessant and of the most various character. The most important are the histories *Des Origines du gouvernement représentatif*, *De la révolution d'Angleterre*, *De la civilisation en France*, and latterly a *Histoire de France*, which he was writing at the time of his death. Among minor historians of the earlier century may be mentioned Prosper Duverger de Hauranne (1708-1831) (*Gouvernement parlementaire en France*), J. J. Ampère (1800-1864) (*Histoire romaine à Rome*), Auguste Arthur Beugnot (1797-1865) (*Destruction du paganisme d'occident*), J. O. B. de Cléron, comte d'Haussonville (*La Réunion de la Lorraine à la France*), Achille Tendelle de Vaulabelle (1799-1870) (*Les Deux Restaurations*). In the last quarter of the century, under the department of history, the most remarkable names were still those of Taine and Renan, the former being distinguished for thought and matter, the latter for style. Indeed it may be here proper to remark that Renan, in the kind of elaborated semi-poetic style which has most characterized the prose of the 19th century in

all countries of Europe, takes pre-eminence among French writers even in the estimation of critics who are not enamoured of his substance and tone. But, under the influence of Taine to some extent and of a general European tendency still more, France during this period attained or recovered a considerable place for what is called "scientific" history—the history which while, in some cases, though not in all, not neglecting the development of style attaches itself particularly to "the document," on the one hand, and to philosophical arrangement on the other. The chief representative of the school was probably Albert Sorel (1842-1906), whose various handlings of the Revolutionary period (including an excursion into partly literary criticism in the shape of an admirable monograph on Madame de Staël) have established themselves once for all. In a wider sweep Ernest Lavisse (b. 1842), who has dealt mainly with the 18th century, may hold a similar position. Of others, older and younger, the duc de Broglie (1821-1901), who devoted himself also to the 18th century and especially to its secret diplomacy; Gaston Boissier (b. 1823), a classical scholar rather than an historian proper, and one of the latest masters of the older French academic style; Thureau-Dangin (b. 1837), a student of mid 19th-century history; Henri Houssaye (b. 1848), one of the Napoleonic period; Gabriel Hanotaux (b. 1853), an historian of Richelieu and other subjects, and a practical politician, may be mentioned. A large accession has also been made to the publication of older memoirs—that important branch of French literature from almost the whole of its existence since the invention of prose.

Summary and Conclusion.—We have in these last pages given such an outline of the 19th-century literature of France as seemed convenient for the completion of what has gone before. It has been already remarked that the nearer approach is made to our own time the less is it possible to give exhaustive accounts of the individual cultivators of the different branches of literature. It may be added, perhaps, that such exhaustiveness becomes, as we advance, less and less necessary, as well as less and less possible. The individual poet of to-day may and does produce work that is in itself of greater literary value than that of the individual trouvère. As a matter of literary history his contribution is less remarkable because of the examples he has before him and the circumstances which he has around him. Yet we have endeavoured to draw such a sketch of French literature from the *Chanson de Roland* onwards that no important development and hardly any important partaker in such development should be left out. A few lines may, perhaps, be now profitably given to summing up the aspects of the whole, remembering always that, as in no case is generalization easier than in the case of the literary aspects and tendencies of periods and nations, so in no case is it apt to be more delusive unless corrected and supported by ample information of fact and detail.

At the close of the 11th century and at the beginning of the 12th we find the vulgar tongue in France not merely in fully organized use for literary purposes, but already employed in most of the forms of poetical writing. An immense outburst of epic and narrative verse has taken place, and lyrical poetry, not limited as in the case of the epics to the north of France, but extending from Roussillon to the Pas de Calais, completes this. The 12th century adds to these earliest forms the important development of the mystery, extends the subjects and varies the manner of epic verse, and begins the compositions of literary prose with the chronicles of St Denis and of Villehardouin, and the prose romances of the Arthurian cycle. All this literature is so far connected purely with the knightly and priestly orders, though it is largely composed and still more largely dealt in by classes of men, trouvères and jongleurs, who are not necessarily either knights or priests, and in the case of the jongleurs are certainly neither. With a possible ancestry of Romance and Teutonic canticles, Breton *lais*, and vernacular legends, the new literature has a certain pattern and model in Latin and for the most part ecclesiastical compositions. It has the sacred books and the legends of the saints for examples of narrative, the rhythm of the hymns for a guide to metre, and the ceremonies of the church for a stimulant to dramatic performance. By degrees

his 12th century, forms of literature which busy them the unprivileged classes begin to be born. The uses every phase of life for its subject; the folk-song elegance and does not lose raciness and truth. In the 13th century, the medieval literature in France arrives at a prime which lasts until the first quarter of the 14th. epics lose something of their savage charms, the polished of Provence quickly perishes. But in the provinces the more prevailing tongue nothing is wanting to development. The language itself has shaken off all its incapacities, and, though not yet well adapted to the requirements of modern life and study, is in every way the demands made upon it by its own time. The germ contained in the fabliau and quickened by the produces the profane drama. Ambitious works of merit of various kinds are published; *Aucassin et Nicolette* is by side with the *Vie de Saint Louis*, the *Jeu de la* *13th Le Miracle de Théophile*, the *Roman de la rose* *Roman du Renart*. The earliest notes of ballads and are heard; endeavours are made with zeal, and not without understanding, to naturalize the wisdom of the in France, and in the graceful tongue that France

Romance in prose and verse, drama, history, songs, story and even erudition, are all represented and ad worthily. Meanwhile all nations of western Europe re to France for their literary models and subjects, greatest writers in English, German; Italian, content as with adaptations of Chrétien de Troyes, of Benoit More, and of a hundred other known and unknown and fabulists. But this age does not last long. The has been put to all the uses of which it is as yet capable; in their sameness begin to pall upon reader and hearer; enormous evils of the civil and religious state reflect themselves in literature. The old forms die out or are only in half-lifeless travesties. The brilliant colouring art, and the graceful science of ballade and rondeau ce Lescaurel and Deschamps, alone maintain the literary n of the time. Towards the end of the 14th century authors and political writers import many terms of art, the language to uses for which it is as yet unbandy, t the beginning of the next age Charles d'Orléans by al grace and the virtue of the forms he used emerges mass of writers. Throughout the 15th century the enriching or at least increasing the vocabulary goes on, et no organizing hand appears to direct the process. ends alone in merit as in peculiarity. But in this time literature and the literature of the floating popular st acquire an immense extension—all or almost all the spirit being concentrated in the rough farce and rougher

while all the literary skill is engrossed by insipid *vers* and pedants. Then comes the grand upheaval enaissance and the Reformation. An immense influx s, of thought to make the science living, of new terms s, the thought, takes place, and a band of literary appear of power enough to master and get into shape id mass. Rabelais, Amyot, Calvin and Herberay French prose; Marot, Ronsard and Regnier refashion erse. The *Pléiade* introduces the drama as it is to be language that is to help the drama to express itself. re for the first time throws invention and originality other form than verse or than prose fiction. But by the e century the tide has receded. The work of arrange- been but half done, and there are no master spirits mplete it. At this period Malherbe and Balzac make earance. Unable to deal with the whole problem, they e to deal with part of it, and to reject a portion of the which they feel themselves unfit to be stewards. Balzac ecessors make of French prose an instrument faultless rable in precision, unequalled for the work for which ut unfit for certain portions of the work which it was : to perform. Malherbe, seconded by Boileau, makes . verse an instrument suited only for the purposes of the

drama of Euripides, or rather of Seneca, with or without its chorus, and for a certain weakened echo of those choruses, under the name of lyrics. No French verse of the first merit other than dramatic is written for two whole centuries. The drama soon comes to its acme, and during the succeeding time usually maintains itself at a fairly high level until the death of Voltaire. But prose lends itself to almost everything that is required of it, and becomes constantly a more and more perfect instrument. To the highest efforts of pathos and sublimity its vocabulary and its arrangement likewise are still unsuited, though the great preachers of the 17th century do their utmost with it. But for clear exposition, smooth and agreeable narrative, sententious and pointed brevity, witty repartee, it soon proves itself to have no superior and scarcely an equal in Europe. In these directions practitioners of the highest skill apply it during the 17th century, while during the 18th its powers are shown to the utmost of their variety by Voltaire, and receive a new development at the hands of Rousseau. Yet, on the whole, it loses during this century. It becomes more and more unfit for any but trivial uses, and at last it is employed for those uses only. Then occurs the Revolution, repeating the mighty stir in men's minds which the Renaissance had given, but at first experiencing more difficulty in breaking up the ground and once more rendering it fertile. The faulty and incomplete genius of Chateaubriand and Madame de Staël gives the first evidence of a new growth, and after many years the Romantic movement completes the work. Whether the force of that movement is now, after three-quarters of a century, spent or not, its results remain. The poetical power of French has been once more triumphantly proved, and its productiveness in all branches of literature has been renewed, while in that of prose fiction there has been almost created a new class of composition. In the process of reform, however, not a little of the finish of French prose style has been lost, and the language itself has been affected in something the same way as it was affected by the less judicious innovations of the Ronsardists. The pedantry of the *Pléiade* led to the preposterous compounds of Du Bartas; the passion of the Romantics for foreign tongues and for the *mot propre* has loaded French with foreign terms on the one hand and with *argot* on the other, while it is questionable whether the *vers libre* is really suited to the French genius. There is, therefore, room for new Malherbes and Balzacs, if the days for Balzacs and Malherbes had not to all appearance passed. Should they be once more forthcoming, they have the fault as well as the success of their predecessors to guide them.

Finally, we may sum up even this summary. For volume and merit taken together the product of these eight centuries of literature excels that of any European nation, though for individual works of the supremest excellence they may perhaps be asked in vain. No French writer is lifted by the suffrages of other nations—the only criterion when sufficient time has elapsed—to the level of Homer, of Shakespeare, or of Dante, who reign alone. Of those of the authors of France who are indeed of the thirty but attain not to the first three Rabelais and Molière alone unite the general suffrage, and this fact roughly but surely points to the real excellence of the literature which these men are chosen to represent. It is great in all ways, but it is greatest on the lighter side. The house of mirth is more suited to it than the house of mourning. To the latter, indeed, the language of the unknown marvel who told Roland's death, of him who gave utterance to Camilla's wrath and despair, and of Victor Hugo, who sings how the mountain wind makes mad the lover who cannot forget, has amply made good its title of entrance. But for one Frenchman who can write admirably in this strain there are a hundred who can tell the most admirable story, formulate the most pregnant reflection, point the acutest jest. There is thus no really great epic in French, few great tragedies, and those imperfect and in a faulty kind, little prose like Milton's or like Jeremy Taylor's, little verse (though more than is generally thought) like Shelley's or like Spenser's. But there are the most delightful short tales, both in prose and in verse, that the world has ever seen, the most polished jewelry of reflection that has

ever been wrought, songs of incomparable grace, comedies that must make men laugh as long as they are laughing animals, and above all such a body of narrative fiction, old and new, prose and verse, as no other nation can show for art and for originality, for grace of workmanship in him who fashions, and for certainty of delight to him who reads.

BIBLIOGRAPHY.—The most elaborate book on French literature as a whole is that edited by Petit de Julleville, and composed of chapters by different authors, *Histoire de la langue et de la littérature françaises* (8 vols., Paris, 1896–1899). Unfortunately these chapters, some of which are of the highest excellence, are of very unequal value; they require connexions which are not supplied, and there is throughout a neglect of minor authors. The bibliographical indications are, however, most valuable. For a survey in a single volume Lanson's *Histoire* has superseded the older but admirable manuals of Demogot and Gêruzez, which, however, are still worth consulting. Brunetière's *Manuel* (translated into English) is very valuable with the cautions above given; and the large *Histoire de la langue française depuis le seizième siècle* of Godefroy supplies copious and well-chosen extracts with much biographical information. In English there is an extensive *History* by H. van Laun (3 vols., 1874, &c.); a *Short History* by Saintsbury (1882); 6th ed., continued to the end of the century, 1901; and a *History* by Professor Dowden (1895).

To pass to special periods—the fountain-head of the literature of the middle ages is the ponderous *Histoire littéraire* already referred to, which, notwithstanding that it extended to 27 quarto volumes in 1906, and had occupied, with interruptions, 150 years in publication, had only reached the 14th century. Many of the monographs which it contains are the best authorities on their subjects, such as that of P. Paris on the early chansonniers, of V. Leclerc on the fabliaux, and of Littré on the romans d'aventures. For the history of literature before the 11th century, the period mainly Latin, J. J. Ampère's *Histoire littéraire de la France avant Charlemagne, sous Charlemagne, et jusqu'au onzième siècle* is the chief authority. Léon Gautier's *Épopées françaises* (5 vols., 1878–1897) contains almost everything known concerning the chansons de geste. P. Paris's *Romans de la table ronde* was long the main authority for this subject, but very much has been written recently in France and elsewhere. The most important of the French contributions, especially those by Gaston Paris (whose *Histoire poétique de Charlemagne* has been reprinted since his death), will be found in this subject, but for more than thirty years has been the chief receptacle of studies on old French literature. On the cycle of Reynard the standard work is Rothe, *Les Romans de Renart*. All parts of the lighter literature of old France are excellently treated by Lenient, *Le Sotire au moyen âge*. The early theatre has been frequently treated by the brothers Parfaict (*Histoire du théâtre français*), by Fabre (*Les Comtes de la Basoche*), by Leroy (*Étude sur les mystères*), by Aubertin (*Histoire de la langue et de la littérature française au moyen âge*). This latter book will be found a useful summary of the whole medieval period. The historical, dramatic and oratorical sections are especially full. On a smaller scale but of unsurpassed authority is G. Paris's *Littérature du moyen âge* translated into English.

On the 16th century an excellent handbook is that by Darmesteter and Hatzfeld; and the recent *Literature of the French Renaissance* of A. Tilley (2 vols., 1904) is of high value. Sainte-Beuve's *Tableau* has been more than once referred to. Ebert (*Entwicklungsgeschichte der französischen Tragödie vornehmlich im 16^{ten} Jahrhundert*) is the chief authority for dramatic matters. Essays and volumes on periods and sub-periods since 1600 are innumerable; but those who desire thorough acquaintance with the literature of these three hundred years should read as widely as possible in all the critical work of Sainte-Beuve, of Schérer, of Faguet and Brunetière—which may be supplemented *ad libitum* from that of other critics mentioned above. The series of volumes entitled *Les grands écrivains français*, now pretty extensive, is generally very good, and Catulle Mendès's invaluable book on 19th-century poetry has been cited above. As a companion to the study of poetry E. Crepet's *Poètes français* (4 vols., 1861), an anthology with introductions by Sainte-Beuve and all the best critics of the day, cannot be surpassed, but to it may be added the later *Anthologie des poètes français du XIX^e siècle* (1877–1879). (G. SA.)

FRENCH POLISH, a liquid for polishing wood, made by dissolving shellac in methylated spirit. There are four different tints, brown, white, garnet and red, but the first named is that most extensively used. All the tints are made in the same manner, with the exception of the red, which is a mixture of the brown polish and methylated spirit with either Saunders wood or Bismarck brown, according to the strength of colour required. Some woods, and especially mahogany, need to be stained before they are polished. To stain mahogany mix some bichromate of potash in hot water according to the depth of colour required. After staining the wood the most approved method of filling the

grain is to rub in fine plaster of Paris (wet), wiping off before it "sets." After this is dry it should be oiled with linseed oil and thoroughly wiped off. The wood is then ready for the polish, which is put on with a rubber made of wadding covered with linen rag and well wetted with polish. The polishing process has to be repeated gradually, and after the work has hardened, the surface is smoothed down with fine glass-paper, a few drops of linseed oil being added until the surface is sufficiently smooth. After a day or two the surface can be cleared by using a fresh rubber with a double layer of linen, removing the top layer when it is getting hard and finishing off with the bottom layer.

FRENCH REVOLUTION, THE. Among the many revolutions which from time to time have given a new direction to the political development of nations the French Revolution stands out as at once the most dramatic in its incidents and the most momentous in its results. This exceptional character is, indeed, implied in the name by which it is known; for France has experienced many revolutions both before and since that of 1789, but the name "French Revolution," or simply "the Revolution," without qualification, is applied to this one alone. The causes which led to it: the gradual decay of the institutions which France had inherited from the feudal system, the decline of the centralized monarchy, and the immediate financial necessities that compelled the assembling of the long neglected states-general in 1789, are dealt with in the article on FRANCE: *History*. The successive constitutions, and the other legal changes which resulted from it, are also discussed in their general relation to the growth of the modern French polity in the article FRANCE (*Law and Institutions*). The present article deals with the progress of the Revolution itself from the convocation of the states-general to the coup d'état of the 18th Brumaire which placed Napoleon Bonaparte in power.

The elections to the states-general of 1789 were held in unfavourable circumstances. The failure of the harvest of 1788 and a severe winter had caused widespread distress. The government was weak and despised, and its agents were afraid or unwilling to quell outbreaks of disorder. At the same time the longing for radical reform and the belief that it would be easy were almost universal. The cahiers or written instructions given to the deputies covered well-nigh every subject of political, social or economic interest, and demanded an amazing number of changes. Amid this commotion the king and his ministers remained passive. They did not even determine the question whether the estates should act as separate bodies or deliberate collectively. On the 5th of May the states-general were opened by Louis in the Salle des Menus Plaisirs at Versailles. Barentin, the keeper of the seals, informed them that they were free to determine whether they would vote by orders or vote by head. Necker, as director-general of the finances, set forth the condition of the treasury and proposed some small reforms. The Tiers État (Third Estate) was dissatisfied that the question of joint or separate deliberation should have been left open. It was aware that some of the nobles and many of the inferior clergy agreed with it as to the need for comprehensive reform. Joint deliberation would ensure a majority to the reformers and therefore the abolition of privileges and the extinction of feudal rights of property. Separate deliberation would enable the majority among the nobles and the superior clergy to limit reform. Hence it became the first object of the Tiers État to effect the amalgamation of the three estates.

The conflict between those who desired and those who resisted amalgamation took the form of a conflict over the verification of the powers of the deputies. The Tiers État insisted that the deputies of all three estates should have their powers verified in common as the first step towards making them all members of one House. It resolved to hold its meetings in the Salle des Menus Plaisirs, whereas the nobles and the clergy met in smaller apartments set aside for their exclusive use. It refrained from taking any step which might have implied that it was an organized assembly, and persevered in regarding itself as a mere crowd of individual members incapable of transacting business. Meanwhile the clergy and

Opening
of the
States-
General.

Conflict
between
the Three
Estates.

nobles began a separate verification of their powers. But of the nobles and a great many of the clergy voted against procedure. On the 7th the Tiers État sent deputations to the other estates to union, while the clergy sent a deputation with the proposal that each estate should name members to discuss the best method of verifying powers. The Tiers État accepted the proposal and conferences were held, without result. It then made another appeal to the clergy which was almost successful. The king interposed with a command for the renewal of the conferences. They were resumed the presidency of Barentin, but again to no purpose.

On the 10th of June Sieyès moved that the Tiers État should last time invite the First and Second Estates to join in the action of powers and announce that, whether they did or not, the work of verifying would begin forthwith. The motion carried by an immense majority. As there was no response, the Tiers État on the 12th named Bailly provisional president and commenced verification. Next day three curés of Poitou went to have their powers verified. Other clergymen followed.

When the work of verification was over, a title had to be found for the body thus created, which would no longer accept the name of the Tiers État. On the 15th Sieyès proposed that the body should entitle themselves the Assembly of the known and acknowledged representatives of the French nation. Mirabeau, Mounier and others proposed various appellations. But success was gained for Legrand, an obscure deputy who proposed the name of National Assembly. Withdrawing his own name, Sieyès adopted Legrand's suggestion, which was carried by 17 votes to 90. The Assembly went on to declare that it would discharge the debts of the crown under the safeguard of the national law and that all existing taxes, although illegal as having been imposed without the consent of the people, should continue to be paid until the day of dissolution.

These proceedings the Tiers État and a few of the clergy considered themselves the national legislature. Then and thereafter the National Assembly assumed full sovereign and constituent powers. Nobles and clergy might come in if they pleased, but it could do without them.

The king's assent to its measures would be convenient, if necessary. This boldness was rewarded, for on the 19th the king decided by a majority of one in favour of joint verification.

On the same day the nobles voted an address to the king condemning the action of the Tiers État. Left to himself, Louis XVI. had been too inert for resistance. But the queen and other, the count of Artois, with some of the ministers and others, urged him to make a stand. A Séance Royale was held for the 22nd and workmen were sent to prepare the Salle des Menus Plaisirs for the ceremony. On the 20th Bailly and the clergy proceeded to the hall and found it barred against their entrance. Thereupon they adjourned to a neighbouring tennis court, where Mounier proposed that they should swear not to separate until they had established the constitution.

With a solitary exception they swore and the Oath of the Tennis Court became an era in French history. As the ministers could not agree on the policy which the king should announce in the Séance Royale, it was postponed to the 23rd. The Assembly found shelter in the church of St. Louis where it was joined by the main body of the clergy and by many of the nobles.

In the Séance Royale Louis made known his will that the estates should deliberate apart, and declared that if they should refuse to help him he would do by his sole authority what was necessary for the happiness of his people. When he quitted the chamber of the clergy and most of the nobles retired to their private chambers. But the rest, together with the Tiers État, Mirabeau and others, declared that, as they had come by the will of the nation, force only should make them withdraw. "I am a Frenchman," said Sieyès, "you are to-day what you were yesterday." With one voice the Assembly proclaimed its rights on to its former decrees and the inviolability of its members. Mirabeau and in Paris popular feeling was clamorous for the king to stand by and against the court. During the next few days

many of the clergy and nobles, including the archbishop of Paris and the duke of Orleans, joined the Assembly. Louis tamely accepted his defeat. He recalled Necker, who had resigned after the Séance Royale. On the 27th he wrote to those clerical and noble deputies who still held out, urging submission. By the end of July the joint verification of powers was completed. The last trace of the historic States-General disappeared and the National Assembly was perfect. On the same day it claimed an absolute discretion by a decree that the mandates of the electors were not binding on its members.

Having failed in their first attempt on the Assembly, the Court party resolved to try what force could do. A large number of troops, chiefly foreign regiments in the service of France, were concentrated near Paris under the command of the marshal de Broglie. On Mirabeau's motion the Assembly voted an address to the king asking for their withdrawal. The king replied that the troops were not meant to act against the Assembly, but intimated his purpose of transferring the session to some provincial town. On the same day he dismissed Necker and ordered him to quit Versailles. These acts led to the first insurrection of Paris. The capital had long been in a dangerous condition. Bread was dear and employment was scarce. The measures taken to relieve distress had allured a multitude of needy and desperate men from the surrounding country. Among the middle class there already existed a party, consisting of men like Danton or Camille Desmoulins, which was prepared to go much further than any of the leaders of the Assembly. The rich citizens were generally fund-holders, who regarded the Assembly as the one bulwark against a public bankruptcy. The duke of Orleans, a weak and dissolute but ambitious man, had conceived the hope of supplanting his cousin on the throne. He strained his wealth and influence to recruit followers and to make mischief. The gardens of his residence, the Palais Royal, became the centre of political agitation. Ever since the elections virtual freedom of the press and freedom of speech had prevailed in Paris. Clubs were multiplied and pamphlets came forth every hour. The municipal officers who were named by the Crown had little influence with the citizens. The police were a mere handful. Of the two line regiments quartered in the capital, one was Swiss and therefore trusty; but the other, the Gardes Françaises, shared all the feelings of the populace.

On the 12th of July Camille Desmoulins announced the dismissal of Necker to the crowd in the Palais Royal. Warned by his eloquence, they sallied into the street. Part of Broglie's troops occupied the Champs Élysées and the Place Louis Quinze. After one or two petty encounters with the mob they were withdrawn, either because their temper was uncertain or because their commanders shunned responsibility. Paris was thus left to the rioters, who seized arms wherever they could find them, broke open the jails, burnt the octroi barriers and soon had every man's life and goods at their discretion. Citizens with anything to lose were driven to act for themselves. For the purpose of choosing its representatives in the states-general the Third Estate of Paris had named 300 electors. Their function once discharged, these men had no public character, but they resolved that they would hold together in order to watch over the interests of the city. After the Séance Royale the municipal authority, conscious of its own weakness, allowed them to meet at the Hôtel de Ville, where they proceeded to consider the formation of a civic guard. On the 13th, when all was anarchy in Paris, they were joined by Fleselles, Provost of the Merchants, and other municipal officers. The project of a civic guard was then adopted. The insurrection, however, ran its course unchecked. Crowds of deserters from the regular troops swelled the ranks of the insurgents. They attacked the Hôtel des Invalides and carried off all the arms which were stored there. With the same object they assailed the Bastille. The garrison was small and disheartened, provisions were short, and after some hours' fighting De Launay the governor surrendered on promise of quarter. He and several of his men were, notwithstanding, butchered by the mob before they could be brought to

Dismissal of Necker.

Rioting in Paris.

Fall of the Bastille, July 14, 1789.

the Hôtel de Ville. As all Paris was in the hands of the insurgents, the king saw the necessity of submission. On the morning of the 13th he entered the hall of the Assembly to announce that the troops would be withdrawn. Immediately afterwards he dismissed his new ministers and recalled Necker. Thereupon the princes and courtiers most hostile to the National Assembly, the count of Artois, the prince of Condé, the duke of Bourbon and many others, feeling themselves no longer safe, quitted France. Their departure is known as the first emigration.

The capture of the Bastille was hailed throughout Europe as symbolizing the fall of absolute monarchy, and the victory of the insurgents had momentous consequences. Recognizing the 300 electors as a temporary municipal government, the Assembly sent a deputation to confer with them at the Hôtel de Ville, and on a sudden impulse one of these deputies, Bailly, lately president of the Assembly, was chosen to be mayor of Paris. The marquis Lafayette, doubly popular as a veteran of the American War and as one of the nobles who heartily upheld the cause of the Assembly, was chosen commandant of the new civic force, thenceforwards known as the National Guard. On the 17th Louis himself visited Paris and gave his sanction to the new authorities. In the course of the following weeks the example of Paris was copied throughout France. All the cities and towns set up new elective authorities and organized a National Guard. At the same time the revolution spread to the country districts. In most of the provinces the peasants rose and stormed and burnt the houses of the *seigneurs*, taking peculiar care to destroy their title-deeds. Some of the *seigneurs* were murdered and the rest were driven into the towns or across the frontier. Amid the universal confusion the old administrative system vanished. The intendants and sub-delegates quitted or were driven from their posts. The old courts of justice, whether royal or feudal, ceased to act. In many districts there was no more police, public works were suspended and the collection of taxes became almost impossible. The insurrection of July really ended the *ancien régime*.

Disorder in the provinces led directly to the proceedings on the famous night of the 4th of August. While the Assembly was considering a declaration which might claim revolt, the vicomte de Noailles and the duc d'Aiguillon moved that it should proclaim equality of taxation and the suppression of feudal burdens. Other deputies rose to demand the repeal of the game laws, the enfranchisement of such serfs as were still to be found in France, and the abolition of tithes and of feudal courts and to renounce all privileges, whether of classes, of cities, or of provinces. Amid indescribable enthusiasm the Assembly passed resolution after resolution embodying these changes. The resolutions were followed by decrees sometimes hastily and unskillfully drawn. In vain Sieyès remarked that in extinguishing tithes the Assembly was making a present to every landed proprietor. In vain the king, while approving most of the decrees, tendered some cautious criticisms of the rest. The majority did not, indeed, design to confiscate property wholesale. They drew a distinction between feudal claims which did and did not carry a moral claim to compensation. But they were embarrassed by the wording of their own decrees and forestalled by the violence of the people. The proceedings of the 4th of August issued in a wholesale transfer of property from one class to another without any indemnity for the losers.

The work of drafting a constitution for France had already been begun. Parties in the Assembly were numerous and ill-defined. The Extreme Right, who desired to keep the government as it stood, were a mere handful. The Right who wanted to revive, as they said, the ancient constitution, in other words, to limit the king's power by periodic States-General of the old-fashioned sort, were more numerous and had able chiefs in Cazalès and Maury, but strove in vain against the spirit of the time. The Right Centre, sometimes called the Monarchiens, were a large body and included several men of talent, notably Mounier and Malouet, as well as many men of rank and wealth. They desired a constitution like

that of England which should reserve a large executive power to the king, while entrusting the taxing and legislative powers to a modern parliament. The Left or Constitutionals, known afterwards as the Feuillants, among whom Barnave and Charles and Alexander Lameth were conspicuous, also wished to preserve monarchy but disdained English precedent. They were possessed with feelings then widespread, weariness of arbitrary government, hatred of ministers and courtiers, and distrust not so much of Louis as of those who surrounded him and influenced his judgment. Republicans without knowing it, they grudged every remnant of power to the Crown. The Extreme Left, still more republican in spirit, of whom Robespierre was the most noteworthy, were few and had little power. Mirabeau's independence of judgment forbids us to place him in any party.

The first Constitutional Committee, elected on the 14th of July, had Mounier for its reporter. It was instructed to begin with drafting a Declaration of the Rights of Man. Six weeks were spent by the Assembly in discussing this document. The Committee then presented a report which embodied the principle of two Chambers. This principle contradicted the extreme democratic theories so much in fashion. It also offended the self-love of most of the nobles and the clergy who were loath that a few of their number should be erected into a House of Lords. The Assembly rejected the principle of two Chambers by nearly 20 to 1. The question whether the king should have a veto on legislation was next raised. Mounier contended that he should have an absolute veto, and was supported by Mirabeau, who had already described the unlimited power of a single Chamber as worse than the tyranny of Constantinople. The Left maintained that the king, as depositary of the executive, should be wholly excluded from the legislative power. Lafayette, who imagined himself to be copying the American constitution, proposed that the king should have a suspensive veto. Thinking that it would be politic to claim no more, Necker persuaded the king to intimate that he was satisfied with Lafayette's proposal. The suspensive veto was therefore adopted. As the king had no power of dissolution, it was an idle form. Mounier and his friends having resigned their places in the Constitutional Committee, it came to an end and the Assembly elected a new Committee which represented the opinions of the Left.

Soon afterwards a fresh revolt in Paris caused the king and the Assembly to migrate thither. The old causes of disorder were still working in that city. The scarcity of bread was set down to conspirators against the Revolution. Riots were frequent and persons supposed hostile to the Assembly and the nation were murdered with impunity. The king still had counsellors who wished for his departure as a means to regaining freedom of action. At the end of September the Flanders regiment came to Versailles to reinforce the Gardes du Corps. The officers of the Gardes du Corps entertained the officers of the Flanders regiment and of the Versailles National Guard at dinner in the palace. The king, queen and dauphin visited the company. There followed a vehement outbreak of loyalty. Rumour enlarged the incident into a military plot against freedom. Those who wanted a more thorough revolution wrought up the crowd and even respectable citizens wished to have the king among them and amenable to their opinion. On the 5th of October a mob which had gathered to assault the Hôtel de Ville was diverted into a march on Versailles. Lafayette was slow to follow it and, when he arrived, took insufficient precautions. At daybreak on the 6th some of the rioters made their way into the palace and stormed the apartment of the queen who escaped with difficulty. At length the National Guards arrived and the mob was quieted by the announcement that the king had resolved to go to Paris. The Assembly declared itself inseparable from the king's person. Louis and his family reached Paris on the same evening and took up their abode in the Tuileries. A little later the Assembly established itself in the riding school of the palace. Thenceforward the king and queen were to all intents prisoners. The Assembly itself was subject to constant

New municipality of Paris and National Guard.

Revolution in the provinces.

The 4th of August.

Parties in the Assembly.

Declaration of the Rights of Man.

The royal veto.

Removal of the royal family and Assembly to Paris.

intimidation. Many members of the Right gave up the struggle and emigrated, or at least withdrew from attendance, so that the Left became supreme.

Mirabeau had already taken alarm at the growing violence of the Revolution. In September he had foretold that it would

Mirabeau and the court.

not stop short of the death of both king and queen. After the insurrection of October he sought to communicate with them through his friend the comte de la Marck. In a remarkable correspondence he sketched a policy for the king. The abolition of privilege and the establishment of a parliamentary system were, he wrote, unalterable facts which it would be madness to dispute. But a strong executive authority was essential, and a king who frankly adopted the Revolution might still be powerful. In order to rally the sound part of the nation Louis should leave Paris, and, if necessary, he should prepare for a civil war; but he should never appeal to foreign powers. Neither the king nor the queen could grasp the wisdom of this advice. They distrusted Mirabeau as an unscrupulous adventurer, and were confirmed in this feeling by his demands for money. His correspondence with the court, although secret, was suspected. The politicians who envied his talents and believed him a rascal raised the cry of treason. In the Assembly Mirabeau, though sometimes successful on particular questions, never had a chance of giving effect to his policy as a whole. Whether even he could have controlled the Revolution is highly doubtful; but his letters and minutes drawn up for the king form the most striking monument of his genius (see MIRABEAU and MONTMORIN DE SAINT-HÉREM).

Early in the year 1790 a dispute with England concerning the frontier in North America induced the Spanish government

The Assembly and the royal power.

to claim the help of France under the Family Compact. This demand led the Assembly to consider in what hands the power of concluding alliances and of making peace and war should be placed. Mirabeau tried to keep the initiative for the king, subject to confirmation by the Chamber. On Barnave's motion the Assembly decreed that the legislature should have the power of war and peace and the king a merely advisory power. Mirabeau was defeated on another point of the highest consequence, the inclusion of ministers in the National Assembly. His colleagues generally adhered to the principle that the legislative and executive powers should be totally separate. The Left assumed that, if deputies could hold office, the king would have the means of corrupting the ablest and most influential. It was decreed that no deputy should be minister while sitting in the House or for two years after. Ministers excluded from the House being necessarily objects of suspicion, the Assembly was careful to allow them the least possible power. The old provinces were abolished, and France was divided anew into eighty departments. Each department

Reorganisation of France.

was subdivided into districts, cantons and communes. The main business of administration, even the levying of taxes, was entrusted to the elective local authorities. The judiciary was likewise made elective. The army and the navy were so organized as to leave the king but a small share in appointing officers and to leave the officers but scanty means of maintaining discipline. Even the cases in which the sovereign might be deposed were foreseen and expressly stated. Monarchy was retained, but the monarch was regarded as a possible traitor and every precaution was taken to render him harmless even at the cost of having no effective national government.

The distrust which the Assembly felt for the actual ministers led it to undertake the business of government as well as the

Executive committee of the Assembly.

business of reform. There were committees for all the chief departments of state, a committee for the army, a committee for the navy, another for diplomacy, another for finance. These committees sometimes asked the ministers for information, but rarely took their advice. Even Necker found the Assembly heedless of his counsels. The condition of the treasury became worse day by day. The yield of the indirect taxes fell off through the interruption of business, and the direct taxes were in large measure withheld, for want of an authority to enforce payment. With some trouble Necker

induced the Assembly to sanction first a loan of 30,000,000 livres and then a loan of 80,000,000 livres. The public having shown no eagerness to subscribe, Necker proposed that every man should be invited to make a patriotic contribution of one-fourth of his income. This expedient also failed. On the 10th of October 1789 Talleyrand, bishop of Autun, proposed

Confiscation of church property.

that the Assembly should take possession of the lands of the church. In November the Assembly enacted that they should be at the disposal of the nation, which would provide for the maintenance of the clergy. Since the church lands were supposed to occupy one-fifth of France, the Assembly thought that it had found an inexhaustible source of public wealth. On the security of the church lands it based a paper currency (the famous assignats). In December it ordered an issue to the amount of 400,000,000 livres. As the revenue still declined and the reforms enacted by the Assembly involved a heavy outlay, it recurred again and again to this expedient. Before its dissolution the Assembly had authorized the creation of 1,800,000,000 livres of assignats and the depreciation of its paper had begun. Finding that he had lost all credit with the Assembly, Necker resigned office and left France in September 1790.

The assignats.

Even the committees of the Assembly had far less power than the new municipal authorities throughout France. They really governed so far as there was any government.

Power of the municipalities and popular clubs.

Often full of public spirit, they lacked experience and in a time of peculiar difficulty had no guide save their own discretion. They opened letters, arrested suspects, controlled the trade in corn, and sent their National Guards on such errands as they thought proper.

The political clubs which sprang up all over the country often presumed to act as though they were public authorities (see

JACOBINS). The revolutionary journalists, Desmoulins in his *Révolutions de France et de Brabant*, Loustallot in his *Révolutions de Paris*, Marat in his *Ami du peuple*, continued to feed the

fire of discord. Amid this anarchy it became a practice for the National Guards of different districts to form federations, that

is, to meet and swear loyalty to each other and obedience to the laws made by the National Assembly. At the suggestion of the municipality of Paris the Assembly decreed a general federation

of all France, to be held on the anniversary of the fall of the Bastille. The ceremony took place in the Champ de Mars (July

14, 1790) in presence of the king, the queen, the Assembly, and an enormous concourse of spectators. It was attended by

deputations from the National Guards in every part of the kingdom, from the regular regiments, and from the crews of the

fleet. Talleyrand celebrated Mass, and Lafayette was the first to swear fidelity to the Assembly and the nation. In this gathering

the provincial deputations caught the revolutionary fever of Paris. Still graver was the effect upon the regular army. It

had been disaffected since the outbreak of the Revolution. The rank and file complained of their food, their lodging and

their pay. The non-commissioned officers, often intelligent and hard-working, were embittered by the refusal

of promotion. The officers, almost all nobles, rarely showed much concern for their men, and were often

Disaffection in the army.

mere courtiers and triflers. After the festival of the

federation the soldiers were drawn into the political clubs, and named regimental committees to defend their interests. Not

content with asking for redress of grievances, they sometimes seized the regimental chest or imprisoned their officers. In

August a formidable outbreak at Nancy was only quelled with much loss of life. Desertion became more frequent than ever, and

the officers, finding their position unbearable, began to emigrate. Similar causes produced an even worse effect upon the navy.

By its rough handling of the church the Assembly brought fresh trouble upon France. The suppression of tithes and the

confiscation of church lands had reduced the clergy to live on whatever stipend the legislature might think fit to give them. A law of February 1790 suppressed the religious orders not engaged in education or in works of

Civil constitution of the clergy.

charity, and forbade the introduction of new ones. Monastic vows

him on the 9th of March, whereupon the assembly testified its confidence in Narbonne. De Lessart having incurred its anger by the tameness of his replies to Austrian dictation, the Assembly voted his impeachment.

The king, seeing no other course open, formed a new ministry which was chiefly Girondin. Roland became minister of the interior, Clavière of finance, De Grave of war, and Lacoste of marine. Far abler and more resolute than any of these men was Dumouriez, the new minister for foreign affairs. A soldier by profession, he had been employed in the secret diplomacy of Louis XV. and had thus gained a wide knowledge of international politics. He stood aloof from parties and had no rigid principles, but held views closely resembling those of Narbonne. He wished for a war with Austria which should restore some influence to the crown and make himself the arbiter of France. The king bent to necessity, and on the 20th of April came to the Assembly with the proposal that war should be declared against Austria. It was carried by acclamation. Dumouriez intended to begin with an invasion of the Austrian Netherlands. As this would awaken English jealousy, he sent Talleyrand to London with assurances that, if victorious, the French would annex no territory.

It was designed that the French should invade the Netherlands at three points simultaneously. Lafayette was to march against Namur, Biron against Mons, and Dillon against Tournay. But the first movement disclosed the miserable state of the army. Smitten with panic, Dillon's force fled at sight of the enemy, and Dillon, after receiving a wound from one of his own soldiers, was murdered by the mob of Lille. Biron was easily routed before Mons. On hearing of these disasters Lafayette found it necessary to retreat. This shameful discomfiture quickened all the suspicion and jealousy fermenting in France. De Grave had to resign and was succeeded by Servan. The Austrian forces in the Netherlands were, however, so weak that they could not take the offensive. Austria demanded help from Prussia under the recent alliance, and the claim was admitted. Prussia declared war against France, and the duke of Brunswick was chosen to command the allied forces, but various causes delayed action. Austrian and Prussian interests clashed in Poland. The Austrian government wished to preserve a harmless neighbour. The Prussian government desired another partition and a large tract of Polish territory. Only after long discussion was it agreed that Prussia should be free to act in Poland, while Austria might find compensation in provinces conquered from France.

A respite was thus given and something was done to improve the army. Meantime the Assembly passed three decrees: one for the deportation of nonjuring priests, another to suppress the king's Constitutional Guard, and a third for the establishment of a camp of *fédérés* near Paris. Louis consented to sacrifice his guard, but vetoed the other decrees. Roland having addressed to him an arrogant letter of remonstrance, the king with the support of Dumouriez dismissed Roland, Servan and Clavière. Dumouriez then took the ministry of war, and the other places were filled with such men as could be had. Dumouriez, who cared only for the successful prosecution of the war, urged the king to accept the decrees. As Louis was obstinate, he felt that he could do no more, resigned office on the 15th of June and went to join the army of the north. Lafayette, who

remained faithful to the constitution of 1791, ventured on a letter of remonstrance to the Assembly. It paid no attention, for Lafayette could no longer sway the people. The Jacobins tried to frighten the king into accepting the decrees and recalling his ministers. On the 20th of June the armed populace invaded the hall of the Assembly and the royal apartments in the Tuileries. For some hours the king and queen were in the utmost peril. With passive courage Louis refrained from making any promise to the insurgents.

The failure of the insurrection encouraged a movement in favour of the king. Some twenty thousand Parisians signed a petition expressing sympathy with Louis. Addresses of like tenour poured in from the departments and the provincial cities. Lafayette himself came to Paris in the hope of rallying the

constitutional party, but the king and queen eluded his offers of assistance. They had always disliked and distrusted Lafayette and the Feuillants, and preferred to rest their hopes of deliverance on the foreigner. Lafayette returned to his troops without having effected anything. The Girondins made a last advance to Louis, offering to save the monarchy if he would accept them as ministers. His refusal united all the Jacobins in the project of overturning the monarchy by force. The ruling spirit of this new revolution was Danton, a barrister only thirty-two years of age, who had not sat in either Assembly, although he had been the leader of the Cordeliers, an advanced republican club, and had a strong hold on the common people of Paris. Danton and his friends were assisted in their work by the fear of invasion, for the allied army was at length mustering on the frontier. The Assembly declared the country in danger. All the regular troops in or near Paris were sent to the front. Volunteers and *fédérés* were constantly arriving in Paris, and, although most went on to join the army, the Jacobins enlisted those who were suitable for their purpose, especially some 500 whom Barbaroux, a Girondin, had summoned from Marseilles. At the same time the National Guard was opened to the lowest class. Brunswick's famous declaration of the 25th of July, announcing that the allies would enter France to restore the royal authority and would visit the Assembly and the city of Paris with military execution if any further outrage were offered to the king, heated the republican spirit to fury. It was resolved to strike the decisive blow on the 10th of August.

On the night of the 9th a new revolutionary Commune took possession of the *hôtel de ville*, and early on the morning of the 10th the insurgents assailed the Tuileries. As the preparations of the Jacobins had been notorious, some measures of defence had been taken. Beside a few gentlemen in arms and a number of National Guards the palace was garrisoned by the Swiss Guard, about 950 strong. The disparity of force was not so great as to make resistance altogether hopeless. But Louis let himself be persuaded into betraying his own cause and retiring with his family under the shelter of the Assembly. The National Guards either dispersed or fraternized with the assailants. The Swiss Guard stood firm, and, possibly by accident, a fusillade began. The enemy were gaining ground when the Swiss received an order from the king to cease firing and withdraw. They were mostly shot down as they were retiring, and of those who surrendered many were murdered in cold blood next day. The king and queen spent long hours in a reporter's box while the Assembly discussed their fate and the fate of the French monarchy. Little more than a third of the deputies were present and they were almost all Jacobins. They decreed that Louis should be suspended from his office and that a convention should be summoned to give France a new constitution. An executive council was formed by recalling Roland, Clavière and Servan to office and joining with them Danton as minister of justice, Lebrun as minister of foreign affairs, and Monge as minister of marine.

When Lafayette heard of the insurrection in Paris he tried to rally his troops in defence of the constitution, but they refused to follow him. He was driven to cross the frontier and surrender himself to the Austrians. Dumouriez was named his successor. But the new government was still beset with danger. It had no root in law and little hold on public opinion. It could not lean on the Assembly, a mere shrunken remnant, whose days were numbered. It remained dependent on the power which had set it up, the revolutionary Commune of Paris. The Commune could therefore extort what concessions it pleased. It got the custody of the king and his family who were imprisoned in the Temple. Having obtained an indefinite power of arrest, it soon filled the prisons of Paris. As the elections to the Convention were close at hand, the Commune resolved to strike the public with terror by the slaughter of its prisoners. It found its opportunity in the progress of invasion. On the 19th Brunswick crossed the frontier. On the 22nd Longwy surrendered. Verdun was invested and seemed likely to fall. On the 1st of September the Commune decreed

War declared against Austria.

Ending of the 10th of August.

Embassy of the 20th of June 1791.

The revolutionary Commune of Paris.

that on the following day the tocsin should be rung, all able-bodied citizens convened in the Champs de Mars, and 60,000 volunteers enrolled for the defence of the country. While this assembly was in progress gangs of assassins were sent to the prisons and began a butchery which lasted four days and consumed 1,400 victims. The Commune addressed a circular letter to the other cities of France inviting them to follow the example. A number of state prisoners awaiting trial at Orleans were ordered to Paris and on the way were murdered at Versailles. The Assembly offered a feeble resistance to these crimes. Danton can hardly be acquitted of connivance at them. Roland hinted disapproval, but did not venture more. He with many other Girondins had been marked for slaughter in the original project.

The elections to the Convention were by almost universal suffrage, but indifference or intimidation reduced the voters to a small number. Many who had sat in the National, and many more who had sat in the Legislative Assembly were returned. The Convention met on the 20th of September. Like the previous assemblies, it did not fall into well-defined parties. The success of the Jacobins in overthrowing the monarchy had ended their union. Thenceforward the name of Jacobin was confined to the smaller and more fanatical group, while the rest came to be known as the Girondins. The Jacobins, about 100 strong, formed the Left of the Convention, afterwards known from the raised benches on which they sat as the Mountain (*q.v.*). The Girondins, numbering perhaps 180, formed the Right. The rest of the House, nearly 500 members, voted now on one side now on the other, until in the course of the Terror they fell under the Jacobin domination. This neutral mass is often termed the Plain, in allusion to its seats on the floor of the House. The Convention as a whole was Republican, if not on principle, from the feeling that no other form of government could be established. It decreed the abolition of monarchy on the 21st of September.

A committee was named to draft a new constitution, which was presented and decreed in the following June, but never took effect and was superseded by a third constitution in 1795. The actual government of France was by committees of the Convention, but some months passed before it could be fully organized.

The inner history of the Convention was strange and terrible. It turned on the successive schisms in the ruling minority.

Whichever side prevailed destroyed its adversaries only to divide afresh and renew the strife until the victors were at length so reduced that their yoke was shaken off and the mass of the Convention, hitherto benumbed by fear, resumed its freedom and the government of France. The first and most memorable of these contests was the quarrel between Jacobin and Girondin. Both parties were republican and democratic; both wished to complete the Revolution; both were determined to maintain the integrity of France. But they differed in circumstances and temperament. Although the leaders on both sides were of the middle class, the Girondins represented the *bourgeoisie*, the Jacobins represented the populace. The Girondins desired a speedy return to law and order; the Jacobins thought that they could keep power only by violence. The Jacobins leant on the revolutionary commune and the mob of Paris; the Girondins leant on the thriving burghers of the provincial cities. Despite their smaller number the Jacobins were victors. They were the more resolute and unscrupulous. The Girondins numbered many orators, but not one man of action. The Jacobins controlled the parent club with its affiliated societies and the whole machinery of terror. The Girondins had no organized force at their disposal. The Jacobins perpetuated in a new form the old centralization of power to which France was accustomed. The Girondins addressed themselves to provincials who had lost the power of initiative. They were termed federalists by their enemies and accused, unjustly enough, of wishing to dissolve the national unity.

Even in the first days of the Convention the feud broke out. The Girondins condemned the September massacres and dreaded

the Parisian populace. Barbaroux accused Robespierre of aiming at a dictatorship, and Buzot demanded a guard recruited in the departments to protect the Convention. In October Louvet reiterated the charge against Robespierre, and Barbaroux called for the dissolution of the Commune of Paris. But the Girondins gained no tangible result from this wordy warfare. For a time the question how to dispose of the king diverted the thoughts of all parties. It was approached in a political, not in a judicial spirit. The Jacobins desired the death of Louis, partly because they hated kings and deemed him a traitor, partly because they wished to envenom the Revolution, defy Europe and compromise their more temperate colleagues. The Girondins wished to spare Louis, but were afraid of incurring the reproach of royalism. At this critical moment the discovery of the famous iron chest, containing papers which showed that many public men had intrigued with the court, was disastrous for Louis. Members of the Convention were anxious to be thought severe lest they should be thought corrupt. Robespierre frankly demanded that Louis as a public enemy should be put to death without form of trial. The majority shrank from such open injustice and decreed on the 3rd of December that Louis should be tried by the Convention.

A committee of twenty-one was chosen to frame the indictment against Louis, and on the 11th of December he was brought to the bar for the first time to hear the charges read. The most essential might be summed up in the statement that he had plotted against the Constitution and against the safety of the kingdom. On the 26th Louis appeared at the bar a second time, and the trial began. The advocates of Louis could plead that all his actions down to the dissolution of the National Assembly came within the amnesty then granted, and that the Constitution had proclaimed his person inviolable, while enacting for certain offences the penalty of deposition which he had already undergone. Such arguments were not likely to weigh with such a tribunal. The Mountain called for immediate sentence of death; the Girondins desired an appeal to the people of France. The galleries of the Convention were packed with adherents of the Jacobins, whose fury, not confined to words, struck terror into all who might incline towards mercy. In Paris unmistakable signs announced a new insurrection, to be followed perhaps by new massacres. On the question whether Louis was guilty none ventured to give a negative vote. The motion for an appeal to the people was rejected by 424 votes to 283. The penalty of death was adopted by 361 votes against 360 in favour of other penalties or of postponing at least the execution of the sentence. On the 21st of January 1793 Louis was beheaded in the Place de la Révolution, now the Place de la Concorde.

Between the deposition and the death of Louis the war had run a surprising course. Accompanied by King Frederick William, Brunswick had entered France with 80,000 men, of whom more than half were Prussians, the best soldiers in Europe. The disorder of France was such that many expected a triumphal march to Paris. But the Allies had opened the campaign late; they moved slowly; the weather broke, and sickness began to waste their ranks. Dumouriez succeeded in rousing the spirit of the French; he occupied the defiles of the forest of Argonne, thus causing the enemy to lose many valuable days, and when at last they turned his position, he retreated without loss. At Valmy on the 20th of September the two armies came in contact. The affair was only a cannonade, but the French stood firm and the advance of the Allies was stayed. Brunswick had no heart for his work; the king was ill satisfied with the Austrians, and both were alarmed by the ravages of disease among the soldiers. Within ten days after the affair of Valmy they began their retreat. Dumouriez, who still hoped to detach Prussia from Austria, left them unmolested. When the enemy had quitted France, he invaded Hainaut and defeated the Austrians at Jemappes on the 6th of November. In Belgium a large party regarded the French as deliverers. Dumouriez entered Brussels without further resistance, and was soon master of the whole country. Elsewhere the French were equally successful. With a slight force Custine

The September massacres.

The National Convention.

Abolition of the monarchy.

Jacobins and Girondins.

Trial and execution of Louis XVI.

Battle of Valmy.

assailed the electorate of Mainz. The common people were friendly, and he had no trouble in occupying the country as far as the Rhine. The king of Sardinia having shown a hostile temper, Montesquieu made an easy conquest of Savoy. At the close of 1792 the relative position of France and her enemies had been reversed. It was seen that the French were still able to wage war, and that the revolutionary spirit had permeated the adjoining countries, while the old governments of Europe, jealous of one another and uncertain of the loyalty of their subjects, were ill qualified for resistance.

Intoxicated with these victories, the Convention abandoned itself to the fervour of propaganda and conquest. The river Scheldt had been closed to commerce by various treaties to which England and Holland, neutral powers, were parties. Without a pretence of negotiation the French government declared on the 16th of November that the Scheldt was thenceforwards open. On the 19th a decree of the Convention offered the aid of France to all nations which were striving after freedom—in other words, to the malcontents in every neighbouring state. Not long afterwards the Convention annexed Savoy, with the consent, it should be added, of many Savoyards. On the 15th of December the Convention decreed that all peoples freed by its assistance should carry out a revolution like that which had been made in France on pain of being treated as enemies. Towards Great Britain the executive council and the Convention behaved with singular folly. There, in spite of a growing antipathy to the Revolution, Pitt earnestly desired to maintain peace. The conquest of the Netherlands and the symptoms of a wish to annex that country made his task most difficult. But the French

The first coalition against France.

government underrated the strength of Great Britain, imagining that all Englishmen who desired parliamentary reform desired revolution, and that a few democratic societies represented the nation. When Monge announced the intention of attacking Great Britain on behalf of the English republicans, the British government and nation were thoroughly alarmed and roused; and when the news of the execution of Louis XVI. was received, Chauvelin, the French envoy, was ordered to quit England. France declared war against England and Holland on the 1st of February and soon afterwards against Spain. In the course of the year 1793 the Empire, the kings of Portugal and Naples and the grand-duke of Tuscany declared war against France. Thus was formed the first coalition.

France was not prepared to encounter so many enemies. Administrative confusion had been heightened by the triumph of the Jacobins. Servan was succeeded as minister of war by Pache who was incapable and dishonest. The army of Dumouriez was left in such want that it dwindled rapidly. The commissioners of the Convention plundered the Netherlands with so little remorse that the people became bitterly hostile. The attempt to enforce a revolution of the French sort on the Catholic and conservative Belgians drove them to fury. By every unfair means the commissioners extorted the semblance of a popular vote in favour of incorporation, and France annexed the Netherlands. This was the last outrage. When a new Austrian army under the prince of Coburg entered the country, Dumouriez, who had invaded Holland, was unable to defend Belgium. On the 18th of March he was defeated at Neerwinden, and a few days later he was driven back to the frontier. Alike on public and personal grounds Dumouriez was the enemy of the government. Trusting in his influence over the army he resolved to lead it against the Convention, and, in order to secure his rear, he negotiated with the enemy. But he could make no impression on his soldiers, and deserted to the Austrians. Events followed a similar course in the Rhine valley. There also the French wore out the goodwill at first shown to them. They summoned a convention and obtained a vote for incorporation with France. But they were unable to hold their ground on the approach of a Prussian army. By April they had lost the country with the exception of Mainz, which was invested. France thus lay open to invasion from the east and the north. The Convention decreed a levy of 300,000 men.

About the same time began the first formidable uprising against the Revolution, the War of La Vendée, the region lying to the south of the lower Loire and facing the Atlantic. Its inhabitants differed in many ways from the mass of the nation. Living far from large towns and busy routes of commerce, they remained primitive in all their thoughts and ways. The peasants had always been on friendly terms with the gentry, and the agrarian changes made by the Revolution had not been appreciated so highly as elsewhere. The people were ardent Catholics, who venerated the nonjuring clergy and resented the measures taken against them. But they remained passive until the enforcement of the decree for the levy of 300,000 men. Caring little for the Convention and knowing nothing of events on the northern or eastern frontier, the peasants were determined not to serve and preferred to fight the Republic at home. When once they had taken up arms they found gentlemen to lead and priests to exhort, and their rebellion became Royalist and Catholic. The chiefs were drawn from widely different classes. If Bonchamps and La Roche-Jacuelin were nobles, Stofflet was a gamekeeper and Cathelineau a mason. As the country was favourable to guerilla warfare, and the government could not spare regular troops from the frontiers, the rebels were usually successful, and by the end of May had almost expelled the Republicans from La Vendée.

Danger without and within prompted the Convention to strengthen the executive authority. That the executive and legislative powers ought to be absolutely separate had been an axiom throughout the Revolution. The Ministers had always been excluded from a seat in the legislature. But the Assemblies were suspicious of the executive and bent on absorbing the government. They had nominated committees of their own members to control every branch of public affairs. These committees, while reducing the ministers to impotence, were themselves clumsy and ineffectual. It may be said that since the first meeting of the states-general the executive authority had been paralysed in France. The Convention in theory maintained the separation of powers. Even Danton had been forced to resign office when he was elected a member. But unity of government was restored by the formation of a central committee. In January the first Committee of General Defence was formed of members of the committees for the several departments of state. Too large and too much divided for strenuous labour, it was reduced in April to nine members and re-named the Committee of Public Safety. It deliberated in secret and had authority over the ministers; it was entrusted with the whole of the national defence and empowered to use all the resources of the state, and it quickly became the supreme power in the republic. Under it the ministers were no more than head clerks. About the same time were instituted the deputies on mission in the provinces, who could overrule any local authority, and who corresponded regularly with the Committee. France thus returned under new forms to its traditional government: a despotic authority in Paris with all-powerful agents in the provinces. Against disaffection the government was armed with formidable weapons: the Committee of General Security and the Revolutionary Tribunal. The Committee of General Security, first established in October 1792, was several times remodelled. In September 1793 the Convention decreed that its members should be nominated by the Committee of Public Safety. The Committee of General Security had unlimited powers for the prevention or discovery of crime against the state. The Revolutionary Tribunal was decreed on the 10th of March. It was an extraordinary court, destined to try all offences against the Revolution without appeal. The jury, which received wages, voted openly, so that condemnation was almost certain. The director of the jury or public prosecutor was Fouquier Tinville. The first condemnation took place on the 11th of April.

Enmity between Girondin and Jacobin grew fiercer as the perils of the Republic increased. Danton strove to unite all partisans of the Revolution in defence of the country; but the Girondins, detesting his character and fearing his ambition,

Rising in La Vendée.

The Committee of Public Safety.

rejected all advances. The Commune of Paris and the journalists who were its mouthpieces, Hébert and Marat, aimed frankly at destroying the Girondins. In April the Girondins carried a decree that Marat should be sent before the Revolutionary Tribunal for incendiary writings, but his acquittal showed that a Jacobin leader was above the law. In May they proposed that the Commune of Paris should be dissolved, and that the *suppléants*, the persons elected to fill vacancies occurring in the Convention, should assemble at Bourges, where they would be safe from that violence which might be applied to the Convention itself. Barère, who was rising into notice by the skill with which he trimmed between parties, opposed this motion, and carried a decree appointing a Committee of Twelve to watch over the safety of the Convention. Then the Commune named as commandant of the National Guard, Hanriot, a man concerned in the September massacres. It raised an insurrection on the 31st of May. On Barère's proposal the Convention stooped to dissolving the Committee of Twelve. The Commune, which had hoped for the arrest of the Girondin leaders, was not satisfied. It undertook a new and more formidable outbreak on the 2nd of June. Enclosed by Hanriot's troops and thoroughly cowed, the Convention decreed the arrest of the Committee of Twelve and of twenty-two principal Girondins. They were put under confinement in their own houses. Thus the Jacobins became all-powerful.

A tremor of revolt ran through the cities of the south which chafed under the despotism of the Parisian mob. These cities had their own grievances. The Jacobin clubs menaced the lives and properties of all who were guilty of wealth or of moderate opinions, while the representatives on mission deposed the municipal authorities and placed their own creatures in power. At the end of April the citizens of Marseilles closed the Jacobin club, put its chiefs on their trial and drove out the representatives on mission. In May Lyons rose. The Jacobin municipality was overturned, and Challier, their fiercest demagogue, was arrested. In June the citizens of Bordeaux declared that they would not acknowledge the authority of the Convention until the imprisoned deputies were set free. In July Toulon rebelled. But in the north the appeals of such Girondins as escaped from Paris were of no avail. Even the southern uprising proved far less dangerous than might have been expected. The peasants, who had gained more by the Revolution than any other class, held aloof from the citizens. The citizens lacked the qualities necessary for the successful conduct of civil war. Bordeaux surrendered almost without waiting to be summoned. Marseilles was taken in August and treated with great cruelty. Lyons, where the Royalists were strong, defended itself with courage, for the trial and execution of Challier made the townsmen hopeless of pardon. Toulon, also largely Royalist, invited the English and Spanish admirals, Hood and Langara, who occupied the port and garrisoned the town. At the same time the Vendean War continued formidable. In June the insurgents took the important town of Saumur, although they failed in an attempt upon Nantes. At the end of July the Republicans were still unable to make any impression upon the revolted territory.

Thus in the summer of 1793 France seemed to be falling to pieces. It was saved by the imbecility and disunion of the hostile powers. In the north the French army after the treason of Dumouriez could only attempt to cover the frontier. The Austrians were joined by British, Dutch and Prussian forces. Had the Allies pushed straight upon Paris, they might have ended the war. But the desire of each ally to make conquests on his own account led them to spend time and strength in sieges. When Condé and Valenciennes had been taken, the British went off to assail Dunkirk and the Prussians retired into Luxemburg. In the east the Prussians and Austrians took Mainz at the end of July, allowing the garrison to depart on condition of not serving against the Allies for a year. Then they invaded Alsace, but their mutual jealousy prevented them from going farther. Thus the summer passed away without any decisive achievement of the

coalition. Meanwhile the Committee of Public Safety, inspired by Danton, strove to rebuild the French administrative system. In July the Committee was renewed and Danton fell out; but soon afterwards it was reinforced by two officers, Carnot, who undertook the organization of the army, and Prieur of the Côte d'Or, who undertook its equipment. Administrators of the first rank, these men renovated the warlike power of France, and enabled her to deal those crushing blows which broke up the coalition.

The Royalist and Girondin insurrections and the critical aspect of the war favoured the establishment of what is known as the reign of terror. Terrorism had prevailed more or less since the beginning of the Revolution, but it was the work of those who desired to rule, not of the nominal rulers. It had been lawless and rebellious. It ended by becoming legal and official. While Danton kept power Terrorism remained imperfect, for Danton, although unscrupulous, did not love cruelty and kept in view a return to normal government. But soon after Danton had ceased to be a member of the Committee of Public Safety Robespierre was elected, and now became the most powerful man in France. Robespierre was an acrid fanatic, and unlike Danton, who only cared to secure the practical results of the Revolution, he had a moral and religious ideal which he intended to force on the nation. All who rejected his ideal were corrupt; all who resented his ascendancy were traitors. The death of Marat, who was stabbed by Charlotte Corday (*q.v.*) to avenge the Girondins, gave yet another pretext for terrible measures of repression. In Paris the armed ruffians who had long preyed upon respectable citizens were organised as a revolutionary army, and other revolutionary armies were established in the provinces. Two new laws placed almost everybody at the mercy of the government. The Law of the Maximum, passed on the 17th of September, fixed the price of food and made it capital to ask for more. The Law of Suspects, passed at the same time, declared suspect every person who was of noble birth, or had held office before the Revolution, or had any connexion with an *émigré*, or could not produce a card of *civisme* granted by the local authority, which had full discretion to refuse. Any suspect might be arrested and imprisoned until the peace or sent before the Revolutionary Tribunal. An earlier law had established in every commune an elective committee of surveillance. These bodies, better known as revolutionary committees, were charged with the enforcement of the Law of Suspects. On the 10th of October the new constitution was suspended and the government declared revolutionary until the peace.

The spirit of those in power was shown by the massacres which followed on the surrender of Lyons in that month. In Paris the slaughter of distinguished victims began with the trial of Marie Antoinette, who was guillotined on the 16th. Twenty-one Girondin deputies were next brought to the bar and, with the exception of Valazé who stabbed himself, were beheaded on the last day of October, Madame Roland and other Girondins of note suffered later. In November the duke of Orleans, who had styled himself Philippe Égalité, had sat in the Convention, and had voted for the king's death, went to the scaffold. Bailly, Barnave and many others of note followed before the end of the year. As the bloody work went on the pretence of trial became more and more hollow, the chance of acquittal fainter and fainter. The Revolutionary Tribunal was a mere instrument of state. Knowing the slight foundation of its power the government deliberately sought to destroy all whose birth, political connexions or past career might mark them out as leaders of opposition. At the same time it took care to show that none was so obscure or so impotent as to be safe when its policy was to destroy.

The disastrous effects of the Terror were heightened by the financial mismanagement of the Jacobins. Assignats were issued with such reckless profusion that the total for the three years of the Convention has been estimated at 7250 millions of francs. Enormous depreciation ensued and, although penalties rising to death itself were denounced against all who should refuse to take them at par, they fell to little more than 1% of their

Fall of the Girondins.

Revolt of the provinces.

The reign of terror.

Execution of the queen.

Division of the allied powers.

compassion. The National Guard was reorganized so as to exclude the lowest class. The property of persons executed since the roth of March 1793 was restored to their families. The signs of reaction daily became more unmistakable. Worshipers crowded to the churches; the *émigrés* returned by thousands; and Anti-Jacobin outbreaks, followed by massacre, took place in the south. The despair of the Jacobins produced a second rising in Paris on the 1st Prairial (May 20). Again the mob invaded the Convention, murdered a deputy named Féraud who attempted to shield the president, and set his head on a pike. The ultra-Jacobin members took possession and embodied their wishes in decrees. Again the hall was cleared by the National Guards, but order was restored in Paris only by employing regular troops, a new precedent in the history of the Revolution. Paris was disarmed, and several leaders of the insurrection were sentenced to death. The Revolutionary Tribunal was suppressed. Toleration was proclaimed for all priests who would declare their obedience to the laws of the state. Royalists began to count upon the restoration of young Louis the Dauphin, otherwise Louis XVII.; but his health had been ruined by persevering cruelty, and he died on the roth of June.

The Thermidorian government also endeavoured to pacify the rebels of the west. Its best adviser, Hoche, recommended an amnesty and the assurance of religious freedom.

Progress of the war. On these terms peace was made with the Vendéans

at La Jaunais in February and with the Chouans at La Mabilais in April. Some of the Vendean leaders persevered in resistance until May, and even after their submission the peace was ill observed, for the Royalists hearkened to the solicitations of the princes and their advisers. In the hope of rekindling the civil war a body of *émigrés* sailed under cover of the British fleet and landed on the peninsula of Quiberon. They were presently hemmed in by Hoche, and all who could not make their escape to the ships were forced to surrender at discretion (July 20). Nearly 700 were executed by court-martial. Yet the spirit of revolt lingered in the west and broke out time after time. Against the coalition the Republic was gloriously successful. (See FRENCH REVOLUTIONARY WARS.) In the summer of 1794 the French invaded Spain at both ends of the Pyrenees, and at the close of the year they made good their footing in Catalonia and Navarre. By the beginning of 1795 the Rhine frontier had been won. Against the king of Sardinia alone they accomplished little. At sea the French had sustained a severe defeat from Lord Howe, and several of their colonies had been taken by the British. But Great Britain, when the Netherlands were lost, could do little for her allies. Even before the close of 1794 the king of Prussia retired from any active part in the war, and on the 5th of April 1795 he concluded with France the treaty of Basel, which recognized her occupation of the left bank of the Rhine. The new democratic government which the French had established in Holland purchased peace by surrendering Dutch territory to the south of that river. A treaty of peace between France and Spain followed in July. The grand duke of Tuscany had been admitted to terms in February. The coalition thus fell into ruin and France occupied a more commanding position than in the proudest days of Louis XIV.

But this greatness was unsure so long as France remained without a stable government. A constitutional committee was named in April. It resolved that the constitution

Constitution of the year III. The Directory.

of 1793 was impracticable and proceeded to frame a new one. The draft was submitted to the Convention in June. In its final shape the constitution established a parliamentary system of two houses: a Council of Five Hundred and a Council of Ancients, 250 in number. Members of the Five Hundred were to be at least thirty years of age, members of the Ancients at least forty. The system of indirect election was maintained but universal suffrage was abandoned. A moderate qualification was required for electors in the first degree, a higher one for electors in the second degree.

When the 750 persons necessary had been elected they were to choose the Ancients out of their own body. A legislature was to last for three years, and one-third of the members were to be

renewed every year. The Ancients had a suspensory veto, but no initiative in legislation. The executive was to consist of five directors chosen by the Ancients out of a list elected by the Five Hundred. One director was to retire every year. The directors were aided by ministers for the various departments of State. These ministers did not form a council and had no general powers of government. Provision was made for the stringent control of all local authorities by the central government. Since the separation of powers was still deemed axiomatic, the directors had no voice in legislation or taxation, nor could directors or ministers sit in either house. Freedom of religion, freedom of the press, and freedom of labour were guaranteed. Armed assemblies and even public meetings of political societies were forbidden. Petitions were to be tendered only by individuals or through the public authorities. The constitution was not, however, allowed free play from the beginning. The Convention was so unpopular that, if its members had retired into private life, they would not have been safe and their work might have been undone. It was therefore decreed that two-thirds of the first legislature must be chosen out of the Convention.

When the constitution was submitted to the primary assemblies, most electors held aloof, 1,050,000 voting for and only 5,000 voting against it. On the 23rd of September it was declared to be law. Then all the parties which resented the limit upon freedom of election combined to rise in Paris. The government entrusted its defence to Barras; but its true man of action was young General Bonaparte, who could dispose of a few thousand regular troops and a powerful artillery. The Parisians were ill-equipped and ill-led, and on the 13th of Vendémiaire (October 5) their insurrection was quelled almost without loss to the victors. No further resistance was possible. The Convention dissolved itself on the 26th of October.

Insurrection of 13 Vendémiaire.

The feeling of the nation was clearly shown in the elections. Among those who had sat in the Convention the anti-Jacobins were generally preferred. A leader of the old Right was sometimes chosen by many departments at once.

Balance of parties in the new legislature.

Owing to this circumstance, 104 places reserved to members of the Convention were left unfilled. When the persons elected met they had no choice but to co-opt the 104 from the Left of the Convention. The new one-third were, as a rule, enemies of the Jacobins, but not of the Revolution. Many had been members of the Constituent or of the Legislative Assembly. When the new legislature was complete, the Jacobins had a majority, although a weak one. After the Council of the Ancients had been chosen by lot, it remained to name the directors. For its own security the Left resolved that all five must be old members of the Convention and regicides. The persons chosen were Rewbell, Barras, La Révellière Lépoux, Carnot and Letourneur. Rewbell was an able, although unscrupulous, man of action, Barras a dissolute and shameless adventurer, La Révellière Lépoux the chief of a new sect, the Theophilanthropists, and therefore a bitter foe to other religions, especially the Catholic. Severe integrity and memorable public services raised Carnot far above his colleagues, but he was not a statesman and was hampered by his past. Letourneur, a harmless insignificant person, was his admirer and follower. The division in the legislature was reproduced in the Directory. Rewbell, Barras and La Révellière Lépoux had a full measure of the Jacobin spirit; Carnot and Letourneur favoured a more temperate policy.

With the establishment of the Directory the Revolution might seem closed. The nation only desired rest and the healing of its many wounds. Those who wished to restore Louis XVIII. and the *ancien régime* and those who would have renewed the Reign of Terror were insignificant in number. The possibility of foreign interference had vanished with the failure of the coalition. Nevertheless the four years of the Directory were a time of arbitrary government and chronic disquiet. The late atrocities had made confidence or goodwill between parties impossible. The same instinct of self-preservation which had led the members of the Convention to claim so large a part in the new legislature and the whole of

Character of the Directory.

the Directory impelled them to keep their predominance. As the majority of Frenchmen wanted to be rid of them, they could achieve their purpose only by extraordinary means. They habitually disregarded the terms of the constitution, and, when the elections went against them, appealed to the sword. They resolved to prolong the war as the best expedient for prolonging their power. They were thus driven to rely upon the armies, which also desired war and were becoming less and less civic in temper. Other reasons influenced them in this direction. The finances had been so thoroughly ruined that the government could not have met its expenses without the plunder and the tribute of foreign countries. If peace were made, the armies would return home and the directors would have to face the exasperation of the rank and file who had lost their livelihood, as well as the ambition of generals who could in a moment brush them aside. Barras and Rewbell were notoriously corrupt themselves and screened corruption in others. The patronage of the directors was ill bestowed, and the general maladministration heightened their unpopularity.

The constitutional party in the legislature desired a toleration of the nonjuring clergy, the repeal of the laws against the relatives of the *émigrés*, and some merciful discrimination toward the *émigrés* themselves. The directors baffled all such endeavours. On the other hand, the socialist conspiracy of Babeuf was easily quelled (see BABEUF, FRANÇOIS N.). Little was done to improve the finances, and the *assignats* continued to fall in value. But the Directory was sustained by the military successes of the year 1796. Hoche again pacified La Vendée. Bonaparte's victories in Italy more than compensated for the reverses of Jourdan and Moreau in Germany. The king of Sardinia made peace in May, ceding Nice and Savoy to the Republic and consenting to receive French garrisons in his Piedmontese fortresses. By the treaty of San Ildefonso, concluded in August, Spain became the ally of France. In October Naples made peace. In 1797 Bonaparte finished the conquest of northern Italy and forced Austria to make the treaty of Campo Formio (October), whereby the emperor ceded Lombardy and the Austrian Netherlands to the Republic in exchange for Venice and undertook to urge upon the Diet the surrender of the lands beyond the Rhine. Notwithstanding the victory of Cape St Vincent, England was brought into such extreme peril by the mutinies in the fleet that she offered to acknowledge the French conquest of the Netherlands and to restore the French colonies. The selfishness of the three directors threw away this golden opportunity. In March and April the election of a new third of the Councils had been held. It gave a majority to the constitutional party. Among the directors the lot fell on Letourneur to retire, and he was succeeded by Barthélemy, an eminent diplomatist, who allied himself with Carnot. The political disabilities imposed upon the relatives of *émigrés* were repealed. Priests who would declare their submission to the Republic were restored to their rights as citizens. It seemed likely that peace would be made and that moderate men would gain power.

Barras, Rewbell and La Révellière-Lépeaux then sought help from the armies. Although Royalists formed but a petty fraction of the majority, they raised the alarm that it was seeking to restore monarchy and undo the work of the Revolution. Hoche, then in command of the army of the Sambre and Meuse, visited Paris and sent troops. Bonaparte sent General Augereau, who executed the *coup d'état* of the 18th Fructidor (September 4). The councils were purged, the elections in forty-nine departments were cancelled, and many deputies and other men of note were arrested. Some of them, including Barthélemy, were deported to Cayenne. Carnot made good his escape. The two vacant places in the Directory were filled by Merlin of Douai and François of Neuchâteau. Then the government frankly returned to Jacobin methods. The law against the relatives of *émigrés* was re-enacted, and military tribunals were established to condemn *émigrés* who should return to France. The nonjuring priests were again persecuted. Many hundreds were either sent to Cayenne

or imprisoned in the hulks of Ré and Oleron. La Révellière-Lépeaux seized the opportunity to propagate his religion. Many churches were turned into Theophilanthropic temples. The government strained its power to secure the recognition of the *décadi* as the day of public worship and the non-observance of Sunday. Liberty of the press ceased. Newspapers were confiscated and journalists were deported wholesale. It was proposed to banish from France all members of the old *noblesse*. Although the proposal was dropped, they were all declared to be foreigners and were forced to obtain naturalization if they would enjoy the rights of other citizens. A formal bankruptcy of the state, the cancelling of two-thirds of the interest on the public debt, crowned the misgovernment of this disastrous time.

In the spring of 1798 not only a new third of the legislature had to be chosen, but the places of the members expelled by the revolution of Fructidor had to be filled. The constitutional party had been rendered helpless, and the mass of the electors were indifferent. But among the Jacobins themselves there had arisen an extreme party hostile to the directors. With the support of many who were not Jacobins but detested the government, it bade fair to gain a majority. Before the new deputies could take their seats the directors forced through the councils the law of the 22nd Floréal (May 11), annulling or perverting the elections in thirty departments and excluding forty-eight deputies by name. Even this *coup d'état* did not secure harmony between the executive and the legislature. In the councils the directors were loudly charged with corruption and misgovernment. The retirement of François of Neuchâteau and the choice of Treillard as his successor made no difference in the position of the Directory.

While France was thus inwardly convulsed, its rulers were doubly bound to husband the national strength and practise moderation towards other states. Since December 1797 a congress had been sitting at Rastadt to regulate the future of Germany. That it should be brought to a successful conclusion was of the utmost import for France. But the directors were driven by self-interest to new adventures abroad. Bonaparte was resolved not to sink into obscurity, and the directors were anxious to keep him as far as possible from Paris; they therefore sanctioned the expedition to Egypt which deprived the Republic of its best army and most renowned captain. Coveting the treasures of Bern, they sent Brune to invade Switzerland and remodel its constitution; in revenge for the murder of General Duphot, they sent Berthier to invade the papal states and erect the Roman Republic; they occupied and virtually annexed Piedmont. In all these countries they organized such an effective pillage that the French became universally hateful. As the armies were far below the strength required by the policy of unbounded conquest and rapine, the first permanent law of conscription was passed in the summer of 1798. The attempt to enforce it caused a revolt of the peasants in the Belgian departments. The priests were made responsible and some eight thousand were condemned in a mass to deportation, although much the greater part escaped by the goodwill of the people. Few soldiers were obtained by the conscription, for the government was as weak as it was tyrannical.

Under these circumstances Nelson's victory of Aboukir (1st of August), which gave the British full command of the Mediterranean and secluded Bonaparte in Egypt, was the signal for a second coalition. Naples, Austria, Russia and Turkey joined Great Britain against France. Ferdinand of Naples, rashly taking the offensive before his allies were ready, was defeated and forced to seek a refuge in Sicily. In January 1799 the French occupied Naples and set up the Parthenopean republic. But the consequent dispersion of their weak forces only exposed them to greater peril. At home the Directory was in a most critical position. In the elections of April 1799 a large number of Jacobins gained seats. A little later Rewbell retired. It was imperative to fill his place with a man of ability and influence. The choice fell upon Sieyès, who had kept aloof from office and retained not only his immeasurable self-conceit but the respect of the public. Sieyès felt that

Coup d'état
of the 18th
Fructidor.

The
second
coalition.

the Directory was bankrupt of reputation, and he intended to be far more than a mere member of a board. He hoped to concentrate power in his own hands, to bridle the Jacobins, and to remodel the constitution. With the help of Barras he proceeded to rid himself of the other directors. An irregularity having been discovered in Treillard's election, he retired, and his place was taken by Gohier. Merlin of Douai and La Révellère Lépoux were driven to resign in June. They were succeeded by Moulin and Ducos. The three new directors were so insignificant that they could give no trouble, but for the same reason they were of little service.

Such a government was ill fitted to cope with the dangers then gathering round France. The directors having resolved on the offensive in Germany, the French crossed the Rhine early in March, but were defeated by the archduke Charles at Stockach on the 25th. The congress at Rastadt, which had sat for fifteen months without doing anything, broke up in April and the French envoys were murdered by Austrian hussars. In Italy the allies took the offensive with an army partly Austrian, partly Russian under the command of Suvarov. After defeating Moreau at Cassano on the 27th of April, he occupied Milan and Turin. The republics established by the French in Italy were overthrown, and the French army retreating from Naples was defeated by Suvarov on the Trebbia. Thus threatened with invasion on her German and Italian frontiers, France was disabled by anarchy within. The finances were in the last distress; the anti-religious policy of the government kept many departments on the verge of revolt; and commerce was almost suspended by the decay of roads and the increase of bandits. There was no real political freedom, yet none of the ease or security which enlightened despotism can bestow. The Terrorists lifted their heads in the Council of Five Hundred. A Law of Hostages, which was really a new Law of Suspects, and a progressive income tax showed the temper of the majority. The Jacobin Club was reopened and became once more the focus of disorder. The Jacobin press renewed the licence of Hébert and Marat. Never since the outbreak of the Revolution had the public temper been so gloomy and desponding.

In this extremity Sieyès chose as minister of police the old Terrorist Fouché, who best understood how to deal with his brethren. Fouché closed the Jacobin Club and deported a number of journalists. But like his predecessors Sieyès felt that for the revolution which he meditated he must have the help of a soldier. As his man of action he chose General Joubert, one of the most distinguished among French officers. Joubert was sent to restore the fortune of the war in Italy. At Novi on the 15th of August he encountered Suvarov. He was killed at the outset of the battle and his men were defeated. After this disaster the French held scarcely anything south of the Alps save Genoa. The Russian and Austrian governments then agreed to drive the enemy out of Switzerland and to invade France from the east. At the same time Holland was assailed by the joint forces of Great Britain and Russia. But the second coalition, like the first, was doomed to failure by the narrow views and conflicting interests of its members. The invasion of Switzerland was baffled by want of concert between Austrians and Russians and by Masséna's victory at Zürich on the 25th and 26th of September. In October the British and the Russians were forced to evacuate Holland. All immediate danger to France was ended, but the issue of the war was still in suspense. The directors had been forced to recall Bonaparte from Egypt. He anticipated their order and on the 9th of October landed at Fréjus.

Dazzled by his victories in the East the public forgot that the Egyptian expedition was ending in calamity. It received him with an ardour which convinced Sieyès that he was the indispensable soldier. Bonaparte was ready to act, but at his own time and for his own ends. Since the close of the Convention affairs at home and abroad had been tending more and more surely to the establishment of a military dictatorship. Feeling his powers equal to such an

office he only hesitated about the means of attainment. At first he thought of becoming a director; finally he decided upon a partnership with Sieyès. They resolved to end the actual government by a fresh *coup d'état*. Means were to be taken for removing the councils from Paris to St Cloud, where pressure could more easily be applied. Then the councils would be induced to decree a provisional government by three consuls and the appointment of a commission to revise the constitution. The pretext for this irregular proceeding was to be a vast Jacobin conspiracy. Perhaps the gravest obstacles were to be expected from the army. Of the generals, some, like Jourdan, were honest republicans; others, like Bernadotte, believed themselves capable of governing France. With perfect subtlety Bonaparte worked on the feelings of all and kept his own intentions secret.

On the morning of the 18th Brumaire (November 9) the Ancients, to whom that power belonged, decreed the transference of the councils to St Cloud. Of the directors, Sieyès and his friend Ducos had arranged to resign; Barras was cajoled and bribed into resigning; Gohier and Moulins, who were intractable, found themselves imprisoned in the Luxemburg palace and helpless. So far all had gone well. But when the councils met at St Cloud on the following day, the majority of the Five Hundred showed themselves bent on resistance, and even the Ancients gave signs of wavering. When Bonaparte addressed the Ancients, he lost his self-possession and made a deplorable figure. When he appeared among the Five Hundred, they fell upon him with such fury that he was hardly rescued by his officers. A motion to outlaw him was only baffled by the audacity of the president, his brother Lucien. At length driven to undisguised violence, he sent in his grenadiers, who turned out the deputies. Then the Ancients passed a decree which adjourned the Councils for three months, appointed Bonaparte, Sieyès and Ducos provisional consuls, and named the Legislative Commission. Some tractable members of the Five Hundred were afterwards swept up and served to give these measures the confirmation of their House. Thus the Directory and the Councils came to their unlamented end. A shabby compound of brute force and imposture, the 18th Brumaire was nevertheless condoned, nay applauded, by the French nation. Weary of revolution, men sought no more than to be wisely and firmly governed.

Although the French Revolution seemed to contemporaries a total break in the history of France, it was really far otherwise. Its results were momentous and durable in proportion General estimate of the Revolution. as they were the outcome of causes which had been working long. In France there had been no historic preparation for political freedom. The desire for such freedom was in the main confined to the upper classes. During the Revolution it was constantly baffled. No Assembly after the states-general was freely elected and none deliberated in freedom. After the Revolution Bonaparte established a monarchy even more absolute than the monarchy of Louis XIV. But the desire for uniformity, for equality and for what may be termed civil liberty was the growth of ages, had been in many respects nurtured by the action of the crown and its ministers, and had become intense and general. Accordingly it determined the principal results of the Revolution. Uniformity of laws and institutions was enforced throughout France. The legal privileges formerly distinguishing different classes were suppressed. An obsolete and burdensome agrarian system was abolished. A number of large estates belonging to the crown, the clergy and the nobles were broken up and sold at nominal prices to men of the middle or lower class. The new jurisprudence encouraged the multiplication of small properties. The new fiscal system taxed men according to their means and raised no obstacle to commerce within the national boundaries. Every calling and profession was made free to all French citizens, and in the public service the principle of an open career for talent was adopted. Religious disabilities vanished, and there was well-nigh complete liberty of thought. It was because Napoleon gave a practical form to these achievements of the Revolution and ensured the public order necessary to their continuance that

the majority of Frenchmen endured so long the fearful sacrifices which his policy exacted.

That a revolution largely inspired by generous and humane feeling should have issued in such havoc and such crimes is a paradox which astounded spectators and still perplexes the historian. Something in the cruelty of the French Revolution may be ascribed to national character. From the time when Burgundians and Armagnacs strove for dominion down to the last insurrection of Paris, civil discord in France has always been cruel. More, however, was due to the total dissolution of society which followed the meeting of the states-general. In the course of the Revolution we can discover no well-organized party, no governing mind. Mirabeau had the stuff of a great statesman, and Danton was capable of statesmanship. But these men were not followed or obeyed save by accident or for a moment. Those who seemed to govern were usually the sport of chance, often the victims of their colleagues. Neither Royalists nor Feuillants nor Girondins had the instinct of government. In the chaotic state of France all ferocious and destructive passions found ample scope. The same conditions explain the triumph of the Jacobins. Devoid of wisdom and virtue in the highest sense, they at least understood how power might be seized and kept. The Reign of Terror was the expedient of a party which knew its weakness and unpopularity. It was not necessary either to secure the lasting benefits of the Revolution or to save France from dismemberment; for nine Frenchmen out of ten were agreed on both of these points and were ready to lay down their lives for the national cause.

In the history of the French Revolution the influence which it exerted upon the surrounding countries demands peculiar attention. The French professed to act upon principles of universal authority, and from an early date they began to seek converts outside their own limits. The effect was slight upon England, which had already secured most of the reforms desired by the French, and upon Spain, where the bulk of the people were entirely submissive to church and king. But in the Netherlands, in western Germany and in northern Italy, countries which had attained a degree of civilization resembling that of France, where the middle and lower classes had grievances and aspirations not very different from those of the French, the effect was profound. Fear of revolution at home was one of the motives which led continental sovereigns to attack revolution in France. Their incoherent efforts only confirmed the Jacobin supremacy. Wherever the victorious French extended their dominion, they remodelled institutions in the French manner. Their sway proved so oppressive that the very classes which had welcomed them with most fervour soon came to long for their expulsion. But revolutionary ideas kept their charm. Under Napoleon the essential part of the changes made by the Republic was preserved in these countries also. Moreover the effacement of old boundaries, the overthrow of ancestral governments, and the invocation, however hollow, of the sovereignty of the people, awoke national feeling which had slumbered long and prepared the struggle for national union and independence in the 19th century.

See also FRANCE, sections *History and Law and Institutions*. For the leading figures in the Revolution see their biographies under separate headings. Particular phases, facts, and institutions of the period are also separately dealt with, e.g. ASSIGNATS, CONVENTION, THE NATIONAL, JACOBIENS.

BIBLIOGRAPHY.—The MS. authorities for the history of the French Revolution are exceedingly copious. The largest collection is in the Archives Nationales in Paris, but an immense number of documents are to be found in other collections in Paris and the provinces. The printed materials are so abundant and varied that any brief notice of them must be imperfect.

The condition of France and the state of public opinion at the beginning of the Revolution may be studied in the printed collections of *Cahiers*. The *Cahiers* were the statements of grievances drawn up for the guidance of deputies to the States-General by those who had elected them. In every *bailliage* and *sénéchaussée* each estate drew up its own cahier and the cahiers of the Third Estate were condensed from separate cahiers drawn up by each parish in the district. Thus the cahiers of the Third Estate number many thousands, the greater part of which have not yet been printed. Among the collections printed we may mention *Les Élections et les cahiers de Paris*

en 1789, by C. L. Chassin (4 vols., Paris, 1888); *Cahiers de plaintes et doléances des paroisses de la province de Maine*, by A. Bellé and V. Duchemin (4 vols., Le Mans, 1881-1893); *Cahiers de doléances de 1789 dans le département du Pas-de-Calais*, by H. Loriquet (2 vols., Arras, 1891); *Cahiers des paroisses et communautés du bailliage d'Autun*, by A. Charmasse (Autun, 1895). New collections are printed from time to time. A more general collection of cahiers than any above named is given in vols. i.-vi. of the *Archives parlementaires*. The cahiers must not be read in a spirit of absolute faith, as they were influenced by certain models circulated at the time of the elections and by popular excitement, but they remain an authority of the utmost value and a mine of information as to old France. Reference should also be made to the works of travellers who visited France at the outbreak of the Revolution. Among these Arthur Young's *Travels in France during the years 1787, 1788 and 1789* (2 vols., Bury St Edmunds, 1792-1794) are peculiarly instructive.

For the history of the Assemblies during the Revolution a main authority is their *Procès verbaux* or Journals; those of the Constituent Assembly in 75 vols., those of the Legislative Assembly in 16 vols.; those of the Convention in 71 vols.; and those of the Councils under the Directory in 99 vols. See also the *Archives parlementaires* edited by J. Mavidal and E. Laurent (Paris, 1867, and the following years); the *Histoire parlementaire de la Révolution*, by P. J. B. Duchez and P. C. Roux (Paris, 1838), and the *Histoire de la Révolution par deux amis de la liberté* (Paris, 1792-1803).

The newspapers, of which a few have been mentioned in the text, were numerous. They are useful chiefly as illustrating the ideas and passions of the time, for they give comparatively little information as to facts and that little is peculiarly inaccurate. The ablest of the Royalist journals was Mallet du Pan's *Mercure de France*. Pamphlets of the Revolution period number many thousands. Such pamphlets as Mounier's *Nouvelles Observations sur les États-Généraux de France* and Sicyès's *Qu'est-ce que le Tiers État* had a notable influence on opinion. The richest collections of Revolution pamphlets are in the Bibliothèque Nationale of Paris and in the British Museum.

The contemporary memoirs, &c., already published are numerous and fresh ones are always coming forth. A few of the best known and most useful are, for the Constituent Assembly, the memoirs of Bailly, of Ferrières, of Malouet. The *Correspondence of Mirabeau with the Count de la Marck*, edited by Baccourt (3 vols., Paris, 1851), is especially valuable. Dumont's *Recollections of Mirabeau and the Diary and Letters of Gouverneur Morris* give the impressions of foreigners with peculiar advantages for observing. For the Legislative Assembly and the Convention the memoirs of Madame Roland, of Bertrand de Molleville, of Barbaroux, of Buzot, of Louvet, of Dumouriez are instructive. For the Directory the memoirs of Barras, of La Révellière Lépoux, and of Thibodeau deserve mention. The memoirs of Lafayette are useful. Those of Talleyrand are singularly barren, the result, no doubt, of deliberate suppression. The memoirs of the marquise de La Rochejacquelein are important for the war of La Vendée. The most notable Jacobins have seldom left memoirs, but the works of Robespierre and St Just enable us to form a clearer conception of the authors. The correspondence of the count of Mercy-Argenteau, the imperial ambassador, with Joseph II. and Kaunitz, and the correspondence of Mallet du Pan with the court of Vienna, are also instructive. But the contemporary literature of the French Revolution requires to be read in an unusually critical spirit. At no other historical crisis have passions been more fiercely excited; at none have shameless disregard of truth and blind credulity been more common.

Among later works based on these original materials the first place belongs to general histories. In French Louis Blanc's *Histoire de la Révolution* (12 vols., Paris, 1847-1862), and Michélet's *Histoire de la Révolution Française* (9 vols., Paris, 1847-1853), are the most elaborate of the older works. Michélet's book is marked by great eloquence and power. In H. Taine's *Origines de la France contemporaine* (Paris, 1876-1894) three volumes are devoted to the Revolution. They show exceptional talent and industry, but their value is impaired by the spirit of system and by strong prepossessions. F. A. M. Mignet's *Histoire de la Révolution Française* (2 vols., Paris, 1861), short and devoid of literary charm, has the merits of learning and judgment and is still useful. F. A. Aulard's *Histoire politique de la Révolution Française* (Paris, 1901) is a most valuable précis of political history, based on deep knowledge and lucidly set forth, although not free from bias. The volume on the Revolution in Lavisse and Rambaud's *Histoire générale de l'Europe* (Paris, 1896) is the work of distinguished scholars using the latest information. In English, general histories of the Revolution are few. Carlyle's famous work, published in 1837, is more of a prose epic than a history, omitting all detail which would not heighten the imaginative effect and tinged by all the favourite ideas of the author. Some fifty years later H. M. Stephens published the first (1886) and second (1892) volumes of a *History of the French Revolution*. They are marked by solid learning and contain much information. Volume viii. of the *Cambridge Modern History*, published in 1904, contains a general survey of the Revolution.

The most notable German work is H. von Sybel's *Geschichte der Revolutionszeit* (5 vols., Stuttgart, 1853-1879). It is strongest in

those parts which relate to international affairs and foreign policy. There is an English translation.

None of the general histories of the Revolution above named is really satisfactory. The immense mass of material has not yet been thoroughly sifted; and the passions of that age still disturb the judgment of the historian. More successful have been the attempts to treat particular aspects of the Revolution.

The foreign relations of France during the Revolution have been most ably unravelled by A. Soré in *L'Europe et la Révolution Française* (8 vols., Paris, 1885-1904) carrying the story down to the settlement of Vienna. Five volumes cover the years 1789-1799.

The financial history of the Revolution has been traced by C. Gomel, *Histoire financière de l'Assemblée Constituante* (2 vols., Paris, 1897), and R. Stourm, *Les Finances de l'Ancien Régime et de la Révolution* (2 vols., Paris, 1885).

The relations of Church and State are sketched in E. Pressensé's *L'Eglise et la Révolution Française* (Paris, 1889).

The general legislation of the period has been discussed by Ph. Sagnac, *La Législation civile de la Révolution Française* (Paris, 1898). The best work upon the social life of the period is the *Histoire de la société française sous la Révolution*, by E. and J. de Goncourt (Paris, 1889). For military history see A. Duruy, *L'Armée royale en 1789* (Paris, 1888); E. de Hauterive, *L'Armée sous la Révolution, 1789-1794* (Paris, 1894); A. Chuquet, *Les Guerres de la Révolution* (Paris, 1886, &c.). See also the memoirs and biographies of the distinguished soldiers of the Republic and Empire, too numerous for citation here.

Modern lives of the principal actors in the Revolution are numerous. Among the most important are *Mémoires de Mirabeau*, by L. de Montigny (Paris, 1834); *Les Mirabeau*, by L. de Loménie (Paris, 1889-1891); H. L. de Lanza de Laborie's *Jean Joseph Mounier* (Paris, 1889); H. B. Mallet's *Mallet du Pan and the French Revolution* (London, 1902); Robinet's *Danton* (Paris, 1889); Hamel's *Histoire de Robespierre* (Paris, 1865-1867) and *Histoire de St-Just* (2 vols., Brussels, 1860); A. Bignon, *Sirey* (Paris, 1893); *Mémoires of Carnot*, by his son (2 vols., Paris, 1861-1864).

For fuller information see M. Tourneux, *Les Sources bibliographiques de l'histoire de la Révolution Française* (Paris, 1898, etc.), and *Bibliographie de l'histoire de Paris pendant la Révolution* (Paris, 1890, etc.). (F. C. M.)

French Republican Calendar.—Among the changes made during the Revolution was the substitution of a new calendar, usually called the revolutionary or republican calendar, for the prevailing Gregorian system. Something of the sort had been suggested in 1785 by a certain Riboud, and a definite scheme had been promulgated by Pierre Sylvain Maréchal (1750-1803) in his *Almanach des honnêtes gens* (1788). The objects which the advocates of a new calendar had in view were to strike a

blow at the clergy and to divorce all calculations of time from the Christian associations with which they were loaded, in short, to abolish the Christian year; and enthusiasts were already speaking of "the first year of liberty" and "the first year of the republic" when the national convention took up the matter in 1793. The business of drawing up the new calendar was entrusted to the president of the committee of public instruction, Charles Gilbert Romme (1750-1795), who was aided in the work by the mathematicians Gaspard Monge and Joseph Louis Lagrange, the poet Fabre d'Églantine and others. The result of their labours was submitted to the convention in September; it was accepted, and the new calendar became law on the 5th of October 1793. The new arrangement was regarded as beginning on the 22nd of September 1793, this day being chosen because on it the republic was proclaimed and because it was in this year the day of the autumnal equinox.

By the new calendar the year of 365 days was divided into twelve months of thirty days each, every month being divided into three periods of ten days, each of which were called *décades*, and the tenth, or last, day of each decade being a day of rest. It was also proposed to divide the day on the decimal system, but this arrangement was found to be highly inconvenient and it was never put into practice. Five days of the 365 still remained to be dealt with, and these were set aside for national festivals and holidays and were called *Sans-culottides*. They were to fall at the end of the year, i.e. on the five days between the 17th and the 21st of September inclusive, and were called the festivals of virtue, of genius, of labour, of opinion and of rewards. A similar course was adopted with regard to the extra day which occurred once in every four years, but the first of these was to fall in the year III., i.e. in 1795, and not in 1796, the leap year in the Gregorian calendar. This day was set apart for the festival of the Revolution and was to be the last of the *Sans-culottides*. Each period of four years was to be called a *Franciade*.

Some discussion took place about the nomenclature of the new divisions of time. Eventually this work was entrusted to Fabre d'Églantine, who gave to each month a name taken from some seasonal event therein. Beginning with the year on the 22nd of September the autumn months were *Vendémiaire*, the month of vintage, *Brumaire*, the months of fog, and *Frimaire*,

	AN II. 1793-1794.	AN III. 1794-1795.	AN IV. 1795-1796.	AN V. 1796-1797.	AN VI. 1797-1798.	AN VII. 1798-1799.	AN VIII. 1799-1800.	AN IX. 1800-1801.
1 Vendémiaire	22 Sept. 1793	22 Sept. 1794	23 Sept. 1795	22 Sept. 1796	22 Sept. 1797	22 Sept. 1798	23 Sept. 1799	23 Sept. 1800
1 Brumaire	22 Oct. "	22 Oct. "	23 Oct. "	22 Oct. "	22 Oct. "	22 Oct. "	23 Oct. "	23 Oct. "
1 Frimaire	21 Nov. "	21 Nov. "	22 Nov. "	21 Nov. "	21 Nov. "	21 Nov. "	22 Nov. "	22 Nov. "
1 Nivôse	21 Déc. "	21 Déc. "	22 Déc. "	21 Déc. "	21 Déc. "	21 Déc. "	22 Déc. "	22 Déc. "
1 Pluviôse	20 Janv. 1794	20 Janv. 1795	21 Janv. 1796	20 Janv. 1797	20 Janv. 1798	20 Janv. 1799	21 Janv. 1800	21 Janv. 1801
1 Ventôse	19 Févr. "	19 Févr. "	20 Févr. "	19 Févr. "	19 Févr. "	19 Févr. "	20 Févr. "	20 Févr. "
1 Germinal	21 Mars "	21 Mars "	21 Mars "	21 Mars "	21 Mars "	21 Mars "	22 Mars "	22 Mars "
1 Floréal	20 Avr. "	20 Avr. "	20 Avr. "	20 Avr. "	20 Avr. "	20 Avr. "	21 Avr. "	21 Avr. "
1 Prairial	20 Mai "	20 Mai "	20 Mai "	20 Mai "	20 Mai "	20 Mai "	21 Mai "	21 Mai "
1 Messidor	19 Juin "	19 Juin "	19 Juin "	19 Juin "	19 Juin "	19 Juin "	20 Juin "	20 Juin "
1 Thermidor	19 Juil. "	19 Juil. "	19 Juil. "	19 Juil. "	19 Juil. "	19 Juil. "	20 Juil. "	20 Juil. "
1 Fructidor	18 Août "	18 Août "	18 Août "	18 Août "	18 Août "	18 Août "	19 Août "	19 Août "
1 Sans-culottides	17 Sept. 1794	17 Sept. 1795	17 Sept. 1796	17 Sept. 1797	17 Sept. 1798	17 Sept. 1799	18 Sept. 1800	18 Sept. 1801
6 "	22 "	22 "	23 "	22 "	22 "	22 "	23 "	23 "
	AN X. 1801-1802.	AN XI. 1802-1803.	AN XII. 1803-1804.	AN XIII. 1804-1805.	AN XIV. 1805.			
1 Vendémiaire	23 Septembre 1801	23 Septembre 1802	24 Septembre 1803	23 Septembre 1804	23 Septembre 1805			
1 Brumaire	23 Octobre "	23 Octobre "	24 Octobre "	23 Octobre "	23 Octobre "			
1 Frimaire	22 Novembre "	22 Novembre "	23 Novembre "	22 Novembre "	22 Novembre "			
1 Nivôse	22 Décembre "	22 Décembre "	23 Décembre "	22 Décembre "	22 Décembre "			
1 Pluviôse	21 janvier 1802	21 janvier 1803	22 janvier 1804	21 janvier 1805	21 janvier 1805			
1 Ventôse	20 Février "	20 Février "	21 Février "	20 Février "	20 Février "			
1 Germinal	22 Mars "	22 Mars "	22 Mars "	22 Mars "	22 Mars "			
1 Floréal	21 Avril "	21 Avril "	21 Avril "	21 Avril "	21 Avril "			
1 Prairial	21 Mai "	21 Mai "	21 Mai "	21 Mai "	21 Mai "			
1 Messidor	20 Juin "	20 Juin "	20 Juin "	20 Juin "	20 Juin "			
1 Thermidor	20 Juillet "	20 Juillet "	20 Juillet "	20 Juillet "	20 Juillet "			
1 Fructidor	19 Août "	19 Août "	19 Août "	19 Août "	19 Août "			
1 Sans-culottides	18 Septembre 1802	18 Septembre 1803	18 Septembre 1804	18 Septembre 1805				
6 "	23 "	23 "	23 "	23 "				

the month of frost. The winter months were *Nivôse*, the snowy, *Pluviôse*, the rainy, and *Ventôse*, the windy month; then followed the spring months, *Germinal*, the month of buds, *Floral*, the month of flowers, and *Prairial*, the month of meadows; and lastly the summer months, *Messidor*, the month of reaping, *Thermidor*, the month of heat, and *Fructidor*, the month of fruit. To the days Fabre d'Églantine gave names which retained the idea of their numerical order, calling them *Primesi*, *Duodi*, &c., the last day of the ten, the day of rest, being named *Décadi*. The new order was soon in force in France and the new method was employed in all public documents, but it did not last many years. In September 1805 it was decided to restore the Gregorian calendar, and the republican one was officially discontinued on the 1st of January 1806.

It will easily be seen that the connecting link between the old and the new calendars is very slight indeed and that the expression of a date in one calendar in terms of the other is a matter of some difficulty. A simple method of doing this, however, is afforded by the table on the preceding page, which is taken from the article by J. Dubouardieu in *La Grande Encyclopédie*.

Thus Robespierre was executed on 10 Thermidor An II., i.e. the 28th of July 1794. The insurrection of 12 Germinal An III. took place on the 1st of April 1795. The famous 18 Brumaire An VIII. fell on the 9th of November 1799, and the *coup d'état* of 18 Fructidor An V. on the 4th of September 1797.

For a complete concordance of the Gregorian and the republican calendars see Stokvis, *Manuel d'histoire*, tome iii. (Leiden, 1889); also G. Villain, "Le Calendrier républicain," in *La Révolution Française* for 1884-1885. (A. W. H.)

FRENCH REVOLUTIONARY WARS (1792-1800), the general name for the first part of the series of French wars which went on continuously, except for some local and temporary cessations of hostilities, from the declaration of war against Britain in 1792 to the final overthrow of Napoleon in 1815. The most important of these cessations—viz. the peace of 1801-1803—closes the "Revolutionary" and opens the "Napoleonic" era of land warfare, for which see NAPOLEONIC CAMPAIGNS, PENINSULAR WAR and WATERLOO CAMPAIGN. The naval history of the period is divided somewhat differently; the first period, treated below, is 1792-1799; for the second, 1799-1815, see NAPOLEONIC CAMPAIGNS.

France declared war on Austria on the 20th of April 1792. But Prussia and other powers had allied themselves with Austria in view of war, and it was against a coalition and not a single power that France found herself pitted, at the moment when the "emigration," the ferment of the Revolution, and want of material and of funds had thoroughly disorganized her army. The first engagements were singularly disgraceful. Near Lille the French soldiers fled at sight of the Austrian outposts, crying *Nous sommes trahis*, and murdered their general (April 29). The commanders-in-chief of the armies that were formed became one after another "suspects"; and before a serious action had been fought, the three armies of Rochambeau, Lafayette and Lückner had resolved themselves into two commanded by Dumouriez and Kellermann. Thus the disciplined soldiers of the Allies had apparently good reason to consider the campaign before them a military promenade. On the Rhine, a combined army of Prussians, Austrians, Hessians and *émigrés* under the duke of Brunswick was formed for the invasion of France, flanked by two smaller armies on its right and left, all three being under the supreme command of the king of Prussia. In the Netherlands the Austrians were to besiege Lille, and in the south the Piedmontese also took the field. The first step, taken against Brunswick's advice, was the issue (July 25) of a proclamation which, couched in terms in the last degree offensive to the French nation, generated the spirit that was afterwards to find expression in the "armed nation" of 1793-4, and sealed the fate of Louis XVI. The duke, who was a model sovereign in his own principality, sympathized with the constitutional side of the Revolution, while as a soldier he had no confidence in the success of the enterprise. After completing its preparations in the leisurely manner of the previous generation, his army crossed the French frontier on the 10th of August. Longwy was easily captured; and the Allies slowly marched on to Verdun, which

was more indefensible even than Longwy. The commandant, Colonel Beaurepaire, shot himself in despair, and the place surrendered on the 3rd of September. Brunswick now began his march on Paris and approached the defiles of the Argonne. But Dumouriez, who had been training his raw troops at Valenciennes in constant small engagements, with the purpose of invading Belgium, now threw himself into the Argonne by a rapid and daring flank march, almost under the eyes of the Prussian advanced guard, and barred the Paris road, summoning Kellermann to his assistance from Metz. The latter moved but slowly, and before he arrived the northern part of the line of defence had been forced. Dumouriez, undaunted, changed front so as to face north, with his right wing on the Argonne and his left stretching towards Châlons, and in this position Kellermann joined him at St Menchould on the 19th of September.

Brunswick meanwhile had passed the northern defiles and had then swung round to cut off Dumouriez from Châlons. At the moment when the Prussian manoeuvre was nearly completed, Kellermann, commanding in Dumouriez's momentary absence, advanced his left wing and took up a position between St Menchould and Valmy. The result was the world-renowned Cannonade of Valmy (September 20, 1792). Kellermann's infantry, nearly all regulars, stood steady. The French artillery justified its reputation as the best in Europe, and eventually, with no more than a half-hearted infantry attack, the duke broke off the action and retired. This trivial engagement was the turning-point of the campaign and a landmark in the world's history. Ten days later, without firing another shot, the invading army began its retreat. Dumouriez's pursuit was not seriously pressed; he occupied himself chiefly with a series of subtle and curious negotiations which, with the general advance of the French troops, brought about the complete withdrawal of the enemy from the soil of France.

Meanwhile, the French forces in the south had driven back the Piedmontese and had conquered Savoy and Nice. Another French success was the daring expedition into Germany made by Custine from Alsace. Custine captured Mains itself on the 21st of October and penetrated as far as Frankfurt. In the north the Austrian siege of Lille had completely failed, and Dumouriez now resumed his interrupted scheme for the invasion of the Netherlands. His forward movement, made as it was late in the season, surprised the Austrians, and he disposed of enormously superior forces. On the 6th of November he won the first great victory of the war at Jemappes near Mons and, this time advancing boldly, he overran the whole country from Namur to Antwerp within a month.

Such was the prelude of what is called the "Great War" in England and the "Épopée" in France. Before going further it is necessary to summarize the special features of the French army—in leadership, discipline, tactics, organization and movement—which made these campaigns the archetype of modern warfare.

At the outbreak of the Revolution the French army, like other armies in Europe, was a "voluntary" long-service army, augmented to some extent in war by drafts of militia.

One of the first problems that the Constituent Assembly took upon itself to solve was the nationalization of this strictly royal and professional force, and as early as October 1789 the word "Conscription" was heard in its debates. But it was decreed nevertheless that free enlistment alone befitted a free people, and the regular army was left unaltered in form. However, a National Guard came into existence side by side with it, and the history of French army organization in the next few years is the history of the fusion of these two elements. The first step, as regards the regular army, was the abolition of proprietary rights, the serial numbering of regiments throughout the Army, and the disbandment of the *Maison du roi*. The next was the promotion of deserving soldiers to fill the numerous vacancies caused by the emigration. Along with these, however, there came to the surface many incompetent leaders, favourites in the political clubs of Paris, &c., and the old strict discipline became impossible owing to the frequent intervention of the civil authorities in matters affecting it, the denunciation of generals, and especially the wild words and wild behaviour of "Volunteer" (embodied national guard) battalions.

When war came, it was soon found that the regulars had fallen too low in numbers and that the national guard demanded too high

pay, to admit of developing the expected field strength. Arms, discipline, training alike were wanting to the new levies, and the repulse of Brunswick was effected by manœuvring and fighting on the old lines and chiefly with the old army. The cry of *La patrie en danger*, after giving, at the crisis, the highest moral support to the troops in the front, dwindled away after victory, and the French government contented itself with the half-measures that had, apparently, sufficed to avert the peril. More, when the armies went into winter quarters, the Volunteers claimed leave of absence and went home.

But in the spring of 1793, confronted by a far more serious peril, the government took strong measures. Universal liability was asserted, and passed into law. Yet even now whole classes obtained exemption and the right of substitution as usual forced the burden of service on the poorer classes, so that of the 100,000 men called on for the regular army and 200,000 for the Volunteers, only some 180,000 were actually raised. Desertion, generally regarded as the curse of professional armies, became a conspicuous vice of the defenders of the Republic, except at moments when a supreme crisis called forth supreme devotion—moments which naturally were more or less prolonged in proportion to the gravity of the situation. Thus, while it almost disappeared in the great effort of 1793-1794, when the armies sustained bloody reverses in distant wars of conquest, as in 1799, it promptly rose again to an alarming height.

While this unsatisfactory general levy was being made, defeats, defections and invasion in earnest came in rapid succession, and to deal with the almost desperate emergency, the ruthless Committee of Public Safety sprang into existence. "The levy is to be universal. Unmarried citizens and widowers without children of ages from 18 to 24 are to be called up first," and 450,000 recruits were immediately obtained by this single act. The complete amalgamation of the regular and volunteer units was decided upon. The white uniforms of the line gave place to the blue of the National Guard in all arms and services. The titles of officers were changed, and in fact every relic of the old régime, save the inherited solidity of the old regular battalions, was swept away. This rough combination of line and volunteers therefore—for the "Amalgam" was not officially begun until 1794—must be understood when we refer to the French army of Hondschoote or of Wattignies. It contained, by reason of its universality and also because men were better off in the army than out of it—if they stayed at home they went in daily fear of denunciation and the guillotine—the best elements of the French nation. To some extent at any rate the political *aristocrates* had been weeded out, and though the informer, here as elsewhere, struck unseen blows, the mass of the army gradually evolved its true leaders and obeyed them. It was, therefore, an army of individual citizen-soldiers of the best type, welded by the enemy's fire, and conscious of its own solidarity in the midst of the Revolutionary chaos.

After 1794 the system underwent but little radical change until the end of the Revolutionary period. Its regiments grew in military value month by month and attained their highest level in the great campaign of 1796. In 1795 the French forces (now all styled National Guard) consisted of 531,000 men, of whom 323,000 were infantry (100 3-battalion demi-brigades), 97,000 light infantry (30 demi-brigades), 29,000 artillery, 20,000 engineers and 59,000 cavalry. This novel army developed novel fighting methods, above all in the infantry. This arm had just received a new drill-book, as the result of a prolonged controversy (see INFANTRY) between the advocates of "lines" and "columns," and this drill-book, while retaining the principle of the line, set controversy at rest by admitting battalion columns of attack, and movements at the "quick" (100-120 paces to the minute) instead of at the "slow" march (76). On these two prescriptions, ignoring the rest, the practical troop leaders built up the new tactics little by little, and almost unconsciously. The process of evolution cannot be stated exactly, for the officers learned to use and even to invent now one form, now another, according to ground and circumstances. But the main stream of progress is easily distinguishable.

The earlier battles were fought more or less according to the drill-book, partly in line for fire action, partly in column for the bayonet attack. But line movements required the most accurate tactics—drill, and what was attainable after years of practice with regulars moving at the slow march was wholly impossible for new levies moving at 120 paces to the minute. When, therefore, the line marched off, it broke up into a shapeless swarm of individual fliers. This was the form, if form it can be called, of the tactics of 1793—"horde-tactics," as they have quite justly been called—and a few such experiences as that of Hondschoote sufficed to suggest the need of a remedy. This was found in keeping as many troops as possible out of the firing line. From 1794 onwards the latter becomes thinner and thinner, and instead of the drill-book form, with half the army firing in line (practically in hordes) and the other half in support in columns, we find the rear lines becoming more and more important and numerous, till at last the fire of the leading line (skirmishers) becomes insignificant, and the decision rests with the bayonets of the closed masses in rear. Indeed, the latter often used mixed line and column formations, which enabled them not only to charge, but to fire close-order volleys—absolutely regardless of the skirmishers in front. In other words, the bravest and coolest marksmen were let

loose to do what damage they could, and the rest, massed in close order, were kept under the control of their officers and only exposed to the dissolving influence of the fight when the moment arrived to deliver, whether by fire or by shock, the decisive blow.

The cavalry underwent little change in its organization and tactics, which remained as in the drill-books founded on Frederick's practice. But except in the case of the hussars, who were chiefly Cavalry, Asiatics, it was thoroughly disorganized by the emigration or execution of the nobles who had officered it, and for long it was incapable of facing the hostile squadrons in the open. Still, its elements were good, it was fairly well trained, and mounted, and not overwhelmed with national guard drafts, and like the other arms it duly evolved and obeyed new leaders.

In artillery matters this period, 1792-1796, marks an important progress, due above all to Gribeauval (*q.v.*) and the two du Teil, Jean Pierre (1722-1794) and Jean (1733-1820) who were Napoleon's instructors. The change was chiefly in organization and equipment—the great tactical development of the arm was not to come until the time of the *Grande Armée*—and may be summarized as the transition from battalion guns and reserve artillery to batteries of "horse and field."

The engineers, like the artillery, were a technical and non-noble corps. They escaped, therefore, most of the troubles of the Revolution—indeed the artillery and engineer officers, Napoleon and Carnot amongst them, were conspicuous in the political regeneration of France—and the engineers carried on with little change the traditions of Vauban and Cormontaigne (see FORTIFICATION AND SIEGE-CRAFT). Before these corps were, after the Revolution as before it, the best in Europe, other armies admitting their superiority and following their precedents.

In all this the army naturally outgrew its old "linear" organization. Temporary divisions, called for by momentary necessities, placed under selected generals and released from the detailed supervision of the commander-in-chief, soon became, though in an irregular and haphazard fashion, permanent organisms, and by 1796 the divisional system had become practically universal. The next step, as the armies became fewer and larger, was the temporary grouping of divisions; this too in turn became permanent, and bequeathed to the military world of to-day both the army corps and the capable, self-reliant and enterprising subordinate generals, for whom the old linear organization had no room.

This subdivision of forces was intimately connected with the general method of making war adopted by the "New French," as their enemies called them. What astonished the Allies most of all was the number and the velocity of the Republicans. These improvised armies had in fact nothing to delay them. Tents were unprocurable for want of money; untransportable for want of the enormous number of wagons that would have been required, and also unnecessary, for the discomfort that would have caused wholesale desertion in professional armies was cheerfully borne by the men of 1793-1794. Supplies for armies of then unheard-of size could not be carried in convoys, and the French soon became familiar with "living on the country." Thus 1793 saw the birth of the modern system of war—rapidity of movement, full development of national strength, bivouacs and requisitions, and force, as against cautious manœuvring, small professional armies, tents and full rations, and chicane. The first represented the decision-compelling spirit, the second the spirit of risking little to gain a little. Above all, the decision-compelling spirit was reinforced by the presence of the emissaries of the Committee of Public Safety, the "representatives on mission" who practically controlled the guillotine. There were civil officials with the armies of the Allies too, but their chief function was not to infuse desperate energy into the military operations, but to see that the troops did not maltreat civilians. Such were the fundamental principles of the "New French" method of warfare, from which the warfare of to-day descends in the direct line. But it was only after a painful period of trial and error, of waste and misdirection, that it became possible for the French army to have evolved Napoleon, and for Napoleon to evolve the principles and methods of war that conformed to and profited to the utmost by the new conditions.

Those campaigns and battles of this army which are described in detail in the present article have been selected, some on account of their historical importance—as producing great results, others from their military interest—as typifying and illustrating the nature of the revolution undergone by the art of war in these heroic years.

CAMPAIGNS IN THE NETHERLANDS

The year 1793 opened disastrously for the Republic. As a consequence of Jemappes and Valmy, France had taken the offensive both in Belgium, which had been overrun by Dumouriez's army, and in the Rhine countries, where Custine had preached the new gospel to the sentimental and half-discontented Hessians and Mainzers. But the execution of Louis XVI. raised up a host of new and determined enemies—England, Holland, Austria, Prussia, Spain and Sardinia promptly

*Universal
service
of the
"Amalgam."*

*The starting-point
of modern
warfare.*

formed the First Coalition. England poured out money in profusion to pay and equip her Allies' land armies, and herself began the great struggle for the command of the sea (see *Naval Operations*, below).

In the Low Countries, while Dumouriez was beginning his proposed invasion of Holland, Prince Josias of Saxe-Coburg, the new Austrian commander on the Lower Rhine, advanced with 42,000 men from the region of Cologne, and drove in the various detachments that Dumouriez had posted to cover his right. The French general thereupon abandoned his advance into Holland, and, with what forces he could gather, turned towards the Meuse. The two armies met at Neerwinden (*q.v.*) on the 18th of March 1793. Dumouriez had only a few thousand men more than his opponent, instead of the enormous superiority he had had at Jemappes. Thus the enveloping attack could not be repeated, and in a battle on equal fronts the old generalship and the old armies had the advantage. Dumouriez was thoroughly defeated, the house of cards collapsed, and the whole of the French forces retreated in confusion to the strong line of border fortresses, created by Louis XIV. and Vauban.¹ Dumouriez, witnessing the failure of his political schemes, declared against the Republic, and after a vain attempt to induce his own army to follow his example, fled (April 5) into the Austrian lines. The leaderless Republicans streamed back to Valenciennes. There, however, they found a general. Picot (*comte de*) Dampierre was a regimental officer of the old army, who, in spite of his vanity and extravagance, possessed real loyalty to the new order of things, and brilliant personal courage. At the darkest hour he seized the reins without orders and without reference to seniority, and began to reconstruct the force and the spirit of the shattered army by wise administration and dithyrambic proclamations. Moreover, he withdrew it well behind Valenciennes out of reach of a second reverse. The region of Dunkirk and Cassel, the camp of La Madeleine near Lille, and Bouchain were made the rallying points of the various groups, the principal army being at the last-named. But the blow of Neerwinden had struck deep, and the army was for long incapable of service, what with the general distrust, the misconduct of the newer battalions, and the discontent of the old white-coated regiments that were left ragged and shoeless to the profit of the "patriot" corps. "Beware of giving horses to the 'Hussars of Liberty,'" wrote Carnot, "all these new corps are abominable."

France was in fact defenceless, and the opportunity existed for the military promenade to Paris that the allied statesmen had imagined in 1792. But Coburg now ceased to be a purely Austrian commander, for one by one allied contingents, with instructions that varied with the political aims of the various governments, began to arrive. Moreover, he had his own views as to the political situation, fearing especially to be the cause of the queen's death as Brunswick had been of the king's, and negotiated for a settlement. The story of these negotiations should be read in Chuquet's *Valenciennes*—it gives the key to many mysteries of the campaign and shows that though the revolutionary spirit had already passed all understanding, enlightened men such as Coburg and his chief-of-staff Mack sympathized with its first efforts and thought the constitution of 1791 a gain to humanity. "If you come to Paris you will find 80,000 patriots ready to die," said the French negotiators. "The patriots could not resist the Austrian regulars," replied Coburg, "but I do not propose to go to Paris. I desire to see a stable government, with a chief, king or other, with whom we can treat." Soon, however, these personal negotiations were stopped by the emperor, and the idea of restoring order in France became little more than a pretext for a general intrigue amongst the confederate powers, each seeking to aggrandize itself at France's expense.

"If you wish to deal with the French," observed Dumouriez ironically to Coburg, "talk 'constitution.' You may beat them but you cannot subdue them." And their subjugation was becoming less and less possible as the days went on and men

¹For the following operations see map in SPANISH SUCCESSION WAR.

talked of the partition of France as a question of the moment like the partition of Poland—a pretension that even the émigrés resented.

Coburg's plan of campaign was limited to the objects acceptable to all the Allies alike. He aimed at the conquest of a first-class fortress—Lille or Valenciennes—and chiefly for this reason. War meant to the burgher of Germany and the Netherlands a special form of *hante politique* with which it was neither his business nor his inclination to meddle. He had no more compunction, therefore, in selling his worst goods at the best price to the army commissaries than in doing so to his ordinary customers. It followed that, owing to the distance between Vienna and Valenciennes, and the exorbitant prices charged by carters and horse-owners, a mere concentration of Austrian troops at the latter place cost as much as a campaign, and the transport expenses rose to such a figure that Coburg's first duty was to find a strong place to serve as a market for the countryside and a depot for the supplies purchased, and to have it as near as possible to the front to save the hire of vehicles. As for the other governments which Coburg served as best he could, the object of the war was material concessions, and it would be easy to negotiate for the cession of Dunkirk and Valenciennes when the British and Austrian colours already waved there. The Allies, therefore, instead of following up their advantage over the French field army and driving forward on the open Paris road, set their faces westward, intending to capture Valenciennes, Le Quesnoy, Dunkirk and Lille one after the other.

Dampierre meanwhile grew less confident as responsibility settled upon his shoulders. Quite unable to believe that Coburg would bury himself in a maze of rivers and fortresses when he could scatter the French army to the winds by a direct advance, he was disquieted and puzzled by the Austrian investment of Condé. This was followed by skirmishes around Valenciennes, so unfavourable to the French that their officers felt it would be madness to venture far beyond the support of the fortress guns. But the representatives on mission ordered Dampierre, who was reorganizing his army at Bouchain, to advance and occupy Famars camp, east of Valenciennes, and soon afterwards, disregarding his protests, bade him relieve Condé at all costs. His skill, though not commensurate with his personal courage and devotion, sufficed to give him the idea of attacking Coburg on the right bank of the Scheldt while Clerfayt, with the corps covering the siege of Condé, was on the left, and then to turn against Clerfayt—in fact, to operate on interior lines—but it was far from being adequate to the task of beating either with the disheartened forces he commanded. On the 1st of May, while Clerfayt was held in check by a very vigorous demonstration, Coburg's positions west of Quiévrain were attacked by Dampierre himself. The French won some local successes by force of numbers and surprise, but the Allies recovered themselves, thanks chiefly to the address and skill of Colonel Mack, and drove the Republicans in disorder to their entrenchments. Dampierre's discouragement now became desperation, and, urged on by the representatives (who, be it said, had exposed their own lives freely enough in the action), he attacked Clerfayt on the 8th at Raismes. The troops fought far better in the woods and hamlets west of the Scheldt than they had done in the plains to the east. But in the heat of the action Dampierre, becoming again the brilliant soldier that he had been before responsibility stifled him, risked and lost his life in leading a storming party, and his men retired sullenly, though this time in good order, to Valenciennes. Two days later the French gave up the open field and retired into Valenciennes. Dampierre's remains were by a vote of the Convention ordered to be deposited in the Panthéon. But he was a "ci-devant" noble, the demagogues denounced him as a traitor, and the only honour finally paid to the man who had tided over the weeks of greatest danger was the placing of his bust, in the strange company of those of Brutus and Marat, in the chamber of deputies.

Another pause followed, Coburg awaiting the British contingent under the duke of York, and the Republicans endeavouring

Assembly
of the
Allies.

Dampierre
at Valen-
ciennes.

assimilate the reinforcements of conscripts, for the most part "undesirables," who now arrived. Mutiny and denunciations augmented the confusion in the French camp. Plan of campaign there was none, save a resolution to stay at Valenciennes in the hope of finding an opportunity of relieving Condé and to create diversions elsewhere by expeditions from Dunkirk, Lille and Sedan. These of course came to nothing, and before they had even started, Coburg, resuming the offensive, had stormed the lines of Famars (May 24), whereupon the French army retired to Bouchain, leaving not only Condé¹ but also Valenciennes to resist as best they could. The central point of the new positions about Bouchain was called Caesar's Camp. Here, surrounded by streams and marshes, the French generals thought that their troops were secure from the rush of the dreaded Austrian cavalry, and Mack himself shared their opinion.

Custine now took command of the abjectly dispirited army, the fourth change of command within two months. His first task was to institute a severe discipline, and his prestige was so great that his mere threat of death sentences for offenders produced the desired effect. As to operations, he wished for a concentration of all possible forces from other parts of the frontier towards Valenciennes, even if necessary at the cost of sacrificing his own conquest of Mainz. But after he had induced the government to assent to this, the generals of the numerous other armies refused to give up their troops, and on the 17th of June the idea was abandoned in view of the growing seriousness of the Vendéan insurrection (see VENDÉE). Custine, therefore, could do no more than continue the work of reorganization. Military operations were few. Coburg, who had all this time succeeded in remaining concentrated, now found himself compelled to extend leftwards towards Flanders,² for Custine had infused some energy into the scattered groups of the Republicans in the region of Douai, Lille and Dunkirk—and during this respite the Paris Jacobins sent to the guillotine both Custine and his successor La Marlière before July was ended. Both were "ci-devant" nobles and, so far as is ascertainable, neither was guilty of anything worse than attempts to make his orders respected by, and himself popular with, the soldiers. By this time, owing to the innumerable denunciations and arrests, the confusion in the Army of the North was at its height, and no further attempt was made either to relieve Valenciennes and Condé, or to press forward from Lille and Dunkirk. Condé, starved out as Coburg desired, capitulated on the 10th of June, and the Austrians, who had done their work as soldiers, but were filled with pity for their suffering and distracted enemies, marched in with food for the women and children. Valenciennes, under the energetic General Ferrand, held out bravely until the fire of the Allies became intolerable, and then the civil population began to plot treachery, and to wear the Bourbon cockade in the open street. Ferrand and the representatives

Fall of Valenciennes.

with him found themselves obliged to surrender to the duke of York, who commanded the siege corps, on the 28th of July, after rejecting the first draft of a capitulation sent in by the duke and threatening to continue the defence to the bitter end. Impossible as this was known to be—for Valenciennes seemed to have become a royalist town—Ferrand's soldierly bearing carried the day, and honourable terms were arranged. The duke even offered to assist the garrison in repressing disorder. Shortly after this the wreck of the field army was forced to evacuate Caesar's Camp after an unimportant action (Aug. 7-8) and retired on Arras. By this they gave up the direct defence of the Paris road, but placed themselves in a "flank position" relatively to it, and secured to themselves the resources and reinforcements available in the region of Dunkirk-Lille.

¹ Coburg refrained from a regular siege of Condé. He wished to gain possession of the fortress in a defensible state, intending to use it as his own depot later in the year. He therefore reduced it by famine. During the siege of Valenciennes the Allies appear to have been supplied from Mons.

² Henceforth to the end of 1794 both armies were more or less "in cordon," the cordon possessing greater or less density at any particular moment or place, according to the immediate intentions of the respective commanders and the general military situation.

Bouchain and Cambrai, Landrecies and Le Quesnoy, were left to their own garrisons.

With this ended the second episode of the amazing campaign of 1793. Military operations were few and spasmodic, on the one side because the Allied statesmen were less concerned with the nebulous common object of restoring order in France than with their several schemes of aggrandisement, on the other owing to the almost incredible confusion of France under the régime of Danton and Marat. The third episode shows little or no change in the force and direction of the allied efforts, but a very great change in France. Thoroughly roused by disaster and now dominated by the furious and bloodthirsty energy of the terrorists, the French people and armies at last set before themselves clear and definite objects to be pursued at all costs.

Jean Nicolas Houchard, the next officer appointed to command, had been a heavy cavalry trooper in the Seven Years' War. His face bore the scars of wounds received at Minden, and his bravery, his stature, his bold and fierce manner, his want of education, seemed to all to betoken the ideal sans-culotte general. But he was nevertheless incapable of leading an army, and knowing this, carefully conformed to the advice of his staff officers Berthelmy and Gay-Vernon, the latter of whom, an exceptionally capable officer, had been Custine's chief of staff and was consequently under suspicion. At one moment, indeed, operations had to be suspended altogether because his papers were seized by the civil authorities, and amongst them were all the confidential memoranda and maps required for the business of headquarters. It was the darkest hour. The Vendéans, the people of Lyons, Marseilles and Toulon, were in open and hitherto successful revolt. Valenciennes had fallen and Coburg's hussar parties pressed forward into the Somme valley. Again the Allies had the decision of the war in their own hands. Coburg, indeed, was still afraid, on Marie Antoinette's account, of forcing the Republicans to extremities, and on military grounds too he thought an advance on Paris hazardous. But, hazardous or not, it would have been attempted but for the English. The duke of York had definite orders from his government to capture Dunkirk—at present a nest of corsairs which interfered with the Channel trade, and in the future, it was hoped, a second Gibraltar—and after the fall of Valenciennes and the capture of Caesar's Camp the English and Hanoverians marched away, via Tournai and Ypres, to besiege the coast fortress. Thereupon the king of Prussia in turn called off his contingent for operations on the middle Rhine. Holland, too, though she maintained her contingent in face of Lille (where it covered Flanders), was not disposed to send it to join the imperialists in an adventure in the heart of France. Coburg, therefore, was brought to a complete standstill, and the scene of the decision was shifted to the district between Lille and the coast.

Thither came Carnot, the engineer officer who was in charge of military affairs in the Committee of Public Safety and is known to history as the "Organizer of Victory." His views of the strategy to be pursued indicate either a purely geographical idea of war, which does not square with his later principles and practice, or, as is far more likely, a profound disbelief in the capacity of the Army of the North, as it then stood, to fight a battle, and they went no further than to recommend an inroad into Flanders on the ground that no enemy would be encountered there. This, however, in the event developed into an operation of almost decisive importance, for at the moment of its inception the duke of York was already on the march. Fighting *en route* a very severe but successful action (Lincelles, Aug. 18) with the French troops encamped near Lille, the Anglo-Hanoverians entered the district—densely intersected with canals and morasses—around Dunkirk and Bergues on the 21st and 22nd. On the right, by way of Furnes, the British moved towards Dunkirk and invested the east front of the weak fortress, while on the left the Hanoverian field marshal v. Freytag moved via Poperinghe on Bergues. The French had a chain of outposts between Furnes and Bergues, but Freytag attacked them resolutely, and the defenders, except a brave handful who stood

to cross bayonets, fled in all directions. The east front of Bergues was invested on the 23rd, and Freytag spread out his forces to cover the duke of York's attack on Dunkirk, his right being opposite Bergues and his centre at Bambeke, while his left covered the space between Roosbrugge and Ypres with a cordon of posts. Houchard was in despair at the bad conduct of his troops. But one young general, Jourdan, anticipating Houchard's orders, had already brought a strong force from Lille to Cassel, whence he incessantly harried Freytag's posts. Carnot encouraged the garrisons of Dunkirk and Bergues, and caused the sluices to be opened. The *moral* of the defenders rose rapidly. Houchard prepared to bring up every available man of the Army of the North, and only waited to make up his mind as to the direction in which his attack should be made. The Allies themselves recognized the extreme danger of their position. It was cut in half by the Great Morass, stretches of which extended even to Furnes. Neither Dunkirk nor Bergues could be completely invested owing to the inundations, and Freytag sent a message to King George III. to the effect that if Dunkirk did not surrender in a few days the expedition would be a complete failure.

As for the French, they could hardly believe their good fortune. Generals, staff officers and representatives on mission alike were eager for a swift and crushing offensive. "Attack and attack in mass" became the shibboleth and the catch-phrase of the camps" (Chuquet), and fortresses and armies on other parts of the frontier were imperiously called upon to supply large drafts for the Army of the North. Gay-Vernon's strategical instinct found expression in a wide-ranging movement designed to secure the absolute annihilation of the duke of York's forces. Beginning with an attack on the Dutch posts north and east of Lille, the army was then to press forward towards Furnes, the left wing holding Freytag's left wing in check, and the right swinging inwards and across the line of retreat of both allied corps. At that moment all men were daring, and the scheme was adopted with enthusiasm. On the 28th of August, consequently, the Dutch posts were attacked and driven away by the mobile forces at Lille, aided by parts of the main army from Arras. But even before they had fired their last shot the Republicans dispersed to plunder and compromised their success. Houchard and Gay-Vernon began to fear that their army would not emerge successfully from the supreme test they were about to impose on it, and from this moment the scheme of destroying the English began to give way to the simpler and safer idea of relieving Dunkirk. The place was so ill-equipped that after a few days' siege it was *in extremis*, and the political importance of its preservation led not merely the civilian representatives, but even Carnot, to implore Houchard to put an end to the crisis at once. On the 30th, Cassel, instead of Ypres, was designated as the point of concentration for the "mass of attack." This surprised the representatives and Carnot as much as it surprised the subordinate generals, all of whom thought that there would still be time to make the détour through Ypres and to cut off the Allies' retreat before Dunkirk fell. But Houchard and Gay-Vernon were no longer under any illusions as to the manœuvring power of their forces, and the government agents wisely left them to execute their own plans. Thirty-seven thousand men were left to watch Coburg and to secure Arras and Douai, and the rest, 50,000 strong, assembled at Cassel. Everything was in Houchard's favour could he but overcome the indiscipline of his own army. The duke of York was more dangerous in appearance than in reality—as the result must infallibly have shown had Houchard and Gay-Vernon possessed the courage to execute the original plan—and Freytag's covering army extended in a line of disconnected posts from Bergues to Ypres.

Against the left and centre of this feeble cordon 40,000 men advanced in many columns on the 6th of September. A confused outpost fight, in which the various assailing columns dissolved into excited swarms, ended, long after nightfall, in the orderly withdrawal of the various allied posts to Hondschoote. The French generals were occupied the whole of next day in sorting out their troops, who had not

only completely wasted their strength against mere outposts, but had actually consumed their rations and used up their ammunition. On the 8th, the assailants, having more or less recovered themselves, advanced again. They found Wallmoden (who had succeeded Freytag, disabled on the 6th) entrenched on either side of the village of Hondschoote, the right resting on the great morass and the left on the village of Leyele. Here was the opportunity for the "attack in mass" that had been so freely discussed; but Houchard was now concerned more with the relief of Dunkirk than with the defeat of the enemy. He sent away one division to Dunkirk, another to Bergues, and a third towards Ypres, and left himself only some 20,000 men for the battle. But Wallmoden had only 13,000—so great was the disproportion between end and means in this ill-designed enterprise against Dunkirk.

Houchard despatched a column, guided by his staff officer Berthelmy, to turn the Hanoverians' left, but this column lost



Redrawn from a map in Forester's *History of the British Army*, by permission of Macmillan & Co., Ltd.

its way in the dense country about Loo. The centre waited motionless under the fire of the allied guns near Hondschoote. In vain the representative Delbrel implored the general to order the advance. Houchard was obstinate, and ere long the natural result followed. Though Delbrel posted himself in front of the line, conspicuous by his white horse and tricoloured sash and plume, to steady the men, the bravest left the ranks and skirmished forward from bush to bush, and the rest sought cover. Then the allied commander ordered forward one regiment of Hessians, and these, advancing at a ceremonial slow march, and firing steady rolling volleys, scattered the Republicans before them. At this crisis Houchard uttered the fatal word "retreat," but Delbrel overwhelmed him with reproaches and stung him into renewed activity. He hurried away to urge forward the right wing while Jourdan rallied the centre and led it into the fight again. Once more Jourdan awaited in vain the order to advance, and once more the troops broke. But at last the exasperated Delbrel rose to the occasion. "You fear the responsibility," he cried to Jourdan; "well, I assume it. My authority overrides the general's and I give you the formal order to attack at once!" Then, gently, as if to soften a rebuke, he continued, "You have forced me to speak as a superior; now I will be your aide-de-

camp," and at once hurried off to bring up the reserves and to despatch cavalry to collect the fugitives. This incident, amongst many, serves to show that the representatives on mission were no mere savage marplots, as is too generally assumed. They were often wise and able men, brave and fearless of responsibility in camp and in action. Jourdan led on the reserves, and the men fighting in the bushes on either side of the road heard their drums to right and left. Jourdan fell wounded, but Delbrel headed a wild irregular bayonet charge which checked the Hanoverians, and Houchard himself, in his true place as a cavalry leader, came up with 500 fresh sabres and flung himself on the Allies. The Hanoverians, magnificently disciplined troops that they were, soon re-formed after the shock, but by this time the fugitives collected by Delbrel's troopers, reanimated by new hopes of victory, were returning to the front in hundreds, and a last assault on Hondschoote met with complete success.

Hondschoote was a psychological victory. Materially, it was no more than the crushing of an obstinate rearguard at enormous expense to the assailants, for the duke of York was able to withdraw while there was still time. Houchard had indeed called back the division he had sent to Bergues, and despatched it by Loo against the enemy's rear, but the movement was undertaken too late in the day to be useful. The struggle was practically a front to front battle, numbers and enthusiasm on the one side, discipline, position and steadiness on the other. Hence, though its strategical result was merely to compel the duke of York to give up an enterprise that he should never have undertaken, Hondschoote established the fact that the "New French" were determined to win, at any cost and by sheer weight and energy. It was long before they were able to meet equal numbers with confidence, and still longer before they could freely oppose a small corps to a larger one. But the nightmare of defeats and surrenders was dispelled.

The influence of Houchard on the course of the operations had been sometimes null, sometimes detrimental, and only occasionally good. The plan and its execution were the work of Berthelmy and Gay-Vernon, the victory itself was Jourdan's and, above all, Delbrel's. To these errors, forgiven to a victor, Houchard added the crowning offence of failure, in the reaction after the battle, to pursue his advantage. His enemies in Paris became more and more powerful as the campaign continued.

Having missed the great opportunity of crushing the English, Houchard turned his attention to the Dutch posts about Menin.

Menin. As far as the Allies were concerned Hondschoote was a mere reverse, not a disaster, and was counter-balanced in Coburg's eyes by his own capture of Le Quesnoy (Sept. 11). The proximity of the main body of the French to Menin induced him to order Beaulieu's corps (hitherto at Cysoing and linking the Dutch posts with the central group) to join the prince of Orange there, and to ask the duke of York to do the same. But this last meant negotiation, and before anything was settled Houchard, with the army from Hondschoote and a contingent from Lille, had attacked the prince at Menin and destroyed his corps (Sept. 12-13).

After this engagement, which, though it was won by immensely superior forces, was if not an important at any rate a complete victory, Houchard went still farther inland—leaving detachments to observe York and replacing them by troops from the various camps as he passed along the cordon—in the hope of dealing with Beaulieu as he had dealt with the Dutch, and even of relieving Le Quesnoy. But in all this he failed. He had expected to meet Beaulieu near Cysoing, but the Austrian general had long before gone northward to assist the prince of Orange. Thus Houchard missed his target. Worse still, one of his protective detachments chanced to meet Beaulieu near Courtrai on the 15th, and was not only defeated but driven in rout from Menin. Lastly, Coburg had already captured Le Quesnoy, and had also repulsed a straggling attack of the Landrecies, Bouchain and other French garrisons on the positions of his covering army (12th).¹

¹ In the course of this the column from Bouchain, 4500 strong, was caught in the open at Avesnes-le-Sec by 5 squadrons of the allied cavalry and literally annihilated.

Houchard's offensive died away completely, and he halted his army (45,000 strong excluding detachments) at Gaverelle, half-way between Douai and Arras, hoping thereby to succour Bouchain, Cambrai or Arras, whichever should prove to be Coburg's next objective. After standing still for several days, a prey to all the conflicting rumours that reached his ears, he came to the conclusion that Coburg was about to join the duke of York in a second siege of Dunkirk, and began to close on his left. But his conclusion was entirely wrong. The Allies were closing on their left inland to attack Maubeuge. Coburg drew in Beaulieu, and even persuaded the Dutch to assist, the duke of York undertaking for the moment to watch the whole of the Flanders cordon from the sea to Tournai. But this concentration of force was merely nominal, for each contingent worked in the interests of its own masters, and, above all, the siege that was the object of the concentration was calculated to last four weeks, i.e. gave the French four weeks unimpeded liberty of action.

Houchard was now denounced and brought captive to Paris. Placed upon his trial, he offered a calm and reasoned defence of his conduct, but when the intolerable word "coward" was hurled at him by one of his judges he wept with rage, pointing to the scars of his many wounds, and then, his spirit broken, sank into a lethargic indifference, in which he remained to the end. He was guillotined on the 16th of November 1793.

After Houchard's arrest, Jourdan accepted the command, though with many misgivings, for the higher ranks were filled by officers with even less experience than he had himself, equipment and clothing was wanting, and, perhaps more important still, the new levies, instead of filling up the depleted ranks of the line, were assembled in undisciplined and half-armed hordes at various frontier camps, under elected officers who had for the most part never undergone the least training. The field states showed a total of 104,000 men, of whom less than a third formed the operative army. But an enthusiasm equal to that of Hondschoote, and similarly demanding a plain, urgent and recognizable objective, animated it, and although Jourdan and Carnot (who was with him at Gaverelle, where the army had now reassembled) began to study the general strategic situation, the Committee brought them back to realities by ordering them to relieve Maubeuge at all costs.

The Allies disposed in all of 66,000 men around the threatened fortress, but 26,000 of these were actually employed in the siege, and the remainder, forming the covering army, extended in an enormous semicircle of posts facing west, south and east. Thus the Republicans, as before, had two men to one at the point of contact (44,000 against 21,000), but so formidable was the discipline and steadiness of manoeuvre of the old armies that the chances were considered as no more than "rather in favour" of the French. Not that these chances were seriously weighed before engaging. The generals might squander their energies in the council chamber on plans of sieges and expeditions, but in the field they were glad enough to seize the opportunity of a battle which they were not skilful enough to compel. It took place on the 15th and 16th of October, and though the allied right and centre held their ground, on their left the plateau of Wattignies (*q.v.*), from which the battle derives its name, was stormed on the second day, Carnot, Jourdan and the representatives leading the columns in person. Coburg indeed retired in unbroken order, added to which the Maubeuge garrison had failed to co-operate with their rescuers by a sortie,² and the duke of York had hurried up with all the men he could spare from the Flanders cordon. But the Dutch generals refused to advance beyond the Sambre, and Coburg broke up the siege of Maubeuge and retired whence he had come, while Jourdan, so far from pressing forward, was anxiously awaiting a counter-attack, and entrenching himself with all possible energy. So ended the episode of Wattignies, which, alike in its general outline and in its details, gives a perfect picture of the character, at once intense and spasmodic, of the "New French" warfare in the days of the Terror.

² One of the generals at Maubeuge, Chancel, was guillotined.

To complete the story of '93 it remains to sketch, very briefly, the principal events on the eastern and southern frontiers of France. These present, in the main, no special features, and all that it is necessary to retain of them is the fact of their existence. What this anticipation of their tasks meant to the Committee of Public Safety and to Carnot in particular it is impossible to realize. It was not merely on the Sambre and the Scheldt, nor against one army of heterogeneous allies that the Republic had to fight for life, but against Russians and Hessians on the Rhine, Sardinians in the Alps, Spaniards in the Pyrenees, and also (one might say, indeed, above all) against Frenchmen in Vendée, Lyons, Marseilles and Toulon.

On the Rhine, the advance of a Prussian-Hessian army, 63,000 strong, rapidly drove back Custine from the Main into the valleys of the Saar and the Lauter. An Austrian corps under Wurmsier soon afterwards invaded Alsace. Here, as on the northern frontier, there was a long period of trial and error, of denunciations and indiscipline, and of wholly trivial fighting, before the Republicans recovered themselves. But in the end the ragged enthusiasts found their true leader in Lazare Hoche, and, though defeated by Brunswick at *Armasens* and *Kaiserslautern*, they managed to develop almost their full strength against Wurmsier in Alsace. On the 26th of December the latter, who had already undergone a series of partial reverses, was driven by main force from the lines of Weissenburg, after which Hoche advanced into the Palatinate and delivered Landau, and Pichegru moved on to recapture Mainz, which had surrendered 1 July. On the Spanish frontier both sides indulged in a fruitless war of posts in broken ground. The Italian campaign of 1793, equally unprofitable, will be referred to below. Far more serious than either was the insurrection of Vendée (*q.v.*) and the counter-revolution in the south of France, the principal incidents of which were the terrible sieges of Lyons and Toulon.

For 1794 Carnot planned a general advance of all the northern armies, that of the North (Pichegru) from Dunkirk-Cassel by Ypres and Oudenarde on Brussels, the minor Army of the Ardennes to Charleroi, and the Army of the Moselle (Jourdan) to Liège, while between Charleroi and Lille demonstrations were to be made against the hostile centre. He counted upon little as regards the two armies near the Meuse, but hoped to force on a decisive battle by the advance of the left wing towards Ypres. Coburg, on the other side, intended, if not forced to develop his strength on the Ypres side, to make his main effort against the French centre about Landrecies. This produced the siege of Landrecies, which need not concern us, a forward movement of the French to Menin and Courtrai which resulted in the battles of Tourcoing and Tournai, and the campaign of Fleurus, which, almost fortuitously, produced the long-sought decision.

The first crisis was brought about by the advance of the left wing of the Army of the North, under Souham, to Menin-Courtrai. His advance placed Souham in the midst of the enemy's right wing, and at last stimulated the Allies into adopting the plan that Mack had advocated, in season and out of season, since before Neerwinden—that of *annihilating the enemy's army*. His vigorous purpose, and the leading part in its execution played by the duke of York and the British contingent, give these operations, to Englishmen at any rate, a living interest which is entirely lacking in, say, the sieges of Le Quesnoy and Landrecies. On the other side, the "New French" armies and their leaders, without losing the energy of 1793, had emerged from confusion and inexperience, and the powers of the new army and the new system had begun to mature. Thus it was a fair trial of strength between the old way and the new.

In the second week of May the left wing of the Army of the North—the centre was towards Landrecies, and the right, used in the Army of the Ardennes, towards Charleroi—found itself interposed at Menin-Courtrai-Lille between two hostile masses, the main body of the allied right wing about Tournai and a secondary corps at Thielt. Common-sense, therefore, dictated a converging attack for the Allies and a series of rapid radial blows for the French. In the allied camp common-sense had first to prevail over routine, and the emperor's first orders were for a raid of the Thielt corps towards Ypres, which his advisers hoped would of itself cause the French to decamp. But the duke of York formed a very different plan, and Feldzeugmeister Clerfayt, in command at Thielt, agreed to co-operate. Their proposal was to surround the French on the Lys with their two corps, and by the 15th the emperor had decided to use larger forces with the same object.

XI. 4

On that day Coburg himself, with 6000 men under Feldzeugmeister Kinsky from the central (Landrecies) group, entered Tournai and took up the general command, while Mack's another reinforcement under the archduke Charles "annihilated plan." marched towards Orchies. Orders were promptly issued for a general offensive. Clerfayt's corps was to be between Rousselaer and Menin on the 16th, and the next day to force its way across the Lys at Werwick and connect with the main army. The main army was to advance in four columns. The first three, under the duke of York, were to move off, at daylight on the 17th, by Dottignies, Leers and Lannoy respectively to the line Mouscron-Tourcoing-Mouveaux. The fourth and fifth under Kinsky and the archduke Charles were to defeat the French corps on the upper Marque, and then, leaving Lille on their left and guaranteeing themselves by a cordon system against being



cut off from Tournai (either by the troops just defeated or by the Lille garrison), to march rapidly forward towards Werwick, getting touch on their right with the duke of York and on their left with Clerfayt, and thus completing the investing circle around Souham's and Moreau's isolated divisions. Speed was enjoined on all. Picked volunteers to clear away the enemy's skirmishers, and pioneers to make good difficult places on the roads, were to precede the heads of the columns. Then came at the head of the main body the artillery with an infantry escort. All this might have been designed by the Japanese for the attack of some well-defined Russian position in the war of 1904. Outpost and skirmisher resistance was to be overpowered the instant it was offered, and the attack on the closed bodies of the enemy was to be initiated by a heavy artillery fire at the earliest possible moment. But in 1904 the Russians stood still, which was the last thing that the Revolutionary armies of 1794 would or could do. Mack's well-considered and carefully balanced

combinations failed, and doubtless helped to create the legend of his incapacity, which finds no support either in the opinion of Coburg, the representative of the old school, or in that of Scharnhorst, the founder of the new

Souham, who commanded in the temporary absence of Pichegru, had formed his own plan. Finding himself with the major part of his forces between York and Clerfayt, he had decided to impose upon the former by means of a covering detachment, and to fall upon Clerfayt near Rousselaer with the bulk of his forces. This plan, based as it was on a sound calculation of time, space, strength and endurance, merits close consideration, for it contains more than a trace of the essential principles of modern strategy, yet with one vital difference, that whereas, in the present case, the factor of the enemy's independent will wrecked the scheme, Napoleon would have guaranteed to himself, before and during its development, the power of executing it in spite of the enemy. The appearance of fresh allied troops (Kinsky) on his right front at once modified these general arrangements. Divining Coburg's intentions from the arrival of the enemy near Pont-à-Marque and at Lannoy, he ordered Bonnaud (Lille group, 27,000) to leave enough troops on the upper Marque to amuse the enemy's leftmost columns, and with every man he had left beyond this absolute minimum to attack the left flank of the columns moving towards Tourcoing, which his weak centre (12,000 men at Tourcoing, Mouscron and Roubaix) was to stop by frontal defence. No rôle was as yet assigned to the principal mass (50,000 under Moreau) about Courtrai. Vandamme's brigade was to extend along the Lys from Menin to Werwick and beyond, to deny as long as possible the passage to Clerfayt.

This second plan failed like the first, because the enemy's counter-will was not controlled. All along the line Coburg's advance compelled the French to fight as they were without any redistribution. But the French were sufficiently elastic to adapt themselves readily to unforeseen conditions, and on Coburg's side too the unexpected happened. When Clerfayt appeared on the Lys above Menin, he found Werwick held. This was an accident, for the battalion there was on its way to Menin, and Vandamme, who had not yet received his new orders, was still far away. But the battalion fought boldly, Clerfayt sent for his pontoons; and ere they arrived Vandamme's leading troops managed to come up on the other side. Thus it was not till 1 A.M. on the 18th that the first Austrian battalions passed the Lys.

On the front of the main allied group the "annihilation plan" was crippled at the outset by the tardiness of the archduke's (fifth or left) column. On this the smooth working of the whole scheme depended, for Coburg considered that he must defeat Bonnaud before carrying out his intended envelopment of the Menin-Courtrai group (the idea of "binding" the enemy by a detachment while the main scheme proceeded had not yet arisen). The allied general, indeed, on discovering the backwardness of the archduke, went so far as to order all the other columns to begin by swerving southward against Bonnaud, but these were already too deeply committed to the original plan to execute any new variation.

The rightmost column (Hanoverians) under von dem Bussche moved on Mouscron, overpowering the fragmentary, if energetic, resistance of the French advanced posts. Next on the left, Lieutenant Field Marshal Otto moved by Leers and Watrellos, driving away a French post at Lis (near Lannoy) on his left flank, and entered Tourcoing. But meantime a French brigade had driven von dem Bussche away from Mouscron, so that Otto felt compelled to keep troops at Leers and Watrellos to protect his rear, which seriously weakened his hold on Tourcoing. The third column, led by the duke of York, advanced from Templeuve on Lannoy, at the same time securing its left by expelling the French from Willems. Lannoy was stormed by the British Guards under Sir R. Abercromby with such vigour that the cavalry which had been sent round the village to cut off the French retreat had no time to get into position. Beyond Lannoy, the French resistance, still disjointed, became more obstinate as

the ground favoured it more, and the duke called up the Austrians from Willems to turn the right of the French position at Roubaix by way of a small valley. Once again, however, the Guards dislodged the enemy before the turning movement had taken effect. A third French position now appeared, at Mouvaux, and this seemed so formidable that the duke halted to rest his now weary men. The emperor himself, however, ordered the advance to be resumed, and Mouvaux too was carried by Abercromby. It was now nightfall, and the duke having attained his objective point prepared to hold it against a counter attack.

Kinsky meanwhile with the fourth column had made fens opposite Pont-à-Tressan, and had forced the passage of the Marque near Bouvines with his main body. But Bonnaud gave ground so slowly that up to 4 P.M. Kinsky had only progressed a few hundred paces from his crossing point. The fifth column, which was behind time on the 16th, did not arrive at Orchies till dawn on the 17th, and had to halt there for rest and food. Thence, moving across country in fighting formation, the archduke made his way to Pont-à-Marque. But he was unable to do more, before calling a halt, than deploy his troops on the other side of the stream.

So closed the first day's operations. The "annihilation plan" had already undergone a serious check. The archduke and Kinsky, instead of being ready for the second part of their task, had scarcely completed the first, and the same could be said of Clerfayt, while von dem Bussche had definitively failed. Only the duke of York and Otto had done their share in the centre, and they now stood at Tourcoing and Mouvaux isolated in the midst of the enemy's main body, with no hope of support from the other columns and no more than a chance of meeting Clerfayt. Coburg's entire force was, without deducting losses, no more than 53,000 for a front of 18 m., and only half of the enemy's available 80,000 men had as yet been engaged. Mack sent a staff officer, at 1 A.M., to implore the archduke to come up to Lannoy at once, but the young prince was asleep and his suite refused to wake him.

Matters did not, of course, present themselves in this light at Souham's headquarters, where the generals met in an informal council. The project of flinging Bonnaud's corps against the flank of the duke of York had not received even a beginning of execution, and the outposts, reinforced though they were from the main group, had everywhere been driven in. All the subordinate leaders, moreover (except Bonnaud), sent in the most despondent reports. "Councils of war never fight" is an old maxim, justified in ninety-nine cases in a hundred: But this council determined to do so, and with all possible vigour. The scheme was practically that which Coburg's first threat had produced and his first brusque advance had inhibited. Vandamme was to hold Clerfayt, the garrison of Lille and a few outlying corps to occupy the archduke and Kinsky, and in the centre Moreau and Bonnaud, with 40,000 effectives, were to attack the Tourcoing-Mouvaux position in front and flank at dawn with all possible energy.

The first shots were fired on the Lys, where, it will be remembered, Clerfayt's infantry had effected its crossing in the night. Vandamme, who was to defend the river, had ^{Battle of} in the evening assembled his troops (fatigued by a ^{Tourcoing} long march) near Menin instead of pushing on at once. Thus only one of his battalions had taken part in the defence of Werwick on the 17th, and the remainder were by this chance massed on the flank of Clerfayt's subsequent line of advance. Vandamme used his advantage well. He attacked, with perhaps 12,000 men against 21,000, the head and the middle of Clerfayt's columns as they moved on Lincelles. Clerfayt stopped at once, turned upon him and drove him towards Roncq and Menin. Still, fighting in succession, rallying and fighting again, Vandamme's regiments managed to spin out time and to commit Clerfayt deeper and deeper to a false direction till it was too late in the day to influence the battle elsewhere.

V von dem Bussche's column at Dottignies, shaken by the blow it had received the day before, did nothing and actually retreated to the Scheidt. On the other flank, Kinsky and the archduke

Charles practically remained inactive despite repeated orders to proceed to Lannoy, Kinsky waiting for the archduke, and the latter using up his time and forces in elaborating a protective cordon all around his left and rear. Both alleged that "the troops were tired," but there was a stronger motive. It was felt that Belgium was about to be handed over to France as the price of peace, and the generals did not see the force of wasting soldiers on a lost cause. There remained the two centre columns, Otto's and the duke of York's. The orders of the emperor to the duke were that he should advance, to establish communication with Clerfayt at Lincelles. Having thus cut off the French Courtrai group, he was to initiate a general advance to crush it, in which all the allied columns would take part, Clerfayt, York and Otto in front, von dem Bussche on the right flank and the archduke and Kinsky in support. These airy schemes were destroyed at dawn on the 18th. Macdonald's brigade carried Tourcoing at the first rush, though Otto's guns and the volleys of the infantry checked its further progress. Malbrancq's brigade swarmed around the duke of York's entrenchments at Mouvaux, while Bonnaud's mass from the side of Lille passed the Marque and lapped round the flanks of the British posts at Roubaix and Lannoy. The duke had used up his reserves in assisting Otto, and by 8 A.M. the positions of Roubaix, Lannoy and Mouvaux were isolated from each other. But the Allies fought magnificently, and by now the Republicans were in confusion, excited to the highest pitch and therefore extremely sensitive to waves of enthusiasm or panic; and at this moment Clerfayt was nearing success, and Vandamme fighting almost back to back with Malbrancq. Otto was able to retire gradually, though with heavy losses, to Leers, before Macdonald's left column was able to storm Watrelos, or Daendels' brigade, still farther towards the Scheldt, could reach his rear. The resistance of the Austrians gave breathing space to the English, who held on to their positions till about 11.30, attacked again and again by Bonnaud, and then, not without confusion, retired to join Otto at Leers.

With the retreat of the two sorely tried columns and the suspension of Clerfayt's attack between Lincelles and Roncq, the battle of Tourcoing ended. It was a victory of which the young French generals had reason to be proud. The main attack was vigorously conducted, and the two-to-one numerical superiority which the French possessed at the decisive point is the best testimony at once to Souham's generalship and to Vandamme's bravery. As for the Allies, those of them who took part in the battle at all, generals and soldiers, covered themselves with glory, but the inaction of two-thirds of Coburg's army was the bankruptcy declaration of the old strategical system. The Allies lost, on this day, about 4000 killed and wounded and 1500 prisoners besides 60 guns. The French loss, which was probably heavier, is not known. The duke of York defeated, Souham at once turned his attention to Clerfayt, against whom he directed all the forces he could gather after a day's "horde-tactics." The Austrian commander, however, withdrew over the river unharmed. On the 19th he was at Rousseleur and Ingelminster, 9 or 10 m. north of Courtrai, while Coburg's forces assembled and encamped in a strong position some 3 m. west and north-west of Tournai, the Hanoverians remaining out in advance of the right on the Espierre.

Souham's victory, thanks to his geographical position, had merely given him air. The Allies, except for the loss of some 5500 men, were in no way worse off. The plan had failed, but the army as a whole had not been defeated, while the troops of the duke of York and Otto were far too well disciplined not to take their defeat as "all in the day's work." Souham was still on the Lys and midway between the two allied masses, able to strike each in turn or liable to be crushed between them in proportion as the opposing generals calculated time, space and endurance accurately. Souham, therefore, as early as the 19th, had decided that until Clerfayt had been pushed back to his old positions near Thielt he could not deal with the main body of the Allies on the side of Tournai, and he had left Bonnaud to hold the latter while he concentrated most of his forces

towards Courtrai. This move had the desired effect, for Clerfayt retired without a contest, and on the 21st of May Souham issued his orders for an advance on Coburg's army, which, as he knew, had meantime been reinforced. Vandamme alone was left to face Clerfayt, and this time with outposts far out, at Ingelminster and Roosebeke, so as to ensure his chief, not a few hours', but two or three days' freedom from interference.

Pichegru now returned and took up the supreme command, Souham remaining in charge of his own and Moreau's divisions. On the extreme right, from Pont-à-Tressin, only demonstrations were to be made; the centre, between Baisieux and Estaimbourg, was to be the scene of the holding attack of Bonnaud's command, while Souham, in considerably greater density, delivered the decisive attack on the allied right by St Leger and Warcoing. At Helchin a brigade was to guard the outer flank of the assailants against a movement by the Hanoverians and to keep open communication with Courtrai in case of attack from the direction of Oudenarde. The details of the allied position were insufficiently known owing to the multiplicity of their advanced posts and the intricate and densely cultivated nature of the ground. The battle of Tournai opened in the early morning of the 22nd and was long and desperately contested. The demonstration on the French extreme right was soon recognized by the defenders to be negligible, and the allied left wing thereupon closed on the centre. There Bonnaud attacked with vigour, forcing back the various advanced posts, especially on the left, where he dislodged the Allies from Nechin. The defenders of Templeuve then fell back, and the attacking swarms—a dissolved line of battle—fringed the brook beyond Templeuve, on the other side of which was the Allies' main position, and even for a moment seized Blandain. Meanwhile the French at Nechin, in concert with the main attack, pressed on towards Ramegnies.

Macdonald's and other brigades had forced the Espierre rivulet and driven von dem Bussche's Hanoverians partly over the Scheldt (they had a pontoon bridge), partly southward. The main front of the Allies was defined by the brook that flows between Templeuve and Blandain, then between Ramegnies and Pont-à-Chin and empties into the Scheldt near the last-named hamlet. On this front till close on nightfall a fierce battle raged. Pichegru's main attack was still by his left, and Pont-à-Chin was taken and retaken by French, Austrians, British and Hanoverians in turn. Between Blandain and Pont-à-Chin Bonnaud's troops more than once entered the line of defence. But the attack was definitively broken off at nightfall and the Republicans withdrew slowly towards Lannoy and Leers. They had for the first time in a fiercely contested "soldier's battle" measured their strength, regiment for regiment, against the Allies, and failed, but by so narrow a margin that henceforward the Army of the North realized its own strength and solidity. The Army of the Revolution, already superior in numbers and imbued with the decision-compelling spirit, had at last achieved self-confidence.

But the actual decision was destined by a curious process of evolution to be given by Jourdan's far-distant Army of the Moselle, to which we now turn.

The Army of the Moselle had been ordered to assemble a striking force on its left wing, without prejudicing the rest of its cordon in Lorraine, and with this striking force to operate towards Liège and Namur. Its first movement on Arlon, in April, was repulsed by a small Austrian corps under Beauieu that guarded this region. But in the beginning of May the advance was resumed though the troops were ill-equipped and ill-fed, and requisitions had reduced the civil population to semi-starvation and sullen hostility. We quote Jourdan's instructions to his advanced guard, not merely as evidence of the trivial purpose of the march as originally planned, but still more as an illustration of the driving power that made the troops march at all, and of the new method of marching and subsisting them.

Its commander was "to keep in mind the purpose of cutting the communications between Luxemburg and Namur, and was therefore to throw out strong bodies against the enemy daily and at different points, to parry the enemy's movements by rapid

marches, to prevent any transfer of troops to Belgium, and lastly to seek an occasion for giving battle, for cutting off his convoys and for seizing his magazines." So much for the

*Jourdan's
movement
on Liège.*

purpose. The method of achieving it is defined as follows. "General Hatry, in order to attain the object of these instructions, will have with him the minimum of weapons. He is to live at the expense of the enemy as much as possible, and to send back into the interior of the Republic whatever may be useful to it; he will maintain his communications with Longwy, report every movement to me, and when necessary to the Committee of Public Safety and to the minister of war, maintain order and discipline, and firmly oppose every sort of pillage." How the last of these instructions was to be reconciled with the rest, Hatry was not informed. In fact, it was ignored. "I am far from believing," wrote the representative on mission Gillet, "that we ought to adopt the principles of philanthropy with which we began the war."

At the moment when, on these terms, Jourdan's advance was resumed, the general situation east of the Scheldt was as follows: The Allies' centre under Coburg had captured Landrecies, and now (May 4) lay around that place, about 65,000 strong, while the left under Kaunitz (27,000) was somewhat north of Maubeuge, with detachments south of the Sambre as far as the Meuse. Beyond these again were the detachment of Beaulieu (8,000) near Arlon, and another, 9,000 strong, around Trier. On the side of the French, the Army of the Moselle (41,000 effectives) was in cordon between Saargemünd and Longwy, the Army of the Ardennes (22,000) between Beaumont and Givet; of the Army of the North, the right wing (38,000) in the area Beaumont—Maubeuge and the centre (24,000) about Guise. In the aggregate the allied field armies numbered 139,000 men, those of the French 203,000. Tactically the disproportion was sufficient to give the latter the victory, if, strategically, it could be made effective at a given time and place. But the French had mobility as a remedy for over-extension, and though their close massing on the extreme flanks left no more than equal forces opposite Coburg in the centre, the latter felt unable either to go forward or to close to one flank when on his right the storm was brewing at Menin and Tournai, and on his left Kaunitz reported the gathering of important masses of the French around Beaumont.

Thus the initiative passed over to the French, but they missed their opportunity, as Coburg had missed his in 1793. Pichegru's right was ordered to march on Mons, and his left to master the navigation of the Scheldt so as to reduce the Allies to wagon-drawn supplies—the latter an objective dear to the 18th-century general; while Jourdan's task, as we know, was to conquer the Liège or Namur country without unduly stripping the cordon on the Saar and the Moselle. Jourdan's orders and original purpose were to get Beaulieu out of his way by the usual strategical tricks, and to march through the Ardennes as rapidly as possible, living on what supplies he could pick up from the enemy or the inhabitants. But he had scarcely started when Beaulieu made his existence felt by attacking a French post at Bouillon. Thereupon Jourdan made the active enemy, instead of Namur, his first object.

The movement of the operative portion of the Army of the Moselle began on the 21st of May from Longwy through Arlon towards Neufchâteau. Irregular fighting, sometimes with the Austrians, sometimes with the bitterly hostile inhabitants, marked its progress. Beaulieu was nowhere forced into a battle. But fortune was on Jourdan's side. The Austrians were a detachment of Coburg's army, not an independent force, and when threatened they retired towards Ciney, drawing Jourdan after them in the very direction in which he desired to go. On the 28th the French, after a vain detour made in the hope of forcing Beaulieu to fight—"les esclaves n'osent pas se mesurer avec des hommes libres," wrote Jourdan in disgust,—reached Ciney, and there heard that the enemy had fallen back to a strongly entrenched position on the east bank of the Meuse near Namur. Jourdan was preparing to attack them there, when considerations of quite another kind intervened to change his direction, and thereby to produce the drama of Charleroi and Fleurus—which

military historians have asserted to be the foreseen result of the initial plan.

The method of "living on the country" had failed lamentably in the Ardennes, and Jourdan, though he had spoken of changing his line of supply from Arlon to Carignan, then to Mézières and so on as his march progressed, was still actually living from hand to mouth on the convoys that arrived intermittently from his original base. When he sought to take what he needed from the towns on the Meuse, he infringed on the preserves of the Army of the Ardennes.¹ The advance, therefore, came for the moment to a standstill, while Beaulieu, solicitous for the safety of Charleroi—in which fortress he had a magazine—called up the outlying troops left behind on the Moselle to rejoin him by way of Bastogne. At the same moment (29th) Jourdan received new orders from Paris—(a) to take Dinant and Charleroi and to clear the country between the Meuse and the Sambre, and (b) to attack Namur, either by assault or by regular siege. In the latter case the bulk of the forces were to form a covering army beyond the place, to demonstrate towards Nivelles, Louvain and Liège, and to serve at need as a support to the right flank of the Ardennes Army. From these orders and from the action of the enemy the campaign at last took a definite shape.

When the Army of the Moselle passed over to the left bank of the Meuse, it was greeted by the distant roar of guns towards Charleroi and by news that the Army of the Ardennes, which had already twice been defeated by Kaunitz, *Charleroi.* was for the third time deeply and unsuccessfully engaged beyond the Sambre. The resumption of the march again complicated the supply question, and it was only slowly that the army advanced towards Charleroi, sweeping the country before it and extending its right towards Namur. But at last on the 3rd of June the concentration of parts of three armies on the Sambre was effected. Jourdan took command of the united force (Army of the Sambre and Meuse) with a strong hand, the 40,000 newcomers inspired fresh courage in the beaten Ardennes troops, and in the sudden dominating enthusiasm of the moment pillaging and straggling almost ceased. Troops that had secured bread shared it with less fortunate comrades, and even the Liégeois peasantry made free gifts of supplies. "We must believe," says the French general staff of to-day, "that the idea symbolized by the Tricolour, around which marched ever these sansculottes, shoeless and hungry, unchained a mysterious force that preceded our columns and aided the achievement of military success."

Friction, however, arose between Jourdan and the generals of the Ardennes Army, to whom the representatives thought it well to give a separate mission. This detachment of 18,000 men was followed by another, of 16,000, to keep touch with Maubeuge. Deducting another 6,000 for the siege of Charleroi, when this should be made, the covering army destined to fight the Imperialists dwindled to 55,000 out of 96,000 effectives. Even now, we see, the objective was not primarily the enemy's army. The Republican leaders desired to strike out beyond the Sambre, and as a preliminary to capture Charleroi. They would not, however, risk the loss of their connexion with Maubeuge before attaining the new foothold.

Meanwhile, Tourcoing and Tournai had at last convinced Coburg that Pichegru was his most threatening opponent, and he had therefore, though with many misgivings, decided to move towards his right, leaving the prince of Orange with not more than 45,000 men on the side of Maubeuge-Charleroi-Namur.

Jourdan crossed the Sambre on the 12th of June, practically unopposed. Charleroi was rapidly invested and the covering army extended in a semicircular position. For the fourth time the Allies counter-attacked successfully, and after a severe struggle the French had to abandon their positions and their siege works and to recross the Sambre (June 16). But the army was not beaten. On the contrary, it was only desirous of having its revenge for a stroke of ill-fortune, due, the soldiers said, to

¹ Each of the fifteen armies on foot had been allotted certain departments as supply areas, Jourdan's being of course far away in Lorraine.

the fog and to the want of ammunition. The fierce threats of St Just (who had joined the army) to *faire tomber les têtes* if more energy were not shown were unnecessary, and within two days the army was advancing again. On the 18th Jourdan's columns recrossed the river and extended around Charleroi in the same positions as before. This time, having in view the weariness of his troops and their heavy losses on the 16th, the prince of Orange allowed the siege to proceed. His reasons for so doing furnish an excellent illustration of the different ideas and capacities of a professional army and a "nation in arms." "The Imperial troops," wrote General Alvinzi, "are very fatigued. We have fought nine times since the 10th of May, we have bivouacked constantly, and made forced marches. Further, we are short of officers." All this, it need hardly be pointed out, applied equally to the French.

Charleroi, garrisoned by less than 3000 men, was intimidated into surrender (25th) when the third parallel was barely established. Thus the object of the first operations was achieved. As to the next neither Jourdan nor the representatives seem to have had anything further in view than the capture of more fortresses. But within twenty-four hours events had decided for them.

Coburg had quickly abandoned his intention of closing on his right wing, and (after the usual difficulties with his Allies on that side) had withdrawn 12,000 Austrians from the centre of his cordon opposite Pichegru, and made forced marches to join the prince of Orange. On the 24th of June he had collected 52,000 men at various points round Charleroi, and on the 25th he set out to relieve the little fortress. But he was in complete ignorance of the state of affairs at Charleroi. Signal guns were fired, but the woods drowned even the roar of the siege batteries, and at last a party under Lieutenant Radetzky made its way through the covering army and discovered that the place had fallen. The party was destroyed on its return, but Radetzky was reserved for greater things. He managed, though twice wounded, to rejoin Coburg with his bad news in the midst of the battle of Fleurus.

On the 26th Jourdan's army (now some 73,000 strong) was still posted in a semicircle of entrenched posts, 20 m. in extent, round the captured town, pending the removal of the now unnecessary pontoon bridge at Marchiennes and the selection of a shorter line of defence.

Coburg was still more widely extended. Inferior in numbers as he was, he proposed to attack on an equal front, and thus gave himself, for the attack of an entrenched position, an order of battle of three men to every two yards of front, all reserves included. The Allies were to attack in five columns, the prince of Orange from the west and north-west towards Trazeignes and Monceau wood, Quasdanovich from the north on Gosselies, Kaunitz from the north-east, the archduke Charles from the east through Fleurus, and finally Beaulieu towards Lambusart. The scheme was worked out in such minute detail and with so entire a disregard of the chance of unforeseen incidents, that once he had given the executive command to move, the Austrian general could do no more. If every detail worked out as planned, victory would be his; if accidents happened he could do nothing to redress them, and unless these righted themselves (which was improbable in the case of the stiffly organized old armies) he could only send round the order to break off the action and retreat.

In these circumstances the battle of Fleurus is the sum rather than the product of the various fights that took place between each allied column and the French division that it met. The prince of Orange attacked at earliest dawn and gradually drove in the French left wing to Courcelles, Roux and Marchiennes, but somewhat after noon the French, under the direction for the most part of Kléber, began a series of counterstrokes which recovered the lost ground, and about 5, without waiting for Coburg's instructions, the prince retired north-westward off the battlefield. The French centre division, under Morlot, made a gradual fighting retreat on Gosselies, followed up by the Quasdanovich column and part of Kaunitz's force. No serious

impression was made on the defenders, chiefly because the brook west of Mellet was a serious obstacle to the rigid order of the Allies and had to be bridged before their guns could be got over. Kaunitz's column and Championnet's division met on the battlefield of 1690. The French were gradually driven in from the outlying villages to their main position between Heppignies and Wangeries. Here the Allies, well led and taking every advantage of ground and momentary chances, had the best of it. They pressed the French hard, necessitated the intervention of such small reserves as Jourdan had available, and only gave way to the defenders' counterstroke at the moment they received Coburg's orders for a general retreat.

On the allied left wing the fighting was closer and more severe than at any point. Beaulieu on the extreme left advanced upon Velaine and the French positions in the woods to the south in several small groups of all arms. Here were the divisions of the Army of the Ardennes, markedly inferior in discipline and endurance to the rest, and only too mindful of their four previous reverses. For six hours, more or less, they resisted the oncoming Allies, but then, in spite of the example and the despairing appeals of their young general Marceau, they broke and fled, leaving Beaulieu free to combine with the archduke Charles, who carried Fleurus after obstinate fighting, and then pressed on towards Campinaire. Beaulieu took command of all the allied forces on this side about noon, and from then to 5 p.m. launched a series of terrible attacks on the French (Lefebvre's division, part of the general reserve, and the remnant of Marceau's troops) above Campinaire and Lambusart. The disciplined resolution of the imperial battalions, and the enthusiasm of the French Revolutionaries, were each at their height. The Austrians came on time after time over ground that was practically destitute of cover. Villages, farms and fields of corn caught fire. The French grew more and more excited—"No retreat to-day!" they called out to their leaders, and finally, clamouring to be led against the enemy, they had their wish. Lefebvre seized the psychological moment when the fourth attack of the Allies had failed, and (though he did not know it) the order to retreat had come from Coburg. The losses of the unit that delivered it were small, for the charge exactly responded to the moral conditions of the moment, but the proportion of killed to wounded (55 to 81) is good evidence of the intensity of the momentary conflict.

So ended the battle. Coburg had by now learned definitely that Charleroi had surrendered, and while the issue of the battle was still doubtful—for though the prince of Orange was beaten, Beaulieu was in the full tide of success—he gave (towards 3 p.m.) the order for a general retreat. This was delivered to the various commanders between 4 and 5, and these, having their men in hand even in the heat of the engagement, were able to break off the battle without undue confusion. The French were far too exhausted to pursue them (they had lost twice as many men as the Allies), and their leader had practically no formed body at hand to follow up the victory, thanks to the extraordinary dissemination of the army.

Tourcoing, Tournay and Fleurus represent the maximum result achievable under the earlier Revolutionary system of making war, and show the men and the leaders at the highest point of combined steadiness and enthusiasm they ever reached—that is, as a "Sanculotte" army. Fleurus was also the last great victory of the French, in point of time, prior to the advent of Napoleon, and may therefore be considered as illustrating the general conditions of warfare at one of the most important points in its development.

The sequel of these battles can be told in a few words. The Austrian government had, it is said, long ago decided to evacuate the Netherlands, and Coburg retired over the Meuse, practically unpursued, while the duke of York's forces fell back in good order, though pursued by Pichegru through Flanders. The English contingent embarked for home, the rest retired through Holland into Hanoverian territory, leaving the Dutch troops to surrender to the victors. The last phase of the pursuit reflected great glory on Pichegru, for it was conducted in midwinter through a country bare of supplies and densely intersected with dykes and meres. The crowning incident was the dramatic capture of the Dutch fleet, frozen in at the Texel, by a handful of hussars who rode over the ice and browbeat the crews of the well-armed battleships into surrender. It was many years before a prince of Orange ruled again in the United provinces, while the Austrian whitecoats never again mounted guard in Brussels.

The Rhine campaign of 1794, waged as before chiefly by the Prussians, was not of great importance. General v. Mollendorf won a victory at Kaiserslautern on the 23rd of May, but operations thereafter became spasmodic, and were soon complicated by Coburg's retreat over the Meuse. With this event the offensive of the Allies against the French Revolution came to an inglorious end. Poland now occupied the thoughts of European statesmen, and Austria began to draw her forces on to the east. England stopped the payment of subsidies, and Prussia made the Peace of Basel on the 5th of April 1795. On the Spanish frontier the French under General Dugommier (who was killed in the last battle) were successful in almost every encounter, and Spain, too, made peace. Only the eternal enemies, France and Austria, were left face to face on the Rhine, and elsewhere, of all the Allies, Sardinia alone (see below under *Italian Campaigns*) continued the struggle in a half-hearted fashion.

The operations of 1795 on the Rhine present no feature of the Revolutionary Wars that other and more interesting campaigns fail to show. Austria had two armies on foot under the general command of Clerfayt, one on the upper Rhine, the other south of the Main, while Mainz was held by an army of imperial contingents. The French, Jourdan on the lower, Pichegru on the upper Rhine, had as usual superior numbers at their disposal. Jourdan combined a demonstrative frontal attack on Neuwied with an advance in force via Düsseldorf, reunited his wings beyond the river near Neuwied, and drove back the Austrians in a series of small engagements to the Main, while Pichegru passed at Mannheim and advanced towards the Neckar. But ere long both were beaten, Jourdan at Höchst and Pichegru at Mannheim, and the investment of Mainz had to be abandoned. This was followed by the invasion of the Palatinate by Clerfayt and the retreat of Jourdan to the Moselle. The position was further compromised by secret negotiations between Pichegru and the enemy for the restoration of the Bourbons. The meditated treason came to light early in the following year, and the guilty commander disappeared into the obscure ranks of the royalist secret agents till finally brought to justice in 1804.

THE CAMPAIGN OF 1796 IN GERMANY

The wonder of Europe now transferred itself from the drama of the French Revolution to the equally absorbing drama of a great war on the Rhine. "Every day, for four terrible years," wrote a German pamphleteer early in 1796, "has surpassed the one before it in grandeur and terror, and to-day surpasses all in dizzy sublimity." That a manœuvre on the Lahn should possess an interest to the peoples of Europe surpassing that of the Reign of Terror is indeed hardly imaginable, but there was a good reason for the tense expectancy that prevailed everywhere. France's policy was no longer defensive. She aimed at invading and "revolutionizing" the monarchies and principalities of old Europe, and to this end the campaign of 1796 was to be the great and conclusive effort. The "liberation of the oppressed" had its part in the decision, and the glory of freeing the serf easily merged itself in the glory of defeating the serf's masters. But a still more pressing motive for carrying the war into the enemy's country was the fact that France and the lands she had overrun could no longer sustain her armies. The Directory frankly told its generals, when they complained that their men were starving and ragged, that they would find plenty of subsistence beyond the Rhine.

On her part, Austria, no longer fettered by allied contingents nor by the expenses of a far distant campaign, could put forth more strength than on former campaigns, and as war came nearer home and the citizen saw himself threatened by "revolutionizing" and devastating armies, he ceased to hamper or to swindle the troops. Thus the duel took place on the grandest scale then known in the history of European armies. Apart from the secondary theatre of Italy, the area embraced in the struggle was a vast triangle extending from Düsseldorf to Basel and thence to Ratisbon, and Carnot sketched the outlines in accordance with the scale of the picture. He imagined nothing less than the union of the armies of the Rhine and the Riviera before the walls of Vienna. Its practicability cannot here be discussed, but it is worth contrasting the attitude of contemporaries and of later strategical theorists towards it. The former, with their empirical knowledge of war, merely thought it impracticable with the available means, but the latter have condemned it root and branch as "an operation on exterior lines."

The scheme took shape only gradually. The first advance was made partly in search of food, partly to disengage the

Palatinate, which Clerfayt had conquered in 1795. "If you have reason to believe that you would find some supplies on the Lahn, hasten thither with the greater part of your forces," wrote the Directory to Jourdan (Army of the Sambre-and-Meuse, 72,000) on the 20th of March. He was to move at once, before the Austrians could concentrate, and to pass the Rhine at Düsseldorf, thereby bringing back the centre of the enemy over the river. He was, further, to take every advantage of their want of concentration to deliver blow after blow, and to do his utmost to break them up completely. A fortnight later Moreau (Army of the Rhine-and-Moselle, 78,000) was ordered to take advantage of Jourdan's move, which would draw most of the Austrian forces to the Mainz region, to enter the Breisgau and Suabia. "You will attack Austria at home, and capture her magazines. You will enter a new country, the resources of which, properly handled, should suffice for the needs of the Army of the Rhine-and-Moselle."

Jourdan
and
Moreau.

Jourdan, therefore, was to take upon himself the destruction of the enemy, Moreau the invasion of South Germany. The first object of both was to subsist their armies beyond the Rhine, the second to defeat the armies and terrorize the populations of the empire. Under these instructions the campaign opened. Jourdan crossed at Düsseldorf and reached the Lahn, but the enemy concentrated against him very swiftly and he had to retire over the river. Still, if he had not been able to "break them up completely," he had at any rate drawn on himself the weight of the Austrian army, and enabled Moreau to cross at Strassburg without much difficulty.

The Austrians were now commanded by the archduke Charles, who, after all detachments had been made, disposed of some 56,000 men. At first he employed the bulk of this force against Jourdan, but on hearing of Moreau's progress he returned to the Neckar country with 20,000 men, leaving Feldzeugmeister v. Wartensleben with 36,000 to observe Jourdan. In later years he admitted himself that his own force was far too small to deal with Moreau, who, he probably thought, would retire after a few manœuvres.

But by now the two French generals were aiming at something more than alternate raids and feints. Carnot had set before them the ideal of a decisive battle as the great object. Jourdan was instructed, if the archduke turned on Moreau, to follow him up with all speed and to bring him to action. Moreau, too, was not retreating but advancing. The two armies, Moreau's and the archduke's, met in a straggling and indecisive battle at Malsch on the 9th of July, and soon afterwards Charles learned that Jourdan had recrossed the Rhine and was driving Wartensleben before him. He thereupon retired both armies from the Rhine valley into the interior, hoping that at least the French would detach large forces to besiege the river fortresses. Disappointed of this, and compelled to face a very grave situation, he resorted to an expedient which may be described in his own words: "to retire both armies step by step without committing himself to a battle, and to seize the first opportunity to unite them so as to throw himself with superior or at least equal strength on one of the two hostile enemies." This is the ever-recurring idea of "interior lines." It was not new, for Frederick the Great had used similar means in similar circumstances, as had Souham at Tourcoing and even Dampierre at Valenciennes. Nor was it differentiated, as were Napoleon's operations in this same year, by the deliberate use of a small containing force at one point to obtain relative superiority at another. A general of the 18th century did not believe in the efficacy of superior numbers—had not Frederick the Great disproved it?—and for him operations on "interior lines" were simply successive blows at successive targets, the efficacy of the blow in each case being dependent chiefly on his own personal qualities and skill as a general on the field of battle. In the present case the point to be observed is not the expedient, which was dictated by the circumstances, but the courage of the young general, who, unlike Wartensleben and the rest of his generals, unlike, too, Moreau and

The
archduke's
plan.

Jourdan themselves, surmounted difficulties instead of lamenting them.

On the other side, Carnot, of course, foresaw this possibility. He warned the generals not to allow the enemy to "use his forces sometimes against one, sometimes against the other, as he did in the last campaign," and ordered them to go forward respectively into Franconia and into the country of the upper Neckar, with a view to seeking out and defeating the enemy's army. But the plan of operations soon grew bolder. Jourdan was informed on the 21st of July that if he reached the Regnitz without meeting the enemy, or if his arrival there forced the latter to retire rapidly to the Danube, he was not to hesitate to advance to Ratisbon and even to Passau if the disorganization of the enemy admitted it, but in these contingencies he was to detach a force into Bohemia to levy contributions. "We presume that the enemy is too weak to offer a successful resistance and will have united his forces on the Danube; we hope that our two armies will act in unison to rout him completely. Each is, in any case, strong enough to attack by itself, and nothing is so pernicious as slowness in war." Evidently the fear that the two Austrian armies would unite against one of their assailants had now given place to something like disdain.

This was due in all probability to the rapidity with which Moreau was driving the archduke before him. After a brief stand on the Neckar at Cannstadt, the Austrians, only 25,000 strong, fell back to the Rauhe Alb, where they halted again, to cover their magazines at Ulm and Günzburg, towards the end of July. Wartensleben was similarly falling back before Jourdan, though the latter, starting considerably later than Moreau, had not advanced so far. The details of the successive positions occupied by Wartensleben need not be stated; all that concerns the general development of the campaign is the fact that the hitherto independent leader of the "Lower Rhine Army" resented the loss of his freedom of action, and besides lamentations opposed a dull passive resistance to all but the most formal orders of the prince. Many weeks passed before this was overcome sufficiently for his leader even to arrange for the contemplated combination, and in these weeks the archduke was being driven back day by day, and the German principalities were falling away one by one as the French advanced and preached the revolutionary formula. In such circumstances as these—the general facts, if not the causes, were patent enough—it was natural that the confident Paris strategists should think chiefly of the profits of their enterprise and ignore the fears of the generals at the front. But the latter were justified in one important respect; their operating armies had seriously diminished in numbers, Jourdan disposing of not more than 45,000 and Moreau of about 50,000. The archduke had now, owing to the arrival of a few detachments from the Black Forest and elsewhere, about 34,000 men, Wartensleben almost exactly the same, and the former, for some reason which has never been fully explained but has its justification in psychological factors, suddenly turned

Neresheim. and fought a long, severe and straggling battle above Neresheim (August 11). This did not, however, give him much respite, and on the 12th and 13th he retired over the Danube. At this date Wartensleben was about Amberg, almost as far away from the other army as he had been on the Rhine, owing to the necessity of retreating round instead of through the principality of Bayreuth, which was a Prussian possession and could therefore make its neutrality respected.

Hitherto Charles had intended to unite his armies on the Danube against Moreau. His later choice of Jourdan's army as the objective of his combination grew out of circumstances and in particular out of the brilliant reconnaissance work of a cavalry brigadier of the Lower Rhine Army, Nauendorff. This general's reports—he was working in the country south and south-east of Nürnberg, Wartensleben being at Amberg—indicated first an advance of Jourdan's army from Forchheim through Nürnberg to the south, and induced the archduke, on the 12th, to begin a concentration of his own army towards Ingolstadt. This was a purely defensive measure, but Nauendorff reported on the 13th and 14th that the main columns of the French were swinging

away to the east against Wartensleben's front and inner flank, and on the 14th he boldly suggested the idea that decided the campaign. "If your Royal Highness will or can advance 12,000 men against Jourdan's rear, he is lost. We could not have a better opportunity." When this message arrived at headquarters the archduke had already issued orders to the same effect. Lieutenant Field Marshal Count Latour, with 30,000 men, was to keep Moreau occupied—another expedient of the moment, due to the very close pressure of Moreau's advance, and the failure of the attempt to put him out of action at Neresheim. The small remainder of the army, with a few detachments gathered *en route*, in all about 27,000 men, began to recross the Danube on the 14th, and slowly advanced north on a broad front, its leader being now sure that at some point on his line he would encounter the French, whether they were heading for Ratisbon or Amberg. Meanwhile, the Directory had, still acting on the theory of the archduke's weakness, ordered Moreau to combine the operations with those of Bonaparte in Italian Tirol, and Jourdan to turn both flanks of his immediate opponent, and thus to prevent his joining the archduke, as well as his retreat into Bohemia. And curiously enough it was this latter, and not Moreau's move, which suggested to the archduke that his chance had come. The chance was, in fact, one dear to the 18th century general, catching his opponent in the act of executing a manoeuvre. So far from "exterior lines" being fatal to Jourdan, it was not until the French general began to operate against Wartensleben's *inner* flank that the archduke's opportunity came.

The decisive events of the campaign can be described very briefly, the ideas that directed them having been made clear. The long thin line of the archduke wrapped itself round Jourdan's right flank near Amberg, while Wartensleben *Amberg and Würzburg.* fought him in front. The battle (August 24) was a series of engagements between the various columns that met; it was a repetition in fact of Fleurus, without the intensity of fighting spirit that redeems that battle from dulness. Success followed, not upon bravery or even tactics, but upon the pre-existing strategical conditions. At the end of the day the French retired, and next morning the archduke began another wide extension to his left, hoping to head them off. This consumed several days. In the course of it Jourdan attempted to take advantage of his opponent's dissemination to regain the direct road to Würzburg, but the attempt was defeated by an almost fortuitous combination of forces at the threatened point. More effective, indeed, than this indirect pursuit was the very active hostility of the peasantry, who had suffered in Jourdan's advance and retaliated so effectually during his retreat that the army became thoroughly demoralized, both by want of food and by the strain of incessant sniping. Defeated again at Würzburg on the 3rd of September, Jourdan continued his retreat to the Lahn, and finally withdrew the shattered army over the Rhine, partly by Düsseldorf, partly by Neuwied. In the last engagement on the Lahn the young and brilliant Marceau was mortally wounded. Far away in Bavaria, Moreau had meantime been driving Latour from one line of resistance to another. On receiving the news of Jourdan's reverses, however, he made a rapid and successful retreat to Strassburg, evading the prince's army, which had ascended the Rhine valley to head him off, in the nick of time.

This celebrated campaign is pre-eminently strategical in its character, in that the positions and movements anterior to the battle preordained its issue. It raised the reputation of the archduke Charles to the highest point, and deservedly, for he wrested victory from the most desperate circumstances by the skillful and resolute employment of his one advantage. But this was only possible because Moreau and Jourdan were content to accept strategical failure without seeking to redress the balance by hard fighting. The great question of this campaign is, why did Moreau and Jourdan fail against inferior numbers, when in Italy Bonaparte with a similar army against a similar opponent won victory after victory against equal and superior forces? The answer will not be supplied by any theory of "exterior and

interior lines." It lies far deeper. So far as it is possible to summarize it in one phrase, it lies in the fact that though the Directory meant this campaign to be the final word on the Revolutionary War, for the nation at large this final word had been said at Fleurus. The troops were still the nation; they no longer fought for a cause and for bare existence, and Moreau and Jourdan were too closely allied in ideas and sympathies with the misplaced citizen soldiers they commanded to be able to dominate their collective will. In default of a cause, however, soldiers will fight for a man, and this brings us by a natural sequence of ideas to the war in Italy.

THE WAR IN ITALY 1793-97

Hitherto we have ignored the operations on the Italian frontier, partly because they were of minor importance and partly because the conditions out of which Napoleon's first campaign arose can be best considered in connexion with that campaign itself, from which indeed the previous operations derive such light as they possess. It has been mentioned that in 1792 the French overran Savoy and Nice. In 1793 the Sardinian army and a small auxiliary corps of Austrians waged a desultory mountain warfare against the Army of the Alps about Briançon and the Army of Italy on the Var. That furious offensive on the part of the French, which signalized the year 1793 elsewhere, was made impossible here by the counter-revolution in the cities of the Midi.

In 1794, when this had been crushed, the intention of the French government was to take the offensive against the Austro-Sardinians. The first operation was to be the capture of Oneglia. The concentration of large forces in the lower Rhone valley had naturally infringed upon the areas told off for the provisioning of the Armies of the Alps (Kellermann) and of Italy (Dumerbion); indeed, the sullen population could hardly be induced to feed the troops suppressing the revolt, still less the distant frontier armies. Thus the only source of supply was the Riviera of Genoa: "Our connexion with this district is imperilled by the corsairs of Oneglia (a Sardinian town) owing to the cessation of our operations afloat. The army is living from hand to mouth," wrote the younger Robespierre in September 1793. Vessels bearing supplies from Genoa could not avoid the corsairs by taking the open sea, for there the British fleet was supreme. Carnot therefore ordered the Army of Italy to capture Oneglia, and 21,000 men (the rest of the 67,000 effectives were held back for coast defence) began operations in April. The French left moved against the enemy's positions on the main road over the Col di Tenda, the centre towards Ponte di Nava, and the right along the Riviera. All met with success, thanks to *Scargio*.

Masséna's bold handling of the centre column. Not only was Oneglia captured, but also the Col di Tenda. Napoleon Bonaparte served in these affairs on the headquarter staff. Meantime the Army of the Alps had possessed itself of the Little St Bernard and Mont Cenis, and the Republicans were now masters of several routes into Piedmont (May). But the Alpine roads merely led to fortresses, and both Carnot and Bonaparte—Napoleon had by now captivated the younger Robespierre and become the leading spirit in Dumerbion's army—considered that the Army of the Alps should be weakened to the profit of the Army of Italy, and that the time had come to disregard the feeble neutrality of Genoa, and to advance over the Col di Tenda.

Napoleon's first suggestion for a rapid condensation of the French cordon, and an irresistible blow on the centre of the Allies by Tenda-Coni,¹ came to nothing owing to the waste of time in negotiations between the generals and the distant Committee, and meanwhile new factors came into play. The capture of the pass of Argentera by the right wing of the Army of the Alps suggested that the main effort should be made against the barrier fortress of Demonte, but here again Napoleon proposed a concentration of effort on the primary and economy of force in the secondary objective. About the same time, in a memoir on the war in general, he laid down his most

¹ Liguria was not at this period thought of, even by Napoleon, as anything more than a supply area.

celebrated maxim: "The principles of war are the same as those of a siege. Fire must be concentrated on one point, and as soon as the breach is made, the equilibrium is broken and the rest is nothing." In the domain of tactics he was and remains the principal exponent of the art of breaking the equilibrium, and already he imagined the solution of problems of policy and strategy on the same lines. "Austria is the great enemy; Austria crushed, Germany, Spain, Italy fall of themselves. We must not disperse, but concentrate our attack." Napoleon argued that Austria could be effectively wounded by an offensive against Piedmont, and even more effectively by an ulterior advance from Italian soil into Germany. In pursuance of the single aim he asked for the appointment of a single commander-in-chief to hold sway from Bayonne to the Lake of Geneva, and for the rejection of all schemes for "revolutionizing" Italy till after the defeat of the arch-enemy.

Operations, however, did not after all take either of these forms. The younger Robespierre perished with his brother in the *coup d'état* of 9th Thermidor, the advance was suspended, and Bonaparte, amongst other leading spirits of the Army of Italy, was arrested and imprisoned. Profiting by this moment, Austria increased her auxiliary corps. An Austrian general took command of the whole of the allied forces, and pronounced a threat from the region of Cairo (where the Austrians took their place on the left wing of the combined army) towards the Riviera. The French, still dependent on Genoa for supplies, had to take the offensive at once to save themselves from starvation, and the result was the expedition of Dego, planned chiefly by Napoleon, who had been released from prison and was at headquarters, though unemployed. The movement began on the 17th of September; and although the Austrian general Colloredo repulsed an attack at Dego (Sept. 21) he retreated to Acqui, and the incipient offensive of the Allies ended abruptly.

The first months of the winter of 1794-1795 were spent in re-equipping the troops, who stood in sore need after their rapid movements in the mountains. For the future operations, the enforced condensation of the army on its right wing with the object of protecting its line of supply to Genoa and the dangers of its cramped situation on the Riviera suggested a plan roughly resembling one already recommended by Napoleon, who had since the affair of Dego become convinced that the way into Italy was through the Apennines and not the Alps. The essence of this was to anticipate the enemy by a very early and rapid advance from Vado towards Carcare by the Ceva road, the only good road of which the French disposed and which they significantly called the *chemin de canon*.

The plan, however, came to nothing; the Committee, which now changed its personnel at fixed intervals, was in consequence wavering and non-committal, troops were withdrawn for a projected invasion of Corsica, and in November 1794 Dumerbion was replaced by Schérer, who assembled only 17,000 of his 54,000 effectives for field operations, and selected as his line of advance the Col di Tenda-Coni road. Schérer, besides being hostile to any suggestion emanating from Napoleon, was impressed with the apparent danger to his right wing concentrated in the narrow Riviera, which it was at this stage impossible to avert by a sudden and early assumption of the offensive. After a brief tenure Schérer was transferred to the Spanish frontier, but Kellermann, who now received command of the Army of Italy in addition to his own, took the same view as his predecessor—the view of the ordinary general. But not even the Schérer plan was put into execution, for spring had scarcely arrived when the prospect of renewed revolts in the south of France practically paralysed the army.

This encouraged the enemy to deliver the blow that had so long been feared. The combined forces, under Devins,—the Sardinians, the Austrian auxiliary corps and the newly arrived Austrian main army,—advanced together and forced the French right wing to evacuate Vado and the Genoese littoral. But at this juncture the conclusion of peace with Spain released the Pyrenees armies, and Schérer returned to the Army of Italy at the head of reinforcements. He was faced with a difficult situation,

but he had the means wherewith to meet it, as Napoleon promptly pointed out. Up to this, Napoleon said, the French commanded the mountain crest, and therefore covered Savoy and Nice, and also Oneglia, Loano and Vado, the ports of the Riviera. But now that Vado was lost the breach was made. Genoa was cut off, and the south of France was the only remaining resource for the army commissariat. Vado must therefore be retaken and the line reopened to Genoa, and to do this it was essential first to close up the over-extended cordon—and with the greatest rapidity, lest the enemy, with the shorter line to move on, should gather at the point of contact before the French—and to advance on Vado. Further, knowing (as every one knew) that the king of Sardinia was not inclined to continue the struggle indefinitely, he predicted that this ruler would make peace once the French army had established itself in his dominions, and for this the way into the interior, he asserted, was the great road Savona-Ceva. But Napoleon's mind ranged beyond the immediate future. He calculated that once the French advanced the Austrians would seek to cover Lombardy, the Piedmontese Turin, and this separation, already morally accomplished, it was to be the French general's task to accentuate in fact. Next, Sardinia having been coerced into peace, the Army of Italy would expel the Austrians from Lombardy, and connect its operations with those of the French in South Germany by way of Tirol. The supply question, once the soldiers had gained the rich valley of the Po, would solve itself.

This was the essence of the first of four memoranda on this subject prepared by Napoleon in his Paris office. The second indicated the means of coercing Sardinia—first the

Loano. Austrians were to be driven or scared away towards Alessandria, then the French army would turn sharp to the left, driving the Sardinians eastward and north-eastward through Ceva, and this was to be the signal for the general invasion of Piedmont from all sides. In the third paper he framed an elaborate plan for the retaking of Vado, and in the fourth he summarized the contents of the other three. Having thus cleared his own mind as to the conditions and the solution of the problem, he did his best to secure the command for himself.

The measures recommended by Napoleon were translated into a formal and detailed order to recapture Vado. To Napoleon the miserable condition of the Army of Italy was the most urgent incentive to prompt action. In Schérer's judgment, however, the army was unfit to take the field, and therefore *ex hypothesi* to attack Vado, without thorough reorganization, and it was only in November that the advance was finally made. It culminated, thanks once more to the resolute Masséna, in the victory of Loano (November 23-24). But Schérer thought more of the destitution of his own army than of the fruits of success, and contented himself with resuming possession of the Riviera.

Meanwhile the Mentor whose suggestions and personality were equally repugnant to Schérer had undergone strange vicissitudes of fortune—dismissal from the headquarters' staff, expulsion from the list of general officers, and then the "whiff of grapeshot" of 13th Vendémiaire, followed shortly by his marriage with Josephine, and his nomination to command the Army of Italy. These events had neither shaken his cold resolution nor disturbed his balance.

The Army of Italy spent the winter of 1795-1796 as before in the narrow Riviera, while on the one side, just over the mountains, lay the Austro-Sardinians, and on the other, out of range of the coast batteries but ready to pounce on the supply ships, were the British frigates. On Bonaparte's left Kellermann, with no more than 18,000, maintained a string of posts between Lake Geneva and the Argentera as before. Of the Army of Italy, 7000 watched the Tenda road and 20,000 men the coast-line. There remained for active operations some 27,000 men, ragged, famished and suffering in every way in spite of their victory of Loano. The Sardinian and Austrian auxiliaries (Colli), 25,000 men, lay between Mondovì and Ceva, a force strung out in the Alpine valleys opposed Kellermann, and the main Austrian army (commanded by Beaulieu), in widely extended

cantonments between Acqui and Milan, numbered 27,000 field troops. Thus the short-lived concentration of all the allied forces for the battle against Schérer had ended in a fresh separation. Austria was far more concerned with Poland than with the moribund French question, and committed as few of her troops as possible to this distant and secondary theatre of war. As for Piedmont, "peace" was almost the universal cry, even within the army. All this scarcely affected the regimental spirit and discipline of the Austrian squadrons and battalions, which had now recovered from the defeat of Loano. But they were important factors for the new general-in-chief on the Riviera, and formed the basis of his strategy.

Napoleon's first task was far more difficult than the writing of memoranda. He had to grasp the reins and to prepare his troops, morally and physically, for active work. It was not merely that a young general with many enemies, a political favourite of the moment, had been thrust upon the army. The army itself was in a pitiable condition. Whole companies with their officers went plundering in search of mere food, the horses had never received as much as half-rations for a year past, and even the generals were half-starved. Thousands of men were barefooted and hundreds were without arms. But in a few days he had secured an almost incredible ascendancy over the sullen, starved, half-clothed army.

"Soldiers," he told them, "you are famished and nearly naked. The government owes you much, but can do nothing for you. Your patience, your courage, do you honour, but give you no glory, no advantage. I will lead you into the most fertile plains of the world. There you will find great towns, rich provinces. There you will find honour, glory and riches. Soldiers of Italy, will you be wanting in courage?"

Such words go far, and little as he was able to supply material deficiencies—all he could do was to expel rascally contractors, sell a captured privateer for £5000 and borrow £2500 from Genoa—he cheerfully told the Directory on the 28th of March that "the worst was over." He augmented his army of operations to about 40,000, at the expense of the coast divisions, and set on foot also two small cavalry divisions, mounted on the half-starved horses that had survived the winter. Then he announced that the army was ready and opened the campaign.

The first plan, emanating from Paris, was that, after an expedition towards Genoa to assist in raising a loan there, the army should march against Beaulieu, previously neutralizing the Sardinians by the occupation of Ceva. When Beaulieu was beaten it was thought probable that the Piedmontese would enter into an alliance with the French against their former comrades. A second plan, however, authorized the general to begin by subduing the Piedmontese to the extent necessary to bring about peace and alliance, and on this Napoleon acted. If the present separation of the Allies continued, he proposed to overwhelm the Sardinians first, before the Austrians could assemble from winter quarters, and then to turn on Beaulieu. If, on the other hand, the Austrians, before he could strike his blow, united with Colli, he proposed to frighten them into separating again by moving on Acqui and Alessandria. Hence Carcare, where the road from Acqui joined the "cannon-road," was the first objective of his march, and from there he could manœuvre and widen the breach between the allied armies. His scattered left wing would assist in the attack on the Sardinians as well as it could—for the immediate attack on the Austrians its co-operation would of course have been out of the question. In any case he grudged every week spent in administrative preparation. The delay due to this, as a matter of fact, allowed a new situation to develop. Beaulieu was himself the first to move, and he moved towards Genoa instead of towards his Allies. The gap between the two allied wings was thereby widened, but it was no longer possible for the French to use it, for their plan of destroying Colli while Beaulieu was ineffective had collapsed.

In connexion with the Genoese loan, and to facilitate the movement of supply convoys, a small French force had been pushed forward to Voltri. Bonaparte ordered it back as soon as he arrived at the front, but the alarm was given. The Austrians

broke up from winter quarters at once, and rather than lose the food supplies at Voltri, Bonaparte actually reinforced Masséna at that place, and gave him orders to hold on as long as possible, cautioning him only to watch his left rear (Montenotte). But he did not abandon his purpose. Starting from the new conditions, he devised other means, as we shall see, for reducing Beaulieu to ineffectiveness. Meanwhile Beaulieu's plan of offensive operations, such as they were, developed. The French advance to Voltri had not only spurred him into activity, but convinced him that the bulk of the French army lay east of Savona. He therefore made Voltri the objective of a converging attack, not with the intention of destroying the French army but with that of "cutting its communications with Genoa," and expelling it from "the only place in the Riviera where there were sufficient ovens to bake its bread." (Beaulieu to the Aulic Council, 15 April.) The Sardinians and auxiliary Austrians were ordered to extend leftwards on Dego to close the gap that Beaulieu's advance on Genoa-Voltri opened up, which they did, though only half-heartedly and in small force, for, unlike Beaulieu, they knew that masses of the enemy were still in the western stretch of the Riviera. The rightmost of Beaulieu's own columns was on the road between Acqui and Savona with orders to seize Monte Legino as an advanced post, the others were to converge towards Voltri from the Genoa side and the mountain passes about Campofreddo and Sassello. The wings were therefore so far connected that Colli wrote to Beaulieu on this day "the enemy will never dare to place himself between our two armies." The event belied the prediction, and the proposed minor operation against granaries and bakeries became the first act of a decisive campaign.

Opening movements.

On the night of the 9th of April the French were grouped as follows: brigades under Garnier and Macquard at the Finestre and Tenda passes, Sérurier's division and Rusca's brigade east of Gassio; Augereau's division about Loano, Meynier's at Finale, Laharpe's at Savona with an outpost on the Monte Legino, and Cervoni's brigade at Voltri. Masséna was in general charge of the last-named units. The cavalry was far in rear beyond Loano. Colli's army, excluding the troops in the valleys that led into Dauphiné, was around Coni and Mondovi-Ceva, the latter group connecting with Beaulieu by a detachment under Provera between Millesimo and Carcare. Of Beaulieu's army, Argenteau's division, still concentrating to the front in many small bodies, extended over the area Acqui-Dego-Sassello. Vukassovich's brigade was equally extended between Ovada and the mountain-crests above Voltri, and Pittoni's division was grouped around Gavi and the Bocchetta, the two last units being destined for the attack on Voltri. Farther to the rear was Sebottendorf's division around Alessandria-Tortona.

On the afternoon of the 10th Beaulieu delivered his blow at Voltri, not, as he anticipated, against three-quarters of the French army, but against Cervoni's detachment. This, after a long irregular fight, slipped away in the night to Savona. Discovering his mistake next morning, Beaulieu sent back some of his battalions to join Argenteau. But there was no road by which they could do so save the détour through Acqui and Dego, and long before they arrived Argenteau's advance on Monte Legino had forced on the crisis. On the 11th (a day behind time), this general drove in the French outposts, but he soon came on three battalions under Colonel Rampon, who threw himself into some old earthworks that lay near, and said to his men, "We must win or die here, my friends." His redoubt and his men stood the trial well, and when day broke on the 12th Bonaparte was ready to deliver his first "Napoleonic stroke."

The principle that guided him in the subsequent operations may be called "superior numbers at the decisive point." Touch had been gained with the enemy all along the long line between the Tenda and Voltri, and he decided to concentrate swiftly upon the nearest enemy—Argenteau. Augereau's division, or such part of it as could march at once,

Montenotte.

was ordered to Mallare, picking up here and there on the way a few horsemen and guns. Masséna, with 9000 men, was to send two brigades in the direction of Carcare and Altare, and with the third to swing round Argenteau's right and to head for Montenotte village in his rear. Laharpe with 7000 (it had become clear that the enemy at Voltri would not pursue their advantage) was to join Rampon, leaving only Cervoni and two battalions in Savona. Sérurier and Rusca were to keep the Sardinians in front of them occupied. The far-distant brigades of Garnier and Macquard stood fast, but the cavalry drew eastward as quickly as its condition permitted. In rain and mist on the early morning of the 13th the French marched on from all quarters, while Argenteau's men waited in their cold bivouacs for light enough to resume their attack on Monte Legino. About 9 the mists cleared, and heavy fighting began, but Laharpe held the mountain, and the vigorous Masséna with his nearest brigade stormed forward against Argenteau's right. A few hours later, seeing Augereau's columns heading for their line of retreat, the Austrians retired, sharply pressed, on Dego. The threatened intervention of Provera was checked by Augereau's presence at Carcare.

Montenotte was a brilliant victory, and one can imagine its effects on the but lately despondent soldiers of the Army of

Italy, for all imagined that Beaulieu's main body had been defeated. This was far from being the case, however, and although the French spent the night of the battle at Cairo-Carcare-Montenotte, midway between the allied wings, only two-thirds of Argenteau's force, and none of the other divisions, had been beaten, and the heaviest fighting was to come. This became evident on the afternoon of the 13th, but meanwhile Bonaparte, eager to begin at once the subjugation of the Piedmontese (for which purpose he wanted to bring Sérurier and Rusca into play) sent only Laharpe's division and a few details of Masséna's, under the latter, towards Dego. These were to protect the main attack from interference by the forces that had been engaged at Montenotte (presumed to be Beaulieu's main body), the said main attack being delivered by



Argenteau's division, reinforced by most of Masséna's, on the positions held by Provera. The latter only 1000 strong to Augereau's 9000, shut himself in the castle of Cossaria, which he defended *à la Rampon* against a series of furious assaults. Not until the morning of the 14th was his surrender secured, after his ammunition and food had been exhausted.

Argenteau also won a day's respite on the 13th, for Laharpe did not join Masséna till late, and nothing took place opposite Dego but a little skirmishing. During the day Bonaparte saw

for himself that he had overrated the effects of Montenotte. Beaulieu, on the other hand, underrated them, treating it as a mishap which was more than counterbalanced by his own success in "cutting off the French from Genoa." He began to reconstruct his line on the front Dego-Sassello, trusting to Colli to harry the French until the Voltri troops had finished their *détour* through Acqui and rejoined Argenteau. This, of course, presumed that Argenteau's troops were intact and Colli's able to move, which was not the case with either. Not until the afternoon of the 14th did Beaulieu place a few extra battalions at Argenteau's disposal "to be used only in case of extreme necessity," and order Vukassovich from the region of Sassello to "make a diversion" against the French right with *two* battalions.

Thus Argenteau, already shaken, was exposed to destruction. On the 14th, after Provera's surrender, Masséna and Laharpe, reinforced until they had nearly a two-to-one superiority, stormed Dego and killed or captured 3000 of Argenteau's 5500 men, the remnant retreating in disorder to Acqui. But nothing was done towards the accomplishment of the purpose of destroying Colli on that day, save that Sérurier and Rusca began to close in to meet the main body between Ceva and Millesimo. Moreover, the victory at Dego had produced its usual results on the wild fighting swarms of the Republicans, who threw themselves like hungry wolves on the little town, without pursuing the beaten enemy or even placing a single outpost on the Acqui road. In this state, during the early hours of the 15th, Vukassovich's brigade,¹ marching up from Sassello, surprised them, and they broke and fled in an instant. The whole morning had to be spent in rallying them at Cairo, and Bonaparte had for the second time to postpone his union with Sérurier and Rusca, who meanwhile, isolated from one another and from the main army, were groping forward in the mountains. A fresh assault on Dego was ordered, and after very severe fighting, Masséna and Laharpe succeeded late in the evening in retaking it. Vukassovich lost heavily, but retired steadily and in order on Spigno. The killed and wounded numbered probably about 1000 French and 1500 Austrians, out of considerably less than 10,000 engaged on each side—a loss which contrasted very forcibly with those suffered in other battles of the Revolutionary Wars, and by teaching the Army of Italy to bear punishment, imbued it with self-confidence. But again success bred disorder, and there was a second orgy in the houses and streets of Dego which went on till late in the morning and paralysed the whole army.

This was perhaps the crisis of the campaign. Even now it was not certain that the Austrians had been definitively pushed aside, while it was quite clear that Beaulieu's main body was intact and Colli was still more an unknown quantity. But Napoleon's intention remained the same, to attack the Piedmontese as quickly and as heavily as possible, Beaulieu being held in check by a containing force under Masséna and Laharpe. The remainder of the army, counting in now Rusca and Sérurier, was to move westward towards Ceva. This disposition, while it illustrates the Napoleonic principle of delivering a heavy blow on the selected target and warding off interference at other points, shows also the difficulty of rightly apportioning the available means between the offensive mass and the defensive system, for, as it turned out, Beaulieu was already sufficiently scared, and thought of nothing but self-defence on the line Acqui-Ovada-Bocchetta, while the French offensive mass was very weak compared with Colli's unbeaten and now fairly concentrated army about Ceva and Montezemolo.

On the afternoon of the 16th the real advance was begun by Augereau's division, reinforced by other troops. Rusca joined Augereau towards evening, and Sérurier approached Ceva from the south. Colli's object was now to spin out time, and having repulsed a weak attack by Augereau, and feeling able to repeat these tactics on each successive spur of the Apennines,

¹ Vukassovich had received Beaulieu's order to demonstrate with two battalions, and also appeals for help from Argenteau. He therefore brought most of his troops with him.

he retired in the night to a new position behind the Cursaglia. On the 17th, reassured by the absence of fighting on the Dego side, and by the news that no enemy remained at Sassello, Bonaparte released Masséna from Dego, leaving only Laharpe there, and brought him over towards the right of the main body, which thus on the evening of the 17th formed a long straggling line on both sides of Ceva, Sérurier on the left, écheloned forward, Augereau, Joubert and Rusca in the centre, and Masséna, partly as support, partly as flank guard, on Augereau's right rear. Sérurier had been bidden to extend well out and to strive to get contact with Masséna, *i.e.* to encircle the enemy. There was no longer any idea of waiting to besiege Ceva, although the artillery train had been ordered up from the Riviera by the "cannon-road" for eventual use there. Further, the line of supply, as an extra guarantee against interference, was changed from that of Savona-Carcare to that of Loano-Bardinetto. When this was accomplished, four clear days could be reckoned on with certainty in which to deal with Colli.

The latter, still expecting the Austrians to advance to his assistance, had established his corps (not more than 12,000 muskets in all) in the immensely strong positions of the Cursaglia, with a thin line of posts on his left stretching towards Cherasco, whence he could communicate, by a roundabout way, with Acqui. Opposite this position the long straggling line of the French arrived, after many delays due to the weariness of the troops, on the 19th. A day of irregular fighting followed, everywhere to the advantage of the defenders. Napoleon, fighting against time, ordered a fresh attack on the 20th, and only desisted when it became evident that the army was exhausted, and, in particular, when Sérurier reported frankly that without bread the soldiers would not march. The delay thus imposed, however, enabled him to clear the "cannon-road" of all vehicles, and to bring up the Dego detachment to replace Masséna in the valley of the western Bormida, the latter coming in to the main army. Further, part at any rate of the convoy service was transferred still farther westward to the line Albenga-Gareasio-Ceva. Nelson's fleet, that had so powerfully contributed to force the French inland, was becoming less and less innocuous. If leadership and force of character could overcome internal friction, all the success he had hoped for was now within the young commander's grasp.

Twenty-four thousand men, for the first time with a due proportion of cavalry and artillery, were now disposed along Colli's front and beyond his right flank. Colli, outnumbered by two to one and threatened with envelopment, decided once more to retreat, and the Republicans occupied the Cursaglia lines on the morning of the 21st without firing a shot. But Colli halted again at Vico, half-way to Mondovi (in order, it is said, to protect the evacuation of a small magazine he had there), and while he was in this unfavourable situation the pursuers came on with true Republican swiftness, lapped round his flanks and crushed him. A few days later (27th April), the armistice of Cherasco put an end to the campaign before the Austrians moved a single battalion to his assistance.

The interest of the campaign being above all Napoleonic, its moral must be found by discovering the "Napoleon touch" that differentiated it from other Revolutionary campaigns. A great deal is common to all, on both sides. The Austrians and Sardinians worked together at least as effectively as the Austrians, Prussians, British and Dutch in the Netherlands. Revolutionary energy was common to the Army of Italy and to the Army of the North. Why, therefore, when the war dragged on from one campaign to another in the great plains of the Meuse and Rhine countries, did Napoleon bring about so swift a decision in these cramped valleys? The answer is to be found partly in the exigencies of the supply service, but still more in Napoleon's own personality and the strategy born of it. The first, as we have seen, was at the end of its resources when Beaulieu placed himself across the Genoa road. Action of some sort was the plain alternative to starvation, and at this point Napoleon's personality intervened. He would have no quarter-rations on the Riviera, but plenty and to spare beyond the mountains. If there were many thousand soldiers who marched unarmed and shoeless in the ranks, it was towards "the Promised Land" that he led them. He looked always to the end, and

met each day as if with full expectation of attaining it before sunset. Strategic conditions and "new French" methods of war did not save Bonaparte in the two crises—the Dego rout and the sullen halt of the army at San Michele—but the personality which made the soldiers, on the way to Montenotte, march barefoot past a wagon-load of new boots.

We have said that Napoleon's strategy was the result of this personal magnetism. Later critics evolved from his success the theory of "interior lines," and then accounted for it by applying the criterion they had evolved. Actually, the form in which the will to conquer found expression was in many important respects old. What, therefore, in the theory or its application was the product of Napoleon's own genius and will-power? A comparison with Souham's campaign of Tourcoing will enable us to answer this question. To begin with, Souham found himself midway between Coburg and Clerfayt almost by accident, and his utilization of the advantages of his position was an expedient for the given case. Napoleon, however, placed himself *deliberately* and by fighting his way thither, in an analogous situation at Carcare and Cairo. Military opinion of the time considered it dangerous, as indeed it was, for no theory can alter the fact that had not Napoleon made his men fight harder and march farther than usual, he would have been destroyed. The effective play of forces on interior lines depends on the two conditions that the outer enemies are not so near together as to give no time for the inner mass to defeat one before the arrival of the other, and that they are not so far apart that before one can be brought to action the other has inflicted serious damage elsewhere.

Neither condition was fully met at any time in the Montenotte campaign. On the 11th Napoleon knew that the attack on Voltri had been made by a part only of the Austrian forces, yet he flung his own masses on Montenotte. On the 13th he thought that Beaulieu's main body was at Dego and Colli's at Millesimo, and on this assumption had to exact the most extraordinary efforts from Augereau's troops at Cosaria. On the 19th and 20th he tried to exclude the risks of the Austrians' intervention, and with this the chances of a victory over them to follow his victory over Colli, by transferring the centre of gravity of his army to Ceva and Garesio, and fighting it out with Colli alone.

It was not, in fact, to gain a position on interior lines—with respect to two opponents—that Napoleon pushed his army to Carcare. Before the campaign began he hoped by using the "cannon-road" to destroy the Piedmontese before the Austrians were in existence at all as an army. But on the news from Voltri and Monte Legino he swiftly concentrated fire, made the breach, and broke the equilibrium "at the spot where the interests and forces of the two Allies converged and diverged. The hypothesis in the first case was that the Austrians were practically non-existent, and the whole object in the second was to breach the now connected front of the Allies ("strategic penetration") and to cause them to break up into two separate systems. More, having made the breach, he had the choice (which he had not before) of attacking either the Austrians or the Sardinians, as every critic has pointed out. Indeed the Austrians offered by far the better target. But he neither wanted nor used the new alternative. His purpose was to crush Piedmont. "My enemies saw too much at once," said Napoleon. Singleness of aim and of purpose, the product of clear thinking and of "personality," was the foundation-stone of the new form of strategy.

In the course of subduing the Sardinians, Napoleon found himself placed on interior lines between two hostile masses, and another new idea, that of "relative superiority," reveals itself. Whereas Souham had been in superior force (90,000 against 70,000), Napoleon (40,000 against 50,000) was not, and yet the Army of Italy was always placed in a position of relative superiority (at first about 3 to 2 and ultimately 2 to 1) to the immediate antagonist. "The essence of strategy," said Napoleon in 1797, "is, with a weaker army, always to have more force at the crucial point than the enemy. But this art is taught neither by books nor by practice; it is a matter of tact."

In this he expressed the result of his victories on his own mind rather than a preconceived formula which produced those victories. But the idea, though undefined, and the method of practice, though imperfectly worked out, were in his mind from the first. As soon as he had made the breach, he widened it by pushing out Masséna and Laharpe on the one hand and Augereau on the other. This is mere common sense. But immediately afterwards, though preparing to throw all available forces against Colli, he posted Masséna and Laharpe at Dego to guard, not like Vandamme on the Lys against a real and pressing enemy, but against a possibility, and he only diminished the strength and altered the position of this containing detachment in proportion as the Austrian danger dwindled. Later in his career he defined this offensive-defensive system as "having all possible strength at the decisive point," and "being nowhere vulnerable," and the art of reconciling these two requirements, in each case as it arose, was always the principal secret of his generalship. At first his precautions (judged by events

Relative superiority.

and not by the probabilities of the moment) were excessive, and the offensive mass small. But the latter was handled by a general untroubled by multiple aims and anxieties, and if such self-confidence was equivalent to 10,000 men on the battlefield, it was legitimate to detach 10,000 men to secure it. These 10,000 were posted 8 m. out on the dangerous

flank, not almost back to back with the main body as Vandamme had been,¹ and although this distance was but little compared to those of his later campaigns, when he employed small armies for the same purpose, it sufficed in this difficult mountain country, where the covering force enjoyed the advantage of strong positions. Of course, if Colli had been better concentrated, or if Beaulieu had been more active, the calculated proportions between covering force and main body might have proved fallacious, and the system on which Napoleon's relative superiority rested might have broken down. But the point is that such a system, however rough its first model, had been imagined and put into practice.

This was Napoleon's individual art of war, as raiding bakeries and cutting communications were Beaulieu's speciality. Napoleon made the art into a science, and in our own time, with modern conditions of effective, armament and communications, it is more than possible that Moreaus and Jourdans will prove able to practise it with success. But in the old conditions it required a Napoleon. "Strategy," said Moltke, "is a system of expedients." But it was the intense personal force, as well as the genius, of Napoleon that forged these expedients into a system.

The first phase of the campaign satisfactorily settled, Napoleon was free to turn his attention to the "arch-enemy" to whom he was now considerably superior in numbers (35,000 to 25,000). The day after the signature of the armistice of Cherasco he began preparing for a new advance and also for the rôle of arbiter of the destinies of Italy. Many whispers there were, even in his own army, as to the dangers of passing on without "revolutionizing" aristocratic Genoa and monarchical Piedmont, and of bringing Venice, the pope and the Italian princes into the field against the French. But Bonaparte, flushed with victory, and better informed than the malcontents of the real condition of Italy, never hesitated. His first object was to drive out Beaulieu, his second to push through Tirol, and his only serious restriction the chance that the armistice with Piedmont would not result in a definitive treaty. Beaulieu had fallen back into Lombardy, and now bordered the Po right and left of Valenza. To achieve further progress, Napoleon had first to cross that river, and the point and method of crossing was the immediate problem, a problem the more difficult as Napoleon had no bridge train and could only make use of such existing bridges as he could seize intact.² If he crossed above Valenza, he would be confronted by one river-line after another, on one of which at least Beaulieu would probably stand to fight. But quite apart from the immediate problem, Napoleon's intention was less to beat the Austrians than to dislodge them. He needed a foothold in Lombardy which would make him independent of, and even a menace to, Piedmont. If this were assured, he could for a few weeks entirely ignore his communications with France and strike out against Beaulieu, dethrone the king of Sardinia, or revolutionize Parma, Modena and the papal states according to circumstances.

Milan, therefore, was his objective, and Tortona-Piacenza his route thither. To give himself every chance, he had stipulated with the Piedmontese authorities for the right of passing at Valenza, and he had the satisfaction of seeing Beaulieu fall into the trap and concentrate opposite that part of the river. The French meantime had moved to the region Alessandria-Tortona. Thence on the 6th of May Bonaparte, with a picked body of troops, set out for a forced march on Piacenza, and that night the advanced guard was 30 m. on the way, at Castel San Giovanni, and Laharpe's and the cavalry divisions at Stradella, 10 m. behind them. Augereau was at Broni, Masséna at Sale and Sérurier near Valenza, the whole forming a rapidly extending fan, 50 m. from point to point. If the Piacenza detachment succeeded in crossing, the army was to follow rapidly in its track. If, on the other hand, Beaulieu fell

¹ We have seen that after Tourcoing, taught by experience, Souham posted Vandamme's covering force 14 or 15 m. out. But Napoleon's disposition was in advance of experience.

² The proposed alliance with the Sardinians came to nothing. The kings of Sardinia had always made their alliance with either Austria or France conditional on sessions of conquered territory. But, according to Thiers, the Directory only desired to coalesce the Milanese to restore it to Austria in return for the definitive cession of the Austrian Netherlands. If this be so, Napoleon's proclamations of "freedom for Italy" were, if not a mere political expedient, at any rate no more than an expression of his own desire which he was not powerful enough to enforce.

back to oppose the advanced guard, the Valenza divisions would take advantage of his absence to cross there. In either case, be it observed, the Austrians were to be *evaded*, not brought to action.

On the morning of the 7th, the swift advanced guard under General Dallemagne crossed at Piacenza,¹ and, hearing of this, Bonaparte ordered every division except Sérurier's thither with all possible speed. In the exultation of the moment he mocked at Beaulieu's incapacity, but the old Austrian was already on the alert. This game of manœuvres he understood; already one of his divisions had arrived in close proximity to Dallemagne and the others were marching eastward by all available roads. It was not until the 8th that the French, after a series of partial encounters, were securely established on the left bank of the Po, and Beaulieu had given up the idea of forcing their most advanced troops to accept battle at a disadvantage. The success of the French was due less to their plan than to their mobility, which enabled them first to pass the river before the Austrians (who had actually started a day in advance of them) put in an appearance, and afterwards to be in superior numbers at each point of contact. But the episode was destined after all to culminate in a great event, which Napoleon himself indicated as the turning-point of his life. "Vendémiaire and even Montebotte did not make me think myself a superior being. It was after Lodi that the idea came to me. . . . That first kindled the spark of boundless ambition."

The idea of a battle having been given up, Beaulieu retired to the Adda, and most of his troops were safely beyond it before the

Lodi. French arrived near Lodi, but he felt it necessary to leave a strong rearguard on the river opposite that place to cover the reassembly of his columns after their scattered march. On the afternoon of the 10th of May, Bonaparte, with Dallemagne, Masséna and Augereau, came up and seized the town. But 200 yds. of open ground had to be passed from the town gate to the bridge, and the bridge itself was another 250 in length. A few hundred yards beyond it stood the Austrians, 9000 strong with 14 guns. Napoleon brought up all his guns to prevent the enemy from destroying the bridge. Then sending all his cavalry to turn the enemy's right by a ford above the town, he waited two hours, employing the time in cannonading the Austrian lines, resting his advanced infantry and closing up Masséna's and Augereau's divisions. Finally he gave the order to Dallemagne's 4000 grenadiers, who were drawn up under cover of the town wall, to rush the bridge. As the column, not more than thirty men broad, made its appearance, it was met by the concentrated fire of the Austrian guns, and half way across the bridge it checked, but Bonaparte himself and Masséna rushed forward, the courage of the soldiers revived, and, while some jumped off the bridge and scrambled forward in the shallow water, the remainder stormed on, passed through the guns and drove back the infantry. This was, in bare outline, the astounding passage of the Bridge of Lodi. It was not till after the battle that Napoleon realized that only a rearguard was in front of him. When he launched his 4000 grenadiers he thought that on the other side there were four or five times that number of the enemy. No wonder, then, that after the event he recognized in himself the flash of genius, the courage to risk everything, and the "tact" which, independent of, and indeed contrary to all reasoned calculations, told him that the moment had come for "breaking the equilibrium." Lodi was a tactical success in the highest sense, in that the principles of his tactics rested on psychology—on the "sublime" part of the art of war as Saxe had called it long ago. The spirit produced the form, and Lodi was the prototype of the Napoleonic battle—contact, manœuvre, preparation, and finally the well-timed, massed and unhesitating assault. The absence of strategical results mattered little. Many months elapsed before this bold assertion of superiority ceased to decide the battles of France and Austria.

¹ On entering the territory of the duke of Parma Bonaparte imposed, besides other contributions, the surrender of twenty famous pictures, and thus began a practice which for many years enriched the Louvre and only ceased with the capture of Paris in 1814.

Next day, still under the vivid tactical impressions of the Bridge of Lodi, he postponed his occupation of the Milanese and set off in pursuit of Beaulieu, but the latter was now out of reach, and during the next few days the French divisions were installed at various points in the area Pavia-Milan-Pizzighetone, facing outwards in all dangerous directions, with a central reserve at Milan. Thus secured, Bonaparte turned his attention to political and military administration. This took the form of exacting from the neighbouring princes money, supplies and objects of art, and the once famished Army of Italy revelled in its opportunity. Now, however, the Directory, suspicious of the too successful and too sanguine young general, ordered him to turn over the command in Upper Italy to Kellermann, and to take an expeditionary corps himself into the heart of the Peninsula, there to preach the Republic and the overthrow of princes. Napoleon absolutely refused, and offered his resignation. In the end (partly by bribery) he prevailed, but the incident reawakened his desire to close with Beaulieu. This indeed he could now do with a free hand, since not only had the Milanese been effectively occupied, but also the treaty with Sardinia had been ratified.

But no sooner had he resumed the advance than it was interrupted by a rising of the peasantry in his rear. The exactions of the French had in a few days generated sparks of discontent which it was easy for the priests and the nobles to fan into open flames. Milan and Pavia as well as the countryside broke into insurrection, and at the latter place the mob forced the French commandant to surrender. Bonaparte acted swiftly and ruthlessly. Bringing back a small portion of the army with him, he punished Milan on the 25th, sacked and burned Binasco on the 26th, and on the evening of the latter day, while his cavalry swept the open country, he broke his way into Pavia with 1500 men and beat down all resistance. Napoleon's cruelty was never purposeless. He deported several scores of hostages to France, executed most of the mob leaders, and shot the French officer who had surrendered. In addition, he gave his 1500 men three hours' leave to pillage. Then, as swiftly as they had come, they returned to the army on the Oglio. From this river Napoleon advanced to the banks of the Mincio, where the remainder of the Italian campaign was fought out, both sides contemptuously disregarding Venetian neutrality.

It centred on the fortress of Mantua, which Beaulieu, too weak to keep the field, and dislodged from the Mincio in the action of Borghetto (May 30), strongly garrisoned before retiring into Tirol. Beaulieu was soon afterwards replaced by Dagobert Siegmund, count von Wurmsér (b. 1724), who brought considerable reinforcements from Germany.

At this point, mindful of the narrow escape he had had of losing his command, Bonaparte thought it well to begin the resettlement of Italy. The scheme for co-operating with Moreau on the Danube was indefinitely postponed, and the Army of Italy (now reinforced from the Army of the Alps and counting 42,000 effectives) was again disposed in a protective "zone of manœuvre," with a strong central reserve. Over 8000 men, however, garrisoned the fortresses of Piedmont and Lombardy, and the effective blockade of Mantua and political expeditions into the heart of the Peninsula soon used up the whole of this reserve.

Moreover, no siege artillery was available until the Austrians in the citadel of Milan capitulated, and thus it was not till the 18th of July that the first parallel was begun. Almost at the same moment Wurmsér began his advance from Trent with 55,000 men to relieve Mantua.

The protective system on which his attack would fall in the first instance was now as follows:—Augereau (6000) about Legnago, Despinoy (8000) south-east of Verona, Masséna (13,000) at Verona and Peschiera, with *Siege of Mantua.* outposts on the Monte Baldo and at La Corona, Sauret (4500) at Salò and Gardavò. Sérurier (12,000) was besieging Mantua, and the only central reserve was the cavalry (2000) under Kilmaine. The main road to Milan passed by Brescia. Sauret's brigade, therefore, was practically a detached

post on the line of communication, and on the main defensive front less than 30,000 men were disposed at various points between La Corona and Legnago (30 m. apart), and at a distance of 15 to 20 m. from Mantua. The strength of such a disposition depended on the fighting power and handiness of the troops, who in each case would be called upon to act as a rearguard to gain time. Yet the lie of the country scarcely permitted a closer grouping, unless indeed Bonaparte fell back on the old-time device of a "circumvallation," and shut himself up, with the supplies necessary for the calculated duration of the siege, in an impregnable ring of earthworks round Mantua. This, however, he could not have done even if he had wished, for the wave of revolt radiating from Milan had made accumulations of food impossible, and the lakes above and below the fortress, besides being extremely unhealthy, would have extended the perimeter of the circumvallation so greatly that the available forces would not suffice to man it. It was not in this, but in the absence of an

On the 29th Quasdanovich attacked Sauret at Salò, drove him towards Desenzano, and pushed on to Gavardo and thence into Brescia. Wurmser expelled Masséna's advanced guard from La Corona, and captured in succession the Monte Baldo and Rivoli posts. The Brenta column approached Verona with little or no fighting. News of this column led Napoleon early in the day to close up Despinoy, Masséna and Kilmaine at Castelnuovo, and to order Augereau from Legnago to advance on Montebello (19 m. east of Verona) against Davidovich's left rear. But after these orders had been despatched came the news of Sauret's defeat, and this moment was one of the most anxious in Napoleon's career. He could not make up his mind to give up the siege of Mantua, and he hurried Augereau back to the Mincio, and sent order after order to the officers on the lines of communication to send all convoys by the Cremona instead of by the Brescia road. More, he had the baggage, the treasure and the sick set in motion at once for Marcaria, and wrote to Sérurier

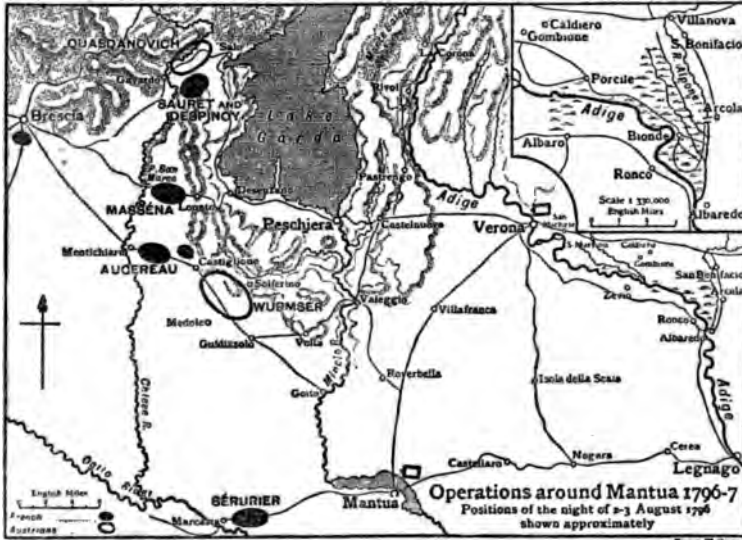

a despatch which included the words "perhaps we shall recover ourselves . . . but I must take serious measures for a retreat." On the 30th he wrote: "The enemy have broken through our line in three places . . . Sauret has evacuated Salò . . . and the enemy has captured Brescia. You see that our communications with Milan and Verona are cut." The reports that came to him during the morning of the 30th enabled him to place the main body of the enemy opposite Masséna, and this, without in the least alleviating the gravity of the situation, helped to make his course less doubtful. Augereau was ordered to hold the line of the Molinella, in case Davidovich's attack, the least-known factor, should after all prove to be serious; Masséna to reconnoitre a road from Peschiera through Castiglione towards Orzinovi, and to stand fast at Castelnuovo opposite Wurmser as long as he could. Sauret and Despinoy were concentrated

important central reserve that Bonaparte's disposition is open to criticism, which indeed could impugn the scheme in its entirety, as overtaxing the available resources, more easily than it could attack its details.

If Bonaparte has occasionally been criticized for his defensive measures, Wurmser's attack procedure has received almost universal condemnation, as to the justice of which it may be pointed out that the object of the expedition was not to win a battle by falling on the disunited French with a well-concentrated army, but to overpower one, any one, of the corps covering the siege, and to press straight forward to the relief of Mantua, i.e. to the destruction of Bonaparte's batteries and the levelling of his trench work. The old principle that a battle was a grave event of doubtful issue was reinforced in the actual case by Beau lieu's late experiences of French *Man*, and as a temporary victory at one point would suffice for the purpose in hand, there was every incentive to multiply the points of contact. The soundness of Wurmser's plan was proved by the event. New ideas and new forces, indiscernible to a man of seventy-two years of age, obliterated his achievement by surpassing it, but such as it was—a limited use of force for a limited object—the venture undeniably succeeded.

The Austrians formed three corps, one (Quasdanovich, 18,000 men) marching round the west side of the Lake of Garda on Gavardo, Salò and the Brescia road, the second (under Wurmser, about 30,000) moving directly down the Adige, and the third (Davidovich, 6,000) making a détour by the Brenta valley and heading for Verona by Vicenza.

¹ See C. von B.-K., *Galet and Staff*, pp. 449-451.

at Desenzano with orders on the 31st to clear the main line of retreat and to recapture Brescia. The Austrian movements were merely the continuation of those of the 29th. Quasdanovich wheeled in ards, his right finally resting on Montechiaro and his left on Salò. Wurmser drove back Masséna to the west side of the Mincio. Davidovich made a slight advance.

In the late evening Bonaparte held a council of war at Roverbella. The proceedings of this council are unknown, but it at any rate enabled Napoleon to see clearly and to act. Hitherto he had been covering the siege of Mantua with various detachments, the defeat of any one of which might be fatal to the enterprise. Thus, when he had lost his main line of retreat, he could assemble no more than 8,000 men at Desenzano to win it back. Now, however, he made up his mind that the siege could not be continued, and bitter as the decision must have been, it gave him freedom. At this moment of crisis the instincts of the great captain came into play, and showed the way to a victory that would more than counter-balance the now inevitable failure. Sérurier was ordered to spike the 140 siege guns that had been so welcome a few days before, and, after sending part of his force to Augereau, to establish himself with the rest at Marcaria on the Cremona road. The field forces were to be used on interior lines. On the 31st Sauret, Despinoy, Augereau and Kilmaine advanced westward against Quasdanovich. The first two found the Austrians at

and Lonato and drove them back, while with Augereau he cavalry Bonaparte himself made a forced march on in, never halting night or day till he reached the town and freed his depots. Meantime Sérurier had retired (night of 31), Masséna had gradually drawn in towards Lonato, Wurmser's advanced guard triumphantly entered the town (August 1).

The Austrian general now formed the plan of crushing Bonaparte between Quasdanovich and his own main body. Meantime Quasdanovich had evacuated Brescia under the pressure of Bonaparte's advance and was now fighting a long and arduous action with Despinoy and Sauret about Gavardo and Lonato and Bonaparte, having missed his expected target, had to retreat by another severe march back to Montechiaro and Chiave. Masséna was now assembled between Lonato and Ponte San Marco, and Sérurier was retiring quietly on Mantua. Wurmser's main body, weakened by the detachment of Quasdanovich, crossed the Mincio about Valeggio and Goltos, and penetrated as far as Castiglione, whence Masséna's advanced guard was expelled. But a renewed advance of Quasdanovich, ordered by Wurmser, which drove Sauret and Despinoy back on Brescia and Lonato, in the end only placed a strong detachment of the Austrians within striking distance of Masséna, who on the 3rd attacked it from the front, and by sheer fighting destroyed it, at the same time Augereau recaptured Castiglione from Wurmser. On the 4th Sauret and Despinoy pressed back beyond Salò and Gavardo. One of the Austrian main bodies, finding itself isolated and unable to retreat with the 1st, turned back to break its way through to Wurmser, and annihilated by Masséna in the neighbourhood of Lonato. On the 5th Augereau fought his way towards Solferino, and Wurmser, thinking rightly or wrongly that he could not now retreat to the Mincio without a battle, drew up his whole force, on 30,000 men, in the plain between Solferino and Medole. The battle may be described in very few words. Bonaparte, seeing that no more was to be feared from Quasdanovich, seeing that Wurmser meant to fight, called in Despinoy's division to the main body and sent orders to Sérurier, then far off on the Cremona road, to march against the left flank of the Austrians. On the 5th the battle of Castiglione was fought. It was contested in the first hours of the frontal attack till the arrival of Sérurier decided the day, it ended in the retreat of the Austrians over the Mincio and into Tirol whence they had

been driven. The new way had failed to keep back Wurmser, and the result failed to crush Napoleon. Each was the result of its own nature. In former wars a commander threatened as Napoleon would have fallen back at once to the Adda, abandoning the town on such good time that he would have been able to bring off his artillery. Instead of this Bonaparte hesitated long enough to do so, which, according to accepted canons was a waste, and held ground, which was, by the same rules, sheer madness. But military discipline was not firm enough to stand a retreat. It turned back, the army would have streamed away to Milan or to the Alps (cf. 1799), and the only alternative to compromise was therefore fighting.

In the manner of this fighting, even the principle of "relative superiority" failed him so long as he was endeavouring to cover his rear and again when his chief care was to protect his new line of retreat and to clear his old. In this period, viz. up to his return to Brescia on the 2nd of August, the only "mass" he collected was a blow in the air, while the covering detachments had to hard for bare existence. Once released from its trammels, the Napoleonic principle had fair play. He stood between Wurmser and Quasdanovich, ready to fight either or both. The latter was defeated, thanks to local superiority and the resolute leading of Bonaparte, but at Castiglione Wurmser actually outnumbered his opponent till the last of Napoleon's precautionary dispositions had given up, and Sérurier brought back from the "alternative line of retreat" to the battlefield. The moral is, again, that it was not the fact of being on interior lines that gave Napoleon the victory, it was "tact," his fine appreciation of the chances in his favour, and in terms of time, space, attacking force and containing. All these factors were greatly influenced by the ground, which held the swarms and columns of the French and deprived the brilliant Austrian cavalry of its power to act. But of far more importance was the mobility that Napoleon's personal

force imparted to the French. Napoleon himself rode five horses to death in three days, and Augereau's division marched from Roverbella to Brescia and back to Montechiaro, a total distance of nearly 50 m., in about thirty-six hours. This indeed was the foundation of his "relative superiority," for every hour saved in the time of marching meant more freedom to destroy one corps before the rest could overwhelm the covering detachments and come to its assistance.

Wurmser's plan for the relief of Mantua, suited to its purpose, succeeded. But when he made his objective the French field army, he had to take his own army as he found it, disposed for an altogether different purpose. A properly combined attack of convergent columns framed *ab initio* by a good staff officer, such as Mack, might indeed have given good results. But the success of such a plan depends principally on the assailant's original possession of the initiative, and not on the chances of his being able to win it over to his own side when operations, as here, are already in progress. When the time came to improvise such a plan, the initiative had passed over to Napoleon, and the plan was foredoomed.

By the end of the second week in August the blockade of Mantua had been resumed, without siege guns. But still under the impression of a great victory gained, Bonaparte was planning a long forward stride. He thought that by advancing past Mantua directly on Trieste and thence onwards to the Semmering he could impose a peace on the emperor. The Directory, however, which had by now focussed its attention on the German campaign, ordered him to pass through Tirol and to co-operate with Moreau, and this plan, Bonaparte, though protesting against an Alpine venture being made so late in the year, prepared to execute, drawing in reinforcements and collecting great quantities of supplies in boats on the Adige and Lake Garda. Wurmser was thought to have posted his main body near Trent, and to have detached one division to Bassano "to cover Trieste." The French advanced northward on the 2nd, in three disconnected columns (precisely as Wurmser had done in the reverse direction at the end of July)—Masséna (13,000) from Rivoli to Ala, Augereau (9,000) from Verona by hill roads, keeping on his right rear, Vaubois (11,000) round the Lake of Garda by Riva and Torbole. Sahuguet's division (8,000) remained before Mantua. The French divisions successfully combined and drove the enemy before them to Trent.

There, however, they missed their target. Wurmser had already drawn over the bulk of his army (22,000) into the Val Sugana, whence, with the Bassano division as his advanced guard, he intended once more to relieve Mantua, while Davidovich with 13,000 (excluding detachments) was to hold Tirol against any attempt of Bonaparte to join forces with Moreau.

Thus Austria was preparing to hazard a second (as in the event she hazarded a third and a fourth) highly trained and expensive professional army in the struggle for the preservation of a fortress, and we must conclude that there were weighty reasons which actuated so notoriously cautious a body as the Council of War in making this unconditional venture. While Mantua stood, Napoleon, for all his energy and sanguineness, could not press forward into Friuli and Carniola, and immunity from a Republican visitation was above all else important for the Vienna statesmen, governing as they did more or less discontented and heterogeneous populations that had not felt the pressure of war for a century and more. The Austrians, so far as is known, desired no more than to hold their own. They no longer possessed the superiority of *moral* that guarantees victory to one side when both are materially equal. There was therefore nothing to be gained, commensurate with the risk involved, by fighting a battle in the open field. *In Italien steigt nicht die Kavallerie* was an old saying in the Austrian army, and therefore the Austrians could not hope to win a victory of the first magnitude. The only practicable alternative was to strengthen Mantua as opportunities offered themselves, and to prolong the passive resistance as much as possible. Napoleon's own practice in providing for secondary theatres of war was to economise forces and to delay a decision, and the fault of the Austrians, viewed from a purely military standpoint, was that they squandered, instead of economising, their forces to gain time. If we neglect pure theory, and regard strategy as the handmaiden of statesmanship—which fundamentally it is—

cannot condemn the Vienna authorities unless it be first proved that they grossly exaggerated the possible results of Bonaparte's threatened irruption. And if their capacity for judging the political situation be admitted, it naturally follows that their object was to preserve Mantua *at all costs*—which object Wurmser, though invariably defeated in action, did in fact accomplish.

When Masséna entered Trent on the morning of the 5th of September, Napoleon became aware that the force in his front was a mere detachment, and news soon came in that **Bassano**. Wurmser was in the Val Sugana about Primolano and at Bassano. This move he supposed to be intended to cover Trieste, being influenced by his own hopes of advancing in that direction, and underestimating the importance, to the Austrians, of preserving Mantua. He therefore informed the Directory that he could not proceed with the Tirol scheme, and spent one more day in driving Davidovich well away from Trent. Then, leaving Vaubois to watch him, Napoleon marched Augereau and Masséna, with a rapidity he scarcely ever surpassed, into the Val Sugana. Wurmser's rearguard was attacked and defeated again and again, and Wurmser himself felt compelled to stand and fight, in the hope of checking the pursuit before going forward into the plains. Half his army had already reached Montebello on the Verona road, and with the rear half he posted himself at Bassano, where on the 8th he was attacked and defeated with heavy losses. Then began a strategic pursuit or general chase, and in this the mobility of the French should have finished the work so well begun by their tactics.

But Napoleon directed the pursuers so as to cut off Wurmser from Trieste, not from Mantua. Masséna followed up the Austrians to Vicenza, while Augereau hurried towards Padua, and it was not until late on the 9th that Bonaparte realized that his opponent was heading for Mantua via Legnago. On the 10th Masséna crossed the Adige at Ronco, while Augereau from Padua reached Montagnana. Sahuguet from Mantua and Kilmaine from Verona joined forces at Castellaro on the 11th, with orders to interpose between Wurmser and the fortress. Wurmser meantime had halted for a day at Legnago, to restore order, and had then resumed his march. It was almost too late, for in the evening, after having to push aside the head of Masséna's column at Cerea, he had only reached Nogara, some miles short of Castellaro, and close upon his rear was Augereau, who reached Legnago that night. On the 12th, eluding Sahuguet by a detour to the southward, he reached Mantua, with all the columns of the French, weary as most of them were, in hot pursuit. After an attempt to keep the open field, defeated in a general action on the 15th, the relieving force was merged in the garrison, now some 28,000 in all. So ended the episode of Bassano, the most brilliant feature of which as usual was the marching power of the French infantry. This time it sufficed to redeem even strategical misconceptions and misdirections. Between the 5th and the 11th, besides fighting three actions, Masséna had marched 100 m. and Augereau 114.

Feldzeugmeister Alvinci was now appointed to command a new army of relief. This time the mere distribution of the troops imposed a concentric advance of separate columns, for practically the whole of the fresh forces available were in Carniola, the Military Frontier, &c., while Davidovich was still in Tirol. Alvinci's intention was to assemble his new army (29,000) in Friuli, and to move on Bassano, which was to be occupied on the 4th of November. Meantime Davidovich (18,000) was to capture Trent, and the two columns were to connect by the Val Sugana. All being well, Alvinci and Davidovich, still separate, were then to converge on the Adige between Verona and Legnago. Wurmser was to co-operate by vigorous sorties. At this time Napoleon's protective system was as follows: Kilmaine (9000) investing Mantua, Vaubois (10,000) at Trent, and Masséna (9000) at Bassano and Treviso, Augereau (9000) and Macquard (3000) at Verona and Villafranca constituting, for the first time in these operations, important mobile reserves. Hearing of Alvinci's approach in good time, he meant first to drive back Davidovich, then with Augereau, Masséna, Macquard and 3000 of Vaubois's force to fall upon Alvinci, who, he calculated,

would at this stage have reached Bassano, and finally to send back a large force through the Val Sugana to attack Davidovich. This plan practically failed.

Instead of advancing, Vaubois was driven steadily backward. By the 6th, Davidovich had fought his way almost to Roveredo, and Alvinci had reached Bassano and was there **Caldiero**, successfully repelling the attacks of Masséna and Augereau. That night Napoleon drew back to Vicenza. On the 7th Davidovich drove in Vaubois to Corona and Rivoli, and Alvinci came within 5 m. of Vicenza. Napoleon watched carefully for an opportunity to strike out, and on the 8th massed his troops closely around the central point of Verona. On the 9th, to give himself air, he ordered Masséna to join Vaubois, and to drive back Davidovich at all costs. But before this order was executed, reports came in to the effect that Davidovich had suspended his advance. The 10th and 11th were spent by both sides in relative inaction, the French waiting on events and opportunities, the Austrians resting after their prolonged exertions. Then, on the afternoon of the 11th, being informed that Alvinci was approaching, Napoleon decided to attack him. On the 12th the advanced guard of Alvinci's army was furiously assailed in the position of Caldiero. But the troops in rear came up rapidly, and by 4 P.M. the French were defeated all along the line and in retreat on Verona. Napoleon's situation was now indeed precarious. He was on "interior lines," it is true, but he had neither the force nor the space necessary for the delivery of rapid radial blows. Alvinci was in superior numbers, as the battle of Caldiero had proved, and at any moment Davidovich, who had twice Vaubois's force, might advance to the attack of Rivoli. The reserves had proved insufficient, and Kilmaine had to be called up from Mantua, which was thus for the third time freed from the blockaders. Again the alternatives were retreat, in whatever order was possible to Republican armies, and beating the nearest enemy at any sacrifice. Napoleon chose the latter, though it was not until the evening of the 14th that he actually issued the fateful order.

The Austrians, too, had selected the 15th as the date of their final advance on Verona, Davidovich from the north, Alvinci via Zevio from the south. But Napoleon was no longer there; leaving Vaubois to hold Davidovich as best he might, and posting only 3000 men in Verona, he had collected the rest of his small army between Albaro and Ronco. His plan seems to have been to cross the Adige well in rear of the Austrians, to march north on to the Verona-Vicenza highway, and there, supplying himself from their convoys, to fight to the last. On the 15th he had written to the Directory, "The weakness and the exhaustion of the army causes me to fear the worst. We are perhaps on the eve of losing Italy." In this extremity of danger the troops passed the Adige in three columns near Ronco and Albaredo, and marched forward along the dikes, with deep marshes and pools on either hand. If Napoleon's intention was to reach the dry open ground of S. Bonifacio in rear of the Austrians, it was not realized, for the Austrian army, instead of being at the gates of Verona, was still between Caldiero and S. Bonifacio, heading, as we know, for Zevio. Thus Alvinci was able, easily and swiftly, to wheel to the south.

The battle of Arcola almost defies description. The first day passed in a series of resultless encounters between the heads of the columns as they met on the dikes. In the evening Bonaparte withdrew over the Adige, expecting **Arcola** at every moment to be summoned to Vaubois's aid. But Davidovich remained inactive, and on the 16th the French again crossed the river. Masséna from Ronco advanced on Porcile, driving the Austrians along the causeway thither, but on the side of Arcola, Alvinci had deployed a considerable part of his forces on the edge of the marshes, within musket shot of the causeway by which Bonaparte and Augereau had to pass, along the Austrian front, to reach the bridge of Arcola. In these circumstances the second day's battle was more murderous and no more decisive than the first, and again the French retreated to Ronco. But Davidovich again stood still, and with incredible obstinacy Bonaparte ordered a third assault for the 17th, using

indeed more tactical expedients than before, but calculating chiefly on the fighting powers of his men and on the exhaustion of the enemy. Masséna again advanced on Porcile, Robert's brigade on Arcola, but the rest, under Augereau, were to pass the Apone near its confluence with the Adige, and joining various small bodies which passed the main stream lower down, to storm forward on dry ground to Arcola. The Austrians, however, themselves advanced from Arcola, overwhelmed Robert's brigade on the causeway and almost reached Ronco. This was perhaps the crisis of the battle, for Augereau's force was now on the other side of the stream, and Masséna, with his back to the new danger, was approaching Porcile. But the fire of a deployed regiment stopped the head of the Austrian column; Masséna, turning about, cut into its flank on the dike; and Augereau, gathering force, was approaching Arcola from the south. The bridge and the village were evacuated soon afterwards, and Masséna and Augereau began to extend in the plain beyond. But the Austrians still sullenly resisted. It was at this moment that Bonaparte secured victory by a mere ruse, but a ruse which would have been unprofitable and ridiculous had it not been based on his fine sense of the moral conditions. Both sides were nearly fought out, and he sent a few trumpeters to the rear of the Austrian army to sound the charge. They did so, and in a few minutes the Austrians were streaming back to S. Bonifacio. This ended the drama of Arcola, which more than any other episode of these wars, perhaps of any wars in modern history, centres on the personality of the hero. It is said that the French fought without spirit on the first day, and yet on the second and third Bonaparte had so thoroughly imbued them with his own will to conquer that in the end they prevailed over an enemy nearly twice their own strength.

The climax was reached just in time, for on the 17th Vaubois was completely defeated at Rivoli and withdrew to Peschiera, leaving the Verona and Mantua roads completely open to Davidovich. But on the 19th Napoleon turned upon him, and combining the forces of Vaubois, Masséna and Augereau against him, drove him back to Trent. Meantime Alvinczi returned from Vicenza to San Bonifacio and Caldiero (November 21st), and Bonaparte at once stopped the pursuit of Davidovich. On the return of the French main body to Verona, Alvinczi finally withdrew, Wurmsér, who had emerged from Mantua on the 23rd, was driven in again, and this epilogue of the great struggle came to a feeble end because neither side was now capable of prolonging the crisis.

Alvinczi renewed his advance in January 1797 with all the forces that could be assembled for a last attempt to save Mantua. At this time 8000 men under Sérurier blockaded Mantua. Masséna (9000) was at Verona, Joubert (Vaubois's successor) at Rivoli with 10,000, Augereau at Legnago with 9000. In reserve were Rey's division (4000) between Brescia and Montechiaro, and Victor's brigade at Goito and Castelnovo. On the other side, Alvinczi had 9000 men under Provera at Padua, 6000 under Bayalich at Bassano, and he himself with 28,000 men stood in the Tirol about Trent. This time he intended to make his principal effort on the Rivoli side. Provera was to capture Legnago on the 9th of January, and Bayalich Verona on the 12th, while the main army was to deliver its blow against the Rivoli position on the 13th.

The first marches of this scheme were duly carried out, and several days elapsed before Napoleon was able to discern the direction of the real attack. Augereau fell back, skirmishing a little, as Provera's and Bayalich's advance developed. On the 11th, when the latter was nearing Verona, Alvinczi's leading troops appeared in front of the Rivoli position. On the 12th Bayalich with a weak force (he had sent reinforcements to Alvinczi by the Val Pantena) made an unsuccessful attack on Verona, Provera, farther south, remaining inactive. On the 13th Napoleon, still in doubt, launched Masséna's division against Bayalich, who was driven back to San Bonifacio; but at the same time definite news came from Joubert that Alvinczi's main army was in front of La Corona. From this point begins the decisive, though by no means the most intense or dramatic,

struggle of the campaign. Once he felt sure of the situation Napoleon acted promptly. Joubert was ordered to hold on to Rivoli at all costs. Rey was brought up by a forced march to Castelnovo, where Victor joined him, and ahead of them both Masséna was hurried on to Rivoli. Napoleon himself joined Joubert on the night of the 13th. There he saw the watch-fires of the enemy in a semicircle around him, for Alvinczi, thinking that he had only to deal with one division, had begun a widespread enveloping attack. The horns of this attack were as yet so far distant that Napoleon, instead of extending on an equal front, only spread out a few regiments to gain an hour or two and to keep the ground for Masséna and Rey, and on the morning of January 14th, with 20,000 men in hand against 26,000, he fell upon the central columns of the enemy as they advanced up the steep broken slopes of the foreground. The fighting was severe, but Bonaparte had the advantage. Masséna arrived at 9 A.M., and a little later the column of Quasdanovich, which had moved along the Adige and was now attempting to gain a foothold on the plateau in rear of Joubert, was crushed by the converging fire of Joubert's right brigade and by Masséna's guns, their rout being completed by the charge of a handful of cavalry under Lasalle. The right horn of Alvinczi's attack, when at last it swung in upon Napoleon's rear, was caught between Masséna and the advancing troops of Rey and annihilated, and even before this the dispirited Austrians were in full retreat. A last alarm, caused by the appearance of a French infantry regiment in their rear (this had crossed the lake in boats from Salò), completed their demoralization, and though less than 2000 had been killed and wounded, some 12,000 Austrian prisoners were left in the hands of the victors. Rivoli was indeed a moral triumph. After the ordeal of Arcola, the victory of the French was a foregone conclusion at each point of contact. Napoleon hesitated, or rather refrained from striking, so long as his information was incomplete, but he knew now from experience that his covering detachment, if well led, could not only hold its own without assistance until it had gained the necessary information, but could still give the rest of the army time to act upon it. Then, when the centre of gravity had been ascertained, the French divisions hurried thither, caught the enemy in the act of manoeuvring and broke them up. And if that confidence in success which made all this possible needs a special illustration, it may be found in Napoleon's sending Murat's regiment over the lake to place a mere two thousand bayonets across the line of retreat of a whole army. Alvinczi's manoeuvre was faulty neither strategically in the first instance nor tactically as regards the project of enveloping Joubert on the 14th. It failed because Joubert and his men were better soldiers than his own, and because a French division could move twice as fast as an Austrian, and from these two factors a new form of war was evolved, the essence of which was that, for a given time and in a given area, a small force of the French should engage and hold a much larger force of the enemy.

The remaining operations can be very briefly summarized. Provera, still advancing on Mantua, joined hands there with Wurmsér, and for a time held Sérurier at a disadvantage. But bearing of this, Napoleon sent back Masséna from the field of Rivoli, and that general, with Augereau and Sérurier, not only forced Wurmsér to retire again into the fortress, but compelled Provera to lay down his arms. On the 2nd of February 1797, after a long and honourable defence, Mantua, and with it what was left of Wurmsér's army, surrendered.

The campaign of 1797, which ended the war of the First Coalition, was the brilliant sequel of these hard-won victories. Austria had decided to save Mantua at all costs, and had lost her armies in the attempt, a loss which was not compensated by the "strategic" victories of the archduke. Thus the Republican "visitation" of Carinthia and Carniola was one swift march—politically glorious, if dangerous from a purely military standpoint—of Napoleon's army to the Semmering. The archduke, who was called thither from Germany, could do no more than fight a few rearguard actions, and make threats against Napoleon's rear, which the latter, with his usual "tact," ignored. On the Rhine, as in 1795 and 1796, the armies of the Sambre-and-Meuse (Hoche) and the Rhine-and-Moselle (Moreau) were opposed by the armies of the Lower Rhine (Werneck) and of the Upper Rhine (Latour). Moreau crossed the river near Strassburg and fought a series of minor actions. Hoche, like his predecessors, crossed at Düsseldorf and Neuwied and fought his

way to the Lahn, where for the last time in the history of these wars, there was an irregular widespread battle. But Hoche, in this his last campaign, displayed the brilliant energy of his first, and delivered the "series of incessant blows" that Carnot had urged upon Jourdan the year before. Werneck was driven with ever-increasing losses from the lower Lahn to Weizlar and Giessen. Thence, pressed hard by the French left wing under Championnet, he retired on the Nidda, only to find that Hoche's right had swung completely round him. Nothing but the news of the armistice of Leoben saved him from envelopment and surrender. This general armistice was signed by Bonaparte, on his own authority and to the intense chagrin of the Directory and of Hoche, on the 18th of April, and was the basis of the peace of Campo Formio.

NAPOLEON IN EGYPT

Within the scope of this article, yet far more important from its political and personal than from its general military interest, comes the expedition of Napoleon to Egypt and its sequel (see also *EGYPT: History; NAPOLEON, &c.*). A very brief summary must here suffice. Napoleon left Toulon on the 19th of May 1798, at the same time as his army (40,000 strong in 400 transports) embarked secretly at various ports. Nelson's fleet was completely evaded, and, capturing Malta *en route*, the armada reached the coast of Egypt on the 1st of July. The republicans stormed Alexandria on the 2nd. Between Embabeh and Gizeh, on the left bank of the Nile, 60,000 Mamelukes were defeated and scattered on the 21st (battle of the Pyramids), the French for the most part marching and fighting in the chequer of infantry squares that afterwards became the classical formation for desert warfare. While his lieutenants pursued the more important groups of the enemy, Napoleon entered Cairo in triumph, and proceeded to organise Egypt as a French protectorate. Meantime Nelson, though too late to head off the expedition, had annihilated the squadron of Admiral Bruyès. This blow severed the army from the home country, and destroyed all hope of reinforcements. But to eject the French already in Egypt, military invasion of that country was necessary. The first attempts at this were made in September by the Turks as overlords of Egypt. Napoleon—after suppressing a revolt in Cairo—marched into Syria to meet them, and captured El Arish and Jaffa (at the latter place the prisoners, whom he could afford neither to feed, to release, nor to guard, were shot by his order). But he was brought to a standstill (March 17-May 20) before the half-defensible fortifications of Acre, held by a Turkish garrison and animated by the leadership of Sir W. Sidney Smith (*q.v.*). In May, though meantime a Turkish relieving army had been severely beaten in the battle of Mount Tabor (April 16, 1799), Napoleon gave up his enterprise, and returned to Egypt, where he won a last victory in annihilating at Aboukir, with 6000 of his own men, a Turkish army 18,000 strong that had landed there (July 25, 1799). With this crowning tactical success to set against the Syrian reverses, he handed over the command to Kléber and returned to France (August 22) to ride the storm in a new *coup d'état*, the "18th Brumaire." Kléber, attacked by the English and Turks, concluded the convention of El Arish (January 27, 1800), whereby he secured free transport for the army back to France. But this convention was disavowed by the British government, and Kléber prepared to hold his ground. On the 20th of March 1800 he thoroughly defeated the Turkish army at Heliopolis and recovered Cairo, and French influence was once more in the ascendant in Egypt, when its director was murdered by a fanatic on the 14th of June, the day of Marengo. Kléber's successor, the incompetent Menou, fell an easy victim to the British expeditionary force under Sir Ralph Abercromby in 1801. The British forced their way ashore at Aboukir on the 8th of March. On the 21st, Abercromby won a decisive battle, and himself fell in the hour of victory (see *ALEXANDRIA: Battle of 1801*). His successor, General Hely Hutchinson, slowly followed up this advantage, and received the surrender of Cairo in July and of Alexandria in August, the debris of the French army being given free passage back to France. Meantime a mixed force of British and native troops from India, under Sir David Baird, had landed at Kosseir and marched across the desert to Cairo.

THE WAR OF THE SECOND COALITION

In the autumn of 1798, while Napoleon's Egyptian expedition was in progress, and the Directory was endeavouring at home to reduce the importance and the predominance of the army and its leaders, the powers of Europe once more allied themselves, not now against the principles of the Republic, but against the treaty of Campo Formio. Russia, Austria, England, Turkey, Portugal, Naples and the Pope formed the Second Coalition. The war began with an advance into the Roman States by a worthless and ill-behaved Neapolitan army (commanded, much against his will, by Mack), which the French troops under Championnet destroyed with ease. Championnet then revolutionized Naples. After this unimportant preludé the curtain rose on a general European war. The Directory which now had at its command neither numbers nor enthusiasm, prepared as best it could to

meet the storm. Four armies, numbering only 160,000, were set on foot, in Holland (Brune, 24,000); on the Upper Rhine (Jourdan, 46,000); in Switzerland, which had been militarily occupied in 1798 (Masséna, 30,000); and in upper Italy (Schérer, 60,000). In addition there was Championnet's army, now commanded by Macdonald, in southern Italy. All these forces the Directory ordered, in January and February 1799, to assume the offensive.

Jourdan, in the Constance and Schaffhausen region, had only 40,000 men against the archduke Charles's 80,000, and was soon brought to a standstill and driven back on Stokach. *Stokach.* The archduke had won these preliminary successes with seven-eighths of his army acting as one concentrated mass. But as he had only encountered a portion of Jourdan's army, he became uneasy as to his flanks, checked his bold advance, and ordered a reconnaissance in force. This practically extended his army while Jourdan was closing his, and thus the French began the battle of Stokach (March 25) in superior numbers, and it was not until late in the day that the archduke brought up sufficient strength (60,000) to win a victory. This was a battle of the "strategic" type, a widespread straggling combat in which each side took fifteen hours to inflict a loss of 12% on the other, and which ended in Jourdan accepting defeat and drawing off, unpursued by the magnificent Austrian cavalry, though these counted five times as many sabres as the French.

The French secondary army in Switzerland was in the hands of the bold and active Masséna. The forces of both sides in the Alpine region were, from a military point of view, mere flank guards to the main armies on the Rhine and the Adige. But unrest, amounting to civil war, among the Swiss and Grison peoples tempted both governments to give these flank guards considerable strength.¹

The Austrians in the Vorarlberg and Grisons were under Hotze, who had 13,000 men at Bregenz, and 7000 commanded by Auffenberg around Chur, with, between them, 5000 men at Feldkirch and a post of 1000 in the strong position of the Luziensteig near Mayenfeld. *Masséna in Switzerland.* Masséna's available force was about 20,000, and he used almost the whole of it against Auffenberg. The Rhine was crossed by his principal column near Mayenfeld, and the Luziensteig stormed (March 6), while a second column from the Zürich side descended upon Disentis and captured its defenders. In three days, thanks to Masséna's energy and the ardent attacking spirit of his men, Auffenberg's division was broken up, Oudinot meanwhile holding off Hotze by a hard-fought combat at Feldkirch (March 7). But a second attack on Feldkirch made on the 23rd by Masséna with 15,000 men was repulsed and the advance of his left wing came to a standstill.

Behind Auffenberg and Hotze was Bellegarde in Tirol with some 47,000 men. Most of these were stationed north of Innsbruck and Landeck, probably as a sort of strategic reserve to the archduke. The rest, with the assistance of the Tirolese themselves, were to ward off irruptions from Italy. Here the French offensive was entrusted to two columns, one from Masséna's command under Lecourbe, the other from the Army of Italy under Dessolle. Simultaneously with Masséna, Lecourbe marched from Bellinzona with 10,000 men, by the San Bernardino pass into the Splügen valley, and thence over the Julier pass into the upper Engadine. A small Austrian force under Major-General Loudon attacked him near Zernets, but was after three days of rapid manœuvres and bold tactics driven back to Martinsbrück, with considerable losses, especially in prisoners. But ere long the country people flew to arms, and Lecourbe found himself between two fires, the levies occupying Zernets and Loudon's regulars Martinsbrück. But though he had only some 5000 of his original force left, he was not discouraged, and, by driving back the levies into the high valleys whence they had come, and constantly threatening Loudon,

¹ The assumption by later critics (Clausewitz even included) that the "flank position" held by these forces relatively to the main armies in Italy and Germany was their *raison d'être* is unsupported by contemporary evidence.

he was able to maintain himself and to wait for Dessolles. The latter, moving up the Valtelline, by now fought his way to the Stelvio pass, but beyond it the defile of Tauffers (S.W. of Glurns) was entrenched by Loudon, who thus occupied a position midway between the two French columns, while his irregulars beset all the passes and ways giving access to the Vintschgau and the lower Engadine. In this situation the French should have been destroyed in detail. But as usual their speed and dash gave them the advantage in every manoeuvre and at every point of contact.

On the 25th Lecourbe and Dessolles attacked Loudon at Nauders in the Engadine and Tauffers in the Vintschgau respectively. At Nauders the French passed round the flanks of the defence by scrambling along the high mountain crests adjacent, while at Tauffers the assailants, only 4500 strong, descended into a deep ravine, debouched unnoticed in the Austrians' rear, and captured 6000 men and 16 guns. The Austrian leader with a couple of companies made his way through Glurns to Nauders, and there, finding himself headed off by Lecourbe, he took to the mountains. His corps, like Auffenberg's, was annihilated.

This ended the French general offensive. Jourdan had been defeated by the archduke and forced or induced to retire over the Rhine. Masséna was at a standstill before the strong position of Feldkirch, and the Austrians of Hotze were still massed at Bregenz, but the Grisons were revolutionized, two strong bodies of Austrians numbering in all about 20,000 men had been destroyed, and Lecourbe and Dessolles had advanced far into Tirol. A pause followed. The Austrians in the mountains needed time to concentrate and to recover from their astonishment. The archduke fell ill, and the Vienna war council forbade his army to advance lest Tirol should be "uncovered," though Bellegarde and Hotze still disposed of numbers equal to those of Masséna and Lecourbe. Masséna succeeded Jourdan in general command on the French side and promptly collected all available forces of both armies in the hilly non-Alpine country between Basel, Zürich and Schaffhausen, thereby directly barring the roads into France (Berne-Neuchâtel-Pontarlier and Basel-Besançon) which the Austrians appeared to desire to conquer. The protection of Alsace and the Vosges was left to the fortresses. There was no suggestion, it would appear, that the Rhine between Basel and Schaffhausen was a flank position sufficient of itself to bar Alsace to the enemy.

It is now time to turn to events in Italy, where the Coalition intended to put forth its principal efforts. At the beginning of March the French had 80,000 men in Upper Italy and some 35,000 in the heart of the Peninsula, the latter engaged chiefly in supporting newly-founded republics. Of the former, 53,000 formed the field army on the Mincio under Schérer. The Austrians, commanded by Kray, numbered in all 84,000, but detachments reduced this figure to 67,000, of whom, moreover, 15,000 had not yet arrived when operations began. They were to be joined by a Russian contingent under the celebrated Suvárov, who was to command the whole on arrival, and whose extraordinary personality gives the campaign its special interest. Kray himself was a resolute soldier, and when the French, obeying the general order to advance, crossed the Adige, he defeated them in a severely fought battle at Magnano near Verona (March 5), the French losing 4000 killed and wounded and 4500 taken, out of 41,000. The Austrians lost some 3800 killed and wounded and 1500 prisoners, out of 46,000 engaged. The war, however, was undertaken not to annihilate, but to evict the French, and, probably under orders from Vienna, Kray allowed the beaten enemy to depart.

Suvárov appeared with 17,000 Russians on the 4th of April. His first step was to set Russian officers to teach the Austrian troops—whose feelings can be imagined—how to attack with the bayonet, his next to order the whole army forward. The Allies broke camp on the 17th, 18th and 19th of April, and on the 20th, after a forced march of close on 30 m., they passed the Chiese. Brescia had a French garrison, but Suvárov soon cowed it into surrender by threats of a massacre, which no one doubted that he would carry into execution.

At the same time, dissatisfied with the marching of the Austrian infantry, he sent the following characteristic reproof to their commander: "The march was in the service of the Kaiser. Fair weather is for my lady's chamber, for dandies, for sluggards. He who dares to cavil against his high duty (*der Grosssprecher wider den hohen Dienst*) is, as an egoist, instantly to vacate his command. Whoever is in bad health can stay behind. The so-called reasoners (*raisonneurs*) do no army any good. . . ." One day later, under this unrelenting pressure, the advanced posts of the Allies reached Cremona and the main body the Oglio. The pace became slower in the following days, as many bridges had to be made, and meanwhile Moreau, Schérer's successor, prepared with a mere 20,000 men to defend Lodi, Cassano and Lecco on the Adda. On the 26th the Russian hero attacked him all along the line. The moral supremacy had passed over to the Allies. Melas, under Suvárov's stern orders, flung his battalions regardless of losses against the strong position of Cassano. The story of 1796 repeated itself with the rôles reversed. The passage was carried, and the French rearguard under Sérurier was surrounded and captured by an inferior corps of Austrians. The Austrians (the Russians at Lecco were hardly engaged) lost 6000 men, but they took 7000 prisoners, and in all Moreau's little army lost half its numbers and retreated in many disconnected bodies to the Ticino, and thence to Alessandria. Everywhere the Italians turned against the French, mindful of the exactions of their commissaries. The strange Cossack cavalry that western Europe had never yet seen entered Milan on the 29th of April, eleven days after passing the Mincio, and next day the city received with enthusiasm the old field marshal, whose exploits against the Turks had long invested him with a halo of romance and legend. Here, for the moment, his offensive culminated. He desired to pass into Switzerland and to unite his own, the archduke's, Hotze's and Bellegarde's armies in one powerful mass. But the emperor would not permit the execution of this scheme until all the fortresses held by the enemy in Upper Italy should have been captured. In any case, Macdonald's army in southern Italy, cut off from France by the rapidity of Suvárov's onslaught, and now returning with all speed to join Moreau by force or evasion, had still to be dealt with.

Suvárov's mobile army, originally 90,000 strong, had now dwindled, by reason of losses and detachments for sieges, to half that number, and serious differences arose between the Vienna government and himself. If he offended the pride of the Austrian army, he was at least respected as a leader who gave it victories, but in Vienna he was regarded as a madman who had to be kept within bounds. But at last, when he was becoming thoroughly exasperated by this treatment, Macdonald came within striking distance and the active campaign recommenced. In the second week of June, Moreau, who had retired into the Apennines about Gavi, advanced with the intention of drawing upon himself troops that would otherwise have been employed against Macdonald. He succeeded, for Suvárov with his usual rapidity collected 40,000 men at Alessandria, only to learn that Macdonald with 35,000 men was coming up on the Parma road. When this news arrived, Macdonald had already engaged an Austrian detachment at Modena and driven it back, and Suvárov found himself between Moreau and Macdonald with barely enough men under his hand to enable him to play the game of "interior lines." But at the crisis the rough energetic warrior who despised "*raisonneurs*," displayed generalship of the first order, and taking in hand all his scattered detachments, he manoeuvred them in the Napoleonic fashion.

On the 14th Macdonald was calculated to be between Modena, Reggio and Carpi, but his destination was uncertain. Would he continue to hug the Apennines to join Moreau, or would he strike out northwards against Kray, who with 20,000 men was besieging Mantua? From Alessandria it is four marches to Piacenza and nine to Mantua, while from Reggio these places are four and two marches respectively. Piacenza, therefore, was the crucial point. &

The
Tribune.

Macdonald continued westward, while, in the other case, nothing could save Kray but the energetic conduct of Hohenzollern's detachment, which was posted near Reggio. This latter, however, was soon forced over the Po, and Ott, advancing from Cremona to join it, found himself sharply pressed in turn. The field marshal had hoped that Ott and Hohenzollern together would be able to win him time to assemble at Parma, where he could bring on a battle whichever way the French took. But on receipt of Ott's report he was convinced that Macdonald had chosen the western route, and ordering Ott to delay the French as long as possible by stubborn rearguard actions and to put a garrison into Piacenza under a general who was to hold out "on peril of his life and honour," he collected what forces were ready to move and hurried towards Piacenza, the rest being left to watch Moreau. He arrived just in time. When after three forced marches the main body (only 26,000 strong) reached Castel San Giovanni, Ott had been driven out of Piacenza, but the two joined forces safely. Both Suvárov and Macdonald spent the 17th in closing up and deploying for battle. The respective forces were Allies 30,000, French 35,000. Suvárov viewed the enemy to be only 26,000 strong, and chiefly raw Italian regiments, but his temperament would not have allowed him to stand still even had he known his inferiority. He had already issued one of his peculiar battle-orders, which began with the words, "The hostile army will be taken prisoners" and continued with directions to the Cossacks to spare the surrendered enemy. But Macdonald too was full of energy, and believed still that he could annihilate Ott before the field marshal's arrival. Thus the battle of the Trebbia (June 17-19) was fought by both sides in the spirit of the offensive. It was one of the severest struggles in the Republican wars, and it ended in Macdonald's retreat with a loss of 15,000 men—probably 6000 in the battle and 9000 killed and prisoners when and after the equilibrium was broken—for Suvárov, unlike other generals, had the necessary surplus of energy after all the demands made upon him by a great battle, to order and to direct an effective pursuit. The Allies lost about 7000. Macdonald retreated to Parma and Modena, harassed by the peasantry, and finally recrossed the Apennines and made his way to Genoa. The battle of the Trebbia is one of the most clearly-defined examples in military history of the result of moral force—it was a matter not merely of energetic leading on the battlefield, but far more of educating the troops beforehand to meet the strain, of ingraining in the soldier the determination to win at all costs. "It was not," says Clausewitz, "a case of losing the key of the position, of turning a flank or breaking a centre, of a mistimed cavalry charge or a lost battery . . . it is a pure trial of strength and expense of force, and victory is the sinking of the balance, if ever so slightly, in favour of one side. And we mean not merely physical, but even more moral forces."

To return now to the Alpine region, where the French offensive had culminated at the end of March. Their defeated left was behind the Rhine in the northern part of Switzerland, the half-victorious centre athwart the Rhine between Mayenfeld and Chur, and their wholly victorious right far within Tirol between Glurns, Nauders and Landeck. But neither the centre nor the right could maintain itself. The forward impulse given by Suvárov spread along the whole Austrian front from left to right. Desolles' column (now under Loison) was forced back to Chiavenna. Bellegarde drove Lecourbe from position to position towards the Rhine during April. There Lecourbe added to the remnant of his expeditionary column the outlying bodies of Masséna's right wing, but even so he had only 8000 men against Bellegarde's 17,000, and he was now exposed to the attack of Hotze's 25,000 as well. The Luziensteig fell to Hotze and Chur to Bellegarde, but the defenders managed to escape from the converging Austrian columns into the valley of the Reuss. Having thus reconquered all the lost ground and forced the French into the interior of Switzerland, Bellegarde and Hotze parted company, the former marching with the greater part of his forces to join Suvárov, the latter moving to his right to reinforce the archduke. Only a chain of posts was left in the Rhine

Valley between Disentis and Feldkirch. The archduke's operations now recommenced.

Charles and Hotze stood, about the 15th of May, at opposite ends of the lake of Constance. The two together numbered about 88,000 men, but both had sent away numerous detachments to the flanks, and the main bodies dwindled to 35,000 for the archduke and 20,000 for Hotze. Masséna, with 45,000 men in all, retired slowly from the Rhine to the Thur. The archduke crossed the Rhine at Stein, Hotze at Balzers, and each then cautiously felt his way towards the other. Their active opponent attempted to take advantage of their separation, and an irregular fight took place in the Thur valley (May 25), but Masséna, finding Hotze close on his right flank, retired without attempting to force a decision. On the 27th, having joined forces, the Austrians dislodged Masséna from his new position on the Töss without difficulty, and this process was repeated from time to time in the next few days, until at last Masséna halted in the position he had prepared for defence at Zürich. He had still but 25,000 of his 45,000 men in hand, for he maintained numerous small detachments on his right, behind the Zürcher See and the Wallen See, and on his left towards Basel. These 25,000 occupied an entrenched position 5 m. in length; against which the Austrians, detaching as usual many posts to protect their flanks and rear, deployed only 42,000 men, of whom 8000 were sent on a wide turning movement and 8000 held in reserve 4 m. in rear of the battlefield. Thus the frontal attack was made with forces not much greater than those of the defence and it failed accordingly (June 4). But Masséna, fearing perhaps to strain the loyalty of the Swiss to their French-made constitution by exposing their town to assault and sack, retired on the 5th.

He did not fall back far, for his outposts still bordered the Limmat and the Linth, while his main body stood in the valley of the Aar between Baden and Lucerne. The archduke pressed Masséna as little as he had pressed Jourdan after Stokach (though in this case he had less to gain by pursuit), and awaited the arrival of a second Russian army, 30,000 strong, under Korsákov, before resuming the advance, meantime throwing out covering detachments towards Basel, where Masséna had a division. Thus for two months operations, elsewhere than in Italy, were at a standstill, while Masséna drew in reinforcements and organized the fractions of his forces in Alsace as a skeleton army, and the Austrians distributed arms to the peasantry of South Germany.

In the end, under pressure from Paris, it was Masséna who resumed active movements. Towards the middle of August, Lecourbe, who formed a loose right wing of the French army in the Reuss valley, was reinforced to a strength of 25,000 men, and pounced upon the extended left wing of the enemy, which had stretched itself, to keep pace with Suvárov, as far westward as the St Gothard. The movement began on the 14th, and in two days the Austrians were driven back from the St Gothard and the Furka to the line of the Linth, with the loss of 8000 men and many guns. At the same time an attempt to take advantage of Masséna's momentary weakness by forcing the Aar at Döttingen near its mouth failed completely (August 16-17). Only 200 men guarded the point of passage, but the Austrian engineers had neglected to make a proper examination of the river, and unlike the French, the Austrian generals had no authority to waste their expensive battalions in forcing the passage in boats. No one regarded this war as a struggle for existence, and no one but Suvárov possessed the iron strength of character to send thousands of men to death for the realization of a diplomatic success—for ordinary men, the object of the Coalition was to upset the treaty of Campo Formio. This was the end of the archduke's campaign in Switzerland. Though he would have preferred to continue it, the Vienna government desired him to return to Germany. An Anglo-Russian expedition was about to land in Holland,¹ and the French were assembling fresh forces on the Rhine, and, with the double object of preventing an invasion of

¹ For this expedition, which was repulsed by Brune in the battle of Castricum, see Fortescue's *Hist. of the British Army*, vol. iv., and Sachot's *Brune en Hollande*.

South Germany and of inducing the French to augment their forces in Alsace at the expense of those in Holland, the archduke left affairs in Switzerland to Hotze and Korsákov, and marched away with 35,000 men to join the detachment of Sarrary (20,000) that he had placed in the Black Forest before entering Switzerland. His new campaign never rose above the level of a war of posts and of manoeuvres about Mannheim and Philippsburg. In the latter stage of it Lecourbe commanded the French and obtained a slight advantage.

Suvárov's last exploit in Italy coincided in time, but in no other respect, with the skirmish at Döttingen. Returning swiftly from the battlefield of the Trebbia, he began to drive back Moreau to the Riviera. At this point Joubert succeeded to the command on the French side, and against the advice of his generals, gave battle. Equally against the advice of his own subordinates, the field marshal accepted it, and won his last great victory at Novi on the 13th of August, Joubert being killed. This was followed by another rapid march against a new French "Army of the Alps" (Championnet) which had entered Italy by way of the Mont Cenis. But immediately after this he left all further operations in Italy to Melas with 60,000 men and himself with the Russians and an Austrian corps marched away, via Varese, for the St Gothard to combine operations against Masséna with Hotze and Korsákov. It was with a heavy heart that he left the scene of his battles, in which the force of his personality had carried the old-fashioned "linear" armies for the last time to complete victory. In the early summer he had himself suggested, eagerly and almost angrily, the concentration of his own and the archduke's armies in Switzerland with a view, not to conquering that country, but to forcing Jourdan and Masséna into a grand decisive battle. But, as we have seen, the Vienna government would not release him until the last Italian fortress had been recaptured, and when finally he received the order that a little while before he had so ardently desired, it was too late. The archduke had already left Switzerland, and he was committed to a resultless warfare in the high mountains, with an army which was a mere detachment

Suvárov ordered to Switzerland. and in the hope of co-operating with two other detachments far away on the other side of Switzerland. As for the reasons which led to the issue of such an order, it can only be said that the bad feeling known to exist between the Austrians and Russians induced England to recommend, as the first essential of further operations, the separate concentration of the troops of each nationality under their own generals. Still stranger was the reason which induced the tsar to give his consent. It was alleged that the Russians would be healthier in Switzerland than the men of the southern plains! From such premises as these the Allied diplomats evolved a new plan of campaign, by which the Anglo-Russians under the duke of York were to reconquer Holland and Belgium, the Archduke Charles to operate on the Middle Rhine, Suvárov in Switzerland and Melas in Piedmont—a plan destitute of every merit but that of simplicity.

It is often said that it is the duty of a commander to resign rather than undertake an operation which he believes to be faulty. So, however, Suvárov did not understand it. In the simplicity of his loyalty to the formal order of his sovereign he prepared to carry out his instructions to the letter. Masséna's command (77,000 men) was distributed, at the beginning of September, along an enormous S, from the Simplon, through the St Gothard and Glarus, and along the Linth, the Züricher See and the Limmat to Basel. Opposite the lower point of this S, Suvárov (28,000) was about to advance. Hotze's corps (25,000 Austrians), extending from Utznach by Chur to Disentis, formed a thin line roughly parallel to the lower curve of the S, Korsákov's Russians (30,000) were opposite the centre at Zürich, while Nauendorff with a small Austrian corps at Waldshut faced the extreme upper point. Thus the only completely safe way in which Suvárov could reach the Zürich region was by skirting the lower curve of the S, under protection of Hotze. But this detour would be long and painful, and the ardent old man preferred to cross the mountains once for all at the St Gothard, and to follow the valley of the Reuss to Altdorf and Schwyz—i.e. to strike vertically

upward to the centre of the S—and to force his way through the French cordon to Zürich, and if events, so far as concerned his own corps, belied his optimism, they at any rate justified his choice of the shortest route. For, aware of the danger gathering in his rear, Masséna gathered up all his forces within reach towards his centre, leaving Lecourbe to defend the St Gothard and the Reuss valley and Sout on the Linth. On the 24th he forced the passage of the Limmat at Dietikon. On the 25th, in the second battle of Zürich, he completely routed Korsákov, who lost 8000 killed and wounded, large numbers of prisoners and 100 guns. All along the line the Allies fell back, one corps after another, at the moment when Suvárov was approaching the foot of the St Gothard.

On the 21st the field marshal's headquarters were at Bellinzona, where he made the final preparations. Expecting to be four days *en route* before he could reach the nearest friendly magazine, he took his trains with him, which inevitably augmented the difficulties of the expedition. On the 24th Airolo was taken, but when the far greater task of storming the pass itself presented itself before them, even the stolid Russians were terrified, and only the passionate protests of the old man, who reproached his "children" with deserting their father in his extremity, induced them to face the danger. At last after twelve hours' fighting, the summit was reached. The same evening Suvárov pushed on to Hospenthal, while a flanking column from Disentis made its way towards Amsteg over the Crispalt. Lecourbe was threatened in rear and pressed in front, and his engineers, to hold off the Disentis column, had broken the Devil's Bridge. Discovering this, he left the road, threw his guns into the river and made his way by fords and water-meadows to Göschenen, where by a furious attack he cleared the Disentis troops off his line of retreat. His rearguard meantime held the ruined Devil's Bridge. This point and the tunnel leading to it, called the Urner Loch, the Russians attempted to force, with the most terrible losses, battalion after battalion crowding into the tunnel and pushing the foremost ranks into the chasm left by the broken bridge. But at last a ford was discovered and the bridge, cleared by a turning movement, was repaired. More broken bridges lay beyond, but at last Suvárov joined the Disentis column near Göschenen. When Altdorf was reached, however, Suvárov found not only Lecourbe in a threatening position, but an entire absence of boats on the Lake of the Four Cantons. It was impossible (in those days the Axenstrasse did not exist) to take an army along the precipitous eastern shore, and thus passing through one trial after another, each more severe than the last, the Russians, men and horses and pack animals in an interminable single file, ventured on the path leading over the Kinzig pass into the Muotta Thal. The passage lasted three days, the leading troops losing men and horses over the precipices, the rearguard from the fire of the enemy, now in pursuit. And at last, on arrival in the Muotta Thal, the field marshal received definite information that Korsákov's army was no longer in existence. Yet even so it was long before he could make up his mind to retreat, and the pursuers gathered on all sides. Fighting, sometimes severe, and never altogether ceasing, went on day after day as the Allied column, now reduced to 15,000 men, struggled on over one pass after another, but at last it reached Ilanz on the Vorder Rhine (October 8). The Archduke Charles meanwhile had, on hearing of the disaster of Zürich, brought over a corps from the Neckar, and for some time negotiations were made for a fresh combined operation against Masséna. But these came to nothing, for the archduke and Suvárov could not agree, either as to their own relations or as to the plan to be pursued. Practically, Suvárov's retreat from Altdorf to Ilanz closed the campaign. It was his last active service, and formed a gloomy but grand climax to the career of the greatest soldier who ever wore the Russian uniform.

MARENGO AND HOHENLINDEN

The disasters of 1799 sealed the fate of the Directory, and placed Bonaparte, who returned from Egypt with the prestige of a recent victory, in his natural place as civil and military

head of France. In the course of the campaign the field strength of the French had been gradually augmented, and in spite of losses now numbered 227,000 at the front. These were divided into the Army of Batavia, Brune (25,000), the Army of the Rhine, Moreau (146,000), the Army of Italy, Masséna (56,000), and, in addition, there were some 100,000 in garrisons and depots in France.

Most of these field armies were in a miserable condition owing to the losses and fatigues of the last campaign. The treasury was empty and credit exhausted, and worse still—for spirit and enthusiasm, as in 1794, would have remedied material deficiencies—the conscripts obtained under Jourdan's law of 1798 (see CONSCRIPTION) came to their regiments most unwillingly. Most of them, indeed, deserted on the way to join the colours. A large draft sent to the Army of Italy arrived with 310 men instead of 10,250, and after a few such experiences, the First Consul decided that the untrained men were to be assembled in the fortresses of the interior and afterwards sent to the active battalions in numerous small drafts, which they could more easily assimilate. Besides accomplishing the immense task of reorganizing existing forces, he created new ones, including the Consular Guard, and carried out at this moment of crisis two such far-reaching reforms as the replacement of the civilian drivers of the artillery by soldiers, and of the hired teams by horses belonging to the state, and the permanent grouping of divisions in army corps.

As early as the 25th of January 1800 the First Consul provided for the assembly of all available forces in the interior in an "Army of Reserve." He reserved to himself the command of this army,¹ which gradually came into being as the pacification of Vendée and the return of some of Brune's troops from Holland set free the necessary nucleus troops. The conscription law was stringently re-enforced, and impassioned calls were made for volunteers (the latter, be it said, did not produce five hundred useful men). The district of Dijon, partly as being central with respect to the Rhine and Italian Armies, partly as being convenient for supply purposes, was selected as the zone of assembly. Chabran's division was formed from some depleted corps of the Army of Italy and from the depots of those in Egypt. Chambarlhac's, chiefly of young soldiers, lost 5% of its numbers on the way to Dijon from desertion—a loss which appeared slight and even satisfactory after the wholesale *débandade* of the winter months. Lechi's Italian legion was newly formed from Italian refugees. Boudet's division was originally assembled from some of the southern garrison towns, but the units composing it were frequently changed up to the beginning of May. The cavalry was deficient in saddles, and many of its units were new formations. The Consular Guard of course was a *corps d'élite*, and this and two and a half infantry divisions and a cavalry brigade coming from the veteran "Army of the West" formed the real backbone of the army. Most of the newer units were not even armed till they had left Dijon for the front.

Such was the first constitution of the Army of Reserve. We can scarcely imagine one which required more accurate and detailed staff work to assemble it—correspondence with the district commanders, with the adjutant-generals of the various armies, and orders to the civil authorities on the lines of march, to the troops themselves and to the arsenals and magazines. No one but Napoleon, even aided by a Berthier, could have achieved so great a task in six weeks, and the great captain, himself doing the work that nowadays is apportioned amongst a crowd of administrative staff officers, still found time to administer France's affairs at home and abroad, and to think out a general plan of campaign that embraced Moreau's, Masséna's and his own armies.

The Army of the Rhine, by far the strongest and best equipped, lay on the upper Rhine. The small and worn-out Army of Italy was watching the Alps and the Apennines from Mont Blanc to

¹ He afterwards appointed Berthier to command the Army of Reserve, but himself accompanied it and directed it, using Berthier as chief of staff.

Genoa. Between them Switzerland, secured by the victory of Zürich, offered a starting-point for a turning movement on either side—this year the advantage of the flank position was recognized and acted upon. The Army of Reserve was assembling around Dijon, within 200 m. of either theatre of war. The general plan was that the Army of Reserve should march through Switzerland to close on the right wing of the Army of the Rhine. Thus supported to whatever degree might prove to be necessary, Moreau was to force the passage of the Rhine about Schaffhausen, to push back the Austrians rapidly beyond the Lech, and then, if they took the offensive in turn, to hold them in check for ten or twelve days. During this period of guaranteed freedom the decisive movement was to be made. The Army of Reserve, augmented by one large corps of the Army of the Rhine, was to descend by the Splügen (alternatively by the St Gothard and even by Tirol) into the plains of Lombardy. Magazines were to be established at Zürich and Lucerne (not at Chur, lest the plan should become obvious from the beginning), and all likely routes reconnoitred in advance. The Army of Italy was at first



to maintain a strict defensive, then to occupy the Austrians until the entry of the Reserve Army into Italy was assured, and finally to manoeuvre to join it.

Moreau, however, owing to want of horses for his pontoon train and also because of the character of the Rhine above Basel, preferred to cross below that place, especially as in Alsace there were considerably greater supply facilities than in a country which had already been fought over and stripped bare. With the greatest reluctance Bonaparte let him have his way, and giving up the idea of using the Splügen and the St Gothard, began to turn his attention to the more westerly passes, the St Bernard and the Simplon. It was not merely Moreau's scruples that led to this essential modification in the scheme. At the beginning of April the enemy took the offensive against Masséna. On the 8th Melas's right wing dislodged the French from the Mont Cenis, and most of the troops that had then reached Dijon were shifted southward to be ready for emergencies. By the 25th Berthier reported that Masséna was seriously attacked and that he might have to be supported by the shortest route. Bonaparte's resolution was already taken. He waited no longer for Moreau

(who indeed so far from volunteering assistance, actually demanded it for himself). Convinced from the paucity of news that Masséna's army was closely pressed and probably severed from France, and feeling also that the Austrians were deeply committed to their struggle with the Army of Italy, he told Berthier to march with 40,000 men at once by way of the St Bernard unless otherwise advised. Berthier protested that he had only 25,000 effectives, and the equipment and armament was still far from complete—as indeed it remained to the end—but the troops marched, though their very means of existence were precarious from the time of leaving Geneva to the time of reaching Milan, for nothing could extort supplies and money from the sullen Swiss.

At the beginning of May the First Consul learned of the serious plight of the Army of Italy. Masséna with his right wing was shut up in Genoa, Suchet with the left wing driven back to the Var. Meanwhile Moreau had won a preliminary victory at Stokach, and the Army of Reserve had begun its movement to Geneva. With these data the plan of campaign took a clear shape at last—Masséna to resist as long as possible, Suchet to resume the offensive, if he could do so, towards Turin; the Army of Reserve to pass the Alps and to debouch into Piedmont by Aosta; the Army of the Rhine to send a strong force into Italy by the St Gothard. The First Consul left Paris on the 6th of May. Berthier went forward to Geneva, and still farther on the route magazines were established at Villeneuve and St-Pierre. Gradually, and with immense efforts, the leading troops of the long column¹ were passed over the St Bernard, drawing their artillery on sledges, on the 15th and succeeding days. Driving away small posts of the Austrian army, the advance guard entered Aosta on the 16th and Châtillon on the 18th and the alarm was given. Melas, committed as he was to his Riviera campaign, began to look to his right rear, but he was far from suspecting the seriousness of his opponent's purpose.

Infinitely more dangerous for the French than the small detachment that Melas opposed to them, or even the actual crossing of the pass, was the unexpected stopping power of the little fort of Bard. The advanced guard of the French appeared before it on the 19th, and after three wasted days the infantry managed to find a difficult mountain by-way and to pass round the obstacle. Ivrea was occupied on the 23rd, and Napoleon hoped to assemble the whole army there by the 27th. But except for a few guns that with infinite precautions were smuggled one by one through the streets of Bard, the whole of the artillery, as well as a detachment (under Chabran) to besiege the fort, had to be left behind. Bard surrendered on the 2nd of June, having delayed the infantry of the French army for four days and the artillery for a fortnight.

The military situation in the last week of May, as it presented itself to the First Consul at Ivrea, was this. The Army of Italy under Masséna was closely besieged in Genoa, where provisions were running short, and the population so hostile that the French general placed his field artillery to sweep the streets. But Masséna was no ordinary general, and the First Consul knew that while Masséna lived the garrison would resist to the last extremity. Suchet was defending Nice and the Var by vigorous minor operations. The Army of Reserve, the centre of which had reached at Ivrea the edge of the Italian plains, consisted of four weak army corps under Victor, Duhesme, Lannes and Murat. There were still to be added to this small army of 34,000 effectives, Turreau's division, which had passed over the Mont Cenis and was now in the valley of the Dora Riparia, Monecy's corps of the Army of the Rhine, which had at last been extorted from Moreau and was due to pass the St Gothard before the end of May, Chabran's division left to besiege Bard, and a small force under Bèthencourt, which was to cross the Simplon and to descend by Arona (this place proved in the event a second Bard and immobilized Bèthencourt until after the decisive battle). Thus it was only the simplest part of Napoleon's task to concentrate half of his army at Ivrea, and he had yet to bring

¹ Only one division of the main body used the Little St Bernard.

in the rest. The problem was to reconcile the necessity for time, which he wanted to ensure the maximum force being brought over the Alps, with the necessity for haste, in view of the impending fall of Genoa and the probability that once this conquest was achieved, Melas would bring back his 100,000 men into the Milanese to deal with the Army of Reserve. As early as the 14th of May he had informed Monecy that from Ivrea the Army of Reserve would move on Milan. On the 25th of May, in response to Berthier's request for guidance, the First Consul ordered Lannes (advanced guard) to push out on the Turin road, "in order to deceive the enemy and to obtain news of Turreau," and Duhesme's and Murat's corps to proceed along the Milan road. On the 27th, after Lannes had on the 26th defeated an Austrian column near Chivasso, the main body was already advancing on Vercelli.

Very few of Napoleon's acts of generalship have been more criticized than this resolution to march on Milan, which abandoned Genoa to its fate and gave Melas a week's leisure to assemble his scattered forces. The account of his motives he dictated at St Helena (*Nap. Correspondence*, v. 30, pp. 375-377), in itself an unconvincing appeal to the rules of strategy as laid down by the theorists—which rules his own practice throughout transcended—gives, when closely examined, some at least of the necessary clues. He says in effect that by advancing directly on Turin he would have "risked a battle against equal forces without an assured line of retreat, Bard being still uncaptured." It is indeed strange to find Napoleon shrinking before equal forces of the enemy, even if we admit without comment that it was more difficult to pass Bard the second time than the first. The only incentive to go towards Turin was the chance of partial victories over the disconnected Austrian corps that would be met in that direction, and this he deliberately set aside. Having done so, for reasons that will appear in the sequel, he could only defend it by saying in effect that he might have been defeated—which was true, but not the Napoleonic principle of war. Of the alternatives, one was to hasten to Genoa, this in Napoleon's eyes would have been playing the enemy's game, for they would have concentrated at Alessandria, facing west "in their natural position." It is equally obvious that thus the enemy would have played his game, supposing that this was to relieve Genoa, and the implication is that it was not. The third course, which Napoleon took, and in this memorandum defended, gave his army the enemy's depots at Milan, of which it unquestionably stood in sore need, and the reinforcement of Monecy's 15,000 men from the Rhine, while at the same time Monecy's route offered an "assured line of retreat" by the Simplon² and the St Gothard. He would in fact make for himself there a "natural position" without forfeiting the advantage of being in Melas's rear. Once possessed of Milan, Napoleon says, he could have engaged Melas with a light heart and with confidence in the greatest possible results of a victory, whether the Austrians sought to force their way back to the east by the right or the left bank of the Po, and he adds that if the French passed on and concentrated south of the Po there would be no danger to the Milan-St Gothard line of retreat, as this was secured by the rivers Ticino and Sesia. In this last, as we shall see, he is shielding an undeniable mistake, but considering for the moment only the movement to Milan, we are justified in assuming that his object was not the relief of Genoa, but the most thorough defeat of Melas's field army, to which end, putting all sentiment aside, he treated the hard-pressed Masséna as a "containing force" to keep Melas occupied during the strategical deployment of the Army of Reserve. In the beginning he had told Masséna that he would "disengage" him, even if he had to go as far east as Trent to find a way into Italy. From the first, then, no direct relief was intended, and when, on hearing bad news from the Riviera, he altered his route to the more westerly passes, it was probably because he felt that Masséna's containing power was almost exhausted, and that the passage and reassembly of the Reserve Army must be brought about in the minimum time and by the shortest way. But the object was still the defeat of Melas, and for this, as the Austrians possessed an enormous numerical superiority, the assembly of all forces, including Monecy's, was indispensable. One essential condition of this was that the points of passage used should be out of reach of the enemy. The more westerly the passes chosen, the more dangerous was the whole operation—in fact the Mont Cenis column never reached him at all—and though his expressed objections to the St Bernard line seem, as we have said, to be written after the event, to disarm his critics, there is no doubt that at the time he disliked it. It was a *pis aller* forced upon him by Moreau's delay and Masséna's extremity, and from the moment at which he arrived at Milan he did, as a fact, abandon it altogether in favour of the St Gothard. Lastly, so strongly was he impressed with the necessity of completing the deployment of all his forces, that though he found the Austrians on the Turin side much scattered and could justifiably expect a series of rapid

² When he made his decision he was unaware that Bèthencourt had been held up at Arona.

partial victories, Napoleon let them go, and devoted his whole energy to creating for himself a "natural" position about Milan. If he sinned, at any rate he sinned handsomely, and except that he went to Milan by Vercelli instead of by Lausanne and Domodossola¹ (on the safe side of the mountains), his march is logistically beyond cavil.

Napoleon's immediate purpose, then, was to reassemble the Army of Reserve in a zone of manoeuvre about Milan. This was carried out in the first days of June. Lannes at Chivasso stood ready to ward off a flank attack until the main army had filed past on the Vercelli road, then leaving a small force to combine with Turreau (whose column had not been able to advance into the plain) in demonstrations towards Turin, he moved off, still acting as right flank guard to the army, in the direction of Pavia. The main body meanwhile, headed by Murat, advanced on Milan by way of Vercelli and Magenta, forcing the passage of the Ticino on the 31st of May at Turbigo and Bufalora. On the same day the other divisions closed up to the Ticino,² and faithful to his principles Napoleon had an examination made of the little fortress of Novara, intending to occupy it as a *place du moment* to help in securing his zone of manoeuvre. On the morning of the 2nd of June Murat occupied Milan, and in the evening of the same day the headquarters entered the great city, the Austrian detachment under Vukassovich (the flying right wing of Melas's general cordon system in Piedmont) retiring to the Adda. Duhesme's corps forced that river at Lodi, and pressed on with orders to organize Crema and if possible Orzinovi as temporary fortresses. Lechi's Italians were sent towards Bergamo and Brescia. Lannes meantime had passed Vercelli, and on the evening of the 2nd his cavalry reached Pavia, where, as at Milan, immense stores of food, equipment and warlike stores were seized.

Napoleon was now safe in his "natural" position, and barred one of the two main lines of retreat open to the Austrians. But his ambitions went further, and he intended to cross the Po and to establish himself on the other likewise, thus establishing across the plain a complete barrage between Melas and Mantua. Here his end outranged his means, as we shall see. But he gave himself every chance that rapidity could afford him, and the moment that some sort of a "zone of manoeuvre" had been secured between the Ticino and the Oglio, he pushed on his main body—or rather what was left after the protective system had been provided for—to the Po. He would not wait even for his guns, which had at last emerged from the Bard defile and were ordered to come to Milan by a safe and circuitous route along the foot of the Alps.

At this point the action of the enemy began to make itself felt. Melas had not gained the successes that he had expected in Piedmont and on the Riviera, thanks to Masséna's obstinacy and to Suchet's brilliant defence of the Var. These operations had led him very far afield, and the protection of his over-long line of communications had caused him to weaken his large army by throwing off many detachments to watch the Alpine valleys on his right rear. One of these successfully opposed Turreau in the valley of the Dora Riparia, but another had been severely handled by Lannes at Chivasso, and a third (Vukassovich) found itself, as we know, directly in the path of the French as they moved from Ivrea to Milan, and was driven far to the eastward. He was further handicapped by the necessity of supporting Ott before Genoa and Elsnitz on the Var, and hearing of Lannes's bold advance on Chivasso and of the presence of a French column with artillery (Turreau) west of Turin, he assumed that the latter represented the main body of the Army of Reserve—in so far indeed as he believed in the existence of that army at all.³ Next, when

¹ This may be accounted for by the fact that Napoleon's mind was not yet definitively made up when his advanced guard had already begun to climb the St Bernard (12th). Napoleon's instructions for Moncey were written on the 14th. The magazines, too, had to be provided and placed before it was known whether Moreau's detachment would be forthcoming.

² Six guns had by now passed Fort Bard and four of these were with Murat and Duhesme, two with Lannes.

³ It is supposed that the foreign spies at Dijon sent word to their various employers that the Army was a bogey. In fact a great part of it never entered Dijon at all, and the troops reviewed there by

Lannes moved away towards Pavia, Melas thought for a moment that fate had delivered his enemy into his hands, and began to collect such troops as were at hand at Turin with a view to cutting off the retreat of the French on Ivrea while Vukassovich held them in front. It was only when news came of Moncey's arrival in Italy and of Vukassovich's fighting retreat on Brescia that the magnitude and purpose of the French column that had penetrated by Ivrea became evident. Melas promptly decided to give up his western enterprises, and to concentrate at Alessandria, preparatory to breaking his way through the network of small columns—as the disseminated Army of Reserve still appeared to be—which threatened to bar his retreat. But orders circulated so slowly that he had to wait in Turin till the 8th of June for Elsnitz, whose retreat was, moreover, sharply followed up and made exceedingly costly by the enterprising Suchet. Ott, too, in spite of orders to give up the siege of Genoa at once and to march with all speed to hold the Alessandria-Piacenza road, waited two days to secure the prize, and agreed (June 4) to allow Masséna's army to go free and to join Suchet. And lastly, the cavalry of O'Reilly, sent on ahead from Alessandria to the Stradella defile, reached that point only to encounter the French. The barrage was complete, and it remained for Melas to break it with the mass that he was assembling, with all these misfortunes and delays, about Alessandria. His chances of doing so were anything but desperate.

On the 5th of June Murat, with his own corps and part of Duhesme's, had moved on Piacenza, and stormed the bridge-head there. Duhesme with one of his divisions pushed out on Crema and Orzinovi and also towards Pizzighetone. Lannes's leading regiments approached Milan, and Berthier thereupon sent on Victor's corps to support Murat and Lannes. Meantime the half abandoned line of operations, Ivrea-Vercelli, was briskly attacked by the Austrians, who had still detachments on the side of Turin, waiting for Elsnitz to rejoin, and the French artillery train was once more checked. On the 6th Lannes from Pavia, crossing the Po at San Cipriano, encountered and defeated a large force, (O'Reilly's column), and barred the Alessandria-Parma main road. Opposite Piacenza Murat had to spend the day in gathering material for his passage, as the pontoon bridge had been cut by the retreating garrison of the bridge-head. On the eastern border of the "zone of manoeuvre" Duhesme's various columns moved out towards Brescia and Cremona, pushing back Vukassovich. Meantime the last divisions of the Army of Reserve (two of Moncey's excepted) were hurried towards Lannes's point of passage, as Murat had not yet secured Piacenza. On the 7th, while Duhesme continued to push back Vukassovich and seized Cremona, Murat at last captured Piacenza, finding there immense magazines. Meantime the army, division by division, passed over, slowly owing to a sudden flood, near Belgiojoso, and Lannes's advanced guard was ordered to open communication with Murat along the main road Stradella-Piacenza. "Moments are precious" said the First Consul. He was aware that Elsnitz was retreating before Suchet, that Melas had left Turin for Alessandria, and that heavy forces of the enemy were at or east of Tortona. He knew, too, that Murat had been engaged with certain regiments recently before Genoa and (wrongly) assumed O'Reilly's column, beaten by Lannes at San Cipriano, to have come from the same quarter. Whether this meant the deliverance or the surrender of Genoa he did not yet know, but it was certain that Masséna's holding action was over, and that Melas was gathering up his forces to recover his communications. Hence Napoleon's great object was concentration. "Twenty thousand men at Stradella," in his own words, was the goal of his efforts, and with the accomplishment of this purpose the campaign enters on a new phase.

On the 8th of June, Lannes's corps was across, Victor following as quickly as the flood would allow. Murat was at Piacenza, but the road between Lannes and Murat was not known to be clear, and the First Consul made the establishment of the Bonaparte were only conscripts and details. By the time that the veteran divisions from the west and Paris arrived, either the spies had been ejected or their news was sent off too late to be of use.

connexion, and the construction of a third point of passage mid-way between the other two, the principal objects of the day's work. The army now being disseminated between the

Napoleon's dispositions.

Alps, the Apennines, the Ticino and the Chièse, it was of vital importance to connect up the various parts into a well-balanced system. But the Napoleon of 1800 solved the problem that lay at the root of his strategy, "concentrate, but be vulnerable nowhere," in a way that compares unfavourably indeed with the methods of the Napoleon of 1806. Duhesme was still absent at Cremona. Lechi was far away in the Brescia country, Bèthencourt detained at Arona. Moncey with about 15,000 men had to cover an area of 40 m. square around Milan, which constituted the original zone of manœuvre, and if Melas chose to break through the flimsy cordon of outposts on this side (the risk of which was the motive for detaching Moncey at all) instead of at the Stradella, it would take Moncey two days to concentrate his force on any battlefield within the area named, and even then he would be outnumbered by two to one. As for the main body at the Stradella, its position was wisely chosen, for the ground was too cramped for the deployment of the superior force that Melas might bring up, but the strategy that set before itself as an object 20,000 men at the decisive point out of 50,000 available, is, to say the least, imperfect. The most serious feature in all this was the injudicious order to Lannes to send forward his advanced guard, and to attack whatever enemy he met with on the road to Voghera. The First Consul, in fact, calculated that Melas could not assemble 20,000 men at Alessandria before the 12th of June, and he told Lannes that if he met the Austrians towards Voghera, they could not be more than 10,000 strong. A later order betrays some anxiety as to the exactitude of these assumptions, warns Lannes not to let himself be surprised, indicates his line of retreat, and, instead of ordering him to advance on Voghera, authorizes him to attack any corps that presented itself at Stradella. But all this came too late. Acting on the earlier order Lannes fought the battle of Montebello on the 9th. This

Montebello.

was a very severe running fight, beginning east of Casteggio and ending at Montebello, in which the French drove the Austrians from several successive positions, and which culminated in a savage fight at close quarters about Montebello itself. The singular feature of the battle is the disproportion between the losses on either side—French, 500 out of 12,000 engaged; Austrians, 2100 killed and wounded and 2100 prisoners out of 14,000. These figures are most conclusive evidence of the intensity of the French military spirit in those days. One of the two divisions (Watrin's) was indeed a veteran organization, but the other, Chambarlhac's, was formed of young troops and was the same that, in the march to Dijon, had congratulated itself that only 5% of its men had deserted. On the other side the soldiers fought for "the honour of their arms"—not even with the courage of despair, for they were ignorant of the "strategic barrage" set in front of them by Napoleon, and the loss of their communications had not as yet lessened their daily rations by an ounce.

Meanwhile, Napoleon had issued orders for the main body to stand fast, and for the detachments to take up their definitive covering positions. Duhesme's corps was directed, from its eastern foray, to Piacenza, to join the main body. Moncey was to provide for the defence of the Ticino line, Lechi to form a "flying camp" in the region of Orzinovi-Brescia and Cremona, and another mixed brigade was to control the Austrians in Pizzighetone and in the citadel of Piacenza. On the other side of the Po, between Piacenza and Montebello, was the main body (Lannes, Murat and part of Victor's and Duhesme's corps), and a flank guard was stationed near Pavia, with orders to keep on the right of the army as it advanced (this is the first and only hint of any intention to go westward) and to fall back fighting should Melas come on by the left bank. One division was to be always a day's march behind the army on the right bank, and a flotilla was to ascend the Po, to facilitate the speedy reinforcement of the flank guard. Farther to the north was a small column on the road Milan-Vercelli. All the protective troops,

except the division of the main body detailed as an eventual support for the flank guard, was to be found by Moncey's corps (which had besides to watch the Austrians in the citadel of Milan) and Chabran's and Lechi's weak commands. On this same day Bonaparte tells the Minister of War, Carnot, that Moncey has only brought half the expected reinforcements and that half of these are unreliable. As to the result of the impending contest Napoleon counts greatly upon the union of 18,000 men under Masséna and Suchet to crush Melas against the "strategic barrage" of the Army of Reserve, by one or other bank of the Po, and he seems equally confident of the result in either case. If Genoa had held out three days more, he says, it would have been easy to count the number of Melas's men who escaped. The exact significance of this last notion is difficult to establish, and all that could be written about it would be merely conjectural. But it is interesting to note that, without admitting it, Napoleon felt that his "barrage" might not stand before the flood. The details of the orders of the 9th to the main body (written before the news of Montebello arrived at headquarters) tend to the closest possible concentration of the main body towards Casteggio, in view of a decisive battle on the 12th or 13th.

But another idea had begun to form itself in his mind. Still believing that Melas would attack him on the Stradella side, and hastening his preparations to meet this, he began to allow for the contingency of Melas giving up or failing in his attempt to re-establish his communication with the *Napoleon's advance.* Mantovese, and retiring on Genoa, which was now in his hands and could be provisioned and reinforced by sea. On the 10th Napoleon ordered reserve ammunition to be sent

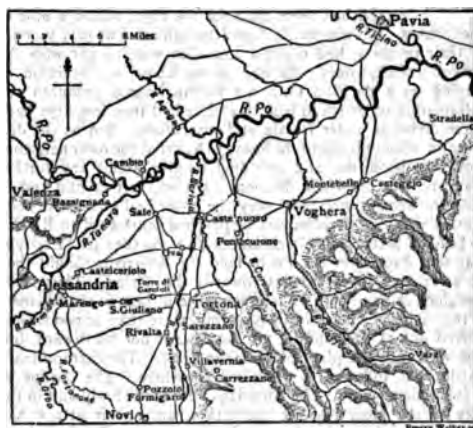

from Pavia, giving Serravalle, which is south of Novi, as its probable destination. But this was surmise, and of the facts he knew nothing. Would the enemy move east on the Stradella, north-east on the Ticino or south on Genoa? Such reports as were available indicated no important movements whatever, which happened to be true, but could hardly appear so to the French headquarters. On the 11th, though he thereby forfeited the reinforcements coming up from Duhesme's corps at Cremona, Napoleon ordered the main body to advance to the Scrivia. Lapoye's division (the right flank guard), which was observing the Austrian posts towards Casale, was called to the south bank of the Po, the zone around Milan was stripped so bare of troops that there was no escort for the prisoners taken at Montebello, while information sent by Chabran (now moving up from Ivrea) as to the construction of bridges at Casale (this was a feat made by Melas on the 10th) passed unheeded. The crisis was at hand, and, clutching at the reports collected by Lapoye as to the quietude of the Austrians toward Valenza and Casale, Bonaparte and Berthier strained every nerve to bring up more men to the

Voghera side in the hope of preventing the prey from slipping away to Genoa.

On the 12th, consequently, the army (the *ordre de bataille* of which had been considerably modified on the 11th) moved to the Scrvia, Lannes halting at Castelnuovo, Desaix (who had just joined the army from Egypt) at Pontecurone, Victor at Tortona with Murat's cavalry in front towards Alessandria. Lapoype's division, from the left bank of the Po, was marching in all haste to join Desaix. Moncey, Dubesme, Lechi and Chabran were absent. The latter represented almost exactly half of Berthier's command (30,000 out of 58,000), and even the concentration of 28,000 men on the Scrvia had only been obtained by practically giving up the "barrage" on the left bank of the Po. Even now the enemy showed nothing but a rearguard, and the old questions reappeared in a new and acute form. Was Melas still in Alessandria? Was he marching on Valenza and Casale to cross the Po? or to Acqui against Suchet, or to Genoa to base himself on the British fleet? As to the first, why had he given up his chances of fighting on one of the few cavalry battlegrounds in north Italy—the plain of Marengo—since he could not stay in Alessandria for any indefinite time? The second question had been answered in the negative by Lapoype, but his latest information was thirty-six hours old. As for the other questions, no answer whatever was forthcoming, and the only course open was to postpone decisive measures and to send forward the cavalry, supported by infantry, to gain information.

On the 13th, therefore, Murat, Lannes and Victor advanced into the plain of Marengo, traversed it without difficulty and carrying the villages held by the Austrian rearguard, established themselves for the night within a mile of the fortress. But meanwhile Napoleon, informed we may suppose of their progress, had taken a step that was fraught with the gravest consequences. He had, as we know, no intention of forcing on a decision until his reconnaissance produced the information on which to base it, and he had therefore kept back three divisions under Desaix at Pontecurone. But as the day wore on without incident, he began to fear that the reconnaissance would be profitless, and unwilling to give Melas any further start, he sent out these divisions right and left to find and to hold the enemy, whichever way the latter had gone. At noon Desaix with one division was despatched southward to Rivalta to head off Melas from Genoa and at 9 A.M. on the 14th, Lapoype was sent back over the Po to hold the Austrians should they be advancing from Valenza towards the Ticino. Thus there remained in hand only 21,000 men when at last, in the forenoon of the 14th the whole of Melas's army, more than 40,000 strong, moved out of Alessandria, not southward nor northward, but due west into the plain of Marengo (*q.v.*). The extraordinary battle that followed is described elsewhere. The outline of it is simple enough. The Austrians advanced slowly and in the face of the most resolute opposition, until their attack had gathered weight, and at last they were carrying all before them, when Desaix returned from beyond Rivalta and initiated a series of counterstrokes. These were brilliantly successful, and gave the French not only local victory but the supreme self-confidence that, next day, enabled them to extort from Melas an agreement to evacuate all Lombardy as far as the Mincio. And though in this way the chief prize, Melas's army, escaped after all, Marengo was the birthday of the First Empire.

One more blow, however, was required before the Second Coalition collapsed, and it was delivered by Moreau. We have seen that he had crossed the upper Rhine and defeated Kray at Stokach. This was followed by other partial victories, and Kray then retired to Ulm, where he reassembled his forces, hitherto scattered in a long weak line from the Neckar to Schaffhausen. Moreau continued his advance, extending his forces up to and over the Danube below Ulm, and winning several combats, of which the most important was that of Höchstädt,

¹ On the strength of a report, false as it turned out, that the Austrian rearguard had broken the bridges of the Bormida.

fought on the famous battlegrounds of 1703 and 1704, and memorable for the death of La Tour d'Auvergne, the "First Grenadier of France" (June 19). Finding himself in danger of envelopment, Kray now retired, swiftly and skillfully, across the front of the advancing French, and reached Ingolstadt in safety. Thence he retreated over the Inn, Moreau following him to the edge of that river, and an armistice put an end for the moment to further operations.

This not resulting in a treaty of peace, the war was resumed both in Italy and in Germany. The Army of Reserve and the Army of Italy, after being fused into one, under Masséna's command, were divided again into a fighting army under Bruce, who opposed the Austrians (Bellegarde) on the Mincio, and a political army under Murat, which re-established French influence in the Peninsula. The former, extending on a wide front as usual, won a few strategical successes without tactical victory, the only incidents of which worth recording are the gallant fight of Dupont's division, which had become isolated during a manoeuvre, at Pozzolo on the Mincio (December 25) and the descent of a corps under Macdonald from the Grisons by way of the Splügen, an achievement far surpassing Napoleon's and even Suvárov's exploits, in that it was made after the winter snows had set in.

In Germany the war for a moment reached the sublime. Kray had been displaced in command by the young archduke John, who ordered the denunciation of the armistice and a general advance. His plan, or that of his advisers, was to cross the lower Inn, out of reach of Moreau's principal mass, and then to swing round the French flank until a complete chain was drawn across their rear. But during the development of the manoeuvre, Moreau also moved, and by rapid marching made good the time he had lost in concentrating his over-dispersed forces. The weather was appalling, snow and rain succeeding one another until the roads were almost impassable. On the 2nd of December the Austrians were brought to a standstill, but the inherent mobility of the Revolutionary armies enabled them to surmount all difficulties, and thanks to the respite afforded him by the archduke's halt, Moreau was able to see clearly into the enemy's plans and dispositions. On the 3rd of December, while the Austrians in many disconnected columns were struggling through the dark and muddy forest paths about Hohenlinden, Moreau struck the decisive blow. While Ney and Grouchy held fast the head of the Austrian main column at Hohenlinden, Richepanse's corps was directed on its left flank. In the forest Richepanse unexpectedly met a subsidiary Austrian column which actually cut his column in two. But profiting by the momentary confusion he drew off that part of his forces which had passed beyond the point of contact and continued his march, striking the flank of the archduke's main column, most of which had not succeeded in deploying opposite Ney, at the village of Mattempost. First the baggage train and then the artillery park fell into his hands, and lastly he reached the rear of the troops engaged opposite Hohenlinden, whereupon the Austrian main body practically dissolved. The rear of Richepanse's corps, after disengaging itself from the Austrian column it had met in the earlier part of the day, arrived at Mattempost in time to head off thousands of fugitives who had escaped from the carnage at Hohenlinden. The other columns of the unfortunate army were first checked and then driven back by the French divisions they met, which, moving more swiftly and fighting better in the broken ground and the woods, were able to combine two brigades against one wherever a fight developed. On this disastrous day the Austrians lost 20,000 men, 12,000 of them being prisoners, and 90 guns.

Marengo and Hohenlinden decided the war of the Second Coalition as Rivoli had decided that of the First, and the Revolutionary Wars came to an end with the armistice of Steyer (December 25, 1800) and the treaty of Lunéville (February 9, 1801). But only the first act of the great drama was accomplished. After a short respite Europe entered upon the Napoleonic Wars.

Hohen-
linden.

BIBLIOGRAPHY.—By far the most important modern works are A. Chuquet's *Guerres de la Révolution* (11 monographs forming together a complete history of the campaigns of 1792-93), and the publications of the French General Staff. The latter appear first, as a rule, in the official "Revue d'histoire" and are then republished in separate volumes, of which every year adds to the number. V. Dupuis' *L'Armée du nord 1793*; Coutanceau's *L'Armée du nord 1793*; J. Colin's *Éducation militaire de Napoléon et Campagne de 1793 en Alsace*; and C. de Cugnac's *Campagne de l'armée de réserve 1800* may be specially named. Among other works of importance the principal are C. von B(ünder)-K(riegsfeld), *Geist und Stoff im Kriege* (Vienna, 1896); E. Gachot's works on Masséna's career (containing invaluable evidence though written in a somewhat rhetorical style); Ritter von Angeli, *Erzherzog Karl* (Vienna, 1896); F. N. Maude, *Evolution of Modern Strategy*; G. A. Furne, *Morwigo and Hohenlinden*; C. von Clausewitz, *Feldzug 1796 in Italien und Feldzug 1799* (French translations); H. Bonnal, *De Ratbach à Ulm*; Krebs and Moris, *Campagnes dans les Alpes* (Paris, 1891-1895); Yorck von Wartenburg, *Napoléon als Feldherr* (English and French translations); F. Bouvier, *Bonaparte en Italie 1796*; Kuhl, *Bonaparte's erster Feldzug*; J. W. Fortescue, *Hist. of the British Army*, vol. iv.; G. D. v. Scharnhorst, *Ursache des Glücks der Franzosen 1793-1794* (reprinted in A. Weiss's *Short German Military Readings*, London, 1892); E. D'Hauterive, *L'Armée sous la Révolution*; C. Rousset, *Les Volontaires*; Max Jähns, *Das französische Heer*; Shadwell, *Mountain Warfare*; works of Colonel Camon (*Guerre Napoléonienne*, &c.); Austrian War Office, *Krieg gegen die franz. Revolution 1792-1797* (Vienna, 1905); Archduke Charles, *Grundsätze der Strategie* (1796 campaign in Germany), and *Gesch. des Feldzuges 1799 in Deutsch. und der Schweiz*; v. Zeissberg, *Erzherzog Karl*; the old history called *Victoires et conquêtes des Français* (27 volumes, Paris, 1817-1825); M. Hartmann, *Anleß der Russen am Feldzug 1799 in der Schweiz* (Zürich, 1892); Danilewiski-Millutin, *Der Krieg Russlands gegen Frankreich unter Paul I.* (Munich, 1858); German General Staff, "Napoléons Feldzug 1796-1797" (Suppl. *Mil. Wochenblatt*, 1889), and *Pirmasens und Kaiserstaub* ("Kriegsgesch. Einzelschriften," 1893). (C.F.A.)

NAVAL OPERATIONS

The naval side of the wars arising out of the French Revolution was marked by unity, and even by simplicity. France had but one serious enemy, Great Britain, and Great Britain had but one purpose, to beat down France. Other states were drawn into the strife, but it was as the allies, the enemies and at times the victims, of the two dominating powers. The field of battle was the whole expanse of the ocean and the landlocked seas. The weapons, the methods and the results were the same. When a general survey of the whole struggle is taken, its unity is manifest. The Revolution produced a profound alteration in the government of France, but none in the final purposes of its policy. To secure for France its so-called "natural limits"—the Rhine, the Alps, the Pyrenees and the ocean; to protect both flanks by reducing Holland on the north and Spain on the south to submission; to confirm the mighty power thus constituted, by the subjugation of Great Britain, were the objects of the Republic and of Napoleon, as they had been of Louis XIV. The naval war, like the war on land, is here considered in the first of its two phases—the Revolutionary (1792-99). (For the Napoleonic phase (1800-15), see NAPOLEONIC CAMPAIGNS.)

The Revolutionary war began in April 1792. In the September of that year Admiral Truguet sailed from Toulon to co-operate with the French troops operating against the Austrians and their allies in northern Italy. In December Latouche Tréville was sent with another squadron to cow the Bourbon rulers of Naples. The extreme feebleness of their opponents alone saved the French from disaster. Mutinies, which began within ten days of the storming of the Bastille (14th of July 1789), had disorganized their navy, and the effects of these disorders continued to be felt so long as the war lasted. In February 1793 war broke out with Great Britain and Holland. In March Spain was added to the list of the powers against which France declared war. Her resources at sea were wholly inadequate to meet the coalition she had provoked. The Convention did indeed order that fifty-two ships of the line should be commissioned in the Channel, but it was not able in fact to do more than send out a few diminutive and ill-appointed squadrons, manned by mutinous crews, which kept close to the coast. The British navy was in excellent order, but the many calls made on it for the protection of world-wide commerce and colonial

possessions caused the operations in the Channel to be somewhat languid. Lord Howe cruised in search of the enemy without being able to bring them to action. The severe blockade which in the later stages of the war kept the British fleet permanently outside of Brest was not enforced in the earlier stages. Lord Howe preferred to save his fleet from the wear and tear of perpetual cruising by maintaining his headquarters at St Helens, and keeping watch on the French ports by frigates. The French thus secured a freedom of movement which in the course of 1794 enabled them to cover the arrival of a great convoy laden with food from America (see FIRST OF JUNE, BATTLE OF). This great effort was followed by a long period of languor. Its internal defects compelled the French fleet in the Channel to play a very poor part till the last days of 1796. Squadrons were indeed sent a short way to sea, but their inefficiency was conspicuously displayed when, on the 17th of June 1795, a much superior number of their line of battle ships failed to do any harm to the small force of Cornwallis, and when on the 22nd of the same month they fled in disorder before Lord Bridport at the Isle de Groix.

Operations of a more decisive character had in the meantime taken place both in the Mediterranean and in the West Indies. In April 1793 the first detachment of a British fleet, which was finally raised to a strength of 21 sail of the line, under the command of Lord Hood, sailed for the Mediterranean. By August the admiral was off Toulon, acting in combination with a Spanish naval force. France was torn by the contentions of Jacobins and Girondins, and its dissensions led to the surrender of the great arsenal to the British admiral and his Spanish colleague Don Juan de Lángara, on the 27th of August. The allies were joined later by a contingent from Naples. But the military forces were insufficient to hold the land defences against the army collected to expel them. High ground commanding the anchorage was occupied by the besieging force, and on the 18th of December 1793 the allies retired. They carried away or destroyed thirty-three French vessels, of which thirteen were of the line. But partly through the inefficiency and partly through the ill-will of the Spaniards, who were indisposed to cripple the French, whom they considered as their only possible allies against Great Britain, the destruction was not so complete as had been intended. Twenty-five ships, of which eighteen were of the line, were left to serve as the nucleus of an active fleet in later years. Fourteen thousand of the inhabitants fled with the allies to escape the vengeance of the victorious Jacobins. Their sufferings, and the ferocious massacre perpetrated on those who remained behind by the conquerors, form one of the blackest pages of the French Revolution. The Spanish fleet took no further part in the war. Lord Hood now turned to the occupation of Corsica, where the intervention of the British fleet was invited by the patriotic party headed by Pascual Paoli. The French ships left at Toulon were refitted and came to sea in the spring of 1794, but Admiral Martin who commanded them did not feel justified in giving battle, and his sorties were mere demonstrations. From the 25th of January 1794 till November 1796 the British fleet in the Mediterranean was mainly occupied in and about Corsica, securing the island, watching Toulon and co-operating with the allied Austrians and Piedmontese in northern Italy. It did much to hamper the coastwise communications of the French. But neither Lord Hood, who went home at the end of 1794, nor his indolent successor Hotham, was able to deliver an effective blow at the Toulon squadron. The second of these officers fought two confused actions with Admiral Martin in the Gulf of Lyons on the 16th of March and the 12th of July 1795, but though three French ships were cut off and captured, the baffling winds and the placid disposition of Hotham united to prevent decisive results. A new spirit was introduced into the command of the British fleet when Sir John Jervis, afterwards Earl Saint Vincent, succeeded Hotham in November 1795.

Jervis came to the Mediterranean with a high reputation, which had been much enhanced by his recent command in the West Indies. In every war with France it was the natural policy

of the British government to seize on its enemy's colonial possessions, not only because of their intrinsic value, but because they were the headquarters of active privateers. The occupation of the little fishing stations of St Pierre and Miquelon (14th May 1793) and of Pondicherry in the East Indies (23rd Aug. 1793) were almost formal measures taken at the beginning of every war. But the French West Indian islands possessed intrinsic strength which rendered their occupation a service of difficulty and hazard. In 1793 they were torn by dissensions, the result of the revolution in the mother country. Tobago was occupied in April, and the French part of the great island of San Domingo was partially thrown into British hands by the Creoles, who were threatened by their insurgent slaves. During 1794 a lively series of operations, in which there were some marked alternations of fortune, took place in and about Martinique and Guadeloupe. The British squadron, and the contingent of troops it carried, after a first repulse, occupied them both in March and April, together with Santa Lucia. A vigorous counter-attack was carried out by the Terrorist Victor Hugues with ability and ferocity. Guadeloupe and Santa Lucia were recovered in August. Yet on the whole the British government was successful in its policy of destroying the French naval power in distant seas. The seaborne commerce of the Republic was destroyed.

The naval supremacy of Great Britain was limited, and was for a time menaced, in consequence of the advance of the French armies on land. The invasion of Holland in 1794 led to the downfall of the house of Orange, and the establishment of the Batavian Republic. War with Great Britain under French dictation followed in January 1795. In that year a British expedition under the command of Admiral Keith Elphinstone (afterwards Lord Keith) occupied the Dutch colony at the Cape (August-September) and their trading station in Malacca. The British colonial empire was again extended, and the command of the sea by its fleet confirmed. But the necessity to maintain a blockading force in the German Ocean imposed a fresh strain on its naval resources, and the hostility of Holland closed a most important route to British commerce in Europe. In 1795 Spain made peace with France at Basel, and in September 1796 re-entered the war as her ally. The Spanish navy was most inefficient, but it required to be watched and therefore increased the heavy strain on the British fleet. At the same time the rapid advance of the French arms in Italy began to close the ports of the peninsula to Great Britain. Its ships were for a time withdrawn from the Mediterranean. Poor as it was in quality, the Spanish fleet was numerous. It was able to facilitate the movements of French squadrons sent to harass British commerce in the Atlantic, and a concentration of forces became necessary.

It was the more important because the cherished French scheme for an attack on the heart of the British empire began to take shape. While Spain occupied one part of the British fleet to the south, and Holland another in the north, a French expedition, which was to have been aided by a Dutch expedition from the Texel, was prepared at Brest. The Dutch were confined to harbour by the vigilant blockade of Admiral Duncan, afterwards Lord Camperdown. But in December 1796 a French fleet commanded by Admiral Morard de Galle, carrying 13,000 troops under General Hoche, was allowed to sail from Brest for Ireland, by the slack management of the blockade under Admiral Colpoys. Being ill-fitted, ill-manned and exposed to constant bad weather the French ships were scattered. Some reached their destination, Bantry Bay, only to be driven out again by north-easterly gales. The expedition finally returned after much suffering, and in fragments, to Brest. Yet the year 1797 was one of extreme trial to Great Britain. The victory of Sir John Jervis over the Spaniards near Cape Saint Vincent on the 14th of February (see SAINT VINCENT, BATTLE OF) disposed of the Spanish fleet. In the autumn of the year the Dutch, having put to sea, were defeated at Camperdown by Admiral Duncan on the 11th of October. Admiral Duncan had the more numerous force, sixteen ships to fifteen, and they were on the average heavier. Attacking from windward he broke through the enemy's line

and concentrated on his rear and centre. Eight line of battle-ships and two frigates were taken, but the good gunnery and steady resistance of the Dutch made the victory costly. Between these two battles the British fleet was for a time menaced in its very existence by a succession of ~~misadventures~~ ^{misadventures}, the result of much neglect of the undoubted grievances of the sailors. The victory of Camperdown, completing what the victory of Cape Saint Vincent had begun, seemed to put Great Britain beyond fear of invasion. But the government of the Republic was intent on renewing the attempt. The successes of Napoleon at the head of the army of Italy had reduced Austria to sign the peace of Campo Formio, on the 17th of October 1797, and he was appointed commander of the new army of invasion. It was still thought necessary to maintain the bulk of the British fleet in European waters, within call in the ocean. The Mediterranean was left free to the French, whose squadrons cruised in the Levant, where the Republic had become possessed of the Ionian Islands by the plunder of Venice. The absence of a British force in the Mediterranean offered to the government of the French Republic an alternative to an invasion of Great Britain or Ireland, which promised to be less hazardous and equally effective. It was induced largely by the persuasion of Napoleon himself, and the wish of the politicians who were very willing to see him employed at a distance. The expedition to Egypt under his command sailed on the 10th of May 1798, having for its immediate purpose the occupation of the Nile valley, and for its ultimate aim an attack on Great Britain "from behind" in India (see NILE, BATTLE OF THE). The British fleet re-entered the Mediterranean to pursue and baffle Napoleon. The destruction of the French squadron at the anchorage of Aboukir on the 1st of August gave it the complete command of the sea. A second invasion of Ireland on a smaller scale was attempted and to some extent carried out, while the great attack by Egypt was in progress. One French squadron of four frigates carrying 1150 soldiers under General Humbert succeeded in sailing from Rochefort on the 6th of August. On the 22nd Humbert was landed at Killala Bay, but after making a vigorous raid he was compelled to surrender at Ballinamuck on the 8th of September. Eight days after his surrender, another French squadron of one sail of the line and eight frigates carrying 3000 troops, sailed from Brest under Commodore Bompard to support Humbert. It was watched and pursued by frigates, and on the 12th of October was overtaken and destroyed by a superior British force commanded by Sir John Borlase Warren, near Tory Island.

From the close of 1798 till the *coup d'état* of the 18th Brumaire (9th November) 1799, which established Napoleon as First Consul and master of France, the French navy had only one object—to reinforce and relieve the army cut off in Egypt by the battle of the Nile. The relief of the French garrison in Malta was a subordinate part of the main purpose. But the supremacy of the British navy was by this time so firmly founded that neither Egypt nor Malta could be reached except by small ships which ran the blockade. On the 25th of April, Admiral Bruix did indeed leave Brest, after baffling the blockading fleet of Lord Bridport, which was sent on a wild-goose chase to the south of Ireland by means of a despatch sent out to be captured and to deceive. Admiral Bruix succeeded in reaching Toulon, and his presence in the Mediterranean caused some disturbance. But, though his twenty-five sail of the line formed the best-manned fleet which the French had sent to sea during the war, and though he escaped being brought to battle, he did not venture to steer for the eastern Mediterranean. On the 13th of August he was back at Brest, bringing with him a Spanish squadron carried off as a hostage for the fidelity of the government at Madrid to its disastrous alliance with France. On the day on which Bruix re-entered Brest, the 13th of August 1799, a combined Russian and British expedition sailed from the Downs to attack the French army of occupation in the Batavian Republic. The military operations were unsuccessful, and terminated in the withdrawal of the allies. But the naval part was well executed. Vice-admiral Mitchell forced the entrance to the Texel, and on the 30th of August received the surrender of the remainder of the

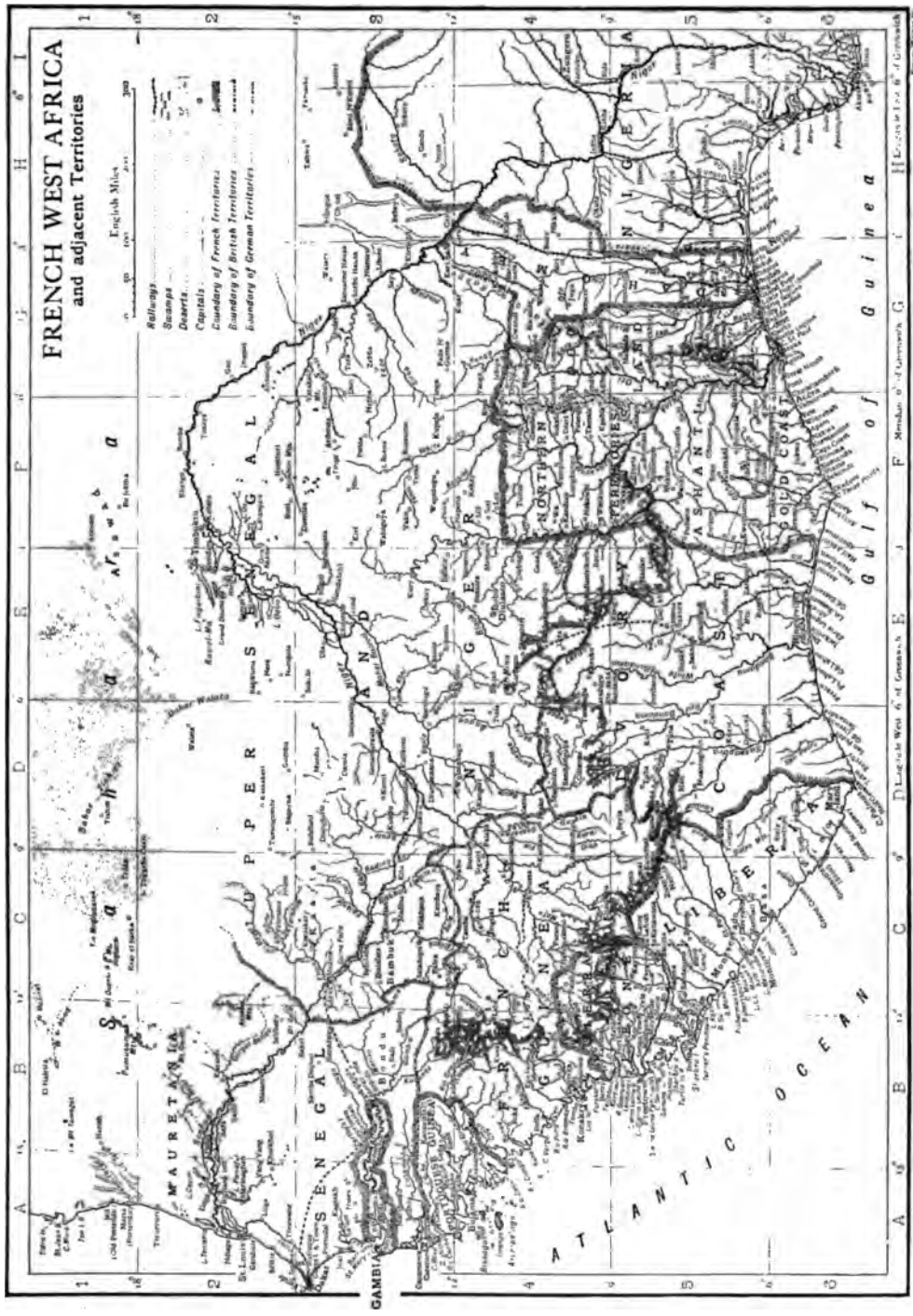

1 2 3 4 5 6 7 8 9 10 11 12 13 14 15 16 17 18 19 20 21 22 23 24 25 26 27 28 29 30 31 32 33 34 35 36 37 38 39 40 41 42 43 44 45 46 47 48 49 50 51 52 53 54 55 56 57 58 59 60 61 62 63 64 65 66 67 68 69 70 71 72 73 74 75 76 77 78 79 80 81 82 83 84 85 86 87 88 89 90 91 92 93 94 95 96 97 98 99 100

A B C D E F G H I J K L M N O P Q R S T U V W X Y Z

1 2 3 4 5 6 7 8 9 10 11 12 13 14 15 16 17 18 19 20 21 22 23 24 25 26 27 28 29 30 31 32 33 34 35 36 37 38 39 40 41 42 43 44 45 46 47 48 49 50 51 52 53 54 55 56 57 58 59 60 61 62 63 64 65 66 67 68 69 70 71 72 73 74 75 76 77 78 79 80 81 82 83 84 85 86 87 88 89 90 91 92 93 94 95 96 97 98 99 100

A B C D E F G H I J K L M N O P Q R S T U V W X Y Z

1 2 3 4 5 6 7 8 9 10 11 12 13 14 15 16 17 18 19 20 21 22 23 24 25 26 27 28 29 30 31 32 33 34 35 36 37 38 39 40 41 42 43 44 45 46 47 48 49 50 51 52 53 54 55 56 57 58 59 60 61 62 63 64 65 66 67 68 69 70 71 72 73 74 75 76 77 78 79 80 81 82 83 84 85 86 87 88 89 90 91 92 93 94 95 96 97 98 99 100

A B C D E F G H I J K L M N O P Q R S T U V W X Y Z

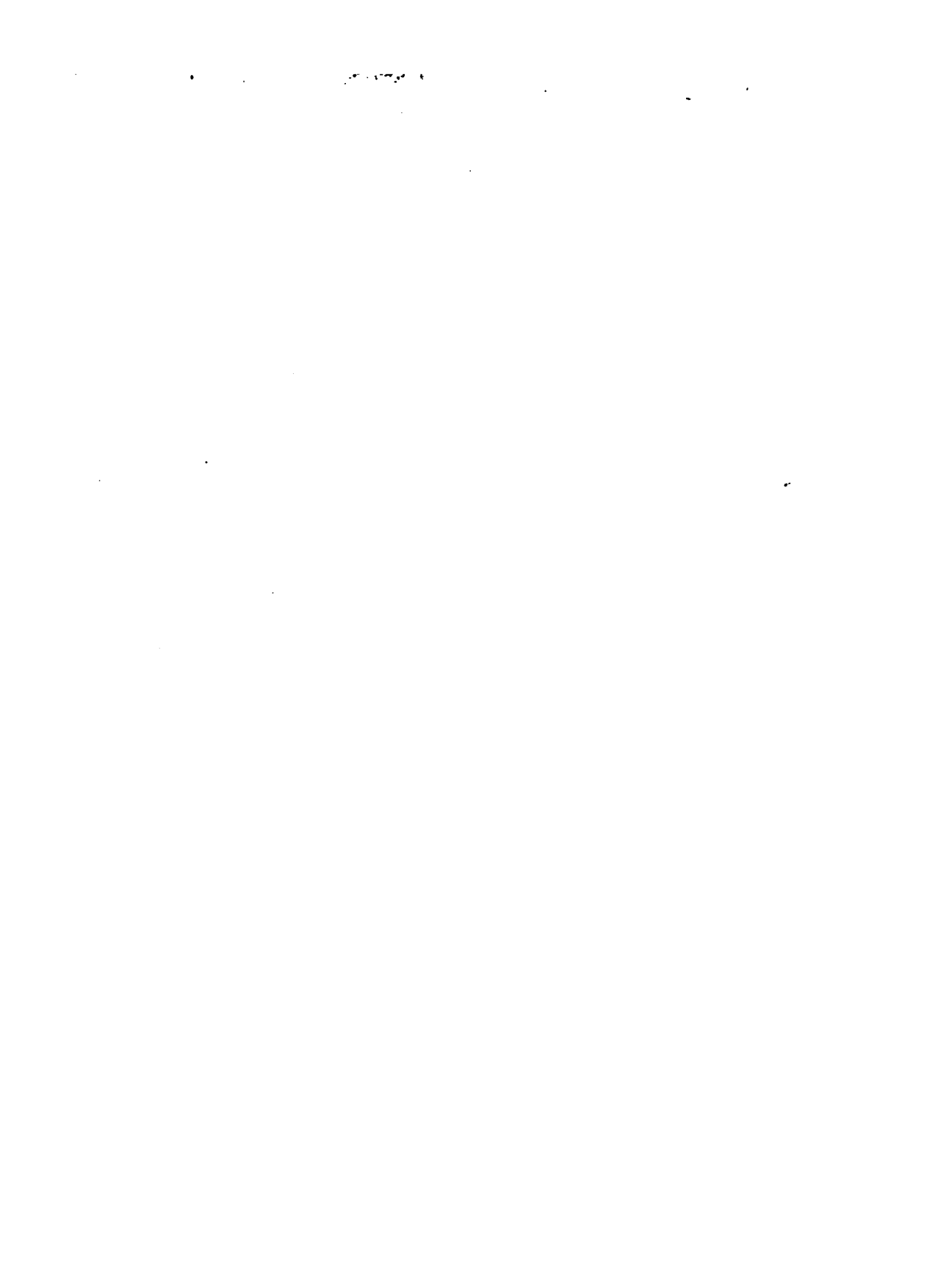

Dutch fleet—thirteen vessels in the Nieuwe Diep—the sailors having refused to fight for the republic. In spite of the failure on land, the expedition did much to confirm the naval supremacy of Great Britain by the entire suppression of the most seaman-like of the forces opposed to it.

AUTHORITIES.—Chevalier, *Histoire de la marine française sous la première République* (Paris, 1886); James's *Naval History* (London, 1837); Captain Mahan, *Influence of Sea Power upon the French Revolution and the Empire* (London, 1892). The French schemes of invasion are exhaustively dealt with in Captain E. Desbrière's *Projets et tentatives de débarquements aux Îles Britanniques* (Paris, 1900, &c.). (D. H.)

FRENCH WEST AFRICA (*L'Afrique occidentale française*), the common designation of the following colonies of France:—(1) Senegal, (2) Upper Senegal and Niger, (3) Guinea, (4) the Ivory Coast, (5) Dahomey; of the territory of Mauretania, and of a large portion of the Sahara. The area is estimated at nearly 2,000,000 sq. m., of which more than half is Saharan territory. The countries thus grouped under the common designation French West Africa comprise the greater part of the continent west of the Niger delta (which is British territory) and south of the tropic of Cancer. It embraces the upper and middle course of the Niger, the whole of the basin of the Senegal and the south-western part of the Sahara. Its most northern point on the coast is Cape Blanco, and it includes Cape Verde, the most westerly point of Africa. Along the Guinea coast the French possessions are separated from one another by colonies of Great Britain and other powers, but in the interior they unite not only with one another but with the hinterlands of Algeria and the French Congo.

In physical characteristics French West Africa presents three types: (1) a dense forest region succeeding a narrow coast belt greatly broken by lagoons, (2) moderately elevated and fertile plateaus, generally below 2000 ft., such as the region enclosed in the great bend of the Niger; (3) north of the Senegal and Niger, the desert lands forming part of the Sahara (q.v.). The most elevated districts are Futa Jallon, whence rise the Senegal, Gambia and Niger, and Gon—both massifs along the south-western edge of the plateau lands, containing heights of 5000 to 6000 ft. or more. Among the chief towns are Timbuktu and Jenné on the Niger, Porto Novo in Dahomey, and St Louis and Dakar in Senegal, Dakar being an important naval and commercial port. The inhabitants are for the most part typical Negroes, with in Senegal and in the Sahara an admixture of Berber and Arab tribes. In the upper Senegal and Futa Jallon large numbers of the inhabitants are Fula. The total population of French West Africa is estimated at about 13,000,000. The European inhabitants number about 12,000.

The French possessions in West Africa have grown by the extension inland of coast colonies, each having an independent origin. They were first brought under one general government in 1805, when they were placed under the supervision of the governor of Senegal, whose title was altered to meet the new situation. Between that date and 1905 various changes in the areas and administrations of the different colonies were made, involving the disappearance of the protectorates and military territories known as French Sudan and dependent on Senegal. These were partly absorbed in the coast colonies, whilst the central portion became the colony of Upper Senegal and Niger. At the same time the central government was freed from the direct administration of the Senegal and Niger countries (Decrees of Oct. 1902 and Oct. 1904). Over the whole of French West Africa is a governor-general, whose headquarters are at Dakar.¹ He is assisted by a government council, composed of high functionaries, including the lieutenant-governors of all colonies under his control. The central government, like all other French colonial administrations, is responsible, not to the colonists, but to the home government, and its constitution is alterable at will by presidential decree save in matters on which the chambers

¹ The organization of the new government was largely the work of E. N. Roume (b 1858), governor-general 1902–1907, an able and energetic official, formerly director of Asian affairs at the colonial ministry.

have expressly legislated. To it is confided financial control over the colonies, responsibility for the public debt, the direction of the departments of education and agriculture, and the carrying out of works of general utility. It alone communicates with the home authorities. Its expenses are met by the duties levied on goods and vessels entering and leaving any port of French West Africa. It may make advances to the colonies under its care, and may, in case of need, demand from them contributions to the central exchequer. The administration of justice is centralized and uniform for all French West Africa. The court of appeal sits at Dakar. There is also a uniform system of land registration adopted in 1906 and based on that in force in Australia. Subject to the limitations indicated the five colonies enjoy autonomy. The territory of Mauretania is administered by a civil commissioner under the direct control of the governor-general. The colony of Senegal is represented in the French parliament by one deputy.

Since the changes in administration effected in 1895 the commerce of French West Africa has shown a steady growth, the volume of external trade increasing in the ten years 1895–1904 from £3,151,004 to £6,238,091. In 1907 the value of the trade was £7,097,000; of this 53% was with France. Apart from military expenditure, about £600,000 a year, which is borne by France, French West Africa is self-supporting. The general budget for 1906 balanced at £1,356,000. There is a public debt of some £11,000,000, mainly incurred for works of general utility.

See SENEGAL, FRENCH GUINEA, IVORY COAST and DAHOMEY. For Anglo-French boundaries east of the Niger see SAHARA and NIGERIA. For the constitutional connexion between the colonies and France see FRANCE: Colonies. An account of the economic situation of the colonies is given by G. François in *Le Gouvernement général de l'Afrique occidentale française* (Paris, 1908). Consult also the annual *Report on the Trade, Agriculture, &c. of French West Africa* issued by the British foreign office. A map of French West Africa by A. Meunier and E. Barralier (6 sheets on the scale 1:2,000,000) was published in Paris, 1903.

FRENTANI, one of the ancient Samnite tribes which formed an independent community on the east coast of Italy. They entered the Roman alliance after their capital, Frentum, was taken by the Romans in 305 or 304 B.C. (Livy ix. 16. 45). This town either changed its name or perished some time after the middle of the 3rd century B.C., when it was issuing coins of its own with an Oscan legend. The town Larinum, which belonged to the same people (Pliny, *Nat. Hist.* iii. 103), became latinized before 200 B.C., as its coins of that epoch bear a legend—LARINOR(VM)—which cannot reasonably be treated as anything but Latin. Several Oscan inscriptions survive from the neighbourhood of Vasto (anc. *Histonium*), which was in the Frentane area.

On the forms of the name, and for further details see R.S. Conway, *Italic Dialects*, p. 206 ff and p. 212; for the coins *id.* No. 195–196.

FREPPÉL, CHARLES ÉMILE (1827–1891), French bishop and politician, was born at Oberehnheim (Obernai), Alsace, on the 1st of June 1827. He was ordained priest in 1849 and for a short time taught history at the seminary of Strassburg, where he had previously received his clerical training. In 1854 he was appointed professor of theology at the Sorbonne, and became known as a successful preacher. He went to Rome in 1869, at the instance of Pius IX., to assist in the steps preparatory to the promulgation of the dogma of papal infallibility. He was consecrated bishop of Angers in 1870. During the Franco-German war FreppéL organized a body of priests to minister to the French prisoners in Germany, and penned an eloquent protest to the emperor William I against the annexation of Alsace-Lorraine. In 1880 he was elected deputy for Brest and continued to represent it until his death. Being the only priest in the Chamber of Deputies since the death of Dupanloup, he became the chief parliamentary champion of the Church, and, though no orator, was a frequent speaker. On all ecclesiastical affairs FreppéL voted with the Royalist and Catholic party, yet on questions in which French colonial prestige was involved, such as the expedition to Tunis, Tong-King, Madagascar (1881, 1883–85), he supported the government of the day. He always remained a staunch Royalist and went so far as to oppose Leo XIII's policy

of conciliating the Republic. He died at Angers on the 12th of December 1891. Freppel's historical and theological works form 30 vols., the best known of which are: *Les Pères apostoliques et leur époque* (1859); *Les Apologistes chrétiens au 11^e siècle* (2 vols., 1860); *Saint Irénée et l'éloquence chrétienne dans la Gaule aux deux premiers siècles* (1861); *Tertullien* (2 vols., 1863); *Saint Cyprien et l'Église d'Afrique* (1864); *Clement d'Alexandrie* (1865); *Origène* (2 vols., 1867).

There are interesting lives by E. Cornut (Paris, 1893) and F. Charpentier (Angers, 1904).

FRERE, SIR HENRY BARTLE EDWARD (1815-1884), British administrator, born at Clydach in Brecknockshire, on the 29th of March 1815, was the son of Edward Frere, a member of an old east county family, and a nephew of John Hookham Frere, of *Anti-Jacobin* and *Aristophanes* fame. After leaving Haileybury, Bartle Frere was appointed a writer in the Bombay civil service in 1834, and went out to India by way of Egypt, crossing the Red Sea in an open boat from Kosseir to Mokha, and sailing thence to Bombay in an Arab dhow. Having passed his examination in the native languages, he was appointed assistant collector at Poona in 1835. There he did valuable work and was in 1842 chosen as private secretary to Sir George Arthur, governor of Bombay. Two years later he became political resident at the court of the rajah of Satara, where he did much to benefit the country by the development of its communications. On the rajah's death in 1848 he administered the province both before and after its formal annexation in 1849. In 1850 he was appointed chief commissioner of Sind, and took ample advantage of the opportunities afforded him of developing the province. He pensioned off the dispossessed amirs, improved the harbour at Karachi, where he also established municipal buildings, a museum and barracks, instituted fairs, multiplied roads, canals and schools.

Returning to India in 1857 after a well-earned rest, Frere was greeted at Karachi with news of the mutiny. His rule had been so successful that he felt he could answer for the internal peace of his province. He therefore sent his only European regiment to Multan, thus securing that strong fortress against the rebels, and sent further detachments to aid Sir John Lawrence in the Punjab. The 178 British soldiers who remained in Sind proved sufficient to extinguish such insignificant outbreaks as occurred. His services were fully recognized by the Indian authorities, and he received the thanks of both houses of parliament and was made K.C.B. He became a member of the viceroy's council in 1859, and was especially serviceable in financial matters. In 1862 he was appointed governor of Bombay, where he effected great improvements, such as the demolition of the old ramparts, and the erection of handsome public offices upon a portion of the space, the inauguration of the university buildings and the improvement of the harbour. He established the Deccan College at Poona, as well as a college for instructing natives in civil engineering. The prosperity—due to the American Civil War—which rendered these developments possible brought in its train a speculative mania, which led eventually to the disastrous failure of the Bombay Bank (1866), an affair in which, from neglecting to exercise such means of control as he possessed, Frere incurred severe and not wholly undeserved censure. In 1867 he returned to England, was made G.C.S.I., and received honorary degrees from Oxford and Cambridge; he was also appointed a member of the Indian council.

In 1872 he was sent by the foreign office to Zanzibar to negotiate a treaty with the sultan, Seyyid Burghash, for the suppression of the slave traffic. In 1875 he accompanied the prince of Wales to Egypt and India. The tour was beyond expectation successful, and to Frere, from Queen Victoria downwards, came acknowledgments of the service he had rendered in piloting the expedition. He was asked by Lord Beaconsfield to choose between being made a baronet or G.C.B. He chose the former, but the queen bestowed both honours upon him. But the greatest service that Frere undertook on behalf of his country was to be attempted not in Asia, but in Africa. Sir Bartle landed at Cape Town as high commissioner

of South Africa on the 31st of March 1877. He had been chosen by Lord Carnarvon in the previous October as the statesman most capable of carrying his scheme of confederation into effect, and within two years it was hoped that he would be the first governor of the South African Dominion. He went out in harmony with the aims and enthusiasm of his chief, "hoping to crown by one great constructive effort the work of a bright and noble life." In this hope he was disappointed. As he stated at the close of his high commissionership, a great mistake seemed to have been made in trying to hasten what could only result from natural growth, and the state of South Africa during Frere's tenure of office was inimical to such growth.

Discord or a policy of blind drifting seemed to be the alternatives presented to Frere upon his arrival at the Cape. He chose the former as the less dangerous, and the first year of his sway was marked by a Kaffir war on the one hand and by a rupture with the Cape (Molteno-Merriman) ministry on the other. The Transkei Kaffirs were subjugated early in 1878 by General Thesiger (the 2nd Lord Chelmsford) and a small force of regular and colonial troops. The constitutional difficulty was solved by Frere dismissing his obstructive cabinet and entrusting the formation of a ministry to Mr (afterwards Sir) Gordon Sprigg. Frere emerged successfully from a year of crisis, but the advantage was more than counterbalanced by the resignation of Lord Carnarvon early in 1878, at a time when Frere required the steadiest and most unflinching support. He had reached the conclusion that there was a widespread insurgent spirit pervading the natives, which had its focus and strength in the celibate military organization of Cetuywayo and in the prestige which impunity for the outrages he had committed had gained for the Zulu king in the native mind. That organization and that evil prestige must be put an end to, if possible by moral pressure, but otherwise by force. Frere reiterated these views to the colonial office, where they found a general acceptance. When, however, Frere undertook the responsibility of forwarding, in December 1878, an ultimatum to Cetuywayo, the home government abruptly discovered that a native war in South Africa was inopportune and raised difficulties about reinforcements. Having entrusted to Lord Chelmsford the enforcement of the British demands, Frere's immediate responsibility ceased. On the 11th of January 1879 the British troops crossed the Tugela, and fourteen days later the disaster of Isandhlwana was reported, and Frere, attacked and censured in the House of Commons, was but feebly defended by the government. Lord Beaconsfield, it appears, supported Frere, the majority of the cabinet were inclined to recall him. The result was the unsatisfactory compromise by which he was censured and begged to stay on. Frere wrote an elaborate justification of his conduct, which was adversely commented on by the colonial secretary (Sir Michael Hicks Beach), who "did not see why Frere should take notice of attacks, and as to the war, all African wars had been unpopular." Frere's rejoinder was that no other sufficient answer had been made to his critics, and that he wished to place one on record. "Few may now agree with my view as to the necessity of the suppression of the Zulu rebellion. Few, I fear, in this generation. But unless my countrymen are much changed, they will some day do me justice. I shall not leave a name to be permanently dishonoured."

The Zulu trouble and the disaffection that was brewing in the Transvaal reacted upon each other in the most disastrous manner. Frere had borne no part in the actual annexation of the Transvaal, which was announced by Sir Theophilus Shepstone a few days after the high commissioner's arrival at Cape Town. The delay in giving the country a constitution afforded a pretext for agitation to the discontented Boers, a rapidly increasing minority, while the reverse at Isandhlwana had lowered British prestige. Owing to the Kaffir and Zulu wars Sir Bartle had hitherto been unable to give his undivided attention to the state of things in the Transvaal. In April 1879 he was at last able to visit that province, and the conviction was forced upon him that the government had been unsatisfactory in many ways. The country was very unsettled. A large camp, numbering

4000 disaffected Boers, had been formed near Pretoria, and they were terrorizing the country. Frere visited them unarmed and practically alone. Even yet all might have been well, for he won the Boers' respect and liking. On the condition that the Boers dispersed, Frere undertook to present their complaints to the British government, and to urge the fulfilment of the promises that had been made to them. They parted with mutual good feeling, and the Boers did eventually disperse—on the very day upon which Frere received the telegram announcing the government's censure. He returned to Cape Town, and his journey back was in the nature of a triumph. But bad news awaited him at Government House—on the 1st of June 1879 the prince imperial had met his death in Zululand—and a few hours later Frere heard that the government of the Transvaal and Natal, together with the high commissionership in the eastern part of South Africa, had been transferred from him to Sir Garnet Wellesey.

When Gladstone's ministry came into office in the spring of 1880, Lord Kimberley had no intention of recalling Frere. In June, however, a section of the Liberal party memorialized Gladstone to remove him, and the prime minister weakly complied (1st August 1880). Upon his return Frere replied to the charges relating to his conduct respecting Afghanistan as well as South Africa, previously preferred in Gladstone's Midlothian speeches, and was preparing a fuller vindication when he died at Wimbledon from the effect of a severe chill on the 20th of May 1884. He was buried in St Paul's, and in 1888 a statue of Frere upon the Thames embankment was unveiled by the prince of Wales. Frere edited the works of his uncle, Hookham Frere, and the popular story-book, *Old Deccan Days*, written by his daughter, Mary Frere. He was three times president of the Royal Asiatic Society.

His *Life and Correspondence*, by John Martineau, was published in 1895. For the South African anti-confederation view, see P. A. Molteno's *Life and Times of Sir John Charles Molteno* (2 vols., London 1900). See also SOUTH AFRICA: *History*.

FRERE, JOHN HOOKHAM (1769-1846), English diplomatist and author, was born in London on the 21st of May 1769. His father, John Frere, a gentleman of a good Suffolk family, had been educated at Caius College, Cambridge, and would have been senior wrangler in 1763 but for the redoubtable competition of Paley; his mother, daughter of John Hookham, a rich London merchant, was a lady of no small culture, accustomed to amuse her leisure with verse-writing. His father's sister Eleanor, who married Sir John Fenn (1739-1794), the learned editor of the *Pastor Letters*, wrote various educational works for children under the pseudonyms "Mrs Lovechild" and "Mrs Teachwell." Young Frere was sent to Eton in 1785, and there began an intimacy with Canning which greatly affected his after life. From Eton he went to his father's college at Cambridge, and graduated B.A. in 1792 and M.A. in 1795. He entered public service in the foreign office under Lord Grenville, and sat from 1796 to 1802 as member of parliament for the close borough of West Looe in Cornwall.

From his boyhood he had been a warm admirer of Pitt, and along with Canning he entered heart and soul into the defence of his government, and contributed freely to the pages of the *Anti-Jacobin*, edited by Gifford. He contributed, in collaboration with Canning, "The Loves of the Triangles," a clever parody of Darwin's "Loves of the Plants," "The Needy Knife-Grinder" and "The Rovers." On Canning's removal to the board of trade in 1799 he succeeded him as under-secretary of state; in October 1800 he was appointed envoy extraordinary and plenipotentiary to Lisbon; and in September 1802 he was transferred to Madrid, where he remained for two years. He was recalled on account of a personal disagreement he had with the duke of Alcudia, but the ministry showed its approval of his action by a pension of £1700 a year. He was made a member of the privy council in 1805; in 1807 he was appointed plenipotentiary at Berlin, but the mission was abandoned, and Frere was again sent to Spain in 1808 as plenipotentiary to the Central Junta. The condition of Spain rendered his position a very

responsible and difficult one. When Napoleon began to advance on Madrid it became a matter of supreme importance to decide whether Sir John Moore, who was then in the north of Spain, should endeavour to anticipate the occupation of the capital or merely make good his retreat, and if he did retreat whether he should do so by Portugal or by Galicia. Frere was strongly of opinion that the bolder was the better course, and he urged his views on Sir John Moore with an urgent and fearless persistency that on one occasion at least overstepped the limits of his commission. After the disastrous retreat to Corunna, the public accused Frere of having by his advice endangered the British army, and though no direct censure was passed upon his conduct by the government, he was recalled, and the marquess of Wellesley was appointed in his place.

Thus ended Frere's public life. He afterwards refused to undertake an embassy to St Petersburg, and twice declined the honour of a peerage. In 1816 he married Elizabeth Jemima, dowager countess of Erroll, and in 1820, on account of her failing health, he went with her to the Mediterranean. There he finally settled in Malta, and though he afterwards visited England more than once, the rest of his life was for the most part spent in the island of his choice. In quiet retirement he devoted himself to literature, studied his favourite Greek authors, and taught himself Hebrew and Maltese. His hospitality was well known to many an English guest, and his charities and courtesies endeared him to his Maltese neighbours. He died at the Pietà Valetta on the 7th of January 1846. Frere's literary reputation now rests entirely upon his spirited verse translations of Aristophanes, which remain in many ways unrivalled. The principles according to which he conducted his task were elucidated in an article on Mitchell's *Aristophanes*, which he contributed to *The Quarterly Review*, vol. xxiii. The translations of *The Acharnians*, *The Knights*, *The Birds*, and *The Frogs* were privately printed, and were first brought into general notice by Sir G. Cornewall Lewis in the *Classical Museum* for 1847. They were followed some time after by *Theognis Restitutus*, or the personal history of the poet *Theognis*, reduced from an analysis of his existing fragments. In 1817 he published a mock-heroic Arthurian poem entitled *Prospectus and Specimen of an intended National Work, by William and Robert Whistlecraft, of Stowmarket in Suffolk, Harness and Collar Makers, intended to comprise the most interesting particulars relating to King Arthur and his Round Table*. William Tennant in *Anster Fair* had used the *ottava rima* as a vehicle for semi-burlesque poetry five years earlier, but Frere's experiment is interesting because Byron borrowed from it the measure that he brought to perfection in *Don Juan*.

Frere's complete works were published in 1871, with a memoir by his nephews, W. E. and Sir Bartle Frere, and reached a second edition in 1874. Compare also Gabrielle Festing, *J. H. Frere and his Friends* (1899).

FRÈRE, PIERRE ÉDOUARD (1819-1886), French painter, studied under Delaroché, entered the *École des Beaux-Arts* in 1836 and exhibited first at the Salon in 1843. The marked sentimental tendency of his art makes us wonder at Ruskin's enthusiastic eulogy which finds in Frère's work "the depth of Wordsworth, the grace of Reynolds, and the holiness of Angelico." What we can admire in his work is his accomplished craftsmanship and the intimacy and tender homeliness of his conception. Among his chief works are the two paintings, "Going to School" and "Coming from School," "The Little Glutton" (his first exhibited picture) and "L'Exercice" (Mr Astor's collection). A journey to Egypt in 1860 resulted in a small series of Orientalist subjects, but the majority of Frère's paintings deal with the life of the kitchen, the workshop, the dwellings of the humble, and mainly with the pleasures and little troubles of the young, which the artist brings before us with humour and sympathy. He was one of the most popular painters of domestic genre in the middle of the 19th century.

FRÈRE-ORBAN, HUBERT JOSEPH WALTHER (1812-1896), Belgian statesman, was born at Liège on the 24th of April 1812. His family name was Frère, to which on his marriage he added his wife's name of Orban. After studying law in Paris, he

practised as a barrister at Liège, took a prominent part in the Liberal movement, and in June 1847 was returned to the Chamber as member for Liège. In August of the same year he was appointed minister of public works in the Rogier cabinet, and from 1848 to 1852 was minister of finance. He founded the Banque Nationale and the Caisse d'Épargne, abolished the newspaper tax, reduced the postage, and modified the customs duties as a preliminary to a decided free-trade policy. The Liberalism of the cabinet, in which Frère-Orban exercised an influence hardly inferior to that of Rogier, was, however, distasteful to Napoleon III. Frère-Orban, to facilitate the negotiations for a new commercial treaty, conceded to France a law of copyright, which proved highly unpopular in Belgium, and he resigned office, soon followed by the rest of the cabinet. His work *La Mort et la charité* (1854-1857), published under the pseudonym of "Jean van Damme," contributed greatly to restore his party to power in 1857, when he again became minister of finance. He now embodied his free-trade principles in commercial treaties with England and France, and abolished the octroi duties and the tolls on the national roads. He resigned in 1861 on the gold question, but soon resumed office, and in 1868 succeeded Rogier as prime minister. In 1869 he defeated the attempt of France to gain control of the Luxemburg railways, but, despite this service to his country, fell from power at the elections of 1870. He returned to office in 1878 as president of the council and foreign minister. He provoked the bitter opposition of the Clerical party by his law of 1879 establishing secular primary education, and in 1880 went so far as to break off diplomatic relations with the Vatican. He next found himself at variance with the Radicals, whose leader, Janson, moved the introduction of universal suffrage. Frère-Orban, while rejecting the proposal, conceded an extension of the franchise (1883); but the hostility of the Radicals, and the discontent caused by a financial crisis, overthrew the government at the elections of 1884. Frère-Orban continued to take an active part in politics as leader of the Liberal opposition till 1894, when he failed to secure re-election. He died at Brussels on the 2nd of January 1896. Besides the work above mentioned, he published *La Question monétaire* (1874), *La Question monétaire en Belgique* in 1889; *Échange de vues entre MM. Frère-Orban et E. de Lavleye* (1890), and *La Révision constitutionnelle en Belgique et ses conséquences* (1894). He was also the author of numerous pamphlets, among which may be mentioned his last work, *La Situation présente* (1895).

FRÉRET, NICOLAS (1688-1749), French scholar, was born at Paris on the 15th of February 1688. His father was *procureur* to the parlement of Paris, and destined him to the profession of the law. His first tutors were the historian Charles Rollin and Father Desmolets (1677-1760). Amongst his early studies history, chronology and mythology held a prominent place. To please his father he studied law and began to practise at the bar; but the force of his genius soon carried him into his own path. At nineteen he was admitted to a society of learned men before whom he read memoirs on the religion of the Greeks, on the worship of Bacchus, of Ceres, of Cybele and of Apollo. He was hardly twenty-six years of age when he was admitted as pupil to the Academy of Inscriptions. One of the first memoirs which he read was a learned and critical discourse, *Sur l'origine des Francs* (1714). He maintained that the Franks were a league of South German tribes and not, according to the legend then almost universally received, a nation of free men deriving from Greece or Troy, who had kept their civilization intact in the heart of a barbarous country. These sensible views excited great indignation in the Abbé Vertot, who denounced Fréret to the government as a libeller of the monarchy. A *lettre de cachet* was issued, and Fréret was sent to the Bastille. During his three months of confinement he devoted himself to the study of the works of Xenophon, the fruit of which appeared later in his memoir on the *Cyropaedia*. From the time of his liberation in March 1715 his life was uneventful. In January 1716 he was received associate of the Academy of Inscriptions, and in December 1742 he was made perpetual secretary. He

worked without intermission for the interests of the Academy, not even claiming any property in his own writings, which were printed in the *Recueil de l'Académie des inscriptions*. The list of his memoirs, many of them posthumous, occupies four columns of the *Nouvelle Biographie générale*. They treat of history, chronology, geography, mythology and religion. Throughout he appears as the keen, learned and original critic; examining into the comparative value of documents, distinguishing between the mythical and the historical, and separating traditions with an historical element from pure fables and legends. He rejected the extreme pretensions of the chronology of Egypt and China, and at the same time controverted the scheme of Sir Isaac Newton as too limited. He investigated the mythology not only of the Greeks, but of the Celts, the Germans, the Chinese and the Indians. He was a vigorous opponent of the theory that the stories of mythology may be referred to historic originals. He also suggested that Greek mythology owed much to the Phoenicians and Egyptians. He was one of the first scholars of Europe to undertake the study of the Chinese language; and in this he was engaged at the time of his committal to the Bastille. He died in Paris on the 8th of March 1749.

Long after his death several works of an atheistic character were falsely attributed to him, and were long believed to be his. The most famous of these spurious works are the *Examen critique des apologues de la religion chrétienne* (1766), and the *Lettre de Thrasvule à Leucippe*, printed in London about 1768. A very defective and inaccurate edition of Fréret's works was published in 1796-1799. A new and complete edition was projected by Champollion-Figeac, but of this only the first volume appeared (1825). It contains a life of Fréret. His manuscripts, after passing through many hands, were deposited in the library of the Institute. The best account of his works is "Examen critique des ouvrages composés par Fréret" in C. A. Walkenaer's *Recueil des notices*, &c. (1841-1850). See also Quéraud's *France littéraire*.

FRÉRON, ÉLIE CATHERINE (1719-1776), French critic and controversialist, was born at Quimper in 1719. He was educated by the Jesuits, and made such rapid progress in his studies that before the age of twenty he was appointed professor at the college of Louis-le-Grand. He became a contributor to the *Observations sur les écrits modernes* of the abbé Guyot Desfontaines. The very fact of his collaboration with Desfontaines, one of Voltaire's bitterest enemies, was sufficient to arouse the latter's hostility, and although Fréron had begun his career as one of his admirers, his attitude towards Voltaire soon changed. Fréron in 1746 founded a similar journal of his own, entitled *Lettres de la Comtesse de*. It was suppressed in 1749, but he immediately replaced it by *Lettres sur quelques écrits de ce temps*, which, with the exception of a short suspension in 1752, on account of an attack on the character of Voltaire, was continued till 1754, when it was succeeded by the more ambitious *Année littéraire*. His death at Paris on the 10th of March 1776 is said to have been hastened by the temporary suppression of this journal. Fréron is now remembered solely for his attacks on Voltaire and the Encyclopaedists, and by the retaliations they provoked on the part of Voltaire, who, besides attacking him in epigrams, and even incidentally in some of his tragedies, directed against him a virulent satire, *Le Pauvre diable*, and made him the principal personage in a comedy *L'Écossaise*, in which the journal of Fréron is designated *L'Âne littéraire*. A further attack on Fréron entitled *Anecdotes sur Fréron* (1760), published anonymously, is generally attributed to Voltaire.

Fréron was the author of *Ode sur la bataille de Fontenoy* (1745); *Histoire de Marie Stuart* (1742, 2 vols.), and *Histoire de l'empire d'Allemagne*, (1771, 8 vols.). See Ch. Nisard, *Les Ennemis de Voltaire* (1853), Despois, *Journalistes et journaux du XVIII^e siècle*, Barthélemy, *Les confessions de Fréron*; Ch. Monselet, *Fréron ou l'illustre critique* (1864), Fréron, *sa vie, ses souvenirs*, &c. (1876).

FRÉRON, LOUIS MARIE STANISLAS (1754-1802), French revolutionist, son of the preceding, was born at Paris on the 17th of August 1754. His name was, on the death of his father, attached to *L'Année littéraire*, which was continued till 1799 and edited successively by the abbés G. M. Royou and J. L. Geoffroy. On the outbreak of the revolution Fréron, who was a schoolfellow of Robespierre and Camille Desmoulins, established

the violent journal *L'Orateur du peuple*. Commissioned, along with Barras in 1793, to establish the authority of the convention at Marseilles and Toulon, he distinguished himself in the atrocity of his reprisals, but both afterwards joined the Thermidorians, and Fréron became the leader of the *jeunesse dorée* and of the Thermidorian reaction. He brought about the accusation of Fouquier-Tinville, and of J. B. Carrier, the deportation of B. Barère, and the arrest of the last *Montagnards*. He made his paper the official journal of the reactionists, and being sent by the Directory on a mission of peace to Marseilles he published in 1796 *Mémoire historique sur la réaction royale et sur les malheurs du midi*. He was elected to the council of the Five Hundred, but not allowed to take his seat. Failing as suitor for the hand of Pauline Bonaparte, one of Napoleon's sisters, he went in 1799 as commissioner to Santo Domingo and died there in 1802. General V. M. Leclerc, who had married Pauline Bonaparte, also received a command in Santo Domingo in 1801, and died in the same year as his former rival.

FRESCO (Ital. for cool, "fresh"), a term introduced into English, both generally (as in such phrases as *al fresco*, "in the fresh air"), and more especially as a technical term for a sort of mural painting on plaster. In the latter sense the Italians distinguished painting *a secco* (when the plaster had been allowed to dry) from a *fresco* (when it was newly laid and still wet). The nature and history of fresco-painting is dealt with in the article **PAINTING**.

FRESCOBALDI, GIROLAMO (1583-1644), Italian musical composer, was born in 1583 at Ferrara. Little is known of his life except that he studied music under Alessandro Milleville, and owed his first reputation to his beautiful voice. He was organist at St Peter's in Rome from 1608 to 1628. According to Baini no less than 30,000 people flocked to St Peter's on his first appearance there. On the 20th of November 1628 he went to live in Florence, becoming organist to the duke. From December 1633 to March 1643 he was again organist at St Peter's. But in the last year of his life he was organist in the parish church of San Lorenzo in Monte. He died on the 2nd of March 1644, being buried at Rome in the Church of the Twelve Apostles. Frescobaldi also excelled as a teacher, Frohberger being the most distinguished of his pupils. Frescobaldi's compositions show the consummate art of the early Italian school, and his works for the organ more especially are full of the finest devices of fugal treatment. He also wrote numerous vocal compositions, such as canzone, motets, hymns, &c., a collection of madrigals for five voices (Antwerp, 1608) being among the earliest of his published works.

FRESENIUS, KARL REMIGIUS (1818-1897), German chemist, was born at Frankfurt-on-Main on the 28th of December 1818. After spending some time in a pharmacy in his native town, he entered Bonn University in 1840, and a year later migrated to Giessen, where he acted as assistant in Liebig's laboratory, and in 1843 became assistant professor. In 1845 he was appointed to the chair of chemistry, physics and technology at the Wiesbaden Agricultural Institution, and three years later he became the first director of the chemical laboratory which he induced the Nassau government to establish at that place. Under his care this laboratory continuously increased in size and popularity, a school of pharmacy being added in 1862 (though given up in 1877) and an agricultural research laboratory in 1868. Apart from his administrative duties Fresenius occupied himself almost exclusively with analytical chemistry, and the fullness and accuracy of his text-books on that subject (of which that on qualitative analysis first appeared in 1841 and that on quantitative in 1846) soon rendered them standard works. Many of his original papers were published in the *Zeitschrift für analytische Chemie*, which he founded in 1862 and continued to edit till his death. He died suddenly at Wiesbaden on the 11th of June 1897. In 1881 he handed over the directorship of the agricultural research station to his son, Remigius Heinrich Fresenius (b. 1847), who was trained under H. Kolbe at Leipzig. Another son, Theodor Wilhelm Fresenius (b. 1856), was educated at Strassburg and occupied various positions in the Wiesbaden laboratory.

XI 4*

FRESHWATER, a watering place in the Isle of Wight, England, 12 m. W. by S. of Newport by rail. Pop. (1901) 3306. It is a scattered township lying on the peninsula west of the river Var, which forms the western extremity of the island. The portion known as Freshwater Gate fronts the English Channel from the strip of low-lying coast interposed between the cliffs of the peninsula and those of the main part of the island. The peninsula rises to 397 ft. in Headon Hill, and the cliffs are magnificent. The western promontory is flanked on the north by the picturesque Alum Bay, and the lofty detached rocks known as the Needles lie off it. Farrington House in the parish was for some time the home of Alfred, Lord Tennyson, who is commemorated by a tablet in All Saints' church and by a great cross on the high downs above the town. There are golf links on the downs.

FRESNEL, AUGUSTIN JEAN (1788-1827), French physicist, the son of an architect, was born at Broglie (Eure) on the 10th of May 1788. His early progress in learning was slow, and when eight years old he was still unable to read. At the age of thirteen he entered the École Centrale in Caen, and at sixteen and a half the École Polytechnique, where he acquitted himself with distinction. Thence he went to the École des Ponts et Chaussées. He served as an engineer successively in the departments of Vendée, Drôme and Ille-et-Vilaine; but his espousal of the cause of the Bourbons in 1814 occasioned, on Napoleon's re-accession to power, the loss of his appointment. On the second restoration he obtained a post as engineer in Paris, where much of his life from that time was spent. His researches in optics, continued until his death, appear to have been begun about the year 1814, when he prepared a paper on the aberration of light, which, however, was not published. In 1818 he read a memoir on diffraction for which in the ensuing year he received the prize of the Académie des Sciences at Paris. He was in 1823 unanimously elected a member of the academy, and in 1825 he became a member of the Royal Society of London, which in 1827, at the time of his last illness, awarded him the Rumford medal. In 1819 he was nominated a commissioner of lighthouses, for which he was the first to construct compound lenses as substitutes for mirrors. He died of consumption at Ville-d'Avray, near Paris, on the 14th of July 1827.

The undulatory theory of light, first founded upon experimental demonstration by Thomas Young, was extended to a large class of optical phenomena, and permanently established by his brilliant discoveries and mathematical deductions. By the use of two plane mirrors of metal, forming with each other an angle of nearly 180°, he avoided the diffraction caused in the experiment of F. M. Grimaldi (1618-1663) on interference by the employment of apertures for the transmission of the light, and was thus enabled in the most conclusive manner to account for the phenomena of interference in accordance with the undulatory theory. With D. F. J. Arago he studied the laws of the interference of polarized rays. Circularly polarized light he obtained by means of a rhomb of glass, known as "Fresnel's rhomb," having obtuse angles of 126°, and acute angles of 54°. His labours in the cause of optical science received during his lifetime only scant public recognition, and some of his papers were not printed by the Académie des Sciences till many years after his decease. But, as he wrote to Young in 1824, in him "that sensibility, or that vanity, which people call love of glory" had been blunted. "All the compliments," he says, "that I have received from Arago, Laplace and Biot never gave me so much pleasure as the discovery of a theoretic truth, or the confirmation of a calculation by experiment."

See Duleau, "Notice sur Fresnel," *Revue encyc. t. xxxix.*; Arago, *Œuvres complètes*, t. i.; and Dr G. Peacock, *Miscellaneous Works of Thomas Young*, vol. i.

FRESNILLO, a town of the state of Zacatecas, Mexico, 37 m. N.W. of the city of Zacatecas on a branch of the Santiago river. Pop. (1900) 6300. It stands on a fertile plain between the Santa Cruz and Zacatecas ranges, about 7700 ft. above sea-level, has a temperate climate, and is surrounded by an agricultural district producing Indian corn and wheat. It is a clean, well-

built town, whose chief distinction is its school of mines founded in 1853. Fresno has large amalgam works for the reduction of silver ores. Its silver mines, located in the neighbouring Proano hill, were discovered in 1560, and were for a time among the most productive in Mexico. Since 1833, when their richest deposits were reached, the output has greatly decreased. There is a station near on the Mexican Central railway.

FRESNO, a city and the county-seat of Fresno county, California, U.S.A., situated in the San Joaquin valley (altitude about 300 ft.) near the geographical centre of the state. Pop. (1880) 1112; (1890) 10,818; (1900) 12,470, of whom 3299 were foreign-born and 1279 were Asiatics; (1910 census) 24,892. The city is served by the Southern Pacific and the Atchison, Topeka & Santa Fé railways. The county is mainly a vast expanse of naturally arid plains and mountains. The valley is the scene of an extensive irrigation system, water being brought (first in 1872-1876) from King's river, 20 m. distant; in 1905 500 sq. m. were irrigated. Fresno is in a rich farming country, producing grains and fruit, and is the only place in America where Smyrna figs have been grown with success; it is the centre of the finest raisin country of the state, and has extensive vineyards and wine-making establishments. The city's principal manufacture is preserved (dried) fruits, particularly raisins; the value of the fruits thus preserved in 1905 was \$6,942,440, being 70·5% of the total value of the factory product in that year (\$9,849,001). In 1900-1905 the factory product increased 257·9%, a ratio of increase greater than that of any other city in the state. In the mountains, lumbering and mining are important industries; lumber is carried from Shaver in the mountains to Clovis on the plains by a V-shaped flume 42 m. long, the waste water from which is ditched for irrigation. The petroleum field of the county is one of the richest in California. Fresno is the business and shipping centre of its county and of the surrounding region. The county was organized in 1856. In 1872 the railway went through, and Fresno was laid out and incorporated. It became the county-seat in 1874 and was chartered as a city in 1885.

FRESNOY, CHARLES ALPHONSE DU (1611-1665), French painter and writer on his art, was born in Paris, son of an apothecary. He was destined for the medical profession, and well educated in Latin and Greek; but, having a natural propensity for the fine arts, he would not apply to his intended vocation, and was allowed to learn the rudiments of design under Perrier and Vouet. At the age of twenty-one he went off to Rome, with no resources; he drew ruins and architectural subjects. After two years thus spent he re-encountered his old fellow-student Pierre Mignard, and by his aid obtained some amelioration of his professional prospects. He studied Raphael and the antique, went in 1633 to Venice, and in 1656 returned to France. During two years he was now employed in painting altar-pieces in the château of Raincy, landscapes, &c. His death was caused by an attack of apoplexy followed by palsy; he expired at Villiers le Bel, near Paris. He never married. His pictorial works are few; they are correct in drawing, with something of the Caracci in design, and of Titian in colouring, but wanting fire and expression, and insufficient to keep his name in any eminent repute. He is remembered now almost entirely as a writer rather than painter. His Latin poem, *De arte graphica*, was written during his Italian sojourn, and embodied his observations on the art of painting; it may be termed a critical treatise on the practice of the art, with general advice to students. The precepts are sound according to the standard of his time; the poetical merits slender enough. The Latin style is formed chiefly on Lucretius and Horace. This poem was first published by Mignard, and has been translated into several languages. In 1684 it was turned into French by Roger de Piles; Dryden translated the work into English prose; and a rendering into verse by Mason followed, to which Sir Joshua Reynolds added some annotations.

FRET. (1) (From O. Eng. *fretan*, a word common in various forms to Teutonic languages; cf. Ger. *fressen*, to eat greedily), properly to devour, hence to gnaw, so used of the slow corroding

action of chemicals, water, &c., and hence, figuratively, to chafe or irritate. Possibly connected with this word, in sense of rubbing, is the use of "fret" for a bar on the fingerboard of a banjo, guitar, or similar musical instruments to mark the fingering. (2) (Of doubtful origin; possibly from the O. Eng. *frætive*, ornaments, but its use is paralleled by the Fr. *frette*, (trellis or lattice), network, a term used in heraldry for an interlaced figure, but best known as applied to the decoration used by the Greeks in their temples and vases: the Greek fret consists of a series of narrow bands of different lengths, placed at right angles to one another, and of great variety of design. It is an ornament which owes its origin to woven fabrics, and is found on the ceilings of the Egyptian tombs at Benihasan, Siout and elsewhere. In Greek work it was painted on the abacus of the Doric capital and probably on the architraves of their temples; when employed by the Romans it was generally carved; the Propylæa of the temple at Damascus and the temple at Atil being examples of the 2nd century. It was carved in large dimensions on some of the Mexican temples, as for instance on the palace at Mitla with other decorative bands, all of which would seem to have been reproductions of woven patterns, and had therefore an independent origin. It is found in China and Japan, and in the latter country when painted on lacquer is employed as a fret-diaper, the bands not being at right angles to one another but forming acute and obtuse angles. In old English writers a wider signification was given to it, as it was applied to raised patterns in plaster on roofs or ceilings, which were not confined to the geometrical fret but extended to the modelling of flowers, leaves and fruit; in such cases the decoration was known as fret-work. In France the fret is better known as the "meander."

FREUDENSTADT, a town of Germany, in the kingdom of Württemberg, on the right bank of the Murg, 40 m. S.W. from Stuttgart, on the railway to Hochdorf. Pop. 7000. It has a Protestant and a Roman Catholic church, some small manufactures of cloth, furniture, knives, nails and glass, and is frequented as a climatic health resort. It was founded in 1599 by Protestant refugees from Salzburg.

FREUND, WILHELM (1806-1894), German philologist and lexicographer, was born at Kempen in the grand duchy of Posen on the 27th of January 1806. He studied at Berlin, Breslau and Halle, and was for twenty years chiefly engaged in private tuition. From 1855-1870 he was director of the Jewish school at Gleiwitz in Silesia, and subsequently retired to Breslau, where he died on the 4th of June 1894. Although chiefly known for his philological labours, Freund took an important part in the movement for the emancipation of his Prussian coreligionists, and the *Judengesetz* of 1847 was in great measure the result of his efforts. The work by which he is best known is his *Wörterbuch der lateinischen Sprache* (1834-1845), practically the basis of all Latin-English dictionaries. His *Wie studiert man klassische Philologie?* (6th ed., 1903) and *Triennium philologicum* (2nd ed., 1878-1885) are valuable aids to the classical student.

FREWEN, ACCEPTED (1588-1664), archbishop of York, was born at Northiam, in Sussex, and educated at Magdalen College, Oxford, where in 1612 he became a fellow. In 1617 and 1621 the college allowed him to act as chaplain to Sir John Digby, ambassador in Spain. At Madrid he preached a sermon which pleased Prince Charles, afterwards Charles I., and the latter on his accession appointed Frewen one of his chaplains. In 1635 he became canon of Canterbury and vice-president of Magdalen College, and in the following year he was elected president. He was vice-chancellor of the university in 1628 and 1629, and again in 1638 and 1639. It was mainly by his instrumentality that the university plate was sent to the king at York in 1642. Two years later he was consecrated bishop of Lichfield and Coventry, and resigned his presidency. Parliament declared his estates forfeited for treason in 1652, and Cromwell afterwards set a price on his head. The proclamations, however, designated him Stephen Frewen, and he was consequently able to escape into France. At the Restoration he reappeared in public, and in 1660 he was consecrated archbishop of York. In 1661 he acted as chairman of the Savoy conference.

FREY (Old Norse, Freyr) son of Njord, one of the chief deities in the northern pantheon and the national god of the Swedes. He is the god of fruitfulness, the giver of sunshine and rain, and thus the source of all prosperity. (See **TEUTONIC PEOPLES**, *ad fin.*)

FREYBURG [**FREYBURG AN DER UNSTRUT**], a town of Germany, in Prussian Saxony, in an undulating vine-clad country on the Unstrut, 6 m. N. from Naumberg-on-the-Saale, on the railway to Artern. Pop. 3200. It has a parish church, a mixture of Gothic and Romanesque architecture, with a handsome tower. It is, however, as being the "Mecca" of the German gymnastic societies that Freyburg is best known. Here Friedrich Ludwig Jahn (1778-1852), the father of German gymnastic exercises, lies buried. Over his grave is built the Turnhalle, with a statue of the "master," while hard by it the Jahn Museum in Romanesque style, erected in 1903. Freyburg produces sparkling wine of good quality and has some other small manufactures. On a hill commanding the town is the castle of Neuenburg, built originally in 1024 by Louis the Leaper, count in Thuringia, and in its present form mainly the work of the dukes of Saxe-Weissenfels.

FREYCINET, CHARLES LOUIS DE SAULCES DE (1828-), French statesman, was born at Foix on the 14th of November 1828. He was educated at the Ecole Polytechnique, and entered the government service as a mining engineer. In 1858 he was appointed traffic manager to the Compagnie de chemins de fer du Midi, a post in which he gave proof of his remarkable talent for organization, and in 1862 returned to the engineering service (in which he attained in 1866 the rank of inspector-general). He was sent on a number of special scientific missions, among which may be mentioned one to England, on which he wrote a notable *Mémoire sur le travail des femmes et des enfants dans les manufactures de l'Angleterre* (1867). On the establishment of the Third Republic in September 1870, he offered his services to Gambetta, was appointed prefect of the department of Tarn-et-Garonne, and in October became chief of the military cabinet. It was mainly his powers of organization that enabled Gambetta to raise army after army to oppose the invading Germans. He showed himself a strategist of no mean order; but the policy of dictating operations to the generals in the field was not attended with happy results. The friction between him and General d'Aurelle de Paladines resulted in the loss of the advantage temporarily gained at Orleans, and he was responsible for the campaign in the east, which ended in the destruction of Bourbaki's army. In 1871 he published a defence of his administration under the title of *La Guerre en province pendant le siège de Paris*. He entered the Senate in 1876 as a follower of Gambetta, and in December 1877 became minister of public works in the Dufaure cabinet. He carried a great scheme for the gradual acquisition of the railways by the state and the construction of new lines at a cost of three milliards, and for the development of the c.n.m.l system at a further cost of one milliard. He retained his post in the ministry of Waddington, whom he succeeded in December 1879 as president of the council and minister for foreign affairs. He passed an amnesty for the Communists, but in attempting to steer a middle course on the question of the religious associations, lost the support of Gambetta, and resigned in September 1880. In January 1882 he again became president of the council and minister for foreign affairs. His refusal to join England in the bombardment of Alexandria was the death-knell of French influence in Egypt. He attempted to compromise by occupying the Isthmus of Suez, but the vote of credit was rejected in the Chamber by 417 votes to 75, and the ministry resigned. He returned to office in April 1883 as foreign minister in the Brisson cabinet, and retained that post when, in January 1886, he succeeded to the premiership. He came into power with an ambitious programme of internal reform; but except that he settled the question of the exiled pretenders, his successes were won chiefly in the sphere of colonial extension. In spite of his unrivalled skill as a parliamentary tactician, he failed to keep his party together, and was defeated on 3rd December 1886. In the following year, after two unsuccessful attempts

to construct new ministries he stood for the presidency of the republic; but the radicals, to whom his opportunism was distasteful, turned the scale against him by transferring the votes to M. Sadi Carnot.

In April 1888 he became minister of war in the Floquet cabinet—the first civilian since 1848 to hold that office. His services to France in this capacity were the crowning achievement of his life, and he enjoyed the conspicuous honour of holding his office without a break for five years through as many successive administrations—those of Floquet and Tirard, his own fourth ministry (March 1890-February 1892), and the Loubet and Ribot ministries. To him were due the introduction of the three-years' service and the establishment of a general staff, a supreme council of war, and the army commands. His premiership was marked by heated debates on the clerical question, and it was a hostile vote on his Bill against the religious associations that caused the fall of his cabinet. He failed to clear himself entirely of complicity in the Panama scandals, and in January 1893 resigned the ministry of war. In November 1898 he once more became minister of war in the Dupuy cabinet, but resigned office on 6th May 1899. He has published, besides the works already mentioned, *Traité de mécanique rationnelle* (1858); *De l'analyse infinitésimale* (1860, revised ed., 1881); *Des pentes économiques en chemin de fer* (1861); *Emploi des eaux d'égout en agriculture* (1869); *Principes de l'assainissement des villes et Traité d'assainissement industriel* (1870); *Essai sur la philosophie des sciences* (1896); *La Question d'Égypte* (1905); besides some remarkable "Pensées" contributed to the *Contemporain* under the pseudonym of "Alceste." In 1882 he was elected a member of the Academy of Sciences, and in 1890 to the French Academy in succession to Émile Augier.

FREYCINET, LOUIS CLAUDE DESAULCES DE (1779-1842), French navigator, was born at Montélimart, Drôme, on the 7th of August 1779. In 1793 he entered the French navy. After taking part in several engagements against the British, he joined in 1800, along with his brother Louis Henri Freycinet (1777-1840), who afterwards rose to the rank of admiral, the expedition sent out under Captain Baudin in the "Naturaliste" and "Géographe" to explore the south and south-west coasts of Australia. Much of the ground already gone over by Flinders was revisited, and new names imposed by this expedition, which claimed credit for discoveries really made by the English navigator. An inlet on the coast of West Australia, in 26° S., is called Freycinet Estuary; and a cape near the extreme south-west of the same coast also bears the explorer's name. In 1805 he returned to Paris, and was entrusted by the government with the work of preparing the maps and plans of the expedition; he also completed the narrative, and the whole work appeared under the title of *Voyage de découvertes aux terres australes* (Paris, 1807-1816). In 1817 he commanded the "Uranie," in which Arago and others went to Rio de Janeiro, to take a series of pendulum measurements. This was only part of a larger scheme for obtaining observations, not only in geography and ethnology, but in astronomy, terrestrial magnetism, and meteorology, and for the collection of specimens in natural history. On this expedition the hydrographic operations were conducted by Louis Isidore Duperry (1786-1865) who in 1822 was appointed to the command of the "Coquille," and during the next three years carried out scientific explorations in the southern Pacific and along the coast of South America. For three years Freycinet cruised about, visiting Australia, the Marianne, Sandwich, and other Pacific islands, South America, and other places, and, notwithstanding the loss of the "Uranie" on the Falkland Islands during the return voyage, returned to France with fine collections in all departments of natural history, and with voluminous notes and drawings which form an important contribution to a knowledge of the countries visited. The results of this voyage were published under Freycinet's supervision, with the title of *Voyage autour du monde sur les corvettes "l'Uranie" et "la Physicienne"* in 1824-1844, in 13 quarto volumes and 4 folio volumes of fine plates and maps. Freycinet was admitted into the Academy of Sciences in 1825, and was one

of the founders of the Paris Geographical Society. He died at Freycinet, Drôme, on the 18th of August 1842.

FREYIA, the sister of Frey, and the most prominent goddess in Northern mythology. Her character seems, in general to have resembled that of her brother. (See *TEUTONIC PEOPLES*, *ad fin.*)

FREYTAG, GEORG WILHELM FRIEDRICH (1788-1861), German philologist, was born at Lüneburg on the 10th of September 1788. After attending school he entered the university of Göttingen as a student of philology and theology; here from 1811 to 1813 he acted as a theological tutor, but in the latter year accepted an appointment as sub-librarian at Königsberg. In 1815 he became a chaplain in the Prussian army, and in that capacity visited Paris. On the proclamation of peace he resigned his chaplaincy, and returned to his researches in Arabic, Persian and Turkish, studying at Paris under De Sacy. In 1819 he was appointed to the professorship of oriental languages in the new university of Bonn, and this post he continued to hold until his death on the 16th of November 1861.

Besides a compendium of Hebrew grammar (*Kurzgefasste Grammatik der hebräischen Sprache*, 1835), and a treatise on Arabic versification (*Darstellung der arabischen Verskunst*, 1830), he edited two volumes of Arabic songs (*Hamasae carmina*, 1828-1852) and three of Arabic proverbs (*Arabum proverbia*, 1838-1843). But his principal work was the laborious and praiseworthy *Lexicon Arabico-latinum* (Halle, 1830-1837), an abridgment of which was published in 1837.

FREYTAG, GUSTAV (1816-1895), German novelist, was born at Kreuzburg, in Silesia, on the 13th of July 1816. After attending the gymnasium at Öls, he studied philology at the universities of Breslau and Berlin, and in 1838 took the degree with a remarkable dissertation, *De initiis poetos scenicae apud Germanos*. In 1839 he settled at Breslau, as *Privatdocens* in German language and literature, but devoted his principal attention to writing for the stage, and achieved considerable success with the comedy *Die Brautfahrt, oder Kunst von der Rosen* (1844). This was followed by a volume of unimportant poems, *In Breslau* (1845) and the dramas *Die Valentine* (1846) and *Graf Waldemar* (1847). He at last attained a prominent position by his comedy, *Die Journalisten* (1853), one of the best German comedies of the 19th century. In 1847 he migrated to Berlin, and in the following year took over, in conjunction with Julian Schmidt, the editorship of *Die Grenzboten*, a weekly journal which, founded in 1847, now became the leading organ of German and Austrian liberalism. Freytag helped to conduct it until 1861, and again from 1867 till 1870, when for a short time he edited a new periodical, *Im neuen Reich*. His literary fame was made universal by the publication in 1855 of his novel, *Soll und Haben*, which was translated into almost all the languages of Europe. It was certainly the best German novel of its day, impressive by its sturdy but unexaggerated realism, and in many parts highly humorous. Its main purpose is the recommendation of the German middle class as the soundest element in the nation, but it also has a more directly patriotic intention in the contrast which it draws between the homely virtues of the Teuton and the shiftlessness of the Pole and the rapacity of the Jew. As a Silesian, Freytag had no great love for his Slavonic neighbours, and being a native of a province which owed everything to Prussia, he was naturally an earnest champion of Prussian hegemony over Germany. His powerful advocacy of this idea in his *Grenzboten* gained him the friendship of the duke of Saxe-Coburg-Gotha, whose neighbour he had become, on acquiring the estate of Siebleben near Gotha. At the duke's request Freytag was attached to the staff of the crown prince of Prussia in the campaign of 1870, and was present at the battles of Wörth and Sedan. Before this he had published another novel, *Die verlorene Handschrift* (1864), in which he endeavoured to do for German university life what in *Soll und Haben* he had done for commercial life. The hero is a young German professor, who is so wrapt up in his search for a manuscript by Tacitus that he is oblivious to an impending tragedy in his domestic life. The book was, however, less successful than its predecessor. Between 1859 and 1867 Freytag published in five volumes *Bilder aus der deutschen Vergangenheit*, a most valuable work on popular lines, illustrating

the history and manners of Germany. In 1872 he began a work with a similar patriotic purpose, *Die Ahnen*, a series of historical romances in which he unfolds the history of a German family from the earliest times to the middle of the 19th century. The series comprises the following novels, none of which, however, reaches the level of Freytag's earlier books. (1) *Ingo und Ingriden* (1872), (2) *Das Nest der Zaunkönige* (1874), (3) *Die Brüder vom deutschen Hause* (1875), (4) *Marcus König* (1876), (5) *Die Geschwister* (1878), and (6) in conclusion, *Aus einer kleinen Stadt* (1880). Among Freytag's other works may be noticed *Die Technik des Dramas* (1863); an excellent biography of the Baden statesman *Karl Mathy* (1869); an autobiography (*Erinnerungen aus meinem Leben*, 1887); his *Gesammelte Aufsätze*, chiefly reprinted from the *Grenzboten* (1888); *Der Kronprinz und die deutsche Kaiserkrone*; *Erinnerungsbilder* (1889). He died at Wiesbaden on the 30th of April 1895.

Freytag's *Gesammelte Werke* were published in 22 vols. at Leipzig (1886-1888); his *Vermischte Aufsätze* have been edited by E. Elster, 2 vols. (Leipzig, 1901-1903). On Freytag's life see, besides his autobiography mentioned above, the lives by C. Alberti (Leipzig, 1890) and F. Seiler (Leipzig, 1898).

FRIAR (from the Lat. *frater*, through the Fr. *frère*); the English generic name for members of the mendicant religious orders. Formerly it was the title given to individual members of these orders, as Friar Laurence (in *Romeo and Juliet*), but this is not now common. In England the chief orders of friars were distinguished by the colour of their habit: thus the Franciscans or Minors were the Grey Friars; the Dominicans or Preachers were the Black Friars (from their black mantle over a white habit), and the Carmelites were the White Friars (from their white mantle over a brown habit): these, together with the Austin Friars or Hermits, formed the four great mendicant orders—Chaucer's "alle the ordres fourre." Besides the four great orders of friars, the Trinitarians (*q.v.*), though really canons, were in England called Trinity Friars or Red Friars; the Crutched or Crossed Friars were often identified with them, but were really a distinct order; there were also a number of lesser orders of friars, many of which were suppressed by the second council of Lyons in 1274. Detailed information on these orders and on their position in England is given in separate articles. The difference between friars and monks is explained in article *MONASTICISM*. Though the usage is not accurate, friars, and also canons regular, are often spoken of as monks and included among the monastic orders.

See Fr. Cuthbert, *The Friars and how they came to England*, pp. 11-32 (1903); also F. A. Gasquet, *English Monastic Life*, pp. 234-249 (1904), where special information on all the English friars is conveniently brought together (E. C. B.)

FRIBOURG [Ger. *Freiburg*], one of the Swiss Cantons, in the western portion of the country, and taking its name from the town around which the various districts that compose it gradually gathered. Its area is 646.3 sq. m., of which 568 sq. m. are classed as "productive" (forests covering 119 sq. m. and vineyards 8 sq. m.); it boasts of no glaciers or eternal snow. It is a hilly, not mountainous, region, the highest summits (of which the Vanil Noir, 785 ft., is the loftiest) rising in the Gruyère district at its south-eastern extremity, the best known being probably the Moléson (658 ft.) and the Berra (563 ft.). But it is the heart of pastoral Switzerland, is famed for its cheese and cattle, and is the original home of the "*Rans des Vaches*," the melody by which the herdsmen call their cattle home at milking time. It is watered by the Sarine or Saane river (with its tributaries the Singine or Sense and the Glâne) that flows through the canton from north to south, and traverses its capital town. The upper course of the Broye (like the Sarine, a tributary of the Aar) and that of the Veveyse (flowing to the Lake of Geneva) are in the southern portion of the canton. A small share of the lakes of Neuchâtel and of Morat belongs to the canton, whereas the largest sheet of water is the Lac Noir or Schwarsee. A sulphur spring rises near the last-named lake, and there are other such springs in the canton at Montbarry and at Bonn, near the capital. There are about 150 m. of railways in the canton, the main line from Lausanne to Bern past Fribourg, running through

are also lines from Fribourg to Morat and to Estavayer, Romont (on the main line) a line runs to Bulle, and has extended to Gessenay or Saanen near the head of the Saane valley. The population of the canton amounted to 127,051 souls, of whom 108,440 were Romanists, protestants, and 167 Jews. The canton is on the linguistic line in Switzerland, the line of division running nearly due south through it, and even right through its capital.

There were 78,353 French-speaking inhabitants, and German-speaking, the latter being found chiefly in the stern (Morat region) and north-eastern (Singine valley), as well as in the upper valley of the Jogne or Jaun in the east. Besides the capital, Fribourg (*q.v.*), the only of any importance are Bulle (3330 inhabitants), Châtel (2509 inhabitants), Morat (*q.v.*) or Murten (2263 in-), Romont (2110 inhabitants), and Estavayer le Lac (1636 inhabitants).

The canton is pre-eminently a pastoral and agricultural, tobacco, cheese and timber being its chief products. Industries are comparatively few: straw-plaiting, watch-making (Semsales), paper-making (Marly), lime-kilns, and, above all, the huge Cailler chocolate factory at Broc. It forms part of the diocese of Lausanne and Geneva, the bishop living since 1814 at Fribourg. It is a stronghold of the Romanists, and still many monasteries and nunneries, such as the Carthusian at Valsainte, and the Cistercian nuns at La Fille Dieu (Faigne). The canton is divided into 7 administrative districts, and contains 283 communes. It sends 2 members to the cantonal legislature (to the Federal *Ständerath*), and 1 member to the Federal *Nationalrath*. The cantonal constitution has scarcely been altered since 1857, and is remarkable for containing none of the modern devices (referendum, proportional representation) save the right of "initiative" enjoyed by 6000 citizens to claim the revision of the constitution. The executive council of 7 members is elected for 5 years by the cantonal legislature, which consists of 100 members (holding office for 5 years) elected in the proportion of 1 every 1200 (or fraction over 800) of the population.

(W. A. B. C.)

FRIBOURG [Ger. *Freiburg*], the capital of the Swiss canton of Fribourg. It is built almost entirely on the left bank of the Bourge, the oldest bit (the Bourg) of the town being just above the river bank, flanked by the Neuveville and Auge quarters, and the Plancher quarter on the right bank of the Bourge forming the *Ville Basse*. On the steeply rising ground to the west of the Bourg is the *Quartier des Places*, beyond to the west and south-west, is the still newer *Pérolles*, where are the railway station and the new University; to the east (with the Bourg) constituting the *Ville Haute*. In 1814 the population of the town was 15,794, of whom 13,270 were Romanists and 100 Jews, while 9701 were French-speaking, 5 German-speaking, these last being mainly in the *Ville Haute*. Its linguistic history is curious. Founded as a German town, the French tongue became the official language during the part of the 14th and 15th centuries, but when it joined the Swiss Confederation in 1481 the German influence came to the fore, and German was the official language from 1483 to 1798, though thus associated with the rule of the patricians. From 1814, and again from 1830 onwards, French prevailed, and is now the official language, though the new University is a centre of German culture.

The town is on the main line of railway from Bern (20 m.) to Lausanne (41 m.). The principal building in the town is the church of St Nicholas, of which the nave dates from the 12th century, while the choir was rebuilt in the 17th century.

It is a fine building, remarkable in itself, as well as for its lofty, late 15th century, bell-tower (249 ft. high), with a set of bells; its famous organ was built between 1824 and 1834 by Aloys Mosser (a native of the town), has 7800 pipes, and is played daily in summer for the edification of tourists. The numerous monasteries in and around the town, its old aspect, its steep and narrow streets, give it a most

striking appearance. One of the most conspicuous buildings in the town is the college of St Michael, while in front of the 16th century town hall is an ancient lime tree stated (but this is very doubtful) to have been planted on the day of the victory of Morat (June 22, 1476). In the Lycée is the Cantonal Museum of Fine Arts, wherein, besides many interesting objects, is the collection of paintings and statuary bequeathed to the town in 1879 by Duchess Adela Colonna (a member of the d'Affry family of Fribourg), by whom many were executed under the name of "Marcello." The deep ravine of the Sarine is crossed by a very fine suspension bridge, constructed 1832-1834 by M. Chaley, of Lyons, which is 167 ft. above the Sarine, has a span of 808 ft., and consists of 6 huge cables composed of 3294 strands. A loftier suspension bridge is thrown over the Gotteron stream just before it joins the Sarine: it is 590 ft. long and 246 ft. in height, and was built in 1840. About 3 m. north of the town is the great railway viaduct or girder bridge of Grandfey, constructed in 1862 (1092 ft. in length, 249 ft. high) at a cost of 2½ million francs. Immediately above the town a vast dam (591 ft. long) was constructed across the Sarine by the engineer Ritter in 1870-1872, the fall thus obtained yielding a water-power of 2600 to 4000 horse-power, and forming a sheet of water known as the Lac de Pérolles. A motive force of 600 horse-power, secured by turbines in the stream, is conveyed to the plateau of Pérolles by "telodynamic" cables of 2510 ft. in length, for whose passage a tunnel has been pierced in the rock. On the Pérolles plateau is the International Catholic University founded in 1889.

History.—In 1178 the foundation of the town (meant to hold in check the turbulent nobles of the neighbourhood) was completed by Berchtold IV., duke of Zähringen, whose father Conrad had founded Freiburg in Breisgau in 1120, and whose son, Berchtold V., was to found Bern in 1191. The spot was chosen for purposes of military defence, and was situated in the *Uechtland* or waste land between Alamannian and Burgundian territory. He granted it many privileges, modelled on the charters of Cologne and of Freiburg in Breisgau, though the oldest existing charter of the town dates from 1249. On the extinction of the male line of the Zähringen dynasty, in 1218, their lands passed to Anna, the sister of the last duke and wife of Count Ulrich of Kyburg. That house kept Fribourg till it too became extinct, in 1264, in the male line. Anna, the heiress, married about 1273 Eberhard, count of Habsburg-Laufenburg, who sold Fribourg in 1277 for 3000 marks to his cousin Rudolf, the head of the house of Habsburg as well as emperor. The town had to fight many a hard battle for its existence against Bern and the count of Savoy, especially between 1448 and 1452. Abandoned by the Habsburgs, and desirous of escaping from the increasing power of Bern, Fribourg in 1452 finally submitted to the count of Savoy, to whom it had become indebted for vast sums of money. Yet, despite all its difficulties, it was in the first half of the 15th century that Fribourg exported much leather and cloth to France, Italy and Venice, as many as 10,000 to 20,000 bales of cloth being stamped with the seal of the town. When Yolande, dowager duchess of Savoy, entered into an alliance with Charles the Bold, duke of Burgundy, Fribourg joined Bern, and helped to gain the victories of Grandson and of Morat (1476).

In 1477 the town was finally freed from the rule of Savoy, while in 1481 (with Soleure) it became a member of the Swiss Confederation, largely, it is said, through the influence of the holy man, Bruder Klaus (Niklaus von der Flüe). In 1475 the town had taken Illens and Arcenciel from Savoy, and in 1536 won from Vaud much territory, including Romont, Rue, Châtel St Denis, Estavayer, St Aubin (by these two conquests its dominion reached the Lake of Neuchâtel), as well as Vuissens and Surpierre, which still form outlying portions (physically within the canton of Vaud) of its territory, while in 1537 it took Bulle from the bishop of Lausanne. In 1502-1504 the lordship of Bellegarde or Jaun was bought, while in 1555 it acquired (jointly with Bern) the lands of the last count of the Gruyère, and thus obtained the rich district of that name. From 1475 it ruled (with Bern) the balliwicks of Morat, Grandson, Orbe and

Echallens, just taken from Savoy, but in 1798 Morat was incorporated with (finally annexed in 1814) the canton of Fribourg, the other bailiwicks being then given to the canton of Léman (later of Vaud). In the 16th century the original democratic government gradually gave place to the oligarchy of the patrician families. Though this government caused much discontent it continued till it was overthrown on the French occupation of 1798.

From 1803 (Act of Mediation) to 1814, Fribourg was one of the six cantons of the Swiss Confederation. But, on the fall of the new régime, in 1814, the old patrician rule was partly restored, as 108 of the 144 seats in the cantonal legislature were assigned to members of the patrician families. In 1831 the Radicals gained the power and secured the adoption of a more liberal constitution. In 1846 Fribourg (where the Conservatives had regained power in 1837) joined the *Sonderbund* and, in 1847, saw the Federal troops before its walls, and had to surrender to them. The Radicals now came back to power, and again revised the cantonal constitution in a liberal sense. The Catholic and Conservative party made several attempts to recover their supremacy, but their chiefs were driven into exile. In 1856 the Conservatives regained the upper hand at the general cantonal election, secured the adoption in 1857 of a new cantonal constitution, and have ever since maintained their rule, which some dub "clerical," while others describe it as "anti-radical."

AUTHORITIES.—*Archives de la Société d'histoire du Canton de F.*, from 1850; F. Buomberger, *Bevölkerungs- u. Vermögensstatistik in d. Stadt u. Landschaft F. um die Mitte d. 15ten Jahrhunderts* (Bern, 1900); A. Daguët, *Histoire de la ville et de la seigneurie de F.*, to 1481 (Fribourg, 1889); A. Dellion, *Dictionnaire historique et statistique des paroisses catholiques du C. de F.* (12 vols., Fribourg, 1884-1903); *Freiburger Geschichtsbilder*, from 1894; *Freiburger aristique* (fine plates), from 1890; E. Heyck, *Geschichte der Herzoge von Zähringen* (Freiburg i. Br., 1891); F. Kuenlin, *Der K. Freiburg* (St Gall and Bern, 1834); *Mémorial de F.* (6 vols., 1854-1859); *Recueil diplomatique du Cant. de F.* (original documents) (8 vols., Fribourg, 1839-1877); F. E. Welti, *Beiträge zur Geschichte des älteren Stadtrechts von Freiburg im Uechtland* (Bern, 1908); J. Zemp, *L'Art de la ville de Fribourg au moyen âge* (Fribourg, 1905); J. Zimmerli, *Die deutsch-französische Sprachgrenze in d. Schweiz* (Basel and Geneva, 1895), vol. ii., pp. 72 seq.; *Les Alpes fribourgeoises* (Lausanne, 1908). (W.A. B.C.)

FRICTION (from Lat. *fricare*, to rub), in physical and mechanical science, the term given to the resistance which every material surface presents to the sliding of any other such surface upon it. This resistance is due to the roughness of the surfaces; the minute projections upon each enter more or less into the minute depressions on the other, and when motion occurs these roughnesses must either be worn off, or continually lifted out of the hollows into which they have fallen, or both, the resistance to motion being in either case quite perceptible and measurable.

Friction is preferably spoken of as "resistance" rather than "force," for a reason exactly the same as that which induces us to treat stress rather as molecular resistance (to change of form) than as force, and which may be stated thus: although friction can be utilized as a moving force at will, and is continually so used, yet it cannot be a primary moving force; it can transmit or modify motion already existing, but cannot in the first instance cause it. For this some external force, not friction, is required. The analogy with stress appears complete; the motion of the "driving link" of a machine is communicated to all the other parts, modified or unchanged as the case may be, by the stresses in those parts; but the actual setting in motion of the driving link itself cannot come about by stress, but must have for its production force obtained directly from the expenditure of some form of energy. It is important, however, that the use of the term "resistance" should not be allowed to mislead. Friction resists the motion of one surface upon another, but it may and frequently does confer the motion of the one upon the other, and in this way causes, instead of resists, the motion of the latter. This may be made more clear, perhaps, by an illustration. Suppose we have a leather strap A passing over a fixed cylindrical drum B, and let a pulling force or effort be applied to the strap. The force applied to A can act on B only at the surfaces of contact between them. There it becomes an effort tending either to move

A upon B, or to move the body B itself, according to the frictional conditions. In the absence of friction it would simply cause A to slide on B, so that we may call it an effort tending to make A slide on B. The friction is the resistance offered by the surface of B to any such motion. But the value of this resistance is not in any way a function of the effort itself,—it depends chiefly upon the pressure normal to the surfaces and the nature of the surfaces. It may therefore be either less or greater than the effort. If less, A slides over B, the rate of motion being determined by the excess of the effort over the resistance (friction). But if the latter be greater no sliding can occur, *i.e.* A cannot, under the action of the supposed force, move upon B. The effort between the surfaces exists, however, exactly as before,—and it must now tend to cause the motion of B. But the body B is fixed,—or, in other words, we suppose its resistance to motion greater than any effort which can tend to move it,—hence no motion takes place. It must be specially noticed, however, that it is not the friction between A and B that has prevented motion, this only prevented A moving on B,—it is the force which keeps B stationary, whatever that may be, which has finally prevented any motion taking place. This can be easily seen. Suppose B not to be fixed, but to be capable of moving against some third body C (which might, *e.g.*, contain cylindrical bearings, if B were a drum with its shaft), itself fixed,—and further, suppose the frictional resistance between B and C to be the only resistance to B's motion. Then if this be less than the effort of A upon B, as it of course may be, this effort will cause the motion of B. Thus friction causes motion, for had there been no frictional resistance between the surfaces of A and B, the latter body would have remained stationary, and A only would have moved. In the case supposed, therefore, the friction between A and B is a necessary condition of B receiving any motion from the external force applied to A.

Without entering here on the mathematical treatment of the subject of friction, some general conclusions may be pointed out which have been arrived at as the results of experiment. The "laws" first enunciated by C. A. Coulomb (1781), and afterwards confirmed by A. J. Morin (1830-1834), have been found to hold good within very wide limits. These are: (1) that the friction is proportional to the normal pressure between the surfaces of contact, and therefore independent of the area of those surfaces, and (2) that it is independent of the velocity with which the surfaces slide one on the other. For many practical purposes these statements are sufficiently accurate, and they do in fact sensibly represent the results of experiment for the pressures and at the velocities most commonly occurring. Assuming the correctness of these, friction is generally measured in terms simply of the total pressure between the surfaces, by multiplying it by a "coefficient of friction" depending on the material of the surfaces and their state as to smoothness and lubrication. But beyond certain limits the "laws" stated are certainly incorrect, and are to be regarded as mere practical rules, of extensive application certainly, but without any pretension to be looked at as really general laws. Both at very high and very low pressures the coefficient of friction is affected by the intensity of pressure, and, just as with velocity, it can only be regarded as independent of the intensity and proportional simply to the total load within more or less definite limits.

Coulomb pointed out long ago that the resistance of a body to be set in motion was in many cases much greater than the resistance which it offered to continued motion; and since his time writers have always distinguished the "friction of rest," or static friction, from the "friction of motion," or kinetic friction. He showed also that the value of the former depended often both upon the intensity of the pressure and upon the length of time during which contact had lasted, both of which facts quite agree with what we should expect from our knowledge of the physical nature, already mentioned, of the causes of friction. It seems not unreasonable to expect that the influence of time upon friction should show itself in a comparison of very slow with very rapid motion, as well as in a comparison of starting (*i.e.* motion after a long time of rest) with continued

motion. That the friction at the higher velocities occurring in engineering practice is much less than at common velocities has been shown by several modern experiments, such as those of Sir Douglas Galton (see *Report Brit. Assoc.*, 1878, and *Proc. Inst. Mech. Eng.*, 1878, 1879) on the friction between brake-blocks and wheels, and between wheels and rails. But no increase in the coefficient of friction had been detected at slow speeds, until the experiments of Prof. Fleeming Jenkin (*Phil. Trans.*, 1877, pt. 2) showed conclusively that at extremely low velocities (the lowest measured was about .0002 ft. per second) there is a sensible increase of frictional resistance in many cases, most notably in those in which there is the most marked difference between the friction of rest and that of motion. These experiments distinctly point to the conclusion, although without absolutely proving it, that in such cases the coefficient of kinetic friction gradually increases as the velocity becomes extremely small, and passes without discontinuity into that of static friction.

(A. B. W. K.; W. E. D.)

FRIDAY (A.S. *frige-dag*, fr. *frige*, gen. of *frige*, love, or the goddess of love—the Norse *Frigg*,—the *dæg*, day; cf. Icelandic *frídagur*, O.H. Ger. *frīatag*, *frīatag*, mod. Ger. *Freitag*), the sixth day of the week, corresponding to the Roman *Dies Veneris*, the French *Vendredi* and Italian *Venerdì*. The ill-luck associated with the day undoubtedly arose from its connexion with the Crucifixion; for the ancient Scandinavian peoples regarded it as the luckiest day of the week. By the Western and Eastern Churches the Fridays throughout the year, except when Christmas falls on that day, have ever been observed as days of fast in memory of the Passion. The special day on which the Passion of Christ is annually commemorated is known as Good Friday (*q.v.*). According to Mahomedan tradition, Friday, which is the Moslem Sabbath, was the day on which Adam was created, entered Paradise and was expelled, and it was the day of his repentance, the day of his death, and will be the Day of Resurrection.

FRIEDBERG, the name of two towns in Germany.

1. A small town in Upper Bavaria, with an old castle, known mainly as the scene of Moreau's victory of the 24th of August 1796 over the Austrians.

2. **FRIEDBERG** IN DER WETTERAU, in the grand duchy of Hesse-Darmstadt, on an eminence above the Usa, 14 m. N. of Frankfurt-on-Main, on the railway to Cassel and at the junction of a line to Hanau. Pop. (1905) 7702. It is a picturesque town, still surrounded by old walls and towers, and contains many medieval buildings, of which the beautiful Gothic town church (Evangelical) and the old castle are especially noteworthy. The grand-ducal palace has a beautiful garden. The schools include technical and agricultural academies and a teachers' seminary. It has manufactures of sugar, gloves and leather, and breweries. Friedberg is of Roman origin, but is first mentioned as a town in the 11th century. In 1211 it became a free imperial city, but in 1349 was pledged to the counts of Schwarzbürg, and subsequently often changed hands, eventually in 1802 passing to Hesse-Darmstadt.

See Dieffenbach, *Geschichte der Stadt und Burg Friedberg* (Darms., 1857).

FRIEDEL, CHARLES (1832-1899), French chemist and mineralogist, was born at Strassburg on the 12th of March 1832. After graduating at Strassburg University he spent a year in the counting-house of his father, a banker and merchant, and then in 1851 went to live in Paris with his maternal grandfather, Georges Louis Duvernoy (1777-1855), professor of natural history and, from 1850, of comparative anatomy, at the Collège de France. In 1854 he entered C. A. Wurtz's laboratory, and in 1856, at the instance of H. H. de Sénarmont (1808-1862), was appointed conservator of the mineralogical collections at the École des Mines. In 1871 he began to lecture in place of A. L. O. L. Des Cloizeaux (1817-1897) at the École Normale, and in 1876 he became professor of mineralogy at the Sorbonne, but on the death of Wurtz in 1884 he exchanged that position for the chair of organic chemistry. He died at Montauban on the 20th of April 1899. Friedel achieved distinction both in miner-

alogy and organic chemistry. In the former he was one of the leading workers, in collaboration from 1879 to 1887 with Émile Edmond Sarasin (1843-1890), at the formation of minerals by artificial means; particularly in the wet way with the aid of heat and pressure, and he succeeded in reproducing a large number of the natural compounds. In 1893, as the result of an attempt to make diamond by the action of sulphur on highly carburetted cast iron at 450°-500° C. he obtained a black powder too small in quantity to be analysed but hard enough to scratch corundum. He also devoted much attention to the pyroelectric phenomena of crystals, which served as the theme of one of the two memoirs he presented for the degree of D.Sc. in 1869, and to the determination of crystallographic constants. In organic chemistry, his study of the ketones and aldehydes, begun in 1857, provided him with the subject of his other doctoral thesis. In 1862 he prepared secondary propyl alcohol, and in 1863, with James Mason Crafts (b. 1839), for many years a professor at the Massachusetts Institute of Technology, Boston, he obtained various organometallic compounds of silicon. A few years later further work, with Albert Ladenburg, on the same element yielded silicochloroform and led to a demonstration of the close analogy existing between the behaviour in combination of silicon and carbon. In 1871, with R. D. da Silva (b. 1837) he synthesized glycerin, starting from propylene. In 1877, with Crafts, he made the first publication of the fruitful and widely used method for synthesizing benzene homologues now generally known as the "Friedel and Crafts reaction." It was based on an accidental observation of the action of metallic aluminium on amyl chloride, and consists in bringing together a hydrocarbon and an organic chloride in presence of aluminium chloride, when the residues of the two compounds unite to form a more complex body. Friedel was associated with Wurtz in editing the latter's *Dictionnaire de chimie*, and undertook the supervision of the supplements issued after 1834. He was the chief founder of the *Revue générale de chimie* in 1899. His publications include a *Notice sur la vie et les travaux de Wurtz* (1885), *Cours de chimie organique* (1887) and *Cours de minéralogie* (1893). He acted as president of the International Congress held at Geneva in 1892 for revising the nomenclature of the fatty acid series.

See a memorial lecture by J. M. Crafts, printed in the *Journal of the London Chemical Society* for 1900.

FRIEDLAND, a town of Bohemia, Austria, 103 m. N.E. of Prague by rail. Pop. (1900) 6229. Besides the old town, which is still surrounded by walls, it contains three suburbs. The principal industry is the manufacture of woollen and linen cloth. Friedland is chiefly remarkable for its old castle, which occupies an imposing situation on a small hill commanding the town. A round watch-tower is said to have been built on its site as early as 1014; and the present castle dates from the 13th century. It was several times besieged in the Thirty Years' and Seven Years' Wars. In 1622 it was purchased by Wallenstein, who took from it his title of duke of Friedland. After his death it was given to Count Mathias Gallas by Ferdinand II., and since 1757 it has belonged to the Count Clam Gallas. It was magnificently restored in 1868-1869.

FRIEDLAND, the name of seven towns in Germany. The most important now is that in the grand duchy of Mecklenburg-Strelitz, on the Mühlenteich, 35 m. N.E. of Strelitz by the railway to Neu-Brandenburg. Pop. 7000. It possesses a fine Gothic church and a gymnasium, and has manufactures of woollen and linen cloth, leather and tobacco. Friedland was founded in 1244 by the margrave John and Otto III. of Brandenburg.

FRIEDLAND, a town of Prussia, on the Alle, 27 m. S.E. of Königsberg (pop. 3000), famous as the scene of the battle fought between the French under Napoleon and the Russians commanded by General Bennigsen, on the 14th of June 1807 (see NAPOLEONIC CAMPAIGNS). The Russians had on the 13th driven the French cavalry outposts from Friedland to the westward, and Bennigsen's main body began to occupy the town in the night. The army of Napoleon was set in motion for Friedland, but it was still dispersed on its various march routes, and the

first stage of the engagement was thus, as usual, a pure "encounter-battle." The corps of Marshal Lannes as "general advanced guard" was first engaged, in the Sortlack Wood and in front of Posthenen (2.30-3 A.M. on the 14th). Both sides now used their cavalry freely to cover the formation of lines of battle, and a race between the rival squadrons for the possession of Heinrichsdorf resulted in favour of the French under Grouchy. Lannes in the meantime was fighting hard to hold Bennigsen, for Napoleon feared that the Russians meant to evade him again. Actually, by 6 A.M. Bennigsen had nearly 50,000 men across the river and forming up west of Friedland. His infantry, in two lines, with artillery, extended between the Heinrichsdorf-Friedland road and the upper bends of the river. Beyond the right of the infantry, cavalry and Cossacks extended the line to the wood N.E. of Heinrichsdorf, and small bodies of Cossacks penetrated even to Schwonau. The left wing also had some cavalry and, beyond the Alle, batteries were brought into action to cover it. A heavy and indecisive fire-fight raged in the Sortlack Wood between the Russian skirmishers and some of Lannes's troops. The head of Mortier's (French and Polish) corps appeared at



Heinrichsdorf and the Cossacks were driven out of Schwonau. Lannes held his own, and by noon, when Napoleon arrived, 40,000 French troops were on the scene of action. His orders were brief: Ney's corps was to take the line between Posthenen and the Sortlack Wood, Lannes closing on his left, to form the centre, Mortier at Heinrichsdorf the left wing. Victor and the Guard were placed in reserve behind Posthenen. Cavalry masses were collected at Heinrichsdorf. The main attack was to be delivered against the Russian left, which Napoleon saw at once to be cramped in the narrow tongue of land between the river and the Posthenen mill-stream. Three cavalry divisions were added to the general reserve. The course of the previous operations had been such that both armies had still large detachments out towards Königsberg. The afternoon was spent by the emperor in forming up the newly arrived masses, the deployment being covered by an artillery bombardment. At 5 o'clock all was ready, and Ney, preceded by a heavy artillery fire, rapidly carried the Sortlack Wood. The attack was pushed on toward the Alle. One of Ney's divisions (Marchand) drove part of the Russian left into the river at Sortlack. A furious charge of cavalry against Marchand's left was repulsed by the dragoon division of Latour-Maubourg. Soon the Russians were huddled together in the bends of the Alle, an easy target for the guns of Ney and of the reserve. Ney's attack indeed came eventually

to a standstill; Bennigsen's reserve cavalry charged with great effect and drove him back in disorder. As at Eylau, the approach of night seemed to preclude a decisive success, but in June and on firm ground the old mobility of the French reasserted its value. The infantry division of Dupont advanced rapidly from Posthenen, the cavalry divisions drove back the Russian squadrons into the now congested masses of foot on the river bank, and finally the artillery general Sémarmont advanced a mass of guns to case-shot range. It was the first example of the terrible artillery preparations of modern warfare, and the Russian defence collapsed in a few minutes. Ney's exhausted infantry were able to pursue the broken regiments of Bennigsen's left into the streets of Friedland. Lannes and Mortier had all this time held the Russian centre and right on its ground, and their artillery had inflicted severe losses. When Friedland itself was seen to be on fire, the two marshals launched their infantry attack. Fresh French troops approached the battlefield. Dupont distinguished himself for the second time by fording the mill-stream and assailing the left flank of the Russian centre. This offered a stubborn resistance, but the French steadily forced the line backwards, and the battle was soon over. The losses incurred by the Russians in retreating over the river at Friedland were very heavy, many soldiers being drowned. Farther north the still unbroken troops of the right wing drew off by the Allenburg road; the French cavalry of the left wing, though ordered to pursue, remaining, for some reason, inactive. The losses of the victors were reckoned at 12,100 out of 86,000, or 14%, those of the Russians at 10,000 out of 46,000, or 21% (Berndt, *Zahl im Kriege*).

FRIEDMANN, MEIR (1831-1908), Hungarian Jewish scholar. His editions of the Midrash are the standard texts. His chief editions were the *Sifra* (1864), the *Mekhilta* (1870), *Peisla Rabbati* (1880). At the time of his death he was editing the *Sifra*. Friedmann, while inspired with regard for tradition, dealt with the Rabbinic texts on modern scientific methods, and rendered conspicuous service to the critical investigation of the Midrash and to the history of early homilies. (I. A.)

FRIEDRICH, JOHANN (1836-), German theologian, was born at Poxdorf in Upper Franconia on the 5th of May 1836, and was educated at Bamberg and at Munich, where in 1865 he was appointed professor extraordinary of theology. In 1869 he went to the Vatican Council as secretary to Cardinal Hohenlobe, and took an active part in opposing the dogma of papal infallibility, notably by supplying the opposition bishops with historical and theological material. He left Rome before the council closed. "No German ecclesiastic of his age appears to have won for himself so unusual a repute as a theologian and to have held so important a position, as the trusted counsellor of the leading German cardinal at the Vatican Council. The path was fairly open before him to the highest advancement in the Church of Rome, yet he deliberately sacrificed all such hopes and placed himself in the van of a hard and doubtful struggle" (*The Guardian*, 1872, p. 1004). Sentence of excommunication was passed on Friedrich in April 1871, but he refused to acknowledge it and was upheld by the Bavarian government. He continued to perform ecclesiastical functions and maintained his academic position, becoming ordinary professor in 1872. In 1882 he was transferred to the philosophical faculty as professor of history. By this time he had to some extent withdrawn from the advanced position which he at first occupied in organizing the Old Catholic Church, for he was not in agreement with its abolition of enforced celibacy.

Friedrich was a prolific writer; among his chief works are: *Johann Wessel* (1862); *Die Lehre des Johann Hus* (1862); *Kirchengeschichte Deutschlands* (1867-1869); *Tagebuch während des Vatican Concils geführt* (1871); *Zur Verteidigung meines Tagebuchs* (1872); *Beiträge zur Kirchengeschichte des 18ten Jahrh.* (1876); *Geschichte der Vatikan. Konzile* (1877-1886); *Beiträge zur Gesch. der Jesuitenordens* (1881); *Das Papatum* (1892); *I. v. Döllinger* (1899-1901).

FRIEDRICHRODA, a summer resort in the duchy of Saxo-Coburg-Gotha, Germany, at the north foot of the Thuringian Forest, 13 m. by rail S.W. from Gotha. Pop. 4500. It is surrounded by fir-clad hills and possesses numerous handsome

villa residences, a *Kurhaus*, sanatorium, &c. In the immediate neighbourhood is the beautiful ducal hunting seat of Reinhardbrunn, built out of the ruins of the famous Benedictine monastery founded in 1085.

FRIEDRICHSDORF, a town of Germany, in the Prussian province of Hesse-Nassau, on the southern slope of the Taunus range, 3 m. N.E. from Homburg. Pop. 1300. It has a French Reformed church, a modern school, dyeworks, weaving mills, tanneries and tobacco manufactures. Friedrichsdorf was founded in 1687 by Huguenot refugees and the inhabitants still speak French. There is a monument to Philipp Reis (1834-1874), who in 1860 first constructed the telephone while a science master at the school.

FRIEDRICHSHAFEN, a town of Germany, in the kingdom of Württemberg, on the east shore of the Lake of Constance, at the junction of railways to Bretten and Lindau. Pop. 4600. It consists of the former imperial town of Buchhorn and the monastery and village of Hofen. The principal building is the palace, formerly the residence of the provosts of Hofen, and now the summer residence of the royal family. To the palace is attached the Evangelical parish church. The town has a hydropathic establishment and is a favourite tourist resort. Here are also the natural history and antiquarian collections of the Lake Constance Association. Buchhorn is mentioned (as Buchhorn or Puchhorn) in documents of 837 and was the seat of a powerful countship. The line of counts died out in 1089, and the place fell first to the Welts and in 1191 to the Hohenstaufen. In 1275 it was made a free imperial city by King Rudolph I. In 1802 it lost this status and was assigned to Bavaria, and in 1810 to Württemberg. The monastery of Hofen was founded in 1050 as a convent of Benedictine nuns, but was changed in 1420 into a provostship of monks. It was suppressed in 1802 and in 1805 came to Württemberg. King Frederick I., who caused the harbour to be made, amalgamated Buchhorn and Hofen under the new name of Friedrichshafen.

FRIEDRICHSRUH, a village in the Prussian province of Schleswig-Holstein, 15 m. S.E. of Hamburg, with a station on the main line of railway to Berlin. It gives its name to the famous country seat of the Bismarck family. The house is a plain unpretentious structure, but the park and estate, forming a portion of the famous Sachsenwald, are attractive. Close by, on a knoll, the Schneckenberg, stands the mausoleum in which the remains of Prince Otto von Bismarck were entombed on the 16th of March 1899.

FRIENDLY¹ SOCIETIES. These organizations, according to the comprehensive definition of the Friendly Societies Act 1896, which regulates such societies in Great Britain and Ireland, are "societies for the purpose of providing by voluntary subscriptions of the members thereof, with or without the aid of donations, for the relief or maintenance of the members, their husbands, wives, children, fathers, mothers, brothers or sisters, nephews or nieces, or wards being orphans, during sickness or other infirmity, whether bodily or mental, in old age, or in widowhood, or for the relief or maintenance of the orphan children of members during minority; for insuring money to be paid on the birth of a member's child, or on the death of a member, or for the funeral expenses of the husband, wife, or child of a member, or of the widow of a deceased member, or, as respects persons of the Jewish persuasion, for the payment of a sum of money during the period of confined mourning; for the relief or maintenance of the members when on travel in search of employment or when in distressed circumstances, or in case of shipwreck, or loss or damage of or to boats or nets; for the endowment of members or nominees of members at any age; for the insurance against fire to any amount not exceeding £15 of the tools or implements of the trade or calling of the members"—and are limited in their contracts for assurance of annuities to £52 (previous to the

¹ The word "friend" (O.E. *freond*, Ger. *Freund*, Dutch *Vriend*) is derived from an old Teutonic verb meaning to love. While used generally as the opposite to enemy, it is specially the term which connotes any degree, but particularly a high degree of personal goodwill, affection or regard, from which the element of sexual love is absent.

Friendly Societies Act 1908 the sum was £50), and for insurance of a gross sum to £300 (previous to the act of 1908 the sum was £200). They may be described in a more popular and condensed form of words as the mutual insurance societies of the poorer classes, by which they seek to aid each other in the emergencies arising from sickness and death and other causes of distress. A phrase in the first act for the encouragement and relief of friendly societies, passed in 1793, designating them "societies of good fellowship," indicates another useful phase of their operations.

The origin of the friendly society is, probably in all countries, the burial club. It has been the policy of every religion, if indeed it is not a common instinct of humanity, to surround the disposal of a dead body with circumstances of pomp and expenditure, often beyond the means of the surviving relatives. The appeal for help to friends and neighbours which necessarily follows is soon organized into a system of mutual aid, that falls in naturally with the religious ceremonies by which honour is done to the dead. Thus in China there are burial societies, termed "long-life loan companies," in almost all the towns and villages. Among the Greeks the *φιλαια* combined the religious with the provident element (see CHARITY AND CHARITIES). From the Greeks the Romans derived their fraternities of a similar kind. The Teutons in like manner had their gilds. Whether the English friendly society owes its origin in the higher degree to the Roman or the Teutonic influence can hardly be determined. The utility of providing by combination for the ritual expenditure upon burial having been ascertained, the next step—to render mutual assistance in circumstances of distress generally—was an easy one, and we find it taken by the Greek *φιλαια* and by the English gilds. Another modification—that the societies should consist not so much of neighbours as of persons having the same occupation—soon arises; and this is the germ of our trade unions and our city companies in their original constitution. The interest, however, that these inquiries possess is mainly antiquarian. The legal definition of a friendly society quoted above points to an organization more complex than those of the ancient fraternities and gilds, and proceeding upon different principles. It may be that the one has grown out of the other. The common element of a provision for a contingent event by a joint contribution is in both; but the friendly society alone has attempted to define with precision what is the risk against which it intends to provide, and what should be the contributions of the members to meet that risk.

United Kingdom.—It would be curious to endeavour to trace how, after the suppression of the religious gilds in the 16th century, and the substitution of an organized system of relief by the poor law of Elizabeth for the more voluntary and casual means of relief that previously existed, the modern system of friendly societies grew up. The modern friendly society, particularly in rural districts, clings with fondness to its annual feast and procession to church, its procession of all the brethren on the occasion of the funeral of one of them, and other incidents which are almost obviously survivals of the customs of medieval gilds. The last recorded gild was in existence in 1628, and there are records of friendly societies as early as 1634 and 1639. The connecting links, however, cannot be traced. With the exception of a society in the port of Borrowstounness on the Firth of Forth, no existing friendly society is known to be able to trace back its history beyond a date late in the 17th century, and no records remain of any that might have existed in the latter half of the 16th century or the greater part of the 17th. One founded in 1666 was extant in 1850, but it has since ceased to exist. This is not so surprising as it might appear. Documents which exist in manuscript only are much less likely to have been preserved since the invention of printing than they were before; and such would be the simple rules and records of any society that might have existed during this interval—if, indeed, many of them kept records at all. On the whole, it seems probable therefore that the friendly society is a lineal descendant of the ancient gild—the idea never having wholly died out, but having been kept up from generation to generation in a succession of small and scattered societies.

At the same time, it seems probable that the friendly society of the present day owes its revival to a great extent to the Protestant refugees of Spitalfields, one of whose societies was founded in 1703, and has continued among descendants of the same families, whose names proclaim their Norman origin. This society has distinguished itself by the intelligence with which it has adapted its machinery to the successive modifications of the law, and it completely reconstructed its rules under the provisions of the Friendly Societies Acts 1875 and 1876.

Another is the society of Lintot, founded in London in 1708, in which the office of secretary was for more than half a century filled by persons of the name of Levesque, one of whom published a translation of its original rules. No one was to be received into the society who was not a member, or the descendant of a member, of the church of Lintot, of recognized probity, a good Protestant, and well-intentioned towards the queen [Anne] and faithful to the government of the country. No one was to be admitted below the age of eighteen, or who had not been received at holy communion and become member of a church. A member should not have a claim to relief during his first year's membership, but if he fell sick within the year a collection should be made for him among the members. The foreign names still borne by a large proportion of the members show that the connexion with descendants of the refugees is maintained.

The example of providence given by these societies was so largely followed that Rose's Act in 1793 recognized the existence of numerous societies, and provided encouragement for them in various ways, as well as relief from taxation to an extent which in those days must have been of great pecuniary value, and exemption from removal under the poor law. The benefits offered by this statute were readily accepted by the societies, and the vast number of societies which speedily became enrolled shows that Rose's Act met with a real public want. In the county of Middlesex alone nearly a thousand societies were enrolled within a very few years after the passing of the act, and the number in some other counties was almost as great. The societies then formed were nearly all of a like kind—small clubs, in which the feature of good fellowship was in the ascendant, and that of provident assurance for sickness and death merely accessory. This is indicated by one provision which occurs in many of the early enrolled rules, viz. that the number of members shall be limited to 61, 81 or 101, as the case may be. The odd 1 which occurs in these numbers probably stands for the president or secretary, or is a contrivance to ensure a clear majority. Several of these old societies are still in existence, and can point to a prosperous career based rather upon good luck than upon scientific calculation. Founded among small tradesmen or persons in the way to thrive, the claims for sickness were only made in cases where the sickness was accompanied by distress, and even the funeral allowance was not always demanded.

The societies generally not being established upon any scientific principle, those which met with this prosperity were the exception to the rule; and accordingly the cry that friendly societies were failing in all quarters was as great in 1819 as in 1869. A writer of that time speaks of the instability of friendly societies as "universal"; and the general conviction that this was so resulted in the passing of the act of 1819. It recites that "the habitual reliance of poor persons upon parochial relief, rather than upon their own industry, tends to the moral deterioration of the people and to the accumulation of heavy burthens upon parishes; and it is desirable, with a view as well to the reduction of the assessment made for the relief of the poor as to the improvement of the habits of the people, that encouragement should be afforded to persons desirous of making provision for themselves or their families out of the fruits of their own industry. By the contributions of the savings of many persons to one common fund the most effectual provision may be made for the casualties affecting all the contributors; and it is therefore desirable to afford further facilities and additional security to persons who may be willing to unite in appropriating small sums from time to time to a common fund for the purposes aforesaid, and it is desirable to protect such persons from the effects of fraud or

miscalculation." This preamble went on to recite that the provisions of preceding acts had been found insufficient for these purposes, and great abuses had prevailed in many societies established under their authority. By this statute a friendly society was defined as "an institution, whereby it is intended to provide, by contribution, on the principle of mutual insurance, for the maintenance or assistance of the contributors thereto, their wives or children, in sickness, infancy, advanced age, widowhood or any other natural state or contingency, whereof the occurrence is susceptible of calculation by way of average." It will be seen that this act dealt exclusively with the scientific aspect of the societies, and had nothing to say to the element of good fellowship. Rules and tables were to be submitted by the persons intending to form a society to the justices, who, before confirming them, were to satisfy themselves that the contingencies which the society was to provide against were within the meaning of the act, and that the formation of the society would be useful and beneficial, regard being had to the existence of other societies in the same district. No tables or rules connected with calculation were to be confirmed by the justices until they had been approved by two persons at least, known to be professional actuaries or persons skilled in calculation, as fit and proper, according to the most correct calculation of which the nature of the case would admit. The justices in quarter sessions were also by this act authorized to publish general rules for the formation and government of friendly societies within their county. The practical effect of this statute in requiring that the societies formed under it should be established on sound principles does not appear to have been as great as might have been expected. The justices frequently accepted as "persons skilled in calculation" local schoolmasters and others who had no real knowledge of the technical difficulties of the subject, while the restrictions upon registry served only to increase the number of societies established without becoming registered.

In 1829 the law relating to friendly societies was entirely reconstructed by an act of that year, and a barrister was appointed under that act to examine the rules of societies, and ascertain that they were in conformity to law and to the provisions of the act. The barrister so appointed was John Tidd Pratt (1797-1870); and no account of friendly societies would be complete that did not do justice to the remarkable public service rendered by this gentleman. For forty years, though he had by statute really very slight authority over the societies, his name exercised the widest influence, and the numerous reports and publications by which he endeavoured to impress upon the public mind sound principles of management of friendly societies, and to expose those which were managed upon unsound principles, made him a terror to evil-doers. On the other hand, he lent with readiness the aid of his legal knowledge and great mental activity to assisting well-intentioned societies in coming within the provisions of the acts, and thus gave many excellent schemes a legal organization.

By the act of 1829, in lieu of the discretion as to whether the formation of the proposed society would be useful and beneficial, and the requirement of the actuarial certificate to the tables, it was enacted that the justices were to satisfy themselves that the tables proposed to be used might be adopted with safety to all parties concerned. This provision, of course, became a dead letter and was repealed in 1834. Thenceforth, societies were free to establish themselves upon what conditions and with what rates they chose, provided only they satisfied the barrister that the rules were "calculated to carry into effect the intention of the parties framing them," and were "in conformity to law."

By an act of 1846 the barrister certifying the rules was constituted "Registrar of Friendly Societies," and the rules of all societies were brought together under his custody. An actuarial certificate was to be obtained before any society could be registered "for the purpose of securing any benefit dependent on the laws of sickness and mortality." In 1850 the acts were again repealed and consolidated with amendments. Societies were divided into two classes, "certified" and "registered." The certified societies were such as obtained a

certificate to their tables by an actuary possessing a given qualification, who was required to set forth the data of sickness and mortality upon which he proceeded, and the rate of interest assumed in the calculations. All other societies were to be simply registered. Very few societies were constituted of the "certified" class. The distinction of classes was repealed and the acts were again consolidated in 1855. Under this act, which admitted of all possible latitude to the framers of rules of societies, 21,875 societies were registered, a large number of them being lodges or courts of affiliated orders, and the act continued in force till the end of 1875.

The Friendly Societies Act 1875 and the several acts amending it are still, in effect, the law by which these societies are regulated, though in form they have been replaced by two consolidating acts, viz. the Friendly Societies Act 1896 and the Collecting Societies and Industrial Assurance Companies Act 1896. This legislation still bears the permissive and elastic character which marked the more successful of the previous acts, but it provides ample means to members of ascertaining and remedying defects of management and of restraining fraud. The business of registry is under the control of a chief registrar, who has an assistant registrar in each of the three countries, with an actuary. An appeal to the chief registrar in the case of the refusal of an assistant registrar to register a society or an amendment of rules, and in the case of suspension or cancelling of registry, is interposed before appeal is to be made to the High Court. Registry under a particular name may be refused if in the opinion of the registrar the name is likely to deceive the members or the public as to the nature of the society or as to its identity. It is the duty of the chief registrar, among other things, to require from every society a return in proper form each year of its receipts and expenditure, funds and effects; and also once every five years a valuation of its assets and liabilities. Upon the application of a certain proportion of the members, varying according to the magnitude of the society, the chief registrar may appoint an inspector to examine into its affairs, or may call a general meeting of the members to consider and determine any matter affecting its interests. These are powers which have been used with excellent effect. Cases have occurred in which fraud has been detected and punished by this means that could not probably have been otherwise brought to light. In others a system of mismanagement has been exposed and effectually checked. The power of calling special meetings has enabled societies to remedy defects in their rules, to remove officers guilty of misconduct, &c., where the procedure prescribed by the rules was for some reason or other inapplicable. Upon an application of a like proportion of members the chief registrar may, if he finds that the funds of a society are insufficient to meet the existing claims thereon, or that the rates of contribution are insufficient to cover the benefits assured (upon which he consults his actuary), order the society to be dissolved, and direct how its funds are to be applied. Authority is given to the chief registrar to direct the expense (preliminary, incidental, &c.) of an inspection or special meeting to be defrayed by the members or officers, or former members or officers, of a society, if he does not think they should be defrayed either by the applicants or out of the society's funds. He is also empowered, with the approval of the treasury, to exempt any friendly society from the provisions of the Collecting Societies Act if he considers it to be one to which those provisions ought not to apply. Every society registered after 1895, to which these provisions do apply, is to use the words "Collecting Society" as the last words of its name.

The law as to the membership of infants has been altered three times. The act of 1875 allowed existing societies to continue any rule or practice of admitting children as members that was in force at its passing, and prohibited membership under sixteen years of age in any other case, except the case of a juvenile society composed wholly of members under that age. The treasury made special regulations for the registry of such juvenile societies. In 1887 the maximum age of their members was extended to twenty-one. In 1895 it was enacted that no society should have any members under one year of age, whether

authorized by an existing rule or not; and that every society should be entitled to make a rule admitting members at any age over one year, but by the Friendly Societies Act 1908 membership was permitted to minors under the age of one year. The Treasury, upon the enactment of 1895 coming into operation, rescinded its regulations for the registry of juvenile societies; and though it is still the practice to submit for registry societies wholly composed of persons under twenty-one, these societies in no way differ from other societies, except in the circumstances that they are obliged to seek officers and a committee of management from outside, as no member of the committee of any society can be under twenty-one years of age. In order to promote the discontinuance of this anomalous proceeding of creating societies under the Friendly Societies Act, which, by the conditions of their existence, are unable to be self-governing, the act provides an easy method of amalgamating juvenile societies and ordinary societies or branches, or of distributing the members and the funds of a juvenile society among a number of branches. The liability of schoolboys and young working lads to sickness is small, and these societies frequently accumulate funds, which, as their membership is temporary, remain unclaimed and are sometimes misapplied.

The legislation of 1875 and 1876 was the result of the labours of a royal commission of high authority, presided over by Sir Stafford Northcote (afterwards Lord Iddesleigh), which sat from 1870 to 1874, and prosecuted an exhaustive inquiry into the organization and condition of the various classes of friendly societies. Their reports occupy more than a dozen large bluebooks. They divided registered friendly societies into 13 classes.

The first class included the affiliated societies or "orders," such as the Manchester Unity of Oddfellows, the Ancient Order of Foresters, the Rechabites, Druids, &c. These societies have a central body, either situated in some large town, as in the case of the Manchester Unity, or moving from place to place, as in that of the Foresters. Under this central body, the country is (in most cases) parcelled out into districts, and these districts again consist each of a number of independent branches, called "lodges," "courts," "tents," or "divisions," having a separate fund administered by themselves, but contributing also to a fund under the control of the central body. Besides these great orders, there were smaller affiliated bodies, each having more than 1000 members; and the affiliated form of society appears to have great attraction. Indeed, in the colony of Victoria, Australia, all the existing friendly societies are of this class. The orders have their "secrets," but these, it may safely be said, are of a very innocent character, and merely serve the purpose of identifying a member of a distant branch by his knowledge of the "grip," and of the current password, &c. Indeed they are now so far from being "secret societies" that their meetings are attended by reporters and the debates published in the newspapers, and the Order of Foresters has passed a wise resolution expunging from its publications all affectation of mystery.

Most of the lodges existing before 1875 have converted themselves into registered branches. The requirement that for that purpose a vote of three-fourths should be necessary was altered in 1895 to a bare majority vote. The provisions as to settlement of disputes were extended in 1885 to every description of dispute between branches and the central body, and in 1895 it was provided that the forty days after which a member may apply to the court to settle a dispute where the society fails to do so, shall not begin to run until application has been made in succession to all the tribunals created by the order for the purpose. In 1887 it was enacted that no body which had been a registered branch should be registered as a separate society except upon production of a certificate from the order that it had seceded or been expelled; and in 1895 it was further enacted that no such body should, after secession or expulsion, use any name or number implying that it is still a branch of the order. The orders generally, especially the greater ones, have carefully supervised the valuations of their branches, and have urged and, as far as circumstances have rendered it practicable, have enforced upon the branches measures for diminishing the deficiencies which the valuations have disclosed. They have organized plans by which branches disposed to make an effort to help themselves in this matter may be assisted out of a central fund. The second class was made up of "general societies," principally existing in London, of which the commissioners enumerated 8 with nearly 60,000 members, and funds amounting to a quarter of a million.

The third class included the "county societies." These societies have been but feebly supported by those for whose benefit they are instituted, having all exacted high rates of contribution, in order to secure financial soundness.

Class 4, "local town societies," is a very numerous one. Among some of the larger societies may be mentioned the "Chelmsford Provident," the "Brighton and Sussex Mutual," the "Cannon Street, Birmingham," the "Birmingham General Provident." In

this group might also be included the interesting societies which are established among the Jewish community. They differ from ordinary friendly societies partly in the nature of the benefits granted upon death, which are intended to compensate for loss of employment during the time of ceremonial seclusion enjoined by the Jewish law, which is called "sitting shiva." They also provide a cab for the mourners and rabbi, and a tombstone for the departed, and the same benefits as an ordinary friendly society during sickness. Some also provide a place of worship. Of these the "Pursuers of Peace" (enrolled in December 1797), the "Bikhor Cholim, or Visitors of the Sick" (April 1798), the "Hozier Holim" (1804), may be mentioned.

Class 5 was "local village and country societies," including the small public-house clubs which abound in the villages and rural districts, a large proportion of which are unregistered.

Class 6 was formed of "particular trade societies."

Class 7 was "dividing societies." These were before 1875 unauthorised by law, though they were very attractive to the members. Their practice is usually to start afresh every January, paying a subscription somewhat in excess of that usually charged by an ordinary friendly society, out of which a sick allowance is granted to any member who may fall sick during the year, and at Christmas the balance not so applied is divided among the members equally, with the exception of a small sum left to begin the new year with. The mischief of the system is that, as there is no accumulation of funds, the society cannot provide for prolonged sickness or old age, and must either break up altogether or exclude its sick and aged members at the very time when they most need its help. This, however, has not impaired the popularity of the societies, and the act of 1875, framed on the sound principle that the protection of the law should not be withheld from any form of association, enables a society to be registered with a rule for dividing its funds, provided only that all existing claims upon the society are to be met before a division takes place.

Class 8, "deposit friendly societies," combine the characteristics of a savings bank with those of a friendly society. They were devised by the Hon. and Rev. S. Best, on the principle that a certain proportion of the sick allowance is to be raised out of a member's separate deposit account, which, if not so used, is retained for his benefit. Their advantages are in the encouragement they offer to saving, and in meeting the selfish objection sometimes raised to friendly societies, that the man who is not sick gets nothing for his money; their disadvantage is in their failing to meet cases of sickness so prolonged as to exhaust the whole of the member's own deposit.

Class 9, "collecting societies," are so called because their contributions are received through a machinery of house-to-house collection. These were the subject of much laborious investigation and close attention on the part of the commissioners. They deal with a lower class of the community, both with respect to means and to intelligence, than that from which the members of ordinary friendly societies are drawn. The large emoluments gained by the officers and collectors, the high percentage of expenditure (often exceeding half the contributions), and the excessive frequency of lapsing of insurances point to mischiefs in their management. "The radical evil of the whole system (the commissioners remark) appears to us to lie in the employment of collectors, otherwise than under the direct supervision and control of the members, a supervision and control which we fear to be absolutely unattainable in burial societies that are not purely local." On the other hand, it must be conceded that these societies extend the benefits of life insurance to a class which the other societies cannot reach, namely, the class that will not take the trouble to attend at an office, but must be induced to effect an insurance by a house-to-house canvasser, and be regularly visited by the collector to ensure their paying the contributions. To many such persons these societies, despite all their errors of constitution and management, have been of great benefit. The great source of these errors lies in a tendency on the part of the managers of the societies to forget that they are simply trustees, and to look upon the concern as their own personal property to be managed for their own benefit. These societies are of two kinds, local and general. For the general societies the act of 1875 made certain stringent provisions. Each member was to be furnished with a copy of the rules for one penny, and a signed policy for the same charge. Forfeiture of benefit for non-payment is not to be enforced without fourteen days' written notice. The transfer of a member from one society to another was not to be made without his written consent and notice to the society affected. No collector is to be a manager, or vote or take part at any meeting. At least one general meeting was to be held every year, of which notice must be given either by advertisement or by letter or post card to each member. The balance-sheet is to be open for inspection seven days before the meeting, and to be certified by a public accountant, not an officer of the society. Disputes could be settled by justices, or county courts, notwithstanding anything in the rules of the society to the contrary. Closely associated with the question of the management of these societies is that of the risk incurred by infant life, through the facilities offered by these societies for making insurances on the death of children. That this is a real risk is certain from the records of the assizes, and from many circumstances of suspicion; but the extent of it cannot be measured, and has probably been exaggerated.

It has never been lawful to assure more than £6 on the death of a child under five years of age, or more than £10 on the death of one under ten. Previous to the act of 1875, however, there was no machinery for ascertaining that the law was complied with, or for enforcing it. This is supplied by that act, though still somewhat imperfectly. When the bill went up to the House of Lords, an amendment was made, reducing the limit of assurance on a child under three years of age to £3, but this amendment was unfortunately disagreed with by the House of Commons.

Class 10, annuity societies, prevail in the west of England. These societies are few, and their business is diminishing. Most of them originated at the time when government subsidized friendly societies by allowing them 4: 11: 3% per annum interest. Now annuities may be purchased direct from the National Debt commissioners. These societies are more numerous, however, in Ireland.

Class 11, female societies, are numerous. Many of them resemble affiliated orders at least in name, calling themselves Female Foresters, Odd Sisters, Loyal Orangewomen, Comforting Sisters and so forth. In their rules may be found such a provision as that a member shall be fined who does not "behave as becometh an Orangewoman." Many are unregistered. In the northern counties of England they are sometimes termed "life boxes," doubtless from the old custom of placing the contributions in a box. The trustees, treasurer, and committee are usually females, but very frequently the secretary is a man, paid a small salary.

Under Class 12 the commissioners included the societies for various purposes which were authorized by the secretary of state to be registered under the Friendly Societies Act of 1855, comprising working-men's clubs, and certain specially authorised societies, as well as others that are now defined to be friendly societies. Among these purposes are assisting members in search of employment; assisting members during slack seasons of trade; granting temporary relief to members in distressed circumstances; purchase of coals and other necessities to be supplied to members; relief or maintenance in case of lameness, blindness, insanity, paralysis, or bodily hurt through accidents; also, the assurance against loss by disease or death of cattle employed in trade or agriculture; relief in case of shipwreck or loss or damage to boats or nets; and societies for social intercourse, mutual helpfulness, mental and moral improvement, rational recreation, &c., called working-men's clubs.

Class 13 was composed of cattle insurance societies. These are the thirteen classes into which the commissioners divided registered friendly societies. There were 26,034 societies enrolled or certified under the various acts for friendly societies in force between 1793 and 1855; and, as we have seen, 21,875 societies registered under the act of 1855 before the 1st January 1876, when the act of 1875 came into operation. The total therefore of societies to which a legal constitution had been given was 47,909. Of these 26,087 were presumed to be in existence when the registrar called for his annual return, but only 11,282 furnished the return required. These had 3,404,187 members, and £9,336,946 funds. Twenty-two societies returned over 10,000 members each; nine over 30,000. One society (the Royal Liver Friendly Society, Liverpool, the largest of the collecting societies) returned 682,371 members. The next in order was one of the same class, the United Assurance Society, Liverpool, with 159,957 members; but in all societies of this class the membership consists very largely of infants. The average of members in the 11,260 societies with less than 10,000 members each was only 177.

Such were the registered societies; but there remained behind a large body of unregistered societies. With increased knowledge of the advantages of registration,¹ and of the true principles upon which friendly societies should be established, the number of unregistered societies, in comparison with those registered, ought to become much less.

On the actuarial side it is in the highest degree essential to the interests of their members that friendly societies should be financially sound,—in other words, that they should throughout their existence be able to meet the engagements into which they have entered with their members. For this purpose it is necessary that the members' contributions should be so fixed as to prove adequate, with proper management, to provide the benefits promised to the members. These benefits almost entirely depend upon the contingencies of health and life; that is, they take the form of payments to members when sick, of payments to members upon attaining given ages, or of payments upon members' deaths, and frequently a member is

¹ These may be briefly summed up thus:—(1) power to hold land and vesting of property in trustees by mere appointment; (2) remedy against misapplication of funds; (3) priority in bankruptcy or on death of officer; (4) transfer of stock by direction of chief registrar; (5) exemption from stamp duties; (6) membership of minors; (7) certificates of birth and death at reduced cost; (8) investment with National Debt Commissioners; (9) reduction of fines on admission to copyholds; (10) discharge of mortgages by mere receipt; (11) obligation on officers to render accounts; (12) settlement of disputes; (13) insurance of funeral expenses for wives and children without insurable interest; (14) nomination at death; (15) payment without administration; (16) services of public auditors and valuers; (17) registry of documents, of which copies may be put in evidence.

assured for all these benefits, viz. a weekly payment if at any time sick before attaining a certain age, a weekly payment for the remainder of life after attaining that age, and a sum to be paid upon his death. Of course the object of the allowance in sickness is to provide a substitute for the weekly wage lost in consequence of being unable to work, and the object of the weekly payment after attaining a certain age, when the member will probably be too infirm to be able to earn a living by the exercise of his calling or occupation, is to provide him with the necessaries of life, and so enable him to be independent of poor relief. There is every reason to believe that, when a large group of persons of the same age and calling are observed, there will be found to prevail among them, taken one with another, an average number of days' sickness, as well as an average rate of mortality, in passing through each year of life, which can be very nearly predicted from the results furnished by statistics based upon observations previously made upon similarly circumstanced groups. Assuming, therefore, the necessary statistics to be attainable, the computation of suitable rates of contribution to be paid by the members of a society in return for certain allowances during sickness, or upon attaining a certain age, or upon death, can be readily made by an actuarial expert. Accordingly, to furnish these statistics, the act of 1875, in continuation of an enactment which first appeared in a statute passed in 1829, required every registered society to make quinquennial returns of the sickness and mortality experienced by its members. By the year 1880 ten periods of five years had been completed, and at the end of each of them a number of returns had been received. Some of these had been tabulated by actuaries, the latest tabulation being of those for the five years ending 1855. There remained untabulated five complete sets of returns for the five subsequent quinquennial periods. It was resolved that these should be tabulated once for all, and it was considered that they would afford sufficient material for the construction of tables of sickness and mortality that might be adopted for the future as standard tables for friendly societies; and that it would be inexpedient to impose any longer on the societies the burden of making such returns. This requirement of the act was accordingly repealed in 1882. The result of the tabulation appeared in 1896, in a bluebook of 1367 folio pages, containing tables based upon the experience of nearly four and a half million years of life. These tables showed generally, as compared with previous observations, an increased liability to sickness. This inference has been confirmed by the observations of Mr Alfred W. Watson, actuary to the Independent Order of Oddfellows, Manchester Unity Friendly Society, on his investigation of the sickness and mortality experience of that society during the five years 1893-1897, which extended over 800,000 individuals, more than 3,000,000 years of life and 7,000,000 weeks of sickness.

The establishment of the National Conference of Friendly Societies by the orders and a few other societies has been of great service in obtaining improvements in the law, and in enabling the societies strongly to represent to the government and the legislature any grievance entertained by them. A complaint that membership of a shop club was made by certain employers a condition of employment, and that the rules of the club required the members to withdraw from other societies, led to the appointment of a departmental committee, who recommended that such a condition of employment should be made illegal, except in certain cases, and that in every case it should be illegal to make the withdrawal from a society a condition of employment. In 1902 an act was passed based upon this recommendation.

It is an increasing practice among societies of combining together to obtain medical attendance and medicine for their members by the formation of medical associations. In 1895 trade unions were enabled to join in such associations, and it was provided that a contributing society or union should not withdraw from an association except upon three months' notice. The working of these associations has been viewed with dissatisfaction by members of the medical profession, and it has been suggested that a board of conciliation should be formed consisting of representatives of the Conference of Friendly Societies and of an equal number of medical men.

The following figures are derived from returns of registered societies and branches of registered societies to the beginning of 1905:

	Number of Returns.	Number of Members.	Amount of Funds.
Ordinary Friendly Societies (classes 2 to 8, 10 and 11).	6,938	3,132,065	£17,042,398
Societies having Branches (class 1)	20,810	2,666,029	23,446,350
Collecting Friendly Societies (class 9)	45	7,448,549	7,862,599
Benevolent Societies (class 12)	75	26,509	317,913
Working Men's Clubs (class 12)	913	236,298	318,943
Specialty Authorized Societies (class 12)	122	75,089	628,759
Specialty Authorized Loan Societies (class 12)	517	115,511	771,578
Medical Societies (see last paragraph)	95	324,145	62,049
Cattle Insurance Societies (class 13)	57	3,736	7,746
Shop Clubs (under act of 1902)	7	10,859	773
	20,588	13,978,790	£50,459,060

British Empire.—In many of the British colonies legislation on the subject similar to that of the mother-country has been adopted. In those forming the Commonwealth of Australia and in New Zealand the affiliated orders hold the field, there being few, if any, independent friendly societies. The state of Victoria has more than 1000 lodges with more than 100,000 members and nearly 1½ million pounds fund, averaging nearly £14 per member. Besides the registrar there is a government actuary for friendly societies, by whom the liabilities and accounts of all societies are valued every five years, a method which ensures uniformity in the processes of valuation. The friendly societies in the other Australasian states are not so numerous nor so wealthy, but are in each case under the supervision of vigilant public officials. In New Zealand a friendly society was established at New Plymouth in 1841, the first year of that settlement. The formation of a society at Nelson was resolved upon by the emigrants on shipboard on their passage out, and the first meeting was held among the tall fern near the beach a few days after they landed. The societies have now a registrar, an actuary, a revising barrister and two public valuers. Investigations have been made into their sickness experience, with results which compare favourably with those of the Manchester Unity and the registry office in the mother-country until the higher ages, when greater sickness appears to result from lower mortality. The average funds per member are £19,10s. Nearly four-fifths are invested in the purchase or on mortgage of real estate.

In Cape Colony no society is allowed to register unless it be shown to the satisfaction of the registrar that the contributions which it proposes to charge are adequate to provide for the benefits which it undertakes to grant. The consequence is that little more than one-third of the existing societies are registered.

In the Dominion of Canada, province of Ontario, extensive powers of control are given to the registrar, and societies are not admitted to registry without strict proof of their compliance with the conditions of registry imposed by the law. Very full returns of their transactions are required and published, and registry is cancelled when any of the conditions of registry cease to be observed. These conditions apply not only to societies existing in Ontario, but to foreign societies transacting business there.

In several of the West Indian Islands statutes have been passed on the model of British legislation and registrars have been appointed.

European Countries.—In foreign countries the development of friendly societies has proceeded upon different lines. Belgium has a *Commission royale permanente des sociétés de secours mutuel*. Under laws passed in 1851 and 1894 societies are divided into two classes, recognized and not recognized. The recognized societies were in 1886 only about half as many as the unrecognized. There were in 1904 nearly 7000 recognized societies with 700,000 members. They enjoy the privileges of incorporation, exemption from stamp duty, gratuitous announcement in the official *Moniteur* and may have free postage.

In France under the second empire a scheme was prepared for assisting friendly societies by granting them collective insurances under government security. The societies have the privilege of investing their funds in the *Caisse des Dépôts et Consignations*, corresponding to the English National Debt commission. The dual classification of societies in France is into those "authorized" and those "approved." By a law of the 1st of April 1898 a friendly society may be established by merely depositing a copy of its rules and list of officers with the *sous-prefet*. Approved societies are entitled to certain state subventions for assisting in the purchase of old-age pensions and otherwise. A higher council has been established to advise on their working.

In Germany a law was passed on

the 7th of April 1876 (amended on the 1st of June 1884) which prescribed for registered friendly societies many things which in England are left to the discretion of their founders; and it provided for an amount of official interference in their management that is wholly unknown here. The superintending authority had a right to inspect the books of every society, whether registered or not, and to give formal notice to a society to call in arrears, exclude defaulters, pay benefits or revoke illegal resolutions. A higher authority might, in certain cases, order societies to be dissolved. These provisions related to voluntary societies; but it was competent for communal authorities also to order the formation of a friendly society, and to make a regulation compelling all workmen not already members of a society to join it. Since then the great series of imperial statutes has been passed, commencing in 1883 with that for sickness insurance, followed in 1884 by that for workmen's accident insurance, extended to sickness insurance in 1885, developed in the laws relating to accident and sickness insurance of persons engaged in agricultural and forestry pursuits in 1886, of persons engaged in the building trade and of seamen and others engaged in seafaring pursuits in 1887, and crowned by the law relating to infirmity and old-age insurance in 1889. Mr H. Unger, a distinguished actuary, remarks that the whole German workman's insurance and its executive bodies (sickness funds, trade associations, insurance institutions) are constantly endeavouring to improve the position of the workmen in a social and sanitary aspect, to the benefit of internal peace and the welfare of the German empire.

In Holland it is stated that the number of burial clubs and sickness benefit societies appears to be greater in proportion to the population than in any other country; but that the burial clubs do not rest upon a scientific basis, and have an unfavourable influence upon infant mortality. Half the population are insured in some burial club or other. The sick benefit societies are, as in England, some in a good and some in a bad financial condition; and legislation follows the English system of compulsory publicity, combined with freedom of competition.

In Spain friendly societies have grown out of the religious guilds. They are regulated by an act of 1887. Their actual condition appears to be backward, but to show indications of improvement. (E. W. B.)

United States.—Under the title of fraternal societies are included in the United States what are known in England as friendly societies, having some basis of mutual help to members, mutual insurance associations and benefit associations of all kinds. There are various classes and a great variety of forms of fraternal associations. It is therefore difficult to give a concrete historical statement of their origin and growth; but, dealing with those having benefit features for the payment of certain amounts in case of sickness, accident or death, it is found that their history in the United States is practically within the last half of the 19th century. The more important of the older organizations are the Improved Order of Red Men, founded in 1771 and reorganized in 1834; Ancient Order of Foresters, 1836; Ancient Order of Hibernians of America, 1836; United Ancient Order of Druids, 1839; Independent Order of Rechabites, 1842; Independent Order of B'nai B'rith, founded in 1843; Order of the United American Mechanics, 1845; Independent Order of Free Sons of Israel, 1849; Junior Order of United American Mechanics, 1853. A very large proportion, probably more than one-half, of the societies which have secret organizations pay benefits in case of sickness, accident, disability, and funeral expenses in case of death. This class of societies grew out of the English friendly societies and have masonic characteristics. The Freemasons and other secret societies, while not all having benefit features in their distinctive organizations, have auxiliary societies with such features. There is also a class of secret societies, based largely on masonic usages, that have for their principal object the payment of benefits in some form. These are the Oddfellows, the Knights of Pythias, the Knights of Honour, the Royal Arcanum and some others. Many trade unions have now adopted benefit features, especially the Typo-

graphical Union, while many subordinate unions and great publishing houses have mutual relief associations purely of a local character, and some of the more important newspapers have such mutual relief or benefit societies. The New York trade unions, taken as a whole, have paid out large sums of money in benefits where members have been out of work, or are sick, or are on strike or have died. The total paid in one year for all these benefits was over \$500,000.

It is impossible to give the membership of all the fraternal associations in the United States; but, including Oddfellows, Freemasons, purely benefit associations and all the class of the larger fraternal organizations, the membership is over 6,000,000. Among the more important, so far as membership is concerned, are the Knights of Pythias, the Oddfellows, the Modern Woodmen of America, the Ancient Order of United Workmen, Improved Order of Red Men, Royal Arcanum, Knights of the Maccabees, Junior Order of United American Mechanics, Foresters of America, Independent Order of Foresters, &c. These and other organizations pay out a vast amount of money every year in the various forms.

Since about the year 1870 a new form of benefit organization has come into existence. This is a life insurance based on the assessment plan, assessments being levied whenever a member dies; or, as more recently, regular assessments being made in advance of death, as post-mortem assessments have proved a fallacious method of securing the means of paying death benefits. There are about 200 mutual benefit insurance companies or associations in the United States conducted on the "lodge system"; that is to say, they have regular meetings for social purposes and for general improvement, and in their work there is found the mysticism, forms and ceremonies which belong to secret societies generally. These elements have proved a very strong force in keeping this class of associations fairly intact. The "work" of the lodges in the initiation of members and their passing through various degrees is attractive to many people, and in small places, remote from the amusements of the city, these lodges constitute a resort where members can give play to their various talents. In most of them the features of the Masonic ritual are prominent. The amount of insurance which a single member can carry in such associations is small. In the Knights of Honour, one of the first of this class, policies ranging from \$500 to \$2000 are granted. In the Royal Arcanum the maximum is \$3000. This form of insurance may be called co-operative, and has many elements which make the organizations practicing it stronger than the ordinary assessment insurance companies having no stated meetings of members. These co-operative insurance societies are organized on the federal plan—as the Knights of Honour, for instance—having local assemblies, where the lodge-room element is in force; state organizations, to which the local bodies send delegates, and the national organization, which conducts all the insurance business through its executive officers. The local societies pay a certain given amount towards the support of the state and national offices, and while originally they paid death assessments, as called for, they now pay regular monthly assessments, in order to avoid the weakness of the post-mortem assessment. The difficulty which these organizations have in conducting the insurance business is in keeping the average age of membership at a low point, for with an increase in the average the assessments increase, and many such organizations have had great trouble to convince younger members that their assessments should be increased to make up for the heavy losses among the older members. The experience of these purely insurance associations has not been sufficient yet to demonstrate their absolute soundness or desirability, but they have enabled a large number of persons of limited means to carry insurance at a very low rate. They have not materially interfered with regular level premium insurance enterprises, for they have stimulated the people to understand the benefits of insurance, and have really been an educational force in this direction.

A modern method of benefit association is found in the railway relief departments of some of the large railway corporations. These departments are organized upon a different plan from the benefit features of labour organizations and secret societies, providing the members not only with payments on account of death, but also with assistance of definite amounts in case of sickness or accident, the railway companies contributing to the funds, partly from philanthropic and partly from financial motives. The principal railway companies in the United States which have established these relief departments are the Pennsylvania, the Philadelphia & Reading, the Baltimore & Ohio, the Chicago, Burlington & Quincy, and the Plant System. The relief department benefits the employes, the railways, and the public, because it is based upon the sound principle that the interests and welfare of labour, capital and society are common and harmonious, and can be promoted more by co-operation of effort than by antagonism and strife.

The railway employes support one-twentieth of the entire population, and most of their associations maintain organizations to provide their members with relief and insurance. The Brotherhood of Locomotive Engineers, the Order of Railway Conductors of America, the Brotherhood of Locomotive Firemen, the Brotherhood of Railway Trainmen, the Brotherhood of Railway Trackmen, the Switchmen's Union, the Brotherhood of Railway Carmen, and the Order of Railway Telegraphers, all have relief and benefit features. The oldest and largest of these is the International Brotherhood of Locomotive Engineers, founded at Detroit in August 1863. Like other labour organizations of the higher class of workmen, the objects of the brotherhoods of railway employes are partly social and partly educational, but in addition to these great purposes they seek to protect their members through relief and benefit features. Of course the relief departments of the railway companies are competitors of the relief and insurance features of the railway employes orders, but both methods of providing assistance have proved successful and beneficial.

For a history of the various American organizations, see Albert C. Stevens, *The Cyclopaedia of Fraternities* (New York, 1899); *Facts for Fraternists*, published by the *Fraternal Monitor*, Rochester, N.Y.; for annual statements, "The World Almanac," "Railway Relief Departments," "Brotherhood Relief and Insurance of Railway Employes," "Mutual Relief and Benefit Associations in the Printing Trade," "Benefit Features of American Trade Unions," *Bulletins* Nos. 8, 17, 19 and 22 of the U.S. Department of Labour. (C. D. W.)

FRIENDS, SOCIETY OF, the name adopted by a body of Christians, who, in law and general usage, are commonly called **QUAKERS**. Though small in number, the Society occupies a position of singular interest. To the student of ecclesiastical history it is remarkable as exhibiting a form of Christianity widely divergent from the prevalent types, being a religious fellowship which has no formulated creed demanding definite subscription, and no liturgy, priesthood or outward sacrament, and which gives to women an equal place with men in church organization. The student of English constitutional history will observe the success with which Friends have, by the mere force of passive resistance, obtained, from the legislature and the courts, indulgence for all their scruples and a legal recognition of their customs. In American history they occupy an important place because of the very prominent part which they played in the colonization of New Jersey and Pennsylvania.

The history of Quakerism in England may be divided into three periods:—(1) from the first preaching of George Fox in 1647 to the Toleration Act 1689; (2) from 1689 to the evangelical movement in 1835; (3) from 1835 to the present time.

1. *Period 1647-1689*.—George Fox (1624-1691), the son of a weaver of Drayton-in-the-Clay (now called Fenny Drayton) in Leicestershire, was the founder of the Society. He began his public ministry in 1647, but there is no evidence to show that he set out to form a separate religious body. Impressed by the formalism and deadness of contemporary Christianity (of which there is much evidence in the confessions of the Puritan writers themselves) he emphasized the importance of repentance and personal striving after the truth. When, however, his preaching attracted followers, a community began to be formed, and traces of organization and discipline may be noted in very early times. In 1652 a number of people in Westmorland and north Lancashire who had separated from the common national worship,¹ came under the influence of Fox, and it was this community (if it can be so called) at Preston Patrick which formed the nucleus of the Quaker church. For two years the movement spread rapidly throughout the north of England, and in 1654 more than sixty ministers went to Norwich, London; Bristol, the Midlands, Wales and other parts. Fox and his fellow-preachers spoke whenever opportunity offered,—sometimes in churches (declining, for the most part, to occupy the pulpit), sometimes in barns, sometimes at market crosses. The insistence on an inward spiritual experience was the great contribution made by Friends

to the religious life of the time, and to thousands it came as a new revelation. There is evidence to show that the arrangement for this "publishing of Truth" rested mainly with Fox, and that the expenses of it and of the foreign missions were borne out of a common fund. Margaret Fell (1614-1702), wife of Thomas Fell (1598-1658), vice-chancellor of the duchy of Lancaster, and afterwards of George Fox, opened her house, Swarthmore Hall near Ulverston, to these preachers and probably contributed largely to this fund.

Their insistence on the personal aspect of religious experience made it impossible for Friends to countenance the setting apart of any man or building for the purpose of divine worship to the exclusion of all others. The operation of the Spirit was in no way limited to time, or individual or place. The great stress which they laid upon this aspect of Christian truth caused them to be charged with unbelief in the current orthodox views as to the inspiration of the Scriptures, and the person and work of Christ, a charge which they always denied. Contrary to the Puritan teaching of the time, they insisted on the possibility, in this life, of complete victory over sin. Robert Barclay, writing some twenty years later, admits of degrees of perfection, and the possibility of a fall from it (*Apology*, Prop. viii.). Such teaching necessarily brought Fox and his friends into conflict with all the religious bodies of England, and they were continually engaged in strife with the Presbyterians, Independents, Baptists, Episcopalians and the wilder sectaries, such as the Ranters and the Muggletonians. The strife was often conducted on both sides with a zeal and bitterness of language which were characteristic of the period. Although there was little or no stress laid on either the joys or the terrors of a future life, the movement was not infrequently accompanied by most of those physical symptoms which usually go with vehement appeals to the conscience and emotions of a rude multitude. It was owing to these physical manifestations that the name "Quaker" was either first given or was regarded as appropriate when given for another reason (see Fox's *Journal* concerning Justice Bennet at Derby in 1650 and Barclay's *Apology*, Prop. 11, § 8). The early Friends definitely asserted that those who did not know quaking and trembling were strangers to the experience of Moses, David and other saints.

Some of the earliest adherents indulged in extravagances of no measured kind. Some of them imitated the Hebrew prophets in the performance of symbolic acts of denunciation, foretelling or warning, going barefoot, or in sackcloth or undress, and, in a few cases, for brief periods, altogether naked; even women in some cases distinguished themselves by extravagance of conduct. The case of James Nayler (1617?-1660), who, in spite of Fox's grave warning, allowed Messianic homage to be paid to him, is the best known of these instances; they are to be explained partly by mental disturbance, resulting from the undue prominence of a single idea, and partly by the general religious excitement of the time and the rudeness of manners prevailing in the classes of society from which many of these individuals came. It must be remembered that at this time, and for long after, there was no definite or formal membership or system of admission to the society, and it was open to any one by attending the meetings to gain the reputation of being a Quaker.

The activity of the early Friends was not confined to England or even to the British Isles. Fox and others travelled in America and the West India Islands; another reached Jerusalem and preached against the superstition of the monks; Mary Fisher (fl. 1652-1697), "a religious maiden," visited Smyrna, the Morea and the court of Mahomed IV. at Adrianople; Alexander Parker (1628-1689) went to Africa; others made their way to Rome; two women were imprisoned by the Inquisition at Malta; two men passed into Austria and Hungary; and William Penn, George Fox and several others preached in Holland and Germany.

It was only gradually that the Quaker community clothed itself with an organization. The beginning of this appears to be due to William Dewsbury (1621-1683) and George Fox; it was not until 1666 that a complete system of church organization

¹ At the time referred to, and during the Commonwealth, the pulpits of the cathedrals and churches were occupied by Episcopalians of the Richard Baxter type, Presbyterians, Independents and a few Baptists. It is these, and not the clergy of the Church of England, who are continually referred to by George Fox as "priests."

was established. The introduction of an ordered system and discipline was, naturally, viewed with some suspicion by people taught to believe that the inward light of each individual man was the only true guide for his conduct. The project met with determined opposition for about twenty years (1675-1695) from persons of considerable repute in the body. John Wilkinson and John Story of Westmorland, together with William Rogers of Bristol, raised a party against Fox concerning the management of the affairs of the society, regarding with suspicion any fixed arrangement for meetings for conducting church business, and in fact hardly finding a place for such meetings at all. They stood for the principle of Independency against the Presbyterian form of church government which Fox had recently established in the "Monthly Meetings" (see below). They opposed all arrangement for the orderly distribution of travelling ministers to different localities, and even for the payment of their expenses (see above); they also strongly objected to any disciplinary power being entrusted to the women's separate meetings for business, which had become of considerable importance after the Plague (1665) and the Fire of London (1666) in consequence of the need for poor relief. They also claimed the right to meet secretly for worship in time of persecution (see below). They drew a considerable following away with them and set up a rival organization, but before long a number returned to their original leader. William Rogers set forth his views in *The Christian Quaker*, 1680; the story of the dissension is told, to some extent, in *The Inner Life of the Religious Societies of the Commonwealth*, by R. Barclay (not the "Apologist"); the best account is given in a pamphlet entitled *Micah's Mother* by John S. Rowntree.

Robert Barclay (*q.v.*), a descendant of an ancient Scottish family, who had received a liberal education, principally in Paris, at the Scots College, of which his uncle was rector, joined the Quakers about 1666, and William Penn (*q.v.*) came to them about two years later. The Quakers had always been active controversialists, and a great body of tracts and papers was issued by them; but hitherto these had been of small account from a literary point of view. Now, however, a more logical and scholarly aspect was given to their literature by the writings of Barclay, especially his *Apology for the True Christian Divinity* published in Latin (1676) and in English (1678), and by the works of Penn, amongst which *No Cross No Crown* and the *Maxims or Fruits of Solitude* are the best known.

During the whole time between their rise and the passing of the Toleration Act 1689, the Quakers were the object of almost continuous persecution which they endured with extraordinary constancy and patience; they insisted on the duty of meeting openly in time of persecution, declining to hold secret assemblies for worship as other Nonconformists were doing. The number who died in prison approached 400, and at least 100 more perished from violence and ill-usage. A petition to the first parliament of Charles II. stated that 3179 had been imprisoned; the number rose to 4500 in 1662, the Fifth Monarchy outbreak, in which Friends were in no way concerned, being largely responsible for this increase. There is no evidence to show that they were in any way connected with any of the plots of the Commonwealth or Restoration periods. A petition to James II. in 1685 stated that 1460 were then in prison. Under the Quaker Act of 1662 and the Conventicle Act of 1664 a number were transported out of England, and under the last-named act and that of 1670 (the second Conventicle Act) hundreds of households were despoiled of all their goods. The penal laws under which Friends suffered may be divided chronologically into those of the Commonwealth and the Restoration periods. Under the former there were a few charges of plotting against the government. Several imprisonments, including that of George Fox at Derby in 1650-1651, were brought about under the Blasphemy Act of 1650, which inflicted penalties on any one who asserted himself to be very God or equal with God, a charge to which the Friends were peculiarly liable owing to their doctrine of perfection. After a royalist insurrection in 1655, a proclamation was issued announcing that persons

suspected of Roman Catholicism would be required to take an oath abjuring the papal authority and transubstantiation. The Quakers, accused as they were of being Jesuits, and refusing to take the oath, suffered under this proclamation and under the more stringent act of 1656. A considerable number were bogged under the Vagrancy Acts (39 Eliz. c. 4; 7 Jac. I. c. 4), which were strained to cover the case of itinerant Quaker preachers. They also came under the provisions of the acts of 1644, 1650 and 1656 directed against travelling on the Lord's day. The interruption of preachers when celebrating divine service rendered the offender liable to three months' imprisonment under a statute of the first year of Mary, but Friends generally waited to speak till the service was over.¹ The Lord's Day Act 1656 also enacted penalties against any one disturbing the service, but apart from statute many Friends were imprisoned for open contempt of ministers and magistrates. At the Restoration 700 Friends, imprisoned for contempt and some minor offences, were set at liberty. After the Restoration there began a persecution of Friends and other Nonconformists *as such*, notwithstanding the king's Declaration of Breda which had proclaimed liberty for tender consciences as long as no disturbance of the peace was caused. Among the most common causes of imprisonment was the practice adopted by judges and magistrates of tendering to Friends (particularly when no other charge could be proved against them) the Oaths of Supremacy and Allegiance (5 Eliz. c. 1 & 7 Jac. I. c. 6). The refusal in any circumstance to take an oath led to much suffering. The Act 3 Jac. I. c. 4, passed in consequence of the Gunpowder Plot, against Roman Catholics for not attending church, was put in force against Friends, and under it enormous fines were levied. The Quaker Act 1662 and the Conventicle Acts of 1664 and 1670, designed to enforce attendance at church, and inflicting severe penalties on those attending other religious gatherings, were responsible for the most severe persecution of all. The act of 1670 gave to informers a pecuniary interest (they were to have one-third of the fine imposed) in hunting down Nonconformists who broke the law, and this and other statutes were unduly strained to secure convictions. A somewhat similar act of 35 Eliz. c. 1., enacting even more severe penalties, had never been repealed, and was sometimes put in force against Friends. The Militia Act 1663 (14 Car. II. c. 3), enacting fines against those who refused to find a man for the militia, was occasionally put in force. The refusal to pay tithes and other ecclesiastical demands led to continuous and heavy distrains, under the various laws made in that behalf. This state of things continued to some extent into the 19th century. For further information see "The Penal Laws affecting Early Friends in England" (from which the foregoing summary is taken) by Wm. Chas. Braithwaite in *The First Publishers of Truth*. On the 15th of March 1672 Charles II. issued his declaration suspending the penal laws in ecclesiastical matters, and shortly afterwards, by pardon under the great seal, he released nearly 500 Quakers from prison, remitted their fines and released such of their estates as were forfeited by *promissio*. It is of interest to note that, although John Bunyan was bitterly opposed to Quakers, his friends, on hearing of the petition contemplated by them, requested them to insert his name on the list, and in this way he gained his freedom. The dissatisfaction which this exercise of the royal prerogative aroused induced the king, in the following year, to withdraw his proclamation, and, notwithstanding appeals to him, the persecution continued intermittently throughout his reign. On the accession of James II. the Quakers addressed him (see above) with some hope on account of his known friendship for William Penn, and the king not long afterwards directed a stay of proceedings in all matters pending in the exchequer against Quakers on the ground of non-attendance at the national worship. In 1687 came his declaration for liberty of conscience, and, after the Revolution of 1688, the Toleration Act 1689 put an end to the persecution of Quakers (along with other Dissenters) for non-attendance at church.

¹ On the whole subject of preaching "after the priest had done," see Barclay's *Inner Life of the Religious Societies of the Commonwealth*, ch. xii.

For many years after this they were liable to imprisonment for non-payment of tithes, and, together with other Dissenters, they remained under various civil disabilities, the gradual removal of which is part of the general history of England. In the years succeeding the Toleration Act at least twelve of their number were prosecuted (often more than once in the spiritual and other courts) for keeping school without a bishop's licence. It is coming to be recognized that the growth of religious toleration owed much to the early Quakers who, with the exception of a few Baptists at the first, stood almost alone among Dissenters in holding their public meetings openly and regularly.

The Toleration Act was not the only law of William and Mary which benefited Quakers. The legislature has continually had regard to their refusal to take oaths, and not only the said act but also another of the same reign, and numerous others, subsequently passed, have respected the peculiar scruples of Friends (see Davis's *Digest of Legislative Enactments relating to Friends*, Bristol, 1820).

2. *Period 1689-1835.*—From the beginning of the 18th century the zeal of the Quaker body abated. Although many "General" and other meetings were held in different parts of the country for the purpose of setting forth Quakerism, the notion that the whole Christian church would be absorbed in it, and that the Quakers were, in fact, the church, gave place to the conception that they were "a peculiar people" to whom, more than to others, had been given an understanding of the will of God. The Quakerism of this period was largely of a traditional kind; it dwelt with increasing emphasis on the peculiarities of its dress and language; it rested much upon discipline, which developed and hardened into rigorous forms; and the correction or exclusion of its members occupied more attention than did the winning of converts.

Excluded from political and municipal life by the laws which required either the taking of an oath or joining in the Lord's Supper according to the rites of the Established Church, excluding themselves not only from the frivolous pursuits of pleasure, but from music and art in general, attaining no high average level of literary culture (though producing some men of eminence in science and medicine), the Quakers occupied themselves mainly with trade, the business of their Society, and the calls of philanthropy. From early times George Fox and many others had taken a keen interest in education, and in 1779 there was founded at Ackworth, near Pontefract, a school for boys and girls; this was followed by the reconstitution, in 1808, of a school at Sidcot in the Mendips, and in 1811, of one in Islington Road, London; it was afterwards removed to Croydon, and, later, to Saffron Walden. Others have since been established at York and in other parts of England and Ireland. None of them are now reserved exclusively for the children of Friends.

During this period Quakerism was sketched from the outside by two very different men. Voltaire (*Dictionnaire Philosophique*, "Quaker," "Toleration") described the body, which attracted his curiosity, his sympathy and his sneers, with all his brilliance. Thomas Clarkson (*Portraiture of Quakerism*) has given an elaborate and sympathetic account of the Quakers as he knew them when he travelled amongst them from house to house on his crusade against the slave trade.

3. *From 1835.*—During the 18th century the doctrine of the Inward Light acquired such exclusive prominence as to bring about a tendency to disparage, or, at least, to neglect, the written word (the Scriptures) as being "outward" and non-essential. In the early part of the 19th century an American Friend, Elias Hicks, pressed this doctrine to its furthest limits, and, in doing so, he laid stress on "Christ within" in such a way as practically to take little account of the person and work of the "outward," i.e. the historic Christ. The result was a separation of the Society in America into two divisions which persist to the present day (see below, "Quakerism in America"). This led to a counter movement in England, known as the Beacon Controversy, from the name of a warning publication issued by Isaac Crewdson of Manchester in 1835, advocating views of a pronounced "evangelical" type. Much controversy ensued, and a certain number

of Friends (Beaconites as they are sometimes called) departed from the parent stock. They left behind them, however, many influential members, who may be described as a middle party, and who strove to give a more "evangelical" tone to Quaker doctrine. Joseph John Gurney of Norwich, a brother of Elizabeth Fry, by means of his high social position and his various writings (some published before 1835), was the most prominent actor in this movement. Those who quitted the Society maintained, for some little time, a separate organization of their own, but sooner or later most of them joined the Evangelical Church or the Plymouth Brethren.

Other causes have been at work modifying the Quaker society. The repeal of the Test Act, the admission of Quakers to Parliament in consequence of their being allowed to affirm instead of taking the oath (1832, when Joseph Pease was elected for South Durham), the establishment of the University of London, and, more recently, the opening of the universities of Oxford and Cambridge to Nonconformists, have all had their effect upon the body. It has abandoned its peculiarities of dress and language, as well as its hostility to music and art, and it has cultivated a wider taste in literature. In fact, the number of men, either Quakers or of Quaker origin and proclivities, who occupy positions of influence in English life is large in proportion to the small body with which they are connected. During the 19th century the interests of Friends became widened and they are no longer a close community.

Doctrine.—It is not easy to state with certainty the doctrines of a body which (in England at least) has never demanded subscription to any creed, and whose views have undoubtedly undergone more or less definite changes. There is not now the sharp distinction which formerly existed between Friends and other non-sacerdotal evangelical bodies; these have, in theory at least, largely accepted the spiritual message of Quakerism. By their special insistence on the fact of immediate communion between God and man, Friends have been led into those views and practices which still mark them off from their fellow-Christians.

Nearly all their distinctive views (e.g. their refusal to take oaths, their testimony against war, their disuse of a professional ministry, and their recognition of women's ministry) were being put forward in England, by various individuals or sects, in the strife which raged during the intense religious excitement of the middle of the 17th century. Nevertheless, before the rise of the Quakers, these views were nowhere found in conjunction as held by any one set of people; still less were they regarded as the outcome of any one central belief or principle. It is rather in their emphasis on this thought of Divine communion, in their insistence on its reasonable consequences (as it seems to them), that Friends constitute a separate community. The appointment of one man to preach, to the exclusion of others, whether he feels a divine call so to do or not, is regarded as a limitation of the work of the Spirit and an undue concentration of that responsibility which ought to be shared by a wider circle. For the same reason they refuse to occupy the time of worship with an arranged programme of vocal service; they meet in silence, desiring that the service of the meeting shall depend on spiritual guidance. Thus it is left to any man or woman to offer vocal prayer, to read the Scriptures, or to utter such exhortation or teaching as may seem to be called for. Of late years, in certain of their meetings on Sunday evening, it has become customary for part of the time to be occupied with set addresses for the purpose of instructing the members of the congregation, or of conveying the Quaker message to others who may be present, all their meetings for worship being freely open to the public. In a few meetings hymns are occasionally sung, very rarely as part of any arrangement, but almost always upon the request of some individual for a particular hymn appropriate to the need of the congregation. The periods of silence are regarded as times of worship equally with those occupied with vocal service, inasmuch as Friends hold that robustness of spiritual life is best promoted by earnest striving on the part of each one to know the will of God for

himself, and to be drawn into Christian fellowship with the other worshippers. The points on which special stress is laid are:—(1) the share of responsibility resting on each individual, whether called to vocal service or not, for the right spiritual atmosphere of the Meeting, and for the welfare of the congregation; (2) the privilege which may be enjoyed by each worshipper of waiting upon the Lord without relying on spoken words, however helpful, or on other outward matters; (3) freedom for each individual (whether a Friend or not) to speak, for the help of others, such message as he or she may feel called to utter; (4) a fresh sense of a divine call to deliver the message on that particular occasion, whether previous thought has been given to it or not. The idea which ought to underlie a Friends' meeting is thus set forth by Robert Barclay: "When I came into the silent assemblies of God's people, I felt a secret power among them, which touched my heart, and as I gave way unto it, I found the evil weakening in me and the good raised up" (*Apology*, xi. 7). In many places Friends have felt the need of bringing spiritual help to those who are unable to profit by the somewhat severe discipline of their ordinary manner of worship. To meet this need they hold (chiefly on Sunday evenings) meetings which are not professedly "Friends' meetings for worship," but which are services conducted on lines similar to those of other religious bodies, with, in some cases, a portion of time set apart for silent worship, and freedom for any one of the congregation to utter words of exhortation or prayer.

From the beginning Friends have not practised the outward ordinances of Baptism and the Lord's Supper, even in a non-sacerdotal spirit. They attach, however, supreme value to the realities of which the observances are reminders or types—on the Baptism which is more than putting away the filth of the flesh, and on the vital union with Christ which is behind any outward ceremony. Their testimony is not *primarily* against these outward observances; their disuse of them is due to a sense of the danger of substituting the shadow for the reality. They believe that an experience of more than 250 years gives ample warrant for the belief that Christ did not command them as a perpetual outward ordinance; on the contrary, they hold that it was alien to His method to lay down minute, outward rules for all time, but that He enunciated principles which His Church should, under the guidance of the Holy Spirit, apply to the varying needs of the day. Their contention that every event of life may be turned into a sacrament, a means of grace, is summed up in the words of Stephen Grellet: "I very much doubt whether, since the Lord by His grace brought me into the faith of His dear Son, I have ever broken bread or drunk wine, even in the ordinary course of life, without the remembrance of, and some devout feeling regarding, the broken body and the bloodshedding of my dear Lord and Saviour."

When the ministry of any man or woman has been found to be helpful to the congregation, the Monthly Meeting (see below) may, after solemn consideration, record the fact that it believes the individual to have a divine call to the ministry, and that it encourages him or her to be faithful to the gift. Such ministers are said to be "acknowledged" or "recorded"; they are emphatically *not* appointed to preach, and the fact of their acknowledgment is not regarded as conferring any special status upon them. The various Monthly Meetings appoint Elders, or some body of Friends, to give advice of encouragement or restraint as may be needed, and, generally, to take the ministry under their care.

With regard to the ministry of women, Friends hold that there is no evidence that the gifts of prophecy and teaching are confined to one sex. On the contrary, they see that a manifest blessing has rested on women's preaching, and they regard its almost universal prohibition as a relic of the seclusion of women which was customary in the countries where Christianity took its rise. The particular prohibition of Paul (1 Cor. xiv. 34, 35) they regard as due to the special circumstances of time and place.

Friends have always held that war is contrary to the precepts and spirit of the Gospel, believing that it springs from the lower

impulses of human nature, and not from the seed of divine life with its infinite capacity of response to the Spirit of God. Their testimony is not based *primarily* on any objection to the use of force in itself, or even on the fact that war involves suffering and loss of life; their root objection is based on the fact that war is both the outcome and the cause of ambition, pride, greed, hatred and everything that is opposed to the mind of Christ; and that no end to be attained can justify the use of such means. While not unaware that with this, as with all moral questions, there may be a certain borderland of practical difficulty, Friends endeavour to bring all things to the test of the Realities which, though not seen, are eternal, and to hold up the ideal, set forth by George Fox, of living in the virtue of that life and power which takes away the occasion of war.

Friends have always held that the attempt to enforce truth-speaking by means of an oath, in courts of law and elsewhere, tends to create a double standard of truth. They find Scripture warrant for this belief in Matt. v. 33-37 and James v. 12. Their testimony in this respect is the better understood when we bear in mind the large amount of perjury in the law courts, and profane swearing in general which prevailed at the time when the Society took its rise. "People swear to the end that they may speak truth; Christ would have men speak truth to the end they might not swear" (W. Penn, *A Treatise of Oaths*).

With regard to the fundamental doctrines of Christianity the belief of the Society of Friends does not essentially differ from that of other Christian bodies. At the same time their avoidance of exact definition embodied in a rigid creed, together with their disuse of the outward ordinances of Baptism and the Supper, has laid them open to considerable misunderstanding. As will have been seen, they hold an exalted view of the divinity and work of Christ as the Word become flesh and the Saviour of the world; but they have always shrunk from rigid Trinitarian definitions. They believe that the same Spirit who gave forth the Scriptures still guides men to a right understanding of them. "You profess the Holy Scriptures: but what do you witness and experience? What interest have you in them? Can you set to your seal that they are true by the work of the same spirit in you that gave them forth in the holy ancients?" (William Penn, *A Summons or Call to Christendom*). At certain periods this doctrine, pushed to an extreme, has led to a practical undervaluing of the Scriptures, but of late times it has enabled Friends to face fearlessly the conclusions of modern criticism, and has contributed to a largely increased interest in Bible study. During the past few years a new movement has been started in the shape of lecture schools, lasting for longer or shorter periods, for the purpose of studying Biblical, ecclesiastical and social subjects. In 1903 there was established at Woodbrooke, an estate at Selly Oak on the outskirts of Birmingham, a permanent settlement for men and women, for the study of these questions on modern lines. The outward beginning of this movement was the Manchester Conference of 1895, a turning-point in Quaker history. Speaking generally, it may be noted that the Society includes various shades of opinion, from that known as "evangelical," with a certain hesitation in receiving modern thought, to the more "advanced" position which finds greater freedom to consider and adopt new suggestions of scientific, religious or other thinkers. The differences, however, are seldom pressed, and rarely become acute. Apart from points of doctrine which can be more or less definitely stated (not always with unanimity) Quakerism is an *atmosphere*, a manner of life, a method of approaching questions, a habit and attitude of mind.

Quakerism in Scotland.—Quakerism was preached in Scotland very soon after its rise in England; but in the north and south of Scotland there existed, independently of and before this preaching, groups of persons who were dissatisfied with the national form of worship and who met together in silence for devotion. They naturally fell into this Society. In Aberdeen the Quakers took considerable hold, and were there joined by

some persons of influence and position, especially Alexander Jaffray, sometime provost of Aberdeen, and Colonel David Barclay of Ury and his son Robert, the author of the *Apology*. Much light has been thrown on the history of the Quakers in Aberdeenshire by the discovery in 1826 at Ury of a MS. *Diary of Jaffray*, since published with elucidations (2nd ed., London, 1836).

Ireland—The father of Quakerism in Ireland was William Edmondson; his preaching began in 1653-1654. The *History of the Quakers in Ireland* (from 1653 to 1752), by Wight and Rutty, may be consulted. Dublin Yearly Meeting, constituted in 1670, is independent of London Yearly Meeting (see below).

America.—In July 1656 two women Quakers, Mary Fisher and Ann Austin, arrived at Boston. Under the general law against heresy their books were burnt by the hangman, they were searched for signs of witchcraft, they were imprisoned for five weeks and then sent away. During the same year eight others were sent back to England.

In 1656, 1657 and 1658 laws were passed to prevent the introduction of Quakers into Massachusetts, and it was enacted that on the first conviction one ear should be cut off, on the second the remaining ear, and that on the third conviction the tongue should be bored with a hot iron. Fines were laid upon all who entertained these people or were present at their meetings. Thereupon the Quakers, who were perhaps not without the obstinacy of which Marcus Aurelius complained in the early Christians, rushed to Massachusetts as if invited, and the result was that the general court of the colony banished them on pain of death, and four of them, three men and one woman, were hanged for refusing to depart from the jurisdiction or for obstinately returning within it. That the Quakers were, at times, irritating cannot be denied: some of them appear to have publicly mocked the institutions and the rulers of the colony and to have interrupted public worship; and a few of their men and women acted with the fanaticism and disorder which frequently characterized the religious controversies of the time. The particulars of the proceedings of Governor Endecott and the magistrates of New England as given in Besse's *Sufferings of the Quakers* (see below) are startling to read. On the Restoration of Charles II. a memorial was presented to him by the Quakers in England stating the persecutions which their fellow-members had undergone in New England. Even the careless Charles was moved to issue an order to the colony which effectually stopped the hanging of the Quakers for their religion, though it by no means put an end to the persecution of the body in New England.

It is not wonderful that the Quakers, persecuted and oppressed at home and in New England, should turn their eyes to the unoccupied parts of America, and cherish the hope of founding, amidst their woods, some refuge from oppression, and some likeness of a city of God upon earth. As early as 1660 George Fox was considering the question of buying land from the Indians. In 1671-1673 he had visited the American plantations from Carolina to Rhode Island and had preached alike to Indians and to settlers; in 1674 a portion of New Jersey (*q.v.*) was sold by Lord Berkeley to John Fenwicke in trust for Edward Byllynge. Both these men were Quakers, and in 1675 Fenwicke with a large company of his co-religionists crossed the Atlantic, sailed up Delaware Bay, and landed at a fertile spot which he called Salem. Byllynge, having become embarrassed in his circumstances, placed his interest in the land in the hands of Penn and others as trustees for his creditors; they invited buyers, and companies of Quakers in Yorkshire and London were amongst the largest purchasers. In 1677-1678 five vessels with eight hundred emigrants, chiefly Quakers, arrived in the colony (then separated from the rest of New Jersey, under the name of West New Jersey), and the town of Burlington was established. In 1677 the fundamental laws of West New Jersey were published, and recognized in a most absolute form the principles of democratic equality and perfect freedom of conscience. Notwithstanding certain troubles from claims of the governor of New York and of the duke of York, the colony prospered, and in 1681 the first legislative assembly of the colony, consisting mainly of

Quakers, was held. They agreed to raise an annual sum of £300 for the expenses of their commonwealth; they assigned their governor a salary of £20; they prohibited the sale of ardent spirits to the Indians and imprisonment for debt. (See *NEW JERSEY*.)

But beyond question the most interesting event in connexion with Quakerism in America is the foundation by William Penn (*q.v.*) of the colony of Pennsylvania, where he hoped to carry into effect the principles of his sect—to found and govern a colony without armies or military power, to reduce the Indians by justice and kindness to civilization and Christianity, to administer justice without oaths, and to extend an equal toleration to all persons who professed a belief in God. The history of this is part of the history of America and of Pennsylvania (*q.v.*) in particular. The chief point of interest in the history of Friends in America during the 18th century is their effort to clear themselves of complicity in slavery and the slave trade. As early as 1671 George Fox when in Barbados counselled kind treatment of slaves and ultimate liberation of them. William Penn provided for the freedom of slaves after fourteen years' service. In 1688 the German Friends of Germantown, Philadelphia, raised the first official protest uttered by any religious body against slavery. In 1711 a law was passed in Pennsylvania prohibiting the importation of slaves, but it was rejected by the Council in England. The prominent anti-slavery workers were Ralph Sandiford, Benjamin Lay, Anthony Benezet and John Woolman.¹ By the end of the 18th century slavery was practically extinct among Friends, and the Society as a whole laboured for its abolition, which came about in 1865, the poet Whittier being one of the chief writers and workers in the cause. From early times up to the present day Friends have laboured for the welfare of the North American Indians. The history of the 19th century is largely one of division. Elias Hicks (*q.v.*), of Long Island, N.Y., propounded doctrines inconsistent with the orthodox views concerning Christ and the Scriptures, and a separation resulted in 1827-1828 (see above). His followers are known as "Hicksites," a name not officially used by themselves, and only assented to for purposes of description under some protest. They have their own organization, being divided into seven yearly meetings numbering about 20,000 members, but these meetings form no part of the official organization which links London Yearly Meeting with other bodies of Friends on the American continent. This separation led to strong insistence on the "evangelical" views (in the usual sense of the term) concerning Christ, the Atonement, imputed righteousness, the Scriptures, &c. This showed itself in the Beaconite controversy in England (see above), and in a further division in America. John Wilbur, a minister of New England, headed a party of protest against the new evangelicalism, laying extreme stress on the "Inward Light"; the result was a further separation of the "Wilburites" or "the smaller body," who, like the "Hicksites," have a separate independent organization of their own. In 1907 they were divided into seven yearly meetings (together with some smaller independent bodies, the result of extreme emphasis laid on individualism), with a membership of about 5000. Broadly speaking, the "smaller body" is characterized by a rigid adherence to old forms of dress and speech, to a disapproval of music and art, and to an insistence on the "Inward Light" which, at times, leaves but little room for the Scriptures or the historic Christ, although with no definite or intended repudiation of them. In 1908 the number of "orthodox" yearly meetings in America, including one in Canada, was fifteen, with a total membership of about 100,000. They have, for the most part, adopted, to a greater or less degree, the "pastoral system," *i.e.* the appointment of one man or woman in each congregation to "conduct" the meeting for worship and to carry on pastoral work. In most cases the pastor receives a salary. A few of them demand from their ministers definite subscription to a specific body of doctrine, mostly of the ordinary "evangelical" type. In the matters of

¹Woolman's *Journal and Works* are remarkable. He had a vision of a political economy based not on selfishness but on love, not on desire but on self-denial.

organization, disuse of the outward ordinances (this point is subject to some slight exception, principally in Ohio), and women's ministry, they do not differ from English Friends. The yearly meetings of Baltimore and Philadelphia have not adopted the pastoral system; the latter contains a very strong conservative element, and, contrary to the practice of London and the other "orthodox" yearly meetings, it officially regards the meetings of "the smaller body" (see above) as meetings of the Society of Friends. In 1902 the "orthodox" yearly meetings in the United States established a "Five Years' Meeting," a representative body meeting once every five years to consider matters affecting the welfare of all, and to further such philanthropic and religious work as may be undertaken in common, e.g. matters concerning foreign missions, temperance and peace, and the welfare of negroes and Indians. Two yearly meetings remain outside the organization, that of Ohio on ultra-evangelical grounds, while that of Philadelphia has not taken the matter into consideration. Canada joined at the first, and having withdrawn, again joined in 1907.

See James Bowden, *History of the Society of Friends in America* (1850-1854); Allan C. and Richard H. Thomas, *The History of Friends in America* (4th edition, 1905); Isaac Sharpless, *History of Quaker Government in Pennsylvania* (1898, 1899); R. P. Hallowell, *The Quaker Invasion of Massachusetts* (1887); and *The Pioneer Quakers* (1887).

Organization and Discipline.—The duty of watching over one another for good was insisted on by the early Friends, and has been embodied in a system of discipline. Its objects embrace (a) admonition to those who fail in the payment of their just debts, or otherwise walk contrary to the standard of Quaker ethics, and the exclusion of obstinate or gross offenders from the body, and, as incident to this, the hearing of appeals from individuals or meetings considering themselves aggrieved; (b) the care and maintenance of the poor and provision for the Christian education of their children, for which purpose the Society has established boarding schools in different parts of the country; (c) the amicable settlement of "all differences about outward things," either by the parties in controversy or by the submission of the dispute to arbitration, and the restraint of all proceedings at law between members except by leave; (d) the "recording" of ministers (see above); (e) the cognizance of all steps preceding marriage according to Quaker forms; (f) the registration of births, deaths and marriages and the admission of members; (g) the issuing of certificates or letters of approval granted to ministers travelling away from their homes, or to members removing from one meeting to another; and (h) the management of the property belonging to the Society. The meetings for business further concern themselves with arrangements for spreading the Quaker doctrine, and for carrying out various religious, philanthropic and social activities not necessarily confined to the Society of Friends.

The present organization of the Quaker church is essentially democratic: every person born of Quaker parents is a member, and, together with those who have been admitted on their own request, is entitled to take part in the business assemblies of any meeting of which he or she is a member. The Society is organized as a series of subordinated meetings which recall to the mind the Presbyterian model. The "Preparative Meeting," usually consists of a single congregation; next in order comes the "Monthly Meeting," the executive body, usually embracing several Preparative Meetings called together, as its name indicates, monthly (in some cases less often); then the "Quarterly Meeting," embracing several Monthly Meetings; and lastly the "Yearly Meeting," embracing the whole of Great Britain (but not Ireland). After several yearly or "general" meetings had been held in different places at irregular intervals as need arose, the first of an uninterrupted series met in 1668. From that date until 1904 it was held in London. In 1905 it met in Leeds, and in 1908 in Birmingham. Its official title is "London Yearly Meeting." It is the legislative body of Friends in Great Britain. It considers questions of policy, and some of its sittings are conferences for the consideration of reports on religious, philanthropic, educational and social work which is carried on. Its sessions occupy a week in May of each year. Representatives are sent from each inferior to each superior meeting, but they have no precedence over others, and all Friends may attend any meeting and take part in any of which they are members. Formerly the system was doubled, the men and women meeting separately for their own appointed business. Of late years the meetings have been, for the most part, held jointly, with equal

liberty for all men and women to state their opinions, and to serve on all committees and other appointments. The mode of conducting these meetings is noteworthy. A secretary or "clerk," as he is called, acts as chairman or president; there are no formal resolutions; and there is no voting or applause. The clerk ascertains what he considers to be the judgment of the assembly, and records it in a minute. The permanent standing committee of the Society is known as the "Meeting for Sufferings" (established in 1675), which took its rise in the days when the persecution of many Friends demanded the Christian care and material help of those who were able to give it. It is composed of representatives (men and women) sent by the quarterly meetings, and of all recorded Ministers and Elders. Its work is not confined to the interests of Friends; it is sensitive to the call of oppression and distress (e.g. a famine) in all parts of the world, it frequently raises large sums of money to alleviate the same, and intervenes, often successfully, and mostly without publicity, with those in authority who have the power to bring about an amelioration.

The offices known to the Quaker body are: (1) that of *minister* (the term "office" is not strictly applicable, see above as to "recording"); (2) of *elder*, whose duty it is "to encourage and help young ministers, and advise others as they, in the wisdom of God, see occasion"; (3) of *overseer*, to whom is especially entrusted that duty of Christian care for and interest in one another which Quakers recognize as obligatory in all the members of a church. In most Monthly Meetings the care of the poor is committed to the overseers. These officers hold, from time to time, meetings separate from the general assemblies of the members, but the special organization for many years known as the Meeting of Ministers and Elders, reconstituted in 1876 as the Meeting on Ministry and Oversight, came to an end in 1906-1907.

This present form both of organization and of discipline has been reached only by a process of development. As early as 1652-1654 there is evidence of some slight organization for dealing with marriages, poor relief, "disorderly walkers," matters of arbitration, &c. The Quarterly or "General" meetings of the different counties seem to have been the first unions of separate congregations. In 1666 Fox established Monthly Meetings; in 1727 elders were first appointed; in 1752 overseers were added; and in 1737 the right of children of Quakers to be considered as members was fully recognized. Concerning the 18th century in general, see above.

Of late years the stringency of the Quaker discipline has been relaxed: the peculiarities of dress and language have been abandoned; marriage with a non-member or between two non-members is now possible at a Quaker meeting-house; and marriage elsewhere has ceased to involve exclusion from the body. Above all, many of its members have come to "the conviction, which is not new, but old, that the virtues which can be rewarded and the vices which can be punished by external discipline are not as a rule the virtues and the vices that make or mar the soul" (Hatch, *Bampton Lectures*, 81).

A genuine vein of philanthropy has always existed in the Quaker body. In nothing has this been more conspicuous than in the matter of slavery. George Fox and William Penn laboured to secure the religious teaching of slaves. As early as 1676 the assembly of Barbados passed "An Act to prevent the people called Quakers from bringing negroes to their meetings." On the attitude of Friends in America to slavery, see the section "Quakerism in America" (above). In 1783 the first petition to the House of Commons for the abolition of the slave trade and slavery went up from the Quakers; and in the long agitation which ensued the Society took a prominent part.

In 1798 Joseph Lancaster, himself a Friend, opened his first school for the education of the poor; and the cause of unsectarian religious education found in the Quakers steady support. They also took an active part in Sir Samuel Romilly's efforts to ameliorate the penal code, in prison reform, with which the name of Elizabeth Fry (a Friend) is especially connected, and in the efforts to ameliorate the condition of lunatics in England (the Friends' Retreat at York, founded in 1792, was the earliest example in England of kindly treatment of the insane). It is noteworthy that Quaker efforts for the education of the poor and philanthropy in general, though they have always been Christian in character, have not been undertaken primarily for the purpose of bringing proselytes within the body, and have not done so to any great extent.

By means of the Adult Schools, Friends have been able to exercise a religious influence beyond the borders of their own Society. The movement began in Birmingham in 1845, in an attempt to help the loungers at street corners; reading and writing were the chief inducements offered. The schools are unsectarian in character and mainly democratic in government: the aim is to draw out what is best in men and to induce them to act for the help of their fellows. Whilst the work is essentially religious in character, a well-equipped school also caters for the social, intellectual and physical parts of a man's nature. Bible teaching is the central part of the school session; the lessons are mainly concerned with life's practical problems. The spirit of brotherliness which prevails is largely the secret of the success of the movement. At the end of 1909 there were in connexion with the "National Council of Adult-School Associations" 1818 "schools" for men with

hip of about 113,789; and 402 for women with a membership of 27,000. The movement, which is no longer exclusively control of Friends, is rapidly becoming one of the chief ringing about a religious fellowship among a class which sed churches have largely failed to reach. The effect of upon the Society itself may be summarized thus: some membership; the creation of a sphere of usefulness for and more active members; a general stirring of interest estions.¹

interest in Sunday schools for children preceded the ool movement. The earliest schools which are still re formed at Bristol, for boys in 1810 and for girls in the ear. Several isolated efforts were made earlier than this; it that there was a school at Lothersdale near Skipton or the preservation of the youth of both sexes, and for iction in useful learning"; and another at Nottingham. r still were the Sunday and day schools in Rossendale, , dating from 1793. At the end of 1909 there were in with the Friends' First-Day School Association 240 h 2722 teachers and 25,215 scholars, very few of whom hildren of members and "attenders," which are usually or during a portion of the time of the morning meeting ; in these distinctly denominational teaching is given. rgan, *Teachers and Taught*.

rganizational committee" of members of the Society of Friends l in 1865 to deal with offers of service in foreign lands. In 1868 this developed into the Friends' Foreign Mission Association, which now undertakes Missionary work in India (begun 1866), Madagascar (1867), Syria (1869), 16), Ceylon (1896). In 1909 the number of missionaries wives) was 113; organized churches, 194; members and 21,085; schools, 135; pupils, 7042; hospitals and 5, 17; patients treated, 6865; subscriptions raised from Great Britain and Ireland, £26,689, besides £3245 received s of work. Quarterly organ, *Our Missions*.

of Quakerism.—At the close of 1909 there were 18,686 e number includes children) in Great Britain; and s" and habitual "attenders" not in membership, 8586; congregations regularly meeting, 390. Ireland—mem-; habitual attenders not in membership, 402.

of offices and reference library of the Society of Friends at Devonshire House, Bishopsgate Without, London.

phy.—The writings of the early Friends are very numer- ously noteworthy are the *Journals* of George Fox and of llwood, both autobiographies, the *Apology* and other Robert Barclay, and the works of Penn and Penington. e 18th century William Sewel, a Dutch Quaker, wrote a e Society and published an English translation; modern ics have been written by T. Edmund Harvey (*The Quakers*) and by Mrs Emmott (*The Story of Quakerism*). ings of the Quakers by Joseph Besse (1753) gives a detailed f the persecution of the early Friends in England and n. An excellent portraiture of early Quakerism is given in nner's *Lectures on Friends in Bristol and Somersetshire*. of *Discipline* in its successive printed editions from 1783 tains the working rules of the organization, and also a n of testimonies borne by the Society at different periods, nt points of Christian truth, and often called forth by the cumstances of the time. *The Inner Life of the Religious f the Commonwealth* (London, 1876) by Robert Barclay, nt of the Apologist, contains much curious information Quakers. See also "Quaker" in the index to Masson's *llion*. Joseph Smith's *Descriptive Catalogue of Friends' ondon, 1867* gives the information which its title promises; author has also published a catalogue of works hostile to e.

For an exposition of Quakerism on its spiritual side the poems by Whittier may be referred to, also *Quaker's and Light Arising* by Caroline E. Stephens; *The Society of s Faith and Practice*, and other works by John Stephenson ; *A Dynamic Faith* and other works by Rufus M. Jones; and the *Light Within* and other works by Edw. Grubb, ries of "Swarthmore Lectures" as well as the histories tioned. Much valuable information will be found in *John's Rowntree: His Life and Work* (1908). The history of the ward movement may be studied in *Essays and Addresses* ilhelm Rowntree, and in *Present Day Papers* edited by him. f life of the 18th century and the first half of the 19th is in *Records of a Quaker Family, the Richardsons of Cleveland, yce*, and *The Diaries of Edward Pease, the Father of English* edited by Sir A. E. Pease. Other works which may usefully ed are the *Journals* of John Woolman, Stephen Grellet and Fry; also *The First Publishers of Truth*, a reprint of con- accounts of the rise of Quakerism in various districts. dicals issued (not officially) in connexion with the Quaker *The Friend* (weekly), *The British Friend* (monthly), *The*

History of the Adult School Movement by J. W. Rowntree l. Binns. The organ of the movement is *One and All*, monthly. See also *The Adult School Year Book*.

Friends' Witness, *The Friendly Messenger*, *The Friends' Fellowship Papers*, *The Friends' Quarterly Examiner*, *Journal of the Friends' Historical Society*. Officially issued: *The Book of Meetings and The Friends' Year Book*. See also works mentioned at the close of sections on Adult Schools and on Quakerism in America, Scotland and Ireland, and elsewhere in this article; also FOX, GEORGE.

(A. N. B.)

FRIES, ELIAS MAGNUS (1794-1878), Swedish botanist, was born at Femsjö, Småland, on the 15th of August 1794. From his father, the pastor of the church at Femsjö, he early acquired an extensive knowledge of flowering plants. In 1811 he entered the university of Lund, where in 1814 he was elected docent of botany and in 1824 professor. In 1834 he became professor of practical economy at Upsala, and in 1844 and 1848 he represented the university of that city in the Rigsdag. On the death of Göran Wahlberg (1780-1851) he was appointed professor of botany at Upsala, where he died on the 8th of February 1878. Fries was admitted a member of the Swedish Royal Academy in 1847, and a foreign member of the Royal Society of London in 1875.

As an author on the Cryptogamia he was in the first rank. He wrote *Notiæ Floræ Suevicæ* (1814 and 1823); *Observationes mycologicæ* (1815); *Flora Hollandica* (1817-1818); *Systema mycologicum* (1821-1829); *Systema orbis vegetabilis*, not completed (1825); *Elenchus Jungerum* (1828); *Lichenographia Europæa* (1831); *Epicrisis systematis mycologici* (1838; 2nd ed., of *Hymenomycetes Europæi*, 1874); *Summa vegetabilium Scandinaviæ* (1846); *Sveriges ädliga och giftiga Svampar*, with coloured plates (1860); *Monographia hymenomycetum Suevicæ* (1863), with the *Icones hymenomycetum*, vol. i. (1867), and pt. i. vol. ii. (1877).

FRIES, JAKOB FRIEDRICH (1773-1843). German philosopher, was born at Barby, Saxony, on the 23rd of August 1773. Having studied theology in the academy of the Moravian brethren at Niesky, and philosophy at Leipzig and Jena, he travelled for some time, and in 1806 became professor of philosophy and elementary mathematics at Heidelberg. Though the progress of his psychological thought compelled him to abandon the positive theology of the Moravians, he always retained an appreciation of its spiritual or symbolic significance. His philosophical position with regard to his contemporaries he had already made clear in the critical work *Reinhold, Fichte und Schelling* (1803; reprinted in 1824 as *Polemische Schriften*), and in the more systematic treatises *System der Philosophie als evidente Wissenschaft* (1804), *Wissen, Glaube und Ahnung* (1805, new ed. 1905). His most important treatise, the *Neue oder anthropologische Kritik der Vernunft* (2nd ed., 1828-1831), was an attempt to give a new foundation of psychological analysis to the critical theory of Kant. In 1811 appeared his *System der Logik* (ed. 1819 and 1837), a very instructive work, and in 1814 *Julius und Evagoras*, a philosophical romance. In 1816 he was invited to Jena to fill the chair of theoretical philosophy (including mathematics and physics, and philosophy proper), and entered upon a crusade against the prevailing Romanticism. In politics he was a strong Liberal and Unionist, and did much to inspire the organization of the *Burschenschaft*. In 1816 he had published his views in a brochure, *Vom deutschen Bund und deutscher Staatsverfassung*, dedicated to "the youth of Germany," and his influence gave a powerful impetus to the agitation which led in 1819 to the issue of the Carlsbad Decrees by the representatives of the German governments. Karl Sand, the murderer of Kotzebue, was one of his pupils; and a letter of his, found on another student, warning the lad against participation in secret societies, was twisted by the suspicious authorities into evidence of his guilt. He was condemned by the Mainz Commission; the grand-duke of Weimar was compelled to deprive him of his professorship; and he was forbidden to lecture on philosophy. The grand-duke, however, continued to pay him his stipend, and in 1824 he was recalled to Jena as professor of mathematics and physics, receiving permission also to lecture on philosophy in his own rooms to a select number of students. Finally, in 1838, the unrestricted right of lecturing was restored to him. He died on the 10th of August 1843.

The most important of the many works written during his Jena professorate are the *Handbuch der praktischen Philosophie* (1817-1832), the *Handbuch der psychischen Anthropologie* (1820-1821, 2nd ed. 1837-1839), *Die mathematische Naturphilosophie* (1822),

System der Metaphysik (1824), *Die Geschichte der Philosophie* (1837-1840). Fries's point of view in philosophy may be described as a modified Kantianism, an attempt to reconcile the criticism of Kant and Jacobi's philosophy of belief. With Kant he regarded *Kritik*, or the critical investigation of the faculty of knowledge, as the essential preliminary to philosophy. But he differed from Kant both as regards the foundation for this criticism and as regards the metaphysical results yielded by it. Kant's analysis of knowledge had disclosed the a priori element as the necessary complement of the isolated a posteriori facts of experience. But it did not seem to Fries that Kant had with sufficient accuracy examined the mode in which we arrive at knowledge of this a priori element. According to him we only know these a priori principles through inner or psychical experience; they are not then to be regarded as transcendental factors of all experience, but as the necessary, constant elements discovered by us in our inner experience. Accordingly Fries, like the Scotch school, places psychology or analysis of consciousness at the foundation of philosophy, and called his criticism of knowledge an anthropological critique. A second point in which Fries differed from Kant is the view taken as to the relation between immediate and mediate cognitions. According to Fries, the understanding is purely the faculty of proof; it is in itself void; immediate certitude is the only source of knowledge. Reason contains principles which we cannot demonstrate, but which can be deduced, and are the proper objects of belief. In this view of reason Fries approximates to Jacobi rather than to Kant. His most original idea is the graduation of knowledge into knowing, belief and presentiment. We know phenomena, how the existence of things appears to us in nature; we believe in the true nature, the eternal essence of things (the good, the true, the beautiful); by means of presentiment (*Ahnung*) the intermediary between knowledge and belief, we recognize the supra-sensible in the sensible, the being in the phenomenon.

See E. L. Henke, *J. F. Fries* (1867); C. Graepengiesser, *J. F. Fries, ein Gedenkbild und Kant's "Kritik der Vernunft" und deren Fortbildung durch J. F. Fries* (1882); H. Strassovsky, *J. F. Fries als Kritiker der Kantischen Erkenntnistheorie* (1891); articles in Ersch and Gruber's *Allgemeine Encyclopädie und Allgemeine deutsche Biographie*; J. E. Erdmann, *Hist. of Philos.* (Eng. trans., London, 1890), vol. ii. § 305.

FRIES, JOHN (c. 1764-1825), American insurgent leader, was born in Pennsylvania of "Dutch" (German) descent about 1764. As an itinerant auctioneer he became well acquainted with the Germans in the S.E. part of Pennsylvania. In July 1798, during the troubles between the United States and France, Congress levied a direct tax (on dwelling-houses, lands and slaves) of \$2,000,000, of which Pennsylvania was called upon to contribute \$237,000. There were very few slaves in the state, and the tax was accordingly assessed upon dwelling-houses and land, the value of the houses being determined by the number and size of the windows. The inquisitorial nature of the proceedings aroused strong opposition among the Germans, and many of them refused to pay. Fries, assuming leadership, organized an armed band of about sixty men, who marched about the country intimidating the assessors and encouraging the people to resist. At last the governor called out the militia (March 1799) and the leaders were arrested. Fries and two others were twice tried for treason (the second time before Samuel Chase) and were sentenced to be hanged, but they were pardoned by President Adams in April 1800, and a general amnesty was issued on 21st May. The affair is variously known as the "Fries Rebellion," the "Hot-Water Rebellion"—because hot water was used to drive assessors from houses—, and the "Home Tax Rebellion." Fries died in Philadelphia in 1825.

See T. Carpenter, *Two Trials of John Fries . . . Taken in Short-hand* (Philadelphia, 1800); the second volume of McMaster's *History of the United States* (New York, 1883); and W. W. H. Davis, *The Fries Rebellion* (Doylestown, Pa., 1899).

FRIESLAND, or **VRIESLAND**, a province of Holland, bounded S.W., W. and N. by the Zuider Zee and the North Sea, E. by Groningen and Drenthe, and S.E. by Overysel. It also includes the islands of Ameland and Schiermonnikoog (see **FRISIAN ISLANDS**). Area, 1281 sq. m.; pop. (1900) 340,262. The soil of Friesland falls naturally into three divisions consisting of sea-clay in the north and north-west, of low-fer in between the south-west and north-east, and of a comparatively small area of high-fer in the south-east. The clay and low-fer furnish a luxuriant meadow-land for the principal industries of the province—cattle-rearing and cheese- and butter-making. Horse-breeding has also been practised for centuries, and the breed of black

Frisian horse is well known. On the clay lands agriculture is also extensively practised. In the high-fer district peat-digging is the chief occupation. The effect of this industry, however, is to lay bare a subsoil of diluvial sand which offers little inducement for subsequent cultivation. Despite the general productiveness of the soil, however, the social condition of Friesland has remained in a backward state and poverty is rife in many districts. The ownership of property being largely in the hands of absentee landlords, the peasantry have little interest in the land, the profits from which go to enrich other provinces. Moreover, the nature of the fertility of the meadow-lands is such as to require little manual labour, and other industrial means of subsistence have hardly yet come into existence. This state of affairs has given rise to a social-democratic outcry on account of which Friesland is sometimes regarded as the "Ireland of Holland." The water system of the province comprises a few small rivers (now largely canalized) in the high lands in the east, and the vast network of canals, waterways and lakes of the whole north and west. The principal lakes are Tjeuke Meer, Sloter Meer, De Fluessen and Sneeker Meer. The tides being lowest on the north coast of the province, the scheme of the Waterstaat, the government department (dating from 1879), provides for the largest removal of superfluous surface water into the Lauwerszee. But owing to the long distance which the water must travel from certain parts of the province, and the continual recession of the Lauwerszee, the drainage problem is a peculiarly difficult one, and floods are sometimes inevitable.

The population of the province is evenly distributed in small villages. The principal market centres are Leeuwarden, the chief towns, Sneek, Bolsward, Franeker (*qq.v.*), Dokkum (4033) and Heerenveen (5011). With the exception of Franeker and Heerenveen all these towns originally arose on the inlet of the Middle Sea. The seaport towns are more or less decayed; they include Stavoren (820), Hindeloopen (1030), Workum (3428), Harlingen (*q.v.*) and Makkum (2456).

For history see **FRISIANS**.

FRIEZE. 1. (Through the Fr. *frise*, and Ital. *fregio*, from the Lat. *Phrygium*, *sc. opus*, Phrygian or embroidered work), a term given in architecture to the central division of the entablature of an order (see **ORDER**), but also applied to any oblong horizontal feature, introduced for decorative purposes and enriched with carving. The Doric frieze had a structural origin as the triglyphs suggest vertical support. The Ionic frieze was purely decorative and probably did not exist in the earliest examples, if we may judge by the copies found in the Lycian tombs carved in the rock. There is no frieze in the Caryatid portico of the Erechtheum, but in the Ionic temples its introduction may have been necessitated in consequence of more height being required in the entablature to carry the beams supporting the lacunaria over the peristyle. In the frieze of the Erechtheum the figures (about 2 ft. high) were carved in white marble and affixed by clamps to a background of black Eleusinian marble. The frieze of the Choragic monument of Lysicrates (10 in. high) was carved with figures representing the story of Dionysus and the pirates. The most remarkable frieze ever sculptured was that on the outside of the wall of the cella of the Parthenon representing the procession of the celebrants of the Panathenæic Festival. It was 40 in. in height and 525 ft. long, being carried round the whole building under the peristyle. Nearly the whole of the western frieze exists *in situ*; of the remainder, about half is in the British Museum, and as much as remains is either in Athens or in other museums. In some of the Roman temples, as in the temple of Antoninus and Faustina and the temple of the Sun, the frieze is elaborately carved and in later work is made convex, to which the term "pulvinate" is given.

2. (Probably connected with "frizz," to curl; there is no historical reason to connect the word with Friesland), a thick, rough woollen cloth, of very lasting quality, and with a heavy nap, forming small tufts or curls. It is largely manufactured in Ireland.

FRIGATE (Fr. *frégate*, Span. and Port. *fragata*; the etymology of the word is obscure; it has been derived from the Late Lat.

fabricata, and the use of the Fr. *bliment*, for a vessel as well as a building is compared; another suggestion derives the word from the Gr. *ἀφρατος*, unfenced or unguarded, originally a small swift, undecked vessel, propelled by oars or sails, in use on the Mediterranean. The word is thus used of the large open boats, without guns, used for war purposes by the Portuguese in the East Indies during the 16th and 17th centuries. The French first applied the term to a particular type of ships of war during the second quarter of the 18th century. The Seven Years' War (1756-1763) marked the definite adoption of the "frigate" as a standard class of vessel, coming next to ships of the line, and used for cruising and scouting purposes. They were three-masted, fully rigged, fast vessels, with the main armament carried on a single deck, and additional guns on the poop and fore-castle. The number of guns varied from 24 to 50, but between 30 and 40 guns was the usual amount carried. "Frigate" continued to be used as the name for this type of ship, even after the introduction of steam and of ironclad vessels, but the class is now represented by that known as "cruiser."

FRIGATE-BIRD, the name commonly given by English sailors, on account of the swiftness of its flight, its habit of cruising about near other species and of daringly pursuing them, to a large sea-bird—the *Fregata aquila* of most ornithologists—the *Fregate* of French and the *Rabihorcado* of Spanish mariners. It was placed by Linnaeus in the genus *Pelecanus*, and its assignment to the family *Pelecanidae* had hardly ever been doubted till Professor St George Mivart declared (*Trans. Zool. Soc. x. p. 364*) that, as regards the postcranial part of its axial skeleton, he could not detect sufficiently good characters to unite it with that family in the group named by Professor J. F. Brandt *Steganopodes*. There seems to be no ground for disputing this decision so far as separating the genus *Fregata* from the *Pelecanidae* goes, but systematists will probably pause before they proceed to abolish the *Steganopodes*, and the result will most likely be that the frigate-birds will be considered to form a distinct family (*Fregatidae*) in that group. In one very remarkable way the osteology of *Fregata* differs from that of all other birds known. The furcula coalesces firmly at its symphysis with the carina of the sternum, and also with the coracoids at the upper extremity of each of its rami, the anterior end of each coracoid coalescing also with the proximal end of the scapula. Thus the only articulations in the whole sternal apparatus are where the coracoids meet the sternum, and the consequence is a bony framework which would be perfectly rigid did not the flexibility of the rami of the furcula permit a limited amount of motion. That this mechanism is closely related to the faculty which the bird possesses of soaring for a considerable time in the air with scarcely a perceptible movement of the wings can hardly be doubted.

Two species of *Fregata* are considered to exist, though they differ in little but size and geographical distribution. The larger, *F. aquila*, has a wide range all round the world within the tropics and at times passes their limits. The smaller, *F. minor*, appears to be confined to the eastern seas, from Madagascar to the Moluccas, and southward to Australia, being particularly abundant in Torres Strait,—the other species, however, being found there as well. Having a spread of wing equal to a swan's and a very small body, the buoyancy of these birds is very great. It is a beautiful sight to watch one or more of them floating overhead against the deep blue sky, the long forked tail alternately opening and shutting like a pair of scissors, and the head, which is of course kept to windward, inclined from side to side, while the wings are to all appearance fixedly extended, though the breeze may be constantly varying in strength and direction. Equally fine is the contrast afforded by these birds when engaged in fishing, or, as seems more often to happen, in robbing other birds, especially boobies, as they are fishing. Then the speed of their flight is indeed seen to advantage, as well as the marvel-

lous suddenness with which they can change their rapid course as their victim tries to escape from their attack. Before gales frigate-birds are said often to fly low, and their appearance near or over land, except at their breeding-time, is supposed to portend a hurricane.² Generally seen singly or in pairs, except when the prospect of prey induces them to congregate, they breed in large companies, and O. Salvin has graphically described (*Ibis*, 1864, p. 375) one of their settlements off the coast of British Honduras, which he visited in May 1862. Here they chose the highest mangrove-trees³ on which to build their frail nests, and seemed to prefer the leeward side. The single egg laid in each nest has a white and chalky shell very like that of a cormorant's. The nestlings are clothed in pure white down, and so thickly as to resemble puff-balls. When fledged, the beak, head, neck and belly are white, the legs and feet bluish-white, but the body is dark above. The adult females retain the white beneath, but the adult males lose it, and in both sexes at maturity the upper plumage is of a very dark chocolate brown, nearly black, with a bright metallic gloss, while the feet in the females are pink, and black in the males—the last also acquiring a bright scarlet pouch, capable of inflation, and being perceptible when on the wing. The habits of *F. minor* seem wholly to resemble those of *F. aquila*. According to J. M. Bechstein, an example of this last species was obtained at the mouth of the Weser in January 1799. (A. N.)

FRIGG, the wife of the god Odin (Woden) in northern mythology. She was known also to other Teutonic peoples both on the continent (O. H. Ger. *Frija*, Langobardic *Frea*) and in England, where her name still survives in Friday (O. E. *Frigedæg*). She is often wrongly identified with Freyia. (See **TEUTONIC PEOPLES**, *ad fin.*)

FRIGIDARIUM, the Latin term (from *frigidus*, cold) applied to the open area of the Roman thermae, in which there was generally a cold swimming bath, and sometimes to the bath (see **BATHS**). From the description given by Aelius Spartianus (A. D. 297) it would seem that portions of the frigidarium were covered over by a ceiling formed of interlaced bars of gilt bronze, and this statement has been to a certain extent substantiated by the discovery of many tons of T-shaped iron found in the excavations under the paving of the frigidarium of the thermae of Caracalla. Dr J. H. Middleton in *The Remains of Ancient Rome* (1892) points out that in the part of the enclosure walls are deep sinkings to receive the ends of the great girders. He suggests that the panels of the lattice-work ceiling were filled in with concrete made of light pumice stone.

FRIIS, JOHAN (1494-1570), Danish statesman, was born in 1494, and was educated at Odense and at Copenhagen, completing his studies abroad. Few among the ancient Danish nobility occupy so prominent a place in Danish history as Johan Friis, who exercised a decisive influence in the government of the realm during the reign of three kings. He was one of the first of the magnates to adhere to the Reformation and its promoter King Frederick I. (1523-1533), his apostasy being so richly rewarded out of the spoils of the plundered Church that his heirs had to restore property of the value of 1,000,000 kroner. Friis succeeded Claus Gjødsen as imperial chancellor in 1532, and held that dignity till his death. During the ensuing interregnum he powerfully contributed, at the head of the nobles of Funen and Jutland, to the election of Christian III. (1533-1559), but in the course of the "Count's War" he was taken prisoner by Count Christopher, the Catholic candidate for the throne, and forced to do him homage. Subsequently by judicious bribery he contrived to escape to Germany, and from thence rejoined Christian III. He was one of the plenipotentiaries who concluded peace with Lübeck at the congress of Hamburg, and subsequently took an active part in the great work of national reconstruction necessitated by the Reformation, acting as mediator between the Danish and the German parties who were contesting for

¹ "Man-of-war-bird" is also sometimes applied to it, and is perhaps the older name; but it is less distinctive, some of the larger Albatrosses being so called, and, in books at least, has generally passed out of use.

² Hence another of the names—"hurricane-bird"—by which this species is occasionally known.

³ Captain Taylor, however, found their nests as well on low bushes of the same tree in the Bay of Fonseca (*Ibis*, 1856, pp. 150-152).

supremacy during the earlier years of Christian III. This he was able to do, as a moderate Lutheran, whose calmness and common sense contrasted advantageously with the unbridled violence of his contemporaries. As the first chancellor of the reconstructed university of Copenhagen, Friis took the keenest interest in spiritual and scientific matters, and was the first donor of a legacy to the institution. He also enjoyed the society of learned men, especially of "those who could talk with him concerning ancient monuments and their history." He encouraged Hans Svaning to complete Saxo's history of Denmark, and Anders Vedel to translate Saxo into Danish. His generosity to poor students was well known; but he could afford to be liberal, as his share of spoliated Church property had made him one of the wealthiest men in Denmark. Under King Frederick II. (1559-1588), who understood but little of state affairs, Friis was well-nigh omnipotent. He was largely responsible for the Scandinavian Seven Years' War (1562-70), which did so much to exacerbate the relations between Denmark and Sweden. Friis died on the 5th of December 1570, a few days before the peace of Stettin, which put an end to the exhausting and unnecessary struggle.

FRIMLEY, an urban district in the Chertsey parliamentary division of Surrey, England, 33 m. W.S.W. from London by the London & South-Western railway, and 1 m. N. of Farnborough in Hampshire. Pop. (1901) 8409. Its healthy climate, its position in the sandy heath-district of the west of Surrey, and its proximity to Aldershot Camp have contributed to its growth as a residential township. To the east the moorland rises in the picturesque elevation of Chobham Ridges; and 3 m. N.E. is Bagshot, another village growing into a residential town, on the head of the same name extending into Berkshire. Bisleigh Camp, to which in 1890 the meetings of the National Rifle Association were removed from Wimbledon, is 4 m. E. Coniferous trees and rhododendrons are characteristic products of the soil, and large nurseries are devoted to their cultivation.

FRIMONT, JOHANN MARIA PHILIPP, COUNT OF PALOTA, PRINCE OF ANTRODCCO (1759-1831), Austrian general, entered the Austrian cavalry as a trooper in 1776, won his commission in the War of the Bavarian Succession, and took part in the Turkish wars and in the early campaigns against the French Revolutionary armies, in which he frequently earned distinction. At Frankenthal in 1796 he won the cross of Maria Theresa. In the campaign of 1800 he distinguished himself greatly as a cavalry leader at Marengo (14th of June), and in the next year became major-general. In the war of 1805 he was again employed in Italy and won further renown by his gallantry at the battle of Caldiero. In 1809 he again saw active service in Italy in the rank of lieutenant field marshal, and in 1812 led the cavalry of Schwarzenberg's corps in the Russian campaign. He served in the campaigns of 1813-14 in high command, and rendered conspicuous service at Brienne-La Rothière and at Arcis-sur-Aube. In 1815 he was commander-in-chief of the Austrians in Italy, and his army penetrated France as far as Lyons, which was entered on the 11th of July. With the army of occupation he remained in France for some years, and in 1819 he commanded at Venice. In 1821 he led the Austrian army which was employed against the Neapolitan rebels, and by the 24th of March he had victoriously entered Naples. His reward from King Ferdinand of Naples was the title of prince of Antrodocco and a handsome sum of money, and from his own master the rank of general of cavalry. After this he commanded in North Italy, and was called upon to deal with many outbreaks of the Italian patriots. He became president of the Aulic council in 1831, but died a few months later.

FRISCHES HAFF, a lagoon on the Baltic coast of Germany, within the provinces East and West Prussia, between Danzig and Königsberg. It is 52 m. in length, from 4 to 12 m. broad, 332 sq. m. in area, and is separated from the Baltic by a narrow spit or bank of land. This barrier was torn open by a storm in 1510, and the channel thus formed, now dredged out to a depth of 22 ft., affords a navigable passage for vessels. Into the Haff flow the Nogat, the Elbing, the Passarge, the Pregel and the

Frising, from the last of which the name Frisches Haff probably arose.

FRISCHLIN, PHILIPP NIKODEMUS (1547-1590), German philologist and poet, was born on the 22nd of September 1547 at Balingen in Württemberg, where his father was parish minister. He was educated at the university of Tübingen, where in 1568 he was promoted to the chair of poetry and history. In 1575 for his comedy of *Rebecca*, which he read at Regensburg before the emperor Maximilian II., he was rewarded with the laureateship, and in 1577 he was made a count palatine (*comes palatinus*) or *Pfalzgraf*. In 1582 his unguarded language and reckless life made it necessary that he should leave Tübingen, and he accepted a mastership at Laibach in Carniola, which he held for about two years. Shortly after his return to the university in 1584, he was threatened with a criminal prosecution on a charge of immoral conduct, and the threat led to his withdrawal to Frankfort-on-Main in 1587. For eighteen months he taught in the Brunswick gymnasium, and he appears also to have resided occasionally at Strassburg, Marburg and Mainz. From the last-named city he wrote certain libellous letters, which led to his being arrested in March 1590. He was imprisoned in the fortress of Hohenurach, near Reutlingen, where, on the night of the 20th of November 1590, he was killed by a fall in attempting to let himself down from the window of his cell.

Frischlin's prolific and versatile genius produced a great variety of works, which entitle him to some rank both among poets and among scholars. In his Latin verse he often successfully imitated the classical models; his comedies are not without freshness and vivacity; and some of his versions and commentaries, particularly those on the *Georgics* and *Bucolics* of Virgil, though now well-nigh forgotten, were important contributions to the scholarship of his time. There is no collected edition of his works, but his *Opera poetica* were published twelve times between 1535 and 1636. Among those most widely known may be mentioned the *Ilebrais* (1590), a Latin epic based on the Scripture history of the Jews; the *Elegaca* (1601), his collected lyric poetry, in twenty-two books; the *Opera scenica* (1604) consisting of six comedies and two tragedies (among the former, *Julius Caesar redituus*, completed 1584); the *Grammatica Latina* (1585); the versions of Callimachus and Aristophanes; and the commentaries on Persius and Virgil. See the monograph of D. F. Strauss (*Leben und Schriften des Dichters und Philologen Frischlin*, 1856).

FRISI, PAOLO (1728-1784), Italian mathematician and astronomer, was born at Milan on the 13th of April 1728. He was educated at the Barnabite monastery and afterwards at Padua. When twenty-one years of age he composed a treatise on the figure of the earth, and the reputation which he soon acquired led to his appointment by the king of Sardinia to the professorship of philosophy in the college of Casale. His friendship with Radicati, a man of liberal opinions, occasioned Frisi's removal by his clerical superiors to Novara, where he was compelled to do duty as a preacher. In 1753 he was elected a corresponding member of the Paris Academy of Sciences, and shortly afterwards he became professor of philosophy in the Barnabite College of St Alexander at Milan. An acrimonious attack by a young Jesuit, about this time, upon his dissertation on the figure of the earth laid the foundation of his animosity against the Jesuits, with whose enemies, including J. d'Alembert, J. A. N. Condorcet and other Encyclopedists, he later closely associated himself. In 1756 he was appointed by Leopold, grand-duke of Tuscany, to the professorship of mathematics in the university of Pisa, a post which he held for eight years. In 1757 he became an associate of the Imperial Academy of St Petersburg, and a foreign member of the Royal Society of London, and in 1758 a member of the Academy of Berlin, in 1766 of that of Stockholm, and in 1770 of the Academies of Copenhagen and of Bern. From several European crowned heads he received, at various times, marks of special distinction, and the empress Maria Theresa granted him a yearly pension of 100 sequins (£50). In 1764 he was created professor of mathematics in the palatine schools at Milan, and obtained from Pope Pius VI. release from ecclesiastical jurisdiction, and authority to become a secular priest. In 1766 he visited France and England, and in 1768 Vienna. In 1777 he became director of a school of architecture at Milan. His knowledge of hydraulics

caused him to be frequently consulted with respect to the management of canals and other watercourses in various parts of Europe. It was through his means that lightning-conductors were first introduced into Italy for the protection of buildings. He died on the 22nd of November 1784.

His publications include:—*Disquisitio mathematica in causam physicam figuræ et magnitudinis terræ* (Milan, 1751); *Saggio della morale filosofia* (Lugano, 1753); *Novæ electricitatis theoria* (Milan, 1755); *Dissertatio de motu diurno terræ* (Pisa, 1758); *Dissertationes varias* (2 vols. 4to, Lucca, 1759, 1761); *Del modo di regolare i fiumi e i torrenti* (Lucca, 1762); *Cosmographia physica et mathematica* (Milan, 1774, 1775, 2 vols. 4to, his chief work); *Dell' architettura, statica e idraulica* (Milan, 1777); and other treatises.

See Verri, *Memorie . . . del signor don Paolo Frisi* (Milan, 1787), 4to; Fabbroni, "Elogj d' illustri Italiani," *Atti di Milano*, vol. ii.; J. C. Foggendorf, *Biograph. literar. Handwörterbuch*, vol. i.

FRISIAN ISLANDS, a chain of islands, lying from 3 to 20 m. from the mainland, and stretching from the Zuider Zee E. and N. as far as Juland, along the coasts of Holland and Germany. They are divided into three groups:—(1) The West Frisian, (2) the East Frisian, and (3) the North Frisian.

The chain of the Frisian Islands marks the outer fringe of the former continental coast-line, and is separated from the mainland by shallows, known as Wadden or Watten, answering to the *maria vadosa* of the Romans. Notwithstanding the protection afforded by sand-dunes and earthen embankments backed by stones and timber, the Frisian Islands are slowly but surely crumbling away under the persistent attacks of storm and flood, and the old Frisian proverb "de nich will diken met wiken" ("who will not build dikes must go away") still holds good. Many of the Frisian legends and folk-songs deal with the submerged villages and hamlets, which lie buried beneath the treacherous waters of the Wadden. Heinrich Heine made use of these legends in his *Nordseebilder*, composed during a visit to Norderney in 1825. The Prussian and Dutch governments annually expend large sums for the protection of the islands, and in some cases the erosion on the seaward side is counterbalanced by the accretion of land on the inner side, fine sandy beaches being formed well suited for sea-bathing, which attracts many visitors in summer. The inhabitants of these islands support themselves by seafaring, pilotage, grazing of cattle and sheep, fishing and a little agriculture, chiefly potato-growing.

The islands, though well lighted, are dangerous to navigation, and a glance at a wreck chart will show the entire chain to be densely dotted. One of the most remarkable disasters was the loss of H.M.S. "La Lutine," 32 guns, which was wrecked off Vlieland in October 1799, only one hand being saved, who died before reaching England. "La Lutine," which had been captured from the French by Admiral Duncan, was carrying a large quantity of bullion and specie, which was underwritten at Lloyd's. The Dutch government claimed the wreck and granted one-third of the salvage to bullion-fishers. Occasional recoveries were made of small quantities which led to repeated disputes and discussions, until eventually the king of the Netherlands ceded to Great Britain, for Lloyd's, half the remainder of the wreck. A Dutch salvage company, which began operations in August 1857, recovered £99,803 in the course of two years, but it was estimated that some £1,175,000 are still unaccounted for. The ship's rudder, which was recovered in 1859, has been fashioned into a chair and a table, now in the possession of Lloyd's.

The West Frisian Islands belong to the kingdom of the Netherlands, and embrace Texel or Tessel (71 sq. m.), Vlieland (19 sq. m.), Terschelling (41 sq. m.), Ameland (23 sq. m.), Schiermonnikoog (19 sq. m.), as well as the much smaller islands of Boschplaat and Rottum, which are practically uninhabited. The northern end of Texel is called Eierland, or "island of eggs," in reference to the large number of sea-birds' eggs which are found there. It was joined to Texel by a sand-dike in 1629–1630, and is now undistinguishable from the main island. Texel was already separated from the mainland in the 8th century, but remained a Frisian province and countyship, which once extended as far as Alkmaar in North Holland, until it came into the possession of the counts of Holland. The island was occupied

by British troops from August to December 1799. The village of Oude Schild has a harbour. The island of Terschelling once formed a separate lordship, but was sold to the states of Holland. The principal village of West-Terschelling has a harbour. As early as the beginning of the 9th century Ameland was a lordship of the influential family of Cammingha who held immediately of the emperor, and in recognition of their independence the Amelanders were in 1369 declared to be neutral in the fighting between Holland and Friesland, while Cromwell made the same declaration in 1654 with respect to the war between England and the United Netherlands. The castle of the Camminghas in the village of Ballum remained standing till 1810, and finally disappeared in 1829 after four centuries. This island is joined to the mainland of Friesland by a stone dike constructed in 1873 for the purpose of promoting the deposit of mud. The island of Schiermonnikoog has a village and a lighthouse. Rottum was once the property of the ancient abbey at Rottum, 8 m. N. of Groningen, of which there are slight remains.

With the exception of Wangeroog, which belongs to the grand duchy of Oldenburg, the East Frisian Islands belong to Prussia. They comprise Borkum (12½ sq. m.), with two lighthouses and connected by steamer with Emden and Leer; Memmert; Juist (2½ sq. m.), with two lifeboat stations, and connected by steamer with Norddeich and Greet-siel; Norderney (5½ sq. m.); Balrum, with a lifeboat station; Langeoog (8 sq. m.), connected by steamer with the adjacent islands, and with Bensersiel on the mainland; Spiekeroog (4 sq. m.), with a tramway for conveyance to the bathing beach, and connected by steamer with Carolinenzil; and Wangeroog (2 sq. m.), with a lighthouse and lifeboat station. All these islands are visited for sea-bathing. In the beginning of the 18th century Wangeroog comprised eight times its present area. Borkum and Juist are two surviving fragments of the original island of Borkum (computed at 380 sq. m.), known to Drusus as *Fabaria*, and to Pliny as *Burchona*, which was rent asunder by the sea in 1170. Newwerk and Scharhörn, situated off the mouth of the Elbe, are islands belonging to the state of Hamburg. Newwerk, containing some marshland protected by dikes, has two lighthouses and a lifeboat station. At low water it can be reached from Duhnen by carriage.

About the year 1250 the area of the North Frisian Islands was estimated at 1065 sq. m.; by 1850 this had diminished to only 105 sq. m. This group embraces the islands of Nordstrand (17½ sq. m.), which up to 1634 formed one larger island with the adjoining Pohnshallig and Nordstrandisch-Moor; Pellworm (16½ sq. m.), protected by a circle of dikes and connected by steamer with Husum on the mainland; Amrum (10½ sq. m.); Föhr (32 sq. m.); Sylt (38 sq. m.); Röm (16 sq. m.), with several villages, the principal of which is Kirkeby; Fanö (21 sq. m.); and Heligoland (½ sq. m.). With the exception of Fanö, which is Danish, all these islands belong to Prussia. In the North Frisian group there are also several smaller islands called Halligen. These rise generally only a few feet above the level of the sea, and are crowned by a single house standing on an artificial mound and protected by a surrounding dike or embankment.

BIBLIOGRAPHY.—Staring, *De Bodem van Nederland* (1856); Blink, *Nederland en zijne Bewoners* (1892); P. H. Witkamp, *Aardrijkskundig Woordenboek van Nederland* (1895); P. W. J. Teding van Berkhout, *De Landaanwinning op de Friesche Wadden* (1869); J. de Vries and T. Focken, *Ostfriesland* (1881); Dr D. F. Buitenrust Hetteema, *Fryske Bybletek* (Utrecht, 1895); Dr Eugen Traeger, *Die Halligen der Nordsee* (Stuttgart, 1892); also *Globus*, vol. lxxviii. (1900). No. 15; P. Axelsen, in *Deut. Rundschau für Geog. u. Statistik* (1898); Christian Jensen, *Vom Dänenstrand der Nordsee und vom Wattenmeer* (Schleswig, 1901), which contains a bibliography; Osterloh, *Wangeroog und sein Seebad* (Emden, 1884); Zwicker, *Führer durch das Nordseebad Wangeroog* (Oldenburg, 1894); Nellner, *Die Nordseeinsel Spiekeroog* (Emden, 1884); Tongers, *Die Nordseeinsel Langeoog* (2nd ed., Norden, 1892); Meier, *Die Nordseeinsel Borkum* (10th ed., Emden, 1894); Herquet, *Die Insel Borkum*, &c. (Emden, 1886); Scherz, *Die Nordseeinsel Juist* (2nd ed., Norden, 1893); von Bertouch, *Vor 40 Jahren: Natur und Kultur auf der Insel Nordstrand* (Weimar, 1891); W. G. Black, *Heligoland and the Islands of the North Sea* (Glasgow, 1888).

FRISIANS (Lat. *Frisii*; in Med. Lat. *Frisones, Frisiones, Fressones*; in their own tongue *Frîsa, Frîsen*), a people of Teutonic (Low-German) stock, who in the first century of our era were found by the Romans in occupation of the coast lands stretching from the mouth of the Scheldt to that of the Ems. They were nearly related both by speech and blood to the Saxons and Angles, and other Low German tribes, who lived to the east of the Ems and in Holstein and Schleswig. The first historical notices of the Frisians are found in the *Annals* of Tacitus. They were rendered (or a portion of them) tributary by Drusus, and became *socii* of the Roman people. In A.D. 28 the exactions of a Roman official drove them to revolt, and their subjection was henceforth nominal. They submitted again to Cn. Domitius Corbulo in the year 47, but shortly afterwards the emperor Claudius ordered the withdrawal of all Roman troops to the left bank of the Rhine. In 58 they attempted unsuccessfully to appropriate certain districts between the Rhine and the Yssel, and in 70 they took part in the campaign of Claudius Civilis. From this time onwards their name practically disappears. As regards their geographical position Ptolemy states that they inhabited the coast above the Bructeri as far as the Ems, while Tacitus speaks of them as adjacent to the Rhine. But there is some reason for believing that the part of Holland which lies to the west of the Zuider Zee was at first inhabited by a different people, the Canninefates, a sister tribe to the Batavi. A trace of this people is perhaps preserved in the name Kennemerland or Kinnehem, formerly applied to the same district. Possibly, therefore, Tacitus's statement holds good only for the period subsequent to the revolt of Civilis, when we hear of the Canninefates for the last time.

In connexion with the movements of the migration period the Frisians are hardly ever mentioned, though some of them are said to have surrendered to the Roman prince Constantius about the year 293. On the other hand we hear very frequently of Saxons in the coast regions of the Netherlands. Since the Saxons (Old Saxons) of later times were an inland people, one can hardly help suspecting either that the two nations have been confused or, what is more probable, that a considerable mixture of population, whether by conquest or otherwise, had taken place. Procopius (*Goth.* iv. 20) speaks of the Frisians as one of the nations which inhabited Britain in his day, but we have no evidence from other sources to bear out his statement. In Anglo-Saxon poetry mention is frequently made of a Frisian king named Finn, the son of Folcwalda, who came into conflict with a certain Hnaef, a vassal of the Danish king Healfdene, about the middle of the 5th century. Hnaef was killed, but his followers subsequently slew Finn in revenge. The incident is obscure in many respects, but it is perhaps worth noting that Hnaef's chief follower, Hengest, may quite possibly be identical with the founder of the Kentish dynasty. About the year 520 the Frisians are said to have joined the Frankish prince Theodbert in destroying a piratical expedition which had sailed up the Rhine under Chocilaicus (Hygelac), king of the Götter. Towards the close of the century they begin to figure much more prominently in Frankish writings. There is no doubt that by this time their territories had been greatly extended in both directions. Probably some Frisians took part with the Angles and Saxons in their sea-roving expeditions, and assisted their neighbours in their invasions and subsequent conquest of England and the Scottish lowlands.

The rise of the power of the Franks and the advance of their dominion northwards brought on a collision with the Frisians, who in the 7th century were still in possession of the whole of the sea-coast, and apparently ruled over the greater part of modern Flanders. Under the protection of the Frankish king Dagobert (622-638), the Christian missionaries Amandus (St Amand) and Eligius (St Eloi) attempted the conversion of these Flemish Frisians, and their efforts were attended with a certain measure of success; but farther north the building of a church by Dagobert at Trajectum (Utrecht) at once aroused the fierce hostility of the heathen tribesmen of the Zuider Zee. The "free" Frisians could not endure this Frankish outpost on their borders. Utrecht

was attacked and captured, and the church destroyed. The first missionary to meet with any success among the Frisians was the Englishman Wilfrid of York, who, being driven by a storm upon the coast, was hospitably received by the king, Adgild or Adgisl, and was allowed to preach Christianity in the land. Adgild appears to have admitted the overlordship of the Frankish king, Dagobert II. (675). Under his successor, however, Radbod (Frisian *Rêdbâd*), an attempt was made to extirpate Christianity and to free the Frisians from the Frankish subjection. He was, however, beaten by Pippin of Heristal in the battle of Dorstadt (689), and was compelled to cede West Frisia (*Frisia citerior*) from the Scheldt to the Zuider Zee to the conqueror. On Pippin's death Radbod again attacked the Franks and advanced as far as Cologne, where he defeated Charles Martel, Pippin's natural son. Eventually, however, Charles prevailed and compelled the Frisians to submit. Radbod died in 719, but for some years his successors struggled against the Frankish power. A final defeat was, however, inflicted upon them by Charles Martel in 734, which secured the supremacy of the Franks in the north, though it was not until the days of Charles the Great (768) that the subjection of the Frisians was completed. Meanwhile Christianity had been making its conquests in the land, mainly through the lifelong labours and preaching of the Englishman Willibrord, who came to Frisia in 692 and made Utrecht his headquarters. He was consecrated (695) at Rome archbishop of the Frisians, and on his return founded a number of bishoprics in the northern Netherlands, and continued his labours unremittingly until his death in 739. It is an interesting fact that both Wilfrid and Willibrord appear to have found no difficulty from the first in preaching to the Frisians in their native dialect, which was so nearly allied to their own Anglo-Saxon tongue. The see of Utrecht founded by Willibrord has remained the chief see of the Northern Netherlands from his day to our own. Frisia was likewise the scene of a portion of the missionary labours of a greater than Willibrord, the famous Boniface, the Apostle of the Germans, also an Englishman. It was at Dokkum in Frisia that he met a martyr's death (754).

Charles the Great granted the Frisians important privileges under a code known as the *Lex Frisionum*, based upon the ancient laws of the country. They received the title of freemen and were allowed to choose their own *podestat* or imperial governor. In the *Lex Frisionum* three districts are clearly distinguished: West Frisia from the Zwin to the Flie; Middle Frisia from the Flie to the Lauwers; East Frisia from the Lauwers to the Weser. At the partition treaty of Verdun (843) Frisia became part of Lotharinga or Lorraine; at the treaty of Mersen (870) it was divided between the kingdoms of the East Franks (Austrasia) and the West Franks (Westrasia); in 880 the whole country was united to Austrasia; in 911 it fell under the dominion of Charles the Simple, king of the West Franks, but the districts of East Frisia asserted their independence and for a long time governed themselves after a very simple democratic fashion. The history of West Frisia gradually loses itself in that of the countship of Holland and the see of Utrecht (see HOLLAND and UTRECHT).

The influence of the Frisians during the interval between the invasion of Britain and the loss of their independence must have been greater than is generally recognized. They were a seafaring people and engaged largely in trade, especially perhaps the slave trade, their chief emporium being Wyk te Duerstede. During the period in question there is considerable archaeological evidence for intercourse between the west coast of Norway and the regions south of the North Sea, and it is worth noting that this seems to have come to an end early in the 9th century. Probably it is no mere accident that the first appearance, or rather reappearance, of Scandinavian pirates in the west took place shortly after the overthrow of the Frisians. Since Radbod's dominions extended from Duerstede to Heligoland his power must have been by no means inconsiderable.

Besides the Frisians discussed above there is a people called North Frisians, who inhabit the west coast of Schleswig. At present a Frisian dialect is spoken only between Tondern and

Husum, but formerly it extended farther both to the north and south. In historical times these North Frisians were subjects of the Danish kingdom and not connected in any way with the Frisians of the empire. They are first mentioned by Saxo Grammaticus in connexion with the exile of Knud V. Saxo recognized that they were of Frisian origin, but did not know when they had first settled in this region. Various opinions are still held with regard to the question; but it seems not unlikely that the original settlers were Frisians who had been expelled by the Franks in the 8th century. Whether the North Frisian language is entirely of Frisian origin is somewhat doubtful owing to the close relationship which Frisian bears to English. The inhabitants of the neighbouring islands, Sylt, Amrum and Föhr, who speak a kindred dialect, have apparently never regarded themselves as Frisians, and it is the view of many scholars that they are the direct descendants of the ancient Saxons.

In 1248 William of Holland, having become emperor, restored to the Frisians in his countship their ancient liberties in reward for the assistance they had rendered him in the siege of Aachen; but in 1254 they revolted, and William lost his life in the contest which ensued. After many struggles West Friesland became completely subdued, and was henceforth virtually absorbed in the county of Holland. But the Friesland east of the Zuider Zee obstinately resisted repeated attempts to bring them into subjection. In the course of the 14th century the country was in a state of anarchy; petty lordships sprang into existence, the interests of the common weal were forgotten or disregarded, and the people began to be split up into factions, and these were continually carrying on petty warfare with one another. Thus the Fetkoopers (Fatmongers) of Oostergoo had endless feuds with the Schieringers (Elfishers) of Westergoo.

This state of affairs favoured the attempts of the counts of Holland to push their conquests eastward, but the main body of the Frisians was still independent when the countship of Holland passed into the hands of Philip the Good of Burgundy. Philip laid claim to the whole country, but the people appealed to the protection of the empire, and Frederick III., in August 1457, recognized their direct dependence on the empire and called on Philip to bring forward formal proof of his rights. Philip's successor, Charles the Bold, summoned an assembly of notables at Enkhuizen in 1469, in order to secure their homage; but the conference was without result, and the duke's attention was soon absorbed by other and more important affairs. The marriage of Maximilian of Austria with the heiress of Burgundy was to be productive of a change in the fortunes of that part of Frisia which lies between the Vlie and the Lauwers. In 1498 Maximilian reversed the policy of his father Frederick III., and detached this territory, known afterwards as the province of Friesland, from the empire. He gave it as a fief to Albert of Saxony, who thoroughly crushed out all resistance. In 1523 it fell with all the rest of the provinces of the Netherlands under the strong rule of the emperor Charles, the grandson of Maximilian and Mary of Burgundy.

That part of Frisia which lies to the east of the Lauwers had a divided history. The portion which lies between the Lauwers and the Ems after some struggles for independence had, like the rest of the country, to submit itself to Charles. It became ultimately the province of the town and district of Groningen (Stadt en Landen) (see GRONINGEN). The easternmost part between the Ems and the Weser, which had since 1454 been a county, was ruled by the descendants of Edzard Cirksena, and was attached to the empire. The last of the Cirksenas, Count Charles Edward, died in 1744 and in default of heirs male the king of Prussia took possession of the county.

The province of Friesland was one of the seven provinces which by the treaty known as the Union of Utrecht bound themselves together to resist the tyranny of Spain. From 1579 to 1795 Friesland remained one of the constituent parts of the republic of the United Provinces, but it always jealously insisted on its sovereign rights, especially against the encroachments of the predominant province of Holland. It maintained throughout the whole of the republican period a certain distinctiveness of

nationality, which was marked by the preservation of a different dialect and of a separate stadtholder. Count William Lewis of Nassau-Siegen, nephew and son-in-law of William the Silent, was chosen stadtholder, and through all the vicissitudes of the 17th and 18th centuries the stadtholdership was held by one of his descendants. Frederick Henry of Orange was stadtholder of six provinces, but not of Friesland, and even during the stadtholderless periods which followed the deaths of William II. and William III. of Orange the Frisians remained staunch to the family of Nassau-Siegen. Finally, by the revolution of 1748, William of Nassau-Siegen, stadtholder of Friesland (who, by default of heirs male of the elder line, had become William IV., prince of Orange), was made hereditary stadtholder of all the provinces. His grandson in 1815 took the title of William I., king of the Netherlands. The male line of the "Frisian" Nassaus came to an end with the death of King William III. in 1890.

BIBLIOGRAPHY—See Tacitus, *Ann.* iv. 72 f., xi. 19 f., xiii. 54; *Hist.* iv. 15 f.; *Germ.* 34; Ptolemy, *Geogr.* ii. 11, § 11; Dio Cassius liv. 32; Eumenius, *Paneg.* iv. 9; the Anglo-Saxon poems, Finn, Beowulf and Widsith; *Fredegaris Chronicon continuatio* and various German Annals; *Gesta regum Francorum*; Eddius, *Vita Wilfridi*, cap. 25 f.; Bede, *Hist. Eccles.* iv. 22, v. 9 f.; Alcuin, *Vita Wilfridi*; I. Undset, *Aarbejg for nordisk Oldkyndighed* (1880), p. 89 ff. (cf. E. Mogk in Paul's *Grundriss d. germ. Philologie* ii. p. 623 ff.); Ubbo Emmius, *Rerum Frisicarum historia* (Leiden, 1616); Pirius Winsemius, *Chronique van Friesland* (Franeker, 1822); C. Scotanus, *Beschryvinge end Chronyck van des Heerlicheydt van Friesland* (1655); *Groot Placaat en Charter-boek van Friesland* (ed. Baron C. F. zu Schwarzenberg) (5 vols., Leeuwarden, 1768-1793); T. D. Wiarda, *Ost-friesische Gesch.* (vols. i.-ix., Aurich, 1791) (vol. x., Bremen, 1817); J. Dirks, *Geschiedkundig onderzoek van den Koophandel der Friesen* (Utrecht, 1846); O. Klopp, *Gesch. Ostfrieslands* (3 vols., Hanover, 1854-1888); Hooft van Iddeking, *Friesland en de Friesen in de Middeleeuwen* (Leiden, 1881); A. Telting, *Het Oost-friesche Stadrecht* (The Hague, 1882); P. J. Blok, *Friesland in Middelalder* (Leer, 1891).

FRITH (or **FRYTH**), **JOHN** (c. 1503-1533), English Reformer and Protestant martyr, was born at Westerham, Kent. He was educated at Eton and King's College, Cambridge, where Gardiner, afterwards bishop of Winchester, was his tutor. At the invitation of Cardinal Wolsey, after taking his degree he migrated (December 1525) to the newly founded college of St Frideswide or Cardinal College (now Christ Church), Oxford. The sympathetic interest which he showed in the Reformation movement in Germany caused him to be suspected as a heretic, and led to his imprisonment for some months. Subsequently he appears to have resided chiefly at the newly founded Protestant university of Marburg, where he became acquainted with several scholars and reformers of note, especially Patrick Hamilton (q.v.). Frith's first publication was a translation of Hamilton's *Places*, made shortly after the martyrdom of its author; and soon afterwards the *Revelation of Antichrist*, a translation from the German, appeared, along with *A Pistle to the Christen Reader*, by "Richard Brightwell" (supposed to be Frith), and *An Antithesis wherein are compared togeder Christes Actes and our Holye Father the Popes*, dated "at Malborow in the lande of Hesse," 12th July 1529. His *Disputacyon of Purgatorye*, a treatise in three books, against Rastell, Sir T. More and Fisher (bishop of Rochester) respectively, was published at the same place in 1531. While at Marburg, Frith also assisted Tyndale, whose acquaintance he had made at Oxford (or perhaps in London) in his literary labours. In 1532 he ventured back to England, apparently on some business in connexion with the prior of Reading. Warrants for his arrest were almost immediately issued at the instance of Sir T. More, then lord chancellor. Frith ultimately fell into the hands of the authorities at Milton Shore in Essex, as he was on the point of making his escape to Flanders. The rigour of his imprisonment in the Tower was somewhat abated when Sir T. Audley succeeded to the chancellorship, and it was understood that both Cromwell and Cranmer were disposed to show great leniency. But the treacherous circulation of a manuscript "lytle treatise" on the sacraments, which Frith had written for the information of a friend, and without any view to publication, served further to excite the

hostility of his enemies. In consequence of a sermon preached before him against the "sacramentaries," the king ordered that Frith should be examined; he was afterwards tried and found guilty of having denied, with regard to the doctrines of purgatory and of transubstantiation, that they were necessary articles of faith. On the 23rd of June 1533 he was handed over to the secular arm, and at Smithfield on the 4th of July following he was burnt at the stake. During his captivity he wrote, besides several letters of interest, a reply to More's letter against Frith's "lytle treatise"; also two tracts entitled *A Mirror or Glass to know thyself*, and *A Mirror or Looking-glass wherein you may behold the Sacrament of Baptism*.

Frith is an interesting and so far important figure in English ecclesiastical history as having been the first to maintain and defend that doctrine regarding the sacrament of Christ's body and blood, which ultimately came to be incorporated in the English communion office. Twenty-three years after Frith's death as a martyr to the doctrine of that office, that "Christ's natural body and blood are in Heaven, not here," Cranmer, who had been one of his judges, went to the stake for the same belief. Within three years more, it had become the publicly professed faith of the entire English nation.

See A. à Wood, *Athenae Oxonienses* (ed. P. Bliss, 1813), I. p. 74; John Foxe, *Acts and Monuments* (ed. G. Townshend, 1843-1849), v. pp. 1-16 (also Index); G. Burnet, *Hist. of the Reformation of the Church of England* (ed. N. Pocock, 1865), i. p. 273; L. Richmond, *The Fathers of the English Church*, i. (1807): *Life and Martyrdom of John Frith* (London, 1824), published by the Church of England Tract Society; Deborah Alcock, *Six Heroic Men* (1906).

FRITH, WILLIAM POWELL (1819-1909), English painter, was born at Aldfield, in Yorkshire, on the 9th of January 1819. His parents moved in 1826 to Harrogate, where his father became landlord of the Dragon Inn, and it was then that the boy began his general education at a school at Knaresborough. Later he went for about two years to a school at St Margaret's, near Dover, where he was placed specially under the direction of the drawing-master, as a step towards his preparation for the profession which his father had decided on as the one that he wished him to adopt. In 1835 he was entered as a student in the well-known art school kept by Henry Sass in Bloomsbury, from which he passed after two years to the Royal Academy schools. His first independent experience was gained in 1839, when he went about for some months in Lincolnshire executing several commissions for portraits; but he soon began to attempt compositions, and in 1840 his first picture, "Malvolio, cross-gartered before the Countess Olivia," appeared at the Royal Academy. During the next few years he produced several notable paintings, among them "Squire Thornhill relating his town adventures to the Vicar's family," and "The Village Pastor," which established his reputation as one of the most promising of the younger men of that time. This last work was exhibited in 1845, and in the autumn of that year he was elected an Associate of the Royal Academy. His promotion to the rank of Academician followed in 1853, when he was chosen to fill the vacancy caused by Turner's death. The chief pictures painted by him during his tenure of Associateship were: "An English Merry-making in the Olden Time," "Old Woman accused of Witchcraft," "The Coming of Age," "Sancho and Don Quixote," "Hogarth before the Governor of Calais," and the "Scene from Goldsmith's 'Good-natured Man,'" which was commissioned in 1850 by Mr Sheepshanks, and bequeathed by him to the South Kensington Museum. Then came a succession of large compositions which gained for the artist an extraordinary popularity. "Life at the Seaside," better known as "Ramsgate Sands," was exhibited in 1854, and was bought by Queen Victoria; "The Derby Day," in 1858; "Claude Duval," in 1860; "The Railway Station," in 1862; "The Marriage of the Prince of Wales," painted for Queen Victoria, in 1865; "The Last Sunday of Charles II.," in 1867; "The Salon d'Or," in 1871; "The Road to Ruin," a series, in 1878; a similar series, "The Race for Wealth," shown at a gallery in King Street, St James's, in 1880; "The Private View," in 1883; and "John Knox at Holyrood," in

1886. Frith also painted a considerable number of portraits of well-known people. In 1889 he became an honorary retired academician. His "Derby Day" is in the National Gallery of British Art. In his youth, in common with the men by whom he was surrounded, he had leanings towards romance, and he scored many successes as a painter of imaginative subjects. In these he proved himself to be possessed of exceptional qualities as a colourist and manipulator, qualities that promised to earn for him a secure place among the best executants of the British School. But in his middle period he chose a fresh direction. Fascinated by the welcome which the public gave to his first attempts to illustrate the life of his own times, he undertook a considerable series of large canvases, in which he commented on the manners and morals of society as he found it. He became a pictorial preacher, a painter who moralized about the everyday incidents of modern existence; and he sacrificed some of his technical variety. There remained, however, a remarkable sense of characterization, and an acute appreciation of dramatic effect. Frith died on the 2nd of November 1909.

Frith published his *Autobiography and Reminiscences* in 1887, and *Further Reminiscences* in 1889.

FRITILLARY (*Fritillaria*: from Lat. *fritillus*, a chess-board, so called from the chequered markings on the petals), a genus of hardy bulbous plants of the natural order Liliaceae, containing about 50 species widely distributed in the northern hemisphere. The genus is represented in Britain by the fritillary or snake's head, which occurs in moist meadows in the southern half of England, especially in Oxfordshire. A much larger plant is the crown imperial (*F. imperialis*), a native of western Asia and well known in gardens. This grows to a height of about 3 ft., the lower part of the stoutish stem being furnished with leaves, while near the top is developed a crown of large pendant flowers surmounted by a tuft of bright green leaves like those of the lower part of the stem, only smaller. The flowers are bell-shaped, yellow or red, and in some of the forms double. The plant grows freely in good garden soil, preferring a deep well-drained loam, and is all the better for a top-dressing of manure as it approaches the flowering stage. Strong clumps of five or six roots of one kind have a very fine effect. It is a very suitable subject for the back row in mixed flower borders, or for recesses in the front part of shrubbery borders. It flowers in April or early in May. There are a few named varieties, but the most generally grown are the single and double yellow, and the single and double red, the single red having also two variegated varieties, with the leaves striped respectively with white and yellow.

"Fritillary" is also the name of a kind of butterfly.

FRITZLAR, a town of Germany, in the Prussian province of Hesse-Cassel, on the left bank of the Eder, 16 m. S.W. from Cassel, on the railway Wabern-Wildungen. Pop. (1905) 3448. It is a prettily situated old-fashioned place, with an Evangelical and two Roman Catholic churches, one of the latter, that of St Peter, a striking mediæval edifice. As early as 732 Boniface, the apostle of Germany, established the church of St Peter and a small Benedictine monastery at Fridelsar, "the quiet home" or "abode of peace." Before long the school connected with the monastery became famous, and among its earlier scholars it numbered Sturm, abbot of Fulda, and Meginod, second bishop of Würzburg. When Boniface found himself unable to continue the supervision of the society himself, he entrusted the office to Wigbert of Glastonbury, who thus became the first abbot of Fritzlar. In 774 the little settlement was taken and burnt by the Saxons; but it evidently soon recovered from the blow. For a short time after 786 it was the seat of the bishop of Buraburg, which had been founded by Boniface in 741. At the diet of Fritzlar in 919 Henry I. was elected German king. In the beginning of the 13th century the village received municipal rights; in 1232 it was captured and burned by the landgrave Conrad of Thuringia and his allies; in 1631 it was taken by William of Hesse; in 1760 it was successfully defended by General Luckner against the French; and in 1761 it was occupied by the French and unsuccessfully bombarded by the Allies. As a principality Fritzlar continued subject to the archbishopric

of Mainz till 1802, when it was incorporated with Hesse. From 1807 to 1814 it belonged to the kingdom of Westphalia; and in 1866 passed with Hesse Cassel to Prussia.

FRIULI (in the local dialect, *Furlanci*), a district at the head of the Adriatic Sea, at present divided between Italy and Austria, the Italian portion being included in the province of Udine and the district of Portogruaro, and the Austrian comprising the province of Görz and Gradiska, and the so-called Idrian district. In the north and east Friuli includes portions of the Julian and Carnic Alps, while the south is an alluvial plain richly watered by the Isonzo, the Tagliamento, and many lesser streams which, although of small volume during the dry season, come down in enormous floods after rain or thaw. The inhabitants, known as Furlanians, are mainly Italians, but they speak a dialect of their own which contains Celtic elements. The area of the country is about 3300 sq. m.; it contains about 700,000 inhabitants.

Friuli derives its name from the Roman town of *Forum Julii*, or *Forojulium*, the modern Cividale, which is said by Paulus Diaconus to have been founded by Julius Caesar. In the 2nd century B.C. the district was subjugated by the Romans, and became part of Gallia Transpadana. During the Roman period, besides Forum Julii, its principal towns were Concordia, Aquileia and Vedinium. On the conquest of the country by the Lombards during the 6th century it was made one of their thirty-six duchies, the capital being Forum Julii or, as they called it, Civitas Austriae. It is needless to repeat the list of dukes of the Lombard line, from Gisulf (d. 611) to Hrothgaud, who fell a victim to his opposition to Charlemagne about 776; their names and exploits may be read in the *Historia Langobardorum* of Paulus Diaconus, and they were mainly occupied in struggles with the Avars and other barbarian peoples, and in resisting the pretensions of the Lombard kings. The discovery, however, of Gisulf's grave at Cividale, in 1874, is an interesting proof of the historian's authenticity. Charlemagne filled Hrothgaud's place with one of his own followers, and the frontier position of Friuli gave the new line of counts, dukes or margraves (for they are variously designated) the opportunity of acquiring importance by exploits against the Bulgarians, Slovenians and other hostile peoples to the east. After the death of Charlemagne Friuli shared in general in the fortunes of northern Italy. In the 11th century the ducal rights over the greater part of Friuli were bestowed by the emperor Henry IV. on the patriarch of Aquileia; but towards the close of the 14th century the nobles called in the assistance of Venice, which, after defeating the archbishop, afforded a new illustration of Aesop's well-known fable, by securing possession of the country for itself. The eastern part of Friuli was held by the counts of Görz till 1500, when on the failure of their line it was appropriated by the German king, Maximilian I., and remained in the possession of the house of Austria until the Napoleonic wars. By the peace of Campo Formio in 1797 the Venetian district also came to Austria, and on the formation of the Napoleonic kingdom of Italy in 1805 the department of Passariano was made to include the whole of Venetian and part of Austrian Friuli, and in 1809 the rest was added to the Illyrian provinces. The title of duke of Friuli was borne by Marshal Duroc. In 1815 the whole country was recovered by the emperor of Austria, who himself assumed the ducal title and coat of arms; and it was not till 1866 that the Venetian portion was again ceded to Italy by the peace of Prague. The capital of the country is Udine, and its arms are a crowned eagle on a field azure.

See Manzano, *Annali del Friuli* (Udine, 1858-1879); and *Compendio di storia friulana* (Udine, 1876); Antonini, *Il Friuli orientale* (Milan, 1865); von Zahn, *Friaulische Studien* (Vienna, 1878); Pirona, *Vocabolario friulano* (Venice, 1869); and L. Fracassetti, *La Statistica etnografica del Friuli* (Udine, 1903). (T. As.)

FROBEN [FROBENIUS], **JOANNES** (c. 1460-1527), German printer and scholar, was born at Hammelburg in Bavaria about the year 1460. After completing his university career at Basel, where he made the acquaintance of the famous printer Johannes Auerbach (1443-1513), he established a printing house in that city about 1491, and this soon attained a European

reputation for accuracy and for taste. In 1500 he married the daughter of the bookseller Wolfgang Lachner, who entered into partnership with him. He was on terms of friendship with Erasmus (*q.v.*), who not only had his own works printed by him, but superintended Frobenius's editions of St Jerome, St Cyprian, Tertullian, Hilary of Poitiers and St Ambrose. His *Novus Testamentum* in Greek (1516) was used by Luther for his translation. Frobenius employed Hans Holbein to illuminate his texts. It was part of his plan to print editions of the Greek Fathers. He did not, however, live to carry out this project, but it was very creditably executed by his son Jerome and his son-in-law Nikolaus Episcopius. Frobenius died in October 1527. His work in Basel made that city in the 16th century the leading centre of the German book trade. An extant letter of Erasmus, written in the year of Frobenius's death, gives an epitome of his life and an estimate of his character; and in it Erasmus mentions that his grief for the death of his friend was far more poignant than that which he had felt for the loss of his own brother, adding that "all the apostles of science ought to wear mourning." The epistle concludes with an epitaph in Greek and Latin.

FROBISHER, SIR MARTIN (c. 1535-1594), English navigator and explorer, fourth child of Bernard Frobisher of Altofts in the parish of Normanton, Yorkshire, was born some time between 1530 and 1540. The family came originally from North Wales. At an early age he was sent to a school in London and placed under the care of a kinsman, Sir John York, who in 1544 placed him on board a ship belonging to a small fleet of merchantmen sailing to Guinea. By 1565 he is referred to as Captain Martin Frobisher, and in 1571-1572 as being in the public service at sea off the coast of Ireland. He married in 1559. As early as 1560 or 1561 Frobisher had formed a resolution to undertake a voyage in search of a North-West Passage to Cathay and India. The discovery of such a route was the motive of most of the Arctic voyages undertaken at that period and for long after, but Frobisher's special merit was in being the first to give to this enterprise a national character. For fifteen years he solicited in vain the necessary means to carry his project into execution, but in 1576, mainly by help of the earl of Warwick, he was put in command of an expedition consisting of two tiny barks, the "Gabriel" and "Michael," of about 20 to 25 tons each, and a pinnacle of 10 tons, with an aggregate crew of 35.

He weighed anchor at Blackwall, and, after having received a good word from Queen Elizabeth at Greenwich, set sail on the 7th of June, by way of the Shetland Islands. Stormy weather was encountered in which the pinnacle was lost, and some time afterwards the "Michael" deserted; but stoutly continuing the voyage alone, on the 28th of July the "Gabriel" sighted the coast of Labrador in lat. 62° 2' N. Some days later the mouth of Frobisher Bay was reached, and a farther advance northwards being prevented by ice and contrary winds, Frobisher determined to sail westward up this passage (which he conceived to be a strait) to see "whether he mighte carrie himself through the same into some open sea on the backe syde." Butcher's Island was reached on the 18th of August, and some natives being met with here, intercourse was carried on with them for some days, the result being that five of Frobisher's men were decoyed and captured, and never more seen. After vainly trying to get back his men, Frobisher turned homewards, and reached London on the 9th of October.

Among the things which had been hastily brought away by the men was some "black earth," and just as it seemed as if nothing more was to come of this expedition, it was noised abroad that the apparently valueless "black earth" was really a lump of gold ore. It is difficult to say how this rumour arose, and whether there was any truth in it, or whether Frobisher was a party to a deception, in order to obtain means to carry out the great idea of his life. The story, at any rate, was so far successful; the greatest enthusiasm was manifested by the court and the commercial and speculating world of the time; and next year a much more important expedition than the former was fitted out, the queen

lending the "Aid" from the royal navy and subscribing £1000 towards the expenses of the expedition. A Company of Cathay was established, with a charter from the crown, giving the company the sole right of sailing in every direction but the east; Frobisher was appointed high admiral of all lands and waters that might be discovered by him. On the 26th of May 1577 the expedition, consisting, besides the "Aid," of the ships "Gabriel" and "Michael," with boats, pinnaces and an aggregate complement of 120 men, including miners, refiners, &c., left Blackwall, and sailing by the north of Scotland reached Hall's Island at the mouth of Frobisher Bay on the 17th of July. A few days later the country and the south side of the bay was solemnly taken possession of in the queen's name. Several weeks were now spent in collecting ore, but very little was done in the way of discovery, Frobisher being specially directed by his commission to "defer the further discovery of the passage until another time." There was much parleying and some skirmishing with the natives, and earnest but futile attempts made to recover the men captured the previous year. The return was begun on the 23rd of August, and the "Aid" reached Milford Haven on the 23rd of September; the "Gabriel" and "Michael," having separated, arrived later at Bristol and Yarmouth.

Frobisher was received and thanked by the queen at Windsor. Great preparations were made and considerable expense incurred for the assaying of the great quantity of "ore" (about 200 tons) brought home. This took up much time, and led to considerable dispute among the various parties interested. Meantime the faith of the queen and others remained strong in the productiveness of the newly discovered territory, which she herself named *Meta Incognita*, and it was resolved to send out a larger expedition than ever, with all necessaries for the establishment of a colony of 200 men. Frobisher was again received by the queen at Greenwich, and her Majesty threw a fine chain of gold around his neck. On the 31st of May 1578 the expedition, consisting in all of fifteen vessels, left Harwich, and sailing by the English Channel on the 20th of June reached the south of Greenland, where Frobisher and some of his men managed to land. On the 2nd of July the foreland of Frobisher Bay was sighted, but stormy weather and dangerous ice prevented the rendezvous from being gained, and, besides causing the wreck of the barque "Dennis" of 100 tons, drove the fleet unwittingly up a new (Hudson) strait. After proceeding about 60 m. up this "mistaken strait," Frobisher with apparent reluctance turned back, and after many buffetings and separations the fleet at last came to anchor in Frobisher Bay. Some attempt was made at founding a settlement, and a large quantity of ore was shipped; but, as might be expected, there was much dissension and not a little discontent among so heterogeneous a company, and on the last day of August the fleet set out on its return to England, which was reached in the beginning of October. Thus ended what was little better than a fiasco, though Frobisher himself cannot be held to blame for the result; the scheme was altogether chimerical, and the "ore" seems to have been not worth smelting.

In 1580 Frobisher was employed as captain of one of the queen's ships in preventing the designs of Spain to assist the Irish insurgents, and in the same year obtained a grant of the reversionary title of clerk of the royal navy. In 1585 he commanded the "Primrose" as vice-admiral to Sir F. Drake in his expedition to the West Indies, and when soon afterwards the country was threatened with invasion by the Spanish Armada, Frobisher's name was one of four mentioned by the lord high admiral in a letter to the queen of "men of the greatest experience that this realm hath," and for his signal services in the "Triumph," in the dispersion of the Armada, he was knighted. He continued to cruise about in the Channel until 1590, when he was sent in command of a small fleet to the coast of Spain. In 1591 he visited his native Altofts, and there married his second wife, a daughter of Lord Wentworth, becoming at the same time a landed proprietor in Yorkshire and Notts. He found, however, little leisure for a country life, and the following year took charge of the fleet fitted out by Sir Walter Raleigh to the Spanish coast, returning with a rich prize. In November 1594 he was

engaged with a squadron in the siege and relief of Brest, when he received a wound at Fort Crozon from which he died at Plymouth on the 22nd of November. His body was taken to London and buried at St Giles', Cripplegate. Though he appears to have been somewhat rough in his bearing, and too strict a disciplinarian to be much loved, Frobisher was undoubtedly one of the most able seamen of his time and justly takes rank among England's great naval heroes.

See Hakluyt's *Voyages*; the Hakluyt Society's *Three Voyages of Frobisher*; Rev. F. Jones's *Life of Frobisher* (1878); Julian Corbett, *Drake and the Tudor Navy* (1898).

FROCK, originally a long, loose gown with broad sleeves, more especially that worn by members of the religious orders. The word is derived from the O. Fr. *frac*, of somewhat obscure origin; in mediæval Lat. *frocus* appears also as *flocus*, which, if it is the original, as Du Cange suggests (*Literula mutata*), would connect the word with "flock" (q.v.), properly a tuft of wool. Another suggestion refers the word to the German *Rock*, a coat (cf. "rochet"), which in some rare instances is found as *hrock*. The formal stripping off of the frock became part of the ceremony of degradation or deprivation in the case of a condemned monk; hence the expression "to unfrock" (med. Lat. *defraccare*, Fr. *défrapper*) used of the degradation of monks and of priests from holy orders. In the middle ages "frock" was also used of a long loose coat worn by men and of a coat of mail, the "frock of mail." In something of this sense the word survived into the 19th century for a coat with long skirts, now called the "frock coat." The word is now chiefly used in English for a child's or young girl's dress, of body and skirt, but is frequently used of a woman's dress. Du Cange (*Glossarium*, s.v. *flocus*) quotes an early use of the word for a woman's garment (*Miracula S. Udalrici*, ap. Mabillon, *Acta Sanctorum Benedicti*, sæc. v. p. 466). Here a woman, possessed of a devil, is cured, and sends her garments to the tomb of the saint, and a dalmatic is ordered to be made out of the *flocus* or *frocus*. "Frock" also appears in the "smock frock," once the typical outer garment of the English peasant. It consists of a loose shirt of linen or other material, worn over the other clothes and hanging to about the knee; its characteristic feature is the "smocking," a puckered honeycomb stitching round the neck and shoulders.

FROEBEL, FRIEDRICH WILHELM AUGUST (1782-1852), German philosopher, philanthropist and educational reformer, was born at Oberweissbach, a village of the Thuringian forest, on the 21st of April 1782. Like Comenius, with whom he had much in common, he was neglected in his youth, and the remembrance of his own early sufferings made him in after life the more eager in promoting the happiness of children. His mother he lost in his infancy, and his father, the pastor of Oberweissbach and the surrounding district, attended to his parish but not to his family. Friedrich soon had a stepmother, and neglect was succeeded by stepmotherly attention; but a maternal uncle took pity on him, and gave him a home for some years at Stadt-Ilm. Here he went to the village school, but like many thoughtful boys he passed for a dunce. Throughout life he was always seeking for hidden connexions and an underlying unity in all things. Nothing of the kind was to be perceived in the piecemeal studies of the school, and Froebel's mind, busy as it was for itself, would not work for the masters. His half-brother was therefore thought more worthy of a university education, and Friedrich was apprenticed for two years to a forester (1797-1799).

Left to himself in the Thuringian forest, Froebel began to study nature, and without scientific instruction he obtained a profound insight into the uniformity and essential unity of nature's laws. Years afterwards the celebrated Jahn (the "Father Jahn" of the German gymnasts) told a Berlin student of a queer fellow he had met, who made out all sorts of wonderful things from stones and cobwebs. This queer fellow was Froebel; and the habit of making out general truths from the observation of nature, especially from plants and trees, dated from the solitary rambles in the forest. No training could have been better suited to strengthen his inborn tendency to mysticism; and when he

left the forest at the early age of seventeen, he seems to have been possessed by the main ideas which influenced him all his life. The conception which in him dominated all others was the unity of nature; and he longed to study natural sciences that he might find in them various applications of nature's universal laws. With great difficulty he got leave to join his elder brother at the university of Jena, and there for a year he went from lecture-room to lecture-room hoping to grasp that connexion of the sciences which had for him far more attraction than any particular science in itself. But Froebel's allowance of money was very small, and his skill in the management of money was never great, so his university career ended in an imprisonment of nine weeks for a debt of thirty shillings. He then returned home with very poor prospects, but much more intent on what he calls the course of "self-completion" (*Vervollkommnung meines selbst*) than on "getting on" in a worldly point of view. He went to learn farming, but was recalled in consequence of the failing health of his father. In 1802 the father died, and Froebel, now twenty years old, had to shift for himself. It was some time before he found his true vocation, and for the next three and a half years we find him at work now in one part of Germany now in another—sometimes land-surveying, sometimes acting as accountant, sometimes as private secretary; but in all this his "outer life was far removed from his inner life," and in spite of his outward circumstances he became more and more conscious that a great task lay before him for the good of humanity. The nature of the task, however, was not clear to him, and it seemed determined by accident. While studying architecture in Frankfurt-on-Main, he became acquainted with the director of a model school, who had caught some of the enthusiasm of Pestalozzi. This friend saw that Froebel's true field was education, and he persuaded him to give up architecture and take a post in the model school. In this school Froebel worked for two years with remarkable success, but he then retired and undertook the education of three lads of one family. In this he could not satisfy himself, and he obtained the parents' consent to his taking the boys to Yverdon, near Neuchâtel, and there forming with them a part of the celebrated institution of Pestalozzi. Thus from 1807 till 1809 Froebel was drinking in Pestalozzianism at the fountainhead, and qualifying himself to carry on the work which Pestalozzi had begun. For the science of education had to deduce from Pestalozzi's experience principles which Pestalozzi himself could not deduce. And "Froebel, the pupil of Pestalozzi, and a genius like his master, completed the reformer's system; taking the results at which Pestalozzi had arrived through the necessities of his position, Froebel developed the ideas involved in them, not by further experience but by deduction from the nature of man, and thus he attained to the conception of true human development and to the requirements of true education" (Schmidt's *Geschichte der Pädagogik*).

Holding that man and nature, inasmuch as they proceed from the same source, must be governed by the same laws, Froebel longed for more knowledge of natural science. Even Pestalozzi seemed to him not to "honour science in her divinity." He therefore determined to continue the university course which had been so rudely interrupted eleven years before, and in 1811 he began studying at Göttingen, whence he proceeded to Berlin. But again his studies were interrupted, this time by the king of Prussia's celebrated call "to my people." Though not a Prussian, Froebel was heart and soul a German. He therefore responded to the call, enlisted in Lützow's corps, and went through the campaign of 1813. But his military ardour did not take his mind off education. "Everywhere," he writes, "as far as the fatigues I underwent allowed, I carried in my thoughts my future calling as educator; yes, even in the few engagements in which I had to take part. Even in these I could gather experience for the task I proposed to myself." Froebel's soldiering showed him the value of discipline and united action, how the individual belongs not to himself but to the whole body, and how the whole body supports the individual.

Froebel was rewarded for his patriotism by the friendship of two men whose names will always be associated with his,

Langenthal and Middendorff. These young men, ten years younger than Froebel, became attached to him in the field, and were ever afterwards his devoted followers, sacrificing all their prospects in life for the sake of carrying out his ideas.

At the peace of Fontainebleau (signed in May 1814) Froebel returned to Berlin, and became curator of the museum of mineralogy under Professor Weiss. In accepting this appointment from the government he seemed to turn aside from his work as educator; but if not teaching he was learning. More and more the thought possessed him that the one thing needful for man was unity of development, perfect evolution in accordance with the laws of his being, such evolution as science discovers in the other organisms of nature. He at first intended to become a teacher of natural science, but before long wider views dawned upon him. Langenthal and Middendorff were in Berlin, engaged in tuition. Froebel gave them regular instruction in his theory, and at length, counting on their support, he resolved to set about realizing his own idea of "the new education." This was in 1816. Three years before one of his brothers, a clergyman, had died of fever caught from the French prisoners. His widow was still living in the parsonage at Griesheim, a village on the Ilm. Froebel gave up his post, and set out for Griesheim on foot, spending his very last groschen on the way for bread. Here he undertook the education of his orphan niece and nephews, and also of two more nephews sent him by another brother. With these he opened a school and wrote to Middendorff and Langenthal to come and help in the experiment. Middendorff came at once, Langenthal a year or two later, when the school had been moved to Keilhau, another of the Thuringian villages, which became the Mecca of the new faith. In Keilhau Froebel, Langenthal, Middendorff and Barop, a relation of Middendorff's, all married and formed an educational community. Such zeal could not be fruitless, and the school gradually increased, though for many years its teachers, with Froebel at their head, were in the greatest straits for money and at times even for food. After fourteen years' experience he determined to start other institutions to work in connexion with the parent institution at Keilhau, and being offered by a private friend the use of a castle on the Wartensee, in the canton of Lucerne, he left Keilhau under the direction of Barop, and with Langenthal he opened the Swiss institution. The ground, however, was very ill chosen. The Catholic clergy resisted what they considered as a Protestant invasion, and the experiment on the Wartensee and at Willisau in the same canton, to which the institution was moved in 1833, never had a fair chance. It was in vain that Middendorff at Froebel's call left his wife and family at Keilhau, and laboured for four years in Switzerland without once seeing them. The Swiss institution never flourished. But the Swiss government wished to turn to account the presence of the great educator; so young teachers were sent to Froebel for instruction, and finally Froebel moved to Burgdorf (a Bernese town of some importance, and famous from Pestalozzi's labours there thirty years earlier) to undertake the establishment of a public orphanage and also to superintend a course of teaching for schoolmasters. The elementary teachers of the canton were to spend three months every alternate year at Burgdorf, and there compare experiences, and learn of distinguished men such as Froebel and Bitzius. In his conferences with these teachers Froebel found that the schools suffered from the state of the raw material brought into them. Till the school age was reached the children were entirely neglected. Froebel's conception of harmonious development naturally led him to attach much importance to the earliest years, and his great work on *The Education of Man*, published as early as 1826, deals chiefly with the child up to the age of seven. At Burgdorf his thoughts were much occupied with the proper treatment of young children, and in scheming for them a graduated course of exercises, modelled on the games in which he observed them to be most interested. In his eagerness to carry out his new plans he grew impatient of official restraints; so he returned to Keilhau, and soon afterwards opened the first *Kindergarten* or "Garden of Children," in the neighbouring village of Blankenburg (1837). Firmly convinced of the importance of

the Kindergarten for the whole human race, Froebel described his system in a weekly paper (his *Sonntagsblatt*) which appeared from the middle of 1837 till 1840. He also lectured in great towns; and he gave a regular course of instruction to young teachers at Blankenburg. But although the principles of the Kindergarten were gradually making their way, the first Kindergarten was failing for want of funds. It had to be given up, and Froebel, now a widower (he had lost his wife in 1839), carried on his course for teachers first at Keilhau, and from 1848, for the last four years of his life, at or near Liebenstein, in the Thuringian forest, and in the duchy of Meiningen. It is in these last years that the man Froebel will be best known to posterity, for in 1849 he attracted within the circle of his influence a woman of great intellectual power, the baroness von Marenholtz-Bülow, who has given us in her *Recollections of Friedrich Froebel* the only lifelike portrait we possess.

These seemed likely to be Froebel's most peaceful days. He married again in 1851, and having now devoted himself to the training of women as educators, he spent his time in instructing his class of young female teachers. But trouble came upon him from a quarter whence he least expected it. In the great year of revolutions (1848) Froebel had hoped to turn to account the general eagerness for improvement, and Middendorff had presented an address on Kindergartens to the German parliament. Besides this, a nephew of Froebel's, Professor Karl Froebel of Zürich, published books which were supposed to teach socialism. True, the uncle and nephew differed so widely that the "new Froebelians" were the enemies of "the old," but the distinction was overlooked, and Friedrich and Karl Froebel were regarded as the united advocates of some new thing. In the reaction which soon set in, Froebel found himself suspected of socialism and irreligion, and in 1851 the "cultus-minister" Von Raumer issued an edict forbidding the establishment of schools "after Friedrich and Karl Froebel's principles" in Prussia. This was a heavy blow to the old man, who looked to the government of the "Cultus-staat" Prussia for support, and was met with denunciation. Whether from the worry of this new controversy, or from whatever cause, Froebel did not long survive the decree. His seventieth birthday was celebrated with great rejoicings in May 1852, but he died on the 21st of June, and was buried at Schweina, a village near his last abode, Marienthal, near Bad-Liebenstein.

"All education not founded on religion is unproductive." This conviction followed naturally from Froebel's conception of the unity of all things, a unity due to the original Unity from whom all proceed and in whom all "live, move and have their being." As man and nature have one origin they must be subject to the same laws. Hence Froebel, like Comenius two centuries before him, looked to the course of nature for the principles of human education. This he declares to be his fundamental belief: "In the creation, in nature and the order of the material world, and in the progress of mankind, God has given us the true type (*Urbild*) of education." As the cultivator creates nothing in the trees and plants, so the educator creates nothing in the children,—he merely superintends the development of inborn faculties. So far Froebel agrees with Pestalozzi; but in one respect he went beyond him. Pestalozzi said that the faculties were developed by exercise. Froebel added that the function of education was to develop the faculties by arousing voluntary activity. Action proceeding from inner impulse (*Selbstthätigkeit*) was the one thing needful.

The prominence which Froebel gave to action, his doctrine that man is primarily a doer and even a creator, and that he learns only through "self-activity," has its importance all through education. But it was to the first stage of life that Froebel paid the greatest attention. He held with Rousseau that each age has a completeness of its own, and that the perfection of the later stage can be attained only through the perfection of the earlier. If the infant is what he should be as an infant, and the child as a child, he will become what he should be as a boy, just as naturally as new shoots spring from the healthy plant. Every stage, then, must be cared for and tended in such a way that it may attain its own perfection. Impressed with the

immense importance of the first stage, Froebel like Pestalozzi devoted himself to the instruction of mothers. But he would not, like Pestalozzi, leave the children entirely in the mother's hands. Pestalozzi held that the child belonged to the family; Fichte, on the other hand, claimed it for society and the state. Froebel, whose mind delighted in harmonizing apparent contradictions, and who taught that "all progress lay through opposites to their reconciliation," maintained that the child belonged both to the family and to society, and he would therefore have children spend some hours of the day in a common life and in well-organized common employments. These assemblies of children he would not call schools; for the children in them ought not to be old enough for schooling. So he invented the name *Kindergarten*, garden of children, and called the superintendents "children's gardeners." He laid great stress on every child cultivating its own plot of ground, but this was not his reason for the choice of the name. It was rather that he thought of these institutions as enclosures in which young human plants are nurtured. In the Kindergarten the children's employment should be play. But any occupation in which children delight is play to them; and Froebel invented a series of employments, which, while they are in this sense play to the children, have nevertheless, as seen from the adult point of view, a distinct educational object. This object, as Froebel himself describes it, is "to give the children employment in agreement with their whole nature, to strengthen their bodies, to exercise their senses, to engage their awakening mind, and through their senses to bring them acquainted with nature and their fellow creatures; it is especially to guide aright the heart and the affections, and to lead them to the original ground of all life, to unity with themselves."

Froebel's own works are: *Menschenziehung* ("Education of Man"), (1826), which has been translated into French and English; *Pädagogik d. Kindergartens*; *Kleinere Schriften und Mutter- und Kosslieder*; collected editions have been edited by Wichard Lange (1862) and Friedrich Seidel (1883).

A. B. Hauschmann's *Friedrich Fröbel* is a lengthy and unsatisfactory biography. An unpretentious but useful little book is *F. Froebel, a Biographical Sketch*, by Matilda H. Kriege, New York (Steiger). A very good account of Froebel's life and thoughts is given in Karl Schmidt's *Geschichte d. Pädagogik*, vol. iv.; also in Adalbert Weber's *Geschichte d. Volksschulpäd. u. d. Kleinkinderziehung* (Weber carefully gives authorities). For a less favourable account see K. Strack's *Geschichte d. deutsch. Volksschulwesens*. Frau von Marenholtz-Bülow published her *Erinnerungen an F. Fröbel* (translated by Mrs. Horace Mann, 1877). This lady, the chief interpreter of Froebel, has expounded his principles in *Das Kind u. sein Wesen* and *Die Arbeit u. die neue Erziehung*. H. Courthope Bowen has written a memoir (1897) in the "Great Educators" series. In England Miss Emily A. E. Shirreff has published *Principles of Froebel's System*, and a short sketch of Froebel's life. See also Dr Henry Barnard's *Papers on Froebel's Kindergarten* (1881); R. H. Quick, *Educational Reformers* (1890). (R. H. Q.)

FROG,¹ a name in zoology, of somewhat wide application, strictly for an animal belonging to the family *Ranidae*, but also used of some other families of the order *Ecaudata* of the sub-class *Batrachia* (*q.v.*).

Frogs proper are typified by the common British species, *Rana temporaria*, and its allies, such as the edible frog, *R. esculenta*, and the American bull-frog *R. catesbeiana*. The genus *Rana* may be defined as firmisternal Ecaudata with cylindrical transverse processes to the sacral vertebra, teeth in the upper jaw and on the vomer, a protrusible tongue which is free and forked behind, a horizontal pupil and more or less webbed toes. It includes about 200 species, distributed over the whole world.

¹The word "frog" is in O.E. *frocca* or *frox*, cf. Dutch *worst*, Ger. *Frosch*; Skat suggests a possible original source in the root meaning "to jump," "to spring," cf. Ger. *froh*, glad, joyful and "frolic." The term is also applied to the following objects: the horny part in the center of a horse's hoof; an attachment to a belt for suspending a sword, bayonet, &c.; a fastening for the front of a coat, still used in military uniforms, consisting of two buttons on opposite sides joined by ornamental looped braids; and, in railway construction, the point where two rails cross. These may be various transferred applications of the name of the animal, but the "frog" of a horse was also called "frush," probably a corruption of the French name *fourchette*, lit. little fork. The ornamental braiding is also more probably due to "frock," Lat. *foecus*.

with the exception of the greater part of South America and Australia. Some of the species are thoroughly aquatic and have fully webbed toes, others are terrestrial, except during the breeding season, others are adapted for burrowing, by means of the much-enlarged and sharp-edged tubercle at the base of the inner toe, whilst not a few have the tips of the digits dilated into disks by which they are able to climb on trees. In most of the older classifications great importance was attached to these physiological characters, and a number of genera were established which, owing to the numerous annectant forms which have since been discovered, must be abandoned. The arboreal species were thus associated with the true tree-frogs, regardless of their internal structure. We now know that such adaptations are of comparatively small importance, and cannot be utilized for establishing groups higher than genera in a natural or phylogenetic classification. The tree-frogs, *Hylidae*, with which the arboreal *Ranidae* were formerly grouped, show in their anatomical structure a close resemblance to the toads, *Bufo* and *Bufo*, and are therefore placed far away from the true frogs, however great the superficial resemblance between them.

Some frogs grow to a large size. The bull-frog of the eastern United States and Canada, reaching a length of nearly 8 in. from snout to vent, long regarded as the giant of the genus, has been surpassed by the discovery of *Rana guppyi* (8½ in.) in the Solomon Islands, and of *Rana goliath* (10 in.) in South Cameroon.

The family *Ranidae* embraces a large number of genera, some of which are very remarkable. Among these may be mentioned the hairy frog of West Africa, *Trichobatrachus robustus*, some specimens of which have the sides of the body and of the hind limbs covered with long villousities, the function of which is unknown, and its ally *Gampsoscolonyx batesi*, in which the last phalanx of the fingers and toes is sharp, claw-like and perforates the skin. To this family also belong the *Rhacophorus* of eastern Asia, arboreal frogs, some of which are remarkable for the extremely developed webs between the fingers and toes, which are believed to act as a parachute when the frog leaps from the branches of trees (flying-frog of A. R. Wallace), whilst others have been observed to make aerial nests between leaves overhanging water, a habit which is shared by their near allies the *Chiromantis* of tropical Africa. *Dimorphognathus*, from West Africa, is the unique example of a sexual dimorphism in the dentition, the males being provided with a series of large sharp teeth in the lower jaw, which in the female, as in most other members of the family, is edentulous. The curious horned frog of the Solomon Islands, *Ceratobatrachus guentheri*, which can hardly be separated from the *Ranidae*, has teeth in the lower jaw in both sexes, whilst a few forms, such as *Dendrobates* and *Cardioglossa*, which on this account have been placed in a distinct family, have no teeth at all, as in toads. These facts militate strongly against the importance which was once attached to the dentition in the classification of the tailless batrachians.

FROG-BIT, in botany, the English name for a small floating herb known botanically as *Hydrocharis morsus-Ranae*, a member of the order Hydrocharitales, a family of Monocotyledons. The plant has rosettes of roundish floating leaves, and multiplies like the strawberry plant by means of runners, at the end of which new leaf-rosettes develop. Staminate and pistillate flowers are borne on different plants; they have three small green sepals and three broadly ovate white membranous petals. The fruit, which is fleshy, is not found in Britain. The plant occurs in ponds and ditches in England and is rare in Ireland.

FROGMORE, a mansion within the royal demesne of Windsor, England, in the Home Park, 1 m. S.E. of Windsor Castle. It was occupied by George III.'s queen, Charlotte, and later by the duchess of Kent, mother of Queen Victoria, who died here in 1861. The mansion, a plain building facing a small lake, has in its grounds the mausoleum of the duchess of Kent and the royal mausoleum. The first is a circular building surrounded with Ionic columns and rising in a dome, a lower chamber within containing the tomb, while in the upper chamber is a statue of the duchess. There is also a bust of Princess Hohenlohe-Langenberg, half-sister of Queen Victoria; and before the entrance is a

memorial erected by the queen to Lady Augusta Stanley (d. 1876), wife of Dean Stanley. The royal mausoleum, a cruciform building with a central octagonal lantern, richly adorned within with marbles and mosaics, was erected (1862-1870) by Queen Victoria over the tomb of Albert, prince consort, by whose side the queen herself was buried in 1901. There are also memorials to Princess Alice and Prince Leopold in the mausoleum. To the south of the mansion are the royal gardens and dairy.

FRÖHLICH, ABRAHAM EMANUEL (1796-1865), Swiss poet, was born on the 1st of February 1796 at Brugg in the canton of Aargau, where his father was a teacher. After studying theology at Zürich he became a pastor in 1817 and returned as teacher to his native town, where he lived for ten years. He was then appointed professor of the German language and literature in the cantonal school at Aarau, which post he lost, however, in the political quarrels of 1830. He afterwards obtained the post of teacher and rector of the cantonal college, and was also appointed assistant minister at the parish church. He died at Baden in Aargau on the 1st of December 1865. His works are—*170 Fabeln* (1825); *Schweizerlieder* (1827); *Das Evangelium St. Johannis, in Liedern* (1830); *Elegeren an Wieg' und Sarg* (1835); *Die Epopöen; Ulrich Zwingli* (1840); *Ulrich von Hutten* (1845); *Auserlesene Psalmen und geistliche Lieder für die Evangelisch-reformirte Kirche des Cantons Aargau* (1844); *Über den Kirchengesang der Protestanten* (1846); *Trostlieder* (1852); *Der Junge Deutsch-Michel* (1846); *Reimsprüche aus Staat, Schule, und Kirche* (1820). An edition of his collected works, in 5 vols., was published at Frauenfeld in 1853. Fröhlich is best known for his two heroic poems, *Ulrich Zwingli* and *Ulrich von Hutten*, and especially for his fables, which have been ranked with those of Hagedorn, Lessing and Gellert.

See the *Life* by R. Fasi (Zürich, 1907).

FROHSCHAMMER, JAKOB (1821-1893), German theologian and philosopher, was born at Illkofen, near Regensburg, on the 6th of January 1821. Destined by his parents for the Roman Catholic priesthood, he studied theology at Munich, but felt an ever-growing attraction to philosophy. Nevertheless, after much hesitation, he took what he himself calls the most mistaken step of his life, and in 1847 entered the priesthood. His keenly logical intellect, and his impatience of authority where it clashed with his own convictions, quite unfitted him for that unquestioning obedience which the Church demanded. It was only after open defiance of the bishop of Regensburg that he obtained permission to continue his studies at Munich. He at first devoted himself more especially to the study of the history of dogma, and in 1850 published his *Beiträge zur Kirchengeschichte*, which was placed on the Index Expurgatorius. But he felt that his real vocation was philosophy, and after holding for a short time an extraordinary professorship of theology, he became professor of philosophy in 1855. This appointment he owed chiefly to his work, *Über den Ursprung der menschlichen Seelen* (1854), in which he maintained that the human soul was not implanted by a special creative act in each case, but was the result of a secondary creative act on the part of the parents: that soul as well as body, therefore, was subject to the laws of heredity. This was supplemented in 1855 by the controversial *Menschenseele und Physiologie*. Undeterred by the offence which these works gave to his ecclesiastical superiors, he published in 1858 the *Einleitung in die Philosophie und Grundriss der Metaphysik*, in which he assailed the doctrine of Thomas Aquinas, that philosophy was the handmaid of theology. In 1861 appeared *Über die Aufgabe der Naturphilosophie und ihr Verhältnis zur Naturwissenschaft*, which was, he declared, directed against the purely mechanical conception of the universe, and affirmed the necessity of a creative Power. In the same year he published *Über die Freiheit der Wissenschaft*, in which he maintained the independence of science, whose goal was truth, against authority, and reproached the excessive respect for the latter in the Roman Church with the insignificant part played by the German Catholics in literature and philosophy. He was denounced by the pope himself in an apostolic brief of the 11th of December 1865, and students of theology were forbidden to attend his lectures.

Public opinion was now keenly excited; he received an ovation from the Munich students, and the king, to whom he owed his appointment, supported him warmly. A conference of Catholic savants, held in 1863 under the presidency of Döllinger, decided that authority must be supreme in the Church. When, however, Döllinger and his school in their turn started the Old Catholic movement, Frohschammer refused to associate himself with their cause, holding that they did not go far enough, and that their declaration of 1863 had cut the ground from under their feet. Meanwhile he had, in 1862, founded the *Athenäum* as the organ of Liberal Catholicism. For this he wrote the first adequate account in German of the Darwinian theory of natural selection, which drew a warm letter of appreciation from Darwin himself. Excommunicated in 1871, he replied with three articles, which were reproduced in thousands as pamphlets in the chief European languages: *Der Fels Petri in Rom* (1873), *Der Primat Petri und des Papstes* (1875), and *Das Christenthum Christi und das Christenthum des Papstes* (1876). In *Das neue Wissen und der neue Glaube* (1873) he showed himself as vigorous an opponent of the materialism of Strauss as of the doctrine of papal infallibility. His later years were occupied with a series of philosophical works, of which the most important were: *Die Phantasie als Grundprincip des Weltprocesses* (1877), *Über die Genesis der Menschheit und deren geistige Entwicklung in Religion, Sittlichkeit und Sprache* (1883), and *Über die Organisation und Cultur der menschlichen Gesellschaft* (1885). His system is based on the unifying principle of imagination (*Phantasie*), which he extends to the objective creative force of Nature, as well as to the subjective mental phenomena to which the term is usually confined. He died at Bad Kreuth in the Bavarian Highlands on the 14th of June 1893.

In addition to other treatises on theological subjects, Frohschammer was also the author of *Monaden und Weltphantasie und Über die Bedeutung der Einbildungskraft in der Philosophie Kants und Spinozas* (1879); *Über die Principien der Aristotelischen Philosophie und die Bedeutung der Phantasie in derselben* (1881); *Die Philosophie als Idealwissenschaft und System* (1884); *Die Philosophie des Thomas von Aquino kritisch gewürdigt* (1889); *Über das Mysterium Magnum des Daseins* (1891); *System der Philosophie im Umrisz*, pt. I. (1892). His autobiography was published in A. Hinrichsen's *Deutsche Denker* (1888). See also F. Kirchner, *Über das Grundprincip der Weltprocesses* (1882), with special reference to F.; E. Reich, *Weltanschauung und Menschenleben; Betrachtungen über die Philosophie J. Frohschammers* (1894); B. Münz, *J. Frohschammer, der Philosoph der Weltphantasie und Briefe von und über J. Frohschammer* (1897); J. Friedrich, *Jakob Frohschammer* (1896) and *Systematische und kritische Darstellung der Psychologie J. Frohschammers* (1899); A. Attensperger, *J. Frohschammers philosophisches System im Grundriss* (1899).

FROISSART, JEAN (1338-1410?), French chronicler and raconteur, historian of his own times. The personal history of Froissart, the circumstances of his birth and education, the incidents of his life, must all be sought in his own verses and chronicles. He possessed in his own lifetime no such fame as that which attended the steps of Petrarch; when he died it did not occur to his successors that a chapter might well be added to his *Chronicle* setting forth what manner of man he was who wrote it. The village of Lestines, where he was curé, has long forgotten that a great writer ever lived there. They cannot point to any house in Valenciennes as the lodging in which he put together his notes and made history out of personal reminiscences. It is not certain when or where he died, or where he was buried. One church, it is true, doubtfully claims the honour of holding his bones. It is that of St Monegunda of Chimay.

"Gallorum sublimis bonos et fama tuorum,
Hic Froissarde, jaces, si modo forte jaces."

It is fortunate, therefore, that the scattered statements in his writings may be so pieced together as to afford a tolerably connected history of his life year after year. The personality of the man, independently of his adventures, may be arrived at by the same process. It will be found that Froissart, without meaning it, has portrayed himself in clear and well-defined outline. His forefathers were *jurés* (aldermen) of the little town of Beaumont, lying near the river Sambre, to the west of the forest of Ardennes. Early in the 14th century the castle and

seigneurie of Beaumont fell into the hands of Jean, younger son of the count of Hainaut. With this Jean, sire de Beaumont, lived a certain canon of Liège called Jean le Bel, who fortunately was not content simply to enjoy life. Instigated by his seigneur he set himself to write contemporary history, to tell "la pure veriteit de tout li fait entièrement al manire de chroniques." With this view, he compiled two books of chronicles. And the chronicles of Jean le Bel were not the only literary monuments belonging to the castle of Beaumont. A hundred years before him Baldwin d'Avernes, the then seigneur, had caused to be written a book of chronicles or rather genealogies. It must therefore be remembered that when Froissart undertook his own chronicles he was not conceiving a new idea, but only following along familiar lines.

Some 20 m. from Beaumont stood the prosperous city of Valenciennes, possessed in the 14th century of important privileges and a flourishing trade, second only to places like Bruges or Ghent in influence, population and wealth. Beaumont, once her rival, now regarded Valenciennes as a place where the ambitious might seek for wealth or advancement, and among those who migrated thither was the father of Froissart. He appears from a single passage in his son's verses to have been a painter of armorial bearings. There was, it may be noted, already what may be called a school of painters at Valenciennes. Among them were Jean and Colin de Valenciennes and André Beau-Neveu, of whom Froissart says that he had not his equal in any country.

The date generally adopted for his birth is 1338. In after years Froissart pleased himself by recalling in verse the scenes and pursuits of his childhood. These are presented in vague generalities. There is nothing to show that he was unlike any other boys, and, unfortunately, it did not occur to him that a photograph of a schoolboy's life amid bourgeois surroundings would be to posterity quite as interesting as that faithful portraiture of courts and knights which he has drawn up in his *Chronicle*. As it is, we learn that he loved games of dexterity and skill rather than the sedentary amusements of chess and draughts, that he was beaten when he did not know his lessons, that with his companions he played at tournaments, and that he was always conscious—a statement which must be accepted with suspicion—that he was born

"Loer Dieu et servir le monde."

In any case he was born in a place, as well as at a time, singularly adapted to fill the brain of an imaginative boy. Valenciennes was then a city extremely rich in romantic associations. Not far from its walls was the western fringe of the great forest of Ardennes, sacred to the memory of Pepin, Charlemagne, Roland and Ogier. Along the banks of the Scheldt stood, one after the other, not then in ruins, but bright with banners, the gleam of armour, and the liveries of the men at arms, castles whose seigneurs, now forgotten, were famous in their day for many a gallant feat of arms. The castle of Valenciennes itself was illustrious in the romance of *Perceforest*. There was born that most glorious and most luckless hero, Baldwin, first emperor of Constantinople. All the splendour of medieval life was to be seen in Froissart's native city: on the walls of the Salle le Comte glittered—perhaps painted by his father—the arms and scutcheons beneath the banners and helmets of Luxembourg, Hainaut and Avesnes; the streets were crowded with knights and soldiers, priests, artisans and merchants; the churches were rich with stained glass, delicate tracery and precious carving; there were libraries full of richly illuminated manuscripts on which the boy could gaze with delight; every year there was the *fête of the puy d'Amour de Valenciennes*, at which he would hear the verses of the competing poets; there were festivals, masques, mummeries and moralities. And, whatever there might be elsewhere, in this happy city there was only the pomp, and not the misery, of war; the fields without were tilled, and the harvests reaped, in security; the workman within plied his craft unmolested for good wage. But the eyes of the boy were turned upon the castle and not upon the town; it was the splendour of the knights which dazzled him, inasmuch that he

regarded and continued ever afterwards to regard a prince gallant in the field, glittering of apparel, lavish of largesse, as almost a god.

The moon, he says, rules the first four years of life; Mercury the next ten; Venus follows. He was fourteen when the last goddess appeared to him in person, as he tells us, after the manner of his time, and informed him that he was to love a lady, "belle, jone, et gente." Awaiting this happy event, he began to consider how best to earn his livelihood. They first placed him in some commercial position—impossible now to say of what kind—which he simply calls "la marchandise." This undoubtedly means some kind of buying and selling, not a handicraft at all. He very soon abandoned merchandise—"car vaut mieus science qu'argens"—and resolved on becoming a learned clerk. He then naturally began to make verses, like every other learned clerk. Quite as naturally, and still in the character of a learned clerk, he fulfilled the prophecy of Venus and fell in love. He found one day a demoiselle reading a book of romances. He did not know who she was, but stealing gently towards her, he asked her what book she was reading. It was the romance of *Cleomades*. He remarked the singular beauty of her blue eyes and fair hair, while she reads a page or two, and then—one would almost suspect a reminiscence of Dante—

"Adont laissames nous le lire."

He was thus provided with that essential for soldier, knight or poet, a mistress—one for whom he could write verses. She was rich and he was poor; she was nobly born and he obscure; it was long before she would accept the devotion, even of the conventional kind which Froissart offered her, and which would in no way interfere with the practical business of her life. And in this hopeless way, the passion of the young poet remaining the same, and the coldness of the lady being unaltered, the course of this passion ran on for some time. Nor was it until the day of Froissart's departure from his native town that she gave him an interview and spoke kindly to him, even promising, with tears in her eyes, that "Doulce Pensée" would assure him that she would have no joyous day until she should see him again.

He was eighteen years of age; he had learned all that he wanted to learn; he possessed the mechanical art of verse; he had read the slender stock of classical literature accessible; he longed to see the world. He must already have acquired some distinction, because, on setting out for the court of England, he was able to take with him letters of recommendation from the king of Bohemia and the count of Hainaut to Queen Philippa, niece of the latter. He was well received by the queen, always ready to welcome her own countrymen; he wrote ballades and virelays for her and her ladies. But after a year he began to pine for another sight of "la très douce, simple, et quois," whom he loved loyally. Good Queen Philippa, perceiving his altered looks and guessing the cause, made him confess that he was in love and longed to see his mistress. She gave him his *congé* on the condition that he was to return. It is clear that the young clerk had already learned to ingratiate himself with princes.

The conclusion of his single love adventure is simply and unaffectedly told in his *Treitie de l'espinnette amoureuse*. It was a passion conducted on the well-known lines of conventional love; the pair exchanged violets and roses, the lady accepted ballads; Froissart became either openly or in secret her recognized lover, a mere title of honour, which conferred distinction on her who bestowed it, as well as upon him who received it. But the progress of the amour was rudely interrupted by the arts of "Malebouche," or Calumny. The story, whatever it was, that Malebouche whispered in the ear of the lady led to a complete rupture. The *demoiselle* not only scornfully refused to speak to her lover or acknowledge him, but even seized him by the hair and pulled out a handful. Nor would she ever be reconciled to him again. Years afterwards, when Froissart writes the story of his one love passage, he shows that he still takes delight in the remembrance of her, loves to draw her portrait, and lingers with fondness over the thought of what she once was to him.

Perhaps to get healed of his sorrow, Froissart began those

wanderings in which the best part of his life was to be consumed. He first visited Avignon, perhaps to ask for a benefice, perhaps as the bearer of a message from the bishop of Cambray to pope or cardinal. It was in the year 1360, and in the pontificate of Innocent VI. From the papal city he seems to have gone to Paris, perhaps charged with a diplomatic mission. In 1361 he returned to England after an absence of five years. He certainly interpreted his leave of absence in a liberal spirit, and it may have been with a view of averting the displeasure of his kind-hearted protector that he brought with him as a present a book of rhymed chronicles written by himself. He says that notwithstanding his youth, he took upon himself the task "à rimer et à dicter"—which can only mean to "turn into verse"—an account of the wars of his own time, which he carried over to England in a book "tout compilé,"—complete to date,—and presented to his noble mistress Philippa of Hainaut, who joyfully and gently received it of him. Such a rhymed chronicle was no new thing. One Colin had already turned the battle of Crécy into verse. The queen made young Froissart one of her secretaries, and he began to serve her with "beaux ditifs et traités amoureux."

Froissart would probably have been content to go on living at ease in this congenial atmosphere of flattery, praise and caresses, pouring out his virelays and chansons according to demand with facile monotony, but for the instigation of Queen Philippa, who seems to have suggested to him the propriety of travelling in order to get information for more rhymed chronicles. It was at her charges that Froissart made his first serious journey. He seems to have travelled a great part of the way alone, or accompanied only by his servants, for he was fain to beguile the journey by composing an imaginary conversation in verse between his horse and his hound. This may be found among his published poems, but it does not repay perusal. In Scotland he met with a favourable reception, not only from King David but from William of Douglas, and from the earls of Fife, Mar, March and others. The souvenirs of this journey are found scattered about in the chronicles. He was evidently much impressed with the Scots; he speaks of the valour of the Douglas, the Campbell, the Ramsay and the Graham; he describes the hospitality and rude life of the Highlanders; he admires the great castles of Stirling and Roxburgh and the famous abbey of Melrose. His travels in Scotland lasted for six months. Returning southwards he rode along the whole course of the Roman wall, a thing alone sufficient to show that he possessed the true spirit of an archaeologist; he thought that Carlisle was Carliou, and congratulated himself on having found King Arthur's capital; he calls Westmorland, where the common people still spoke the ancient British tongue, North Wales; he rode down the banks of the Severn, and returned to London by way of Oxford—"l'escole d'Asque-Suffort."

In London Froissart entered into the service of King John of France as secretary, and grew daily more courtly, more in favour with princes and great ladies. He probably acquired at this period that art, in which he has probably never been surpassed, of making people tell him all they knew. No newspaper correspondent, no American interviewer, has ever equalled this medieval collector of intelligence. From Queen Philippa, who confided to him the tender story of her youthful and lasting love for her great husband, down to the simplest knight—Froissart conversed with none beneath the rank of gentlemen—all united in telling this man what he wanted to know. He wanted to know everything; he liked the story of a battle from both sides and from many points of view; he wanted the details of every little cavalry skirmish, every capture of a castle, every gallant action and brave deed. And what was more remarkable, he forgot nothing. "I had," he says, "thanks to God, sense, memory, good remembrance of everything, and an intellect clear and keen to seize upon the acts which I could learn." But as yet he had not begun to write in prose.

At the age of twenty-nine, in 1366, Froissart once more left England. This time he repaired first to Brussels, whither were gathered together a great concourse of minstrels from all parts.

from the courts of the kings of Denmark, Navarre and Aragon, from those of the dukes of Lancaster, Bavaria and Brunswick. Hither came all who could "rimer et dicter." What distinction Froissart gained is not stated; but he received a gift of money, as appears from the accounts: "uni Fritsardo, dictori, qui est cum regina Angliæ, dicto die, vi. motteson."

After this congress of versifiers, he made his way to Brittany, where he heard from eye-witnesses and knights who had actually fought there details of the battles of Cocherel and Auray, the Great Day of the Thirty and the heroism of Jeanne de Montfort. Windsor Herald told him something about Auray, and a French knight, one Antoine de Beaujeu, gave him the details of Cocherel. From Brittany he went southwards to Nantes, La Rochelle and Bordeaux, where he arrived a few days before the visit of Richard, afterwards second of that name. He accompanied the Black Prince to Dax, and hoped to go on with him into Spain, but was despatched to England on a mission. He next formed part of the expedition which escorted Lionel duke of Clarence to Milan, to marry the daughter of Galeazzo Visconti. Chaucer was also one of the prince's suite. At the wedding banquet Petrarch was a guest sitting among the princes.

From Milan Froissart, accepting gratefully a *cotte hardie* with 20 florins of gold, set out upon his travels in Italy. At Bologna, then in decadence, he met Peter king of Cyprus, from whose follower and minister, Eustache de Confans, he learned many interesting particulars of the king's exploits. He accompanied Peter as far as Venice, where he left him after receiving a gift of 40 ducats. With them and his *cotte hardie*, still lined we may hope with the 20 florins, Froissart betook himself to Rome. The city was then at its lowest point: the churches were roofless; there was no pope; there were no pilgrims; there was no splendour; and yet, says Froissart sadly,

"Ce furent jadis en Rome
Li plus preu et li plus sage homme,
Car par sens tons les arts passerent."

It was at Rome that he learned of the death of his friend King Peter of Cyprus, and, worse still, an irreparable loss to him, that of the good Queen Philippa, of whom he writes, in grateful remembrance—

"Propices li soit Dieu à l'âme!
J'en suis bien tenu de pryer
Et ses largheces escuyer,
Car elle me fist et créa."

Philippa dead, Froissart looked around for a new patron. Then he hastened back to his own country and presented himself, with a new book in French, to the duchess of Brabant, from whom he received the sum of 16 francs, given in the accounts as paid *uni Frissardo dictatori*. The use of the word *uni* does not imply any meanness of position, but is simply an equivalent to the modern French *sieur*. Froissart may also have found a patron in Yolande de Bar, grandmother of King René of Anjou. In any case he received a substantial gift from some one in the shape of the benefice of Lestines, a village some three or four miles from the town of Binche. Also, in addition to his cure, he got placed upon the duke of Brabant's pension list, and was entitled to a yearly grant of grain and wine, with some small sum in money.

It is clear, from Froissart's own account of himself, that he was by no means a man who would at the age of four or five and thirty be contented to sit down at ease to discharge the duties of parish priest, to say mass, to bury the dead, to marry the villagers and to baptize the young. In those days, and in that country, it does not seem that other duties were expected. Preaching was not required, godliness of life, piety, good works, and the graces of a modern ecclesiastic were not looked for. Therefore, when Froissart complains to himself that the taverns of Lestines got 500 francs of his money, we need not at once set him down as either a bad priest or exceptionally given to drink. The people of the place were greatly addicted to wine; the *taverniers de Lestines* proverbially sold good wine; the Flemings were proverbially of a joyous disposition—

"Ceux de Hainaut chantent à pleines gorges."

Froissart, the parish priest of courtly manners, no doubt

drank with the rest, and listened if they sang his own, not the coarse country songs. Mostly he preferred the society of Gerard d'Obies, provost of Binche, and the little circle of knights within that town. Or—for it was not incumbent on him to be always in residence—he repaired to the court of Coudenberg, and became "moult frère et accointé" with the duke of Brabant. And then came Gui de Blois, one of King John's hostages in London in the old days. He had been fighting in Prussia with the Teutonic knights, and now, a little tired of war, proposed to settle down for a time in his castle of Beaumont. This prince was a member of the great house of Chatillon. He was count of Blois, of Soissons and of Chimay. He had now, about the year 1374, an excellent reputation as a good captain. In him Froissart, who hastened to resume acquaintance, found a new patron. More than that, it was this sire de Beaumont, in emulation of his grandfather, the patron of Jean le Bel, who advised Froissart seriously to take in hand the history of his own time. Froissart was then in his thirty-sixth year. For twenty years he had been rhyming, for eighteen he had been making verses for queens and ladies. Yet during all this time he had been accumulating in his retentive brain the materials for his future work.

He began by editing, so to speak, that is, by rewriting with additions, the work of Jean le Bel; Gui de Blois, among others, supplied him with additional information. His own notes, taken from information obtained in his travels, gave him more details, and when in 1374 Gui married Marie de Namur, Froissart found in the bride's father, Robert de Namur, one who had himself largely shared in the events which he had to relate. He, for instance, is the authority for the story of the siege of Calais and the six burghesses. Provided with these materials, Froissart remained at Lestines, or at Beaumont, arranging and writing his chronicles. During this period, too, he composed his *Espinette amoureuse*, and the *Joli Buisson de jonesse*, and his romance of *Méliador*. He also became chaplain to the count of Blois, and obtained a canonry of Chimay. After this appointment we hear nothing more of Lestines, which he probably resigned.

In these quiet pursuits he passed twelve years, years of which we hear nothing, probably because there was nothing to tell. In 1386 his travels began again, when he accompanied Gui to his castle at Blois, in order to celebrate the marriage of his son Louis de Dunois with Marie de Berry. He wrote a *pastourelle* in honour of the event. Then he attached himself for a few days to the duke of Berry, from whom he learned certain particulars of current events, and then, becoming aware of what promised to be the most mighty feat of arms of his time, he hastened to Sluis in order to be on the spot. At this port the French were collecting an enormous fleet, and making preparations of the greatest magnitude in order to repeat the invasion of William the Conqueror. They were tired of being invaded by the English and wished to turn the tables. The talk was all of conquering the country and dividing it among the knights, as had been done by the Normans. It is not clear whether Froissart intended to go over with the invaders; but as his sympathies are ever with the side where he happens to be, he exhausts himself in admiration of this grand gathering of ships and men. "Any one," he says, "who had a fever would have been cured of his malady merely by going to look at the fleet." But the delays of the duke of Berry, and the arrival of bad weather, spoiled everything. There was no invasion of England. In Flanders Froissart met many knights who had fought at Rosebeque, and could tell him of the troubles which in a few years desolated that country, once so prosperous. He set himself to ascertain the history with as much accuracy as the comparison of various accounts by eye-witnesses and actors would allow. He stayed at Ghent, among those ruined merchants and mechanics, for whom, as one of the same class, he felt a sympathy never extended to English or French, perhaps quite as unfortunate, and he devotes no fewer than 300 chapters to the Flemish troubles, an amount out of all proportion to the comparative importance of the events. This portion of the chronicle was written at Valenciennes. During this residence in his birthplace his verses were crowed at the "pays d'amour" of Valenciennes and Tournay

This part of his work finished, he considered what to do next. There was small chance of anything important happening in Picardy or Hainault, and he determined on making a journey to the south of France in order to learn something new. He was then fifty-one years of age, and being still, as he tells us, in his prime, "of an age, strength, and limbs able to bear fatigue," he set out as eager to see new places as when, 33 years before, he rode through Scotland and marvelled at the bravery of the Douglas. What he had, in addition to strength, good memory and good spirits, was a manner singularly pleasing and great personal force of character. This he does not tell us, but it comes out abundantly in his writings; and, which he does tell us, he took a singular delight in his book. "The more I work at it," he says, "the better am I pleased with it."

On this occasion he rode first to Blois; on the way he fell in with two knights who told him of the disasters of the English army in Spain; one of them also informed him of the splendid hospitalities and generosity of Gaston Phoebus, count of Foix, on hearing of which Froissart resolved to seek him out. He avoided the English provinces of Poitou and Guienne, and rode southwards through Berry, Auvergne and Languedoc. Arrived at Foix he discovered that the count was at Orthez, whither he proceeded in company with a knight named Espaing de Lyon, who, Froissart found, had not only fought, but could describe.

The account of those few days' ride with Espaing de Lyon is the most charming, the most graphic, and the most vivid chapter in the whole of Froissart. Every turn of the road brings with it the sight of a ruined castle, about which this knight of many memories has a tale or a reminiscence. The whole country teems with fighting stories. Froissart never tires of listening nor the good knight of telling "Sainte Marie!" cries Froissart in mere rapture. "How pleasant are your tales, and how much do they profit me while you relate them! And you shall not lose your trouble, for they shall all be set down in memory and remembrance in the history which I am writing." Arrived at length at Orthez, Froissart lost no time in presenting his credentials to the count of Foix. Gaston Phoebus was at this time fifty-nine years of age. His wife, from whom he was separated, was that princess, sister of Charles of Navarre, with whom Guillaume de Machault carried on his innocent and poetical amour. The story of the miserable death of his son is well known, and may be read in Froissart. But that was already a tale of the past, and the state which the count kept up was that of a monarch. To such a prince such a visitor as Froissart would be in every way welcome. Mindful no doubt of those paid clerks who were always writing verses, Froissart introduced himself as a chronicler. He could, of course, rhyme, and in proof he brought with him his romance of *Meliador*; but he did not present himself as a wandering poet. The count received him graciously, speedily discovered the good qualities of his guest, and often invited him to read his *Meliador* aloud in the evening, during which time, says Froissart, "nobody dared to say a word, because he wished me to be heard, such great delight did he take in listening." Very soon Froissart, from reader of a romance, became raconteur of the things he had seen and heard; the next step was that the count himself began to talk of affairs, so that the notebook was again in requisition. There was a good deal, too, to be learned of people about the court. One knight recently returned from the East told about the Genoese occupation of Famagosta; two more had been in the fray of Otterbourne; others had been in the Spanish wars.

Leaving Gaston at length, Froissart assisted at the wedding of the old duke of Berry with the youthful Jeanne de Bourbon, and was present at the grand reception given to Isabeau of Bavaria by the Parisians. He then returned to Valenciennes, and sat down to write his fourth book. A journey undertaken at this time is characteristic of the thorough and conscientious spirit in which he composed his work; it illustrates also his restless and curious spirit. While engaged in the events of the year 1385 he became aware that his notes taken at Orthez and elsewhere on the affairs of Castile and Portugal were wanting in completeness. He left Valenciennes and hastened to Bruges, where, he felt certain, he should find some one who would help

him. There was, in fact, at this great commercial centre, a colony of Portuguese. From them he learned that a certain Portuguese knight, Dom Juan Fernand Pacheco, was at the moment in Middelburg on the point of starting for Prussia. He instantly embarked at Sluys, reached Middelburg in time to catch this knight, introduced himself, and conversed with him uninterruptedly for the space of six days, getting his information on the promise of due acknowledgment. During the next two years we learn little of his movements. He seems, however, to have had trouble with his seigneur Gui de Blois, and even to have resigned his chaplaincy. Froissart is tender with Gui's reputation, mindful of past favours and remembering how great a lord he is. Yet the truth is clear that in his declining years the once gallant Gui de Blois became a glutton and a drunkard, and allowed his affairs to fall into the greatest disorder. So much was he crippled with debt that he was obliged to sell his castle and county of Blois to the king of France. Froissart lays all the blame on evil counsellors. "He was my lord and master," he says simply, "an honourable lord and of great reputation; but he trusted too easily in those who looked for neither his welfare nor his honour." Although canon of Chimay and perhaps curé of Lestines as well, it would seem as if Froissart was not able to live without a patron. He next calls Robert de Namur his seigneur, and dedicates to him, in a general introduction, the whole of his chronicles. We then find him at Abbeville, trying to learn all about the negotiations pending between Charles VI. and the English. He was unsuccessful, either because he could not get at those who knew what was going on, or because the secret was too well kept. He next made his last visit to England, where, after forty years' absence, he naturally found no one who remembered him. Here he gave King Richard a copy of his "traités amoureux," and got favour at court. He stayed in England some months, seeking information on all points from his friends Henry Chrystead and Richard Stury, from the dukes of York and Gloucester, and from Robert the Hermit.

On his return to France, he found preparations going on for that unlucky crusade, the end of which he describes in his *Chronicle*. It was headed by the count of Nevers. After him floated many a banner of knights, descendants of the crusaders, who bore the proud titles of duke of Athens, duke of Thebes, sire de Sidon, sire de Jericho. They were going to invade the sultan's empire by way of Hungary; they were going to march south; they would reconquer the holy places. And presently we read how it all came to nothing, and how the slaughtered knights lay dead outside the city of Nikopoli. In almost the concluding words of the *Chronicle* the murder of Richard II. of England is described. His death ends the long and crowded *Chronicle*, though the pen of the writer struggles through a few more unfinished sentences.

The rest is vague tradition. He is said to have died at Chimay; it is further said that he died in poverty so great that his relations could not even afford to carve his name upon the headstone of his tomb; not one of his friends, not even Eustache Deschamps, writes a line of regret in remembrance; the greatest historian of his age had a reputation so limited that his death was no more regarded than that of any common monk or obscure priest. We would willingly place the date of his death, where his *Chronicle* stops, in the year 1400; but tradition assigns the date of 1410. What date more fitting than the close of the century for one who has made that century illustrious for ever?

Among his friends were Guillaume de Machault, Eustache Deschamps, the most vigorous poet of this age of decadence, and Cuvelier, a follower of Bertrand du Guesclin. These alliances are certain. It is probable that he knew Chaucer, with whom Deschamps maintained a poetical correspondence; there is nothing to show that he ever made the acquaintance of Christine de Pisan. Froissart was more proud of his poetry than his prose. Posterity has reversed this opinion, and though a selection of his verse has been published, it would be difficult to find an admirer, or even a reader, of his poems. The selection published by Buchon in 1829 consists of the *Diu don feruin*, half of which is a description of the power of money; the *Dit don chereal*

et don levrier, written during his journey in Scotland; the *Distie de la fleur de la Margherite*; a *Distie d'amour* called *L'Orlose amoureux*, in which he compares himself, the imaginary lover, with a clock; the *Espinette amoureuse*, which contains a sketch of his early life, freely and pleasantly drawn, accompanied by rondeaux and virelays; the *Buisson de jonesce*, in which he returns to the recollections of his own youth; and various smaller pieces. The verses are monotonous; the thoughts are not without poetical grace, but they are expressed at tedious length. It would be, however, absurd to expect in Froissart the vigour and verve possessed by none of his predecessors. The time was gone when Marie de France, Rutebeuf and Thibaut de Champagne made the 13th-century language a medium for verse of which any literature might be proud. Briefly, Froissart's poetry, unless the unpublished portion be better than that before us, is monotonous and mechanical. The chief merit it possesses is in simplicity of diction. This not infrequently produces a pleasing effect.

As for the character of his *Chronicle*, little need be said. There has never been any difference of opinion on the distinctive merits of this great work. It presents a vivid and faithful drawing of the things done in the 14th century. No more graphic account exists of any age. No historian has drawn so many and such faithful portraits. They are, it is true, portraits of men as they seemed to the writer, not of men as they were. Froissart was uncritical; he accepted princes by their appearance. Who, for instance, would recognize in his portrait of Gaston Phoebus de Foix the cruel voluptuary, stained with the blood of his own son, which we know him to have been? Froissart, again, had no sense of historical responsibility; he was no judge to inquire into motives and condemn actions; he was simply a chronicler. He has been accused by French authors of lacking patriotism. Yet it must be remembered that he was neither a Frenchman nor an Englishman, but a Fleming. He has been accused of insensibility to suffering. Indignation against oppression was not, however, common in the 14th century; why demand of Froissart a quality which is rare enough even in our own time? Yet there are moments when, as in describing the massacre of Limoges, he speaks with tears in his voice.

Let him be judged by his own aims. "Before I commence this book," he says, "I pray the Saviour of all the world, who created every thing out of nothing, that He will also create and put in me sense and understanding of so much worth, that this book, which I have begun, I may continue and persevere in, so that all those who shall read, see, and hear it may find in it delight and pleasure." To give delight and pleasure, then, was his sole design.

As regards his personal character, Froissart depicts it himself for us. Such as he was in youth, he tells us, so he remained in more advanced life; rejoicing mightily in dances and carols, in hearing minstrels and poems; inclined to love all those who love dogs and hawks; pricking up his ears at the uncorking of bottles,—"*Car au voire prens grand plaisir*"; pleased with good cheer, gorgeous apparel and joyous society, but no commonplace reveller or greedy voluptuary,—everything in Froissart was ruled by the good manners which he set before all else; and always eager to listen to tales of war and battle. As we have said above, he shows, not only by his success at courts, but also by the whole tone of his writings, that he possessed a singularly winning manner and strong personal character. He lived wholly in the present, and had no thought of the coming changes. Born when chivalrous ideas were most widely spread, but the spirit of chivalry itself, as inculcated by the best writers, in its decadence, he is penetrated with the sense of knightly honour, and ascribes to all his heroes alike those qualities which only the ideal knight possessed.

The first edition of Froissart's *Chronicles* was published in Paris. It bears no date: the next editions are those of the years 1505, 1514, 1518 and 1520. The edition of Buchon, 1824, was a continuation of one commenced by Dacier. The best modern editions are those of Kervyn de Lettenhove (Brussels, 1863-1877) and Simson Luce (Paris, 1869-1888); for bibliography see Forchast, *Bibliotheca hist.*

medii aevi, i. (Berlin, 1896). An abridgment was made in Latin by Belleforest, and published in 1672. An English translation was made by Boucher, Lord Berners, and published in London, 1525. See the "Tudor Translations" edition of Berners (Nutt, 1901), with introduction by W. P. Ker; and the "Globe" edition, with introduction by G. C. Macaulay. The translation by Thomas Johnes was originally published in 1802-1805. For Froissart's poems see Scheler's text in K. de Lettenhove's complete edition; *Milivador* has been edited by Longnon for the Société des Anciens Textes (1895-1899). See also Madame Darmesteter (Duclaux), *Froissart* (1894). (W. B.)

FROME, a market town in the Frome parliamentary division of Somersetshire, England, 107 m. W. by S. of London by the Great Western railway. Pop. of urban district (1901) 11,057. It is unevenly built on high ground above the river Frome, which is here crossed by a stone bridge of five arches. It was formerly called Frome or Froome Selwood, after the neighbouring forest of Selwood; and the country round is still richly wooded and picturesque. The parish church of St John the Baptist, with its fine tower and spire, was built about the close of the 14th century, and, though largely restored, has a beautiful chancel, Lady chapel and baptistery. Fragments of Norman work are left; the interior is elaborately adorned with sculptures and stained glass. The market-hall, museum, school of art, and a free grammar school, founded under Edward VI., may be noted among buildings and institutions. The chief industries are brewing and art metal-working, also printing, metal-founding, and the manufacture of cloth, silk, tools and cards for wool-dressing. Dairy farming is largely practised in the neighbourhood. Selwood forest was long a favourite haunt of brigands, and even in the 18th century gave shelter to a gang of coiners and highwaymen.

The Saxon occupation of Frome (From) is the earliest of which there is evidence, the settlement being due to the foundation of a monastery by Aldhelm in 705. A witenagemot was held there in 934, so that Frome must already have been a place of some size. At the time of the Domesday Survey the manor was owned by King William. Local tradition asserts that Frome was a mediæval borough, and the reeve of Frome is occasionally mentioned in documents after the reign of Edward I., but there is no direct evidence that Frome was a borough and no trace of any charter granted to it. It was not represented in parliament until given one member by the Reform Act of 1832. Separate representation ceased in 1885. Frome was never incorporated. A charter of Henry VII. to Edmund Leversedge, then lord of the manor, granted the right to have fairs on the 22nd of July and the 21st of September. In the 18th century two other fairs on the 24th of February and the 25th of November were held. Cattle fairs are now held on the last Wednesday in February and November, and a cheese fair on the last Wednesday in September. The Wednesday market is held under the charter of Henry VII. There is also a Saturday cattle market. The manufacture of woollen cloth has been established since the 15th century, Frome being the only Somerset town in which this staple industry has flourished continuously.

FROMENTIN, EUGÈNE (1820-1876), French painter, was born at La Rochelle in December 1820. After leaving school he studied for some years under Louis Cabat, the landscape painter. Fromentin was one of the earliest pictorial interpreters of Algeria, having been able, while quite young, to visit the land and people that suggested the subjects of most of his works, and to store his memory as well as his portfolio with the picturesque and characteristic details of North African life. In 1840 he obtained a medal of the second class. In 1852 he paid a second visit to Algeria, accompanying an archaeological mission, and then completed that minute study of the scenery of the country and of the habits of its people which enabled him to give to his after-work the realistic accuracy that comes from intimate knowledge. In a certain sense his works are not more artistic results than contributions to ethnological science. His first great success was produced at the Salon of 1847, by the "*Gorges de la Chiffa*." Among his more important works are—"*La Place de la brèche à Constantine*" (1849); "*Euterement*

Maure" (1853); "Bateleurs nègres" and "Audience chez un chahife" (1859); "Berger kabyle" and "Courriers arabes" (1861); "Bivouac arabe," "Chasse au faucon," "Fauconnier arabe" (now at Luxembourg) (1863); "Chasse au héron" (1865); "Voleurs de nuit" (1867); "Centaurus et arabes: aitaqués par une lionne" (1868); "Halte de muletiers" (1869); "Le Nil" and "Un Souvenir d'Esneh" (1875). Fromentin was much influenced in style by Eugène Delacroix. His works are distinguished by striking composition, great dexterity of handling and brilliancy of colour. In them is given with great truth and refinement the unconscious grandeur of barbarian and animal attitudes and gestures. His later works, however, show signs of an exhausted vein and of an exhausted spirit, accompanied or caused by physical enfeeblement. But it must be observed that Fromentin's paintings show only one side of a genius that was perhaps even more felicitously expressed in literature, though of course with less profusion. "Dominique," first published in the *Revue des deux mondes* in 1862, and dedicated to George Sand, is remarkable among the fiction of the century for delicate and imaginative observation and for emotional earnestness. Fromentin's other literary works are—*Visites artistiques* (1852); *Simplex Pélerinages* (1856); *Un Été dans le Sahara* (1857); *Une Année dans le Sahel* (1858); and *Les Maîtres d'autrefois* (1876). In 1876 he was an unsuccessful candidate for the Academy. He died suddenly at La Rochelle on the 27th of August 1876.

FROMMEL, GASTON (1862-1906), Swiss theologian, professor of theology in the university of Geneva from 1894 to 1906. An Alsatian by birth, he belonged mainly to French Switzerland, where he spent most of his life. He may best be described as continuing the spirit of the 19th (q.v.) amid the mental conditions marking the end of the 19th century. Like Vinet, he derived his philosophy of religion from a peculiarly deep experience of the Gospel of Christ as meeting the demands of the moral consciousness; but he developed even further than Vinet the psychological analysis of conscience and the method of verifying every doctrine by direct reference to spiritual experience. Both made much of moral individuality or personality as the crown and criterion of reality, believing that its correlation with Christianity, both historically and philosophically, was most intimate. But while Vinet laid most stress on the liberty from human authority essential to the moral consciousness, the changed needs of the age caused Frommel to develop rather the aspect of man's dependence as a moral being upon God's spiritual initiative, "the conditional nature of his liberty." "Liberty is not the primary, but the secondary characteristic" of conscience; "before being free, it is the subject of obligation." On this depends its objectivity as a real revelation of the Divine Will. Thus he claimed that a deeper analysis carried one beyond the human subjectivity of even Kant's categorical imperative, since consciousness of obligation was "une expérience imposée sous le mode de l'absolu." By his use of *imposée* Frommel emphasized the priority of man's sense of obligation to his consciousness either of self or of God. Here he appealed to the current psychology of the subconscious for confirmation of his analysis, by which he claimed to transcend mere intellectualism. In his language on this fundamental point he was perhaps too jealous of admitting an ideal element as implicit in the feeling of obligation. Still he did well in insisting on priority to self-conscious thought as a mark of metaphysical objectivity in the case of moral, no less than of physical experience. Further, he found in the Christian revelation the same characteristics as belonged to the universal revelation involved in conscience, viz. God's sovereign initiative and his living action in history. From this standpoint he argued against a purely psychological type of religion (*agnosticisme religieux*, as he termed it)—a tendency to which he saw even in A. Sabatier and the *symbolisme* of the Paris School—as giving up a real and unifying faith. His influence on men, especially the student class, was greatly enhanced by the religious force and charm of his personality. Finally, like Vinet, he was a man of letters and a penetrating critic of men and systems.

LITERATURE.—G. Godet, *Gaston Frommel* (Neuchâtel, 1906), a compact sketch, with full citation of sources; cf. H. Bois, in *Sainte-Croix* for 1906, for "L'Étudiant et le professeur." A complete edition of his writings was begun in 1907. (J. V. B.)

FRONDE, THE, the name given to a civil war in France which lasted from 1648 to 1652, and to its sequel, the war with Spain in 1653-59. The word means a sling, and was applied to this contest from the circumstance that the windows of Cardinal Mazarin's adherents were pelted with stones by the Paris mob. Its original object was the redress of grievances, but (the movement soon degenerated into a factional contest among the nobles, who sought to reverse the results of Richelieu's work and to overthrow his successor Mazarin. In May 1648 a tax levied on judicial officers of the parlement of Paris was met by that body, not merely with a refusal to pay, but with a condemnation of earlier financial edicts, and even with a demand for the acceptance of a scheme of constitutional reforms framed by a committee of the parlement. This charter was somewhat influenced by contemporary events in England. But there is no real likeness between the two revolutions, the French parlement being no more representative of the people than the Inns of Court were in England. The political history of the time is dealt with in the article FRANCE: *History*, the present article being concerned chiefly with the military operations of what was perhaps the most costly and least necessary civil war in history.

The military record of the first or "parliamentary" Fronde is almost blank. In August 1648, strengthened by the news of Condé's victory at Lens, Mazarin suddenly arrested the leaders of the parlement, whereupon Paris broke into insurrection and barricaded the streets. The court, having no army at its immediate disposal, had to release the prisoners and to promise reforms, and fled from Paris on the night of the 22nd of October. But the signing of the peace of Westphalia set free Condé's army, and by January 1649 it was besieging Paris. The peace of Rueil was signed in March, after little blood had been shed. The Parisians, though still and always anti-cardinalist, refused to ask for Spanish aid, as proposed by their princely and noble adherents, and having no prospect of military success without such aid, submitted and received concessions. Thenceforward the Fronde becomes a story of sordid intrigues and half-hearted warfare, losing all trace of its first constitutional phase. The leaders were discontented princes and nobles—Monsieur (Gaston of Orléans, the king's uncle), the great Condé and his brother Conti, the duc de Bouillon and his brother Turenne. To these must be added Gaston's daughter, Mademoiselle de Montpensier (La grande Mademoiselle), Condé's sister, Madame de Longueville, Madame de Chevreuse, and the astute intriguer Paul de Gondi, later Cardinal de Retz. The military operations fell into the hands of war-experienced mercenaries, led by two great, and many second-rate, generals, and of nobles to whom war was a polite pastime. The feelings of the people at large were enlisted on neither side.

This peace of Rueil lasted until the end of 1649. The princes, received at court once more, renewed their intrigues against Mazarin, who, having come to an understanding with Monsieur, Gondi and Madame de Chevreuse, suddenly arrested Condé, Conti and Longueville (January 14, 1650). The war which followed this *coup* is called the "Princes' Fronde." This time it was Turenne, before and afterwards the most loyal soldier of his day, who headed the armed rebellion. Listening to the promptings of his Egeria, Madame de Longueville, he resolved to rescue her brother, his old comrade of Freiburg and Nördlingen. It was with Spanish assistance that he hoped to do so; and a powerful army of that nation assembled in Artois under the archduke Leopold, governor-general of the Spanish Netherlands. But the peasants of the country-side rose against the invaders, the royal army in Champagne was in the capable hands of César de Choiseul, comte du Plessis-Praslin, who counted fifty-two years of age and thirty-six of war experience, and the little fortress of Guise successfully resisted the archduke's attack. Thereupon, however, Mazarin drew upon Plessis-Praslin's army

for reinforcements to be sent to subdue the rebellion in the south, and the royal general had to retire. Then, happily for France, the archduke decided that he had spent sufficient of the king of Spain's money and men in the French quarrel. The magnificent regular army withdrew into winter quarters, and left Turenne to deliver the princes with a motley host of Frondeurs and Lorrainers. Plessis-Praslin by force and bribery secured the surrender of Bethel on the 13th of December 1650, and Turenne, who had advanced to relieve the place, fell back hurriedly. But he was a terrible opponent, and Plessis-Praslin and Mazarin himself, who accompanied the army, had many misgivings as to the result of a lost battle. The marshal chose nevertheless to force Turenne to a decision, and the battle of Blanc-Champ (near Somme-Py) or Bethel was the consequence. Both sides were at a standstill in strong positions, Plessis-Praslin doubtful of the trustworthiness of his cavalry, Turenne too weak to attack, when a dispute for precedence arose between the *Gardes françaises* and the *Picardie* regiment. The royal infantry had to be rearranged in order of regimental seniority, and Turenne, seeing and desiring to profit by the attendant disorder, came out of his stronghold and attacked with the greatest vigour. The battle (December 15, 1650) was severe and for a time doubtful, but Turenne's Frondeurs gave way in the end, and his army, as an army, ceased to exist. Turenne himself, undecieved as to the part he was playing in the drama, asked and received the young king's pardon, and meantime the court, with the *maison du roi* and other loyal troops, had subdued the minor risings without difficulty (March-April 1651). Condé, Conti and Longueville were released, and by April 1651 the rebellion had everywhere collapsed. Then followed a few months of hollow peace and the court returned to Paris. Mazarin, an object of hatred to all the princes, had already retired into exile. "Le temps est un galant homme," he remarked, "laissons le faire!" and so it proved. His absence left the field free for mutual jealousies, and for the remainder of the year anarchy reigned in France. In December 1651 Mazarin returned with a small army. The war began again, and this time Turenne and Condé were pitted against one another. After the first campaign, as we shall see, the civil war ceased, but for several other campaigns the two great soldiers were opposed to one another, Turenne as the defender of France, Condé as a Spanish invader. Their personalities alone give threads of continuity to these seven years of wearisome manœuvres, sieges and combats, though for a right understanding of the causes which were to produce the standing armies of the age of Louis XIV. and Frederick the Great the military student should search deeply into the material and moral factors that here decided the issue.

The début of the new Frondeurs took place in Guyenne (February-March 1652), while their Spanish ally, the archduke Leopold William, captured various northern fortresses. On the Loire, whither the centre of gravity was soon transferred, the Frondeurs were commanded by intiguers and quarrelsome lords, until Condé's arrival from Guyenne. His bold trenchant leadership made itself felt in the action of Bléneau (7th April 1652), in which a portion of the royal army was destroyed, but fresh troops came up to oppose him, and from the skillful dispositions made by his opponents Condé felt the presence of Turenne and broke off the action. The royal army did likewise. Condé invited the commander of Turenne's rearguard to supper, chafed him unmercifully for allowing the prince's men to surprise him in the morning, and by way of farewell remarked to his guest, "Quel dommage que des braves gens comme nous se coupent la gorge pour un faquin"—an incident and a remark that thoroughly justify the iron-handed absolutism of Louis XIV. There was no hope for France while tournaments on a large scale and at the public's expense were fashionable amongst the *grands seigneurs*. After Bléneau both armies marched to Paris to negotiate with the parlement, de Retz and Mlle de Montpensier, while the archduke took more fortresses in Flanders, and Charles IV., duke of Lorraine, with an army of plundering mercenaries, *marched through Champagne to join Condé*. As to the latter, *Turenne manœuvred past Condé and planted himself in front*

of the mercenaries, and their leader, not wishing to expend his men against the old French regiments, consented to depart with a money payment and the promise of two tiny Lorraine fortresses. A few more manœuvres, and the royal army was able to hem in the Frondeurs in the Faubourg St Antoine (2nd July 1652) with their backs to the closed gates of Paris. The royalists attacked all along the line and won a signal victory in spite of the knightly prowess of the prince and his great lords, but at the critical moment Gaston's daughter persuaded the Parisians to open the gates and to admit Condé's army. She herself turned the guns of the Bastille on the pursuers. An insurrectional government was organized in the capital and proclaimed Monsieur lieutenant-general of the realm. Mazarin, feeling that public opinion was solidly against him, left France again, and the bourgeois of Paris, quarrelling with the princes, permitted the king to enter the city on the 21st of October 1652. Mazarin returned unopposed in February 1653.

The Fronde as a civil war was now over. The whole country, wearied of anarchy and disgusted with the princes, came to look to the king's party as the party of order and settled government, and thus the Fronde prepared the way for the absolutism of Louis XIV. The general war continued in Flanders, Catalonia and Italy wherever a Spanish and a French garrison were face to face, and Condé with the wreck of his army openly and definitely entered the service of the king of Spain. The "Spanish Fronde" was almost purely a military affair and, except for a few outstanding incidents, a dull affair to boot. In 1653 France was so exhausted that neither invaders nor defenders were able to gather supplies to enable them to take the field till July. At one moment, near Péronne, Condé had Turenne at a serious disadvantage, but he could not galvanize the Spanish general Count Fuensaldana, who was more solicitous to preserve his master's soldiers than to establish Condé as mayor of the palace to the king of France, and the armies drew apart again without fighting. In 1654 the principal incident was the siege and relief of Arras. On the night of the 24th-25th August the lines of circumvallation drawn round that place by the prince were brilliantly stormed by Turenne's army, and Condé won equal credit for his safe withdrawal of the besieging corps under cover of a series of bold cavalry charges led by himself as usual, sword in hand. In 1655 Turenne captured the fortresses of Landrecies, Condé and St Ghislain. In 1656 the prince of Condé revenged himself for the defeat of Arras by storming Turenne's circumvallation around Valenciennes (16th July), but Turenne drew off his forces in good order. The campaign of 1657 was uneventful, and is only to be remembered because a body of 6000 British infantry, sent by Cromwell in pursuance of his treaty of alliance with Mazarin, took part in it. The presence of the English contingent and its very definite purpose of making Dunkirk a new Calais, to be held by England for ever, gave the next campaign a character of certainty and decision which is entirely wanting in the rest of the war. Dunkirk was besieged promptly and in great force, and when Don Juan of Austria and Condé appeared with the relieving army from Fumes, Turenne advanced boldly to meet him. The battle of the Dunes, fought on the 14th of June 1658, was the first real trial of strength since the battle of the Faubourg St Antoine. Successes on one wing were compromised by failure on the other, but in the end Condé drew off with heavy losses, the success of his own cavalry charges having entirely failed to make good the defeat of the Spanish right wing amongst the Dunes. Here the "red-coats" made their first appearance on a continental battlefield, under the leadership of Sir W. Lockhart, Cromwell's ambassador at Paris, and astonished both armies by the stubborn fierceness of their assaults, for they were the products of a war where passions ran higher and the determination to win rested on deeper foundations than in the *dégringolade* of the feudal spirit in which they now figured. Dunkirk fell, as a result of the victory, and the St George's cross till Charles II. sold it to the king of France. A last desultory campaign followed in 1659—the twenty-fifth year of the Franco-Spanish War—and the peace of the Pyrenees was signed on the 5th of November. On the 27th of January

1660 the prince asked and obtained at Aix the forgiveness of Louis XIV. The later careers of Turenne and Condé as the great generals—and obedient subjects—of their sovereign are described in the article **DUTCH WARS**.

For the many memoirs and letters of the time see the list in G. Monod's *Bibliographie de l'histoire de France* (Paris, 1888). The *Lettres du cardinal Mazarin* have been collected in nine volumes (Paris, 1878-1906). See P. Adolphe Chéruel, *Histoire de France pendant la minorité de Louis XIV* (4 vols., 1879-1880), and his *Histoire de France sous le ministère de Mazarin* (3 vols., 1883); L. C. de Beauport de Sainte-Aulaire, *Histoire de la Fronde* (2nd ed., 2 vols., 1860); "Arvède Barine" (Mme Charles Vincens), *La Jeunesse de la grande mademoiselle* (Paris, 1902); Duc d'Aumale, *Histoire des princes de Condé* (Paris, 1889-1896, 7 vols.). The most interesting account of the military operations is in General Hardy de Périni's *Turenne et Condé (Batailles françaises, vol. iv.)*.

FRONTENAC ET PALLUAU, LOUIS DE BUADE, COMTE DE (1620-1698), French-Canadian statesman, governor and lieutenant-general for the French king in *La Nouvelle France* (Canada), son of Henri de Buade, colonel in the regiment of Navarre, was born in the year 1620. The details of his early life are meagre, as no trace of the Frontenac papers has been discovered. The de Buades, however, were a family of distinction in the principality of Béarn. Antoine de Buade, seigneur de Frontenac, grandfather of the future governor of Canada, attained eminence as a councillor of state under Henri IV.; and his children were brought up with the dauphin, afterwards Louis XIII. Louis de Buade entered the army at an early age. In the year 1635 he served under the prince of Orange in Holland, and fought with credit and received many wounds during engagements in the Low Countries and in Italy. He was promoted to the rank of colonel in the regiment of Normandy in 1643, and three years later, after distinguishing himself at the siege of Orbitello, where he had an arm broken, he was made *marchal de camp*. His service seems to have been continuous until the conclusion of the peace of Westphalia in 1648, when he returned to his father's house in Paris and married, without the consent of her parents, Anne de la Grange-Trianon, a girl of great beauty, who later became the friend and confidente of Madame de Montpensier. The marriage was not a happy one, and after the birth of a son incompatibility of temper led to a separation, the count retiring to his estate on the Indre, where by an extravagant course of living he became hopelessly involved in debt. Little is known of his career for the next fifteen years beyond the fact that he held a high position at court; but in the year 1669, when France sent a contingent to assist the Venetians in the defence of Crete against the Turks, Frontenac was placed in command of the troops on the recommendation of Turenne. In this expedition he won military glory; but his fortune was not improved thereby.

At this period the affairs of New France claimed the attention of the French court. From the year 1665 the colony had been successfully administered by three remarkable men—Daniel de Rémy de Courcelle, the governor, Jean Talon, the intendant, and the marquis de Tracy, who had been appointed lieutenant-general for the French king in America; but a difference of opinion had arisen between the governor and the intendant, and each had demanded the other's recall in the public interest. At this crisis in the administration of New France, Frontenac was appointed to succeed de Courcelle. The new governor arrived in Quebec on the 12th of September 1672. From the commencement it was evident that he was prepared to give effect to a policy of colonial expansion, and to exercise an independence of action that did not coincide with the views of the monarch or of his minister Colbert. One of the first acts of the governor, by which he sought to establish in Canada the three estates—nobles, clergy and people—met with the disapproval of the French court, and measures were adopted to curb his ambition by increasing the power of the sovereign council and by reviving the office of intendant. Frontenac, however, was a man of dominant spirit, jealous of authority, prepared to exact obedience from all and to yield to none. In the course of events he soon became involved in quarrels with the intendant touching questions of precedence, and with the ecclesiastics, one or two

of whom ventured to criticize his proceedings. The church in Canada had been administered for many years by the religious orders; for the see of Quebec, so long contemplated, had not yet been erected. But three years after the arrival of Frontenac a former vicar apostolic, François Xavier de Laval de Montmorenci, returned to Quebec as bishop, with a jurisdiction over the whole of Canada. In this redoubtable churchman the governor found a vigorous opponent who was determined to render the state subordinate to the church. Frontenac, following in this respect in the footsteps of his predecessors, had issued trading licences which permitted the sale of intoxicants. The bishop, supported by the intendant, endeavoured to suppress this trade and sent an ambassador to France to obtain remedial action. The views of the bishop were upheld and henceforth authority was divided. Troubles ensued between the governor and the sovereign council, most of the members of which sided with the one permanent power in the colony—the bishop; while the suspicions and intrigues of the intendant, Duchesneau, were a constant source of vexation and strife. As the king and his minister had to listen to and adjudicate upon the appeals from the contending parties their patience was at last worn out, and both governor and intendant were recalled to France in the year 1682. During Frontenac's first administration many improvements had been made in the country. The defences had been strengthened, a fort was built at Cataragui (now Kingston), Ontario, bearing the governor's name, and conditions of peace had been fairly maintained between the Iroquois on the one hand and the French and their allies, the Ottawas and the Hurons, on the other. The progress of events during the next few years proved that the recall of the governor had been ill-timed. The Iroquois were assuming a threatening attitude towards the inhabitants, and Frontenac's successor, La Barre, was quite incapable of leading an army against such cunning foes. At the end of a year La Barre was replaced by the marquis de Denonville, a man of ability and courage, who, though he showed some vigour in marching against the western Iroquois tribes, angered rather than intimidated them, and the massacre of Lachine (5th of August 1689) must be regarded as one of the unhappy results of his administration.

The affairs of the colony were now in a critical condition; a man of experience and decision was needed to cope with the difficulties, and Louis XIV., who was not wanting in sagacity, wisely made choice of the choleric count to represent and uphold the power of France. When, therefore, on the 15th of October 1689, Frontenac arrived in Quebec as governor for the second time, he received an enthusiastic welcome, and confidence was at once restored in the public mind. Quebec was not long to enjoy the blessing of peace. On the 16th of October 1690 several New England ships under the command of Sir William Phipps appeared off the island of Orleans, and an officer was sent ashore to demand the surrender of the fort. Frontenac, bold and fearless, sent a defiant answer to the hostile admiral, and handled so vigorously the forces he had collected as completely to repulse the enemy, who in their hasty retreat left behind a few pieces of artillery on the Beauport shore. The prestige of the governor was greatly increased by this event, and he was prepared to follow up his advantage by an attack on Boston from the sea, but his resources were inadequate for the undertaking. New France now rejoiced in a brief respite from her enemies, and during the interval Frontenac encouraged the revival of the drama at the Château St-Louis and paid some attention to the social life of the colony. The Indians, however, were not yet subdued, and for two years a petty warfare was maintained. In 1696 Frontenac decided to take the field against the Iroquois, although at this time he was seventy-six years of age. On the 6th of July he left Lachine at the head of a considerable force for the village of the Onondagas, where he arrived a month later. In the meantime the Iroquois had abandoned their villages, and as pursuit was impracticable the army commenced its return march on the 10th of August. The old warrior endured the fatigue of the march as well as the youngest soldier, and for his courage and prowess he received the crown of St.

Louis. Frontenac died on the 28th of November 1698 at the Château St-Louis after a brief illness, deeply mourned by the Canadian people. The faults of the governor were those of temperament, which had been fostered by early environment. His nature was turbulent, and from his youth he had been used to command; but underlying a rough exterior there was evidence of a kindly heart. He was fearless, resourceful and decisive, and triumphed as few men could have done over the difficulties and dangers of a most critical position.

See *Count Frontenac*, by W. D. Le Sueur (Toronto, 1906); *Count Frontenac and New France under Louis XIV.*, by Francis Parkman (Boston, 1878); *Le Comte de Frontenac*, by Henri Lorin (Paris, 1895); *Frontenac et ses amis*, by Ernest Myrand (Quebec, 1902).

FRONTINUS, SEXTUS JULIUS (c. A.D. 40-103), Roman soldier and author. In 70 he was city praetor, and five years later was sent into Britain to succeed Petilius Cerealis as governor of that island. He subdued the Silures, and held the other native tribes in check till he was superseded by Agricola (78). In 97 he was appointed superintendent of the aqueducts (*curator aquarum*) at Rome, an office only conferred upon persons of very high standing. He was also a member of the college of augurs. His chief work is *De aquis urbis Romae*, in two books, containing a history and description of the water-supply of Rome, including the laws relating to its use and maintenance, and other matters of importance in the history of architecture. Frontinus also wrote a theoretical treatise on military science (*De re militari*) which is lost. His *Strategematicon libri iiii.* is a collection of examples of military stratagems from Greek and Roman history, for the use of officers; a fourth book, the plan and style of which is different from the rest (more stress is laid on the moral aspects of war, e.g. discipline), is the work of another writer (best edition by G. Gundermann, 1888). Extracts from a treatise on land-surveying ascribed to Frontinus are preserved in Lachmann's *Gromatici veteres* (1848).

A valuable edition of the *De aquis* (text and translation) has been published by C. Herschel (Boston, Mass., 1899). It contains numerous illustrations; maps of the routes of the ancient aqueducts and the city of Rome in the time of Frontinus; a photographic reproduction of the only MS. (the Monte Cassino); several explanatory chapters, and a concise bibliography, in which special reference is made to P. d. Tissot, *Étude sur la condition des arrosementes* (1879). There is a complete edition of the works by A. Dederich (1855), and an English translation of the *Strategematica* by R. Scott (1816).

FRONTISPIECE (through the French, from Med. Lat. *frontispicium*, a front view, *frons*, *frontis*, forehead or front, and *specere*, to look at; the English spelling is a mistaken adaptation to "piece"), an architectural term for the principal front of a building, but more generally applied to a richly decorated entrance doorway, if projecting slightly only in front of the main wall, otherwise portal or porch would be a more correct term. The word, however, is more used for a decorative design or the representation of some subject connected with the substance of a book and placed as the first illustrated page. A design at the end of the chapter of a book is called a tail-piece.

FRONTUS, MARCUS CORNELIUS (c. A.D. 100-170), Roman grammarian, rhetorician and advocate, was born of an Italian family at Ciria in Numidia. He came to Rome in the reign of Hadrian, and soon gained such renown as an advocate and orator as to be reckoned inferior only to Cicero. He amassed a large fortune, erected magnificent buildings and purchased the famous gardens of Maecenas. Antoninus Pius, hearing of his fame, appointed him tutor to his adopted sons Marcus Aurelius and Lucius Verus. In 143 he was consul for two months, but declined the proconsulship of Asia on the ground of ill-health. His latter years were embittered by the loss of all his children except one daughter. His talents as an orator and rhetorician were greatly admired by his contemporaries, a number of whom formed themselves into a school called after him Frontoniani, whose avowed object it was to restore the ancient purity and simplicity of the Latin language in place of the exaggerations of the Greek sophistical school. However praiseworthy the intention may have been, the list of authors specially recommended

does not speak well for Fronto's literary taste. The authors of the Augustan age are unduly depreciated, while Ennius, Plautus, Laberius, Sallust are held up as models of imitation. Till 1815 the only extant works ascribed (erroneously) to Fronto were two grammatical treatises, *De nominum verborumque differentiiis* and *Exempla elocutionum* (the last being really by Arrianus Messius). In that year, however, Angelo Mai discovered in the Ambrosian library at Milan a palimpsest manuscript (and, later, some additional sheets of it in the Vatican), on which had been originally written some of Fronto's letters to his royal pupils and their replies. These palimpsests had originally belonged to the famous convent of St Columba at Bobbio, and had been written over by the monks with the acts of the first council of Chalcedon. The letters, together with the other fragments in the palimpsest, were published at Rome in 1823. Their contents falls far short of the writer's great reputation. The letters consist of correspondence with Antoninus Pius, Marcus Aurelius and Lucius Verus, in which the character of Fronto's pupils appears in a very favourable light, especially in the affection they both seem to have retained for their old master; and letters to friends, chiefly letters of recommendation. The collection also contains treatises on eloquence, some historical fragments, and literary trifles on such subjects as the praise of smoke and dust, of negligence, and a dissertation on Anon. "His style is a laborious mixture of archaisms, a motley cento, with the aid of which he conceals the poverty of his knowledge and ideas." His chief merit consists in having preserved extracts from ancient writers which would otherwise have been lost.

The best edition of his works is by S. A. Naber (1867), with an account of the palimpsest; see also G. Boissier, "Marc Aurèle et les lettres de F." in *Revue des deux mondes* (April 1868); R. Ellis, in *Journal of Philology* (1868) and *Correspondence of Fronto and M. Aurelius* (1904); and the full bibliography in the article by Brzoska in the new edition of Pauly's *Realencyclopädie der classischen Altertumswissenschaft*, iv. pt. i. (1900).

FROSINONE (anc. *Frusino*), a town of Italy in the province of Rome, from which it is 53 m. E.S.E. by rail. Pop. (1901) town, 9530; commune, 11,029. The place is picturesquely situated on a hill of 955 ft. above sea-level, but contains no buildings of interest. Of the ancient city walls a small fragment alone is preserved, and no other traces of antiquity are visible, not even of the amphitheatre which it once possessed, for which a ticket (*testera*) has been found (Th. Mommsen in *Ber. d. Sächsischen Gesellschaft d. Wissenschaften*, 1840, 286). It was a Volscian, not a Hernican, town; a part of its territory was taken from it about 306-303 B.C. by the Romans and sold. The town then became a *praefectura*, probably with the *civitas sine suffragio*, and later a colony, but we hear nothing important of it. It was situated just above the Via Latina. (T. As.)

FROSSARD, CHARLES AUGUSTE (1807-1875), French general, was born on the 26th of April 1807, and entered the army from the École Polytechnique in 1827, being posted to the engineers. He took part in the siege of Rome in 1849 and in that of Sebastopol in 1855, after which he was promoted general of brigade. Four years later as general of division, and chief of engineers in the Italian campaign, he attracted the particular notice of the emperor Napoleon III., who made him in 1867 chief of his military household and governor to the prince imperial. He was one of the superior military authorities who in this period 1866-1870 foresaw and endeavoured to prepare for the inevitable war with Germany, and at the outbreak of war he was given by Napoleon the choice between a corps command and the post of chief engineer at headquarters. He chose the command of the II. corps. On the 6th of August 1870 he held the position of Spicheren against the Germans until the arrival of reinforcements for the latter, and the non-appearance of the other French corps compelled him to retire. After this he took part in the battles around Metz, and was involved with his corps in the surrender of Bazaine's army. General Frossard published in 1872 a *Rapport sur les opérations du 2^e corps*. He died at Château-Villain (Haute-Marne) on the 25th of August 1875.

FROST, WILLIAM EDWARD (1810-1877), English painter, was born at Wandsworth, near London, in September 1810. About

1825, through William Etty, R.A., he was sent to a drawing school in Bloomsbury, and after several years' study there, and in the sculpture rooms at the British Museum, Frost was in 1829 admitted as a student in the schools of the Royal Academy. He won medals in all the schools, except the antique, in which he was beaten by MacIise. During those years he maintained himself by portrait-painting. He is said to have painted about this time over 300 portraits. In 1839 he obtained the gold medal of the Royal Academy for his picture of "Prometheus bound by Force and Strength." At the cartoon exhibition at Westminster Hall in 1843 he was awarded a third-class prize of £100 for his cartoon of "Una alarmed by Fauns and Satyrs." He exhibited at the Academy "Christ crowned with Thorns" (1843), "Nymphs dancing" (1844), "Sabrina" (1845), "Diana and Actaeon" (1846). In 1846 he was elected Associate of the Royal Academy. His "Nymph disarming Cupid" was exhibited in 1847; "Una and the Wood-Nymphs" of the same year was bought by the queen. This was the time of Frost's highest popularity, which considerably declined after 1850. His later pictures are simply repetitions of earlier motives. Among them may be named "Euphrosyne" (1848), "Wood-Nymphs" (1851), "Chastity" (1854), "Il Penseroso" (1855), "The Graces" (1856), "Narcissus" (1857), "Zephyr with Aurora playing" (1858), "The Graces and Loves" (1863), "Hylas and the Nymphs" (1867). Frost was elected to full membership of the Royal Academy in December 1871. This dignity, however, he soon resigned. Frost had no high power of design, though some of his smaller and apparently less important works are not without grace and charm. Technically, his paintings are, in a sense, very highly finished, but they are entirely without mastery. He died on the 4th of June 1877.

FROST (a common Teutonic word, cf. Dutch, *vorst*, Ger. *Frost*, from the common Teutonic verb meaning "to freeze," Dutch, *wiezen*, Ger. *frieren*); the Indo-European root is seen in Lat. *primo*, hoar-frost, cf. *prurire*, to itch, burn, *pruna*, burning coal, Sansk. *prush*, to burn), in meteorology, the act, or agent of the process, of freezing; hence the terms "hoar-frost" and "white-frost" applied to visible frozen vapour formed on exposed surfaces. A frost can only occur when the surface temperature falls below 32° F., the freezing-point of water; if the temperature be between 28° and 32° it is a "light frost," if below 28° it is a "heavy," "killing" or "black frost"; the term "black frost" is also used when no hoar-frost is present. The number of degrees below freezing-point is termed "degrees of frost." As soon as a mass of air is cooled to its dew-point, water begins to be precipitated in the form of rain, dew, snow or hail. Hoar-frost is only formed at the immediate surface of the land if the latter be at a temperature below 32°, and this may occur even when the temperature of the air a few feet above the ground is 12°-16° above the freezing-point. The heaviest hoar-frosts are formed under weather conditions similar to those under which the heaviest summer dews occur, namely, clear and calm nights, when there is no cloud to impede the radiation of heat from the surface of the land, which thereby becomes rapidly and completely cooled. The danger of frost is minimized when the soil is very moist, as for example after 10-12 mm. of rain; and it is a practice in America to flood fields on the receipt of a frost warning, radiation being checked by the light fog sheets which develop over moist soils, just as a cloud-layer in the upper atmosphere impedes radiation on a grand scale. A layer of smoke will also impede radiation locally, and to this end smoky fires are sometimes lit in such positions that the smoke may drift over planted ground which it is desirable to preserve from frost. Similarly, frost may occur in open country when a town, protected by its smoke-cloud above, is free of it. In a valley with fairly high and steep flanks frost sometimes occurs locally at the bottom, because the layer of air cooled by contact with the cold surface of the higher ground is heavier than that not so cooled, and therefore tends to flow or settle downwards along the slope of the land. When meteorological considerations point to a frost, an estimate of the night temperature may be obtained by multiplying the difference between the readings of the wet

and dry bulb thermometer by 2.5 and subtracting the result from the dry bulb temperature. This rule applies when the evening air is at about 50° and 30-1-in. pressure, the sky being clear. An instrument has been devised in France for the prediction of frost. It consists of a wet bulb and a dry bulb thermometer, mounted on a board on which is also a scale of lines corresponding to degrees of the dry bulb, and a pointer traversing a scale graduated according to degrees of the wet bulb. Observations for the night are taken about half an hour before sunset. By means of the pointer and scale, the point may be found at which the line of the dry-bulb reading meets the pointer set to the reading of the wet bulb. The scale is further divided by colours so that the observed point may fall within one of three zones, indicating certain frost, probable frost or no-probability of frost.

FROSTBITE, a form of mortification (*q.v.*), due to the action of extreme cold in cutting off the blood-supply from the fingers, toes, nose, ears, &c. In comparatively trifling forms it occurs as "chaps" and "chilblains," but the term frostbite is usually applied only to more severe cases, where the part affected becomes in danger of gangrene. An immediate application of snow, or ice-water, will restore the circulation; the application of heat would cause inflammation. But if the mortification has gone too far for the circulation to be restored, the part will be lost, and surgical treatment may be necessary.

FROSTBURG, a town of Allegany county, Maryland, U.S.A., 11 m. W. of Cumberland. Pop. (1890) 3804; (1900) 5274 (578 foreign-born and 236 negroes); (1910) 6028. It is served by the Cumberland & Pennsylvania railway and the Cumberland & Westernport electric railway. The town is about 2000 ft. above sea-level on a plateau between the Great Savage and Dana mountains, and its delightful scenery and air have made it attractive as a summer resort. It is the seat of the second state normal school, opened in 1904. Frostburg is in the midst of the coal region of the state, and is itself almost completely undermined; it has planing mills and manufactures large quantities of fire-brick. The municipality owns and operates its water-works. Natural gas is piped to Frostburg from the West Virginia fields, 120 m. away. Frostburg was first settled in 1812; was called Mount Pleasant until about 1830, when the present name was substituted in honour of Meshech Frost, one of the town's founders; and was incorporated in 1870.

FROTHINGHAM, OCTAVIUS BROOKS (1822-1895), American clergyman and author, was born in Boston on the 26th of November 1822, son of Nathaniel Langdon Frothingham (1793-1870), a prominent Unitarian preacher of Boston, and through his mother's family related to Phillips Brooks. He graduated from Harvard College in 1843 and from the Divinity School in 1846. He was pastor of the North Unitarian church of Salem, Massachusetts, in 1847-1855. From 1855 to 1860 he was pastor of a new Unitarian society in Jersey City, where he gave up the Lord's Supper, thinking that it ministered to self-satisfaction; and it was as a radical Unitarian that he became pastor of another young church in New York City in 1860. Indeed in 1864 he was recognized as leader of the radicals after his reply to Dr Hedge's address to the graduating students of the Divinity School on *Anti-Supernaturalism in the Pulpit*. In 1865, when he had practically given up "transcendentalism," his church building was sold and his congregation began to worship in Lyric Hall under the name of the Independent Liberal Church; in 1875 they removed to the Masonic Temple, but four years later ill-health compelled Frothingham's resignation, and the church dissolved. Paralysis threatened him and he never fully recovered his health; in 1881 he returned to Boston, where he died on the 27th of November 1895. To this later period of his life belongs his best literary work. While he was in New York he was for a time art critic of the *Tribune*. Always himself on the unpopular side and an able but thoroughly fair critic of the majority, he habitually under-estimated his own worth; he was not only an anti-slavery leader when abolition was not popular even in New England, and a radical and rationalist when it was impossible for him to stay conveniently in the Unitarian Church, but he

was the first president of the National Free Religious Association (1867) and an early and ardent disciple of Darwin and Spencer. To his radical views he was always faithful. It is a mistake to say that he grew more conservative in later years; but his judgment grew more generous and catholic. He was a greater orator than man of letters, and his sermons in New York were delivered to large audiences, averaging one thousand at the Masonic Temple, and were printed each week; in eloquence and in the charm of his spoken word he was probably surpassed in his day by none save George William Curtis. Personally he seemed cold and distant, partly because of his impressive appearance, and partly because of his own modesty, which made him backward in seeking friendships.

His principal published works are: *Stories from the Life of the Teacher* (1863), *A Child's Book of Religion* (1866), and other works of religious teaching for children; several volumes of sermons: *Beliefs of Unbelievers* (1876), *The Cradle of the Christ: a Study in Primitive Christianity* (1877), *The Spirit of New Faith* (1877), *The Rising and the Setting Faith* (1878), and other expositions of the "new faith" he preached; *Life of Theodore Parker* (1874), *Transcendentalism in New England* (1876), which is largely biographical, *Gerrit Smith, a Biography* (1878), *George Ripley* (1882), in the "American Men of Letters" series, *Memoir of William Henry Channing* (1886), *Boston Unitarianism, 1820-1850* (1890), really a biography of his father; and *Recollections and Impressions, 1822-1890* (1891).

FROUDE, JAMES ANTHONY (1818-1894), English historian, son of R. H. Froude, archdeacon of Totnes, was born at Dartington, Devon, on the 23rd of April 1818. He was educated at Westminster and Oriel College, Oxford, then the centre of the ecclesiastical revival. He obtained a second class and the chancellor's English essay prize, and was elected a fellow of Exeter College (1842). His elder brother, Richard Hurrell Froude (1803-1836), had been one of the leaders of the High Church movement at Oxford. Froude joined that party and helped J. H. Newman, afterwards cardinal, in his *Lives of the English Saints*. He was ordained deacon in 1845. By that time his religious opinions had begun to change, he grew dissatisfied with the views of the High Church party, and came under the influence of Carlyle's teaching. Signs of this change first appeared publicly in his *Shadows of the Clouds*, a volume containing two stories of a religious sort, which he published in 1847 under the pseudonym of "Zeta," and his complete desertion of his party was declared a year later in his *Nemesis of Faith*, an heretical and unpleasant book, of which the earlier part seems to be autobiographical.

On the demand of the college he resigned his fellowship at Oxford, and mainly at least supported himself by writing, contributing largely to *Fraser's Magazine* and the *Westminster Review*. The excellence of his style was soon generally recognized. The first two volumes of his *History of England from the Fall of Wolsey to the Defeat of the Spanish Armada* appeared in 1856, and the work was completed in 1870. As an historian he is chiefly remarkable for literary excellence, for the art with which he represents his conception of the past. He condemns a scientific treatment of history and disregards its philosophy. He held that its office was simply to record human actions and that it should be written as a drama. Accordingly he gives prominence to the personal element in history. His presentations of character and motives, whether truthful or not, are undeniably fine; but his doctrine that there should be "no theorizing" about history tended to narrow his survey, and consequently he sometimes, as in his remarks on the foreign policy of Elizabeth, seems to misapprehend the tendencies of a period on which he is writing.

Froude's work is often marred by prejudice and incorrect statements. He wrote with a purpose. The keynote of his *History* is contained in his assertion that the Reformation was "the root and source of the expansive force which has spread the Anglo-Saxon race over the globe." Hence he overpraises Henry VIII. and others who forwarded the movement, and speaks too harshly of some of its opponents. So too, in his *English in Ireland* (1872-1874), which was written to show the futility of attempts to conciliate the Irish, he aggravates all

that can be said against the Irish, touches too lightly on English atrocities, and writes unjustly of the influence of Roman Catholicism. A strong anti-clerical prejudice is manifest in his historical work generally, and is doubtless the result of the change in his views on Church matters and his abandonment of the clerical profession. Carlyle's influence on him may be traced both in his admiration for strong rulers and strong government, which led him to write as though tyranny and brutality were excusable, and in his independent treatment of character. His rehabilitation of Henry VIII. was a useful protest against the idea that the king was a meresanguinary profligate, but his representation of him as the self-denying minister of his people's will is erroneous, and is founded on the false theory that the preambles of the acts of Henry's parliaments represented the opinions of the educated laymen of England. As an advocate he occasionally forgets that sobriety of judgment and expression become an historian. He was not a judge of evidence, and seems to have been unwilling to admit the force of any argument or the authority of any statement which militated against his case. In his *Divorce of Catherine of Aragon* (1891) he made an unfortunate attempt to show that certain fresh evidence on the subject, brought forward by Dr Gairdner, Dr Friedmann and others, was not inconsistent with the views which he had expressed in his *History* nearly forty years before. He worked diligently at original manuscript authorities at Simancas, the Record Office and Hatfield House; but he used his materials carelessly, and evidently brought to his investigation of them a mind already made up as to their significance. His *Life of Caesar* (1879), a glorification of imperialism, betrays an imperfect acquaintance with Roman politics and the life of Cicero; and of his two pleasant books of travel, *The English in the West Indies* (1888) shows that he made little effort to master his subject, and *Oceana* (1886), the record of a tour in Australia and New Zealand, among a multitude of other blunders, notes the prosperity of the working-classes in Adelaide at the date of his visit, when, in fact, owing to a failure in the wheat-crop, hundreds were then living on charity. He was constitutionally inaccurate, and seems to have been unable to represent the exact sense of a document which lay before him, or even to copy from it correctly. Historical scholars ridiculed his mistakes, and Freeman, the most violent of his critics, never let slip a chance of hitting at him in the *Saturday Review*. Froude's temperament was sensitive, and he suffered from these attacks, which were often unjust and always too savage in tone. The literary quarrel between him and Freeman excited general interest when it blazed out in a series of articles which Freeman wrote in the *Contemporary Review* (1878-1879) on Froude's *Short Study of Thomas Becket*.

Notwithstanding its defects, Froude's *History* is a great achievement; it presents an important and powerful account of the Reformation period in England, and lays before us a picture of the past magnificently conceived, and painted in colours which will never lose their freshness and beauty. As with Froude's work generally, its literary merit is remarkable; it is a well-balanced and orderly narrative, coherent in design and symmetrical in execution. Though it is perhaps needlessly long, the thread of the story is never lost amid a crowd of details; every incident is made subordinate to the general idea, appear in its appropriate place, and contributes its share to the perfection of the whole. The excellence of its form is matched by the beauty of its style, for Froude was a master of English prose. The most notable characteristic of his style is its graceful simplicity; it is never affected or laboured; his sentences are short and easy, and follow one another naturally. He is always lucid. He was never in doubt as to his own meaning, and never at a loss for the most appropriate words in which to express it. Simple as his language is, it is dignified and worthy of its subject. Nowhere perhaps does his style appear to more advantage than in his four series of essays entitled *Short Studies on Great Subjects* (1867-1882), for it is seen there unfettered by the obligations of narrative. Yet his narrative is admirably told. For the most part flowing easily along, it rises on fit occasions to splendour, picturesque beauty or pathos. Few more brilliant pieces of historical

writing exist than his description of the coronation procession of Anne Boleyn through the streets of London, few more full of picturesque power than that in which he relates how the spire of St Paul's was struck by lightning; and to have once read is to tremble for ever the touching and stately words in which he compares the monks of the London Charterhouse preparing for death with the Spartans at Thermopylae. Proofs of his power in the sustained narration of stirring events are abundant; his treatment of the Pilgrimage of Grace, of the sea fight at St Helens and the repulse of the French invasion, and of the murder of Rizzio, are among the most conspicuous examples of it. Nor is he less successful when recording pathetic events, for his stories of certain martyrdoms, and of the execution of Mary queen of Scots, are told with exquisite feeling and in language of well-restrained emotion. And his characters are alive. We may not always agree with his portraiture, but the men and women whom he saw exist for us instinct with the life with which he endows them and animated by the motives which he attributes to them. His successes must be set against his failures. At the least he wrote a great history, one which can never be disregarded by future writers on his period, be their opinions what they may; which attracts and delights a multitude of readers, and is a splendid example of literary form and grace in historical composition.

The merits of his work met with full recognition. Each instalment of his *History*, in common with almost everything which he wrote, was widely read, and in spite of some adverse criticisms was received with eager applause. In 1868 he was elected rector of St Andrews University, defeating Disraeli by a majority of fourteen. He was warmly welcomed in the United States, which he visited in 1872, but the lectures on Ireland which he delivered there caused much dissatisfaction. On the death of his adversary Freeman in 1892, he was appointed, on the recommendation of Lord Salisbury, to succeed him as regius professor of modern history at Oxford. Except to a few Oxford men, who considered that historical scholarship should have been held to be a necessary qualification for the office, his appointment gave general satisfaction. His lectures on Erasmus and other 16th-century subjects were largely attended. With some allowance for the purpose for which they were originally written, they present much the same characteristics as his earlier historical books. His health gave way in the summer of 1894, and he died on the 20th of October.

His long life was full of literary work. Besides his labours as an author, he was for fourteen years editor of *Fraser's Magazine*. He was one of Carlyle's literary executors, and brought some sharp criticism upon himself by publishing Carlyle's *Reminiscences* and the *Memorials of Jane Welsh Carlyle*, for they exhibited the domestic life and character of his old friend in an unpleasant light. Carlyle had given the manuscripts to him, telling him that he might publish them if he thought it well to do so, and at the close of his life agreed to their publication. Froude therefore declared that in giving them to the world he was carrying out his friend's wish by enabling him to make a posthumous confession of his faults. Besides publishing these manuscripts he wrote a *Life of Carlyle*. His earlier study of Irish history afforded him suggestions for a historical novel entitled *The Two Chiefs of Dunboy* (1886). In spite of one or two stirring scenes it is a tedious book, and its personages are little more than machines for the enunciation of the author's opinions and sentiments. Though Froude had some intimate friends he was generally reserved. When he cared to please, his manners and conversation were charming. Those who knew him well formed a high estimate of his ability in practical affairs. In 1874 Lord Carnarvon, then colonial secretary, sent Froude to South Africa to report on the best means of promoting a confederation of its colonies and states, and in 1875 he was again sent to the Cape as a member of a proposed conference to further confederation. Froude's speeches in South Africa were rather injudicious, and his mission was a failure (see SOUTH AFRICA: *History*). He was twice married. His first wife, a

daughter of Pascoe Grenfell and sister of Mrs Charles Kingsley; died in 1860; his second, a daughter of John Warre, M.P. for Taunton, died in 1874.

Froude's *Life*, by Herbert Paul, was published in 1905. (W. Hu.)

FRUCTOSE, LAEVULOSE, or FRUIT-SUGAR, a carbohydrate of the formula $C_6H_{12}O_6$. It is closely related to ordinary *d*-glucose, with which it occurs in many fruits, starches and also in honey. It is a hydrolytic product of inulin, from which it may be prepared; but it is more usual to obtain it from "invert sugar," the mixture obtained by hydrolysing cane sugar with sulphuric acid. Cane sugar then yields a syrupy mixture of glucose and fructose, which, having been freed from the acid and concentrated, is mixed with water, cooled in ice and calcium hydroxide added. The fructose is precipitated as a saccharate, which is filtered, suspended in water and decomposed by carbon dioxide. The liquid is filtered, the filtrate concentrated, and the syrup so obtained washed with cold alcohol. On cooling the fructose separates. It may be obtained as a syrup, as fine, silky needles, a white crystalline powder, or as a granular crystalline, somewhat hygroscopic mass. When anhydrous it melts at about $95^{\circ}C$. It is readily soluble in water and in dilute alcohol, but insoluble in absolute alcohol. It is sweeter than cane sugar and is more easily assimilated. It has been employed under the name diabetin as a sweetening agent for diabetics, since it does not increase the sugar-content of the urine; other medicinal applications are in phthisis (mixed with quassia or other bitter), and for children suffering from tuberculosis or scrofula in place of cane sugar or milk-sugar.

Chemically, fructose is an oxyketone or ketose, its structural formula being $CH_2OH \cdot (CH_2OH)_2 \cdot CO \cdot CH_2OH$; this result followed from its conversion by H. Killian into methylbutylacetic acid. The form described above is *laevo*-rotatory, but it is termed *d*-fructose, since it is related to *d*-glucose. Solutions exhibit mutarotation, fresh solutions having a specific rotation of -104.0° , which gradually diminishes to -92° . It was synthesized by Emil Fischer, who found the synthetic sugar which he named *α*-acrose to be (*d*-*l*)-fructose, and by splitting this mixture he obtained both the *d* and *l* forms. Fructose resembles *d*-glucose in being fermentable by yeast (it is the one ketose which exhibits this property), and also in its power of reducing alkaline copper and silver solutions; this latter property is assigned to the readiness with which hydroxyl and ketone groups in close proximity suffer oxidation. For the structural (stereochemical) relations of fructose see SUGAR.

FRUGONI, CARLO INNOCENZIO MARIA (1692-1768), Italian poet, was born at Genoa on the 21st of November 1692. He was originally destined for the church and at the age of fifteen, in opposition to his strong wishes, was shut up in a convent; but although in the following year he was induced to pronounce monastic vows, he had no liking for this life. He acquired considerable reputation as an elegant writer both of Latin and Italian prose and verse; and from 1716 to 1724 he filled the chairs of rhetoric at Brescia, Rome, Genoa, Bologna and Modena successively, attracting by his brilliant fluency a large number of students at each university. Through Cardinal Bentivoglio he was recommended to Antonio Farnese, duke of Parma, who appointed him his poet laureate; and he remained at the court of Parma until the death of Antonio, after which he returned to Genoa. Shortly afterwards, through the intercession of Bentivoglio, he obtained from the pope the remission of his monastic vows, and ultimately succeeded in recovering a portion of his paternal inheritance. After the peace of Aix-la-Chapelle he returned to the court of Parma, and there devoted the later years of his life chiefly to poetical composition. He died on the 20th of December 1768. As a poet Frugoni was one of the best of the school of the Arcadian Academy, and his lyrics and pastorals had great facility and elegance.

His collected works were published at Parma in 10 vols. in 1799, and a more complete edition appeared at Lucca in the same year in 15 vols. A selection from his works was published at Brescia in 1782, in 4 vols.

FRUIT (through the French from the Lat. *fructus; frui*, to enjoy), in its widest sense, any product of the soil that can be enjoyed by man or animals; the word is so used constantly in the Bible, and extended, as a Hebraism, to offspring or progeny of man and of animals, in such expressions as "the fruit of the body;" "of the womb;" "fruit of thy cattle" (Deut. xviii. 4), &c., and generally to the product of any action or effort. Between this wide and frequently figurative use of the word and its application in the strict botanical sense treated below, there is a popular meaning, regarding the objects denoted by the word entirely from the standpoint of edibility, and differentiating them roughly from those other products of the soil, which, regarded similarly, are known as vegetables. In this sense "fruit" is applied to such seed-envelopes of plants as are edible, either raw or cooked, and are usually sweet, juicy or of a refreshing flavour. But applications of the word in this sense are apt to be loose and shifting according to the fashion of the time.

Fruit, in the botanical sense, is developed from the flower as the result of fertilization of the ovule. After fertilization various changes take place in the parts of the flower. Those more immediately concerned in the process, the anther and stigma, rapidly wither and decay, while the filaments and style often remain for some time; the floral envelopes become dry, the petals fall, and the sepals are either deciduous, or remain persistent in an altered form; the ovary becomes enlarged, forming the *pericarp*; and the ovules are developed as the seeds, containing the embryo-plant. The term fruit is strictly applied to the mature pistil or ovary, with the seeds in its interior; but it often includes other parts of the flower, such as the bracts and floral envelopes. Thus the fruit of the hazel and oak consists of the ovary enveloped by the bracts; that of the apple and pear, of the ovary and floral receptacle; and that of the pineapple, of the whole inflorescence. Such fruits are sometimes distinguished as *pseudocarps*. In popular language, the fruit includes all those parts which exhibit a striking change as the result of fertilization. In general, the fruit is not ripened unless fertilization has been effected; but cases occur as the result of cultivation in which the fruit swells and becomes to all appearance perfect, while no seeds are produced. Thus, there are seedless oranges, grapes and pineapples. When the ovules are unfertilized, it is common to find that the ovary withers and does not come to maturity; but in the case of bananas, plantains and breadfruit, the non development of seeds seems to lead to a larger growth and a greater succulence of fruit.

The fruit, like the ovary, may be formed of a single carpel or of several. It may have one cell or cavity, being *unilocular*; or many, *multilocular*, &c. The number and nature of the divisions depend on the number of carpels and the extent to which their edges are folded inwards. The appearances presented by the ovary do not always remain permanent in the fruit. Great changes are observed to take place, not merely as regards the increased size of the ovary, its softening or hardening, but also in its internal structure, owing to the suppression, additional formation or enlargement of parts. Thus, in the ash (fig. 1) an ovary with two cells, each containing an ovule attached to a central placenta, is changed into a unilocular fruit with one seed; one ovule becomes abortive, while the other, *g*, gradually enlarging until the septum is pushed to one side, unites with the walls of the cell, and the placenta appears to be parietal. In the oak and hazel, an ovary with three and two cells respectively, and two ovules in each, produces a one-celled fruit with one seed. In the coco-nut, a trilocular and triovular ovary produces a one-celled, one-seeded fruit. This abortion may depend on the pressure caused by the development of certain ovules, or it may proceed from non-fertilization of all the ovules and consequent non-enlargement of the carpels. Again, by the growth of the placenta, or the folding inwards of parts of the carpels, divisions occur in the fruit which did not exist in the ovary. In *Cathartocarpus Fistula* a one-celled ovary is changed into a fruit having each of its seeds in a separate cell, in consequence of spurious dissepiments being produced horizontal from the inner wall of the ovary. In flax (*Linum*) by the folding inwards of the back of the carpels a five-celled ovary becomes a ten-celled fruit. In *Astragalus* the folding inwards of the dorsal suture converts a one-celled ovary into a two-celled fruit; and in *Oxytropis* the folding of the ventral suture gives rise to a similar change. The development of cellular or pulpy matter, and the enlargement of parts not forming whorls of the flower, frequently alter the appearance of the fruit, and render it difficult to discover

its formation. In the gooseberry (fig. 2*g*), grape, guava, tomato and pomegranate, the seeds nestle in pulp formed by the placentas. In the orange the pulpy matter surrounding the seeds is formed by succulent cells, which are produced from the inner partitioned lining of the pericarp. In the strawberry the receptacle becomes succulent, and bears the mature carpels on its convex surface (fig. 2); in the rose there is a fleshy hollow receptacle which bears the carpels on its concave surface (fig. 3). In the juniper the scaly bracts grow up round the seeds and become succulent, and in the fig (fig. 4) the receptacle becomes succulent and encloses an inflorescence.

The pericarp consists usually of three layers, the external, or *epicarp* (fig. 5, *ep*); the middle, or *mesocarp*, *m*; and the internal,

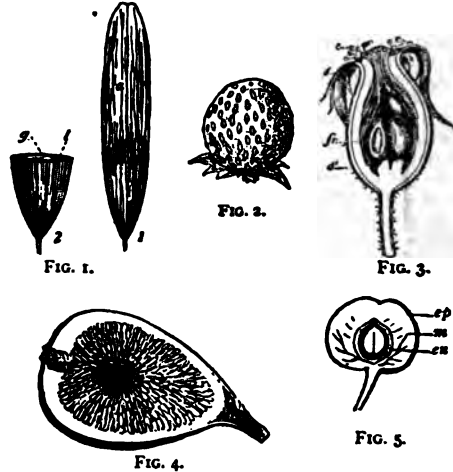

FIG. 1.—Samara or winged fruit of Ash (*Fraxinus*). 1, Entire, with its wing *a*; 2, lower portion cut transversely, to show that it consists of two cells; one of which, *l*, is abortive, and is reduced to a very small cavity, while the other is much enlarged and filled with a seed *g*.

FIG. 2.—Fruit of the Strawberry (*Fragaria vesca*), consisting of an enlarged succulent receptacle, bearing on its surface the small dry seed-like fruits (achenes). (After Duchartre.)

From Strasburger's *Lehrbuch der Botanik*, by permission of Gustav Fischer.
FIG. 3.—Fruit of the Rose cut vertically. *s*, Fleshy hollowed receptacle; *fr*, persistent sepals; *fr*, ripe carpels; *a*, stamens, withered.

FIG. 4.—Peduncle of Fig (*Ficus Carica*), ending in a hollow receptacle enclosing numerous male and female flowers.

FIG. 5.—Fruit of Cherry (*Prunus Cerasus*) in longitudinal section. *ep*, Epicarp; *m*, mesocarp; *en*, endocarp.

From Strasburger's *Lehrbuch der Botanik*, by permission of Gustav Fischer.
or *endocarp*, *en*. These layers are well seen in such a fruit as the peach, plum or cherry, where they are separable one from the other; in them the epicarp forms what is commonly called the skin; the mesocarp, much developed, forms the flesh or pulp, and hence has sometimes been called *sarcocarp*; while the endocarp, hardened by the production of woody cells, forms the *stone* or *putamen* immediately covering the kernel or seed. The pulpy matter found in the interior of fruits, such as the gooseberry, grape and others, is formed from the placentas, and must not be confounded with the sarcocarp. In some fruits, as in the nut, the three layers become blended together and are indistinguishable. In bladder senna (*Cassia arborescens*) the pericarp retains its leaf-like appearance, but in most cases it becomes altered both in consistency and in colour. Thus in the date the epicarp is the outer brownish skin, the pulpy matter is the mesocarp or sarcocarp, and the thin papery-like lining is the endocarp covering the hard seed. In the medlar the endocarp becomes of a stony hardness. In the melon the epicarp and endocarp are very thin, while the mesocarp forms the bulk of the fruit, differing in texture and taste in its external and internal parts. The rind of the orange consists of epicarp and mesocarp, while the endocarp forms partitions in the interior, filled with pulpy cells. The part of the pericarp attached to the peduncle is the base, and the point where the style or stigma existed is the apex. This latter is not always the apparent apex, as in the case of the ovary; it may be lateral or even basilar. The style sometimes remains in a hardened form, rendering the fruit *apiculate*; at other times it falls off, leaving only traces of its existence. The presence of the style or stigma serves to distinguish certain single-seeded pericarps from seeds.

When the fruit is mature and the seeds are ripe, the carpels usually give way either at the ventral or dorsal suture or at both, and so allow the seeds to escape. The fruit in this case *Dehiscence of fruits.* is *dehiscent*. But some fruits are *indehiscent*, falling to the ground entire, and the seeds eventually reaching the soil by their decay. By dehiscence the pericarp becomes divided into different pieces, or *valves*, the fruit being univalvular, bivalvular or multivalvular, &c., according as there are one, two or many valves. The splitting extends the whole length of the fruit, or is partial, the valves forming teeth at the apex, as in the order Caryophyllaceae (fig. 6). Sometimes the valves are detached only at certain points, and thus dehiscence takes place by pores at the apex, as in poppy (fig. 7), or at the base, as in *Campanula*. Indehiscent fruits are either dry, as the nut, or fleshy, as the cherry and apple. They are formed of one or several carpels. In the former case they usually contain only a single seed, which may become so incorporated with the pericarp as to appear to be naked, as in the grain of wheat and generally in grasses. In such cases the presence of the remains of style or stigma determines opening by pores *p.*, under the radiating peltate stigma *s.*

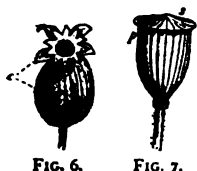

FIG. 6.—Seed-vessel or capsule of Campion, opening by ten teeth at the apex. The calyx *c* is seen surrounding the seed-vessel.

FIG. 7.—Capsule of Poppy, which opens by a central pore *p.*, under the radiating peltate stigma *s.*

Dehiscent fruits, when composed of single carpels, may open by the ventral suture only, as in the paony, hellebore, *Aquilegia* (fig. 28) and *Callitha*; by the dorsal suture only, as in magnolias and some *Proteaceae*, or by both together, as in the pea (fig. 8) and bean; in these cases the dehiscence is *sutural*. When composed of several

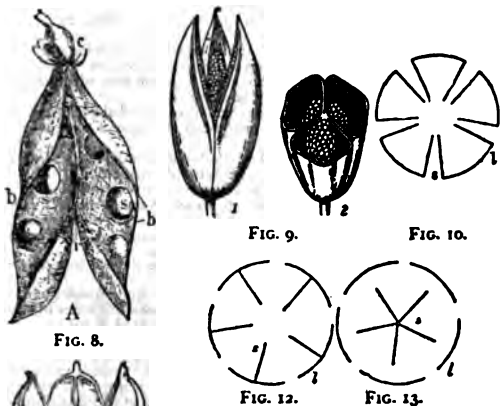

FIG. 8.—Dry dehiscent fruit. The pod (legume) of the Pea; *r*, the dorsal suture; *b*, the ventral; *c*, calyx; *s*, seeds.

FIG. 9.—(1) Fruit or capsule of Meadow Saffron (*Colchicum autumnale*), dehiscing along the septa (septicality); (2) same cut across, showing the three chambers with the seeds attached along the middle line (axile placentation).

FIG. 10.—Diagram to illustrate the septical dehiscence in a pentalocular capsule. The loculements *l* correspond to the number of the carpels, which separate by splitting through the septa, *s*.

FIG. 11.—The seed vessel (capsule) of the Flower-de-Luce (*Iris*), opening in a loculicidal manner. The three valves bear the septa in the centre, and the opening takes place through the back of the loculements. Each valve is formed by the halves of contiguous carpels.

FIG. 12.—Diagram to illustrate loculicidal dehiscence. The loculements *l*, split at the back, and the valves separate, bearing the septa *s* on their centres.

FIG. 13.—Diagram to illustrate septifragal dehiscence, in which the dehiscence takes place through the back of the loculements *l*, and the valves separate from the septa *s*, which are left attached to the placentas in the centre.

united carpels, two types of dehiscence occur—a longitudinal and a transverse. In the longitudinal the separation may take place by the dissepiments throughout their length, so that the fruit is resolved into its original carpels, and each valve represents a carpel, as in rhododendron, *Colchicum*, &c.; this dehiscence, in consequence of taking place through the septum, is called *septifragal* (figs. 9, 10). The valves separate from their commissure, or central line of union, carrying the placentas with them, or they leave the latter in the centre, so as to form with the axis a column of a cylindrical, conical or prismatic shape. Dehiscence is *loculicidal* when the union between the edges of the carpels is persistent, and they dehisce by the dorsal suture, or through the back of the loculements, as in the lily and iris (figs. 11, 12). In these cases each valve consists of a half of each of two contiguous carpels. The placentas either remain united to the axis, or they separate from it, being attached to the septa on the valves. When the outer walls of the carpels break off from the septa, leaving them attached to the central column, the dehiscence is said to be *septifragal* (fig. 13), and where, as in *Linum catharticum* and *Calluna*, the splitting takes place first of all in a septicidal manner, the fruit is described as *septicidally septifragal*; while in other cases, as in thorn apple (*Datura Stramonium*), where the splitting is at first loculicidal, the dehiscence is *loculicidally septifragal*. In all those forms the separation of the valves takes place either from above downwards or from below upwards. In

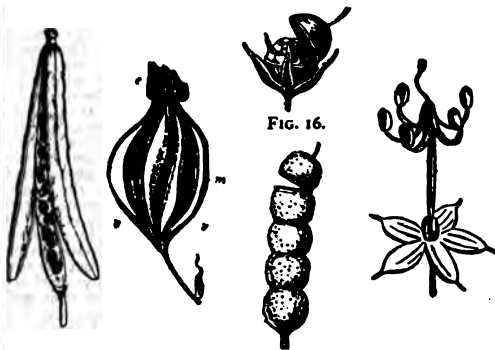

FIG. 14.—Silique or seed-vessel of Wallflower (*Cheiranthus Cheiri*), opening by two valves, which separate from the base upwards, leaving the seeds attached to the dissepiment which is supported by the replum.

FIG. 15.—Capsule of an Orchid (*Xylobium*). *v*, valve.

FIG. 16.—Seed-vessel of *Anagallis arvensis*, opening by circumscissile dehiscence.

FIG. 17.—Lomentum of *Hedysarum* which, when ripe, separates transversely into single-seeded portions or mericarps.

FIG. 18.—Fruit of *Geranium pratense*, after splitting.

Saxifraga a splitting for a short distance of the ventral sutures of the carpels takes place, so that a large apical pore is formed. In the fruit of Cruciferae, as wallflower (fig. 14), the valves separate from the base of the fruit, leaving a central *replum*, or frame, which supports the false septum formed by a prolongation from the parietal placentas on opposite sides of the fruit, extending between the ventral sutures of the carpels. In Orchidaceae (fig. 15) the pericarp, when ripe, separates into three valves in a loculicidal manner, but the midribs of the carpels, to which the placentas are attached, often remain adherent to the axis both at the apex and base after the valves bearing the seeds have fallen. The other type of dehiscence is transverse, or *circumscissile*, when the upper part of the united carpels falls off in the form of a lid or operculum, as in *Anagallis* and in henbane (*Hyoscyamus*) (fig. 16).

Sometimes the axis is prolonged beyond the base of the carpels, as in the mallow and castor-oil plant, the carpels being united to it throughout their length by their faces, and separating from it without opening. In the Umbelliferae the two carpels separate from the lower part of the axis, and remain attached by their apices to a prolongation of it, called a *carpopore* or *podocarp*, which splits into two (fig. 25) and suspends them; hence the fruit is termed a *cremocarp*, which divides into two *mericarps*. The general term *schisocarp* is applied to all dry fruits, which break up into two or more one-seeded indehiscent mericarps, as in *Hedysarum* (fig. 17). In the order Geraniaceae the styles remain attached to a central column, and the mericarps separate from below upwards, before dehiscing by their ventral suture (fig. 18). Carpels which separate one from another in this manner are called *cocci*. They are well

seen in the order Euphorbiaceae, where there are usually three such carpels, and the fruit is termed tricoecus. In many of them, as *Hura crepitans*, the cocci separate with great force and elasticity. In many leguminous plants, such as *Ornithoglossum* (fig. 17), *Enxada*, *Covonilla* and the gum-arabic plant (*Acacia arabica*), the fruit becomes a schizocarp by the formation of transverse partitions from the folding in of the sides of the pericarp, and distinct separations taking place at these partitions.

Fruits are formed by one flower, or are the product of several flowers combined. In the former case they are either *apocarpous*, of one mature carpel or of several separate free carpels; or *syncarpous*, of several carpels, more or less completely united. When the fruit is composed of the ovaries of several flowers united, it is usual to find the bracts and floral envelopes also joined with them, so as to form one mass; hence such fruits are known as multiple, confluent or *anthocarpous*. The term simple is applied to fruits which are formed by the ovary of a single flower, whether they are composed of one or several carpels, and whether these carpels are separate or combined.

The object of the fruit in the economy of the plant is the protection and nursing of the developing seed and the dispersion of the ripe seeds. Hence, generally, one-seeded fruits are indehiscent, while fruits containing more than one seed open to allow of the dispersal of the seeds over as wide an area as possible. The form, colour, structure and method of dehiscence of fruits and the form of the contained seeds are intimately associated with the means of dispersal, which fall into several categories. (1) By a mechanism residing in the fruit. Thus many fruits open suddenly when they are dry, and the seeds are ejected by the twisting or curling of the valves, or in some other way; e.g. in gorse, by the spiral curving of the valves; in *Impatiens*, by the twisting of the cocci; in squinting cucumber, by the pressure exerted on the pulpy contents by the walls of the pericarp. (2) By aid of various external agencies such as water. Fruits or seeds are sometimes sufficiently buoyant to float for a long time on sea- or fresh-water; e.g. coco-nut, by means of its thick, fibrous coat (mesocarp), is carried hundreds of miles in the sea, the tough, leathery outer coat (epicarp) preventing it from becoming water-soaked. Fruits and seeds of West Indian plants are thrown up on the coasts of north-west Europe, having been carried by the Gulf Stream, and will often germinate; many are rendered buoyant by air-containing cavities, and the embryo is protected from the seawater by the tough coat of fruit or seed. Water-lily seeds are surrounded with a spongy tissue when set free from the fruit, and float for some distance before dropping to the bottom. (3) The most general agent in the dispersal of seeds is the wind or currents of air—the fruit or seed being rendered buoyant by wing-developments as in fruits of ash (fig. 1) or maple (fig. 21), seeds of pines and firs, or many members of the order Bignoniaceae; or hair-developments as in fruits of clematis, where the style forms a feathery

of Jericho, a small cruciferous plant (*Amastatica hierocuntica*), where the plant dries up after developing its fruits and becomes detached from the ground; the branches curl inwards, and the whole plant is rolled over the dry ground by the wind. The wind also aids the dispersal of the seeds in the case of fruits which open by small teeth (many Caryophyllaceae (fig. 6)) or pores (poppy (fig. 7)). *Campandula*, &c.; the seeds are in these cases small and numerous, and are jerked through the pores when the capsules, which are generally borne on long, dry stems or stalks, are shaken by the wind. (4) In other cases members of the animal world aid in seed-dispersal. Fruits often bear stiff hairs or small hooks, which cling to the coat of an animal or the feathers of a bird; such are fruits of cleavers (*Galium Aparine*), a common hedge-row plant, *Ranunculus arvensis* (fig. 20), carrot, *Geum*, &c.; or the fruit or seed has an often bright-coloured, fleshy



FIG. 19.



FIG. 20.

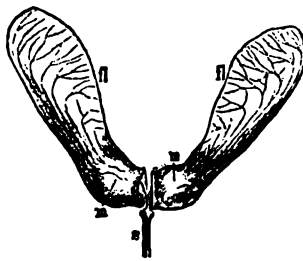

FIG. 21.

From Vines' *Students' Text-Book of Botany*, by permission of Swan Sonnenschein & Co.

FIG. 19.—Dry one-seeded fruit of dock (*Rumex*) cut vertically. *a*, Pericarp formed from ovary wall; *s*, seed; *e*, endosperm; *pl*, embryo with radicle pointing upwards and cotyledons downwards—enlarged.

FIG. 20.—Achene of *Ranunculus arvensis* in longitudinal section; *e*, endosperm; *pl*, embryo. (After Baillon, enlarged.)
From Strasburger's *Lehrbuch der Botanik*, by permission of Gustav Fischer.

FIG. 21.—Fruit of Common Sycamore (*Acer Pseudoplatanus*), dividing into two mericarps *m*; *s*, pedicel; *fl*, wings (nat. size).

appendage, fruits of many Compositae (dandelion, thistle, &c.), which are crowned by a plumose pappus, or seeds of willow and poplar, or *Asclepias* (fig. 36), which bear tufts of silky hairs; to this category belong bladder-like fruits, such as bladder-senna, which are easily rolled by the wind, or cases like the so-called rose

of Jericho, a small cruciferous plant (*Amastatica hierocuntica*), where the plant dries up after developing its fruits and becomes detached from the ground; the branches curl inwards, and the whole plant is rolled over the dry ground by the wind. The wind also aids the dispersal of the seeds in the case of fruits which open by small teeth (many Caryophyllaceae (fig. 6)) or pores (poppy (fig. 7)). *Campandula*, &c.; the seeds are in these cases small and numerous, and are jerked through the pores when the capsules, which are generally borne on long, dry stems or stalks, are shaken by the wind. (4) In other cases members of the animal world aid in seed-dispersal. Fruits often bear stiff hairs or small hooks, which cling to the coat of an animal or the feathers of a bird; such are fruits of cleavers (*Galium Aparine*), a common hedge-row plant, *Ranunculus arvensis* (fig. 20), carrot, *Geum*, &c.; or the fruit or seed has an often bright-coloured, fleshy



FIG. 22.



FIG. 23.



FIG. 24.



FIG. 25.

FIG. 22.—Vertical section of a grain of wheat, showing embryo below at the base of the endosperm *e*; *s*, scutellum separating embryo from endosperm; *pl*, foliage leaf; *p.s.*, sheath of plumule; *p.p.*, primary root; *s.p.p.*, sheath of primary root.

FIG. 23.—Fruit of Comfrey (*Symphytum*) surrounded by persistent calyx, *c*. The style *s* appears to arise from the base of the carpels, enlarged.

FIG. 24.—Ovary of *Foeniculum officinale* with pendulous ovules, in longitudinal section. (After Berg and Schmidt, magnified.)
From Strasburger's *Lehrbuch der Botanik*, by permission of Gustav Fischer.

FIG. 25.—Fruit of *Carum Carui*. *A*, Ovary of the flower; *B*, ripe fruit. The two carpels have separated so as to form two mericarps (*m*). Part of the septum constitutes the carpophore (*a*). *p*, Top of flower-stalk; *d*, disk on top of ovary; *s*, stigma.
From Vines' *Students' Text-Book of Botany*, by permission of Swan Sonnenschein & Co.

covering, which is sought by birds as food, as in stone-fruits such as plum, cherry (fig. 3), &c., where the seed is protected from injury in the mouth or stomach of the animal by the hard endocarp; or the hips of the rose (fig. 3), where the succulent scarlet "fruit" (the swollen receptacle) envelops a number of small dry true fruits (achenes), which cling by means of stiff hairs to the beak of the bird.

Simple fruits have either a *dry* or *succulent* pericarp. The *achene* is a dry, one-seeded, indehiscent fruit, the pericarp of which is closely applied to the seed, but separable from it. It is solitary, forming a single fruit, as in the dock (fig. 19) and in the *Forms of fruit.*

cashew, where it is supported on a fleshy peduncle; or *aggregate*, as in *Ranunculus* (fig. 20), where several achenes are placed on a common elevated receptacle. In the strawberry the achenes (fig. 2) are aggregated on a convex succulent receptacle. In the rose they are supported on a concave receptacle (fig. 3), and in the fig the succulent receptacle completely encloses the achenes (fig. 4). In *Dorstenia* the achenes are situated on a flat or slightly concave receptacle. Hence what in common language are called the seeds of the strawberry, rose and fig, are in reality ripe carpels.

The styles occasionally remain attached to the achenes in the form of feathery appendages, as in *Clematis*. In Compositae, the fruit is an inferior achene (*cypselis*), to which the pappus (modified calyx) remains adherent. Such is also the nature of the fruit in Dipsacaceae (e.g. scabious). When the pericarp is thin, and appears like a bladder surrounding the seed, the achene is termed a *utricle*, as in Amarantaceae. When the pericarp is extended in the form of a winged appendage, a *samara* or *samaroid* achene is produced, as in the ash (fig. 1) and common sycamore (fig. 21). In these cases there are usually two achenes united, one of which, however, as in *Fraxinus* (fig. 1), may be abortive. The wing surrounds the fruit longitudinally in the elm. When the pericarp becomes so incorporated with the seed as to be inseparable from it, as in grains of wheat (fig. 22), maize, and other grasses, then the name *caryopsis* is given. The one-seeded portions (mericarps) of schizocarps often take the form of achenes, e.g. the mericarps of the

mallows or of umbellifers (figs. 24, 25). In Labiatae and Boraginaceae (e.g. comfrey, fig. 23), where the bicarpellary ovary becomes one-seeded portions in the fruit, the partial fruits are of the nature of achenes or nutlets according to the texture (leathery or hard) of the pericarp.

The *nut* or *glands* is a dry one-celled indehiscent fruit with a hardened pericarp, often surrounded by bracts at the base, and, when mature, containing only one seed. In the young state the ovary often contains two or more ovules, but only one comes to maturity. It is illustrated by the fruits of the hazel and chestnut, which are covered by leafy bracts, in the form of a *husk*, and by the acorn, in which the bracts and receptacle form a *cupula* or *cup* (fig. 26). The parts of the pericarp of the nut are united so as to appear one.



From Strasburger's *Lehrbuch der Botanik*, by permission of Gustav Fischer.

FIG. 26.—Cupule of *Quercus Aegilops*, cp, cupule; gl, fruit. (After Duchartre.)

In common language the term *nut* is very vaguely applied both to fruit and seeds. The *drupe* is a succulent usually one-seeded indehiscent fruit, with a pericarp easily distinguishable into epicarp, mesocarp and endocarp. This term is applied to such fruits as the cherry (fig. 5), peach, plum, apricot or mango. The endocarp is usually hard, forming the stone (putamen) of the fruit, which encloses the kernel or seed. The mesocarp is generally pulpy and succulent, so as to be truly a sarcocarp, as in the peach, but it is sometimes of a tough texture, as in the almond, and at other times is more or less fibrous, as in the coco-nut. In the almond there are often two ovules formed, only one of which comes to perfection. In the raspberry and bramble several small drupes or *drupels* are aggregated so as to constitute an *eteerio*.

The *follicle* is a dry unilocular many-seeded fruit, formed from one carpel and dehiscing by the ventral suture. It is rare to meet with a solitary follicle forming the fruit. There are usually several aggregated together, either in a whorl on a shortened receptacle, as in hellebore, aconite, larkspur, columbine (figs. 27, 28) or the order Crassulaceae, or in a spiral manner on an elongated receptacle, as in *Magnolia* and *Banksia*. Occasionally, follicles dehisce by the dorsal suture, as in *Magnolia grandiflora* and *Banksia*.

The *legume* or *pod* is a dry monocarpellary unilocular many-seeded fruit, formed from one carpel, dehiscing both by the ventral and



FIG. 27.



FIG. 28.



FIG. 29.



FIG. 30.

FIG. 27.—Fruit of Columbine (*Aquilegia*), formed of five follicles. FIG. 28.—Single follicle, showing dehiscence by the ventral suture.

FIG. 29.—Transverse section of berry of Gooseberry, showing the seeds attached to the parietal placentas and immersed in pulp, which is formed partly from the endocarp, partly from the seed-coat.

FIG. 30.—Section of the fruit of the Apple (*Pyrus Malus*), or pome, consisting of a fleshy covering formed by the floral receptacle and the true fruit or core with five cavities with seeds.

dorsal suture. It characterizes leguminous plants, as the bean and pea (fig. 8). In the bladder-senna it forms an inflated legume. In some Leguminosae, as *Arachis*, *Cathartocarpus* *Fistula* and the tamarind, the fruit must be considered a legume, although it does not dehisce. The first of these plants produces its fruit underground, and is called earth-nut; the second has a partitioned legume and is schizocarpic; and both the second and third have pulpy matter surrounding the seeds. Some legumes are schizocarpic by the formation of constrictions externally. Such a form is the *lomentum* or *lomentaceous legume* of *Helysarum* (fig. 17), *Coronilla*, *Ornithopus*, *Entada* and of some *Acacias*. In *Medicago* the legume

is twisted like a snail, and in *Caesalpinia coriaria*, or *Divi-divi*, it is vermiform or curved like a worm. Sometimes the number of seeds is reduced, as in *Erythrina monosperma* and *Geoffraya superba*, which are one-seeded, and in *Pterocarpus* and *Dalbergia*, which are two-seeded.

The *berry* (*bacca*) is a term applied generally to all fruits with seeds immersed in pulp, and includes fruits of very various origin. In *Actaea* (baneberry) or *Berberis* (barberry) it is derived from a single free carpel; generally, however, it is the product of a syncarpous ovary, which is superior, as in grape or potato, or inferior, as in gooseberry (fig. 29) or currant. In the pomegranate there is a peculiar *baccate* many-celled inferior fruit, having a tough rind, enclosing two rows of carpels placed one above the other. The seeds are immersed in pulp, and are attached irregularly to the wall, base and centre of the loculi. In the baobab there is a multilocular syncarpous fruit, in which the seeds are immersed in pulp.

The *pepo*, another indehiscent syncarpous fruit, is illustrated by the fruit of the gourd, melon (fig. 31) and other Cucurbitaceae. It is formed of three carpels, surmounted by the calyx; the rind is thick and fleshy, and there are three or more seed-bearing parietal placentas, either surrounding a central cavity or prolonged inwards into it. The fruit of the papaw resembles the pepo, but the calyx is not superior.

The *hesperidium* is the name given to such indehiscent fleshy syncarpous fruits as the orange, lemon and shaddock, in which the epicarp and mesocarp form a separable rind, and the endocarp sends prolongations inwards, forming triangular divisions, to the inner angle of which the seeds are attached, pulpy cells being developed around them from the wall. Both pepo and hesperidium may be considered as modifications of the berry.

The *pome* (fig. 30), seen in the apple, pear, quince, medlar and hawthorn, is a fleshy indehiscent syncarpous fruit, in the formation of which the receptacle takes part. The outer succulent part is the swollen receptacle, the horny core being the true fruit developed from the usually five carpels and enclosing the seeds. In the medlar the core (or true pericarp) is of a stony hardness, while the outer succulent covering is open at the summit. The pome somewhat resembles the fruit of the rose (fig. 3), where the succulent receptacle surrounds a number of separate achenes.

The name *capsule* is applied generally to all dry syncarpous fruits, which dehisce by valves. It may thus be unilocular or multilocular, one- or many-seeded. The true valvular capsule is observed in *Colchicum* (fig. 9), lily and iris (fig. 11). The *porose capsule* is seen in the poppy (fig. 7), *Antirrhinum* and *Campanula*. In *Campanula* the pores occur at the base of the capsule, which becomes inverted when ripe. When the capsule opens by a lid, or by circumscissile dehiscence, it is called a *pyxidium*, as in pimpernel (*Nagellia arvensis*) (fig. 16), henbane and monkey-pot (*Lecythis*). The capsule assumes a screw-like form in *Helictes*, and a star-like form in *Staranis* (*Illicium anisatum*). In certain instances the cells of the capsule separate from each other, and open with elasticity to scatter the seeds. This kind of capsule is met with in the sandbox tree (*Hura crepitans*) and other Euphorbiaceae, where the cocci, containing each a single seed, burst asunder with force; and in Geraniaceae, where the cocci, each containing, when mature, usually one seed, separate from the carpophore, become curved upwards by their adherent styles, and open by the ventral suture (fig. 18).

The *siliqua* is a dry syncarpous bilocular many-seeded fruit, formed from two carpels, with a false septum, dehiscing by two valves from below upwards, the valves separating from the placentas and leaving them united by the septum (fig. 32). The seeds are attached on both sides of the septum, either in one row or in two. When the fruit is long and narrow it is a *siliqua* (fig. 14); when broad and short, *silicula* (fig. 33). It occurs in cruciferous plants, as wall-flower, cabbage and cress. In *Glaucium* and *Eschscholtzia* (Papaveraceae) the dissepiment is of a spongy nature. It may become transversely constricted (*lomentaceous*), as in radish (*Raphanus*) and sea-kale, and it may be reduced, as in woad (*Isatis*), to a one-seeded condition.

It sometimes happens that the ovaries of two flowers unite so as to form a double fruit (*syncarp*). This may be seen in many species of honeysuckle. But the fruits which are now to be considered consist usually of the floral envelopes, as well as the ovaries of several flowers united into one, and are called *multiple* or *confused*. The term *anthocarpous* has also been applied as indicating that the floral envelopes as well as the carpels are concerned in the formation of the fruit.

The *ovoidia* is a succulent multiple fruit formed by the coalescence

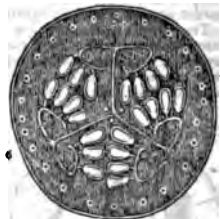

FIG. 31.—Transverse section of the fruit of the Melon (*Cucumis Melo*), showing the placentas with the seeds attached to them. The three carpels forming the pepo are separated by partitions. From the centre processes pass outwards, ending in the curved placentas.

of a spike of flowers, as in the fruit of the pine-apple (fig. 34), the bread-fruit and jack-fruit. Similarly the fruit of the mulberry represents a catkin-like inflorescence.

The *syconus* is an anthocarpous fruit, in which the receptacle completely encloses numerous flowers and becomes succulent. The fig (fig. 4) is of this nature, and what are called its seeds are the achenes of the numerous flowers scattered over the succulent hollowed receptacle. In *Dorstenia* the axis is less deeply hollowed, and of a harder texture, the fruit exhibiting often very anomalous forms.

The *strobilus*, or *cone*, is a seed-bearing spike, more or less elongated, covered with scales, each of which may be regarded as representing a separate flower, and has often two seeds at its base; the seeds are naked, no ovary being present. This fruit is seen in the cones of firs, spruces, larches and cedars, which have received the

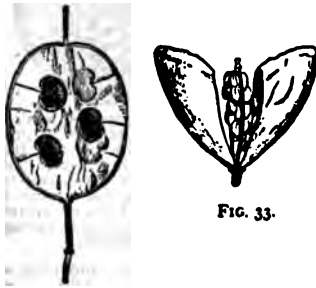

FIG. 32.

FIG. 32.—Honesty (*Lunaria biennis*), showing the septum after the carpels have fallen away.

FIG. 33.—Silicula or pouch of shepherd's purse (*Capsella*), opening by two folded valves, which separate from above downwards. The partition is narrow, hence the silicula is angustiseptate.

FIG. 34.—Fruit of the pine-apple (*Ananassa sativa*), developed from a spike of numerous flowers with bracts, united so as to form a collective or anthocarpous fruit. The crown of the pine-apple, *c*, consists of a series of empty bracts prolonged beyond the fruit.

name of Coniferae, or cone-bearers, on this account. Cone-like fruit is also seen in most Cycadaceae. The scales of the strobilus are sometimes thick and closely united, so as to form a more or less angular and rounded mass, as in the cypress; while in the juniper they become fleshy, and are so incorporated as to form a globular fruit like a berry. The dry fruit of the cypress and the succulent fruit of the juniper have received the name of *galbulus*. In the hop the fruit is called also a strobilus, but in it the scales are thin and membranous, and the seeds are not naked but are contained in pericarps.

The same causes which produce alterations in the other parts of the flower give rise to anomalous appearances in the fruit. The carpels, in place of bearing seeds, are sometimes changed into leaves, with lobes at their margins. Leaves are sometimes produced from the upper part of the fruit. In the genus *Citrus*, to which the orange and lemon belong, it is very common to meet with a separation of the carpels, so as to produce what are called horned oranges and fingered citrons. In this case a syncarpous fruit has a tendency to become apocarpous. In the orange we occasionally find a supernumerary row of carpels produced, giving rise to the appearance of small and imperfect oranges enclosed within the original one; the navel orange is of this nature. It sometimes happens that, by the union of flowers, double fruits are produced. Occasionally a double fruit is produced, not by the incorporation of two flowers, but by the abnormal development of a second carpel in the flower.

Arrangement of Fruits.

A. True fruits—developed from the ovary alone.

1. Pericarp not fleshy or fibrous.

- i. Indehiscent—not opening to allow the escape of the seeds—generally one-seeded. Achene; caryopsis; cypselia; nut; schizocarp.
- ii. Dehiscent—the pericarp splits to allow the escape of the seeds—generally many-seeded. Follicle; legume; siliqua; capsule.

2. Pericarp generally differentiated into distinct layers, one of which is succulent or fibrous. Drupe; berry.

B. Pseudocarps—the development extends beyond the ovary. Pome; syconus; sorosis.

The *Seed*.—The seed is formed from the ovule as the result of fertilization. It is contained in a seed-vessel formed from the ovary



FIG. 34.



FIG. 33.

in the plants called *angiosperms*; while in *gymnosperms* plants, such as Coniferae and Cycadaceae, it is naked, or, in other words, has no true pericarp. It sometimes happens in Angiosperms, that the seed-vessel is ruptured at an early period of growth, so that the seeds become more or less exposed during their development; this occurs in mignonette, where the capsule opens at the apex, and in *Cuphea*, where the placenta bursts through the ovary and floral envelopes, and appears as an erect process bearing the young seeds. After fertilization the ovule is greatly changed, in connexion with the formation of the embryo. In the embryo-sac of most Angiosperms (*g.v.*) there is a development of cellular tissue, the endosperm, more or less filling the embryo-sac. In Gymnosperms (*g.v.*) the endosperm is formed preparatory to fertilization. The fertilized egg enlarges and becomes multicellular, forming the embryo. The embryo-sac enlarges greatly, displacing gradually the surrounding nucellus, which eventually forms merely a thin layer around the sac, or completely disappears. The remainder of the nucellus and the integuments of the ovules form the seed-coats. In some cases (fig. 35) a delicate inner coat or *tegmen* can be distinguished from a tougher outer coat or *testa*; often, however, the layers are not thus separable. The consistency of the seed-coat, its thickness, the character of its surface, &c., vary widely, the variations being often closely associated with the environment or with the means of seed-dispersal. An account of the development of the seed from the ovule will be found in the article ANGIOSPERMS. When the pericarp is dehiscent the seed-covering is of a strong and often rough character; but when the pericarp is indehiscent and encloses the seed for a long period, the outer seed-coat is thin and soft. The cells of the testa are often coloured, and have projections and appendages of various kinds. Thus in *Abrus precatorius* and *Adenanthera pavonina* it is of a bright red colour; in French beans it is beautifully mottled; in the almond it is veined; in the tulip

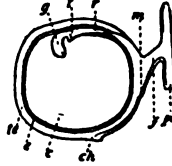

FIG. 35.

FIG. 35.—Seed of Pea (*Pisum*) with one cotyledon removed. *a*, Remaining cotyledon; *ch*, chalazal-point at which the nourishing vessels enter; *e*, tegmen or inner coat; *f*, funicle or stalk; *m*, plumule of embryo; *m*, micropyle; *p*, plumule; *r*, radicle of embryo; *t*, tegmen or stalk between root and plumule; *te*, testa.



FIG. 36.

FIG. 36.—Seed of *Asclepias*, with a cluster of hairs arising from the edges of the micropyle.

and primrose it is rough; in the snapdragon it is marked with depressions; in cotton and *Asclepias* (fig. 36) it has hairs attached to it; and in mahogany, *Bignonia*, and the pines and firs it is expanded in the form of wing-like appendages (fig. 37). In *Collomia*, *Acaridium*, *Cobaea scandens* and other seeds, it contains spiral cells, from which, when moistened with water, the fibres uncoil in a beautiful manner; and in flax (*Linum*) and others the cells are converted into mucilage. These structural peculiarities of the testa in different plants have relation to the scattering of the seed and its germination upon a suitable nidus. But in some plants the pericarps assume structures which subserve the same purpose; this especially occurs in small pericarps enclosing single seeds, as achenes, caryopsides, &c. Thus in Compositae and valerian, the papose limb of the calyx forms a parachute to the pericarp; in Labiatae and some Compositae spiral cells are formed in the epicarp; and the epicarp is prolonged as a wing in *Fraxinus* (fig. 1) and *Acer* (fig. 21).

Sometimes there is an additional covering to the seed, formed after fertilization, to which the name *arillus* has been given (fig. 38). This is seen in the passion-flower, where the covering arises from the placenta or extremity of the funicle at the base of the ovule and passes upwards towards the apex, leaving the micropyle uncovered. In the nutmeg and spindle tree this additional coat is formed from above downwards, constituting in the former case a lacinated scarlet covering called *mace*. In such instances it has been called an *arillode* (fig. 39). This arillode, after growing downwards, may be reflected upwards so as to cover the micropyle. The fleshy scarlet covering formed around the naked seed in the yew is by some considered of the nature of an aril. On the testa, at various points, there are produced at times other cellular bodies, to which the name of *strophioles*, or *caruncles*, has been given, the seeds being strophiolate or carunculate. These tumours may occur near the base of the seed, as in *Polygala*, or at the apex, as in *Castor-oil* plant (*Ricinus*); or they may occur in the course of the raphe, as in blood-root (*Sanguinaria*) and *Asarabacca*. The funicles of the ovules frequently attain a great length in the seed, and in some magnolias, when the fruit dehisces, they appear as long scarlet cords suspending the seeds outside. The hilum or umbilicus of the seed is usually

well marked, as a scar of varying size; in the calabar bean and in some species of *Mucuna* and *Dolichos* it extends along a large portion of the edge of the seed; it frequently exhibits marked colours, being black in the bean, white in many species of *Phaseolus*, &c. The micropyle (fig. 35, *m*) of the seed may be recognizable by the naked eye, as in the pea and bean tribe, *Tris*, &c., or it may be very minute or microscopic. It indicates the true apex of the seed, and is important as marking the point to which the root of the embryo is directed. At the micropyle in the bean is observed a small process of integument, which, when the young plant sprouts, is pushed up like a lid; it is called the *embryotega*. The chalaza (fig. 38, *ch*) is often of a different colour from the rest of the seed. In the orange (fig. 40) it is of a reddish-brown colour, and is easily recognized at one end of the seed when the integuments are carefully removed. In anatropal seeds the raphe forms a distinct ridge along one side of the seed (fig. 41).

The position of the seed as regards the pericarp resembles that of the ovule in the ovary, and the same terms are applied—erect, ascending, pendulous, suspended, curved, &c. These terms have no reference to the mode in which the fruit is attached to the axis. Thus the seed may be erect while the fruit itself is pendent, in the ordinary meaning of that term. The part of the seed next the axis or the ventral suture is its face, the opposite side being the back. Seeds exhibit great varieties of form. They may be flattened laterally (*compressed*), or from above downwards (*depressed*). They may be round, oval, triangular, polygonal, rolled up like a snail, as in *Physostemon*, or coiled up like a snake, as in *Ophiocaryon paradoxum*.

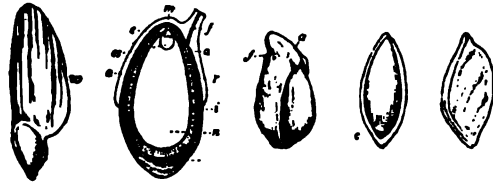

FIG. 37. FIG. 38. FIG. 39. FIG. 40. FIG. 41.

FIG. 37.—Seed of Pine (*Pinus*), with a membranous appendage to the testa, called a wing.

FIG. 38.—Young anatropal seed of the white Water-lily (*Nymphaea alba*), cut vertically. It is attached to the placenta by the funicle *f*, cellular prolongations from which form an aril *a*. The vessels of the cord are prolonged to the base of the nucellus *n* by means of the raphe *r*. The base of the nucellus is indicated by the chalaza *ch*, while the apex is at the micropyle *m*. The covering of the seed is marked *i*. *s* is the nucellus or perisperm, enclosing the embryo-sac *es*, in which the endosperm is formed. The embryo *e*, with its suspensor, is contained in the sac, the radicle pointing to the micropyle *m*.

FIG. 39.—Arilode *a*, or false aril, of the Spindle-tree (*Euonymus*), arising from the micropyle *f*.

FIG. 40.—Anatropal seed of the Orange (*Citrus Aurantium*) opened to show the chalaza *c*, which forms a brown spot at one end.

FIG. 41.—Entire anatropal seed of the Orange (*Citrus Aurantium*), with its rugose or wrinkled testa, and the raphe *r* ramifying in the thickness of the testa on one side.

The endosperm formed in the embryo-sac of angiosperms after fertilization, and found previous to it in gymnosperms, consists of cells containing nitrogenous and starchy or fatty matter, destined for the nutriment of the embryo. It occupied the whole cavity of the embryo-sac, or is formed only at certain portions of it, at the apex, as in *Rhinanthus*, at the base, as in *Vaccinium*, or in the middle, as in *Veronica*. As the endosperm increases in size along with the embryo-sac and the embryo, the substance of the original nucellus of the ovule is gradually absorbed. Sometimes, however, as in *Musaceae*, *Cannaceae*, *Zingiberaceae*, no endosperm is formed; the cells of the original nucellus, becoming filled with food-materials for the embryo, are not absorbed, but remain surrounding the embryo-sac with the embryo, and constitute the *perisperm*. Again, in other plants, as *Nymphaeaceae* (fig. 38) and *Piperaceae*, both endosperm and perisperm are present. It was from observations on cases such as these that old authors, imagining a resemblance betwixt the plant-ovule and the animal ovum, applied the name *albumen* to the outer nutrient mass or perisperm, and designated the endosperm as *vitellus*. The term albumen is very generally used as including all the nutrient matter stored up in the seed, but it would be advisable to discard the name as implying a definite chemical substance. There is a large class of plants in which although at first after fertilization a mass of endosperm is formed, yet, as the embryo increases in size, the nutrient matter from the endospermic cells passes out from them, and is absorbed by the cells of the embryo plant. In the mature seed, in such cases, there is no separate mass of tissue containing nutrient food-material apart from the embryo itself. Such a seed is said to be *exalbuminous*, as in *Compositae*, *Cruciferae* and most *Leguminosae* (e.g. pea, fig. 35).

When either endosperm or perisperm or both are present the seed is said to be *albuminous*.

The albumen varies much in its nature and consistence, and furnishes important characters. It may be farinaceous or mealy, consisting chiefly of cells filled with starch, as in cereal grains, where it is abundant; fleshy or cartilaginous, consisting of thick cells which are still soft, as in the coco-nut, and which sometimes contain oil, as in the oily albumen of *Croton*, *Ricinus* and poppy; horny, when the cell-walls are slightly thickened and capable of distension, as in date and coffee; the cell-walls sometimes become greatly thickened, filling up the testa as a hard mass, as in vegetable ivory (*Phytelphas*). The albumen may be uniform throughout, or it may present a mottled appearance, as in the nutmeg, the seeds of *Anonaceae* and some *Palms*, where it is called *ruminate*. This mottled appearance is due to a protrusion of a dark lamella of the integument between folded protuberances of albumen. A cavity is sometimes left in the centre which is usually filled with fluid, as in the coco-nut.

The relative size of the embryo and of the endosperm varies much. In *Monocotyledons* the embryo is usually small, and the endosperm large, and the same is true in the case of coffee and many other plants amongst *Dicotyledons*. The opposite is the case in other plants, as in the *Labiatae*, *Plumbaginaceae*, &c. The embryo consists of an axis bearing the cotyledons (fig. 42, *c*), or the first leaves of the plant. To that part of this axis immediately beneath the cotyledons the terms *hypocotyl*, *caulicle* or *tigellum* (*h*) have been applied, and continuous backwards with it is the young root or *radicle* (*r*), the descending axis, their point of union being the collar or neck. The terminal growing bud of the axis is called the *plumule* or *gemmule* (*g*), and represents the ascending axis. The radicular extremity towards the micropyle, while the cotyledonary extremity is pointed towards the base of the ovule or the chalaza. Hence, by ascertaining the position of the micropyle and chalaza, the two extremities of the embryo can in general be discovered. It is in many cases difficult to recognize the parts in an embryo; thus in *Cuscuta*, the embryo appears as an elongated axis without divisions; and in *Caryocar* the mass of the embryo is made up by the radicular extremity and hypocotyl, in a groove of which the cotyledonary extremity lies embedded (fig. 52). In some monocotyledonous embryos, as in *Orchidaceae*, the embryo is a cellular mass showing no parts. In parasitic plants also which form no chlorophyll, as *Orbanchia*, *Monotropa*, &c., the embryo remains without differentiation, consisting merely of a mass of cells until the ripening of the seed. When the embryo is surrounded by the endosperm on all sides except its radicular extremity it is internal (see figs. 19, 20); when lying outside the endosperm, and only coming into contact with it at certain points, it is external, as in grasses (*L.*, wheat, fig. 22). When the embryo follows the direction of the axis of the seed, it is axile or axial (fig. 43); when it is not in the direction of the axis, it becomes abaxial or abaxial. In campylotropal seeds the embryo is curved, and in place of being embedded in endosperm, is frequently external to it, following the concavity of the seed (fig. 44), and becoming peripheral, with the chalaza situated in the curvature of the embryo, as in *Caryophyllaceae*.

It has been already stated that the radicle of the embryo is directed to the micropyle, and the cotyledons to the chalaza. In some cases, by the growth of the integuments, the former is turned round so as not to correspond with the apex of the nucellus, and then the embryo has the radicle directed to one side, and is called *excentric*, as is seen in *Primulaceae*, *Plantaginaceae* and many palms, especially the date. The position of the embryo in different kinds of seeds varies. In an orthotropal seed the embryo is inverted or *antitropal*, the radicle pointing to the apex of the seed, or to the part opposite the hilum. Again, in an anatropal seed the embryo is erect or *homotropal* (fig. 43), the radicle being directed to the base of the seed. In curved or campylotropal seeds the embryo is folded so that its radicular and cotyledonary extremities are approximated, and it becomes *amphitropal* (fig. 44). In this instance the seed may be exalbuminous, and the embryo may be folded on itself; or albuminous, the embryo surrounding more or less completely the endosperm and being peripheral. According to the mode in which the seed is attached to the pericarp, the radicle may be directed upwards or downwards, or laterally, as regards the ovary. In an orthotropal seed attached to the base of the pericarp it is superior, as also in a suspended anatropal seed. In other anatropal seeds the radicle is inferior. When the seed is horizontal as regards the pericarp, the radicle is either centrifugal, when it points to the outer wall of the ovary; or centripetal, when it points to the axis or inner wall of the ovary. These characters are of value for purposes of classification, as they are often constant in large groups of genera.



FIG. 42.—The dicotyledonous embryo of the Pea laid open.

c, *c*. The two fleshy cotyledons, or seed-lobes, which remain under ground when the plant sprouts; *r*, the radicular extremity of the axis whence the root arises; *h*, the axis (hypocotyl) bearing the young stalk and leaves *g* (plumule), which lie in a depression of the cotyledons *f*.

Plants in which there are two cotyledons produced in the embryo are *dicotyledonous*. The two cotyledons thus formed are opposite to each other (figs. 42 and 45), but are not always of the same size. Thus, in *Abronia* and other members of the order Nyctaginaceae, one of them is smaller than the other (often very small), and in *Carapa guianensis* there appears to be only one, in consequence of the intimate union which takes place between the two. The union between the cotyledonary leaves may continue after the young plant begins to germinate. Such embryos have been called *pseudomonocotyledonous*. The texture of the cotyledons varies. They may be thick, as in the pea (fig. 42), exhibiting no traces of venation, with their flat internal surfaces in contact, and their backs more or less convex; or they may be in the form of thin and delicate laminae, flattened on both sides, and having distinct venation, as in *Ricinus*, *Jatropha*, *Eucalyptus*, &c. The cotyledons usually form the greater part of the mature embryo, and this is remarkably well seen in such exalbuminous seeds as the bean and pea.

Cotyledons are usually entire and sessile. But they occasionally become lobed, as in the walnut and the lime; or petiolate, as in *Geranium molle*; or auriculate, as in the ash. Like leaves in the

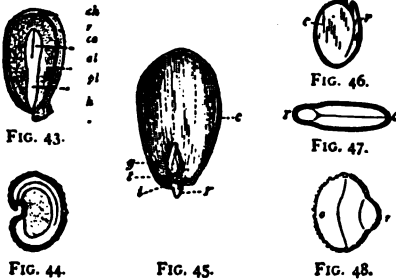

FIG. 43.—Seed of Pansy (*Viola tricolor*) cut vertically. The embryo *pl* is axial, in the midst of fleshy endosperm *al*. The seed is anatropal, and the embryo is homotropal; the cotyledons *co* point to the base of the nucellus or chalazae *ch*, while the radicle, or the other extremity of the embryo, points to the micropyle, close to the hilum *h*. The hilum or base of the seed, and the chalazae or base of the nucellus are united by means of the raphe *r*.

FIG. 44.—Seed of the Red Campion (*Lychnis*), cut vertically, showing the peripheral embryo, with its two cotyledons and its radicle. The embryo is curved round the albumen, so that its cotyledons and radicle both come near the hilum (*amphitropal*).

FIG. 45.—Mature dicotyledonous embryo of the Almond, with one of the cotyledons removed. *r*, Radicle; *t*, young stem or caudicle; *c*, one of the cotyledons left; *i*, line of insertion of the cotyledon which has been removed; *g*, plumule.

FIG. 46.—Exalbuminous seed of Wallflower (*Cheiranthus*) cut vertically. The radicle *r* is folded on the edges of the cotyledons *c* which are incumbent.

FIG. 47.—Transverse section of the seed of the Wallflower (*Cheiranthus*), showing the radicle *r* folded on the edges of the incumbent cotyledons *c*.

FIG. 48.—Transverse section of the seed of the Dame's Violet (*Hesperis*). The radicle *r* is folded on the back of the cotyledons *c*, which are said to be incumbent.

bud, cotyledons may be either applied directly to each other, or may be folded in various ways. In geranium the cotyledons are twisted and doubled; in convolvulus they are corrugated; and in the potato and in *Bunias*, they are spiral,—the same terms being applied as to the foliage leaves. The radicle and cotyledons are either straight or variously curved. Thus, in some cruciferous plants, as the wallflower, the cotyledons are applied by their faces, and the radicle (figs. 46, 47) is folded on their edges, so as to be lateral; the cotyledons are here *acumbent*. In others, as *Hesperis*, the cotyledons (fig. 48) are applied to each other by their faces, and the radicle, *r*, is folded on their back, so as to be dorsal, and the cotyledons are *incumbent*. Again, the cotyledons are *conduplicate* when the radicle is dorsal, and enclosed between their folds. In other divisions the radicle is folded in a spiral manner, and the cotyledons follow the same course.

In many gymnosperms more than two cotyledons are present, and they are arranged in a whorl. This occurs in Coniferae, especially in the pine, fir (fig. 49), spruce and larch, in which six, nine, twelve and even fifteen have been observed. They are linear, and resemble in their form and mode of development the clustered or fasciculated leaves of the larch. Plants having numerous cotyledons are termed *polycotyledonous*. In species of *Streptocarpus* the cotyledons are permanent, and act the part of leaves. One of them is frequently largely developed, while the other is small or abortive.

In those plants in which there is only a single cotyledon in the embryo, hence called *monocotyledonous*, the embryo usually has a cylindrical form more or less rounded at the extremities, or elongated and fusiform, often oblique. The axis is usually very short compared with the cotyledon, which in general encloses the plumule by its lower portion, and exhibits on one side a small slit which indicates the union of the edges of the vaginal or sheathing portion of the leaf (fig. 50). In grasses, by the enlargement of the embryo in a particular direction, the endosperm is pushed on one side, and thus the embryo comes to lie outside at the base of the endosperm (figs. 27, 51). The lamina of the cotyledon is not developed. Upon the side of the embryo next the endosperm and enveloping it is a large shield-shaped body, termed the *scutellum*. This is an outgrowth from the base of the cotyledon, enveloping more or less the cotyledon

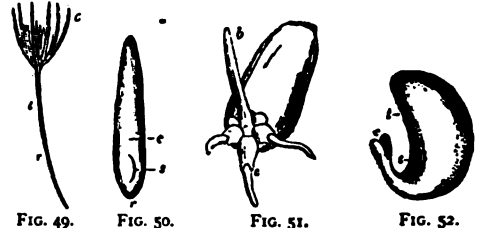

FIG. 49.—Polycotyledonous embryo of the Pine (*Pinus*) beginning to sprout. *t*, Hypocotyl; *r*, radicle. The cotyledons *c* are numerous. Within the cotyledons the primordial leaves are seen, constituting the plumule or first bud of the plant.

FIG. 50.—Embryo of a species of Arrow-grass (*Triglochin*), showing a uniform conical mass, with a slit *s* near the lower part. The cotyledon *c* envelops the young bud, which protrudes at the slit during germination. The radicle is developed from the lower part of the axis *r*.

FIG. 51.—Grain of Wheat (*Triticum*) germinating, showing (b) the cotyledon and (c) the rootlets surrounded by their sheaths (*coleorrhizae*).

FIG. 52.—Embryo of *Caryocarp*. *t*, Thick hypocotyl, forming nearly the whole mass, becoming narrowed and curved at its extremity, and applied to the groove *s*. In the figure this narrowed portion is slightly separated from the groove; *c*, two rudimentary cotyledons.

and plumule, in some cases, as in maize, completely investing it; in other cases, as in rice, merely sending small prolongations over its anterior face at the apex. By others this scutellum is considered as the true cotyledon, and the sheathing structure covering the plumule is regarded as a ligule or axillary stipule (see GRASSES). In many aquatic monocotyledons (e.g. *Potamogeton*, *Ruppia* and others) there is a much-developed hypocotyl, which forms the greater part of the embryo and acts as a store of nutriment in germination; these are known as *macrotylous* embryos. A similar case is that of *Caryocarp* among Dicotyledons, where the swollen hypocotyl occupies most of the embryo (fig. 52). In some grasses, as oats and rice, a projection of cellular tissue is seen upon the side of the embryo opposite to the scutellum, that is, on the anterior side. This has been termed the *epiblast*. It is very large in rice. This by some was considered the rudimentary second cotyledon, but is now generally regarded as an outgrowth of the sheath of the true cotyledon. (A. B. R.)

FRUIT AND FLOWER FARMING. The different sorts of fruits and flowers are dealt with in articles under their own headings, to which reference may be made, and these give the substantial facts as to their cultivation. See also the article HORTICULTURE.

GREAT BRITAIN

The extent of the fruit industry may be gathered from the figures for the acreage of land under cultivation in orchards and small fruit plantations. The Board of Agriculture returns concerning the orchard areas of Great Britain showed a continuous expansion year by year from 199,178 acres in 1888 to 234,660 acres in 1901, as will be learnt from Table I. There was, it is true, an exception in 1892, but the decline in that year is explained by the circumstance that since 1891 the agricultural returns have been collected only from holdings of more than one acre, whereas they were previously obtained from all holdings of a quarter of an acre or more. As there are many holdings of less than an acre in extent upon which fruit is grown, and as fruit is largely raised also in suburban and other gardens which

do not come into the returns, it may be taken for granted that the actual extent of land devoted to fruit culture exceeds that which is indicated by the official figures. In the Board of Agriculture returns up to June 1908, 308,000 acres are stated to be devoted to fruit cultivation of all kinds in Great Britain.

TABLE I.—Extent of Orchards in Great Britain in each Year, 1887 to 1901.

Year.	Acres.	Year.	Acres.	Year.	Acres.
1887	202,234	1892	208,950	1897	224,116
1888	199,178	1893	211,664	1898	226,059
1889	199,897	1894	214,187	1899	228,603
1890	202,305	1895	218,428	1900	232,129
1891	209,996	1896	221,254	1901	234,660

Table II. shows that the expansion of the orchard area of Great Britain is mainly confined to England, for it has slightly decreased in Wales and Scotland. The acreage officially returned as under orchards is that of arable or grass land which is also

TABLE II.—Areas under Orchards in England, Wales and Scotland—Acres.

Year.	England.	Wales.	Scotland.	Great Britain.
1896	215,642	3677	1935	221,254
1897	218,261	3707	2148	224,116
1898	220,220	3690	2149	226,059
1899	222,712	3666	2225	228,603
1900	226,164	3695	2270	232,129
1901	228,580	3767	2313	234,660
1908	244,430	3577	2290	250,297

used for fruit trees of any kind. Conditions of soil and climate determine the irregular distribution of orchards in Great Britain. The dozen counties which possess the largest extent of orchard land all lie in the south or west of the island. According to the returns for 1908 (excluding small fruit areas) they were the following:—

County.	Acres.	County.	Acres.	County.	Acres.
Kent .	32,751	Worcester	23,653	Salop . .	4685
Devon	27,200	Gloucester	20,424	Dorset . .	4464
Hereford	28,316	Cornwall	5,415	Monmouth	3914
Somerset	25,279	Middlesex	5,300	Wilts . .	3630

Leaving out of consideration the county of Kent, which grows a greater variety of fruit than any of the others, the counties of Devon, Hereford, Somerset, Worcester and Gloucester have an aggregate orchard area of 124,872 acres. These five counties of the west and south-west of England—constituting in one continuous area what is essentially the cider country of Great Britain—embrace therefore rather less than half of the entire orchard area of the island, while Salop, Monmouth and Wilts have about 300 less than they had a few years ago. Five English counties have less than 1000 acres each of orchards, namely, the county of London, and the northern counties of Cumberland, Westmorland, Northumberland and Durham. Rutland has just over 100 acres. The largest orchard areas in Wales are in the two counties adjoining Hereford—Brecon with 1136 acres and Radnor with 777 acres; at the other extreme is Anglesey, with a decreasing orchard area of only 22 acres. Of the Scottish counties, Lanark takes the lead with 1285 acres, Perth, Stirling and Haddington following with 684 and 129 acres respectively. Ayr and Midlothian are the only other counties possessing 100 acres or more of orchards, whilst Kincardine, Orkney and Shetland return no orchard area, and Banff, Bute, Kinross, Nairn, Peebles, Sutherland and Wigtown return less than 10 acres each. It may be added that in 1908 Jersey returned 1090 acres of orchards, Guernsey, &c., 144 acres, and the Isle of Man, 121 acres; the two last-named places showing a decline as compared with eight years previously.

Outside the cider counties proper of England, the counties in which orchards for commercial fruit-growing have increased considerably in recent years include Berks, Buckingham, Cambridge, Essex, Lincoln, Middlesex, Monmouth, Norfolk,

Oxford, Salop, Sussex, Warwick and Wilts. Apples are the principal fruit grown in the western and south-western counties, pears also being fairly common. In parts of Gloucestershire, however, and in the Evesham and Pershore districts of Worcestershire, plum orchards exist. Plums are almost as largely grown as apples in Cambridgeshire. Large quantities of apples, plums, damsons, cherries, and a fair quantity of pears are grown for the market in Kent, whilst apples, plums and pears predominate in Middlesex. In many counties damsons are cultivated around fruit plantations to shelter the latter from the wind.

Of small fruit (currants, gooseberries, strawberries, raspberries, &c.) no return was made of the acreage previous to 1888, in which year it was given as 36,724 acres for Great Britain. In 1889 it rose to 41,933 acres.

Later figures are shown in Table III. It will be observed that, owing to corrections made in the enumeration in 1897, a consider-

TABLE III.—Areas of Small Fruit in Great Britain.

Year.	Acres.	Year.	Acres.	Year.	Acres.
1890	46,234	1894	68,415	1898	69,753
1891	58,704	1895	74,547	1899	71,526
1892	62,148	1896	76,245	1900	73,780
1893	65,487	1897	69,792	1901	74,999

able reduction in the area is recorded for that year, and presumably the error then discovered existed in all the preceding returns. The returns for 1907 gave the acreage of small fruit as 82,175 acres, and in 1908 at 84,880 acres—an area more than double that of 1889.

There has undoubtedly been a considerable expansion, rather than a contraction, of small fruit plantations since 1896. The acreage of small fruit in Great Britain is about one-third that of the orchards. As may be seen in Table IV., it is mainly confined to England, though Scotland has over 4000 more acres of small

TABLE IV.—Areas under Small Fruit in England, Wales and Scotland—Acres.

Year.	England.	Wales.	Scotland.	Great Britain.
1898	63,438	1044	5271	69,753
1899	64,867	1106	5553	71,526
1900	66,749	1109	5922	73,780
1901	67,828	1092	6079	74,999
1908	75,750	1200	7930	84,880

fruit than of orchards. About one-third of the area of small fruit in England belongs to Kent alone, that county having returned 24,137 acres in 1908. Cambridge now ranks next with 6878 acres, followed by Norfolk with 5876 acres, Worcestershire with 4852 acres, Middlesex with 4163 acres, Hants with 3320 acres and Essex with 2150 acres. It should be remarked that between 1900 and 1908 Cambridgeshire had almost doubled its area of small fruits, from 3740 to 6878 acres; whilst both Norfolk and Worcestershire in 1908 had larger areas devoted to small fruits than Middlesex—in which county there had been a decrease of about 400 acres during the same period. The largest county area of small fruit in Wales is 806 acres in Denbighshire, and in Scotland 2791 acres in Perthshire, 2259 acres in Lanarkshire, followed by 412 acres in Forfarshire. The only counties in Great Britain which make no return under the head of small fruit are Orkney and Shetland; and Sutherland only gives 2½ acres. It is hardly necessary to say that considerable areas of small fruit, in kitchen gardens and elsewhere, find no place in the official returns, which, however, include small fruit grown between and under orchard trees.

Gooseberries are largely grown in most small fruit districts. Currants are less widely cultivated, but the red currant is more extensively grown than the black, the latter having suffered seriously from the ravages of the black currant mite. Kent is the great centre for raspberries and for strawberries, though, in addition, the latter fruit is largely grown in Cambridgeshire (2411 acres), Hampshire (2327 acres), Norfolk (2067 acres) and Worcestershire (1273 acres). Essex, Lincolnshire, Cheshire,

Cornwall and Middlesex each has more than 500 acres devoted to strawberry cultivation.

The following statement from returns for 1908 shows the area under different kinds of fruit in 1907 and 1908 in Great Britain, and also whether there had been an increase or decrease:

	1907.	1908.	Increase or Decrease.
	Acres.	Acres.	Acres.
Small Fruit—			
Strawberries	27,827	28,815	+ 988
Raspberries	8,878	9,323	+ 445
Currants and Gooseberries	25,590	26,341	+ 651
Other kinds	19,880	20,501	+ 621
	82,175	84,880	+2705
Orchards—			
Apples	172,643	172,751	+ 108
Pears	8,911	9,624	+ 693
Cherries	12,027	11,868	- 159
Plums	14,901	15,683	+ 782
Other kinds	41,694	40,391	-1303
	250,176	250,297	+ 121

It appears from the Board of Agriculture returns that 27,433 acres of small fruit was grown in orchards, so that the total extent of land under fruit cultivation in Great Britain at the end of 1908 was about 308,000 acres.

There are no official returns as to the acreage devoted to orchard cultivation in Ireland. The figures relating to small fruit, moreover, extend back only to 1899, when the area under this head was returned as 4809 acres, which became 4359 acres in 1900 and 4877 acres in 1901. In most parts of the country there are districts favourable to the culture of small fruits, such as strawberries, raspberries, gooseberries and currants, and of top fruits, such as apples, pears, plums and damsons. The only localities largely identified with fruit culture as an industry are the Drogheda district and the Armagh district. In the former all the kinds named are grown except strawberries, the speciality being raspberries, which are marketed in Dublin, Belfast and Liverpool. In the Armagh district, again, all the kinds named are grown, but in this case strawberries are the speciality, the markets utilized being Richhill, Belfast, and those in Scotland. In the Drogheda district the grower bears the cost of picking, packing and shipping, but he cannot estimate his net returns until his fruit is on the market. Around Armagh the Scottish system prevails—that is, the fruit is sold while growing, the buyer being responsible for the picking and marketing.

The amount of fruit imported into the United Kingdom has such an important bearing on the possibilities of the industry that the following figures also may be useful:

The quantities of apples, pears, plums, cherries and grapes imported in the raw condition into the United Kingdom in each year, 1892 to 1901, are shown in Table V. Previous to 1892 apples only were separately enumerated. Up to 1899 inclusive the quantities were given in bushels, but in 1900 a change was made to hundred-weights. This renders the quantities in that and subsequent years not directly comparable with those in earlier years, but the comparison of the values, which are also given in the table, continues to hold good. The figures for 1908 have been added to show the increase that had taken place. In some years the value of imported apples exceeds the aggregate value of the pears, plums, cherries and grapes imported. The extreme values for apples shown in the table are £844,000 in 1893 and £2,079,000 in 1908. Grapes rank next to apples in point of value, and over the seventeen years the amount ranged between £394,000 in 1892 and £728,000 in 1908. On the average, the annual outlay on imported pears is slightly in excess of that on plums. The extremes shown are £167,000 in 1895 and £515,000 in 1908. In the case of plums, the smallest outlay tabulated is £166,000 in 1895, whilst the largest is £498,000 in 1897. The amounts expended upon imported cherries varied between £96,000 in 1895 and £308,000 in 1900. In 1900 apricots and peaches, imported raw, previously included with raw plums, were for the first time separately enumerated, the import into the United Kingdom for that year amounting to 13,689 cwt., valued at £25,846; in 1901 the quantity was 13,463 cwt. and the value £32,350. The latter

rose in 1908 to £60,000. In 1900, also, currants, gooseberries and strawberries, hitherto included in unenumerated raw fruit, were likewise for the first time separately returned. Of raw currants the import was 64,462 cwt., valued at £87,170 (1908, £121,850); of raw gooseberries 26,045 cwt., valued at £14,626 (1908, £25,520); and of raw strawberries, 52,225 cwt., valued at £85,949. In 1907 only 44,000 cwt. of strawberries were imported. In 1901 the quantities and values were respectively—currants, 70,402 cwt.,

TABLE V.—Imports of Raw Apples, Pears, Plums, Cherries and Grapes into the United Kingdom, 1892 to 1901. Quantities in Thousands of Bushels (thousands of cwt. in 1900 and 1901). Values in Thousands of Pounds Sterling.

Year.	Quantities.				
	Apples.	Pears.	Plums.	Cherries.	Grapes.
1892	4515	637	413	217	762
1893	3460	915	777	346	979
1894	4969	1310	777	311	833
1895	3292	407	401	196	865
1896	6177	483	560	219	883
1897	4200	1052	1044	312	994
1898	3459	492	922	402	1136
1899	3861	572	558	281	1158
1900	2129 ¹	477 ¹	423 ¹	243 ¹	593 ¹
1901	1830 ¹	349 ¹	264 ¹	213 ¹	680 ¹
	Values.				
1892	1354	297	200	135	394
1893	844	347	332	195	530
1894	1389	411	302	167	470
1895	960	167	166	96	487
1896	1582	207	242	106	443
1897	1187	378	498	178	495
1898	1108	222	435	231	550
1899	1186	266	294	154	588
1900	1225	367	393	308	595
1901	1183	296	244	214	605
1908	2079	515	428	235	728

¹ Thousands of cwt.

£75,308; gooseberries, 21,735 cwt., £11,420; strawberries, 38,604 cwt., £51,290. Up to 1899 the imports of tomatoes were included amongst unenumerated raw vegetables, so that the quantity was not separately ascertainable. For 1900 the import of tomatoes was 833,032 cwt., valued at £792,339, which is equivalent to a fraction under 2½d. per lb. For 1901 the quantity was 793,991 cwt. and the value £734,051; for 1906, there were 1,124,700 cwt., valued at £953,475; for 1907, 1,135,499 cwt., valued at £1,020,805; and for 1908, 1,160,283 cwt., valued at £955,983.

In 1908 the outlay of the United Kingdom upon imported raw fruits, such as can easily be produced at home, was £4,195,654, made up as follows:

Apples	£2,079,703	Plums	£428,966
Grapes	728,026	Currants	121,852
Pears	515,914	Apricots and peaches	60,141
Cherries	235,523	Gooseberries	25,529

In addition about £280,000 was spent upon "unenumerated" raw fruit, and £560,000 on nuts other than almonds "used as fruit," which would include walnuts and filberts, both produced at home. It is certain, therefore, that the expenditure on imported fruits, such as are grown within the limits of the United Kingdom, exceeds four millions sterling per annum. The remainder of the outlay on imported fruit in 1908, amounting to over £5,000,000, was made up of £2,269,651 for oranges, £471,713 for lemons, £1,769,249 for bananas, and £560,301 for almonds-nuts; these cannot be grown on an industrial scale in the British Isles.

It may be interesting to note the source of some of these imported fruits. The United States and Canada send most of the apples, the quantity for 1907 being 1,413,000 cwt. and 1,588,000 cwt. respectively, while Australia contributes 280,000 cwt. Plums come chiefly from France (200,000 cwt.), followed with 38,000 cwt. from Germany and 28,000 cwt. from the Netherlands. Pears are imported chiefly from France (204,000 cwt.) and Belgium (176,000); but the Netherlands send 52,000 cwt., and the United States 24,000 cwt. The great bulk of imported tomatoes comes from the Canary Islands, the quantity in 1907 being 604,692 cwt. The Channel Islands also sent 223,800 cwt., France 115,500 cwt., Spain 169,000 cwt., and Portugal a long way behind with 11,700 cwt. Most of the strawberries imported come from France (33,800 cwt.) and the Netherlands (10,300 cwt.).

Fruit-growing in Kent.—Kent is by far the largest fruit-growing county in England. For centuries that county has been famous for its fruit, and appears to have been the centre for the distribution of trees and grafts throughout the country. The cultivation

of fruit land upon farms in many parts of Kent has always been an important feature in its agriculture. An excellent description of this noteworthy characteristic of Kentish farming is contained in a comprehensive paper on the agriculture of Kent by Mr Charles Whitehead,¹ whose remarks, with various additions and modifications, are here reproduced.

Where the conditions are favourable, especially in East and Mid Kent, there is a considerable acreage of fruit land attached to each farm, planted with cherry, apple, pear, plum and damson trees, and with bush fruits, or soft fruits as they are sometimes called, including gooseberries, currants, raspberries, either with or without standard trees, and strawberries, and filberts and cob-nuts in Mid Kent. This acreage has largely increased, and will no doubt continue to increase, as, on the whole, fruit-growing has been profitable and has materially benefited those fortunate enough to have fruit land on their farms. There are also cultivators who grow nothing but fruit. These are principally in the district of East Kent, between Rochester and Canterbury, and in the district of Mid Kent near London, and they manage their fruit land, as a rule, better than farmers, as they give their undivided attention to it and have more technical knowledge. But there has been great improvement of late in the management of fruit land, especially of cherry and apple orchards, the grass of which is fed off by animals having corn or cake, or the land is well manured. Apple trees are grease-banded and sprayed systematically by advanced fruit-growers, to prevent or check the attacks of destructive insects. Far more attention is being paid to the selection of varieties of apples and pears having colour, size, flavour, keeping qualities, and other attributes to meet the tastes of the public, and to compete with the beautiful fruit that comes from the United States and Canada.

Of the various kinds of apples at present grown in Kent mention should be made of Mr Gladstone, Beauty of Bath, Devonshire Quarrenden, Lady Sudeley, Yellow Ingestre and Worcester Pearmain. These are dessert apples ready to pick in August and September, and are not stored. For storing, King of the Pippins, Cox's Orange Pippin (the best dessert apple in existence), Cox's Pomona, Duchesse Favourite, Gascoyne's Scarlet Seedling, Court Pendu Plat, Baumann's Red Reinette, Allington Pippin, Duke of Devonshire and Blenheim Orange. Among kitchen apples for selling straight from the trees the most usually planted are Lord Grosvenor, Lord Suffield, Keswick Codlin, Early Julian, Ecliville Seedling, Pott's Seedling, Early Rivers, Grenadier, Golden Spire, Stirling Castle and Domino. For storing, the cooking sorts favoured now are Stone's or Loddington, Warner's King, Wellington, Lord Derby, Queen Caroline, Tower of Glamis, Winter Queening, Lucombe's Seedling, Bismarck, Bramley's Seedling, Golden Noble and Lane's Prince Albert. Almost all these will flourish equally as standards, pyramids and bushes. Among pears are Hessele, Clapp's Favourite, William's Bon Chrétien, Beurré de Capiaumont, Fertilité, Beurré Riche, Chissel, Beurré Clairgeau, Louise Bonne of Jersey, Doyenne du Comice and Vicar of Winkfield. Among plums, Rivers's Early Prolific, Tsar, Belgian Purple, Black Diamond, Kentish Bush Plum, Pond's Seedling, Magnum Bonum and Victoria are mainly cultivated. The damson known as Farleigh Prolific, or Crittenden's, is most extensively grown throughout the county, and usually yields large crops, which make good prices. As a case in point, purchasers were offering to contract for quantities of this damson at £20 per ton in May of 1899, as the prospects of the yield were unsatisfactory. On the other hand, in one year recently when the crop was abnormally abundant, some of the fruit barely paid the expenses of sending to market. The varieties of cherries most frequently grown are Governor Wood, Knight's Early Black, Frogmore Blackheart, Black Eagle, Waterloo, Amberheart, Bigarreau, Napoleon Bigarreau and Turk. A variety of cherry known as the Kentish cherry, of a light red colour and fine subacid flavour, is much grown in Kent for drying and cooking purposes. Another cherry, similar in colour and quality, which comes rather late, known as the Flemish, is also extensively cultivated, as well as the very dark red large Morello, used for making cherry brandy. These three varieties are grown extensively as pyramids, and the last-named also on walls and sides of buildings. Sometimes the cherry crop is sold by auction to dealers, who pick, pack and consign the fruit to market. Large prices are often made, as much as £80 per acre being not uncommon. The crop on a large cherry orchard in Mid Kent has been sold for more than £100 per acre.

Where old standard trees have been long neglected and have become overgrown by mosses and lichens, the attempts made to improve them seldom succeed. The introduction of bush fruit trees dwarfed by grafting on the Paradise stock has been of much advantage to fruit cultivators, as they come into bearing in two or three years, and are more easily cultivated, pruned, sprayed and picked than standards. Many plantations of these bush trees have been formed in Kent of apples, pears and plums. Half standards and pyramid, have also been planted of these fruits, as well as of cherries. Bushes of gooseberries and currants, and clumps or stools of raspberry canes, have been planted to a great extent in many parts of the East and Mid divisions of Kent, but not much in the Weald, where apples are

principally grown. Sometimes fruit bushes are put in alternate rows with bush or standard trees of apple, pear, plum or damson, or they are planted by themselves. The distances apart for planting are generally for cherry and apple trees on grass 30 ft. by 30 ft.; for standard apples and pear trees from 20 ft. to 24 ft. upon arable land, with bush fruit, as gooseberries and currants, under them. These are set 6 ft. by 6 ft. apart, and 5 ft. by 2 ft. for raspberries, and strawberries 2 ft. 6 in. to 3 ft. by 1 ft. 6 in. to 1 ft. 3 in. apart. On some fruit farms bush or dwarf trees—apples, pears, plums—are planted alone, at distances varying from 8 ft. to 10 ft. apart, giving from 485 to 680 bush trees per acre, nothing being grown between them except perhaps strawberries or vegetables during the first two or three years. It is believed that this is the best way of ensuring fruit of high quality and colour. Another arrangement consists in putting standard apple or pear trees 30 ft. apart (48 trees per acre), and setting bush trees of apples or pears 15 ft. apart between them; these latter come quickly into bearing, and are removed when the standards are fully grown. Occasionally gooseberry or currant bushes, or raspberry canes or strawberry plants, are set between the bush trees, and taken away directly they interfere with the growth of these. Half standard apple or plum trees are set triangularly 15 ft. apart, and strawberry plants at a distance of 1½ ft. from plant to plant and 2½ ft. from row to row. Or currant or gooseberry bushes are set between the half standards, and strawberry plants between these.

These systems involve high farming. The manures used are London manure, where hops are not grown, and bone meal, superphosphate, rags, shoddy, wool-waste, fish refuse, nitrate of soda, kainit and sulphate of ammonia. Where hops are grown the London manure is wanted for them. Fruit plantations are always dug by hand with the Kent spud. Fruit land is never ploughed, as in the United States and Canada. The soil is levelled down with the "Canterbury" hoe, and the plantations are kept free from weeds with the ordinary draw or "plate" hoe. The best fruit farmers spray fruit trees regularly in the early spring, and continue until the blossoms come out, with quassia and soft soap and paraffin emulsions, and a very few with Paris green only, where there is no under fruit. In order to prevent and check the constant attacks of the various caterpillars and other insect pests. This is a costly and laborious process, but it pays well, as a rule. The fallacy that fruit trees on grass land require no manure, and that the grass may be allowed to grow up to their trunks without any harm, is exploding, and many fruit farmers are well manuring their grass orchards and removing the grass for some distance round the stems, particularly where the trees are young.

Strawberries are produced in enormous quantities in the northern part of the Mid Kent district round the Crays, and from thence to Orpington; also near Sandwich, and to some extent near Maidstone. Raspberry canes have been extensively put in during the last few years, and in some seasons yield good profits. There is a very great and growing demand for all soft fruits for jam-making, and prices are fairly good, taking an average of years, notwithstanding the heavy importations from France, Belgium, Holland, Spain and Italy. The extraordinary increase in the national demand for jam and other fruit preserves has been of great benefit to Kent fruit producers. The cheapness of duty-free sugar, as compared with sugar paying duty in the United States and other large fruit-producing countries, afforded one of the very few advantages possessed by British cultivators, but the reimposition of the sugar duty in the United Kingdom in 1901 has modified the position in this respect. Jam factories were established in several parts of Kent about 1890 or 1899, but most of them collapsed either from want of capital or from bad management. There are still a few remaining, principally in connexion with large fruit farms. One of these is at Swanley, whose energetic owners farm nearly 2000 acres of fruit land in Kent. The fruit grown by them that will not make satisfactory prices in a fresh raw state is made into jam, or if time presses it is first made into pulp, and kept until the opportunity comes for making it into jam. In this factory there are fifteen steam-jacketed vats in one row, and six others for candied peel. A season's output on a recent occasion comprised about 3500 tons of jam, 850 tons of candied peel and 750 gross (108,000 bottles) of bottled fruit. A great deal of the fruit preserved is purchased, whilst much of that grown on the farms is sold. A strigging machine is employed, which does as much work as fifty women in taking currants off their strigs or stalks. Black currant pulp is stored in casks till winter, when there is time to convert it into jam. Strawberries cannot be pulped to advantage, but it is otherwise with raspberries, the pulp of which is largely made. Apricots for jam are obtained chiefly from France and Spain. There is another flourishing factory near Sittingbourne worked on the same lines. It is very advantageous to fruit farmers to have jam factories in connexion with their farms or to have them near, as they can thoroughly grade their fruit, and send only the best to market, thus ensuring a high reputation for its quality. Carriage is saved, which is a serious charge, though railway rates from Kent to the great manufacturing towns and to Scotland are very much less proportionally than those to London, and consequently Kent growers send increasing quantities to these distant markets, where prices are better, not being so directly interfered with by imported fruit, which generally finds its way to London.

Kentish fruit-growers are becoming more particular in picking,

¹ *Jour. Roy. Agric. Soc.*, 1899.

grading, packing and storing fruit, as well as in marketing it. A larger quantity of fruit is now carefully stored, and sent to selected markets as it ripens, or when there is an ascertained demand, as it is found that if it is consigned to market direct from the trees there must frequently be forced sales and competition with foreign fruit that is fully matured and in good order. It was customary formerly for Kentish growers to consign all their fruit to the London markets; now a good deal of it is sent to Manchester, Birmingham, Liverpool, Sheffield, Newcastle and other large cities. Some is sent even to Edinburgh and Glasgow. Many large growers send no fruit to London now. It is by no means uncommon for growers to sell their fruit crops on the trees or bushes by auction or private treaty, or to contract to supply a stipulated quantity of specified fruit, say of currants, raspberries or strawberries, to jam manufacturers. There is a considerable quantity of fruit, such as grapes, peaches, nectarines, grown under glass, and this kind of culture tends to increase.

Filberts and cob-nuts are a special product of Kent, in the neighbourhood of Maidstone principally, and upon the Ragstone soils, certain conditions of soil and situation being essential for their profitable production. A part of the filbert and cob-nut crop is picked green in September, as they do well for dessert, though their kernels are not large or firm, and it pays to sell them green, as they weigh more heavily. One grower in Mid Kent has 100 acres of nuts, and has grown 100 tons in a good year. The average price of late years has been about 5d. per lb, which would make the gross return of the 100 acres amount to £4660. Kentish filberts have long been proverbial for their excellence. Cobs are larger and look better for dessert, though their flavour is not so fine. They are better croppers, and are now usually planted. This cultivation is not much extending, as it is very long before the trees come into full bearing. The London market is supplied entirely with these nuts from Kent, and there is some demand in America for them. Filbert and cob trees are most closely pruned. All the year's growth is cut away except the very finest young wood, which the trained eye of the tree-cutter sees at a glance in blossom-bearing. The trees are kept from 5½ to 7 ft. high upon stems from 1½ to 2 ft. high, and are trained so as to form a cup of from 7 to 8 ft. in diameter.

There seems no reason to expect any decrease in the acreage of fruit land in Kent, and if the improvement in the selection of varieties and in the general management continues it will yet pay. A hundred years ago every one was grubbing fruit land in order that hops might be planted, and for this many acres of splendid cherry orchards were sacrificed. Now the disposition is to grub hop plants and substitute apples, plums, or small fruit or cherry trees.

Fruit-growing in other Districts.—The large fruit plantations in the vicinity of London are to be found mostly in the valley of the Thames, around such centres as Brentford, Isleworth, Twickenham, Heston, Hounslow, Cranford and Southall. All varieties of orchard trees, but mostly apples, pears, and plums and small fruit, are grown in these districts, the nearness of which to the metropolitan fruit market at Covent Garden is of course an advantage. Some of the orchards are old, and are not managed on modern principles. They contain, moreover, varieties of fruit many of which are out of date and would not be employed in establishing new plantations. In the better-managed grounds the antiquated varieties have been removed, and their places taken by newer and more approved types. In addition to apples, pears, plums, damsons, cherries and quinces as top fruit, currants, gooseberries and raspberries are grown as bottom fruit. Strawberries are extensively grown in some of the localities, and in favourable seasons outdoor tomatoes are ripened and marketed.

Fruit is extensively grown in Cambridgeshire and adjacent counties in the east of England. A leading centre is Cottenham, where the Lower Greensand crops out and furnishes one of the best of soils for fruit-culture. In Cottenham about a thousand acres are devoted to fruit, and nearly the same acreage to asparagus, which is, however, giving place to fruit. Currants, gooseberries and strawberries are the most largely grown, apples, plums and raspberries following. Of varieties of plums the Victoria is first in favour, and then Rivers's Early Prolific, Tsar and Gisborne. London is the chief market, as it receives about half the fruit sent away, whilst a considerable quantity goes to Manchester, and some is sent to a neighbouring jam factory at Histon, where also a moderate acreage of fruit is grown. Another fruit-growing centre in Cambridgeshire is at Willingham, where—besides plums, gooseberries and raspberries—outdoor tomatoes are a feature. Greengages are largely grown near Cambridge. Wisbech is the centre of an extensive fruit district, situated partly in Cambridgeshire and partly in Norfolk. Gooseberries, strawberries and raspberries are largely grown, and as many as 80 tons of the first-named fruit have been sent away from Wisbech station in a single day. In the fruit-growing localities of Huntingdonshire apples, plums and gooseberries are the most extensively grown, but pears, greengages, cherries, currants, strawberries and raspberries are also cultivated. As illustrating variations in price, it may be mentioned that about the year 1880 the lowest price for gooseberries was £10 per ton, whereas it has since been down to £4. Huntingdonshire fruit is sent chiefly to Yorkshire, Scotland and South Wales, but railway freights are high.

Essex affords a good example of successful fruit-farming at Tiptree Heath, near Kelvedon, where under one management about 260

acres out of a total of 360 are under fruit. The soil, a stiff loam, grows strawberries to perfection, and 165 acres are allotted to this fruit. The other principal crops are 43 acres of raspberries and 30 acres of black currants, besides which there are small areas of red currants, gooseberries, plums, damsons, greengages, cherries, apples, quinces and blackberries. The variety of strawberry known as the Small Scarlet is a speciality here, and it occupies 55 acres, as it makes the best of jam. The Paxton, Royal Sovereign and Noble varieties are also grown. Strawberries stand for six or seven years on this farm, and begin to yield well when two years old. A jam factory is worked in conjunction with the fruit farm. Pulp is not made except when there is a glut of fruit. Perishable fruit intended for whole-fruit preserves is never held over after it is gathered. The picking of strawberries begins at 4 A.M., and the first lot is made into jam by 6 A.M.

Hampshire, like Cambridgeshire and Norfolk, are the only counties in which the area of small fruit exceeds that of orchards. The returns for 1908 show that Hampshire had 3320 acres of small fruit to 2326 acres of orchards; Cambridge had 6878 acres of small fruit to 5221 of orchards; and Norfolk had 5876 acres of small fruit against 5188 acres of orchards. Compared with twenty years previously, the acreage of small fruit had trebled. This is largely due in Hampshire to the extension of strawberry culture in the Southampton district, where the industry is in the hands of many small growers; few of whom cultivate more than 20 acres each. Sarisbury and Botley are the leading parishes in which the business is carried on. Most of the strawberry holdings are from half an acre to 5 acres in extent, a few are from 5 to 10 acres, fewer still from 10 to 20 acres and a half-a-dozen over the last limit; to sunners from one-year plants are used for planting, being found more fruitful than those from older plants. Peat-moss manure from London stables is much used, but artificial manures are also employed with good results. Shortly after flowering the plants are bedded down with straw at the rate of about 25 cwt. per acre. Picking begins some 12 days earlier than in Kent, at a date between 1st June and 15th June. The first week's gathering is sent mostly to London, but subsequently the greater part of the fruit goes to the Midlands and to Scotland and Ireland.

In recent years fruit-growing has much increased in South Worcestershire, in the vicinity of Evesham and Pershore. Hand-lights are freely used in the market gardens of this district for the protection of cucumbers and vegetable marrows, besides which tomatoes are extensively grown out of doors. At one time the egg plum and the Worcester damson were the chief fruit crops, apples and cherries ranking next, pears being grown to only a moderate extent. According to the 1908 returns, however, apples come first, plums second, pears third and cherries fourth. In a prolific season a single tree of the Damascene or Worcester damson will yield from 400 to 500 lb of fruit. There is a tendency to grow plum trees in the bush shape, as they are less liable than standards to injury from wind. The manures used include soot, fish guano, blood manure and phosphates—basic slag amongst the last-named. In the Pershore district, where there is a jam factory, plums are the chief tree fruit, whilst most of the orchard apples and pears are grown for cider and perry. Gooseberries are a feature, as are also strawberries, red and black currants and a few white, but raspberries are little grown. The soil, a strong or medium loam of fair depth, resting on clay, is so well adapted to plums that trees live for fifty years. In order to check the ravages of the winter moth, plum and apple trees are greebanded at the beginning of October and again at the end of March. The trees are also sprayed when necessary with insecticidal solutions. Pruning is done in the autumn. An approved distance apart at which to grow plum trees is 12 ft. by 12 ft. In the Earl of Coventry's fruit plantation, 40 acres in extent, at Croome Court, plums and apples are planted alternately, the bottom fruit being black currants, which are less liable to injury from birds than are red currants or gooseberries. Details concerning the methods of cultivation of fruit and flowers in various parts of England, the varieties commonly grown, the expenditure involved, and allied matters, will be found in Mr W. E. Bear's papers in the *Journal of the Royal Agricultural Society* in 1898 and 1899.

Apart altogether from market gardening and commercial fruit-growing, it must be borne in mind that an enormous business is done in the raising of young fruit-trees every year. Hundreds of thousands of apples, pears, plums, cherries, peaches, nectarines and apricots are budded or grafted each year on suitable stocks. They are trained in various ways, and are usually fit for sale the third year. These young trees replace old ones in private and commercial gardens, and are also used to establish new plantations in different parts of the kingdom.

The Woburn Experimental Fruit Farm.—The establishment in 1894 of the experimental fruit farm at Ridgmont, near Woburn, Beds, has exercised a healthy influence upon the progress and development of fruit-farming in England. The farm was founded and carried on by the public-spirited enterprise of the Duke of Bedford and Mr Spencer U. Pickering, the latter acting as director. The main object of the experimental station was "to ascertain facts relative to the culture of fruit, and to increase our knowledge of, and to improve our practice in, this industry." The farm is 20 acres in extent, and occupies a field which up to June 1894 had been used as

arable land for the ordinary rotation of farm crops. The soil is a sandy loam 9 or 10 in. deep, resting on a bed of Oxford Clay. Although it contains a large proportion of sand, the land would generally be termed very heavy, and the water often used to stand on it in places for weeks together in a wet season. The tillage to which the ground was subjected for the purposes of the fruit farm much improved its character, and in dry weather it presents as good a tilth as could be desired. Chemical analyses of the soil from different parts of the field show such wide differences that it is admitted to be by no means an ideal one for experimental purposes. Without entering upon further details, it may be useful to give a summary of the chief results obtained.

Apples have been grown and treated in a variety of ways, but of the different methods of treatment careless planting, coupled with subsequent neglect, has given the most adverse results, the crop of fruit being not 5% of that from trees grown normally. Of the separate deleterious items constituting total neglect, by far the most effective was the growth of weeds on the surface; careless planting, absence of manure, and the omission of trenching all had comparatively little influence on the results. A set of trees that had been carelessly planted and neglected, but subsequently tended in the early part of 1896, were in the autumn of that year only 10% behind their normally-treated neighbours, thus demonstrating that the response to proper attention is prompt. The growth of grass around young apple trees produced a very striking effect, the injury being much greater than that due to weeds. It is possible, however, that in wet years the ill-effects of both grass and weeds would be less than in dry seasons. Nevertheless, the grass-grown trees, after five years, were scarcely bigger than when planted, and the actual increase in weight which they showed during that time was about eighteen times smaller than in the case of similar trees in tilled ground. It is believed that one of the main causes of the ill-effects is the large increase in the evaporation of water from the soil which is known to be produced by grass, the trees being thereby made to suffer from drought, with constant deprivation of other nourishment as well. That grass growing round young apple trees is deleterious was a circumstance known to many horticulturists, but the extent to which it interferes with the development of the trees had never before been realized. Thousands of pounds are annually thrown away in England through want of knowledge of this fact. Yet trees will flourish in grass under certain conditions. Whether the dominant factor is the age (or size) of the tree has been investigated by grazing over trees which have hitherto been in the open ground, and the results appear to indicate that the grass is as deleterious to the older trees as it was to the younger ones. Again, it appears to have been demonstrated that young apple trees, at all events in certain soils, require but little or no manure in the early stages of their existence, so that in this case also large sums must be annually wasted upon manurial dressings which produce no effects. The experiments have dealt with dwarf trees of Bramley, Cox and Potts, six trees of each variety constituting one investigation. Some of the experiments were repeated with Stirling Castle, and others with standard trees of Bramley, Cox and Lane's Prince Albert. All were planted in 1894-1895, the dwarfs being then three years old and the standards four. In each experiment the "normal" treatment is altered in some one particular, this normal treatment consisting of planting the trees carefully in trenched ground, and subsequently keeping the surface clean; cutting back after planting, pruning moderately in autumn, and shortening the growths when it appeared necessary in summer; giving in autumn a dressing of mixed mineral manures, and in February one of nitrate of soda, this dressing being probably equivalent to one of 12 tons of dung per acre. In the experiments on branch treatment, the bad effects of omitting to cut the trees back on planting, or to prune them subsequently, is evident chiefly in the straggling and bad shape of the resulting trees, but such trees also are not so vigorous as they should be. The quantity of fruit borne, however, is in excess of the average. The check on the vigour and growth of a tree by cutting or injuring its roots is in marked contrast with the effects of a similar interference with the branches. Trees which had been root-pruned each year were in 1898 little more than half as big as the normal trees, whilst those root-pruned every second year were about two-thirds as big as the normal. The crops borne by these trees were nevertheless heavy in proportion to the size of the trees. Such frequent root-pruning is not, of course, a practice which should be adopted. It was found that trees which had been carefully lifted every other year and replanted at once experienced no ill-effects from the operation; but in a case where the trees after being lifted had been left in a shed for three days before replanting—which would reproduce to a certain extent the conditions experienced when trees are sent out from a nursery—material injury was suffered, these trees after four years being 28% smaller than similar ones which had not been replanted. Sets of trees planted respectively in November, January and March have, on the whole, shown nothing in favour of any of these different times for planting purposes. Some doubt is thrown on the accepted view that there is a tendency, at any rate with young apple and pear trees, to fruit in alternate seasons.

Strawberries of eighty-five different varieties have been experimented with, each variety being represented in 1900 by plants of five different ages, from one to five years. In 1896 and 1898 the

crops of fruit were about twice as heavy as in 1897 and 1899, but it has not been found possible to correlate these variations with the meteorological records of the several seasons. Taking the average of all the varieties, the relative weights of crop per plant, when these are compared with the two-year-old plants in the same season, are, for the five ages of one to five years, 31, 100, 122, 121 and 134, apparently showing that the bearing power increases rapidly up to two years, less rapidly up to three years, after which age it remains practically constant. The relative average size of the berries shows a deterioration with the age of the plant. The comparative sizes from plants of one to five years old were 115, 100, 96, 91 and 82 respectively. If the money value of the crop is taken to be directly dependent on its total weight, and also on the size of the fruits, the relative values of the crop for the different ages would be 34, 100, 117, 111 and 110, so that, on the Ridgmont ground, strawberry plants could be probably retained up to five years and probably longer. As regards what may be termed the order of merit of different varieties of strawberries, it appears that even small differences in position and treatment cause large variations, not only in the features of the crop generally, but also in the relative behaviour of the different varieties. The relative cropping power of the varieties under apparently similar conditions may often be expressed by a number five or tenfold as great in one case as in the other. A comparison of the relative behaviour of the same varieties in different seasons is attended by similar variations. The varying sensitiveness of different varieties of strawberries plants to small and undefinable differences in circumstances is indeed one of the most important facts brought to light in the experiments.

Fruit Culture in Ireland.—The following figures have been kindly supplied by the Irish Board of Agriculture, and deal with the acreage under fruit culture in Ireland up to the end of the year 1907.

	Statute Acres.
1. Orchard Fruit—	
Apples	5829
Pears	224
Plums	223
Damsons	138
Other kinds	129
Total	6543
2. Small Fruit—	
Currants, black	234
Currants, red and white	159
Gooseberries	675
Raspberries	374
Strawberries	994
Mixed fruit	2470
Total	4906

It therefore appears that while Ireland grows only about one-thirty-third the quantity of apples that England does, it is nevertheless nearly 5000 acres ahead of Scotland and about 2000 acres ahead of Wales. It grows 41 times fewer pears than England, but still is ahead of Scotland and a long way ahead of Wales in this fruit. There are 70 times fewer plums grown in Ireland than in England, and about the same in Scotland, while Wales does very little indeed. In small fruit Ireland is a long way behind Scotland in the culture of strawberries and raspberries, although with currants and gooseberries it is very close. Considering the climate, and the fact that there are, according to the latest available returns, over 62,000 holdings above 1 acre but not exceeding 5 acres (having a total of 224,000 acres), it is possible fruit culture may become more prevalent than it has been in the past.

The Flower-growing Industry.—During the last two or three decades of the 19th century a very marked increase in flower production occurred in England. Notably was this the case in the neighbourhood of London, where, within a radius of 15 or 20 m., the fruit crops, which had largely taken the place of garden vegetables, were themselves ousted in turn to satisfy the increasing demand for land for flower cultivation. No flower has entered more largely into the development of the industry than the narcissus or daffodil, of which there are now some 600 varieties. Comparatively few of these, however, are grown for market purposes, although all are charming from the amateur point of view. On some flower farms a dozen or more acres are devoted to narcissi alone, the production of bulbs for sale as well as of flowers for market being the object of the growers.

In the London district the country in the Thames valley west of the metropolis is as largely occupied by flower farms as it is by fruit farms—in fact, the cultivation of flowers is commonly associated with that of fruit. In the vicinity of Richmond narcissi are extensively grown, as they also are more to the west in the Long Ditton district, and likewise around Twickenham, Isleworth, Hounslow, Feltham and Hampton. Roses come more into evidence in the neighbourhood of Hounslow, Cranford,

Hillingdon and Uxbridge, and in some gardens daffodils and roses occupy alternate rows. In this district also such flowers as herbaceous peonies, Spanish irises, German irises, Christmas roses, lilies of the valley, chrysanthemums, foxgloves, hollyhocks, wallflowers, carnations, &c., are extensively grown in many market gardens. South of London is the Mitcham country, long noted for its production of lavender. The incessant growth of the lavender plant upon the same land, however, has led to the decline of this industry, which has been largely transferred to districts in the counties of Bedford Essex and Hertford. At Mitcham, nevertheless, mixed flowers are very largely grown for the supply of the metropolis, and one farm alone has nearly 100 acres under flowers and glass-houses. Chrysanthemums, asters, Iceland poppies, gaillardias, pansies, bedding calceolarias, zonal pelargoniums and other plants are cultivated in immense quantities. At Swanley and Eynsford, in Kent, flowers are extensively cultivated in association with fruit and vegetables. Narcissi, chrysanthemums, violets, carnations, campanulas, roses, pansies, irises, sweet peas, and many other flowers are here raised, and disposed of in the form both of cut flowers and of plants.

The Scilly Isles are important as providing the main source of supply of narcissi to the English markets in the early months of the year. This trade arose almost by accident, for it was about the year 1865 that a box of narcissi sent to Covent Garden Market, London, realized £1; and the knowledge of this fact getting abroad, the farmers of the isles began collecting wild bulbs from the fields in order to cultivate them and increase their stocks. Some ten years, however, elapsed before the industry promised to become remunerative. In 1885 a Bulb and Flower Association was established to promote the industrial growth of flowers. The exports of flowers in that year reached 65 tons, and they steadily increased until 1893, when they amounted to 450 tons. A slight decline followed, but in 1896 the quantity exported was no less than 514 tons. This would represent upwards of 3½ million bunches of flowers, chiefly narcissi and anemones. Rather more than 500 acres are devoted to flower-growing in the isles, by far the greater part of this area being assigned to narcissi, whilst anemones, gladioli, marguerites, arum lilies, Spanish irises, pinks and wallflowers are cultivated on a much smaller scale. The great advantage enjoyed by the Scilly flower-growers is earliness of production, due to climatic causes; the soil, moreover, is well suited to flower culture and there is an abundance of sunshine. The long journey to London is somewhat of a drawback, in regard to both time and freight, but the earliness of the flowers more than compensates for this. Open-air narcissi are usually ready at the beginning of January, and the supply is maintained in different varieties up to the middle or end of May. The narcissus bulbs are usually planted in October, 4 in. by 3 in. apart for the smaller sorts and 6 in. by 4 to 6 in. for the larger. A compost of farmyard manure, seaweed, earth and road scrapings is the usual dressing, but nitrate of soda, guano and bones are also occasionally employed. A better plan, perhaps, is to manure heavily the previous crop, frequently potatoes, no direct manuring then being needed for the bulbs, these not being left in the ground more than two or three years. The expenses of cultivation are heavy, the cost of bulbs alone—of which it requires nearly a quarter of a million of the smaller varieties, or half as many of the largest, to plant an acre—being considerable. The polyanthus varieties of narcissus are likely to continue the most remunerative to the flower-growers of Scilly, as they flourish better in these isles than on the mainland.

In the district around the Wash, in the vicinity of such towns as Wisbech, Spalding and Boston, the industrial culture of bulbs and flowers underwent great expansion in the period between 1880 and 1900. At Wisbech one concern alone has a farm of some 900 acres, devoted chiefly to flowers and fruit, the soil being a deep fine alluvium. Roses are grown here, one field containing upwards of 100,000 trees. Nearly 20 acres are devoted to narcissi, which are grown for the bulbs and also, together with tulips, for cut flowers. Carnations are cultivated

both in the field and in pots. Cut flowers are sent out in large quantities, neatly and effectively packed, the parcel post being mainly employed as a means of distribution. In the neighbourhood of Spalding crocuses and snowdrops are less extensively grown than used to be the case. On one farm, however, upwards of 20 acres are devoted to narcissi alone, whilst gladioli, lilies and irises are grown on a smaller scale. Around Boston narcissi are also extensively grown for the market, both bulbs and cut blooms being sold. The bulbs are planted 3 in. apart in rows, the latter being 9 in. apart, and are allowed to stand from two to four years.

The imports of fresh flowers into the United Kingdom were not separately shown prior to 1900. In that year, however, their value amounted to £200,585, in 1901 to £225,011, in 1906 to £233,884, in 1907 to £233,641, and in 1908 to £229,802, so that the trade showed a fairly steady condition. From the monthly totals quoted in Table VI. it would appear that the trade sinks to its minimum

TABLE VI.—Values of Fresh Flowers imported into the United Kingdom.

Month.	1906.	1907.	1908.
January	£31,035	£18,545	£29,180
February	34,647	25,541	30,541
March	50,232	42,611	35,185
April	30,809	50,418	42,681
May	22,980	21,767	23,129
June	17,641	18,358	16,904
July	3,386	4,509	3,467
August	1,646	1,539	1,081
September	852	736	953
October	4,481	3,180	4,304
November	17,506	15,763	15,097
December	18,669	30,674	27,080
Total	£233,884	£233,641	£229,802

dimensions in the four months July to October inclusive, and that after September the business continually expands up to April, subsequent to which contraction again sets in. About one-half of the trade belongs practically to the three months of February, March and April.

Hothouse Culture of Fruit and Flowers.—The cultivation of fruit and flowers under glass has increased enormously since about the year 1880, especially in the neighbourhood of London, where large sums of money have been sunk in the erection and equipment of hothouses. In the parish of Cheshunt, Herts, alone there are upwards of 130 acres covered with glass, and between that place on the north and London on the south extensive areas of land are similarly utilized. In Middlesex, in the north, in the districts of Edmondton, Enfield, Ponders End and Finchley, and in the west from Isleworth to Hampton, Feltham, Hillingdon, Sipson and Uxbridge, many crops are now cultivated under glass. At Erith, Swanley, and other places in Kent, as also at Worthing, in Sussex, glass-house culture has much extended. A careful estimate puts the area of industrial hothouses in England at about 1200 acres, but it is probably much more than this. Most of the greenhouses are fixtures, but in some parts of the kingdom structures that move on rails and wheels are used, to enable the ground to be prepared in the open for one crop while another is maturing under glass. The leading products are grapes, tomatoes and cucumbers, the last-named two being true fruits from the botanist's point of view, though commercially included with vegetables. To these may be added on the same ground dwarf or French beans, and runner or climbing beans. Peaches, nectarines and strawberries are largely grown under glass, and, in private hothouses—from which the produce is used mainly for household consumption, and which are not taken into consideration here—pineapples, figs and other fruit. Conservative estimates indicate the average annual yield of hothouse grapes to be about 12 tons per acre and of tomatoes 20 tons. The greater part of the space in the hothouses is assigned to fruit, but whilst some houses are devoted exclusively to flowers, in others, where fruit is the main object, flowers are forced in considerable quantities in winter and early spring. The flowers grown under glass include tulips, hyacinths, primulas, cyclamens, spiraeas, mignonettes, fuchsias,

calceolarias, roses, chrysanthemums, daffodils, arum lilies or callas, liliiums, azaleas, eucharis, camellias, stephanotis, tuberose, bouvardias, gardenias, heaths or ericas, poinsettias, lilies of the valley, zonal pelargoniums, tuberous and fibrous rooted begonias, and many others. There is an increasing demand for foliage hothouse plants, such as ferns, palms, crotons, aspidistras, araucarias, dracaenas, India-rubber plants, aralias, grevilleas, &c. Berried plants like solanums and aucubas also find a ready sale, while the ornamental kinds of asparagus such as *sprengeri* and *plumosus nanus*, are ever in demand for trailing decorations, as well as myrsiphyllum. Special mention must be made of the winter or perpetual flowering carnations which are now grown by hundreds of thousands in all parts of the kingdom for decorative work during the winter season. The converse of forcing plants into early blossom is adopted with such an important crop as lily of the valley. During the summer season the crowns are placed in refrigerators with about 2 degrees of frost, and quantities are taken out as required every week and transferred to the greenhouse to develop. Tomatoes are grown largely in houses exclusively occupied by them, in which case two and sometimes three crops can be gathered in the year. In the Channel Islands, where potatoes grown under glass are lifted in April and May, in order to secure the high prices of the early markets, tomato seedlings are planted out from boxes into the ground as quickly as the potatoes are removed, the tomato planter working only a few rows behind the potato digger. The trade in imported tomatoes is so considerable that home growers are well justified in their endeavours to meet the demand more fully with native produce, whether raised under glass or in the open. Tomatoes were not separately enumerated in the imports previous to 1900. It has already been stated that in 1900 the raw tomatoes imported amounted to 833,032 cwt., valued at £792,339, and in 1901 to 793,991 cwt., valued at £734,051. From the monthly quantities given in Table VII.

TABLE VII.—Quantities of Tomatoes imported into the United Kingdom.

Month.	1906.	1907.	1908.
January	61,940	56,022	73,409
February	58,187	58,289	69,350
March	106,458	98,028	86,928
April	103,273	109,057	74,917
May	67,933	114,041	88,901
June	62,906	144,379	127,793
July	238,362	150,907	171,978
August	180,046	102,600	124,757
September	114,860	101,198	119,224
October	52,678	67,860	75,722
November	41,513	66,522	74,292
December	36,316	66,591	73,012
Total	1,124,472	1,135,494	1,160,283
Value	£953,475	£1,135,499	£1,160,283

it would appear that the imports are largest in June, July and August, about one-half of the year's total arriving during those three months. It is too early in June and July for home-grown outdoor tomatoes to enter into competition with the imported product, but home-grown hothouse tomatoes should be qualified to challenge this trade.

An important feature of modern flower growing is the production and cultivation of what are known as "hardy herbaceous perennials." Some 2000 or 3000 different species and varieties of these are now raised in special nurseries, and during the spring, summer and autumn seasons magnificent displays are to be seen not only in the markets but at the exhibitions in London and at the great provincial shows held throughout the kingdom. The production of many of these perennials is so easy that amateurs in several instances have taken it up as a business hobby; and in some cases, chiefly through advertising in the horticultural press, very lucrative concerns have been established.

Ornamental flowering trees and shrubs constitute another

feature of modern gardening. These are grown and imported by thousands chiefly for their sprays of blossom or foliage, and for planting in large or small gardens, public parks, &c., for landscape effect. Indeed there is scarcely an easily grown plant from the northern or southern temperate zones that does not now find a place in the nursery or garden, provided it is sufficiently attractive to sell for its flowers, foliage or appearance.

Conditions of the Fruit and Flower growing Industries.—As regards open-air fruit-growing, the outlook for new ventures is perhaps brighter than in the hothouse industry, not—as Mr Bear has pointed out—because the area of fruit land in England is too small, but because the level of efficiency, from the selection of varieties to the packing and marketing of the produce, is very much lower in the former than in the latter branch of enterprise. In other words, whereas the practice of the majority of hothouse nurserymen is so skilled, so up-to-date, and so entirely under high pressure that a new competitor, however well trained, will find it difficult to rise above mediocrity, the converse is true of open-air fruit-growers. Many, and an increasing proportion, of the latter are thoroughly efficient in all branches of their business, and are in possession of plantations of the best market varieties of fruit, well cultivated, pruned and otherwise managed. But the extent of fruit plantations completely up to the mark in relation to varieties and treatment of trees and bushes, and in connexion with which the packing and marketing of the produce are equally satisfactory, is small in proportion to the total fruit area of the country. Information concerning the best treatment of fruit trees has spread widely in recent years, and old plantations, as a rule, suffer from the neglect or errors of the past, however skilful their present holders may be. Although the majority of professional market fruit-growers may be well up to the standard in skill, there are numerous contributors to the fruit supply who are either ignorant of the best methods of cultivation and marketing or careless in their application. The bad condition of the great majority of farm orchards is notorious, and many landowners, farmers and amateur gardeners, who have planted fruit on a more or less extensive scale have mismanaged their undertakings. For these reasons new growers of open-air fruit for market have opportunities of succeeding by means of superiority to the majority of those with whom they will compete, provided that they possess the requisite knowledge, energy and capital. It has been asserted on sound authority that there is no chance of success for fruit-growers except in districts favourable as regards soil, climate and nearness to a railway or a good market; and, even under these conditions, only for men who have had experience in the industry and are prepared to devote their unremitting attention to it. Most important is it to a beginner that he should ascertain the varieties of fruit that flourish best in his particular district. Certain kinds seem to do well or fairly well in all parts of the country; others, whilst heavy croppers in some localities, are often unsatisfactory in others.

As has been intimated, there is probably in England less room for expansion of fruit culture under glass than in the open. The large increase of glass-houses in modern times appears to have brought the supply of hothouse produce, even at greatly reduced prices, at least up to the level of the demand; and as most nurserymen continue to extend their expanse of glass, the prospect for new competitors is not a bright one. Moreover, the vast scale upon which some of the growers conduct the hothouse industry puts small producers at a great disadvantage, not only because the extensive producers can grow grapes and other fruit more economically than small growers—with the possible exception of those who do all or nearly all their own work—but also, and still more, because the former have greater advantages in transporting and marketing their fruit. There has, in recent years, been a much greater fall in the prices of hothouse than of open-air fruit, especially under the existing system of distribution, which involves the payment by consumers of 50 to 100% more in prices than growers receive. The best openings for new nurseries are probably not where they are now to be found in large groups, and especially not in the neighbourhood

of London, but in suitable spots near the great centres of population in the Midlands and the North, or big towns elsewhere not already well supplied with nurseries. By such a selection of a locality the beginner may build up a retail trade in hothouse fruit, or at least a trade with local fruiterers and grocers, thus avoiding railway charges and salesmen's commissions to a great extent, though it may often be advantageous to send certain kinds of produce to a distant market. Above all, a man who has no knowledge of the hothouse industry should avoid embarking his capital in it, trusting himself in the hands of a foreman, as experience shows that such a venture usually leads to disaster. Some years of training in different nurseries are desirable for any young man who is desirous of becoming a grower of hothouse fruits or flowers.

There can be no doubt that flower-growing is greatly extending in England, and that competition among home growers is becoming more severe. Foreign supplies of flowers have increased, but not nearly as greatly in proportion as home supplies, and it seems clear that home growers have gained ground in relation to their foreign rivals, except with respect to flowers for the growth of which foreigners have extraordinary natural advantages. There seems some danger of the home culture of the narcissus being over-done, and the florists' chrysanthemum appears to be produced in excess of the demand. Again, in the production of violets the warm and sunny South of France has an advantage not possessed by England, whilst Holland, likewise for climatic reasons, maintains her hold upon the hyacinth and tulip trade. Whether the production of flowers as a whole is gaining ground upon the demand or not is a difficult question to answer. It is true that the prices of flowers have fallen generally; but production, at any rate under glass, has been cheapened, and if a fair profit can be obtained, the fall in prices, without which the existing consumption of flowers would be impossible, does not necessarily imply over-production. There is some difference of opinion among growers upon this point; but nearly all agree that profits are now so small that production on a large scale is necessary to provide a fair income. Industrial flower-growing affords such a wide scope for the exercise of superior skill, industry and alertness, that it is not surprising to find some who are engaged in it doing remarkably well to all appearance, while others are struggling on and hardly paying their way. That a man with only a little capital, starting in a small way, has many disadvantages is certain; also, that his chance of saving money and extending his business quickly is much smaller than it was. To the casual looker-on, who knows nothing of the drudgery of the industry, flower-growing seems a delightful method of getting a living. That it is an entrancing pursuit there is no doubt; but it is equally true that it is a very arduous one, requiring careful forethought, ceaseless attention and abundant energy. Fortunately for those who might be tempted, without any knowledge of the industry, to embark capital in it, flower-growing, if at all comprehensive in scope, so obviously requires a varied and extensive technical knowledge, combined with good commercial ability, that any one can see that a thorough training is necessary to a man who intends to adopt it as a business, especially if hothouse flowers are to be produced.

The market for fruit, and more especially for flowers, is a fickle one, and there is nearly always some uncertainty as to the course of prices. The perishable nature of soft fruit and cut flowers renders the markets very sensitive to anything in the nature of a glut, the occurrence of which is usually attended with disastrous results to producers. Foreign competition, moreover, has constantly to be faced, and it is likely to increase rather than diminish. French growers have a great advantage over the open-air cultivators of England, for the climate enables them to get their produce into the markets early in the season, when the highest prices are obtainable. The geographical advantage which France enjoys in being so near to England is, however, considerably discounted by the increasing facilities for cold storage in transit, both by rail and sea. The development of such facilities permits of the retail sale of luscious fruit as fresh and attractive as when it was gathered beneath the sunny skies of California. In the case of flowers, fashion is an element not to be ignored. Flowers much in request in one season may meet with very little demand in another, and it is difficult

for the producer to anticipate the changes which caprice may dictate. Even for the same kind of flower the requirements are very uncertain, and the white blossom which is all the rage in one season may be discarded in favour of one of another colour in the next. The sale of fresh flowers for church decoration at Christmas and Easter has reached enormous dimensions. The irregularity in the date of the festival, however, causes some inconvenience to growers. If it falls very early the great bulk of suitable flowers may not be sufficiently forward for sale, whilst a late Easter may find the season too far advanced. The trade in cut flowers, therefore, is generally attended by uncertainty, and often by anxiety. (W. Fa.; J. Wa.)

UNITED STATES

In the United States horticulture and market gardening have now assumed immense proportions. In a country of over 3,000,000 sq. m., stretching from the Atlantic to the Pacific on the one hand, and from the Gulf of Mexico to the great northern lakes and the Dominion of Canada on the other, a great variation of climatic conditions is not unnatural. From a horticultural point of view there are practically two well-defined regions: (1) that to the east of the Rocky Mountains across to the Atlantic, where the climate is more like that of eastern Asia than of western Europe so far as rainfall, temperature and seasonable conditions are concerned; (2) that to the west of the Rockies, known as the Pacific coast region, where the climate is somewhat similar to that of western Europe. It may be added that in the northern states—in Washington, Montana, North Dakota, Minnesota, Wisconsin, &c.—the winters are often very severe, while the southern states practically enjoy a temperature somewhat similar to that of the Riviera. Indeed the range of temperature between the extreme northern states and the extreme southern may vary as much as 120° F. The great aim of American gardeners, therefore, has been to find out or to produce the kinds of fruits, flowers and vegetables that are likely to flourish in different parts of this immense country.

Fruit Culture.—There is probably no country in the world where so many different kinds of fruit can be grown with advantage to the nation as in the United States. In the temperate regions apples, pears and plums are largely grown, and orchards of these are chiefly to be found in the states of New York, Massachusetts, Pennsylvania, Michigan, Missouri, Colorado, and also in northern Texas, Arkansas and N. California. To these may be added cranberries and quinces, which are chiefly grown in the New England states. The quinces are not a crop of first-rate importance, but as much as 800,000 bushels of cranberries are grown each year. The peach orchards are assuming great proportions, and are chiefly to be found in Georgia and Texas, while grapes are grown throughout the Republic from east to west in all favourable localities. Oranges, lemons and citrons are more or less extensively grown in Florida and California, and in these regions what are known as Japanese or "Kelsey" plums (forms of *Prunus triflora*) are also grown as marketable crops. Pomegranates are not yet largely grown, but it is possible their culture will develop in southern Texas and Louisiana, where the climate is tempered by the waters of the Gulf of Mexico. Tomatoes are grown in most parts of the country so easily that there is frequently a glut; while the strawberry region extends from Florida to Virginia, Pennsylvania and other states—thus securing a natural succession from south to north for the various great market centres.

Of the fruits mentioned apples are undoubtedly the most important. Not only are the American people themselves supplied with fresh fruit, but immense quantities are exported to Europe—Great Britain alone absorbing as much as 1,430,000 cwt. in 1908. The varieties originally grown were of course those taken or introduced from Europe by the early settlers. Since the middle of the 19th century great changes have been brought about, and the varieties mostly cultivated now are distinctly American. They have been raised by crossing and intercrossing the most suitable European forms with others since imported from Russia. In the extreme northern states indeed, where it is essential to have apple trees that will stand the severest winters, the Russian varieties crossed with the betry crab of eastern Europe (*Pyrus baccata*) have produced

a race eminently suited to that particular region. The individual fruits are not very large, but the trees are remarkably hardy. Farther south larger fruited varieties are grown, and among these may be noted Baldwins, Newton pippins, Spitzenbergs and Rhode Island greening. Apple orchards are numerous in the State of New York, where it is estimated that over 100,000 acres are devoted to them. In the hilly regions of Missouri, Arkansas and Colorado there are also great plantations of apples. The trees, however, are grown on different principles from those in New York State. In the latter state apple trees with ordinary care live to more than 100 years of age and produce great crops; in the other states, however, an apple tree is said to be middle-aged at 20, decrepit at 30 and practically useless at 40 years of age. They possess the advantage, however, of bearing early and heavily.

Until the introduction of the cold-storage system, about the year 1880, America could hardly be regarded as a commercial fruit-growing country. Since then, however, owing to the great improvements made in railway refrigerating vans and storage houses, immense quantities of fruit can be despatched in good condition to any part of the world; or they can be kept at home in safety until such time as the markets of Chicago, New York, Boston, Baltimore, Philadelphia, &c., are considered favourable for their reception.

Apple trees are planted at distances varying from 25 ft. to 30 ft. apart in the middle western states, to 40 ft. to 50 ft. apart in New York State. Here and there, however, in some of the very best orchards the trees are planted 60 ft. apart every way. Each tree thus has a chance to develop to its utmost limits, and as air and light reach it better, a far larger fruit-bearing surface is secured. Actual experience has shown that trees planted at 60 ft. apart—about 28 to the acre—produce more fruit by 43 bushels than trees at 30 ft. apart—i.e. about 48 to the acre.

Until recent years pruning as known to English and French gardeners was practically unknown. There was indeed no great necessity for it, as the trees, not being cramped for space, threw their branches outwards and upwards, and thus rarely become overcrowded. When practised, however, the operation could scarcely be called pruning; lopping or trimming would be more accurate descriptions.

Apple orchards are not immune from insect pests and fungoid diseases, and an enormous business is now done in spraying machines and various insecticides. It pays to spray the trees, and figures have been given to show that orchards that have been sprayed four times have produced an average income of £211 per acre against £103 per acre from unsprayed orchards.

The spring frosts are also troublesome, and in the Colorado and other orchards the process known as "smudging" is now adopted to save the crops. This consists in placing 20 or 30, or even more, iron or tin pots to an acre, each pot containing wooden chips soaked in tar (or pitch) mixed with kerosene. Whenever the thermometer shows 3 or 4 degrees of frost the smudge-pots are lighted. A dense white smoke then arises and is diffused throughout the orchards, enveloping the blossoming heads of the trees in a dense cloud. This prevents the frost from killing the tender pistils in the blossoms, and when several smudge-pots are alight at the same time the temperature of the orchard is raised two or three degrees. This work has generally to be done between 3 and 5 A.M., and the growers naturally have an anxious time until all danger is over. The failure to attend to smudging, even on one occasion, may result in the loss of the entire crop of plums, apples or pears.

Next to apples perhaps peaches are the most important fruit crop. The industry is chiefly carried on in Georgia, Texas and S. Carolina, and on a smaller scale in some of the adjoining states. Peaches thus flourish in regions that are quite unsuitable for apples or pears. In many orchards in Georgia, where over 3,000,000 acres have been planted, there are as many as 100,000 peach trees; while some of the large fruit companies grow as many as 365,000. In one place in West Virginia there is, however, a peach orchard containing 175,000 trees, and in Missouri another company has 3 sq. m. devoted

to peach culture. As a rule the crops do well. Sometimes, however, a disease known as the "yellows" makes sad havoc amongst them, and scarcely a fruit is picked in an orchard which early in the season gave promise of a magnificent crop.

Plums are an important crop in many states. Besides the European varieties and those that have been raised by crossing with American forms, there is now a growing trade done in Japanese plums. The largest of these is popularly known as "Kelseys," named after John Kelsey, who raised the first fruit in 1876 from trees brought to California in 1870. Sometimes the fruits are 3 in. in diameter, and like most of the Japanese varieties are more heart-shaped and pointed than plums of European origin. One apparent drawback to the Kelsey plum is its irregularity in ripening. It has been known in some years to be quite ripe in June, while in others the fruits are still green in October.

Pears are much grown in such states as Massachusetts, New York, Pennsylvania, Missouri and California; while bush fruits like currants, gooseberries and raspberries find large spaces devoted in most of the middle and northern states. Naturally a good deal of crossing and intercrossing has taken place amongst the European and American forms of these fruits, but so far as gooseberries are concerned no great advance seems to have been made in securing varieties capable of resisting the devastating gooseberry mildew.

Other fruits of more or less commercial value are oranges, lemons and citrons, chiefly in Florida. Lemons are practically a necessity to the American people, owing to the heat of the summers, when cool and refreshing drinks with an agreeable acidulous taste are in great demand. The pomelo (grape-fruit) is a kind of lemon with a thicker rind and a more acid flavour. At one time its culture was confined to Florida, but of recent years it has found its way into Californian orchards. Notwithstanding the prevailing mildness of the climate in both California and Florida, the crops of oranges, lemons, citrons, &c., are sometimes severely injured by frosts when in blossom.

Other fruits likely to be heard of in the future are the kaki or persimmon, the loquat, which is already grown in Louisiana, as well as the pomegranate.

Great aid and encouragement are given by the government to the progress of American fruit-growing, and by the experiments that are being constantly carried out and tabulated at Cornell University and by the U.S.A. department of agriculture.

Flower Culture.—So far as flowers are concerned there appears to be little difference between the kinds of plants grown in the United States and in England, France, Belgium, Germany, Holland, &c. Indeed there is a great interchange of new varieties of plants between Europe and America, and modifications in systems of culture are being gradually introduced from one side of the Atlantic to the other. The building of greenhouses for commercial purposes is perhaps on a somewhat different scale from that in England, but there are probably no extensive areas of glass such as are to be seen north of London from Enfield Highway to Broxburne. Hot water apparatus differs merely in detail, although most of the boilers used resemble those on the continent of Europe rather than in England. Great business is done in bulbs—mostly imported from Holland—stove and greenhouse plants, hardy perennials, orchids, ferns of the "fancy" and "dagger" types of *Nephrolepis*, and in carnations and roses. Amongst the latter thousands of such varieties as Beauty, Liberty, Killarney, Richmond and Bride are grown, and realize good prices as a rule in the markets. Carnations of the winter-flowering or "perpetual" type have long been grown in America, and enormous prices have been given for individual plants on certain occasions, rivalling the fancy prices paid in England for certain orchids. The American system of carnation-growing has quite captivated English cultivators, and new varieties are being constantly raised in both countries. Chrysanthemums are another great feature of American florists, and sometimes during the winter season a speculative grower will send a living specimen to one of the London exhibitions in the hope of booking large orders for cuttings of it later on. Sweet

peas, dahlias, lilies of the valley, arum lilies and indeed every flower that is popular in England is equally popular in America, and consequently is largely grown.

Vegetables.—So far as these are concerned, potatoes, cabbages, cauliflower, beans of all kinds, cucumbers, tomatoes (already referred to under fruits), musk-melons, lettuces, radishes, endives, carrots, &c.; are naturally grown in great quantities, not only in the open air, but also under glass. The French system of intensive cultivation as practised on hot beds of manure round Paris is practically unknown at present. In the southern states there would be no necessity to practise it, but in the northern ones it is likely to attract attention. (J. Ws.)

FRUMENTIUS (c. 300–c. 360), the founder of the Abyssinian church, traditionally identified in Abyssinian literature with Abba Salama or Father of Peace (but see ΕΠΙΘΟΡΙΑ), was a native of Phoenicia. According to the 4th-century historian Rufinus (x. 9), who gives Aedesius himself as his authority, a certain Tyrian, Meropius, accompanied by his kinsmen Frumentius and Aedesius, set out on an expedition to "India," but fell into the hands of Ethiopians on the shore of the Red Sea and, with his ship's crew, was put to death. The two young men were taken to the king at Axum, where they were well treated and in time obtained great influence. With the help of Christian merchants who visited the country Frumentius gave Christianity a firm footing, which was strengthened when in 326 he was consecrated bishop by Athanasius of Alexandria, who in his *Epistola ad Constantinum* mentions the consecration, and gives some details of the history of Frumentius's mission. Later witnesses speak of his fidelity to the homoousian during the Arian controversies. Aedesius returned to Tyre, where he was ordained presbyter.

FRUNDSBERG, GEORG VON (1473–1528), German soldier, was born at Mindelheim on the 24th of September 1473. He fought for the German king Maximilian I. against the Swiss in 1499, and in the same year was among the imperial troops sent to assist Ludovico Sforza, duke of Milan, against the French. Still serving Maximilian, he took part in 1504 in the war over the succession to the duchy of Bavaria-Landshut, and afterwards fought in the Netherlands. Convinced of the necessity of a native body of trained infantry Frundsberg assisted Maximilian to organize the *Landsknechte* (q.v.), and subsequently at the head of bands of these formidable troops he was of great service to the Empire and the Habsburgs. In 1509 he shared in the war against Venice, winning fame for himself and his men; and after a short visit to Germany returned to Italy, where in 1513 and 1514 he gained fresh laurels by his enterprises against the Venetians and the French. Peace being made, he returned to Germany, and at the head of the infantry of the Swabian league assisted to drive Ulrich of Württemberg from his duchy in 1510. At the diet of Worms in 1521 he spoke words of encouragement to Luther, and when the struggle between France and the Empire was renewed he took part in the invasion of Picardy, and then proceeding to Italy brought the greater part of Lombardy under the influence of Charles V. through his victory at Bicocca in April 1522. He was partly responsible for the great victory over the French at Pavia in February 1525, and, returning to Germany, he assisted to suppress the Peasant revolt, using on this occasion, however, diplomacy as well as force. When the war in Italy was renewed Frundsberg raised an army at his own expense, and skillfully surmounting many difficulties, joined the constable de Bourbon near Piacenza and marched towards Rome. Before he reached the city, however, his unpaid troops showed signs of mutiny, and their leader, stricken with illness and unable to pacify them, gave up his command. Returning to Germany, he died at Mindelheim on the 20th of August 1528. He was a capable and chivalrous soldier, and a devoted servant of the Habsburgs. His son Caspar (1500–1536) and his grandson Georg (d. 1586) were both soldiers of some distinction. With the latter's death the family became extinct.

See Adam Reissner, *Historia Herrn Georgs und Herrn Caspares von Frundsberg* (Frankfurt, 1568). A German translation of this work was published at Frankfurt in 1572. F. W. Barthold, *Georg von Frundsberg* (Hamburg, 1833); J. Heilmann, *Kriegsgeschichte des Bayern, Franken, Pfalz und Schwaben* (Munich, 1868).

FRUSTUM (Latin for a "piece broken off"), a term in geometry for the part of a solid figure, such as a cone or pyramid, cut off by a plane parallel to the base, or lying between two parallel planes; and hence in architecture a name given to the drum of a column.

FRUYTIERS, PHILIP (1627–1666), Flemish painter and engraver, was a pupil of the Jesuits' college at Antwerp in 1627, and entered the Antwerp gild of painters without a fee in 1631. He is described in the register of that institution as "illuminaator, painter and engraver." The current account of his life is "that he worked exclusively in water colours, yet was so remarkable in this branch of his art for arrangement, drawing, and especially for force and clearness of colour, as to excite the admiration of Rubens, whom he portrayed with all his family." The truth is that he was an artist of the most versatile talents, as may be judged from the fact that in 1646 he executed an Assumption with figures of life size, and four smaller pictures in oil, for the church of St Jacques at Antwerp, for which he received the considerable sum of 1150 florins. Unhappily no undoubted production of his hand has been preserved. All that we can point to with certainty is a series of etched plates, chiefly portraits, which are acknowledged to have been powerfully and skilfully handled. If, however, we search the portfolios of art collections on the European continent, we sometimes stumble upon miniatures on vellum, drawn with great talent and coloured with extraordinary brilliancy. In form they quite recall the works of Rubens, and these, it may be, are the work of Philip Fruytiers.

FRY, the name of a well-known English Quaker family, originally living in Wiltshire. About the middle of the 18th century **JOSEPH FRY** (1728–1787), a doctor, settled in Bristol, where he acquired a large practice, but eventually abandoned medicine for commerce. He became interested in china-making, soap-boiling and type-founding businesses in Bristol, and in a chemical works at Battersea, all of which ventures proved very profitable. The type-founding business was subsequently removed to London and conducted by his son Edmund. Joseph Fry, however, is best remembered as the founder of the great Bristol firm of J. S. Fry & Sons, chocolate manufacturers. He purchased the chocolate-making patent of William Churchman and on it laid the foundations of the present large business. After his death the Bristol chocolate factory was carried on with increasing success by his widow and by his son, **JOSEPH STORRS FRY** (1767–1835).

In 1795 a new and larger factory was built in Union Street, Bristol, which still forms the centre of the firm's premises, and in 1798 a Watt's steam-engine was purchased and the cocoa-beans ground by steam. On the death of Joseph Storrs Fry his three sons, Joseph (1795–1879), Francis, and Richard (1807–1878) became partners in the firm, the control being mainly in the hands of FRANCIS FRY (1803–1886). Francis Fry was in every way a remarkable character. The development of the business to its modern enormous proportion was chiefly his work, but this did not exhaust his activities. He took a principal part in the introduction of railways to the west of England, and in 1851 drew up a scheme for a general English railway parcel service. He was an ardent bibliographer, taking a special interest in early English Bibles, of which he made in the course of a long life a large and striking collection, and of the most celebrated of which he published facsimiles with bibliographical notes. Francis Fry died in 1886, and his son Francis J. Fry and nephew Joseph Storrs Fry carried on the business, which in 1896 was for family reasons converted into a private limited company, Joseph Storrs Fry being chairman and all the directors members of the Fry family.

FRY, SIR EDWARD (1827–), English judge, second son of Joseph Fry (1795–1879), was born at Bristol on the 4th of November 1827, and educated at University College, London, and London University. He was called to the bar in 1854 and was made a Q.C. in 1869, practising in the rolls court and becoming recognized as a leading equity lawyer. In 1877 he was raised to the bench and knighted. As chancery judge he will be

remembered for his careful interpretations and elucidations of the Judicature Acts, then first coming into operation. In 1883 he was made a lord justice of appeal, but resigned in 1892; and subsequently his knowledge of equity and talents for arbitration were utilized by the British government from time to time in various special directions, particularly as chairman of many commissions. He was also one of the British representatives at the Paris North Sea Inquiry Commission (1905), and was appointed a member of the Hague Permanent Arbitration Court. He wrote *A Treatise on the Specific Performance of Public Contracts* (London, 1858, and many subsequent editions).

FRY, ELIZABETH (1780-1845), English philanthropist, and, after Howard, the chief promoter of prison reform in Europe, was born in Norwich on the 21st of May 1780. Her father, John Gurney, afterwards of Earham Hall, a wealthy merchant and banker, represented an old family which for some generations had belonged to the Society of Friends. While still a girl she gave many indications of the benevolence of disposition, clearness and independence of judgment, and strength of purpose, for which she was afterwards so distinguished; but it was not until after she had entered her eighteenth year that her religion assumed a decided character, and that she was induced, under the preaching of the American Quaker, William Savery, to become an earnest and enthusiastic though never fanatical "Friend." In August 1800 she became the wife of Joseph Fry, a London merchant.

Amid increasing family cares she was unwearied in her attention to the poor and the neglected of her neighbourhood; and in 1811 she was acknowledged by her co-religionists as a "minister," an honour and responsibility for which she was undoubtedly qualified, not only by vigour of intelligence and warmth of heart, but also by an altogether unusual faculty of clear, fluent and persuasive speech. Although she had made several visits to Newgate prison as early as February 1813, it was not until nearly four years afterwards that the great public work of her life may be said to have begun. The association for the Improvement of the Female Prisoners in Newgate was formed in April 1817. Its aim was the much-needed establishment of some of what are now regarded as the first principles of prison discipline, such as entire separation of the sexes, classification of criminals, female supervision for the women, and adequate provision for their religious and secular instruction, as also for their useful employment. The ameliorations effected by this association, and largely by the personal exertions of Mrs Fry, soon became obvious, and led to a rapid extension of similar methods to other places. In 1818 she, along with her brother, visited the prisons of Scotland and the north of England; and the publication (1819) of the notes of this tour, as also the cordial recognition of the value of her work by the House of Commons committee on the prisons of the metropolis, led to a great increase of her correspondence, which now extended to Italy, Denmark and Russia, as well as to all parts of the United Kingdom. Through a visit to Ireland, which she made in 1827, she was led to direct her attention to other houses of detention besides prisons; and her observations resulted in many important improvements in the British hospital system, and in the treatment of the insane. In 1838 she visited France, and besides conferring with many of the leading prison officials, she personally visited most of the houses of detention in Paris, as well as in Rouen, Caen and some other places. In the following year she obtained an official permission to visit all the prisons in that country; and her tour, which extended from Boulogne and Abbeville to Toulouse and Marseilles, resulted in a report which was presented to the minister of the interior and the prefect of police. Before returning to England she had included Geneva, Zürich, Stuttgart and Frankfort-on-Main in her inspection. The summer of 1840 found her travelling through Belgium, Holland and Prussia on the same mission; and in 1841 she also visited Copenhagen. In 1842, through failing health, Mrs Fry was compelled to forgo her plans for a still more widely extended activity, but had the satisfaction of hearing from almost every quarter of Europe that the authorities were giving increased practical effect to her suggestions. In 1844 she was seized with a lingering illness, of

which she died on the 12th of October 1845. She was survived by a numerous family, the youngest of whom was born in 1822.

Two interesting volumes of *Memoirs, with Extracts from her Journals and Letters*, edited by two of her daughters, were published in 1847. See also *Elizabeth Fry*, by G. King Lewis (1910).

FRYXELL, ANDEBS (1795-1881), Swedish historian, was born at Hesselkog, Dalaland, Sweden, on the 7th of February 1795. He was educated at Upsala, took holy orders in 1820, was made a doctor of philosophy in 1821, and in 1823 began to publish the great work of his life, the *Stories from Swedish History*. He did not bring this labour to a close until, fifty-six years later, he published the forty-sixth and crowning volume of his vast enterprise. Fryxell, as a historian, appealed to every class by the picturesqueness of his style and the breadth of his research; he had the gift of awakening to an extraordinary degree the national sense in his readers. In 1824 he published his *Swedish Grammar*, which was long without a rival. In 1833 he received the title of professor, and in 1835 he was appointed to the incumbency of Sunne, in the diocese of Karlstad, where he resided for the remainder of his life. In 1840 he was elected to the Swedish Academy in succession to the poet Wallin (1779-1830). In 1847 Fryxell received from his bishop permission to withdraw from all the services of the Church, that he might devote himself without interruption to historical investigation. Among his numerous minor writings are prominent his *Characteristics of Sweden between 1592 and 1600* (1830), his *Origins of the Inaccuracy with which the History of Sweden in Catholic Times has been Treated* (1847), and his *Contributions to the Literary History of Sweden*. It is now beginning to be seen that the abundant labours of Fryxell were rather of a popular than of a scientific order, and although their influence during his lifetime was unbounded, it is only fair to later and exacter historians to admit that they threaten to become obsolete in more than one direction. On the 21st of March 1881 Anders Fryxell died at Stockholm, and in 1884 his daughter Eva Fryxell (born 1829) published from his MS. an interesting *History of My History*, which was really a literary autobiography and displays the persistency and tirelessness of his industry. (E. G.)

FUAD PASHA (1815-1869), Turkish statesman, was the son of the distinguished poet Kechêji-zadê Izzet Molla. He was educated at the medical school and was at first an army surgeon. About 1836 he entered the civil service as an official of the foreign ministry. He became secretary of the embassy in London; was employed on special missions in the principalities and at St Petersburg (1848), and was sent to Egypt as special commissioner in 1851. In that year he became minister for foreign affairs, a post to which he was appointed also on four subsequent occasions and which he held at the time of his death. During the Crimean War he commanded the troops on the Greek frontier and distinguished himself by his bravery. He was Turkish delegate at the Paris conference of 1856; was charged with a mission to Syria in 1860; grand vizier in 1860 and 1861, and also minister of war. He accompanied the sultan Abd-ul-Aziz on his journey to Egypt and Europe, when the freedom of the city of London was conferred on him. He died at Nice (whither he had been ordered for his health) in 1869. Fuad was renowned for his boldness and promptness of decision, as well as for his ready wit and his many *bons mots*. Generally regarded as the partisan of a pro-English policy, he rendered most valuable service to his country by his able management of the foreign relations of Turkey, and not least by his efficacious settlement of affairs in Syria after the massacres of 1860.

FUCHOW, FU-CHAU, FOCHOW, a city of China, capital of the province of Fu-kien, and one of the principal ports open to foreign commerce. In the local dialect it is called Hokchiu. It is situated on the river Min, about 35 m. from the sea, in 26° 5' N. and 119° 20' E., 140 m. N. of Amoy and 280 S. of Hang-chow. The city proper, lying nearly 3 m. from the north bank of the river, is surrounded by a wall about 30 ft. high and 12 ft. thick, which makes a circuit of upwards of 5 m. and is pierced by seven gateways surrounded by tall fantastic watch-tow-

The whole district between the city and the river, the island of Nantai, and the southern banks of the Min are occupied by extensive suburbs; and the river itself bears a large floating population. Communication from bank to bank is afforded by a long stone bridge supported by forty solid stone piers in its northern section and by nine in its southern. The most remarkable establishment of Fuchow is the arsenal situated about 3 m. down the stream at Pagoda Island, where the sea-going vessels usually anchor. It was founded in 1867, and is conducted under the direction of French engineers according to European methods. In 1870 it employed about 1000 workmen besides fifty European superintendents, and between that date and 1880 it turned out about 20 or 30 small gunboats. In 1884 it was partially destroyed by the French fleet, and for a number of years the workshops and machinery were allowed to stand idle and go to decay. On the 1st of August 1895 an attack was made on the English mission near the city of Ku-chang, 120 m. west of Fuchow, on which occasion nine missionaries, of whom eight were ladies, were massacred. The port was opened to European commerce in 1842; and in 1853 the firm of Russell and Co. shipped the first cargoes of tea from Fuchow to Europe and America. The total trade in foreign vessels in 1876 was imports to the value of £1,531,617, and exports to the value of £3,330,489. In 1904 the imports amounted to £1,440,351, and the exports to £1,034,436. The number of vessels that entered in 1876 was 275, and of these 211 were British, 27 German, 11 Danish and 9 American. While in 1904 480 vessels entered the port, 216 of which were British. A large trade is carried on by the native merchants in timber, paper, woollen and cotton goods, oranges and olives; but the foreign houses mainly confine themselves to opium and tea. Commercial intercourse with Australia and New Zealand is on the increase. The principal imports, besides opium, are shirtings, T-cloths, lead and tin, medicines, rice, tobacco, and beans and peas. Two steamboat lines afford regular communication with Hong-Kong twice a month. The town is the seat of several important missions, of which the first was founded in 1846. That supported by the American board had in 1876 issued 1,300,000 copies of Chinese books and tracts.

FUCHS, JOHANN NEPOMUK VON (1774–1856), German chemist and mineralogist, was born at Mattenzell, near Brennbereg in the Bavarian Forest, on the 15th of May 1774. In 1807 he became professor of chemistry and mineralogy at the university of Landshut, and in 1823 conservator of the mineralogical collections at Munich, where he was appointed professor of mineralogy three years later, on the removal thither of the university of Landshut. He retired in 1852, was ennobled by the king of Bavaria in 1854, and died at Munich on the 5th of March 1856. His name is chiefly known for his mineralogical observations and for his work on soluble glass.

His collected works, including *Über den Einfluss der Chemie und Mineralogie* (1824), *Die Naturgeschichte des Mineralreichs* (1842), *Über die Theorien der Erde* (1844), were published at Munich in 1856.

FUCHS, LEONHARD (1501–1566), German physician and botanist, was born at Wemdingen in Bavaria on the 17th of January 1501. He attended school at Heilbronn and Erfurt, and in 1521 graduated at the university of Ingolstadt. About the same time he espoused the doctrines of the Reformation. Having in 1524 received his diploma as doctor of medicine, he practised for two years in Munich. He became in 1526 professor of medicine at Ingolstadt, and in 1528 physician to the margrave of Anspach. In Anspach he was the means of saving the lives of many during the epidemic locally known as the "English sweating-sickness." By the duke of Württemberg he was, in 1535, appointed to the professorship of medicine at the university of Tübingen, a post held by him till his death on the 10th of May 1566. Fuchs was an advocate of the Galenic school of medicine, and published several Latin translations of treatises by its founder and by Hippocrates. But his most important publication was *De historia stirpium commentarii insignes* (Basel, 1542), a work illustrated with more than five hundred excellent outline illustrations, including figures of the common forglove and of

another species of the genus *Digitalis*, which was so named by him.

FUCHSIA, so named by Plumier in honour of the botanist Leonhard Fuchs, a genus of plants of the natural order Onagraceae, characterized by entire, usually opposite leaves, pendent flowers, a funnel-shaped, brightly coloured, quadripartite, deciduous calyx, 4 petals, alternating with the calycine segments, 8, rarely 10, exerted stamens, a long filiform style, an inferior ovary, and fruit, a fleshy ovoid many-seeded berry. All the members of the genus, with the exception of the New Zealand species, *F. excorticata*, *F. Colensoi* and *F. procumbens*, are natives of Central and South America—occurring in the interior of forests or in damp and shady mountainous situations. The various species differ not a little in size as well as in other characters; some, as *F. verrucosa*, being dwarf shrubs; others, as *F. arborescens* and *F. apetala*, attaining a height of 12 to 16 ft., and having stems several inches in diameter. Plumier, in his *Nova plantarum Americanarum genera* (p. 14, tab. 14, Paris, 1703), gave a description of a species of fuchsia, the first known, under the name of *Fuchsia triphylla*, *flora coccinea*, and a somewhat conventional outline figure of the same plant was published at Amsterdam in 1757 by Burmann. In the *Histoire des plantes médicinales* of the South American traveller Feuillée (p. 64, pl. XLVII.), written in 1709–1711, and published by him with his *Journal*, Paris, 1725, the name *Thilco* is applied to a species of fuchsia from Chile, which is described, though not evidently so figured, as having a pentamerous calyx.

The *F. coccinea* of Aiton (fig.) (see J. D Hooker, in *Journal Linnean Soc.*, Botany, vol. x. p. 458, 1867), the first species of fuchsia cultivated in England, where it was long confined to the greenhouse, was brought from South America by



Fuchsia coccinea.

1, Flower cut open after removal of sepals; 2, fruit; 3, floral diagram.

Captain Firth in 1788 and placed in Kew Gardens. Of this species Mr Lee, a nurseryman at Hammersmith, soon afterwards obtained an example, and procured from it by means of cuttings several hundred plants, which he sold at a guinea each. In 1823 *F. macrostemma* and *F. gracilis*, and during the next two or three years several other species, were introduced into England; but it was not until about 1837, or soon after florists had acquired *F. fulgens*, that varieties of interest began to make their appearance. The numerous hybrid forms now existing are the result chiefly of the intercrossing of that or other long-flowered with globe-flowered plants. *F. Venus-victrix*, raised by Mr Gulliver, gardener to the Rev. S. Marriott of Horsemonden, Kent, and sold in 1822 to Messrs Cripps, was the earliest white-sepalled fuchsia. The first fuchsia with a white corolla was produced about 1833 by Mr Storey. In some varieties the blossoms are variegated, and in others they are double. There appears to be very little limit to the number of forms to be obtained by careful cultivation and selection. To hybridize, the flower as soon as it opens is emasculated, and it is then fertilized with pollen from some different flower.

Ripe seed is sown either in autumn or about February or March in light, rich, well-drained mould, and is thinly covered with

sandy soil and watered. A temperature of 70° to 75° Fahr. has been found suitable for raising. The seedlings are pricked off into shallow pots or pans, and when 3 in. in height are transferred to 3-in. pots, and are then treated the same as plants from cuttings. Fuchsias may be grafted as readily as camellias, preferably by the splice or whip method, the apex of a young shoot being employed as a scion; but the easiest and most usual method of propagation is by cuttings. The most expeditious way to procure these is to put plants in heat in January, and to take their shoots when 3 in. in length. For summer flowering in England they are best made about the end of August, and should be selected from the shortest-jointed young wood. They root readily in a compost of loam and silver-sand if kept close and sprinkled for a short time. In from two to three weeks they may be put into 3-in. pots containing a compost of equal parts of rich loam, silver-sand and leaf-mould. They are subsequently moved from the frame or bed. first to a warm and shady, and then to a more airy part of the greenhouse. In January a little artificial heat may be given, to be gradually increased as the days lengthen. The side-shoots are generally pruned when they have made three or four joints, and for bushy plants the leader is stopped soon after the first potting. Care is taken to keep the plants as near the glass as possible, and shaded from bright sunshine, also to provide them plentifully with water, except at the time of shifting, when the roots should be tolerably dry. For the second potting a suitable soil is a mixture of well-rotted cow-dung or old hotbed mould with leaf-mould and sandy peat, and to promote drainage a little peat-moss may be placed immediately over the crocks in the lower part of the pot. Weak liquid manure greatly promotes the advance of the plants, and should be regularly supplied twice or thrice a week during the flowering season. After this, water is gradually withheld from them, and they may be placed in the open air to ripen their wood.

Among the more hardy or half-hardy plants for inside borders are varieties of the Chilean species, *F. macrostemma* (or *F. magellanica*), a shrub 6 to 12 ft. high with a scarlet calyx, such as *F. m. globosa*, *F. m. gracilis*; one of the most graceful and hardy of these, a hybrid *F. riccartoni*, was raised at Riccarton, near Edinburgh, in 1830. For inside culture may be mentioned *F. boliviana* (Bolivia), 2 to 4 ft. high, with rich crimson flowers with a trumpet-shaped tube; *F. corymbiflora* (Peru), 4 to 6 ft. high, with scarlet flowers nearly 2 in. long in long terminal clusters; *F. fulgens* (Mexico), 4 to 6 ft., with drooping apical clusters of scarlet flowers; *F. microphylla* (Central America), with small leaves and small scarlet funnel-shaped flowers, the petals deep red; *F. procumbens* (New Zealand), a pretty little creeper, the small flowers of which are succeeded by oval magenta-crimson berries which remain on for months; and *F. splendens* (Mexico), 6 ft. high, with very showy scarlet and green flowers. But these cannot compare in beauty or freedom of blossom with the numerous varieties raised by gardeners. The nectar of fuchsia flowers has been shown to contain nearly 78% of cane sugar, the remainder being fruit sugar. The berries of some fuchsias are subacid or sweet and edible. From certain species a dye is obtainable. The so-called "native fuchsias" of southern and eastern Australia are plants of the genus *Correa*, natural order Rutaceae.

FUCHSINE, or **MAGENTA**, a red dyestuff consisting of a mixture of the hydrochlorides or acetates of pararosaniline and rosaniline. It was obtained in 1856 by J. Natanson (*Ann.*, 1856, 98, p. 297) by the action of ethylene chloride on aniline, and by A. W. Hofmann in 1858 from aniline and carbon tetrachloride. It is prepared by oxidizing "aniline for red" (a mixture of aniline and ortho- and para-toluidine) with arsenic acid (H. Medlock, *Dingler's Poly. Jour.*, 1860, 158, p. 146); by heating aniline for red with nitrobenzene, concentrated hydrochloric acid and iron (Coupier, *Ber.*, 1873, 6, p. 423); or by condensing formaldehyde with aniline and ortho-toluidine and oxidizing the mixture. It forms small crystals, showing a brilliant green reflex, and is soluble in water and alcohol with formation of a deep red solution. It dyes silk, wool and leather direct, and cotton after mordanting with tannin and tartar emetic (see DYEING). An aqueous solu-

tion of fuchsine is decolorized on the addition of sulphurous acid, the easily soluble fuchsine sulphurous acid being formed. This solution is frequently used as a test reagent for the detection of aldehydes, giving, in most cases, a red coloration on the addition of a small quantity of the aldehyde.

The constitution of the fuchsine bases (pararosanine and rosaniline) was determined by E. and O. Fischer in 1878 (*Ann.*, 1878, 194, p. 242); A. W. Hofmann having previously shown that oxidation of pure aniline alone or of pure toluidine yielded no fuchsine, whilst oxidation of a mixture of aniline and para-toluidine gave rise to the fine red dyestuff para-fuchsine (pararosanine hydrochloride)

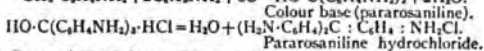
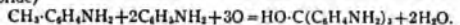

Pararosanine hydrochloride. A. Rosenstiehl (*Jahres.*, 1869, p. 693) found also that different rosanilines were obtained according to whether ortho- or para-toluidine was oxidized with aniline, and he gave the name rosaniline to the one obtained from aniline and ortho-toluidine, reserving the term pararosaniline for the other. E. and O. Fischer showed that these compounds were derivatives of triphenylmethane and tolyldiphenylmethane respectively. Pararosanine was reduced to the corresponding leuco compound (paraleucanine), from which by diazotization and boiling with alcohol, the parent hydrocarbon was obtained

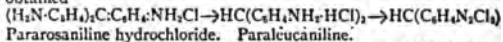

Pararosanine hydrochloride. Paraleucanine.



Triphenylmethane.

The reverse series of operations was also carried out by the Fischers, triphenylmethane being nitrated, and the nitro compound then reduced to triaminotriphenylmethane or paraleucanine, which on careful oxidation is converted into the dyestuff. A similar series of reactions was carried out with rosaniline, which was shown to be the corresponding derivative of tolyldiphenylmethane.

The free pararosaniline, $\text{C}_{18}\text{H}_{15}\text{N}_3\text{O}$ and rosaniline, $\text{C}_{12}\text{H}_9\text{N}_3\text{O}$, may be obtained by precipitating solutions of their salts with a caustic alkali, colourless precipitates being obtained, which crystallize from hot water in the form of needles or plates. The position of the amino groups in pararosaniline was determined by the work of H. Caro and C. Graebe (*Ber.*, 1878, 11, p. 1348) and of E. and O. Fischer (*Ber.*, 1880, 13, p. 2204) as follows: Nitrous acid converts pararosaniline into aurin, which when superheated with water yields para-dioxybenzophenone. As the hydroxyl groups in aurin correspond to the amino groups in pararosaniline, two of these in the latter compound must be in the para position. The third is also in the para position; for if benzaldehyde be condensed with aniline, condensation occurs in the para position, for the compound formed may be converted into para-dioxybenzophenone,

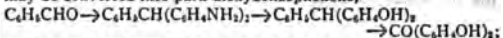

but if para-nitrobenzaldehyde be used in the above reaction and the resulting nitro compound $\text{NO}_2\text{-C}_6\text{H}_4\text{-CH}(\text{C}_6\text{H}_4\text{NH}_2)_2$ be reduced, then pararosaniline is the final product, and consequently the third amino group occupies the para position. Many derivatives of pararosaniline and rosaniline are known, in which the hydrogen atoms of the amino groups are replaced by alkyl groups; this has the effect of producing a blue or violet shade, which becomes deeper as the number of groups increases (see DYEING).

FUCINO, **LAGO DI** [Lat. *Lacus Fucinus*], a lake bed of the Abruzzi, Italy, in the province of Aquila, 2 m. E. of the town of Avezzano. The lake was 37 m. in circumference and 65 ft. deep. From the lack of an outlet, the level of the lake was subject to great variations, often fraught with disastrous consequences. As early as A.D. 52 the emperor Claudius, realizing a project of Julius Caesar, constructed a tunnel 3½ m. long, with 40 shafts at intervals, by which the surplus waters found an outlet to the Liris (or Garigliano). No less than 30,000 workmen were employed for eleven years in driving this tunnel. In the following reign the tunnel was allowed to fall into disrepair, but was repaired by Trajan. When, however, it finally went out of use is uncertain. The various attempts made to reopen it from 1240 onwards were unsuccessful. By 1852 the lake had gradually risen until it was 30 ft. above its original level, and had become a source of danger to the surrounding countryside. A company undertook to drain it on condition of becoming proprietors of the site when dry; in 1854, however, the rights and privileges were purchased by Prince Giulio Torlonia (d. 1886), the great Roman banker, who carried on the work at his own expense until, in 1876, the lake was finally drained at the cost of some £1,700,000. The

reclaimed area is $12\frac{1}{2}$ m. long, 7 m. broad, and is cultivated by families from the Torlonia estates. The outlet by which it was drained is 4 m. long and 24 sq. yds. in section.

See A. Brisse and L. de Rotron, *Le Dessèchement du lac Fucin, exécuté par S. E. le Prince A. Torlonia* (Rome, 1876). (T. As.)

FUEL (O. Fr. *feuaille*, popular Lat. *focalia*, from *focus*, hearth, fire), a term applicable to all substances that can be usefully employed for the production of heat by combustion. Any element or combination of elements susceptible of oxidation may under appropriate conditions be made to burn; but only those that ignite at a moderate initial temperature and burn with comparative rapidity, and, what is practically of more importance, are obtainable in quantity at moderate prices, can fairly be regarded as fuels. The elementary substances that can be so classed are primarily hydrogen, carbon and sulphur, while others finding more special applications are silicon, phosphorus, and the more readily oxidizable metals, such as iron, manganese, aluminium and magnesium. More important, however, than the elements are the carbohydrates or compounds of carbon, oxygen and hydrogen, which form the bulk of the natural fuels, wood, peat and coal, as well as of their liquid and gaseous derivatives—coal-gas, coal-tar, pitch, oil, &c., which have high values as fuel. Carbon in the elementary form has its nearest representative in the carbonized fuels, charcoal from wood and coke from coal.

Solid Fuels.

Wood may be considered as having the following average composition when in the air-dried state: Carbon, 39.6; hydro-

gen, 4.8; oxygen, 34.8; ash, 1.0; water, 20%.

When it is freshly felled, the water may be from 18 to 50%. Air-dried or even green wood ignites readily when a considerable surface is exposed to the kindling flame, but in large masses with regular or smooth surfaces it is often difficult to get it to burn. When previously torrefied or scorched by heating to a temperature of about 200°, at which incipient charring is set up, it is exceedingly inflammable. The ends of imperfectly charred boughs from the charcoal heaps in this condition are used in Paris and other large towns in France for kindling purposes, under the name of *sumérons*. The inflammability, however, varies with the density,—the so-called hard woods, oak, beech and maple, taking fire less readily than the softer, and, more especially, the coniferous varieties rich in resin. The calorific power of absolutely dry woods may as an average be taken at about 4000 units, and when air-dried, *i.e.* containing 25% of water, at 2800 to 3000 units. Their evaporative values, *i.e.* the quantities of water evaporated by unit weight, are 3.68 and 4.44.

Wood being essentially a flaming fuel is admirably adapted for use with heat-receiving surfaces of large extent, such as locomotive and marine boilers, and is also very clean in use. The absence of all cohesion in the cinders or unburnt carbonized residue causes a large amount of ignited particles to be projected from the chimney, when a rapid draught is used, unless special spark-catchers of wire gauze or some analogous contrivance are used. When burnt in open fireplaces the volatile products given off in the apartment on the first heating have an acrid penetrating odour, which is, however, very generally considered to be agreeable. Owing to the large amount of water present, no very high temperatures can be obtained by the direct combustion of wood, and to produce these for metallurgical purposes it is necessary to convert it previously either into charcoal or into inflammable gas.

Peat includes a great number of substances of very unequal fuel value, the most recently formed spongy light brown kind approximating in composition to wood, while the

Peat. dense pitchy brown compact substance, obtained from the bottom of bogs of ancient formation, may be compared with lignite or even in some instances with coal. Unlike wood, however, it contains incombustible matter in variable but large quantity, from 5 to 15% or even more. Much of this, when the amount is large, is often due to sand mechanically intermixed; when air-dried the proportion of water is from 8 to 20%. When these constituents are deducted the average composition may

be stated to be—carbon, 52 to 66; hydrogen, 4.7 to 7.4; oxygen, 28 to 39; and nitrogen, 1.5 to 3%. Average air-dried peat may be taken as having a calorific value of 3000 to 3500 units, and when dried at 100° C., and with a minimum of ash (4 to 5%), at about 5200 units, or from a quarter to one-third more than that of an equal weight of wood. The lighter and more spongy varieties of peat when air-dried are exceedingly inflammable, firing at a temperature of 200° C.; the denser pulpy kinds ignite less readily when in the natural state, and often require a still higher temperature when prepared by pulping and compression or partial carbonization. Most kinds burn with a red smoky flame, developing a very strong odour, which, however, has its admirers in the same way that wood smoke has. This arises from the destructive distillation of imperfectly carbonized organic matter. The ash, like that of wood, is light and powdery, except when much sand is present, when it is of a denser character.

Peat is principally found in high latitudes, on exposed high tablelands and treeless areas in more temperate climates, and in the valleys of slow-flowing rivers,—as in Ireland, the west of Scotland, the tableland of Bavaria, the North German plain, and parts of the valleys of the Somme, Oise and a few other rivers in northern France. A principal objection to its use is its extreme bulk, which for equal evaporative effect is from 8 to 18 times that of coal. Various methods have been proposed, and adopted more or less successfully, for the purpose of increasing the density of raw peat by compression, either with or without pulping; the latter process gives the heaviest products, but the improvement is scarcely sufficient to compensate for the cost.

Lignite or brown coal is of intermediate character between peat and coal proper. The best kinds are undistinguishable in quality from free-burning coals, and the lowest earthy lignites are not equal to average peat. When freshly raised, the proportion of water may be from 45 to 50% and even more, which is reduced from 28 to 20% by exposure to dry air. Most varieties, however, when fully dried, break up into powder, which considerably diminishes their utility as fuel, as they cannot be consolidated by coking. Lignite dust may, however, be compacted into serviceable blocks for burning, by pressure in machines similar to those used for brick-making, either in the wet state as raised from the mines or when kiln-dried at 200° C. This method was adopted to a very large extent in Prussian Saxony. The calorific value varies between 3500 and 5000 units, and the evaporative factor from 2.16 when freshly raised to 5.84 for the best kinds of lignite when perfectly dried.

Of the other natural fuels, apart from coal (*q.v.*), the most important is so-called vegetable refuse, such as cotton stalks, brushwood, straw, and the woody residue of sugar-cane after the extraction of the saccharine juice known as megasse or cane trash. These are extensively used in countries where wood and coal are scarce, usually for providing steam in the manufactures where they arise, *e.g.* straw for thrashing, cotton stalks for ploughing, irrigating, or working presses, and cane trash for boiling down sugar or driving the cane mill. According to J. Head (*Proc. Inst. of Civil Engineers*, vol. xviii. p. 75), the evaporative values of 1 lb. of these different articles when burnt in a tubular boiler are—coal, 8 lb; dry peat, 4 lb; dry wood, 3.58-3.52 lb; cotton stalks or megasse, 3.2-2.7 lb; straw, 2.46-2.30 lb. Owing to the siliceous nature of the ash of straw, it is desirable to have a means of clearing the grate bars from slags and clinkers at short intervals, and to use a steam jet to clear the tubes from similar deposits.

The common fuel of India and Egypt is derived from the dung of camels and oxen, moulded into thin cakes, and dried in the sun. It has a very low heating power, and in burning gives off acrid ammoniacal smoke and vapour.

Somewhat similar are the tan cakes made from spent tanners' bark, which are used to some extent in eastern France and in Germany. They are made by moulding the spent bark into cakes, which are then slowly dried by exposure to the air. Their effect is about equivalent to 80 and 30% of equal weights of wood and coal respectively.

Other natural fuels.

Sulphur, phosphorus and silicon, the other principal combustible elements, are only of limited application as fuels. The first is used in the liquidation of sulphur-bearing rocks. The ore is piled into large heaps, which are ignited at the bottom, a certain proportion, from one-fourth to one-third, of the sulphur content being sacrificed, in order to raise the mass to a sufficient temperature to allow the remainder to melt and run down to the collecting basin. Another application is in the so-called "pyritic smelting," where ores of copper (*q.v.*) containing iron pyrites, FeS₂, are smelted with appropriate fluxes in a hot blast, without preliminary roasting, the sulphur and iron of the pyrites giving sufficient heat by oxidation to liquefy both slag and metal. Phosphorus, which is of value from its low igniting point, receives its only application in the manufacture of lucifer matches.

The high temperature produced by burning phosphorus is in part due to the product of combustion (phosphoric acid) being solid, and therefore there is less heat absorbed than would be the case with a gaseous product. The same effect is observed in a still more striking manner with silicon, which in the only special case of its application to the production of heat, namely, in the Bessemer process of steel-making, gives rise to an enormous increase of temperature in the metal, sufficient indeed to keep the iron melted. The absolute calorific value of silicon is lower than that of carbon, but the product of combustion (silica) being non-volatile at all furnace temperatures, the whole of the heat developed is available for heating the molten iron, instead of a considerable part being consumed in the work of volatilization, as is the case with carbonic oxide, which burns to waste in the air.

Assay and Valuation of Carbonaceous Fuels.—The utility or value of a fuel depends upon two principal factors, namely, its calorific power and its calorific intensity or pyrometric effect, that is, the sensible temperature of the products of combustion.

The first of these is constant for any particular product of combustion independently of the method by which the burning is effected, whether by oxygen, air or a reducible metallic oxide. It is most conveniently determined in the laboratory by measuring the heat evolved during the combustion of a given weight of the fuel. The method of Lewis Thompson is one of the most useful. The calorimeter consists of a copper cylinder in which a weighed quantity of coal intimately mixed with 10-12 parts of a mixture of 3 parts of potassium chlorate and 1 of potassium nitrate is deflagrated under a copper case like a diving-bell, placed at the bottom of a deep glass jar filled with a known weight of water. The mixture is fired by a fuse of lamp-cotton previously soaked in a nitre solution and dried. The gases produced by the combustion rising through the water are cooled, with a corresponding increase of temperature in the latter, so that the difference between the temperature observed before and after the experiment measures the heat evolved. The instrument is so constructed that 30 grains (2 grammes) of coal are burnt in 29,010 grains of water, or in the proportion of 1 to 937, these numbers being selected that the observed rise of temperature in Fahrenheit degrees corresponds to the required evaporative value in pounds, subject only to a correction for the amount of heat absorbed by the mass of the instrument, for which a special coefficient is required and must be experimentally determined. The ordinary bomb calorimeter is also used. An approximate method is based upon the reduction of lead oxide by the carbon and hydrogen of the coal, the amount of lead reduced affording a measure of the oxygen expended, whence the heating power may be calculated, 1 part of pure carbon being capable of producing 34½ times its weight of lead. The operation is performed by mixing the weighed sample with a large excess of litharge in a crucible, and exposing it to a bright red heat for a short time. After cooling, the crucible is broken and the reduced button of lead is cleaned and weighed. The results obtained by this method are less accurate with coals containing much disposable hydrogen and iron pyrites than with those approximating to anthracite, as the heat equivalent of the hydrogen in excess of that required to form water with the oxygen of the coal is calculated as carbon, while it is really about four times as great. Sulphur in iron pyrites also acts as a reducing agent upon litharge, and increases the apparent effect in a similar manner.

The evaporative power of a coal found by the above methods, and also by calculating the separate calorific factors of the components as determined by the chemical analysis, is always considerably above that obtained by actual combustion under a steam boiler, as in the latter case numerous sources of loss, such as imperfect combustion of gases, loss of unburnt coal in cinders, &c., come into play, which cannot be allowed for in laboratory experiments. It is usual, therefore, to determine the value of a coal by the combustion

of a weighed quantity in the furnace of a boiler, and measuring the amount of water evaporated by the heat developed.

In a research upon the heating power and other properties of coal for naval use, carried out by the German admiralty, the results tabulated below were obtained with coals from different localities.

The heats of combustion of elements and compounds will be found in most of the larger works on physical and chemical constants;

	Slag left in Grate.	Ashes in Ashpit.	Soot in Flues.	Water evaporated by 1 lb of Coal
Westphalian gas coals .	0.33-6.42	2.83- 6.53	0.32-0.46	6.60-7.45 lb
Do. bituminous coals .	0.98-9.10	1.97- 9.63	0.24-0.88	7.30-8.66
Do. dry coals .	1.93-5.70	4.37-10.63	0.24-0.48	7.03-8.51
Silesian coals .	0.92-1.30	3.15- 3.50	0.24-0.30	6.73-7.10
Welsh steam coals .	1.20-4.07	4.07	0.32	8.41
Newcastle coals .	1.92	2.57	0.35	7.28

a convenient series is given in the *Annuaire du Bureau des Longitudes*, appearing in alternate years. The following figures for the principal fuel elements are taken from the issue for 1908; they are expressed in gramme "calories" or heat units, signifying the weight of water in grammes that can be raised 1° C. in temperature by the combustion of 1 gramme of the substance, when it is oxidized to the condition shown in the second column:

Element.	Product of Combustion.	Calories.
Hydrogen	Water, H ₂ O, condensed to liquid	34,500
	" " as vapour	29,650
Carbon—	Carbon dioxide, CO ₂	7,868
	Graphite	7,900
	Amorphous	8,133
Silicon—	Silicon dioxide, SiO ₂	6,414
	Crystallized	6,570
Phosphorus	Phosphoric pentoxide, P ₂ O ₅	5,958
Sulphur	Sulphur dioxide, SO ₂ , gaseous	2,165

The results may also be expressed in terms of the atomic equivalent of the combustible by multiplying the above values by the atomic weight of the substance, 12 for carbon, 28 for silicon, &c.

In all fuels containing hydrogen the calorific value as found by the calorimeter is higher than that obtainable under working conditions by an amount equal to the latent heat of volatilization of water which reappears as heat when the vapour is condensed, though under ordinary conditions of use the vapour passes away uncondensed. This gives rise to the distinction of higher and lower calorific values for such substances, the latter being those generally used in practice. The differences for the more important compound gaseous fuels are as follows:—

	Calorific Value.	
	Higher.	Lower.
Acetylene, C ₂ H ₂	11,920	11,500
Ethylene, C ₂ H ₄	11,880	11,120
Methane, CH ₄	13,240	11,910
Carbon monoxide, CO	2,440	2,440

The calorific intensity of pyrometric effect of any particular fuel depends upon so many variable elements that it cannot be determined except by actual experiment. The older method was to multiply the weight of the products of combustion by their specific heats, but this gave untrustworthy results as a rule, on account of two circumstances—the great increase in specific heat at high temperatures in compound gases such as water and carbon dioxide, and their instability when heated to 1800° or 2000°. At such temperatures dissociation to a notable extent takes place, especially with the latter substance, which is also readily reduced to carbon monoxide when brought in contact with carbon at a red heat—a change which is attended with a large heat absorption. This effect is higher with soft kinds of carbon, such as charcoal or soft coke, than with dense coke, gas retort carbon or graphite. These latter substances, therefore, are used when an intense local heat is required, as for example, in the Deville furnace, to which air is supplied under pressure. Such a method is, however, only of very special application, the ordinary method being to supply air to the fire in excess of that required to burn the fuel to prevent the reduction of the carbon dioxide. The volume of flame, however, is increased by inert gas, and there is a proportionate diminution of the heating effect. Under the most favourable conditions, when the air employed has been previously raised to a high temperature and pressure, the highest attainable flame temperature from carbonaceous fuel seems to be about 2100°-2300° C.; this is realized in the bright spots or "eyes" of the tuyeres of blast furnaces.

Very much higher temperatures may be reached when the products of combustion are not volatile, and the operation can be effected by using the fuel and oxidizing agent in the proportions exactly

required for perfect combustion and intimately mixed. These conditions are met in the "Thermit" process of Goldschmidt, where finely divided aluminium is oxidized by the oxide of some similar metal, such as iron, manganese or chromium, the reaction being started by a primer of magnesium and barium peroxide. The reaction is so rapidly effected that there is an enormous rise in temperature, estimated to be 5400° F. (3000° C.), which is sufficient to melt the most refractory metals, such as chromium. The slag consists of alumina which crystallizes in the forms of corundum and ruby, and is utilized as an abrasive under the name of corubin.

The chemical examination includes the determination of (1) moisture, (2) ash, (3) coke, (4) volatile matter, (5) fixed carbon in coke, (6) sulphur, (7) chlorine, (8) phosphorus. Moisture is determined by noting the loss in weight when a sample is heated at 100° for about one hour. The ash is determined by heating a sample in a muffle furnace until all the combustible matter has been burnt off. The ash, which generally contains silica, oxides of the alkaline earths, ferric oxide (which gives the ash a red colour), sulphur, &c., is analysed by the ordinary gravimetric methods. The determination of coke is very important on account of the conclusions concerning the nature of the coal which it permits to be drawn. A sample is finely powdered and placed in a covered porcelain crucible, which is surrounded by an outer one, the space between them being packed with small coke. The crucibles are heated in a wind furnace for 1 to 1½ hours, then allowed to cool, the inner crucible removed, and the coke weighed. The coke may be (1) pulverulent, (2) slightly fritted, (3) spongy and swelled, (4) compact. Pulverulent coals indicate a non-caking bituminous coal, rich in oxygen if the amount be below 60%, but if the amount be very much less it generally indicates a lignite; if the amount be above 80% it indicates an anthracite containing little oxygen or hydrogen. A fritted coke indicates a slightly caking coal, while the spongy appearance points to a highly caking coal which has been partly fused in the furnace. A compact coke is yielded by good coking coals, and is usually large in amount. The volatile matters are determined as the loss of weight on coking less the amount of moisture. The "fixed carbon" is the carbon retained in the coke, which contains in addition the ash already determined. The fixed carbon is therefore the difference between the coke and the ash, and may be determined from these figures; or it may be determined directly by burning off the coke in a muffle and noting the loss in weight. Sulphur may be present as (1) organic sulphur, (2) as iron pyrites or other sulphides, (3) as the sulphates of calcium, aluminium and other metals; but the amount is generally so small that only the total sulphur is determined. This is effected by heating a mixture of the fuel with lime and sodium carbonate in a porcelain dish to redness in a muffle until all the carbonaceous matter has been burnt off. The residue, which contains the sulphur as calcium sulphate, is transferred to a beaker containing water to which a little bromine has been added. Hydrochloric acid is carefully added, the liquid filtered and the residue washed. To the filtrate ammonia is added, and then barium chloride, which precipitates the sulphur as barium sulphate. Sulphur existing in the form of sulphates may be removed by washing a sample with boiling water and determining the sulphuric acid in the solution. The washed sample is then fused in the usual way to determine the proportion of sulphur existing as iron pyrites. The distinction between sulphur present as sulphate and sulphide is of importance in the examination of coals intended for iron smelting, as the sulphates of the earthy metals are reduced by the gases of the furnace to sulphides, which pass into the slag without affecting the quality of the iron produced, while the sulphur of the metallic sulphides in the ash acts prejudicially upon the metal. Coals for gas-making should contain little sulphur, as the gases produced in the combustion are noxious and have very corrosive properties. Chlorine is rarely determined, but when present in quantity it corrodes copper and brass boiler tubes, with which consequently chlorine-bearing coals cannot be used. The element is determined by fusing with soda lime in a muffle, dissolving the residue in water and precipitating with silver nitrate. Phosphorus is determined in the ash by fusing it with a mixture of sodium and potassium carbonates, extracting the residue with hydrochloric acid, and twice evaporating to dryness with the same acid. The residue is dissolved in hydrochloric acid, a few drops of ferric chloride added, and then ammonia in excess. The precipitate of ferric phosphate is then treated as in the ordinary estimation of phosphates. If it be necessary to determine the absolute amount of carbon and hydrogen in a fuel, the dried sample is treated with copper oxide as in the ordinary estimation of these elements in organic compounds. (H. B.)

Liquid Fuel.

Vegetable oil is not used for fuel except for laboratory purposes, partly because its constituent parts are less adaptable for combustion under the conditions necessary for steam-raising, but chiefly because of the commercial difficulty of producing it with sufficient economy to compete with mineral fuel either solid or liquid.

The use of petroleum as fuel had long been recognized as a

scientific possibility, and some attempts had been made to adopt it in practice upon a commercial scale, but the insufficiency, and still more the irregularity, of the supplies prevented it from coming into practical use to any important extent until about 1898, when discoveries of oil specially adapted by chemical composition for fuel purposes changed the aspect of the situation. These discoveries of special oil were made first in Borneo and later in Texas, and experience in treating the oils from both localities has shown that while not less adapted to produce kerosene or illuminating oil, they are better adapted to produce fuel oil than either the Russian or the Pennsylvanian products. Texas oil did not hold its place in the market for long, because the influx of water into the wells lowered their yield, but discoveries of fuel oil in Mexico have come later and will help to maintain the balance of the world's supply, although this is still a mere fraction of the assured supply of coal.

With regard to the chemical properties of petroleum, it is not necessary to say more in the present place than that the lighter and more volatile constituents, known commercially as naphtha and benzene, must be removed by distillation in order to leave a residue composed principally of hydrocarbons which, while containing the necessary carbon for combustion, shall be sufficiently free from volatile qualities to avoid premature ignition and consequent danger of explosion. Attempts have been made to use crude oil for fuel purposes, and these have had some success in the neighbourhood of the oil wells and under boilers of unusually good ventilation both as regards their chimneys and the surroundings of their stokeholds; but for reasons both of commerce and of safety it is not desirable to use crude oil where some distillation is possible. The more complete the process of distillation, and the consequent removal of the volatile constituents, the higher the flash-point, and the more turgid and viscous is the fuel resulting; and if the process is carried to an extreme, the residue or fuel becomes difficult to ignite by the ordinary process of spraying or atomizing mechanically at the moment immediately preceding combustion. The proportions which have been found to work efficiently in practice are as follows:—

Carbon	:	:	:	:	88-00	%
Hydrogen	:	:	:	:	10-75	%
Oxygen	:	:	:	:	1-25	%
Total	:	:	:	:	100	

The standards of safety for liquid fuel as determined by flash-point are not yet finally settled, and are changing from time to time. The British admiralty require a flash-point of 270° F., and to this high standard, and the consequent viscosity of the fuel used by vessels in the British fleet, may partly be attributed the low rate of combustion that was at first found possible in them. The German admiralty have fixed a flash-point of 187° F., and have used oil of this standard with perfect safety, and at the same time with much higher measure of evaporative duty than has been attained in British war-vessels. In the British mercantile marine Lloyd's Register has permitted fuel with a flash-point as low as 150° F. as a minimum, and no harm has resulted. The British Board of Trade, the department of the government which controls the safety of passenger vessels, has fixed a higher standard upon the basis of a minimum of 185°. In the case of locomotives the flash-point as a standard of safety is of less importance than in the case of stationary or marine boilers, because the storage is more open, and the ventilation, both of the storage tanks and the boilers during combustion, much more perfect than in any other class of steam-boilers.

The process of refining by distillation is also necessary to reduce two impurities which greatly retard storage and combustion, *i.e.* water and sulphur. Water is found in all crude petroleum as it issues from the wells, and sulphur exists in important quantities in oil from the Texas wells. Its removal was at first found very expensive, but there no longer exists difficulty in this respect, and large quantities of petroleum fuel practically free from sulphur are now regularly exported from Texas to New York and to Europe.

Water mixed with fuel is in intimate mechanical relation, and frequently so remains in considerable quantities even after the process of distillation. It is in fact so thoroughly mixed as to form an emulsion. The effect of feeding such a mixture into a furnace is extremely injurious, because the water must be decomposed chemically into its constituents, hydrogen and oxygen, thus absorbing a large quantity of heat which would otherwise be utilized for evaporation. Water also directly delays combustion by producing from the jet a long, dull, red flame instead of a short bright, white flame, and the process of combustion, which should take place by vaporization of the oil near the furnace mouth, is postponed and transferred to the upper part of the combustion-box, the tubes, and even the base of the chimney, producing loss of heat and injury to the boiler structure. The most effective means of ridding the fuel of this dangerous impurity is by heat and settlement. The coefficients of expansion of water and oil by heat are substantially different, and a moderate rise of temperature therefore separates the particles and precipitates the water, which is easily drawn off—leaving the oil available for use. The heating and precipitation are usually performed upon a patented system of settling tanks and heating apparatus known as the Flannery-Boyd system, which has proved itself indispensable for the successful use at sea of petroleum fuel containing any large proportion of water.

The laboratory and mechanical use of petroleum for fuel has already been referred to, but it was not until the year 1870 that petroleum was applied upon a wider and commercial scale. In the course of distillation of Russian crude petroleum for the production of kerosene or lamp oil, large quantities of refuse were produced—known by the Russian name of *astakhi*—and these were found an incumbrance and useless for any commercial purpose. To a Russian oil-refiner gifted with mechanical instinct and the genius for invention occurred the idea of utilizing the waste product as fuel by spraying or atomizing it with steam, so that, the thick and sluggish fluid being broken up into particles, the air necessary for combustion could have free access to it. The earliest apparatus for this purpose was a simple piece of gas-tube, into which the thick oil was fed; by another connexion steam at high pressure was admitted to an inner and smaller tube, and, the end of the tube nearest to the furnace being open, the pressure of the steam blew the oil into the furnace, and by its velocity broke it up into spray. The apparatus worked with success from the first. Experience pointed out the proper proportionate sizes for the inlets of steam and oil, the proper pressure for the steam, and the proportionate sizes for the orifices of admission to the furnaces, as well as the sizes of

air-openings and best arrangements of fire-bricks in the furnaces themselves, and what had been a waste product now became a by-product of great value. Practically all the steam power in South Russia, both for factories and navigation of the inland seas and rivers, is now raised from *astakhi* fuel.

In the Far East, including Burma and parts of China and Japan, the use of liquid fuel spread rapidly during the years 1899, 1900 and 1901, owing entirely to the development of the Borneo oil-fields by the enterprise of Sir Marcus Samuel and the large British corporation known as the Shell Transport and Trading Company, of which he is the head. This corporation

has since amalgamated with the Royal Dutch Petroleum Company controlling the extensive wells in Dutch Borneo, and together they supply large quantities of liquid fuel for use in the Far East. In the United States of America liquid fuel is not only used for practically the whole of the manufacturing and locomotive purposes of the state of Texas, but factories in New York, and a still larger number in California, are now discarding the use of coal and adopting petroleum, because it is more economical in its consumption and also more easily handled in transit, and saves nearly all the labour of stoking. So far the supplies for China and Japan have been exported from Borneo, but the discoveries of new oil-fields in California, of a character specially adapted for fuel, have encouraged the belief that it may be possible to supply Chile and Peru and other South American countries, where coal is extremely expensive, with Californian fuel; and it has also found its way across the Pacific to Japan. There are believed to be large deposits in West Africa, but in the meantime the only sources of supply to those parts of Africa where manufacture is progressing, i.e. South Africa and Egypt, are the oil-fields of Borneo and Texas, from which the import has well begun, from Texas to Alexandria via the Mediterranean, and from Borneo to Cape Town via Singapore.

In England, notwithstanding the fact that there exist the finest coal-fields in the world, there has been a surprising development of the use of petroleum as fuel. The Great Eastern railway adapted 120 locomotive engines to its use, and these ran with regularity and success both on express passenger and goods trains until the increase in price due to short supply compelled a return to coal fuel. The London, Brighton & South Coast railway also began the adaptation of some of their locomotive engines, but discontinued the use of liquid fuel from the same cause. Several large firms of contractors and cement manufacturers, chiefly on the banks of the Thames, made the same adaptations which proved mechanically successful, but were not continued when the price of liquid fuel increased with the increased demand.

The chief factors of economy are the greater calorific value

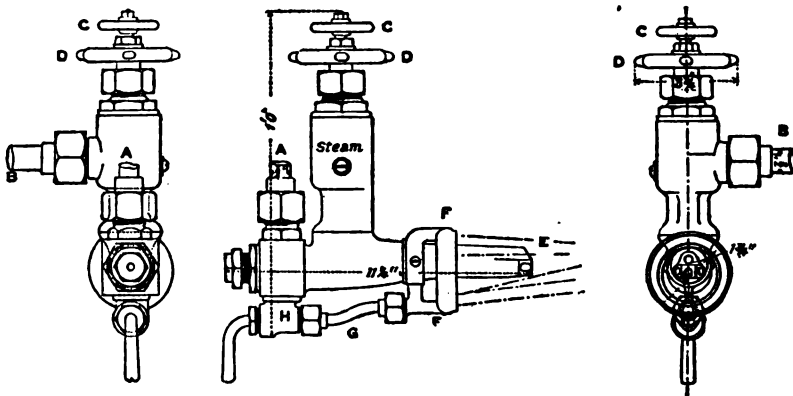

FIG. 1.—Holden Burner

of oil than coal (about 16 lb of water per lb of oil fuel evaporated from a temperature of 212° F.), not only in laboratory practice, but in actual use on a large scale, and the saving of labour both in transit from the source of supply to the place of use and in the act of stoking the furnaces. The use of cranes, horses and carts, is unavoidable for the transit of coal; and labour to trim the coal, to stoke it when under combustion, and to handle the residual ashes, are all indispensable to steam-raising by coal. On the other hand, a system of pipes and pumps, and a limited quantity of skilled

Economy
of Liquid
Fuel.

labour to manage them, is all that is necessary for the transit and combustion of petroleum fuel; and it is certain that even in England will be found places which, from topographical and other circumstances, will use petroleum more economically than coal as fuel for manufacturing purposes under reasonable conditions of price for the fuel.

The theoretical calorific value of oil fuel is more nearly realized in practice than the theoretical calorific value of coal, because the facilities for complete combustion, due to the artificial admixture of the air by the atomizing process, are greater in

riveted and tested, so as to form a storage tank. From this tank a feed-pipe is led to a burner of the combined steam-and-oil type already indicated, and this burner is so arranged as to enter a short distance inside the furnace mouth. The ordinary fire-bars are covered with a thin layer of coal, which starts the ignition in the first place, and the whole apparatus is ready for work. The burner best adapted for locomotive practice is the Holden Burner (fig. 1), which was used on the Great Eastern railway. The steam-pipe is connected at A, the oil-pipe at B, and the hand-

Liquid fuel in locomotives.

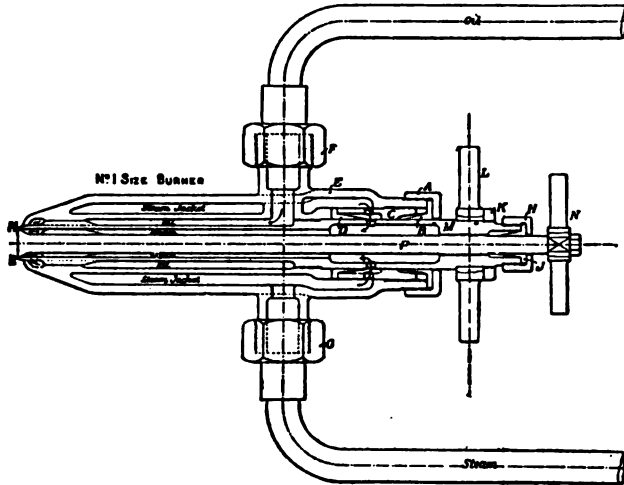

FIG. 2.—Rusden and Eccles Burner.

the case of oil than coal, and for this reason, among others, the practical evaporative results are proportionately higher with liquid fuel. In some cases the work done in a steam-engine by 2 tons of coal has been performed by 1 ton of oil fuel, but in others the proportions have been as 3 to 2, and these latter can be safely relied on in practice as a minimum. This saving, combined with the savings of labour and transit already explained, will in the near future make the use of liquid fuel compulsory, except in places so near to coal-fields that the cost of coal becomes sufficiently low to counterbalance the savings in weight of fuel consumed and in labour in handling it. In some locomotives on the Great Eastern railway the consumption of oil and coal for the same development of horse-power was as 17 lb oil is to 35 lb coal; all, however, did not realize so high a result.

The mechanical apparatus for applying petroleum to steam-raising in locomotives is very simple. The space in the tender usually occupied by coal is closed up by steel-plating closely

wheels C and D are for the adjustment of the internal orifices according to the rate of combustion required. The nozzle E is directed towards the furnace, and the external ring FF, supplied by the small pipe G and the by-pass valve H, projects a series of steam jets into the furnace, independent of the injections of atomized fuel, and so induces an artificial inrush of air for the promotion of combustion. This type of burner has also been tried on stationary boilers and on board ship. It works well, although the great consumption of steam by the supplementary ring is a difficulty at sea, where the water lost by the consumption of steam cannot easily be made up.

Although the application of the new fuel for land and locomotive boilers has already been large, the practice at sea has been far more extensive. The reason is chiefly to be found in the fact that although the sources of supply are at a distance from Great Britain, yet they are in countries to whose neighbourhood British steamships regularly trade, and in which British navalsquadrons are regularly stationed, so that the advantages of adopting liquid fuel have been more immediate and the economy

Liquid fuel at sea.

more direct. The certainty of continuous supply of the fuel and the wide distribution of storage stations have so altered the conditions that the general adoption of the new fuel for marine purposes becomes a matter of urgency for the statesman, the merchant and the engineer. None of these can afford to neglect the new conditions, lest they be noted and acted upon by their competitors. Storage for supply now exists at a number of sea ports. London, Barrow, Southampton, Amsterdam, Copenhagen, New Orleans, Savannah, New York, Philadelphia, Singapore, Hong Kong, Madras, Colombo, Sues, Hamburg, Port Arthur, Rangoon, Calcutta, Bombay, Alexandria, Bangkok, Saigon, Penang, Batavia, Surabaya, Amoy, Swatow, Fuchow, Shanghai, Hankow, Sydney, Melbourne, Adelaide, Zanzibar, Mombasa, Yokohama, Kobe and Nagasaki; also in South African and South American ports.

The British admiralty have undertaken experiments with liquid fuel at sea, and at the same time investigations of the

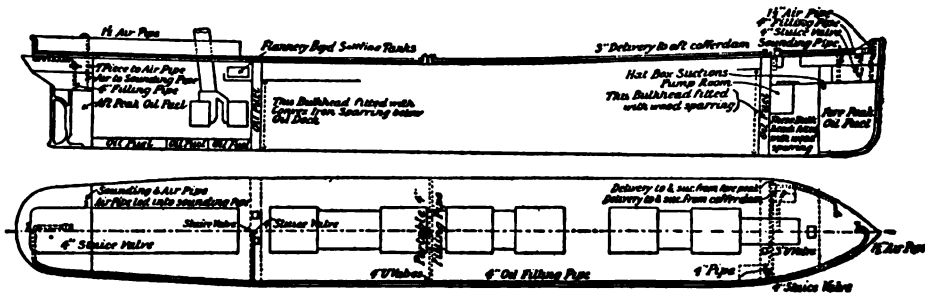

FIG. 3.—Storage of Liquid Fuel on Oil-carrying Steamers (Flannery-Boyd System).

possibility of supply from sources within the regions of the British empire. There is an enormous supply of shale under the north-eastern counties of England, but no oil that can be pumped—still less oil with a pressure above it so as to “gush” like the wells in America—and the only sources of liquid supply under the British flag appear to be in Burma and Trinidad. The Borneo

efficiency based on the thickest armour, the heaviest and most numerous guns, the highest maximum speed, and, last and not least, the greatest range of effective action based upon the maximum supplies of fuel, provisions and other consumable stores that the ship can carry. Now, if by changing the type of fuel it be possible to reduce its weight by 30%, and to abolish the stokers, who are usually more than half the ship’s company, the weight saved will be represented not merely by the fuel, but by the consumable stores otherwise necessary for the stokers. Conversely, the radius of effective action of the ship will be doubled as regards consumable stores if the crew be halved, and will be increased by 50% if the same weight of fuel be carried in the form of liquid instead of coal. In space the gain by using oil fuel is still greater, and 36 cubic feet of oil as stored are equal in practical calorific value to 67 cubic feet of coal according to the allowance usual for ship’s bunkering. On the other hand, coal has been relied upon, when placed in the side bunkers of unarmoured ships, as a protection against shot and shell, and this advantage, if it really exists, could not be claimed in regard to liquid fuel.

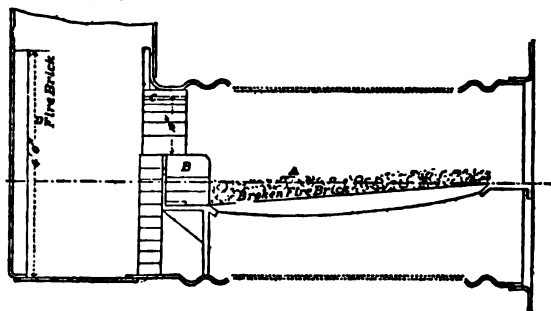

FIG. 4.—Installation on s. “Trocas.”

fields are not under British control, although developed entirely by British capital. The Italian admiralty have fitted several large warships with boiler apparatus to burn petroleum. The German admiralty are regularly using liquid fuel on the China station. The Dutch navy have fitted coal fuel and liquid fuel furnaces in combination, so that the smaller powers required

Recent experiments in coaling warships at sea have not been very successful, as the least bad weather has prevented the safe transmission of coal bags from the collier to the ship. The same difficulty does not exist for oil fuel, which has been pumped through flexible tubing from one ship to the other even in comparatively rough weather. Smokelessness, so important a feature of sea strategy, has not always been attained by liquid fuel, but where the combustion is complete,

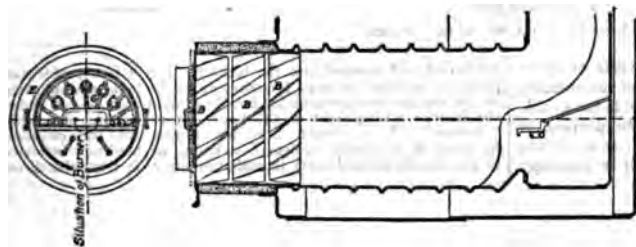
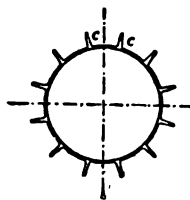

FIG. 5.—Details of Furnace, Meyer System.

may be developed by coal alone, and the larger powers by supplementing coal fuel with oil fuel. The speeds of some vessels of the destroyer type have by this means been accelerated nearly two knots.

The questions which govern the use of fuel in warships are more largely those of strategy and fighting efficiency than economy of evaporation. Indeed, the cost of constructing and maintaining in fighting efficiency a modern warship is so great that the utmost use strategically must be obtained from the vessel, and in this comparison the cost of fuel is relatively so small an item that its increase

Advantages in warships.



or decrease may be considered almost a negligible quantity. The desideratum in a warship is to obtain the greatest fighting

efficiency based on the thickest armour, the heaviest and most numerous guns, the highest maximum speed, and, last and not least, the greatest range of effective action based upon the maximum supplies of fuel, provisions and other consumable stores that the ship can carry.

by reason of suitable furnace arrangements and careful management, there is no smoke. The great drawback, however, to the use of liquid fuel in fast small vessels is the confined space allotted to the boilers, such confinement being unavoidable in view of the high power concentrated in a small hull. The British admiralty’s experiments, however, have gone far to solve the problem, and the quantity of oil which can be consumed by forced draught in confined boilers now more nearly equals the quantity of coal consumed under similar conditions. All recent vessels built for the British navy are so constructed that the spaces between their double bottoms are oil-tight and capable of storing liquid fuel in the tanks so formed. Most recent battleships and cruisers have also liquid fuel furnace fittings, and in 1910 it already appeared probable that the use of oil fuel in warships would rapidly develop.

In view of recent accusations of insufficiency of coal storage in foreign naval depots, by reason of the allegation that coal so stored quickly perishes, it is interesting to note that liquid fuel may be stored in tanks for an indefinite time without any deterioration whatever.

In the case of merchant steamers large progress has also been made. The Shell Transport and Trading Company have twenty-one vessels successfully navigating in all parts of the world and using liquid fuel. The Hamburg-American Steamship Company have four large vessels similarly fitted for oil fuel, which, however, differ in furnace arrangements, as will be hereafter described, although using coal when the fluctuation of the market renders that the more economical fuel. One of the large American transatlantic lines is adopting liquid fuel, and French, German, Danish and American mercantile vessels are also beginning to use it in considerable amounts.

Advantages in merchant ships.

In the case of very large passenger steamers, such as those of 20 knots and upwards in the Atlantic trade, the saving in cost of fuel is trifling compared with the advantage arising from the greater weight and space available for freight. Adopting a basis of 3 to 2 as between coal consumption and oil consumption, there is an increase of 1000 tons of dead weight cargo in even a

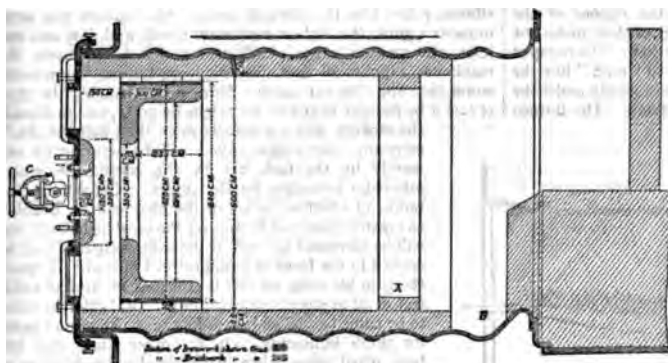

FIG. 7.—Furnace on ss. "Ferdinand Laeiza." A, it is proposed to do away with this ring of brickwork as being useless; B, it is proposed to fill this space up, thus continuing lining of furnace to combustion chamber, and also to fit protection bricks in way of saddle plate.

ships, whilst considerable additional speed is obtainable. The cost of the installation, however, is very considerable, as it includes not only burners and pipes for the furnaces, but also the construction of oil-tight tanks, with pumps and numerous valves and pipe connexions.

Fig. 2 shows a burner of Rusden and Eeles' patent as generally used on board ships for the purpose of injecting the oil. A is a movable cap holding the packing B, which renders the annular spindle M oil and steam tight. E is the outer casing containing the steam jacket from which the steam, after being fed through the steam-supply pipe G, passes into the annular space surrounding the spindle P. It will be seen that if the spindle P be travelled inwards by turning the handle N, the orifice at the nozzle RR will be opened so as to allow the steam to flow out radially. If at the same time the annular spindle M be drawn inwards by revolving the handle L, the oil which passes through the supply pipe F will also have emission at RR, and, coming in contact with the outflowing steam, will be

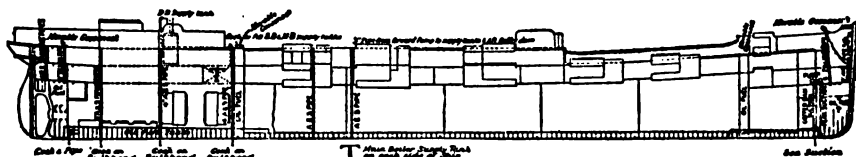

FIG. 8.—Fuel Tanks, &c., of ss. "Murex."

medium-sized Atlantic steamer, and a collateral gain of about 100,000 cub. ft. of measurement cargo, by reason of the ordinary bunkers being left quite free, and the oil being stored in the double bottom spaces hitherto unutilized except for the purpose of water ballast. The cleanliness and saving of time from bunkering by the use of oil fuel is also an important factor in passenger

pulverized and sprayed into the furnace. Fig. 3 is a profile and plan of a steamer adapted for carrying oil in bulk, and showing all the storage arrangements for handling liquid fuel. Fig. 4 shows the interior arrangement of the boiler furnace of the steamship "Trocas." A is broken fire-brick resting on the ordinary fire-bars, B is a brick bridge, C a casing of fire-brick intended to protect the riveted seam immediately above it from the direct

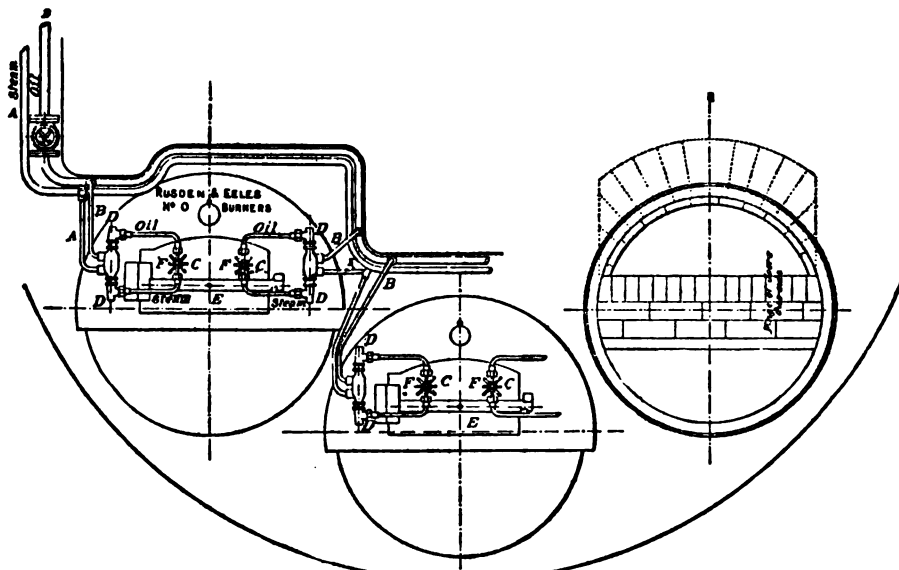

FIG. 9.—Furnace Gear of ss. "Murex."

impact of the flame, and D is a lining of fire-brick at the back of the combustion-box, also intended to protect the plating from the direct impact of the petroleum flame. The arrangement of the furnace on the Meyer system is shown in fig. 5, where E is an annular projection built at the mouth of the furnace, and BB are spiral passages for heating the air before it passes into the furnace. Fig. 6 shows the rings CC and details of the casting which forms the projection or exterior elongation of the furnace. The brickwork arrangement adopted for the double-ended boilers on the Hamburg-American Steamship Company's "Ferdinand Laeisz" is represented in fig. 7. The whole furnace is lined with fire-brick, and the burner is mounted upon a circular disk plate which covers the mouth of the furnace. The oil is injected not by steam pulverization, but by pressure due to a steam-pump. The oil is heated to about 60° C. before entering the pump, and further heated to 90° C. after leaving the pump. It

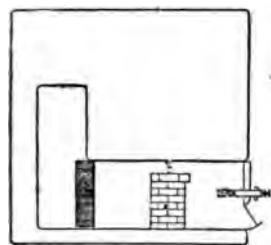

FIG. 10.—Section through Furnace of ss. "Murex."

is then filtered, and passes to the furnace injector C at about 30-lb pressure; and its passage through this injector and the spiral passages of which it consists pulverizes the oil into spray, in which form it readily ignites on reaching the interior of the furnace. The injector is on the Körtig principle, that is, it atomizes by fracture of the liquid oil arising from its own momentum under pressure. The advantage of this system as compared with the steam-jet system is the saving of fresh water, the abstraction of which is so

injurious to the boiler by the formation of scale. The general arrangement of the fuel tanks and filling pipes on the ss. "Murex" is shown in fig. 8; and fig. 9 represents the furnace gear of the same vessel, A being the steam-pipe, B the oil-pipe, C the injector, D the swivel upon which the injector is hung so that it may be swung clear of the furnace, E the fire-door, and F the handle for adjusting the injector. In fig. 10, which represents a section of the furnace, H is a fire-brick pier and K a fire-brick baffling bridge.

It is found in practice that to leave out the fire-bars ordinarily used for coal produces a better result with liquid fuel than the alternative system of keeping them in place and protecting them by a layer of broken fire-brick.

Boilers fitted upon all the above systems have been run for thousands of miles without trouble. In new construction it is desirable to give larger combustion chambers and longer and narrower boiler tubes than in the case of boilers intended for the combustion of coal alone. (F. F.)

Gaseous Fuel.

Strictly speaking, much, and sometimes even most, of the heating effected by solid or liquid fuel is actually performed by the gases given off during the combustion. We speak, however, of gaseous fuel only in those cases where we supply a combustible gas from the outset, or where we produce from ordinary solid (or liquid) fuel in one place a stream of combustible gas which is burned in another place, more or less distant from that where it has been generated.

The various descriptions of gaseous fuel employed in practice may be classified under the following heads:

I. Natural Gas.

II. Combustible Gases obtained as by-products in various technical operations.

III. Coal Gas (Illuminating Gas).

IV. Combustible Gases obtained by the partial combustion of coal, &c.

I. *Natural Gas.*—From time immemorial it has been known that in some parts of the Caucasus and of China large quantities of gases issue from the soil, sometimes under water, which can be lighted and burn with a luminous flame. The "eternal fires" of Baku belong to this class. In coal-mines frequently similar streams of gas issue from the coal; these are called "blowers," and when they are of somewhat regular occurrence are sometimes conducted away in pipes and used for underground lighting. As a regular source of heating power, however, natural gas is employed only in some parts of the United States, especially in Pennsylvania, Kansas, Ohio and West Virginia, where it always occurs in the neighbourhood of coal and petroleum fields. The first public mention of it was made in 1775, but it was

not till 1821 that it was turned to use at Fredonia, N.Y. In Pennsylvania natural gas was discovered in 1859, but at first very little use was made of it. Its industrial employment dates only from 1874, and became of great importance about ten years later. Nobody ever doubted that the gas found in these localities was an accumulation of many ages and that, being tapped by thousands of bore-holes, it must rapidly come to an end. This assumption was strengthened by the fact that the "gas-wells," which at first gave out the gas at a pressure of 700 or 800, sometimes even of 1400 lb per sq. in., gradually showed a more and more diminishing pressure and many of them ceased to work altogether. About the year 1890 the belief was fairly general that the stock of natural gas would soon be entirely exhausted. Indeed, the value of the annual production of natural gas in the United States, computed as its equivalent of coal, was then estimated at twenty-one million dollars, in 1895 at twelve millions, in 1899 at eleven and a half millions. But the output rose again to a value of twenty-seven millions in 1901, and to fifty million dollars in 1907. Mostly the gas, derived from upwards of 10,000 gas-wells, is now artificially compressed to a pressure of 300 or 400 lb per sq. in. by means of steam-power or gas motors, fed by the gas itself, and is conveyed over great distances in iron pipes, from 9 or 10 to 36 in. in diameter. In 1904 nearly 30,000 m. of pipe lines were in operation. In 1907 the quantity of natural gas consumed in the United States (nearly half of which was in Pennsylvania) was 400,000 million cub. ft., or nearly 3 cub. m. Canada (Ontario) also produces some natural gas, reaching a maximum of about \$746,000 in 1907.

The principal constituent of natural gas is always methane, CH₄, of which it contains from 68.4 to 94.0% by volume. Those gases which contain less methane contain all the more hydrogen, viz. 2.9 to 29.8%. There is also some ethylene, ethane and carbon monoxide, rarely exceeding 2 or 3%. The quantity of incombustible gases—oxygen, carbon dioxide, nitrogen—ranges from mere traces to about 5%. The density is from 0.45 to 0.55. The heating power of 1000 cub. ft. of natural gas is equal to from 80 to 120 lb, on the average 100 lb, of good coal, but it is really worth much more than this proportion would indicate, as it burns completely, without smoke or ashes, and without requiring any manual labour. It is employed for all domestic and for most industrial purposes.

The origin of natural gas is not properly understood, even now. The most natural assumption is, of course, that its formation is connected with that of the petroleum always found in the same neighbourhood, the latter principally consisting of the higher-boiling aliphatic hydrocarbons of the methane series. But whence do they both come? Some bring them into connexion with the formation of coal, others with the decomposition of animal remains, others with that of *diatomaceae*, &c., and even an inorganic origin of both petroleum and natural gas has been assumed by chemists of the rank of D. I. Mendeléeff and H. Moissan.

II. *Gases obtained as By-products.*—There are two important cases in which gaseous by-products are utilized as fuel; both are intimately connected with the manufacture of iron, but in a very different way, and the gases are of very different composition.

(a) *Blast-furnace Gases.*—The gases issuing from the mouths of blast-furnaces (see IRON and STEEL) were first utilized in 1837 by Faber du Faur, at Wasseralfingen. Their use became more extensive after 1860, and practically universal after 1870. The volume of gas given off per ton of iron made is about 158,000 cub. ft. Its percentage composition by volume is:

Carbon monoxide 21.6 to 29.0,	mostly about	26 %
Hydrogen 1.8 "	6.3, "	3 "
Methane 0.1 "	0.8, "	0.5 %
Carbon dioxide 6 "	12, "	9.5 %
Nitrogen 51 "	60, "	56 %
Steam 5 "	12, "	5 %
			100 %

There is always a large amount of mechanically suspended

flue-dust in this gas. It is practically equal to a poor producer-gas (see below), and is everywhere used, first for heating the blast in Cowper stoves or similar apparatus, and secondly for raising all the steam required for the operation of the blast-furnace, that is, for driving the blowing-engines, hoisting the materials, &c. Where the iron ore is roasted previously to being fed into the furnace, this can also be done by this gas, but in some cases the waste in using it is so great that there is not enough left for the last purpose. The calorific power of this gas per cubic foot is from 80 to 120 B.Th.U.

Since about 1900 a great advance has been made in this field. Instead of burning the blast-furnace gas under steam boilers and employing the steam for producing mechanical energy, the gas is directly burned in gas-motors on the explosion principle. Thus upwards of three times the mechanical energy is obtained in comparison with the indirect way through the steam boiler. After all the power required for the operations of the blast-furnace has been supplied, there is a surplus of from 10 to 20 h.p. for each ton of pig-iron made, which may be applied to any other purpose.

(b) *Coke-oven Gases*.—Where the coking of coal is performed in the old beehive ovens or similar apparatus the gas issuing at the mouth of the ovens is lost. The attempts at utilizing the gases in such cases have not been very successful. It is quite different where coke is manufactured in the same way as illuminating gas, viz. by the destructive distillation of coal in closed apparatus (retorts), heated from the outside. This industry, which is described in detail in G. Lunge's *Coal-Tar and Ammonia* (4th ed., 1909), originated in France, but has spread far more in Germany, where more than half of the coke produced is made by it; in the United Kingdom and the United States its progress has been much slower, but there also it has long been recognized as the only proper method. The output of coke is increased by about 15% in comparison with the beehive ovens, as the heat required for the process of distillation is not produced by burning part of the coal itself (as in the beehive ovens), but by burning part of the gas. The quality of the coke for iron-making is quite as good as that of beehive coke, although it differs from it in appearance. Moreover, the gases can be made to yield their ammonia, their tar, and even their benzene vapours, the value of which products sometimes exceeds that of the coke itself. And after all this there is still an excess of gas available for any other purpose.

As the principle of distilling the coal is just the same, whether the object is the manufacture of coal gas proper or of coke as the main product, although there is much difference in the details of the manufacture, it follows that the quality of the gas is very similar in both cases, so far as its heating value is concerned. Of course this heating value is less where the benzene has been extracted from coke-oven gas, since this compound is the richest heat-producer in the gas. This is, however, of minor importance in the present case, as there is only about 1% benzene in these gases.

The composition of coke-oven gases, after the extraction of the ammonia and tar, is about 53% hydrogen, 36% methane, 6% carbon monoxide, 2% ethylene and benzene, 0.5% sulphuretted hydrogen, 1.5% carbon dioxide, 1% nitrogen.

III. *Coal Gas (Illuminating Gas)*.—Although ordinary coal gas is primarily manufactured for illuminating purposes, it is also extensively used for cooking, frequently also for heating domestic rooms, baths, &c., and to some extent also for industrial operations on a small scale, where cleanliness and exact regulation of the work are of particular importance. In chemical laboratories it is preferred to every other kind of fuel wherever it is available. The manufacture of coal gas being described elsewhere in this work (see *Gas*, § *Manufacture*), we need here only point out that

it is obtained by heating bituminous coal in fireclay retorts and purifying the products of this destructive distillation by cooling, washing and other operations. The residual gas, the ordinary composition of which is given in the table below, amounts to about 10,000 cub. ft. for a ton of coal, and represents about 21% of its original heating value, 56.5% being left in the coke, 5.5% in the tar and 17% being lost. As we must deduct from the coke that quantity which is required for the heating of the retorts, and which, even when good gas producers are employed, amounts to 12% of the weight of the coal, or 10% of its heat value, the total loss of heat rises to 27%. Taking, further, into account the cost of labour, the wear and tear, and the capital interest on the plant, coal gas must always be an expensive fuel in comparison with coal itself, and cannot be thought of as a general substitute for the latter. But in many cases the greater expense of the coal gas is more than compensated by its easy distribution, the facility and cleanliness of its application, the general freedom from the mechanical loss, unavoidable in the case of coal fires, the prevention of black smoke and so forth. The following table shows the average composition of coal gas by volume and weight, together with the heat developed by its single constituents, the latter being expressed in kilogram-calories per cub. metre (0.252 kilogram-calories = 1 British heat unit; 1 cub. metre = 35.3 cub. ft.; therefore 0.1123 calories per cub. metre = 1 British heat unit per cub. foot).

Constituents.	Volume per cent.	Weight per cent.	Heat-value per Cubic Metre Calories.	Heat-value per Quantity contained in 1 Cub. Met.	Heat-value per cent. of Total.
Hydrogen, H ₂	47	7.4	2,582	1213	22.8
Methane, CH ₄	34	42.8	8,524	2898	54.5
Carbon monoxide, CO	9	19.9	3,043	273	5.1
Benzene vapour, C ₆ H ₆	1.2	7.4	33,815	405	7.7
Ethylene, C ₂ H ₄	3.8	8.4	13,960	530	9.9
Carbon dioxide, CO ₂	2.5	8.6
Nitrogen, N ₂	2.5	5.5
Total	100.0	100.0	..	5319	100.0

One cubic metre of such gas weighs 568 grammes. *Rich gas*, or gas made by the destructive distillation of certain bituminous schists, of oil, &c., contains much more of the heavy hydrocarbons, and its heat-value is therefore much higher than the above. The carburetted water gas, very generally made in America, and sometimes employed in England for mixing with coal gas, is of varying composition; its heat-value is generally rather less than that of coal gas (see below).

IV. *Combustible Gases produced by the Partial Combustion of Coal, &c.*—These form by far the most important kind of gaseous fuel. When coal is submitted to destructive distillation to produce the illuminating gas described in the preceding paragraph, only a comparatively small proportion of the heating value of the coal (say, a sixth or at most a fifth part) is obtained in the shape of gaseous fuel, by far the greater proportion remaining behind in the shape of coke.

An entirely different class of gaseous fuels comprises those produced by the incomplete combustion of the total carbon contained in the raw material, where the result is a mixture of gases which, being capable of combining with more oxygen, can be burnt and employed for heating purposes. Apart from some descriptions of waste gases belonging to this class (of which the most notable are those from blast-furnaces), we must distinguish two ways of producing such gaseous fuels entirely different in principle, though sometimes combined in one operation. The incomplete combustion of carbon may be brought about by means of atmospheric oxygen, by means of water, or by a simultaneous combination of these two actions. In the first case the chemical reaction is



the nitrogen accompanying the oxygen in the atmospheric air necessarily remains mixed with carbon monoxide, and the resulting gases, which always contain some carbon dioxide, some

products of the destructive distillation of the coal, &c., are known as *producer gas* or *Siemens gas*. In the second case the chemical reaction is mainly



that is to say, the carbon is converted into monoxide and the hydrogen is set free. As both of these substances can combine with oxygen, and as there is no atmospheric nitrogen to deal with, the resulting gas (*water gas*) is, apart from a few impurities, entirely combustible. Another kind of water gas is formed by the reaction



but this reaction, which converts all the carbon into the incombustible form of CO_2 , is considered as an unwelcome, although never entirely avoidable, concomitant of (b).

The reaction by which water gas is produced being endothermic (as we shall see), this gas cannot be obtained except by introducing the balance of energy in another manner. This might be done by heating the apparatus from without, but as this method would be uneconomical, the process is carried out by alternating the endothermic production of water gas with the exothermic combustion of carbon by atmospheric air. Pure water gas is not, therefore, made by a continuous process, but alternates with the production of other gases, combustible or not. But instead of constantly interrupting the process in this way, a continuous operation may be secured by simultaneously carrying on both the reactions (a) and (b) in such proportions that the heat generated by (a) at least equals the heat absorbed by (b). For this purpose the apparatus is fed at the same time with atmospheric air and with a certain quantity of steam, preferably in a superheated state. Gaseous mixtures of this kind have been made, more or less intentionally, for a long time past. One of the best known of them, intended less for the purpose of serving as ordinary fuel than for that of driving machinery, is the *Dowson gas*.

An advantage common to all kinds of gaseous fuel, which indeed forms the principal reason why it is intentionally produced from solid fuel, in spite of inevitable losses in the course of the operation, is the following. The combustion of solid fuel (coal, &c.) cannot be carried on with the theoretically necessary quantity of atmospheric air, but requires a considerable excess of the latter, at least 50%, sometimes 100% and more. This is best seen from the analyses of smoke gases. If all the oxygen of the air were converted into CO_2 and H_2O , the amount of CO_2 in the smoke gases should be in the case of pure carbon nearly 21 volumes %, as carbon dioxide occupies the same volume as oxygen; while ordinary coal, where the hydrogen takes up a certain quantity of oxygen as well, should show about 18.5% CO_2 . But the best smoke gases of steam boilers show only 12 or 13%, much more frequently only 10% CO_2 , and gases from reverberatory furnaces often show less than 5%. This means that the volume of the smoke gases escaping into the air is from $1\frac{1}{2}$ to 2 times (in the case of high-temperature operations often 4 times) greater than the theoretical minimum; and as these gases always carry off a considerable quantity of heat, the loss of heat is all the greater the less complete is the utilization of the oxygen and the higher the temperature of the operation. This explains why, in the case of the best-constructed steam-boiler fires provided with heat economizers, where the smoke gases are deprived of most of their heat, the proportion of the heat value of the fuel actually utilized may rise to 70 or even 75%, while in some metallurgical operations, in glass-making and similar cases, it may be below 5%.

One way of overcoming this difficulty to a certain extent is to reduce the solid fuel to a very fine powder, which can be intimately mixed with the air so that the consumption of the latter is only very slightly in excess of the theoretical quantity; but this process, which has been only recently introduced on a somewhat extended scale, involves much additional expense and trouble, and cannot as yet be considered a real success. Generally, too, it is far less easily applied than gaseous fuel. The latter can be readily and intimately mixed with the exact quantity of air that is required and distributed in any suitable way, and

much of the waste heat can be utilized for a preliminary heating of the air and the gas to be burned by means of "recuperators."

We shall now describe the principal classes of gaseous fuel, produced by the partial combustion of coal.

A. Producer Gas, Siemens Gas.—As we have seen above, this gas is made by the incomplete combustion of fuel. The materials generally employed for its production are anthracite, coke or other fuels which are not liable to cake during the operation, and thus stop the draught or otherwise disturb the process, but by special measures also bituminous coal, lignite, peat and other fuel may be utilized for gas producers. The fuel is arranged in a deep layer, generally from 4 ft. up to 10 ft., and the air is introduced from below, either by natural draught or by means of a blast, and either by a grate or only by a slit in the wall of the "gas producer." Even if the primary action taking place at the entrance of the air consisted in the complete combustion of the carbon to dioxide, CO_2 , the latter, in rising through the high column of incandescent fuel, must be reduced to monoxide: $CO_2 + C = 2CO$. But as the temperature in the producer rises rather high, and as in ordinary circumstances the action of oxygen on carbon above $1000^\circ C$. consists almost entirely in the direct formation of CO , we may regard this compound as primarily formed in the hotter parts of the gas-producer. It is true that ordinary producer gas always contains more or less CO_2 , but this may be formed higher up by air entering through leakages in the apparatus. If we ignore the hydrogen contained in the fuel, the theoretical composition of producer gas would be 33.3% CO and 66.7% N , both by volume and weight. Its weight per cubic metre is 1.251 grammes, and its heat value 1013 calories per cubic metre, or less than one-fifth of the heat-value of coal gas. Practically, however, producer gas contains a small percentage of gases, increasing its heat-value, like hydrogen, methane, &c., but on the other hand it is never free from carbon dioxide to the extent of from 2 to 8%. Its heat-value may therefore range between 800 and 1100 calories per cubic metre. Even when taking as the basis of our calculation a theoretical gas of 33.3% CO , we find that there is a great loss of heat-value in the manufacture of this gas. Thermochemistry teaches us that the reaction $C + O$ develops 29.5% of the heat produced by the complete oxidation of C to CO_2 , thus leaving only 70.5% for the stage $CO + O = CO_2$. If, therefore, the gas given off in the producer is allowed to cool down to ordinary temperature, nearly 30% of the heat-value of the coal is lost by radiation. If, however, the gas producer is built in close proximity to the place where the combustion takes place, so that the gas does not lose very much of its heat, the loss is correspondingly less. Even then there is no reason why this mode of burning the fuel, *i.e.* first with "primary air" in the producer ($C + O = CO$), then with "secondary air" in the furnace ($CO + O = CO_2$), should be preferred to the direct complete burning of the fuel on a grate, unless the above-mentioned advantage is secured, *viz.* reduction of the smoke gases to a minimum by confining the supply of air as nearly as possible to that required for the formation of CO_2 , which is only possible by producing an intimate mixture of the producer gas with the secondary air. The advantage in question is not very great where the heat of the smoke gases can be very fully utilized, *e.g.* in well-constructed steam boilers, salt-pans and the like, and as a matter of fact gas producers have not found much use in such cases. But a very great advantage is attained in high-temperature operations, where the smoke gases escape very hot, and where it is on that account all-important to confine their quantity to a minimum.

It is precisely in these cases that another requirement frequently comes in, *viz.* the production at a given point of a higher temperature than is easily attained by ordinary fires. Gas-firing lends itself very well to this end, as it is easily combined with a preliminary heating up of the air, and even of the gas itself, by means of "recuperators." The original and best-known form of these, due to Siemens Brothers, consists of two brick chambers filled with loosely stacked fire-bricks in such manner that any gases passed through the chambers must seek their way through the interstices left between the bricks, by which means a thorough

interchange of temperature takes place. The smoke gases, instead of escaping directly into the atmosphere, are made to pass through one of these chambers, giving up part of their heat to the brickwork. After a certain time the draught is changed by means of valves, the smoke gases are passed through another chamber, and the cold air intended to feed the combustion is made to pass through the first chamber, where it takes up heat from the white-hot bricks, and is thus heated up to a bright red heat until the chamber is cooled down too far, when the draughts are again reversed. Sometimes the producer gas itself is heated up in this manner (especially when it has been cooled down by travelling a long distance); in that case four recuperator chambers must be provided instead of two. Another class of recuperators is not founded on the alternating system, but acts continuously; the smoke gases travel always in the same direction in flues contiguous to other flues or pipes in which the air flows in the opposite direction, an interchange of heat taking place through the walls of the flues or pipes. Here the surface of contact must be made very large if a good effect is to be produced. In both cases not merely is a saving effected of all the calories which are abstracted by the cold air from the recuperator, but as less fuel has to be burned to get a given effect, the quantity of smoke gas is reduced. For details and other producer gases, see GAS, II. *For Fuel and Power.*

Gas-firing in the manner just described can be brought about by very simple means, viz. by lowering the fire-grate of an ordinary fire-place to at least 4 ft. below the fire-bridge, and by introducing the air partly below the grate and partly behind the fire-place, at or near the point where the greatest heat is required. Usually, however, more elaborate apparatus is employed, some of which we shall describe below. Gas-firing has now become universal in some of the most important industries and nearly so in others. The present extension of steel-making and other branches of metallurgy is intimately connected with this system, as is the modern method of glass-making, of heating coal gas retorts and so forth.

The composition of producer gas differs considerably, principally according to the material from which it is made. Analyses of ordinary producer gas (not such as falls under the heading of "semi-water gas," see *sub C*) by volume show 22 to 33% CO, 1 to 7% CO₂, 0.5 to 2% H₂, 0.5 to 3% hydrocarbons, and 64 to 68% N₂.

B. Water Gas.—The reaction of steam on highly heated carbonaceous matter was first observed by Felice Fontana in 1780. This was four years before Henry Cavendish isolated hydrogen from water, and thirteen years before William Murdoch made illuminating gas by the distillation of coal, so that it was no wonder that Fontana's laboratory work was soon forgotten. Nor had the use of carburetted water gas, as introduced by Donovan in 1830 for illuminating purposes, more than a very short life. More important is the fact that during nine years the illumination of the town of Narbonne was carried on by incandescent platinum wire, heated by water gas, where also internally heated generators were for the first time regularly employed. The Narbonne process was abandoned in 1865, and for some time no real progress was made in this field in Europe. But in America, T. S. C. Lowe, Strong, Tessié du Motay and others took up the matter, the first permanent success being obtained by the introduction (1873) of Lowe's system at Phoenixville, Pa. In the United States the abundance of anthracite, as well as of petroleum naphtha, adapted for carbureting the gas, secures a great commercial advantage to this kind of illuminant over coal gas, so that now three-fourths of all American gas-works employ carburetted water gas. In Europe the progress of this industry was naturally much less rapid, but here also since 1882, when the apparatus of Lowe and Dwight was introduced in the town of Essen, great improvements have been worked out, principally by E. Blass, and by these improvements water gas obtained a firm footing also for certain heating purposes. The American process for making carburetted water gas, as an auxiliary to ordinary coal gas, was first introduced by the London Gas Light and Coke Company on a large scale in 1890.

Water gas in its original state is called "blue gas," because it burns with a blue, non-luminous flame, which produces a very high temperature. According to the equation $C + H_2O = CO + H_2$, this gas consists theoretically of equal volumes of carbon monoxide and hydrogen. We shall presently see why it is impossible to avoid the presence of a little carbon dioxide and other gases, but we shall for the moment treat of water gas as if it were composed according to the above equation. The reaction $C + H_2O = CO + H_2$ is endothermic, that is, its thermal value is negative. One gram-molecule of carbon produces 97 great calories (1 great calorie or kilogram-calorie = 1000 gram-calories) when burning to CO₂, and this is of course the maximum effect obtainable from this source. If the same gram-molecule of carbon is used for making water gas, that is, CO + H₂, the heat produced by the combustion of the product is $68.4 + 57.6 = 126$ great calories, an apparent surplus of 29 calories, which cannot be got out of nothing. This is made evident by another consideration. In the above reaction C is not burned to CO₂, but to CO, a reaction which produces 28.6 calories per gram-molecule. But as the oxygen is furnished from water, which must first be decomposed by the expenditure of energy, we must introduce this amount, 68.5 calories in the case of liquid water, or 57.6 calories in the case of steam, as a negative quantity, and the difference, viz. $+28.6 - 57.6 = 29$ great calories, represents the amount of heat to be expended from another source in order to bring about the reaction of one gram-molecule of carbon on one gram-molecule of H₂O in the shape of steam. This explains why steam directed upon incandescent coal will produce water gas only for a very short time: even a large mass of coal will quickly be cooled down so much that at first a gas of different composition is formed and soon the process will cease altogether. We can avoid this result by carrying on the process in a retort heated from without by an ordinary coal fire, and all the early water gas apparatus was constructed in this way; but such a method is very uneconomical, and was long ago replaced by a process first patented by J. and T. N. Kirkham in 1854, and very much improved by successive inventors. This process consists in conducting the operation in an upright brick shaft, charged with anthracite, coke or other suitable fuel. This shaft resembles an ordinary gas producer, but it differs in being worked, not in a continuous manner, which, as shown above, would be impossible, but by alternately blowing air and steam through the coal for periods of a few minutes each. During the first phase, when carbon is burned by atmospheric oxygen, and thereby heat is produced, this heat, or rather that part of it which is not carried away by radiation and by the products of combustion on leaving the apparatus, is employed in raising the temperature of the remaining mass of fuel, and is thus available for the second phase, in which the reaction (b) $C + H_2O = CO + H_2$ goes on with the abstraction of a corresponding amount of heat from the incandescent fuel, so that the latter rapidly cools down, and the process must be reversed by blowing in air and so forth. The formation of exactly equal volumes of carbon monoxide and hydrogen goes on only at temperatures over 1200° C., that is, for a very few minutes. Even at 1100° C. a little CO₂ can be proved to exist in the gas, and at 900° its proportion becomes too high to allow the process to go on. About 650° C. the CO has fallen to a minimum, and the reaction is now essentially (c) $C + 2H_2O = CO_2 + 2H_2$; soon after the temperature of the mass will have fallen to such a low point that the steam passes through it without any perceptible action. The gas produced by reaction (c) contains only two-thirds of combustible matter, and is on that account less valuable than proper water gas formed by reaction (b); moreover, it requires the generation of twice the amount of steam, and its presence is all the less desirable since it must soon lead to a total cessation of the process. In ordinary circumstances it is evident that the more steam is blown in during a unit of time, the sooner reaction (c) will set in; on the other hand, the more heat has been accumulated in the producer the longer can the blowing-in of steam be continued.

The process of making water gas consequently comprises

two alternating operations, viz. first "blowing-up" by means of a current of air, by which the heat of the mass of fuel is raised to about 1200° C.; and, secondly "steaming," by injecting a current of (preferably superheated) steam until the temperature of the fuel had fallen to about 900° C., and too much carbon dioxide appears in the product. During the steaming the gas is carried off by a special conduit into a scrubber, where the dust mechanically carried away in the current is washed out, and the gas is at the same time cooled down nearly to the ordinary temperature. It is generally stored in a gas-holder, from which it is conducted away as required. It is never quite free from nitrogen, as the producer at the beginning of steaming contains much of this gas, together with CO or CO₂. The proportion of hydrogen may exceed 50%, in consequence of reaction (c) setting in at the close of the steaming. Ordinary "blue" water gas, if, as usual, made from coke or anthracite, contains 48-52% H₂, 40-41% CO, 1-5% CO₂, 4-5% N₂, and traces of hydrocarbons, especially methane. If made from bituminous coal, it contains more of the latter. If "carburetted" (a process which increases its volume 50% and more) by the vapours from superheated petroleum naphtha, the proportion of CO ranges about 25%, with about as much methane, and from 10 to 15% of "illuminants" (heavy hydrocarbons). The latter, of course, greatly enhance the fuel-value of the gas. Pure water gas would possess the following fuel-value per cubic metre:

0.5	cub. met. H ₂	= 1291	calories
0.5	"	CO = 1522	"
		2813	"

Ordinary "blue" water gas has a fuel-value of at least 2500 calories. Carburetted water gas, which varies very much in its percentage of hydrocarbons, sometimes reaches nearly the heat-value of coal gas, but such gas is only in exceptional cases used for heating purposes.

We must now turn to the "blowing-up" stage of the process. Until recently it was assumed that during this stage the combustion of carbon cannot be carried on beyond the formation of carbon monoxide, for as the gas-producer must necessarily contain a deep layer of fuel (generally about 6 to 10 ft.), any CO₂ formed at first would be reduced to CO; and it was further assumed that hardly any CO₂ would be formed from the outset, as the temperature of the apparatus is too high for this reaction to take place. But as the combustion of C to CO produces only about 30% of the heat produced when C is burned into CO₂; the quantity of fuel consumed for "blowing-up" is very large, and in fact considerably exceeds that consumed in "steaming." There is, of course, a further loss by radiation and minor sources, and the result is that 1 kilogram of carbon yields only about 1.2 cub. met. of water gas. Each period of blowing-up generally occupies from 8 to 12 minutes, that of steaming only 4 or 5 minutes. This low yield of water gas until quite recently appeared to be unavoidable, and the only question seemed to be whether and to what extent the gas formed during blowing-up, which is in fact identical with ordinary producer gas (Siemens gas), could be utilized. In America, where the water gas is mostly employed for illuminating purposes, at least part of the blowing-up gas is utilized for heating the apparatus in which the naphtha is volatilized and the vapours are "fixed" by superheating. This process, however, never utilizes anything like the whole of the blowing-up gas, nor can this be effected by raising and superheating the steam necessary for the second operation; indeed, the employment of this gas for raising steam is not very easy, owing to the irregularities of and constant interruptions in the supply. In some systems the gas made during the blowing-up stage is passed through chambers, loosely filled with bricks, like Siemens recuperators, where it is burned by "secondary" air: the heat thus imparted to the brickwork is utilized by passing through the recuperator, and thus superheating, the steam required for the next steaming operation. In many cases, principally where no carburetted is practised, the blowing-up gas is simply burned at the mouth of the producer, and is thus altogether lost; and in no case can it be utilized without great

waste. A very important improvement in this respect was effected by C. Dellwik and E. Fleischer. They found that the view that it is unavoidable to burn the carbon to monoxide during the blowing-up holds good only for the pressure of blast formerly applied. This did not much exceed that which is required for overcoming the frictional resistance within the producer. If, however, the pressure is considerably increased, and the height of the column of fuel reduced, both of these conditions being strictly regulated in accordance with the result desired, it is easy to attain a combustion of the carbon to dioxide, with only traces of monoxide, in spite of the high temperature. Evidently the excess of oxygen coming into contact with each particle of carbon in a given unit of time produces other conditions of chemical equilibrium than those existing at lower pressures. At any rate, experience has shown that by this process, in which the full heat-value of carbon is utilized during the blowing-up stage, the time of heating-up can be reduced from 10 to 1½ or 2 minutes, and the steaming can be prolonged from 4 or 5 to 8 or 10 minutes, with the result that twice the quantity of water gas is obtained, viz. upwards of 2 cub. metres from 1 kilogram of carbon.

The application of water gas as a fuel mainly depends upon the high temperatures which it is possible to attain by its aid, and these are principally due to the circumstance that it forms a much smaller flame than coal gas, not to speak of Siemens gas, which contains at most 33% of combustible matter against 90% or more in water gas. The latter circumstance also allows the gas to be conducted and distributed in pipes of moderate dimensions. Its application, apart from its use as an illuminant (with which we are not concerned here), was formerly retarded by its high cost in comparison with Siemens gas and other sources of heat, but as this state of affairs has been changed by the modern improvements, its use is rapidly extending, especially for metallurgical purposes.

C. Mixed Gas (Semi-Water Gas).—This class is sometimes called Dowson gas, irrespective of its method of production, although it was made and extensively used a long time before J. E. Dowson constructed his apparatus for generating such a gas principally for driving gas-engines. By a combination of the processes for generating Siemens gas and water gas, it is produced by injecting into a gas-producer at the same time a certain quantity of air and a corresponding quantity of steam, the latter never exceeding the amount which can be decomposed by the heat-absorbing reaction, $C + H_2O = CO + H_2$, at the expense of the heat generated by the action of the air in the reaction $C + O = CO$. Such gas used to be frequently obtained in an accidental way by introducing liquid water or steam into an ordinary gas-producer for the purpose of facilitating its working by avoiding an excessive temperature, such as might cause the rapid destruction of the brickwork and the fusion of the ashes of the fuel into troublesome cakes. It was soon found that by proceeding in this way a certain advantage could be gained in regard to the consumption of fuel, as the heat abstracted by the steam from the brickwork and the fuel itself was usefully employed for decomposing water, its energy thus reappearing in the shape of a combustible gas. It is hardly necessary to mention explicitly that the total heat obtained by any such process from a given quantity of carbon (or hydrogen) can in no case exceed that which is generated by direct combustion; some inventors, however, whether inadvertently or intentionally, have actually represented this to be possible, in manifest violation of the law of the conservation of energy.

Roughly speaking, this gas may be said to be produced by the combination of the reactions, described *sub* A and B, to the joint reaction: $2C + O + H_2O = 2CO + H_2$. The decomposition of H₂O (applied in the shape of steam) absorbs 57.6 gram calories, the formation of 2CO produces 59 gram calories; hence there is a small positive excess of 1.4 calories at disposal. This in reality would not be sufficient to cover the loss by radiation, &c.; hence rather more free oxygen (*i.e.* atmospheric air) must be employed than is represented by the above equation. All this free oxygen is, of course, accompanied by nearly four times its volume of nitrogen.

The mixed gas thus obtained differs very much in composition, but is always much richer in hydrogen (of which it contains sometimes as much as 20%) and poorer in carbon monoxide (sometimes down to 20%) than Siemens gas; generally it contains more of CO₂ than the latter. The proportion of nitrogen is always less, about 50%. It is therefore a more concentrated fuel than Siemens gas, and better adapted to the driving of gas-engines. It scarcely costs more to make than ordinary Siemens gas, except where the steam is generated and superheated in special apparatus, as is done in the Dowson producer, which, on the other hand, yields a correspondingly better gas. As is natural, its properties are some way between those of Siemens gas and of water gas; but they approach more nearly the former, both as to costs and as to fuel-value, and also as to the temperatures reached in combustion. This is easily understood if we consider that gas of just the same description can be obtained by mixing one volume of real water gas with the four volumes of Siemens gas made during the blowing-up stage—an operation which is certainly too expensive for practical use.

A modification of this gas is the *Mond gas*, which is made, according to Mond's patent, by means of such an excess of steam that most of the nitrogen of the coke is converted into ammonia (Grouven's reaction). Of course much of this steam passes on undecomposed, and the quantity of the gas is greatly increased by the reaction $C + 2H_2O = CO_2 + 2H_2$; hence the fuel-value of this gas is less than that of semi-water gas made in other ways. Against this loss must be set the gain of ammonia which is recovered by means of an arrangement of coolers and scrubbers, and, except at very low prices of ammonia, the profit thus made is probably more than sufficient to cover the extra cost. But as the process requires very large and expensive plant, and its profits would vanish in the case of the value of ammonia becoming much lower (a result which would very probably follow if it were somewhat generally introduced), it cannot be expected to supplant the other descriptions of gaseous fuel to more than a limited extent.

Semi-water gas is especially adapted for the purpose of driving gas-engines on the explosive principle (gas-motors). Ordinary producer-gas is too poor for this purpose in respect of heating power; moreover, owing to the prevalence of carbon monoxide, it does not light quickly enough. These defects are sufficiently overcome in semi-water gas by the larger proportion of hydrogen contained in it. For the purpose in question the gas should be purified from tar and ashes, and should also be cooled down before entering the gas-engine. The Dowson apparatus and others are constructed on this principle.

Air Gas.—By forcing air over or through volatile inflammable liquids a gaseous mixture can be obtained which burns with a bright flame and which can be used for illumination. Its employment for heating purposes is quite exceptional, e.g. in chemical laboratories, and we abstain, therefore, from describing any of the numerous appliances, some of them bearing very fanciful names, which have been devised for its manufacture. (G. L.)

FUENTE OVEJUNA [*Fuenteovejuna*], a town of Spain, in the province of Cordova; near the sources of the river Guadiato, and on the Fuente del Arco-Belmez-Cordova railway. Pop. (1900) 11,777. Fuente Ovejuna is built on a hill, in a well-irrigated district, which, besides producing an abundance of wheat, wine, fruit and honey, also contains argentiferous lead mines and stone quarries. Cattle-breeding is an important local industry, and leather, preserved meat, soap and flour are manufactured. The parish church formerly belonged to the knights of Calatrava (c. 1163-1486).

FUENTERRABIA (formerly sometimes written *Fontarabia*; Lat. *Fons Rapidus*), a town of northern Spain, in the province of Guipúzcoa; on the San Sebastian-Bayonne railway; near the Bay of Biscay and on the French frontier. Pop. (1870) about 750; (1900) 4345. Fuenterrabia stands on the slope of a hill on the left bank of the river Bidassoa, and near the point where its estuary begins. Towards the close of the 19th century the town became popular as a summer resort for visitors from the interior of Spain, and, in consequence, its appearance under-

went many changes and much of its early prosperity returned. Hotels and villas were built in the new part of the town that sprang up outside the picturesque walled fortress, and there is quite a contrast between the part inside the heavy, half-ruined ramparts, with its narrow, steep streets and curious gable-roofed houses, its fine old church and castle and its massive town hall, and the new suburbs and fishermen's quarter facing the estuary of the Bidassoa. Many industries flourish on the outskirts of the town, including rope and net manufactures, flour mills, saw mills, mining railways, paper mills.

Fuenterrabia formerly possessed considerable strategic importance, and it has frequently been taken and retaken in wars between France and Spain. The rout of Charlemagne in 778, which has been associated with Fontarabia, by Milton (*Paradise Lost*, i. 587), is generally understood to have taken place not here but at Roncesvalles (*q.v.*), which is nearly 40 m. E.S.E. Unsuccessful attempts to seize Fuenterrabia were made by the French troops in 1476 and again in 1503. In a subsequent campaign (1521) these were more successful, but the fortress was retaken in 1524. The prince of Condé sustained a severe repulse under its walls in 1638, and it was on this occasion that the town received from Philip IV. the rank of city (*muy noble, muy leal, y muy valerosa ciudad*, "most noble, most loyal, and most valiant city"), a privilege which involved some measure of autonomy. After a severe siege, Fuenterrabia surrendered to the duke of Berwick and his French troops in 1719; and in 1794 it again fell into the hands of the French, who so dismantled it that it has never since been reckoned by the Spaniards among their fortified places. It was by the ford opposite Fuenterrabia that the duke of Wellington, on the 8th of October 1813, successfully forced a passage into France in the face of an opposing army commanded by Marshal Soult. Severe fighting also took place here during the Carlist War in 1837.

FUERO, a Spanish term, derived from the Latin *forum*. The Castilian use of the word in the sense of a right, privilege or charter is most probably to be traced to the Roman *conventus juridici*, otherwise known as *jurisdicciones* or *fora*, which in Pliny's time were already numerous in the Iberian peninsula. In each of these provincial *fora* the Roman magistrate, as is well known, was accustomed to pay all possible deference to the previously established common law of the district; and it was the privilege of every free subject to demand that he should be judged in accordance with the customs and usages of his proper forum. This was especially true in the case of the inhabitants of those towns which were in possession of the *jus italicum*. It is not, indeed, demonstrable, but there are many presumptions, besides some fragments of direct evidence, which make it more than probable that the old administrative arrangements both of the provinces and of the towns, but especially of the latter, remained practically undisturbed at the period of the Gothic occupation of Spain.¹ The Theodosian Code and the Breviary of Alaric alike seem to imply a continuance of the municipal system which had been established by the Romans; nor does the later Lex Visigothorum, though avowedly designed in some points to supersede the Roman law, appear to have contemplated any marked interference with the former *fora*, which were still to a large extent left to be regulated in the administration of justice by unwritten, immemorial, local custom. Little is known of the condition of the subject populations of the peninsula during the Arab occupation; but we are informed that the Christians were, sometimes at least, judged according to their own laws in separate tribunals presided over by Christian judges;² and the mere fact of the preservation of the name *alcalde*, an official whose functions corresponded so closely to those of the *judex* or *defensor civitatis*, is fitted to suggest that the old municipal *fora*, if much impaired, were not even then in all cases wholly destroyed. At all events when the word *forum*³ begins to appear for the first time in documents of the 10th century in the sense of a liberty or

¹ The nature of the evidence may be gathered from Savigny, *Conc. d. rom. Rechts*. See especially i. pp. 154, 259 seq.

² Compare Lembke u. Schifer, *Geschichte von Spanien*, l. 314; ii. 117.

³ Or rather *forus*. See Ducange, *s.v.*

privilege, it is generally implied that the thing so named is nothing new. The earliest extant written fuero is probably that which was granted to the province and town of Leon by Alphonso V. in 1020. It emanated from the king in a general council of the kingdom of Leon and Castile, and consisted of two separate parts; in the first 19 chapters were contained a series of statutes which were to be valid for the kingdom at large, while the rest of the document was simply a municipal charter.¹ But in neither portion does it in any sense mark a new legislative departure, unless in so far as it marks the beginning of the era of written charters for towns. The "fuero general" does not profess to supersede the *consuetudines antiquorum iurium* or Chindaswint's codification of these in the Lex Visigothorum; the "fuero municipal" is really for the most part but a resuscitation of usages formerly established, a recognition and definition of liberties and privileges that had long before been conceded or taken for granted. The right of the burgesses to self-government and self-taxation is acknowledged and confirmed, they, on the other hand, being held bound to a constitutional obedience and subjection to the sovereign, particularly to the payment of definite imperial taxes, and the rendering of a certain amount of military service (as the ancient municipia had been). Almost contemporaneous with this fuero of Leon was that granted to Najera (Naxera) by Sancho el Mayor of Navarre (ob. 1035), and confirmed, in 1076, by Alphonso VI.² Traces of others of perhaps even an earlier date are occasionally to be met with. In the fuero of Cardeña, for example, granted by Ferdinand I. in 1039, reference is made to a previous forum Burgense (Burgos), which, however, has not been preserved, if, indeed, it ever had been reduced to writing at all. The phraseology of that of Sepulveda (1076) in like manner points back to an indefinitely remote antiquity.³ Among the later fueros of the 11th century, the most important are those of Jaca (1064) and of Logroño (1095). The former of these, which was distinguished by the unusual largeness of its concessions, and by the careful minuteness of its details, rapidly extended to many places in the neighbourhood, while the latter charter was given also to Miranda by Alphonso VI., and was further extended in 1181 by Sancho el Sabio of Navarre to Vitoria, thus constituting one of the earliest written fora of the "Provincias Vascongadas." In the course of the 12th and 13th centuries the number of such documents increased very rapidly; that of Toledo especially, granted to the Mozarabic population in 1101, but greatly enlarged and extended by Alphonso VII. (1118) and succeeding sovereigns, was used as a basis for many other Castilian fueros. Latterly the word fuero came to be used in Castile in a wider sense than before, as meaning a general code of laws; thus about the time of Saint Ferdinand the old Lex Visigothorum, then translated for the first time into the vernacular, was called the Fuero Juzgo, a name which was soon retranslated into the barbarous Latin of the period as Forum Judicum;⁴ and among the compilations of Alphonso the Learned in like manner were an *Espejo de Fueros* and also the *Fuero de las leyes*, better known perhaps as the *Fuero Real*. The famous code known as the *Ordenamiento Real de Alcalá*, or *Fuero Viejo de Castilla*, dates from a still later period. As the power of the Spanish crown was gradually concentrated and consolidated, royal pragmatics began to take the place of constitutional laws;

¹ Cap. xx. begins: "Constituimus etiam ut Legionensis civitas, quae depopulata fuit a Sarracenis in diebus patris mei Veremundi regis, repopulatur per hos foros subscriptos."

² "Mando et concedo et confirmo ut ista civitas cum sua plebe et cum omnibus suis pertinentiis sub tali lege et sub tali foro maneat per saecula cuncta. Amen. Isti sunt fueros quae habuerunt in Najera in diebus Sanctii regis et Gartiani regis."

³ "Ego Aldefonus rex et uxor mea Agnes confirmamus ad Septempública suo foro quod habuit in tempore antiquo de avolo meo et in tempore comitum Ferrando Gonzalez et comite Garcia Fernandez et comite Donno Santio."

⁴ This Latin is later even than that of Ferdinand, whose words are: "Statuo et mando quod Liber Judicum, quo ego misi Cordubam, translatur in vulgare et vocetur forum de Corduba. . . et quod per saecula cuncta sit pro foro et nullus sit ausus istud forum aliter appellare nisi forum de Corduba et jubeo et mando quod omnis morator et populator. . . veniet ad iudicium et ad forum de Corduba."

the local fueros of the various districts slowly yielded before the superior force of imperialism; and only those of Navarre and the Basque provinces (see Basques) have had sufficient vitality to enable them to survive to comparatively modern times. While actually owning the lordship of the Castilian crown since about the middle of the 14th century, these provinces rigidly insisted upon compliance with their consuetudinary law, and especially with that which provided that the *señor*, before assuming the government, should personally appear before the assembly and swear to maintain the ancient constitutions. Each of the provinces mentioned had distinct sets of fueros, codified at different periods, and varying considerably as to details; the main features, however, were the same in all. Their rights, after having been recognized by successive Spanish sovereigns from Ferdinand the Catholic to Ferdinand VII., were, at the death of the latter in 1833, set aside by the government of Castafios. The result was a civil war, which terminated in a renewed acknowledgment of the fueros by Isabel II. (1839). The provisional government of 1868 also promised to respect them, and similar pledges were given by the governments which succeeded. In consequence, however, of the Carlist rising of 1873-1876, the Basque fueros were finally extinguished in 1876. The history of the *Fozaes* of the Portuguese towns, and of the *Fors des Béarns*, is precisely analogous to that of the fueros of Castile.

Among the numerous works that more or less expressly deal with this subject, that of Marina (*Ensayo historico-crítico sobre la antigua legislación y principales cuerpos legales de los reynos de Leon y Castilla*) still continues to hold a high place. Reference may also be made to Colmeiro's *Curso de derecho político segun la historia de Leon y de Castilla* (Madrid, 1873); to Schäfer's *Geschichte von Spanien*, ii. 418-428, iii. 293 seq.; and to Hallam's *Middle Ages*, c. iv.

FUERTEVENTURA, an island in the Atlantic Ocean, forming part of the Spanish archipelago of the Canary Islands (*q.v.*). Pop. (1900) 11,669; area 665 sq. m. Fuerteventura lies between Lanzarote and Grand Canary. It has a length of 52 m., and an average width of 12 m. Though less mountainous than the other islands, its aspect is barren. There are only two springs of fresh water, and these are confined to one valley. Lava streams and other signs of volcanic action abound, but there has been no igneous activity since the Spaniards took possession. At each extremity of the island are high mountains, which send off branches along the coast so as to enclose a large arid plain. The highest peak reaches 2500 ft. In external appearance, climate and productions, Fuerteventura greatly resembles Lanzarote. An interval of three years without rain has been known. Oliva (pop. 1900, 2464) is the largest town. A smaller place in the centre of the island named Betancuria (586) is the administrative capital. Cabras (1000) on the eastern coast is the chief port. Dromedaries are bred here.

FUGGER, the name of a famous German family of merchants and bankers. The founder of the family was Johann Fugger, a weaver at Graben, near Augsburg, whose son, Johann, settled in Augsburg probably in 1367. The younger Johann added the business of a merchant to that of a weaver, and through his marriage with Clara Widolph became a citizen of Augsburg. After a successful career he died in 1408, leaving two sons, Andreas and Jakob, who greatly extended the business which they inherited from their father. Andreas, called the "rich Fugger," had several sons, among them being Lukas, who was very prominent in the municipal politics of Augsburg and who was very wealthy until he was ruined by the repudiation by the town of Louvain of a great debt owing to him, and Jakob, who was granted the right to bear arms in 1452, and who founded the family of Fugger vom Reh—so called from the first arms of the Fuggers, a roc (*Rok*) or on a field azure—which became extinct on the death of his great-grandson, Ulrich, in 1583. Johann Fugger's son, Jakob, died in 1469, and three of his seven sons, Ulrich (1441-1510), Georg (1453-1506) and Jakob (1459-1525), men of great resource and industry, inherited the family business and added enormously to the family wealth. In 1473 Ulrich obtained from the emperor Frederick III. the right to bear arms for himself and his brothers, and about the same time he began

to act as the banker of the Habsburgs, a connexion destined to bring fame and fortune to his house. Under the lead of Jakob, who had been trained for business in Venice, the Fuggers were interested in silver mines in Tirol and copper mines in Hungary, while their trade in spices, wool and silk extended to almost all parts of Europe. Their wealth enabled them to make large loans to the German king, Maximilian I., who pledged to them the county of Kirchberg, the lordship of Weissenhorn and other lands, and bestowed various privileges upon them. Jakob built the castle of Fuggerei in Tirol, and erected the Fuggerei at Augsburg, a collection of 106 dwellings, which were let at low rents to poor people and which still exist. Jakob Fugger and his two nephews, Ulrich (d. 1525) and Hieronymus (d. 1536), the sons of Ulrich, died without direct heirs, and the family was continued by Georg's sons, Raimund (1489-1535) and Anton (1493-1560), under whom the Fuggerei attained the summit of their wealth and influence.

Jakob Fugger's florins had contributed largely to the election of Charles V. to the imperial throne in 1519, and his nephews and heirs maintained close and friendly relations with the great emperor. In addition to lending him large sums of money, they farmed his valuable quicksilver mines at Almaden, his silver mines at Guadalcanal, the great estates of the military orders which had passed into his hands, and other parts of his revenue as king of Spain; receiving in return several tokens of the emperor's favour. In 1530 Raimund and Anton were granted the imperial dignity of counts of Kirchberg and Weissenhorn, and obtained full possession of these mortgaged properties; in 1534 they were given the right of coining money; and in 1541 received rights of jurisdiction over their lands. During the diet of Augsburg in 1550 Charles V. was the guest of Anton Fugger at his house in the Weinmarkt, and the story relates how the merchant astonished the emperor by lighting a fire of cinnamon with an imperial bond for money due to him. This incident forms the subject of a picture by Carl Becker which is in the National Gallery at Berlin. Continuing their mercantile career, the Fuggerei brought the new world within the sphere of their operations, and also carried on an extensive and lucrative business in farming indulgences. Moreover, both brothers found time to acquire landed property, and were munificent patrons of literature and art. When Anton died he is said to have been worth 6,000,000 florins, besides a vast amount of property in Europe, Asia and America; and before this time the total wealth of the family had been estimated at 63,000,000 florins. The Fuggerei were devotedly attached to the Roman Catholic Church, which benefited from their liberality. Jakob had been made a count palatine (*Pfalzgraf*) and had received other marks of favour from Pope Leo X., and several members of the family had entered the church; one, Raimund's son, Sigmund, becoming bishop of Regensburg.

In addition to the bishop, three of Raimund Fugger's sons attained some degree of celebrity. Johann Jakob (1516-1575), was the author of *Wahrhaftigen Beschreibung des österreichischen und habsburgischen Namens*, which was largely used by S. von Bircken in his *Spiegel der Ehren des Erzhauses Österreich* (Nuremberg, 1668), and of a *Geheim Erbnbuch des Fuggerei Geschlechtes*. He was also a patron of art, and a distinguished counsellor of Duke Albert IV. of Bavaria. After the death of his son Konstantin, in 1627, this branch of the family was divided into three lines, which became extinct in 1738, 1795 and 1846 respectively. Another of Raimund's sons was Ulrich (1526-1584), who, after serving Pope Paul III. at Rome, became a Protestant. Hated on this account by the other members of his family, he took refuge in the Rhenish Palatinate; greatly interested in the Greek classics, he occupied himself in collecting valuable manuscripts, which he bequeathed to the university of Heidelberg. Raimund's other son was Georg (d. 1579), who inherited the countships of Kirchberg and Weissenhorn, and founded a branch of the family which still exists, its present head being Georg, Count Fugger of Kirchberg and Weissenhorn (b. 1850).

Anton Fugger left three sons, Marcus (1529-1597), Johann (d. 1598) and Jakob (d. 1598), all of whom left male issue.

Marcus was the author of a book on horse-breeding, *Wie und wo man ein Gestüt von guten edeln Kriegsgrossen aufrichten soll* (1578), and of a German translation of the *Historia ecclesiastica* of Nicephorus Callistus. He founded the Nordendorf branch of the family, which became extinct on the death of his grandson, Nicolaus, in 1676. Another grandson of Marcus was Franz Fugger (1612-1664), who served under Wallenstein during the Thirty Years' War, and was afterwards governor of Ingolstadt. He was killed at the battle of St Gotthard on the 1st of August 1664.

Johann Fugger had three sons, Christoph (d. 1615) and Marcus (d. 1614), who founded the families of Fugger-Glött and Fugger-Kirchheim respectively, and Jakob, bishop of Constance from 1604 until his death in 1626. Christoph's son, Otto Heinrich (1592-1644), was a soldier of some distinction and a knight of the order of the Golden Fleece. He was one of the most active of the Bavarian generals during the Thirty Years' War, and acted as governor of Augsburg, where his rule aroused much discontent. The family of Kirchheim died out in 1672. That of Glött was divided into several branches by the sons of Otto Heinrich and of his brother Johann Ernst (d. 1628). These lines, however, have gradually become extinct except the eldest line, represented in 1909 by Karl Ernst, Count Fugger of Glött (b. 1859). Anton Fugger's third son Jakob, the founder of the family of Wellenburg, had two sons who left issue, but in 1777 the possessions of this branch of the family were again united by Anselm Joseph (d. 1793), Count Fugger of Babenhausen. In 1803 Anselm's son, Anselm Maria (d. 1821), was made a prince of the Holy Roman Empire, the title of Prince Fugger of Babenhausen being borne by his direct descendant Karl (b. 1861). On the fall of the empire in 1806 the lands of the Fuggerei, which were held directly of the empire, were mediatised under Bavaria and Württemberg. The heads of the three existing branches of the Fuggerei are all hereditary members of the Bavarian Upper House.

Augsburg has many interesting mementoes of the Fuggerei, including the family burial-chapel in the church of St Anna; the Fugger chapel in the church of St Ulrich and St Afra; the Fuggerhaus, still in the possession of one branch of the family; and a statue of Johann Jakob Fugger.

In 1593 a collection of portraits of the Fuggerei, engraved by Dominique Custos of Antwerp, was issued at Augsburg. Editions with 127 portraits appeared in 1618 and 1620, the former accompanied by a genealogy in Latin, the latter by one in German. Another edition of this *Pinacotheca Fuggerei*, published at Vienna in 1754, includes 139 portraits. See *Chronik der Familie Fugger vom Jahre 1590*, edited by C. Meyer (Munich, 1902); A. Geiger, *Jakob Fugger, 1450-1525* (Regensburg, 1895); A. Schulte, *Die Fugger in Rom, 1495-1525* (Leipzig, 1904); R. Ehrenberg, *Das Zeitalter der Fugger* (Jena, 1896); K. Häbler, *Die Geschichte der Fuggerei Handlung in Spanien* (Weimar, 1897); A. Stauber, *Das Haus Fugger* (Augsburg, 1900); and M. Jansen, *Die Anfänge der Fugger* (Leipzig, 1907).

FUGITIVE SLAVE LAWS, a term applied in the United States to the Statutes passed by Congress in 1793 and 1850 to provide for the return of negro slaves who escaped from one state into another or into a public territory. A fugitive slave clause was inserted in the Articles of Confederation of the New England Confederation of 1643, providing for the return of the fugitive upon the certificate of one magistrate in the jurisdiction out of which the said servant fled—no trial by jury being provided for. This seems to have been the only instance of an inter-colonial provision for the return of fugitive slaves; there were, indeed, not infrequent escapes by slaves from one colony to another, but it was not until after the growth of anti-slavery sentiment and the acquisition of western territory, that it became necessary to adopt a uniform method for the return of fugitive slaves. Such provision was made in the Ordinance of 1787 (for the Northwest Territory), which in Article VI. provided that in the case of "any person escaping into the same [the Northwest Territory] from whom labor or service is lawfully claimed in any one of the original states, such fugitive may be lawfully reclaimed and conveyed to the person claiming his or her labor or service as aforesaid." An agreement of the sort was

necessary to persuade the slave-holding states to union, and in the Federal Constitution, Article IV., Section II., it is provided that "no person held to service or labor in one state, under the laws thereof, escaping into another, shall, in consequence of any law or regulation therein, be discharged from such service or labor, but shall be delivered up on claim of the party to whom such service or labour may be due."

The first specific legislation on the subject was enacted on the 12th of February 1793, and like the Ordinance for the Northwest Territory and the section of the Constitution quoted above, did not contain the word "slave"; by its provisions any Federal district or circuit judge or any state magistrate was authorized to decide finally and without a jury trial the status of an alleged fugitive. The measure soon met with strong opposition in the northern states, and Personal Liberty Laws were passed to hamper officials in the execution of the law; Indiana in 1824 and Connecticut in 1828 providing jury trial for fugitives who appealed from an original decision against them. In 1840 New York and Vermont extended the right of trial by jury to fugitives and provided them with attorneys. As early as the first decade of the 19th century individual dissatisfaction with the law of 1793 had taken the form of systematic assistance rendered to negroes escaping from the South to Canada or New England—the so-called "Underground Railroad."¹ The decision of the Supreme Court of the United States in the case of *Prigg v. Pennsylvania* in 1842 (16 Peters 539), that state authorities could not be forced to act in fugitive slave cases, but that national authorities must carry out the national law, was followed by legislation in Massachusetts (1843), Vermont (1843), Pennsylvania (1847) and Rhode Island (1848), forbidding state officials to help enforce the law and refusing the use of state gaols for fugitive slaves. The demand from the South for more effective Federal legislation was voiced in the second fugitive slave law, drafted by Senator J. M. Mason of Virginia, and enacted on the 18th of September 1850 as a part of the Compromise Measures of that year. Special commissioners were to have concurrent jurisdiction with the U.S. circuit and district courts and the inferior courts of Territories in enforcing the law; fugitives could not testify in their own behalf; no trial by jury was provided;

¹ The precise amount of organization in the Underground Railroad cannot be definitely ascertained because of the exaggerated use of the figure of railroading in the documents of the "presidents" of the road, Robert Purvis and Levi Coffin, and of its many "conductors," and their discussion of the "packages" and "freight" shipped by them. The system reached from Kentucky and Virginia across Ohio, and from Maryland across Pennsylvania and New York, to New England and Canada, and as early as 1817 a group of anti-slavery men in southern Ohio had helped to Canada as many as 1000 slaves. The Quakers of Pennsylvania possibly began the work of the mysterious Underground Railroad; the best known of them was Thomas Garrett (1789-1871), a native of Pennsylvania, who, in 1822, removed to Wilmington, Delaware, where he was convicted in 1848 on four counts under the Fugitive Slave Law and was fined \$8000; he is said to have helped 2700 slaves to freedom. The most picturesque figure of the Underground Railroad was Harriet Tubman (c. 1820), called by her friend, John Brown, "General" Tubman, and by her fellow negroes "Moses." She made about a score of trips into the South, bringing out with her 300 negroes altogether. At one time a reward of \$40,000 was offered for her capture. She was a mystic, with remarkable clairvoyant powers, and did great service as a nurse, a spy and a scout in the Civil War. Levi Coffin (1798-1877), a native of North Carolina (whose cousin, Vestal Coffin, had established before 1819 a "station" of the Underground near what is now Guilford College, North Carolina), in 1826 settled in Wayne County, Ohio; his home at New Garden (now Fountain City) was the meeting point of three "lines" from Kentucky; and in 1847 he removed to Cincinnati, where his labours in bringing slaves out of the South were even more successful. It has been argued that the Underground Railroad delayed the final decision of the slavery question, inasmuch as it was a "safety valve" for, without it, the more intelligent and capable of the negro slaves would, it is asserted, have become the leaders of insurrections in the South, and would not have been removed from the places where they could have done most damage. Consult William Still, *The Underground Railroad* (Philadelphia, 1872), a collection of anecdotes by a negro agent of the Pennsylvania Anti-Slavery Society, and of the Philadelphia branch of the Railroad; and the important and scholarly work of Wilbur H. Siebert, *The Underground Railroad from Slavery to Freedom* (New York, 1898).

penalties were imposed upon marshals who refused to enforce the law or from whom a fugitive should escape, and upon individuals who aided negroes to escape; the marshal might raise a *posse comitatus*; a fee of \$10 was paid to the commissioner when his decision favoured the claimant and only \$5 when it favoured the fugitive; and both the fact of the escape and the identity of the fugitive were to be determined on purely *ex parte* testimony. The severity of this measure led to gross abuses and defeated its purpose; the number of abolitionists increased, the operations of the Underground Railroad became more efficient, and new Personal Liberty Laws were enacted in Vermont (1850), Connecticut (1854), Rhode Island (1854), Massachusetts (1855), Michigan (1855), Maine (1855 and 1857), Kansas (1858) and Wisconsin (1858). These Personal Liberty Laws forbade justices and judges to take cognizance of claims, extended the *habeas corpus* act and the privilege of jury trial to fugitives, and punished false testimony severely. The supreme court of Wisconsin went so far (1859) as to declare the Fugitive Slave Law unconstitutional. These state laws were one of the grievances officially referred to by South Carolina (in Dec. 1860) as justifying her secession from the Union. Attempts to carry into effect the law of 1850 aroused much bitterness. The arrests of Sims and of Shadrach in Boston in 1851; of "Jerry" M'Henry, in Syracuse, New York, in the same year; of Anthony Burns in 1854, in Boston; and of the two Garner families in 1856, in Cincinnati, with other cases arising under the Fugitive Slave Law of 1850, probably had as much to do with bringing on the Civil War as did the controversy over slavery in the Territories.

With the beginning of the Civil War the legal status of the slave was changed by his master's being in arms. General B. F. Butler, in May 1861, declared negro slaves contraband of war. A confiscation bill, was passed in August 1861 discharging from his service or labour any slave employed in aiding or promoting any insurrection against the government of the United States. By an act of the 17th of July 1862 any slave of a disloyal master who was in territory occupied by northern troops was declared *ipso facto* free. But for some time the Fugitive Slave Law was considered still to hold in the case of fugitives from masters in the border states who were loyal to the Union government, and it was not until the 28th of June 1864 that the Act of 1850 was repealed.

See J. F. Rhodes, *History of the United States from the Compromise of 1850*, vols. i. and ii. (New York, 1893); and M. G. M'Dougall, *Fugitive Slaves, 1619-1865* (Boston, 1891).

FUGLEMAN (from the Ger. *Flügelmann*, the man on the Flügel or wing), properly a military term for a soldier who is selected to act as "guide," and posted generally on the flanks with the duty of directing the march in the required line, or of giving the time, &c., to the remainder of the unit, which conforms to his movements, in any military exercise. The word is then applied to a ringleader or one who takes the lead in any movement or concerted movement.

FUGUE (Lat. *fuga*, flight), in music, the mutual "pursuit" of voices or parts. It was, up to the end of the 16th century, if not later, the name applied to two art-forms. (A) *Fuga ligata* was the exact reproduction by one or more voices of the statement of a leading part. The reproducing voice (*comes*) was seldom if ever written out, for all differences between it and the *dux* were rigidly systematic; e.g. it was an exact inversion, or exactly twice as slow, or to be sung backwards, &c. &c. Hence, a rule or *canon* was given, often in enigmatic form, by which the *comes* was deduced from the *dux*: and so the term *canon* became the appropriate name for the form itself, and is still retained. (B) A composition in which the canonic style was cultivated without canonic restriction was, in the 16th century, called *fuga ricercata* or simply a *ricercare*, a term which is still used by Bach as a title for the fugues in *Das musikalische Opfer*.

The whole conception of fugue, rightly understood, is one of the most important in music, and the reasons why some contrapuntal compositions are called fugues, while others are not, are so trivial, technically as well as aesthetically, that we have

preferred to treat the subject separately under the general heading of CONTRAPUNTAL FORMS, reserving only technical terms for definition here.

(i.) If in the beginning or "exposition" the material with which the opening voice accompanies the answer is faithfully reproduced as the accompaniment to subsequent entries of the subject, it is called a *countersubject* (see COUNTERPOINT, under sub-heading *Double Countersubject*). Obviously the process may be carried further, the first countersubject going on to a second when the subject enters in the third part and so on. The term is also applied to new subjects appearing later in the fugue in combination (immediate or destined) with the original subject. Cherubini, holding the doctrine that a fugue cannot have more than one subject, insists on applying the term to the less prominent of the subjects of what are commonly called double fugues, i.e. fugues which begin with two parts and two subjects simultaneously, and so also with *triple* and *quadruple* fugues.

(ii.) *Episodes* are passages separating the entries of the subject.¹ Episodes are usually developed from the material of the subject and countersubjects; they are very rarely independent, but then conspicuously so.

(iii.) *Stretto*, the overlapping of subject and answer, is a resource the possibilities of which may be exemplified by the setting of the words *omnes generationes* in Bach's *Magnificat* (see BACH).

(iv.) The distinction between *real* and *tonal* fugue, which is still sometimes treated as a thing of great historical and technical importance, is really a mere detail resulting from the fact that a violent oscillation between the keys of tonic and dominant is no part of the function of a fugal exposition, so that the answer is (especially in its first notes and in points that tend to shift the key) not so much a transposition of the subject to the key of the dominant as an adaptation of it from the tonic part to the dominant part of the scale, or vice versa; in short, the answer is as far as possible *on* the dominant, not *in* the dominant. The modifications this principle produces in the answer (which have been happily described as resembling "fore-shortening") are the only distinctive marks of tonal fugue; and the text-books are half filled with the attempt to reduce them from matters of ear to rules of thumb, which rules, however, have the merit (unusual in those of the academic fugue) of being founded on observation of the practice of great masters. But the same principle as often as not produces answers that are exact transpositions of the subject; and so the only kind of real fugue (i.e. fugue with an exact answer) that could rightly be contrasted with tonal fugue would be that in which the answer ought to be tonal but is not. It must be admitted that tonal answers are rare in the modal music of the 16th century, though their melodic principles are of yet earlier date; still, though tonal fugue does not become usual until well on in the 17th century, the idea that it is a separate species is manifestly absurd, unless the term simply means "fugue in modern tonality or key," whatever the answer may be.

The term "answer" is usually reserved for those entries of the subject that are placed in what may be called the "complementary" position of the scale, whether they are "tonally" modified or not. Thus the order of entries in the exposition of the first fugue of the *Wohltemp. Klav.* is subject, answer, answer, subject; a departure from the usual rule according to which subject and answer are strictly alternate in the exposition.

In conclusion we may remind the reader of the most accurate as well as the most vivid description ever given of the essentials of a fugue, in the famous lines in *Paradise Lost*, book xi.

"His volant touch,
Instinct through all proportions, low and high,
Fled and pursued transverse the resonant fugue."

It is hard to realize that this description of organ-music was written in no classical period of instrumental polyphony, but just half-way between the death of Frescobaldi and the birth

¹An episode occurring during the exposition is sometimes called *codetta*, a distinction the uselessness of which at once appears on an analysis of Bach's 2nd fugue in the *Wohltemp. Klav.* (the term *codetta* is more correctly applied to notes filling in a gap between subject and its first answer, but such a gap is rare in good examples).

of Bach. Every word is a definition, both retrospective and prophetic; and in "transverse" we see all that Sir Frederick Gore Ouseley expresses in his popular distinction between the "perpendicular" or homophonic style in which harmony is built up in chords, and the "horizontal" or polyphonic style in which it is woven in threads of independent melody. (D. F. T.)

FÜHRICH, JOSEPH VON (1800-1876), Austrian painter, was born at Kratzau in Bohemia on the 9th of February 1800. Deeply impressed as a boy by rude pictures adorning the wayside chapels of his native country, his first attempt at composition was a sketch of the Nativity for the festival of Christmas in his father's house. He lived to see the day when, becoming celebrated as a composer of scriptural episodes, his sacred subjects were transferred in numberless repetitions to the roadside churches of the Austrian state, where humble peasants thus learnt to admire modern art reviving the models of earlier ages. Führich has been fairly described as a "Nazarene," a romantic religious artist whose pencil did more than any other to restore the old spirit of Dürer and give new shape to countless incidents of the gospel and scriptural legends. Without the power of Cornelius or the grace of Overbeck, he composed with great skill, especially in outline. His mastery of distribution, form, movement and expression was considerable. In its peculiar way his drapery was perfectly cast. Essentially creative as a landscape draughtsman, he had still no feeling for colour; and when he produced monumental pictures he was not nearly so successful as when designing subjects for woodcuts. Führich's fame extended far beyond the walls of the Austrian capital, and his illustrations to Tieck's *Genesefa*, the Lord's Prayer, the Triumph of Christ, the Road to Bethlehem, the Succession of Christ according to Thomas & Kempis, the Prodigal Son, and the verses of the Psalter, became well known. His Prodigal Son, especially, is remarkable for the fancy with which the spirit of evil is embodied in a figure constantly recurring, and like that of Mephistophelus exhibiting temptation in a human yet demoniacal shape. Führich became a pupil at the Academy of Prague in 1816. His first inspiration was derived from the prints of Dürer and the Faust of Cornelius, and the first fruit of this turn of study was the *Genesefa* series. In 1826 he went to Rome, where he added three frescoes to those executed by Cornelius and Overbeck in the Palazzo Massimo. His subjects were taken from the life of Tasso, and are almost solitary examples of his talent in this class of composition. In 1831 he finished the Triumph of Christ now in the Raczyński palace at Berlin. In 1834 he was made custos and in 1841 professor of composition in the Academy of Vienna. After this he completed the monumental pictures of the church of St. Nepomuk, and in 1854-1861 the vast series of wall paintings which cover the inside of the Lerchenfeld church at Vienna. In 1872 he was pensioned and made a knight of the order of Franz Joseph; 1875 is the date of his illustrations to the Psalms. He died on the 13th of March 1876.

His autobiography was published in 1875, and a memoir by his son Lucas in 1886.

FUJI (Fuji-san, Fujiyama, Fusi-yama), a celebrated mountain of Japan, standing W.S.W. of Tokyo, its base being about 70 m. by rail from that city. It rises to a height of 12,395 ft. and its southern slopes reach the shore of Suruga Bay. It is a cone of beautifully simple form, the more striking to view because it stands isolated; but its summit is not conical, being broken by a crater some 2000 ft. in diameter, for Fuji is a quiescent volcano. Small outbursts of steam are still to be observed at some points. An eruption is recorded so lately as the first decade of the 18th century. The mountain is the resort of great numbers of pilgrims (see also JAPAN).

FU-KIEN (formerly Mxn), a south-eastern province of China, bounded N. by the province of Cheh-kiang, S. by that of Kwang-tung, W. by that of Kiang-si and E. by the sea. It occupies an area of 53,480 sq. m. and its population is estimated at 20,000,000. The provincial capital is Fuchow Fu, and it is divided into eleven prefectures, besides that ruled over by the prefect of the capital city. Fu-kien is generally mountainous, being overspread by the Nan-shan ranges, which run a general course of N.E. and S.W.

The principal river is the Min, which is formed by the junction, in the neighbourhood of the city of Yen-p'ing Fu, of three rivers, namely, the Nui-si, which takes its rise in the mountains on the western frontier in the prefecture of Kien-ning Fu, the Fuh-tun Ki, the source of which is found in the district of Kwang-tsih in the north-west of the province, and the Ta-shi-ki (Shao Ki), which rises in the mountains in the western district of Ning-hwa. From Yen-p'ing Fu the river takes a south-easterly course, and after passing along the south face of the city of Fuchow Fu, empties itself into the sea about 30 m. below that town. Its upper course is narrow and rocky and abounds in rapids, but as it approaches Fuchow Fu the channel widens and the current becomes slow and even. Its depth is very irregular, and it is navigable only by native boats of a small class. Two other rivers flow into the sea near Amoy, neither of which, however, is navigable for any distance from its mouth owing to the shallows and rapids with which they abound. Thirty-five miles inland from Amoy stands the city of Chang Chow, famous for the bridge which there spans the Kin-lung river. This bridge is 800 ft. long, and consists of granite monoliths stretching from one abutment to another. The soil of the province is, as its name, "Happy Establishment," indicates, very productive, and the scenery is of a rich and varied character. Most of the hills are covered with verdure, and the less rugged are laid out in terraces. The principal products of the province are tea, of which the best kind is that known as Böhea, which takes its name, by a mispronunciation, from the Wu-e Mountains, in the prefecture of Kien-ning Fu, where it is grown; grains of various kinds, oranges, plantains, lichis, bamboo, ginger, gold, silver, lead, tin, iron, salt (both marine and rock), deers' horns, beeswax, sugar, fish, birds' nests, medicine, paper, cloth, timber, &c. Fu-kien has three open ports, Fuchow Fu opened in 1842, Amoy opened to trade in the same year and Funing. The latter port was only opened to foreign trade in 1898, but in 1904 it imported and exported goods to the value of £7668 and £278,160 respectively.

FUKUI, a town of Japan in the province of Echizen, Nippon, near the west coast, 20 m. N. by E. of Wakasa Bay. It lies in a volcanic district much exposed to earthquakes, and suffered severely during the disturbances of 1891-1892, when a chasm over 40 m. long was opened across the Neo valley from Fukui to Katabira. But Fukui subsequently revived, and is now in a flourishing condition, with several local industries, especially the manufacture of paper, and an increasing population exceeding 50,000. Fukui has railway communication. There are ruins of a castle of the Daimios of Echizen.

FUKUOKA, a town on the north-west coast of the island of Kiushiu, Japan, in the province of Chikuzen, 90 m. N.N.E. of Nagasaki by rail. Pop. about 72,000. With Hakata, on the opposite side of a small coast stream, it forms a large centre of population, with an increasing export trade and several local industries. Of these the most important is silk-weaving, and Hakata especially is noted for its durable silk fabrics. Fukuoka was formerly the residence of the powerful daimio of Chikuzen, and played a conspicuous part in the medieval history of Japan, the renowned temple of Yeiyas in the district was destroyed by fire during the revolution of 1868. There are several other places of this name in Japan, the most important being Fukuoka in the province of Mutsu, North Nippon, a railway station on the main line from Tokyo to Aimori Ura Bay. Pop. about 5000.

FULA (FULBE, FELLATAH or PEULS), a numerous and powerful African people, spread over an immense region from Senegal nearly to Darfur. Strictly they have no country of their own, and nowhere form the whole of the population, though nearly always the dominant native race. They are most numerous in Upper Senegal and in the countries under French sway immediately south of Senegambia, notably Futa Jallon. Farther east they rule, subject to the control of the French, Segu and Massena, countries on both banks of the upper Niger, to the south-west of Timbuktu. The districts within the great bend of the Niger have a large Fula population. East of that river Sokoto and its tributary emirates are ruled by Fula princes, subject to the control of the British Nigerian administration. Fula are settled

in Bornu, Bagirmi, Wadal and the upper Nile Valley,¹ but have no political power in those countries. Their most southerly emirate is Adamawa, the country on both sides of the upper Benue. In this vast region of distribution the Fula populations are most dense towards the west and north, most scattered towards the east and south. Originally herdsmen in the western and central Sudan, they extended their sway east of the Niger, under the leadership of Othman Dan Fodio, during the early years of the 19th century, and having subdued the Hausa states, founded the empire of Sokoto with the vassal emirates of Kano, Gando, Nupe, Adamawa, &c.

The question of the ethnic affinities of the Fula has given rise to an enormous amount of speculation, but the most reasonable theory is that they are a mixture of Berber and Negro. This is now the most generally accepted theory. Certainly there is no reason to connect them with the ancient Egyptians. In the district of Senegal known as Fuladugu or "Fula Land," where the purest types of the race are found, the people are of a reddish brown or light chestnut colour, with oval faces, ringlety or even smooth hair, never woolly, straight and even aquiline noses, delicately shaped lips and regular features quite differentiating them from the Negro type. Like most conquering races the Fula are, however, not of uniform physique, in many districts approximating to the local type. They nevertheless maintain throughout their widespread territory a certain national solidarity, thanks to common speech, traditions and usages. The ruling caste of the Fula differs widely in character from the herdsmen of the western Sudan. The latter are peaceable, inoffensive and abstemious. They are mainly monogamous, and by rigidly abstaining from foreign marriages have preserved racial purity. The ruling caste in Nigeria, on the other hand, despise their pastoral brethren, and through generations of polygamy with the conquered tribes have become more Negroid in type, black, burly and coarse featured. Love of luxury, pomp and finery is their chief characteristic. Taken as a whole, the Fula race is distinguished by great intelligence, frankness of disposition and strength of character. As soldiers they are renowned almost exclusively as cavalry; and the race has produced several leaders possessed of much strategical skill. Besides the ordinary Negro weapons, they use iron spears with leatherbound handles and swords. They are generally excellent rulers, stern but patient and just. The Nigerian emirs acquired, however, an evil reputation during the 19th century as slave raiders. They have long been devout Mahomedans, and mosques and schools exist in almost all their towns. Tradition says that of old every Fula boy and girl was a scholar; but during the decadence of their power towards the close of the 19th century education was not highly valued. Power seems to have somewhat spoiled this virile race, but such authorities as Sir Frederick Lugard believe them still capable of a great future.

The Fula language has as yet found no place in any African linguistic family. In its rudiments it is akin to the Hamito-Semitic group. It possesses two grammatical genders, not masculine and feminine, but the human and the non-human; the adjective agrees in assonance with its noun, and euphony plays a great part in verbal and nominal inflections. In some ways resembling the Negro dialects, it betrays non-Negroid influences in the use of suffixes. The name of the people has many variations. Fulbe or Fula (sing. Pullo, Peul) is the Mandingan name. Follani the Hausa, Fellatah the Kanuri, Fullan the Arab, and Fulde on the Benue. Like the name Abate, "white," given them in Kororofa, all these seem to refer to their light reddish hue.

See F. Ratzel, *History of Mankind* (English ed., London, 1896-1898); Sir F. Lugard, "Northern Nigeria," in *Geographical Journal* (July 1904); Grimal de Guironod, *Les Puls* (1887); E. A. Brackenbury, *A Short Vocabulary of the Fulani Language* (Zungeru, 1907); the articles NIGERIA and SOKOTO and authorities there cited.

¹ Sir Wm. Wallace in a report on Northern Nigeria ("Colonial Office" series, No. 551, 1907) calls attention to the exodus "of thousands of Fulani of all sorts, but mostly Mellawa, from the French Middle Niger," and states that the majority of the emigrants are settling in the Nile valley.

FULCHER (or **FOUCHER**) OF **CHARTRES** (1058-c. 1130), French chronicler, was a priest who was present at the council of Clermont in 1095, and accompanied Robert II., duke of Normandy, on the first crusade in 1096. Having spent some time in Italy and taken part in the fighting on the way to the Holy Land, he became chaplain to Baldwin, who was chosen king of Jerusalem in 1100, and lived with Baldwin at Edessa and then at Jerusalem. He accompanied this king on several warlike expeditions, but won more lasting fame by writing his *Historia Hierosolymitana* or *Gesta Francorum Jerusalem expugnantium*, one of the most trustworthy sources for the history of the first crusade. In its final form it is divided into three books, and covers the period between the council of Clermont and 1127, and the author only gives details of events which he himself had witnessed. It was used by William of Tyre. Fulcher died after 1127, probably at Jerusalem. He has been confused with Foucher of Mongervillier (d. 1171), abbot of St-Père-en-Vallée at Chartres, and also with another person of the same name who distinguished himself at the siege of Antioch in 1098.

The *Historia*, but in an incomplete form, was first published by J. Bongars in the *Gesta Dei per Francos* (Hanover, 1611). The best edition is in tome iii. of the *Recueil des historiens des croisades, Historiens occidentaux* (Paris, 1866); and there is a French translation in tome xxiv. of Guizot's *Collection des mémoires relatifs à l'histoire de France* (Paris, 1823-1835).

See H. von Sybel, *Geschichte des ersten Kreuzzuges* (Leipzig, 1881); and A. Molinier, *Les Sources de l'histoire de France*, tome ii. (Paris, 1902).

FULDA, a town and episcopal see of Germany, in the Prussian province of Hesse-Nassau, between the Rhön and the Vogel-Gebirge, 69 m. N.E. from Frankfurt-on-Main on the railway to Bebra. Although irregularly built the town is pleasantly situated, and contains two fine squares, on one of which stands a fine statue of St Boniface. The present cathedral was built at the beginning of the 18th century on the model of St Peter's at Rome, but it has an ancient crypt, which contains the bones of St Boniface and was restored in 1802. Opposite the cathedral is the former monastery of St Michael, now the episcopal palace. The Michaelskirche, attached to it, is a small round church built, in imitation of the Holy Sepulchre, in 822 and restored in 1853. Of other buildings may be mentioned the Library, with upwards of 80,000 printed books and many valuable MSS., the stately palace with its gardens and orangery, the former Benedictine nunnery (founded 1625, and now used as a seminary), and the Minorite friary (1238) now used as a furniture warehouse. Among the secular buildings are the fine *Schloss*, the *Bibliothek*, the town hall and the post office. There are several schools, a hospital founded in the 13th century, and some new artillery barracks. Many industries are carried on in Fulda. These include weaving and dyeing, the manufacture of linen, plush and other textiles and brewing. There are also railway works in the town. A large trade is done in cattle and grain, many markets being held here. Fine views are obtained from several hills in the neighbourhood, among these being the Frauenberg, the Petersberg and the Kalvarienberg.

Fulda owes its existence to its famous abbey. It became a town in 1208, and during the middle ages there were many struggles between the abbots and the townsfolk. During the Peasants' War it was captured by the rebels and during the Seven Years' War by the Hanoverians. It came finally into the possession of Prussia in 1866. From 1734 to 1804 Fulda was the seat of a university, and latterly many assemblies of German bishops have been held in the town.

The great Benedictine abbey of Fulda occupies the place in the ecclesiastical history of Germany which Monte Cassino holds in Italy, St Gall in South Germany, Corvey in Saxony, Tours in France and Iona in Scotland. Founded in 744 at the instigation of St Boniface by his pupil Sturm, who was the first abbot, it became the centre of a great missionary work. It was liberally endowed with land by the princes of the Carolingian house and others, and soon became one of the most famous and wealthy establishments of its kind. About 968 the pope declared that

its abbot was primate of all the abbots in Germany and Gaul, and later he became a prince of the Empire. Fulda was specially famous for its school, which was the centre of the theological learning of the early middle ages. Among the teachers here were Alcuin, Hrabanus Maurus, who was abbot from 822 to 842, and Walafrid Strabo. Early in the 10th century the monastery was reformed by introducing monks from Scotland, who were responsible for restoring in its old strictness the Benedictine rule. Later the abbey lost some of its lands and also its high position, and some time before the Reformation the days of its glory were over. Johann von Henneberg, who was abbot from 1529 to 1541, showed some sympathy with the teaching of the reformers, but the Counter-Reformation made great progress here under Abbot Balthasar von Dernbach. Gustavus Adolphus gave the abbey as a principality to William, landgrave of Hesse, but William's rule only lasted for ten years. In 1752 the abbot was raised to the rank of a bishop, and Fulda ranked as a prince-bishopric. This was secularized in 1802, and in quick succession it belonged to the prince of Orange, the king of France and the grand-duchy of Frankfurt. In 1816 the greater part of the principality was ceded by Prussia to Hesse-Cassel, a smaller portion being united with Bavaria. Sharing the fate of Hesse-Cassel, this larger portion was annexed by Prussia in 1866. In 1829 a new bishopric was founded at Fulda.

For the town see A. Hartmann, *Zeitgeschichte von Fulda* (Fulda, 1895); J. Schneider, *Führer durch die Stadt Fulda* (Fulda, 1899); and *Chronik von Fulda und dessen Umgebungen* (1839). For the history of the abbey see Gegenbaur, *Das Kloster Fulda im Karolinger Zeitalter* (Fulda, 1871-1874); Arndt, *Geschichte des Hochstifts Fulda* (Fulda, 1860); and the *Fuldaer Geschichtsblätter* (1902 fol.).

FULGENTIUS, **FABIUS PLACIANUS**, Latin grammarian, a native of Africa, flourished in the first half of the 6th (or the last part of the 5th) century A.D. He is to be distinguished from Fulgentius, bishop of Ruspe (468-533), to whom he was probably related, and also from the bishop's pupil and biographer, Fulgentius Ferrandus. Four extant works are attributed to him. (1) *Mythologiarum libri iii.*, dedicated to a certain Catus, a presbyter of Carthage, containing 75 myths briefly told, and then explained in the mystical and allegorical manner of the Stoics and Neoplatonists. For this purpose the author generally invokes the aid of etymologies which, borrowed from the philosophers, are highly absurd. As a Christian, Fulgentius sometimes (but less frequently than might have been expected) quotes the Bible by the side of the philosophers, to give a Christian colouring to the moral lesson. (2) *Expositio Vergilianae continentiae* (*continentia* = contents), a sort of appendix to (1), dedicated to Catus. The poet himself appears to the author and explains the twelve books of the *Aeneid* as a picture of human life. The three words *arma* (= virtue), *vir* (= sapientia); *primus* (= princeps) in the first line represent respectively *substantia corporalis, sensualis, ornans*. Book i. symbolizes the birth and early childhood of man (the shipwreck of Aeneas denotes the peril of birth), book vi. the plunge into the depths of wisdom. (3) *Expositio sermonum antiquorum*, explanations of 63 rare and obsolete words, supported by quotations (sometimes from authors and works that never existed). It is much inferior to the similar work of Nonius, with which it is often edited. (4) *Liber absque litteris de acatibus mundi et hominis*. In the MS. heading of this work, the name of the author is given as Fabius Claudius Gordianus Fulgentius (Claudius is the name of the father, and Gordianus that of the grandfather of the bishop, to whom some attribute the work). The title *Absque litteris* indicates that one letter of the alphabet is wholly omitted in each successive book (A in bk. i., B in bk. ii.). Only 14 books are preserved. The matter is chiefly taken from sacred history. In addition to these, Fulgentius speaks of early poetical attempts after the manner of Anacreon, and of a work called *Physiologus*, dealing with medical questions, and including a discussion of the mystical signification of the numbers 7 and 9. Fulgentius is a representative of the so-called late African style, taking for his models Apuleius, Tertullian and Martianus Capella. His language is bombastic, affected and incorrect, while the lengthy and elaborate periods make it difficult to understand his meaning.

See the edition of the four works by R. Helm (1898, Teubner series); also M. Zink, *Der Mytholog. Fulgentius* (1867); E. Jungmann, "De Fulgentii aetate et scriptis," in *Acta Societatis Philologicae Lipsiensis*, i. (1871); A. Ebert, *Allgemeine Geschichte der Lit. des Mittelalters*, i.; article "Fulgentius," by C. F. Bähr in Ersch and Gruber's *Allgemeine Encyclopädie*; Teufel-Schwabe, *History of Roman Literature* (Eng. trans.).

FULGINIAE (mod. *Foligno*), an ancient town of Umbria, Italy, on the later line of the Via Flaminia, 15 m. S. of Nuceria. It appears to have been of comparatively late origin, inasmuch as it had no city walls, but, in imperial times especially, owing to its position on the new line of the Via Flaminia, it must have increased in importance as being the point of departure of roads to Perugia and to Picenum over the pass of Plestia. It appears to have had an amphitheatre, and three bridges over the Topino are attributed to the Roman period. Three miles to the N. lies the independent community of Forum Flaminii, the site of which is marked by the church of S. Giovanni Profamma, at or near which the newer line of the Via Flaminia rejoined the older. It was no doubt founded by the builder of the road, C. Flaminius, consul in 220 B.C. (See **FOLIGNO** and **FLAMINIA, VIA**). (T. As.)

FULGURITE (from Lat. *fulgur*, lightning), in petrology, the name given to rocks which have been fused on the surface by lightning, and to the characteristic holes in rocks formed by the same agency. When lightning strikes the naked surfaces of rocks, the sudden rise of temperature may produce a certain amount of fusion, especially when the rocks are dry and the electricity is not readily conducted away. Instances of this have been observed on Ararat and on several mountains in the Alps, Pyrenees, &c. A thin glassy crust, resembling a coat of varnish, is formed; its thickness is usually not more than one-eighth of an inch, and it may be colourless, white or yellow. When examined under the microscope, it usually shows no crystallization, and contains minute bubbles due to the expansion of air or other gases in the fused pellicle. Occasionally small microliths may appear, but this is uncommon because so thin a film would cool with extreme rapidity. The minerals of the rock beneath are in some cases partly fused, but the more refractory often appear quite unaffected. The glass has arisen from the melting of the most fusible ingredients alone.

Another type of fulgurite is commonest in dry sands and takes the shape of vertical tubes which may be nearly half an inch in diameter. Generally they are elliptical in cross section, or flattened by the pressure exerted by the surrounding sand on the fulgurite at a time when it was still very hot and plastic. These tubes are often vertical and may run downwards for several feet through the sand, branching and lessening as they descend. Tubular perforations in hard rocks have been noted also, but these are short and probably follow original cracks. The glassy material contains grains of sand and many small round or elliptical cavities, the long axes of which are radial. Minerals like felspar and mica are fused more readily than quartz, but analysis shows that some fulgurite glasses are very rich in silica, which perhaps was dissolved in the glass rather than simply fused. The central cavity of the tube and the bubbles in its walls point to the expansion of the gases (air, water, &c.) in the sand by sudden and extreme heating. Very fine threads of glass project from the surface of the tube as if fused droplets had been projected outwards with considerable force. Where the quartz grains have been greatly heated but not melted they become white and semi-opaque, but where they are in contact with the glass they usually show partial solution. Occasionally crystallization has begun before the glass solidified, and small microliths, the nature of which is undeterminable, occur in streams and wisps in the clear hyaline matrix. (J. S. F.)

FULHAM, a western metropolitan borough of London, England, bounded N.W. by Hammersmith, N.E. by Kensington, E. by Chelsea, and S.E., S. and S.W. by the river Thames. Pop. (1901) 137,289. The principal thoroughfares are Fulham Palace Road running S. from Hammersmith, Fulham Road and King's Road, W. from Chelsea, converging and leading to

Putney Bridge over the Thames; North End Road between Hammersmith and Fulham Roads; Lillie Road between South Kensington and Fulham Palace Road; and Wandsworth Bridge Road leading S. from New King's Road to Wandsworth Bridge. In the north Fulham includes the residential district known as West Kensington, and farther south that of Walham Green. The manor house or palace of the bishops of London stands in grounds, beautifully planted and surrounded by a moat, believed to be a Danish work, near the river west of Putney Bridge. Its oldest portion is the picturesque western quadrangle, built by Bishop Fitzjames (1506-1522). The parish church of All Saints, between the bridge and the grounds, was erected in 1881 from designs by Sir Arthur Blomfield. The fine old monuments from the former building, dating from the 16th to the 18th centuries, are mostly preserved, and in the churchyard are the memorials of several bishops of London and of Theodore Hook (1841). The public recreation grounds include the embankment and gardens between the river and the palace grounds, and there are also two well-known enclosures used for sports within the borough. Of these Hurlingham Park is the headquarters of the Hurlingham Polo Club and a fashionable resort; and Queen's Club, West Kensington, has tennis and other courts for the use of members, and is also the scene of important football matches, and of the athletic meetings between Oxford and Cambridge Universities, and those between the English and American Universities held in England. In Scagrove Road is the Western fever hospital. The parliamentary borough of Fulham returns one member. The borough council consists of a mayor, 6 aldermen and 36 councillors. Area, 1703.5 acres.

Fulham, or in its earliest form *Fullanham*, is uncertainly stated to signify "the place" either "of fowls" or "of dirt." The manor is said to have been given to Bishop Erkenwald about the year 691 for himself and his successors in the see of London, and Holinshed relates that the Bishop of London was lodging in his manor place in 1141 when Geoffrey de Mandeville, riding out from the Tower of London, took him prisoner. At the Commonwealth the manor was temporarily out of the bishops' hands, being sold to Colonel Edmund Harvey. There is no record of the first erection of a parish church, but the first known rector was appointed in 1242, and a church probably existed a century before this. The earliest part of the church demolished in 1881, however, did not date farther back than the 15th century. In 879 Danish invaders, sailing up the Thames, wintered at Fulham and Hammersmith. Near the former wooden Putney Bridge, built in 1729 and replaced in 1886, the earl of Essex threw a bridge of boats across the river in 1642 in order to march his army in pursuit of Charles I., who thereupon fell back on Oxford. Margrave Road recalls the existence of Bradenburg House, a riverside mansion built by Sir Nicholas Crispe in the time of Charles I., used as the headquarters of General Fairfax in 1647 during the civil wars, and occupied in 1792 by the margrave of Bradenburg-Anspach and Bayreuth and his wife, and in 1820 by Caroline, consort of George IV.

FULK, king of Jerusalem (b. 1092), was the son of Fulk IV., count of Anjou, and his wife Bertrada (who ultimately deserted her husband and became the mistress of Philip I. of France). He became count of Anjou in 1109, and considerably added to the prestige of his house. In particular he showed himself a doughty opponent to Henry I. of England, against whom he continually supported Louis VI. of France, until in 1127 Henry won him over by betrothing his daughter Matilda to Fulk's son Geoffrey Plantagenet. Already in 1120 Fulk had visited the Holy Land, and become a close friend of the Templars. On his return he assigned to the order of the Templars an annual subsidy, while he also maintained two knights in the Holy Land for a year. In 1128 he was preparing to return to the East, when he received an embassy from Baldwin II., king of Jerusalem, who had no male heir to succeed him, offering his daughter Melisinda in marriage, with the right of eventual succession to the kingdom. Fulk readily accepted the offer; and in 1129 he came and was married to Melisinda, receiving the towns of

Acre and Tyre as her dower. In 1131, at the age of thirty-nine, he became king of Jerusalem. His reign is not marked by any considerable events: the kingdom which had reached its zenith under Baldwin II., and did not begin to decline till the capture of Edessa in the reign of Baldwin III., was quietly prosperous under his rule. In the beginning of his reign he had to act as regent of Antioch, and to provide a husband, Raymond of Poitou, for the infant heiress Constance. But the great problem with which he had to deal was the progress of the atabeg Zengi of Mosul. In 1137 he was beaten near Barin, and escaping into the fort was surrounded and forced to capitulate. A little later, however, he greatly improved his position by strengthening his alliance with the vizier of Damascus, who also had to fear the progress of Zengi (1140); and in this way he was able to capture the fort of Banias, to the N. of Lake Tiberias. Fulk also strengthened the kingdom on the south; while his butler, Paganus, planted the fortress of Krak to the south of the Dead Sea, and helped to give the kingdom an access towards the Red Sea, he himself constructed Blanche Garde and other forts on the S.W. to overawe the garrison of Ascalon, which was still held by the Mahomedans, and to clear the road towards Egypt. Twice in Fulk's reign the eastern emperor, John Comnenus, appeared in northern Syria (1137 and 1142); but his coming did not affect the king, who was able to decline politely a visit which the emperor proposed to make to Jerusalem. In 1143 he died, leaving two sons, who both became kings, as Baldwin III. and Amalric I.

Fulk continued the tradition of good statesmanship and sound churchmanship which Baldwin I. and Baldwin II. had begun. William of Tyre speaks of him as a fine soldier, an able politician, and a good son of the church, and only blames him for partiality to his friends, and a forgetfulness of names and faces, which placed him at a disadvantage and made him too dependent on his immediate intimates. Little, perhaps, need be made of these censures: the real fault of Fulk was his neglect to envisage the needs of the northern principalities, and to head a combined resistance to the rising power of Zengi of Mosul.

His reign in Jerusalem is narrated by R. Röhrich (*Geschichte des Königreichs Jerusalem*, Innsbruck, 1898), and has been made the subject of a monograph by C. Dodu (*De Fulconis Hierosolymitani regno*, Paris, 1894). (E. Br.)

FULK (d. 900), archbishop of Reims, and partisan of Charles the Simple in his struggle with Odo, count of Paris, was elected to the see as archbishop in 883 upon the death of Hincmar. In 887 he was engaged in a struggle with the Normans who invaded his territories. Upon the deposition of Charles the Fat he sided with Charles the Simple in his contest for the West Frankish dominions against Count Odo of Paris, and crowned him king in his own metropolitan church at Reims after most of the nobles had gone over to Odo (893). Upon the death of Odo he succeeded in having Charles recognized as king by a majority of the West Frankish nobility. In 892 he obtained special privileges for his province from Pope Formosus, who promised that thereafter, when the archbishopric became vacant, the revenues should not be enjoyed by anyone while the vacancy existed, but should be reserved for the new incumbent, provided the election took place within the canonical limit of three months. From 898 until his death he held the office of chancellor, which for some time afterwards was regularly filled by the archbishop of Reims. In his efforts to keep the wealthy abbeys and benefices of the church out of the hands of the nobles, he incurred the hatred of Baldwin, count of Flanders, who secured his assassination on the 17th of June 900, a crime which the weak Carolingian monarch left unpunished.

Fulk left some letters, which are collected in Migne, *Patrologia Latina*, vol. cxxxi. 11-14.

FULKE, WILLIAM (1538-1589), Puritan divine, was born in London and educated at Cambridge. After studying law for six years, he became a fellow at St John's College, Cambridge, in 1564. He took a leading part in the "vestiarian" controversy, and persuaded the college to discard the surplice. In consequence

he was expelled from St. John's for a time, but in 1567 he became Hebrew lecturer and preacher there. After standing unsuccessfully for the headship of the college in 1569, he became chaplain to the earl of Leicester, and received from him the livings of Warley, in Essex, and Dennington in Suffolk. In 1578 he was elected master of Pembroke Hall, Cambridge. As a Puritan controversialist he was remarkably active; in 1580 the bishop of Ely appointed him to defend puritanism against the Roman Catholics, Thomas Watson, ex-bishop of Lincoln (1513-1584), and John Feckenham, formerly abbot of Westminster, and in 1581 he was one of the disputants with the Jesuit, Edmund Campion, while in 1582 he was among the clergy selected by the privy council to argue against any papist. His numerous polemical writings include *A Defense of the sincere true Translations of the holis Scriptures into the English tong* (London, 1583), and confutations of Thomas Stapleton (1535-1598), Cardinal Allen and other Roman Catholic controversialists.

FULK NERRA (c. 970-1040), count of Anjou, eldest son of Count Geoffrey I., "Grisegonelle" (Grey Tunic) and Adela of Vermandois, was born about 970 and succeeded his father in the countship of Anjou on the 21st of July 987. He was successful in repelling the attacks of the count of Rennes and laying the foundations of the conquest of Touraine (see ANJOU). In this connexion he built a great number of strong castles, which has led in modern times to his being called "the great builder." He also founded several religious houses, among them the abbeys of Beaulieu, near Loches (c. 1007), of Saint-Nicholas at Angers (1020) and of Ronceray at Angers (1028), and, in order to expiate his crimes of violence, made three pilgrimages to the Holy Land (in 1002-1003, c. 1008 and in 1039). On his return from the third of these journeys he died at Metz in Lorraine on the 21st of June 1040. By his first marriage, with Elizabeth, daughter of Bouchard le Vénérable, count of Vendôme, he had a daughter, Adela, who married Boon of Nevers and transmitted to her children the countship of Vendôme. Elizabeth having died in 1000, Fulk married Hildegarde of Lorraine, by whom he had a son, Geoffrey Martel (q.v.), and a daughter Ermengarde, who married Geoffrey, count of Gâtinais, and was the mother of Geoffrey "le Barbu" (the Bearded) and of Fulk "le Réchin" (see ANJOU).

See Louis Halphen, *Le Comté d'Anjou au XI^e siècle* (Paris, 1906). The biography of Fulk Nerra by Alexandre de Salice, *Histoire de Fouques Nerra* (Angers, 1874) is confused and uncritical. A very summary biography is given by Célestin Port, *Dictionnaire historique, géographique et biographique de Maine-et-Loire* (3 vols., Paris-Angers, 1874-1878), vol. ii. pp. 189-192, and there is also a sketch in Kate Norgate, *England under the Angevin Kings* (2 vols., London, 1887), vol. i. ch. iii. (L. H.*)

FÜLLEBORN, GEORG GUSTAV (1769-1803), German philosopher, philologist and miscellaneous writer, was born at Glogau, Silesia, on the 2nd of March 1769, and died at Breslau on the 6th of February 1803. He was educated at the University of Halle, and was made doctor of philosophy in recognition of his thesis *De Xenophane, Zenone et Gorgia*. He took diaconal orders in 1791, but almost immediately became professor of classics at Breslau. His philosophical works include annotations to Garve's translation of the *Politics* of Aristotle (1799-1800), and a large share in the *Beiträge zur Geschichte der Philosophie* (published in twelve parts between 1791 and 1799), in which he collaborated with Forberg, Reinhold and Niethammer. In philology he wrote *Encyclopaedia philologica sine primae linguae Isaagogis in antiquorum studia* (1798; 2nd ed., 1805); *Kurze Theorie des lateinischen Stils* (1793); *Leitfaden der Rhetorik* (1802); and an annotated edition of the *Satires* of Persius. Under the pseudonym "Edelwald Justus" he published several collections of popular tales—*Bunte Blätter* (1795); *Kleine Schriften zur Unterhaltung* (1798); *Nebenstunden* (1799). After his death were published *Taschenbuch für Brunnengüsse* (1806) and *Kammlreden* (1807). He was a frequent contributor to the press, where his writings were very popular.

See Schummel, *Gedächtnisrede* (1803) and *Garve und Fülleborn; Meusel, Gelehrtes Teutschland*, vol. 2.

FULLER, ANDREW (1754-1815), English Baptist divine, was born on the 6th of February 1754, at Wicken in Cambridgeshire. In his boyhood and youth he worked on his father's farm. In his seventeenth year he became a member of the Baptist church at Sobam, and his gifts as an exhorter met with so much approval that, in the spring of 1775, he was called and ordained as pastor of that congregation. In 1782 he removed to Kettering in Northamptonshire, where he became friendly with some of the most eminent ministers of the denomination. Before leaving Sobam he had written the substance of a treatise in which he had sought to counteract the prevailing Baptist hyper-Calvinism which, "admitting nothing spiritually good to be the duty of the unregenerate, and nothing to be addressed to them in a way of exhortation excepting what related to external obedience," had long perplexed his own mind. This work he published, under the title *The Gospel worthy of all Acceptation*, soon after his settlement in Kettering; and although it immediately involved him in a somewhat bitter controversy which lasted for nearly twenty years, it was ultimately successful in considerably modifying the views prevalent among English dissenters. In 1793 he published a treatise, *The Calvinistic and Socinian systems examined and compared as to their moral tendency*, in which he rebutted the accusation of antinomianism levelled by the Socinians against those who over-emphasized the doctrines of free grace. This work, along with another against Deism, entitled *The Gospel its own Witness*, is regarded as the production on which his reputation as a theologian mainly rests. Fuller also published an admirable *Memoir of the Rev. Samuel Pearce*, of Birmingham, and a volume of *Expository Lectures in Genesis*, besides a considerable number of smaller pieces, chiefly sermons and pamphlets, which were issued in a collected form after his death. He was a man of forceful character, more prominent on the practical side of religion than on the devotional, and accordingly not pre-eminently successful in his local ministry. His great work was done in connexion with the Baptist Missionary Society, formed at Kettering in 1792, of which he was secretary until his death on the 7th of May 1815. Both Princeton and Yale, U.S.A., conferred on him the degree of D. D., but he never used it.

Several editions of his collected works have appeared, and a *Memoir*, principally compiled from his own papers, was published about a year after his decease by Dr Ryland, his most intimate friend and coadjutor in the affairs of the Baptist mission. There is also a biography by the Rev. J. W. Morris (1816); and his son prefixed a memoir to an edition of his chief works in Bohn's Standard Library (1852).

FULLER, GEORGE (1822-1884), American figure and portrait painter, was born at Deerfield, Massachusetts, in 1822. At the age of twenty he entered the studio of the sculptor H. K. Brown, at Albany, New York, where he drew from the cast and modelled heads. Having attained some proficiency he went about the country painting portraits, settling at length in Boston, where he studied the works of the earlier Americans, Stuart, Copley and Allston. After three years in that city, and twelve in New York, where in 1857 he was elected a member of the National Academy of Design, he went to Europe for a brief visit and for study. During all this time his work had received little recognition and practically no financial encouragement, and on his return he settled on the family farm at Deerfield, where he continued to work in his own way with no thought of the outside world. In 1876, however, he was forced by pressing needs to dispose of his work, and he sent some pictures to a dealer in Boston, where he met with immediate success, financial and artistic, and for the remaining eight years of his life he never lacked patrons. He died in Boston on the 21st of March 1884. He was a poetic painter, and a dreamer of delicate fancies and quaint, intangible phases of nature, his canvases being usually enveloped in a brown mist that renders the outlines vague. Among his noteworthy canvases are: "The Turkey Pasture," "Romany Girl," "And she was a Witch," "Nydia," "Winifred Dysart" and "The Quadroom."

FULLER, MARGARET, MARCHESS OSSLI (1810-1850), American authoress, eldest child of Timothy Fuller (1778-1835),

a lawyer and politician of some eminence, was born at Cambridgeport, Massachusetts, on the 23rd of May 1810. Her education was conducted by her father, who, she states, made the mistake of thinking to "gain time by bringing forward the intellect as early as possible," the consequence being "a premature development of brain that made her a youthful prodigy by day, and by night a victim of spectral illusions, nightmare and somnambulism." At six years she began to read Latin, and at a very early age she had selected as her favourite authors Shakespeare, Cervantes and Molière. Soon the great amount of study exacted of her ceased to be a burden, and reading became a habit and a passion. Having made herself familiar with the masterpieces of French, Italian and Spanish literature, she in 1833 began the study of German, and within the year had read some of the masterpieces of Goethe, Körner, Novalis and Schiller.

After her father's death in 1835 she went to Boston to teach languages, and in 1837 she was chosen principal teacher in the Green Street school, Providence, Rhode Island, where she remained till 1839. From this year until 1844 she stayed at different places in the immediate neighbourhood of Boston, forming an intimate acquaintance with the colonists of Brook Farm, and numbering among her closest friends R. W. Emerson, Nathaniel Hawthorne and W. H. Channing. In 1839 she published a translation of Eckermann's *Conversations with Goethe*, which was followed in 1842 by a translation of the correspondence between Karoline von Günderode and Bettina von Arnim, entitled *Günderode*. Aided by R. W. Emerson and George Ripley, she in 1840 started *The Dial*, a poetical and philosophical magazine representing the opinions and aims of the New England Transcendentalists. This journal she continued to edit for two years, and while in Boston she also conducted conversation classes for ladies in which philosophical and social subjects were discussed with a somewhat over-accentuated earnestness. These meetings may be regarded as perhaps the beginning of the modern movement in behalf of women's rights. R. W. Emerson, who had met her as early as 1836, thus describes her appearance: "She was then twenty-six years old. She had a face and frame that would indicate fulness and tenacity of life. She was rather under the middle height, her complexion was fair, with strong fair hair. She was then, as always, carefully and becomingly dressed, and of ladylike self-possession. For the rest her appearance had nothing prepossessing. Her extreme plainness, a trick of incessantly opening and shutting her eyelids, the nasal tone of her voice, all repelled; and I said to myself we shall never get far." On better acquaintance this unprepossessing exterior seemed, however, to melt away, and her inordinate self-esteem to be lost in the depth and universality of her sympathy. She possessed an almost irresistible power of winning the intellectual and moral confidence of those with whom she came in contact, and "applied herself to her companion as the sponge applies itself to water." She obtained from each the best they had to give. It was indeed more as a conversationalist than as a writer that she earned the title of the Priestess of Transcendentalism. It was her intimate friends who admired her most. Smart and pungent though she is as a writer, the apparent originality of her views depends more on eccentricity than either intellectual depth or imaginative vigour. In 1844 she removed to New York at the desire of Horace Greeley to write literary criticism for *The Tribune*, and in 1846 she published a selection from her articles on contemporary authors in Europe and America, under the title *Papers on Literature and Art*. The same year she paid a visit to Europe, passing some time in England and France, and finally taking up her residence in Italy. There she was married in December 1847 to the marquis Giovanni Angelo Ossoli, a friend of Mazzini. During 1848-1849 she was present with her husband in Rome, and when the city was besieged she, at the request of Mazzini, took charge of one of the two hospitals while her husband fought on the walls. In May 1850, along with her husband and infant son, she embarked at Leghorn for America, but when they had all but reached their destination the vessel was wrecked on Fire

Island beach on the 16th of June, and the *Ossolis* were among the passengers who perished.

Life Without and Life Within (Boston, 1860) is a collection of essays, poems, &c., supplementary to her *Collected Works*, printed in 1835. See the *Autobiography of Margaret Fuller Ossoli*, with additional memoirs by J. F. Clarke, R. W. Emerson and W. H. Channing (2 vols., Boston, 1832); also *Margaret Fuller (Marchesa Ossoli)*, by Julia Ward Howe (1883), in the "Eminent Women" series; *Margaret Fuller Ossoli* (Boston, 1884), by Thomas Wentworth Higginson in the "American Men of Letters" series, which is based largely on unedited material; and *The Love Letters of Margaret Fuller, 1845-1846* (London and New York, 1903), with an introduction by Julia Ward Howe.

FULLER, MELVILLE WESTON (1833-1910), American jurist, chief justice of the Supreme Court of the United States, was born at Augusta, Maine, on the 11th of February 1833. After graduating at Bowdoin College in 1853 he spent a year at the Harvard Law School, and in 1855 began the practice of law at Augusta, where he was an associate-editor of a Democratic paper, *The Age*, and served in the city council and as city attorney. In 1856 he removed to Chicago, Illinois, where he continued to practise until 1888, rising to a high position at the bar of the Northwest. For some years he was active in Democratic politics, being a member of the Illinois Constitutional Convention in 1861 and of the State House of Representatives from 1863 to 1865. He was a delegate to various National conventions of his party, and in that of 1876 placed Thomas A. Hendricks in nomination for the presidency. In 1888, by President Cleveland's appointment, he succeeded Morrison R. Waite as chief-justice of the Supreme Court of the United States. In 1899 he was appointed by President McKinley a member of the arbitration commission at Paris to settle the Venezuela-British Guiana boundary dispute.

FULLER, THOMAS (1608-1661), English divine and historian, eldest son of Thomas Fuller, rector of Aldwinckle St Peter's, Northamptonshire, was born at his father's rectory and was baptized on the 10th of June 1608. Dr John Davenant, bishop of Salisbury, was his uncle and godfather. According to Aubrey, Fuller was "a boy of pregnant wit." At thirteen he was admitted to Queens' College, Cambridge, then presided over by Dr John Davenant. His cousin, Edward Davenant, was a tutor in the same college. He was apt and quick in study; and in Lent 1624-1625 he became B.A. and in July 1628 M.A. Being overlooked in an election of fellows of his college, he was removed by Bishop Davenant to Sidney Sussex College, November 1628. In 1630 he received from Corpus Christi College the curacy of St Benet's, Cambridge.

Fuller's quaint and humorous oratory soon attracted attention. He published in 1631 a poem on the subject of David and Bathsheba, entitled *David's Hainous Sinne, Heartie Repentance, Heavie Punishment*. In June of the same year his uncle gave him a prebend in Salisbury, where his father, who died in the following year, held a canonry. The rectory of Broadwindsor, Dorsetshire, then in the diocese of Bristol, was his next preferment (1634), and on the 11th of June 1635 he proceeded B.D. At Broadwindsor he compiled *The Historie of the Holy Warre* (1639), a history of the crusades, and *The Holy State and the Prophane State* (1642). This work describes the holy state as existing in the family and in public life, gives rules of conduct, model "characters" for the various professions and profane biographies. It was perhaps the most popular of all his writings. He was in 1640 elected proctor for Bristol in the memorable convocation of Canterbury, which assembled with the Short Parliament. On the sudden dissolution of the latter he joined those who urged that convocation should likewise dissolve as usual. That opinion was overruled; and the assembly continued to sit by virtue of a royal writ. Fuller has left in his *Church History* a valuable account of the proceedings of this synod, for sitting in which he was fined £200, which, however, was never exacted. His first published volume of sermons appeared in 1640 under the title of *Joseph's party-coloured Coat*, which contains many of his quaint utterances and odd conceits. His grosser mannerisms of style, derived from the divines of the former

generation, disappeared for the most part in his subsequent discourses.

About 1640 he had married Eleanor, daughter of Hugh Grove of Chisenbury, Wiltshire. She died in 1641. Their eldest child, John, baptized at Broadwindsor by his father, 6th June 1641, was afterwards of Sidney Sussex College, edited the *Worthies of England*, 1662, and became rector of Great Wakering, Essex, where he died in 1687.

At Broadwindsor, early in the year 1641, Thomas Fuller, his curate Henry Sanders, the church wardens, and others, nine persons altogether, certified that their parish, represented by 242 grown-up male persons, had taken the Protestation ordered by the speaker of the Long Parliament. Fuller was not formally dispossessed of his living and prebend on the triumph of the Presbyterian party, but he relinquished both preferments about this time. For a short time he preached with success at the Inns of Court, and thence removed, at the invitation of the master of the Savoy (Dr Balcanqual) and the brotherhood of that foundation, to be lecturer at their chapel of St Mary Savoy. Some of the best discourses of the witty preacher were delivered at the Savoy to audiences which extended into the chapel-yard. In one he set forth with searching and truthful minuteness the hindrances to peace, and urged the signing of petitions to the king at Oxford, and to the parliament, to continue their care in advancing an accommodation. In his *Appeal of Injured Innocences* Fuller says that he was once deputed to carry a petition to the king at Oxford. This has been identified with a petition entrusted to Sir Edward Wardour, clerk of the pells, Dr Dukeson, "Dr Fuller," and four or five others from the city of Westminster and the parishes contiguous to the Savoy. A pass was granted by the House of Lords, on the 2nd of January 1643, for an equipage of two coaches, four or six horses and eight or ten attendants. On the arrival of the deputation at Uxbridge, on the 4th of January, officers of the Parliamentary army stopped the coaches and searched the gentlemen; and they found upon the latter "two scandalous books arraigning the proceedings of the House," and letters with ciphers to Lord Viscount Falkland and the Lord Spencer. Ultimately a joint order of both Houses remanded the party; and Fuller and his friends suffered a brief imprisonment. The Westminster Petition, notwithstanding, reached the king's hands; and it was published with the royal reply (see J. E. Bailey, *Life of Thomas Fuller*, pp. 245 et seq.). When it was expected, three months later, that a favourable result would attend the negotiations at Oxford, Fuller preached a sermon at Westminster Abbey, on the 27th of March 1643, on the anniversary of Charles I's accession, on the text, "Yea, let him take all, so my Lord the King return in peace." On Wednesday, the 26th of July, he preached on church reformation, satirizing the religious reformers, and maintaining that only the Supreme Power could initiate reforms.

He was now obliged to leave London, and in August 1643 he joined the king at Oxford. He lived in a hired chamber at Lincoln College for 17 weeks. Thence he put forth a witty and effective reply to John Saltmarsh, who had attacked his views on ecclesiastical reform. Fuller subsequently published by royal request a sermon preached on the 10th of May 1644, at St Mary's, Oxford, before the king and Prince Charles, called *Jacob's Vow*.

The spirit of Fuller's preaching, always characterized by calmness and moderation, gave offence to the high royalists, who charged him with lukewarmness in their cause. To silence unjust censures he became chaplain to the regiment of Sir Ralph Hopton. For the first five years of the war, as he said, when excusing the non-appearance of his *Church History*, "I had little list or leisure to write, fearing to be made a history, and shifting daily for my safety. All that time I could not live to study, who did only study to live." After the defeat of Hopton at Cheriton Down, Fuller retreated to Basing House. He took an active part in its defence, and his life with the troops caused him to be afterwards regarded as one of "the great cavalier parsons." In his marches with his regiment round about Oxford and in the west, he devoted much time to the collection of details,

from churches, old buildings, and the conversation of ancient gossips, for his *Church-History and Worthies of England*. He compiled in 1645 a small volume of prayers and meditations,—the *Good Thoughts in Bad Times*,—which, set up and printed in the besieged city of Exeter, whither he had retired, was called by himself “the first fruits of Exeter press.” It was inscribed to Lady Dalkeith, governess to the infant princess, Henrietta Anne (b. 1644), to whose household he was attached as chaplain. The corporation gave him the Bodleian lectureship on the 21st of March 1645/6, and he held it until the 17th of June following, soon after the surrender of the city to the parliament. *The Fear of losing the Old Light* (1646) was his farewell discourse to his Exeter friends. Under the Articles of Surrender Fuller made his composition with the government at London, his “delinquency” being that he had been present in the king’s garrisons. In *Andronicus, or the Unfortunate Politician* (1646), partly authentic and partly fictitious, he satirized the leaders of the Revolution; and for the comfort of sufferers by the war he issued (1647) a second devotional manual, entitled *Good Thoughts in Worse Times*, abounding in fervent aspirations, and drawing moral lessons in beautiful language out of the events of his life or the circumstances of the time. In grief over his losses, which included his library and manuscripts (his “upper and nether millstone”), and over the calamities of the country, he wrote his work on the *Cause and Cure of a Wounded Conscience* (1647). It was prepared at Boughton House in his native county, where he and his son were entertained by Edward Lord Montagu, who had been one of his contemporaries at the university and had taken the side of the parliament.

For the next few years of his life Fuller was mainly dependent upon his dealings with booksellers, of whom he asserted that none had ever lost by him. He made considerable progress in an English translation from the MS. of the *Annales* of his friend Archbishop Ussher. Amongst his benefactors it is curious to find Sir John Danvers of Chelsea, the regicide. Fuller in 1647 began to preach at St Clement’s, Eastcheap, and elsewhere in the capacity of lecturer. While at St Clement’s he was suspended; but speedily recovering his freedom, he preached wherever he was invited. At Chelsea, where also he occasionally officiated, he covertly preached a sermon on the death of Charles I., but he did not break with his Roundhead patrons. James Hay, 2nd earl of Carlisle, made him his chaplain, and presented him in 1648 or 1649 to the curacy of Waltham Abbey. His possession of the living was in jeopardy on the appointment of Cromwell’s “Triers”; but he evaded their inquisitorial questions by his ready wit. He was not disturbed at Waltham in 1655, when the Protector’s edict prohibited the adherents of the late king from preaching. Lionel, 3rd earl of Middlesex, who lived at Copt Hall, near Waltham, gave him what remained of the books of the lord treasurer his father; and through the good offices of the marchioness of Hertford, part of his own pillaged library was restored to him. Fuller was thus able to prosecute his literary labours, producing successively his descriptive geography of the Holy Land, called *A Pisgah-Sight of Palestine* (1650), and his *Church-History of Britain* (1653), from the birth of Jesus Christ until the year 1648. With the *Church-History* was printed *The History of the University of Cambridge since the Conquest and The History of Waltham Abbey*. These works were furthered in no slight degree by his connexion with Sion College, London, where he had a chamber, as well for the convenience of the press as of his city lectureships. The *Church-History* was angrily attacked by Dr P. Heylyn, who, in the spirit of High-Churchmanship, wished, as he said, to vindicate the truth, the church and the injured clergy. About 1652 Fuller married his second wife, Mary Roper, youngest sister of Thomas, Viscount Baltinglass, by whom he had several children. At the Oxford Act of 1657, Robert South, who was *Terrae filius*, lampooned Fuller, whom he described in this *Oratio* as living in London, ever scribbling and each year bringing forth new *folia* like a tree. At length, continues South, the *Church-History* came forth with its 166 dedications to wealthy and noble friends; and with this huge volume under one arm, and his wife (said to

be little of stature) on the other, he ran up and down the streets of London, seeking at the houses of his patrons’ invitations to dinner, to be repaid by his dull jests at table.

His last and best patron was George Berkeley, 1st Earl Berkeley (1628–1698), of Cranford House, Middlesex, whose chaplain he was, and who gave him Cranford rectory (1658). To this nobleman Fuller’s reply to Heylyn’s *Examen Historicum*, called *The Appeal of Injured Innocence* (1659), was inscribed. At the end of the *Appeal* is an epistle “to my loving friend Dr Peter Heylyn,” conceived in the admirable Christian spirit which characterized all Fuller’s dealings with controversialists. “Why should Peter,” he asked, “fall out with Thomas, both being disciples to the same Lord and Master? I assure you, sir, whatever you conceive to the contrary, I am cordial to the cause of the English Church, and my hoary hairs will go down to the grave in sorrow for her sufferings.”

In *An Alarm to the Counties of England and Wales* (1660) Fuller argued for a free and full parliament—free from force, as he expressed it, as well as from abjurations or previous engagements. *Misc Contemplations in Better Times* (1660), dedicated to Lady Monk, tendered advice in the spirit of its motto, “Let your moderation be known to all men: the Lord is at hand.” There is good reason to suppose that Fuller was at the Hague immediately before the Restoration, in the retinue of Lord Berkeley, one of the commissioners of the House of Lords, whose last service to his friend was to interest himself in obtaining him a bishopric. *A Panegyric to His Majesty on his Happy Return* was the last of Fuller’s verse-efforts. On the 2nd of August, by royal letters, he was admitted D.D. at Cambridge. He resumed his lectures at the Savoy, where Samuel Pepys heard him preach; but he preferred his conversation or his books to his sermons. Fuller’s last promotion was that of chaplain in extraordinary to Charles II. In the summer of 1661 he visited the west in connexion with the business of his prebend, which had been restored to him. On Sunday, the 12th of August, while preaching at the Savoy, he was seized with typhus fever, and died at his new lodgings in Covent Garden on the 16th of August. He was buried in Cranford church, where a mural tablet was afterwards set up on the north side of the chancel, with an epitaph which contains a conceit worthy of his own pen, to the effect that while he was endeavouring (viz. in *The Worthies*) to give immortality to others, he himself attained it.

Fuller’s wit and vivacious good-humour made him a favourite with men of both sides, and his sense of humour kept him from extremes. Probably Heylyn and South had some excuse for their attitude towards his very moderate politics. “By his particular temper and management,” said Echarid (*Hist. of England*, iii 71), “he weathered the late great storm with more success than many other great men.” He was known as “a perfect walking library.” The strength of his memory was proverbial, and some amusing anecdotes are connected with it.

His writings were the product of a highly original mind. He had a fertile imagination and a happy faculty of illustration. Antithetic and axiomatic sentences abound in his pages, embodying literally the wisdom of the many in the wit of one. He was “quaint,” and something more. “Wit,” said Coleridge, in a well-known eulogy, “was the stuff and substance of Fuller’s intellect. It was the element, the earthen base, the material which he worked in; and this very circumstance has defrauded him of his due praise for the practical wisdom of the thoughts, for the beauty and variety of the truths, into which he shaped the stuff. Fuller was incomparably the most sensible, the least prejudiced, great man of an age that boasted a galaxy of great men” (*Literary Remains*, vol. ii. (1836), pp. 389–390). This opinion was formed after the perusal of the *Church-History*. That work and *The History of the Worthies of England* are unquestionably Fuller’s greatest efforts. They embody the collections of an entire life; and since his day they have been the delight of many readers. *The Holy State* has taken rank amongst the best books of “characters.” Charles Lamb made some selections from Fuller, and had a profound admiration for the “golden works” of the “dear, fine, silly old angel.” Since

Lamb's time, mainly through the appreciative criticisms of S. T. Coleridge, Robert Southey and others, Fuller's works have received much attention.

There is an elaborate account of the life and writings of Fuller by William Oldys in the *Biographia Britannica*, vol. iii. (1750), based on Fuller's own works and the anonymous *Life of . . . Dr Thomas Fuller* (1661; reprinted in a volume of selections by A. L. J. Gosset, 1893). The completest account of him is *The Life of Thomas Fuller, with Notices of his Books, his Kinsmen and his Friends* (1874), by J. E. Bailey, who gives a detailed bibliography (pp. 713-762) of his works. *The Worthies of England* was reprinted by John Nichols (1811) and by P. A. Nuttall (1840). His *Collected Sermons* were edited by J. E. Bailey and W. E. A. Axon in 1891. Fuller's quaint wit lends itself to selection, and there are several modern volumes of extracts from his works.

FULLER, WILLIAM (1670-c. 1717), English impostor, was born at Milton in Kent on the 20th of September 1670. His paternity is doubtful, but he was related to the family of Herbert. After 1688 he served James II.'s queen, Mary of Modena, and the Jacobites, seeking at the same time to gain favour with William III.; and after associating with Titus Oates, being imprisoned for debt and pretending to reveal Jacobite plots, the House of Commons in 1692 declared he was an "imposter, cheat and false accuser." Having stood in the pillory he was again imprisoned until 1695, when he was released; and at this time he took the opportunity to revive the old and familiar story that Mary of Modena was not the mother of the prince of Wales. In 1701 he published his autobiographical *Life of William Fuller* and some *Original Letters of the late King James*. Unable to prove the assertions made in his writings he was put in the pillory, whipped and fined. He died, probably in prison, about 1717. Fuller's other writings are *Mr William Fuller's trip to Bridenell, with a full account of his barbarous usage in the pillory; The sincere and hearty confession of Mr William Fuller* (1704); and *An humble appeal to the impartial judgment of all parties in Great Britain* (1716).

He must be distinguished from WILLIAM FULLER (1608-1675), dean of St Patrick's (1660), bishop of Limerick (1663), and bishop of Lincoln (1667), the friend of Samuel Pepys; and also from William Fuller (c. 1580-1659), dean of Ely and later dean of Durham.

FULLER'S EARTH (Ger. *Walkererde*, Fr. *terre de foulon, argile smectique*)—so named from its use by fullers as an absorbent of the grease and oil of cloth,—a clay-like substance, which from its variability is somewhat difficult to define. In colour it is most often greenish, olive-green or greenish-grey; on weathering it changes to a brown tint or it may be black. As a rule it falls to pieces when placed in water and is not markedly plastic; when dry it adheres strongly to the tongue; since, however, these properties are possessed by many clays that do not exhibit detergent qualities, the only test of value lies in the capacity to absorb grease or clarify oil. Fuller's earth has a specific gravity of 1.7-2.4, and a shining streak; it is usually unctuous to the touch. Microscopically, it consists of minute irregular-shaped particles of a mineral that appears to be the result of a chloritic or talcose alteration of a felspar. The small size of most of the grains, less than .07 mm., makes their determination almost impossible. Chemical analysis shows that the peculiar properties of this earth are due to its physical rather than its chemical nature.

The following analyses of the weathered and unweathered condition of the earth from Nutfield, Surrey, represent the composition of one of the best known varieties:—

Blue Earth (dried at 100° C.).		Yellow Earth (dried at 100° C.).	
Insoluble residue	69.96	Insoluble residue	76.13
Fe ₂ O ₃	2.48	SiO ₂	2.41
Al ₂ O ₃	3.46	Al ₂ O ₃	1.77
CaO	5.87	CaO	4.31
MgO	1.41	MgO	1.05
P ₂ O ₅	0.27	P ₂ O ₅	0.14
SO ₃	0.05	SO ₃	0.07
NaCl	0.05	NaCl	0.14
K ₂ O	0.04	K ₂ O	0.84
H ₂ O (combined)	15.57	H ₂ O (combined)	13.19
	99.86		100.05

Yellow Earth (dried at 100° C.).		Insoluble residue—	
Insoluble residue	76.13	SiO ₂	59.37
Fe ₂ O ₃	2.41	Al ₂ O ₃	10.05
Al ₂ O ₃	1.77	Fe ₂ O ₃	3.86
CaO	4.31	CaO	1.86
MgO	1.05	MgO	1.04
P ₂ O ₅	0.14		
SO ₃	0.07		
NaCl	0.14		
K ₂ O	0.84		
H ₂ O (combined)	13.19		
	100.05		76.18

(Analysis by P. G. Sanford, *Geol. Mag.*, 1889, 6, pp. 456, 526.)

Of other published analyses, not a few show a lower silica content (44% .50%), along with a higher proportion of alumina (11% .23%).

Fuller's earth may occur on any geological horizon; at Nutfield in Surrey, England, it is in the Cretaceous formations; at Midford near Bath it is of Jurassic age; at Bala, North Wales, it occurs in Ordovician strata; in Saxony it appears to be the decomposition product of a diabasic rock. In America it is found in California in rocks ranging from Cretaceous to Pleistocene age; in S. Dakota, Custer county and elsewhere a yellow, gritty earth of Jurassic age is worked; in Florida and Georgia occurs a brittle, whitish earth of Oligocene age. Other deposits are worked in Arkansas, Texas, Colorado, Massachusetts and South Carolina.

Fuller's earth is either mined or dug in the open according to local circumstances. It is then dried in the sun or by artificial heat and transported in small lumps in sacks. In other cases it is ground to a fine powder after being dried; or it is first roughly ground and made into a slurry with water, which is allowed to carry off the finer from the coarser particles and deposit them in a creamy state in suitable tanks. After consolidation this fine material is dried artificially on drying floors, broken into lumps, and packed for transport. The use of fuller's earth for cleansing wool and cloth has greatly decreased, but the demand for the material is as great or greater than it ever was. It is now used very largely in the filtration of mineral oils, and also for decolorizing certain vegetable oils. It is employed in the formation of certain soaps and cleansing preparations.

The term "Fuller's Earth" has a special significance in geology, for it was applied by W. Smith in 1790 to certain clays in the neighbourhood of Bath, and the use of the expression is still retained by English geologists, either in this form or in the generalized "Fullonian." The Fullonian lies at the base of the Great Oolite or Bathonian series, but its palaeontological characters place it between that series and the underlying Inferior Oolite. The zonal fossils are *Perisphinctes arbustigerus* and *Macrocephalus subcontractus* with *Ostrea acuminata*, *Rhynchonella concinna* and *Goniomya angulifera*. The formation is in part the equivalent of the "Vesulien" of J. Marcou (Vesoul in Haute-Saône). In Dorsetshire and Somersetshire, where it is best developed, it is represented by an Upper Fuller's Earth Clay, the Fuller's Earth Rock (an impersistent earthy limestone, usually fossiliferous), and the Lower Fuller's Earth Clay. Commercial fuller's earth has been obtained only from the Upper Clay. In eastern Gloucestershire and northern Oxfordshire the Fuller's Earth passes downwards without break into the Inferior Oolite; northward it dies out about Chipping Norton in Oxfordshire and passes laterally into the Stonesfield Slates series; in the midland counties it may perhaps be represented by the "Upper Estuarine Series." In parts of Dorsetshire the clays have been used for brickmaking and the limestone (rock) for local buildings.

See H. B. Woodward, "Jurassic Rocks of Great Britain," vol. iv. (1894), *Mem. Geol. Survey* (London). [J. A. H.]

FULLERTON, LADY GEORGIANA CHARLOTTE (1812-1885), English novelist and philanthropist, youngest daughter of the 1st Earl Granville, was born at Tixall Hall in Staffordshire on the 23rd of September 1812. In 1833 she married Alexander George Fullerton, then an Irish officer in the guards. After living in Paris for some eight years she and her husband accompanied Lord Granville to Cannes and thence to Rome. In 1843

her husband entered the Roman Catholic church, and in the following year Lady Georgiana Fullerton published her first novel, *Ellen Middleton*, which attracted W. E. Gladstone's attention in the *English Review*. In 1846 she entered the Roman Catholic church. The death of her only son in 1854 plunged her in grief, and she continued to wear mourning until the end of her life. In 1856 she became one of the third order of St Francis, and thenceforward devoted herself to charitable work. In conjunction with Miss Taylor she founded the religious community known as "The Poor Servants of the Mother of God Incarnate," and she also took an active part in bringing to England the sisters of St Vincent of Paul. Her philanthropic work is described in Mrs Augustus Craven's work *Lady Georgiana Fullerton, sa vie et ses œuvres* (Paris, 1888), which was translated into English by Henry James Coleridge. She died at Bournemouth on the 19th of January 1885. Among her other novels were *Granley Manor* (1847), *Lady Bird* (1852), and *Too Strange not to be True* (1864).

FULMAR, from the Gaelic *Fulmair*, the *Fulmarus glacialis* of modern ornithologists, one of the largest of the petrels (*Procellariidae*) of the northern hemisphere, being about the size of the common gull (*Larus canus*) and not unlike it in general coloration, except that its primaries are grey instead of black. This bird, which ranges over the North Atlantic, is seldom seen on the European side below lat. 53° N., but on the American side comes habitually to lat. 45° or even lower. In the Pacific it is represented by a scarcely separable form, *F. glupischa*. It has been commonly believed to have two breeding-places in the British Islands, namely, St Kilda and South Barra; but, according to Robert Gray (*Birds of the West of Scotland*, p. 490), it has abandoned the latter since 1844, though still breeding in Skye. Northward it established itself about 1838 on Myggenaes Holm, one of the Faeroes, while it has several stations off the coast of Iceland and Spitzbergen, as well as at Bear Island. Its range towards the pole seems to be only bounded by open water, and it is the constant attendant upon all who are employed in the whale and seal fisheries, showing the greatest boldness in approaching boats and ships, and feeding on the offal obtained from them. By British seamen it is commonly called the "molly mawk" (corrupted from *Mollemsuck*), and is extremely well known to them, its flight, as it skims over the waves, first with a few beats of the wings and then gliding for a long way, being very peculiar. It only visits the land to deposit its single white egg, which is laid on a rocky ledge, where a shallow nest is made in the turf and lined with a little dried grass. Many of its breeding-places are a most valuable property to those who live near them and take the eggs and young, which, from the nature of the locality, are only to be had at a hazardous risk of life. In St Kilda a large number of the young are killed in one week of August, the only time when, by the custom of the community, they are allowed to be taken. These, after the oil is extracted from them, serve the islanders with food for the winter. The oil has been chemically analysed and found to be a fish-oil, and to possess nearly all the qualities of that obtained from the liver of the cod, with a lighter specific gravity. It, however, has an extremely strong scent, which is said by those who have visited St Kilda to pervade every thing and person on the island, and is certainly retained by an egg or skin of the bird for many years. Whenever a live example is seized in the hand it ejects a considerable quantity of this oil from its mouth.

FULMINIC ACID, HCNO or $\text{H}_2\text{C}_2\text{N}_2\text{O}_3$, an organic acid isomeric with cyanic and cyanuric acids; its salts, termed *fulminates*, are very explosive and are much employed as detonators. The free acid, which is obtained by treating the salts with acids, is an oily liquid smelling like prussic acid; it is very explosive, and the vapour is poisonous to about the same degree as that of prussic acid. The first fulminate prepared was the "fulminating silver" of L. G. Brugnatelli, who found in 1798 that if silver be dissolved in nitric acid and the solution added to spirits of wine, a white, highly explosive powder was obtained. This substance is to be distinguished from the black "fulminating

silver" obtained by C. L. Berthollet in 1788 by acting with ammonia on precipitated silver oxide. The next salt to be obtained was the mercuric salt, which was prepared in 1799 by Edward Charles Howard, who substituted mercury for silver in Brugnatelli's process. A similar method is that of J. von Liebig (1823), who heated a mixture of alcohol, nitric acid and mercuric nitrate; the salt is largely manufactured by processes closely resembling the last. A laboratory method is to mix solutions of sodium nitromethane, $\text{CH}_3\text{NO}(\text{ONa})$, and mercuric chloride, a yellow basic salt being formed at the same time. Mercuric fulminate is less explosive than the silver salt, and forms white needles (with $\frac{1}{2}\text{H}_2\text{O}$) which are tolerably soluble in water. The use of mercuric fulminate as a detonator dates from about 1814, when the explosive cap was invented. It is still the commonest detonator, but it is now usually mixed with other substances; the British service uses for percussion caps 6 parts of fulminate, 6 of potassium chlorate and 4 of antimony sulphide, and for time fuses 4 parts of fulminate, 6 of potassium chlorate and 4 of antimony sulphide, the mixture being damped with a shellac varnish; for use in blasting, a home office order of 1807 prescribes a mixture of 4 parts of fulminate and 1 of potassium chlorate. In 1900 Bielefeldt found that a fulminate placed on top of an aromatic nitro compound, such as trinitrotoluene, formed a useful detonator; this discovery has been especially taken advantage of in Germany, in which country detonators of this nature are being largely employed. Tetranitromethylaniline (tetryl) has also been employed (Brit. Pat. 13340 of 1905). It has been proposed to replace fulminate by silver azoimide (Wöhler & Matter, Brit. Pat. 4468 of 1908), and by lead azoimide (Hyronimus, Brit. Pat. 1819 of 1908).

The constitution of fulminic acid has been investigated by many experimenters, but apparently without definitive results. The researches of Liebig (1823), Liebig and Gay-Lussac (1824), and of Liebig again in 1838 showed the acid to be isomeric with cyanic acid, and probably $(\text{HCNO})_2$, since it gave mixed and acid salts. Kekulé, in 1858, concluded that it was nitroacetonitrile, $\text{NO}_2\text{CH}_2\text{CN}$, a view opposed by Steiner (1883), E. Divers and M. Kawakita (1884), R. Scholl (1890), and by J. U. Nef (1894), who proposed the formulae:

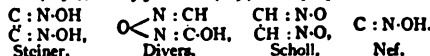

The formulae of Kekulé, Divers and Armstrong have been discarded, and it remains to be shown whether Nef's carbonyloxime formula (or the bimolecular formula of Steiner) or Scholl's glyoxime peroxide formula is correct. There is some doubt as to the molecular formula of fulminic acid. The existence of double salts, and the observations of L. Wöhler and K. Theodorow (*Ber.*, 1905, 38, p. 345), that only compounds containing two carbon atoms yielded fulminates, points to $(\text{HCNO})_2$; on the other hand, Wöhler (*loc. cit.* p. 1351) found that cryoscopic and electric conductivity measurements showed sodium fulminate to be NaCNO . Nef based his formula, which involves bivalent carbon, on many reactions; in particular, that silver fulminate with hydrochloric acid gave salts of formylchloridoxime, which with water gave hydroxylamine and formic acid, thus

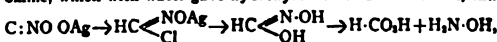

and also on the production from sodium nitromethane and mercuric chloride, thus $\text{CH}_3 : \text{NO} \cdot \text{OAg} \rightarrow \text{H}_2\text{O} + \text{C} : \text{NOAg}$ ($\text{hg} = \frac{1}{2}\text{Hg}$). H. Wieland and F. C. Palazzo (1907) support this formula, finding that methyl nitrolic acid, $\text{NO}_2\text{CH} : \text{N} \cdot \text{OH}$, yielded under certain conditions fulminic acid, and vice versa (Palazzo, 1907). M. Z. Jowitschitsch (*Ausw.*, 1906, 347, p. 233) inclines to Scholl's formula; he found that the synthetic silver salt of glyoxime peroxide resembled silver fulminate in yielding hydroxylamine with hydrochloric acid, but differed in being less explosive, and in being soluble in nitric acid. H. Wieland and his collaborators regard "glyoxime peroxide" as an oxide of furazane (*q.v.*), and have shown that a close relationship exists between the nitrite oxides, furaxane, and fulminic acid (see *Ausw. Rep.*, London Chem. Soc., 1909, p. 84). *Fulminic acid*, $(\text{HCNO})_2$, obtained by Liebig by boiling mercuric fulminate with water, was synthesized in 1905 by C. Ulpiani and L. Bernardini (*Gazzetta*, iii. 35, p. 7), who regard it as $\text{NO}_2\text{CH}(\text{CN})\text{CO} \cdot \text{NH}_2$. It decomposes at 145°, and forms a characteristic cuprammonium salt.

The early history of mercuric fulminate and a critical account of its application as a detonator is given in *The Rise and Progress of the British Explosives Industry* (International Congress of Applied Chemistry, 1909). The manufacture and modern aspects are treated in Oscar Guttman, *The Manufacture of Explosives, and Manufacture of Explosives, Twenty Years' Progress* (1909).

¹ A name misapplied in the southern hemisphere to *Diomedes melanophrys*, one of the albatrosses.

FULTON, ROBERT (1765–1815), American engineer, was born in 1765 in Little Britain (now Fulton, Lancaster county), Pa. His parents were Irish, and so poor that they could afford him only a very scanty education. At an early age he was bound apprentice to a jeweller in Philadelphia, but subsequently adopted portrait and landscape painting as his profession. In his twenty-second year, with the object of studying with his countryman, Benjamin West, he went to England, and there became acquainted with the duke of Bridgewater, Earl Stanhope and James Watt. Partly by their influence he was led to devote his attention to engineering, especially in connexion with canal construction; he obtained an English patent in 1794 for superseding canal locks by inclined planes, and in 1796 he published a *Treatise on the Improvement of Canal Navigation*. He then took up his residence in Paris, where he projected the first panorama ever exhibited in that city, and constructed a submarine boat, the "Nautilus," which was tried in Brest harbour in 1801 before a commission appointed by Napoleon I., and by the aid of which he was enabled to blow up a small vessel with a torpedo. It was at Paris also in 1803 that he first succeeded in propelling a boat by steam-power, thus realizing a design which he had conceived ten years previously. Returning to America he continued his experiments with submarine explosives, but failed to convince either the English, French or United States governments of the adequacy of his methods. With steam navigation he had more success. In association with Robert R. Livingston (q.v.), who in 1798 had been granted the exclusive right to navigate the waters of New York state with steam-vessels, he constructed the "Clermont," which, engine by Boulton & Watt of Birmingham, began to ply on the Hudson between New York and Albany in 1807. The privilege obtained by Livingston in 1798 was granted jointly to Fulton and Livingston in 1803, and by an act passed in 1808 the monopoly was secured to them and their associates for a period depending on the number of steamers constructed, but limited to a maximum of thirty years. In 1814–1815, on behalf of the United States government, he constructed the "Fulton," a vessel of 38 tons with central paddle-wheels, which was the first steam warship. He died at New York on the 24th of February 1815. Among Fulton's inventions were machines for spinning flax, for making ropes, and for sawing and polishing marble.

See C. D. Colden, *Life of Robert Fulton* (New York, 1817); Robert H. Thurston, *History of the Growth of the Steam-Engine* (New York, 1878); George H. Preble, *Chronological History of Steam Navigation* (Philadelphia, 1883); and Mrs A. C. Sutcliffe, *Robert Fulton and the Clermont* (New York, 1909).

FULTON, a city and the county-seat of Callaway county, Missouri, U.S.A., 25 m. N.E. of Jefferson City. Pop. (1890) 4314; (1900) 4883 (1167 negroes); (1910) 5228. It is served by the Chicago & Alton railway. The city has an important stock market and manufactures fire-brick and pottery. At Fulton are the Westminster College (Presbyterian, founded in 1853), the Synodical College for Young Women (Pres., founded in 1871), the William Woods College for Girls (Christian Church, 1890), and the Missouri school for the deaf (1851). Here, too, is a state hospital for the insane (1847), the first institution of the kind in Missouri. The place was laid out as a town in 1825 and named Volney, but in honour of Robert Fulton the present name was adopted a little later. Fulton was incorporated in 1859.

FULTON, a city of Oswego county, New York, U.S.A., on the right bank of the Oswego river, about 10 m. S. by E. of Oswego. Pop. (1900) 5281; (1905, state census) 8847; (1910) 10,430. Fulton is served by the Delaware, Lackawanna & Western, the New York Central & Hudson River, and the New York, Ontario & Western railways, by electric railway to Oswego and Syracuse and by the Oswego Canal. The city has a Carnegie library. Ample water-power is furnished by the Oswego river, which here flows in a series of rapids, and the manufactures are many in kind. On the 3rd of July 1756, on an island (afterward called Battle Island) 4 m. N. of the present city of Fulton, a British force of about 300 under Captain John Bradstreet (1711–1774) defeated an attacking force of French and Indians (numbering

about 700) under De Villiers. Soon after this, Bradstreet built a fort within the present limits of Fulton. The first civilian settler came in 1793, and the first survey (which included only a part of the subsequent village) was made in 1815. Fulton was incorporated as a village in 1835, and in April 1902 was combined with the village of Oswego Falls (pop. in 1900, 2925) and was chartered as a city.

FUM, or **FUNJ HWANG**, one of the four symbolical creatures which in Chinese mythology are believed to keep watch and ward over the Celestial Empire. It was begotten by fire, was born in the Hill of the Sun's Halo, and its body bears inscribed on it the five cardinal virtues. It has the breast of a goose, the hind-quarters of a stag, a snake's neck, a fish's tail, a fowl's forehead, a duck's down, the marks of a dragon, the back of a tortoise, the face of a swallow, the beak of a cock, is about six cubits high, and perches only on the woo-tung tree. The appearance of Fum heralds an age of universal virtue. Its figure is that which is embroidered on the dresses of some mandarins.

FUMARIC AND MALEIC ACIDS, two isomeric unsaturated acids of composition $C_4H_4O_4$. *Fumaric acid* is found in fumitory (*Fumaria officinalis*), in various fungi (*Agaricus piperatus*, &c.), and in Iceland moss. It is obtained by heating malic acid alone to 150° C., or by heating it with hydrochloric acid (V. Dessaignes, *Jahresb.*, 1856, p. 463) or with a large quantity of hydrobromic acids (A. Kekulé, *Ann.*, 1864, 130, p. 21). It may also be obtained by boiling monobromosuccinic acid with water; by the action of dichloroacetic acid and water on silver malonate (T. Komnens, *Ann.*, 1883, 218, p. 160); by the cyanide synthesis from acetylene di-iodide; and by heating malic acid to 210° C. (Z. Skrap, *Monats. f. Chemie*, 1891, 12, p. 112). It crystallizes in small prisms or needles, and is practically insoluble in cold water. It sublimes to some extent at about 200° C., being partially converted into malic anhydride and water, the reaction becoming practically quantitative if dehydrating agents be used. Reducing agents (zinc and caustic alkali, hydriodic acid, sodium amalgam, &c.) convert it into succinic acid. Bromine converts it into dibromosuccinic acid. Potassium permanganate oxidizes it to racemic acid (A. Kekulé and R. Anschütz, *Ber.*, 1881, 14, p. 713). By long-continued heating with caustic soda at 100° C. it is converted into inactive malic acid.

Maleic acid is obtained by distilling malic or fumaric acids; by heating fumaric acid with acetyl chloride to 100° C.; or by the hydrolysis of trichlorophenolic acid (β -trichloroacetoacrylic acid) [A. Kekulé, *Ann.*, 1884, 223, p. 185]. It crystallizes in monoclinic prisms, which are easily soluble in water, melt at 130° C., and boil at 160° C., decomposing into water and maleic anhydride. When heated with concentrated hydrobromic or hydriodic acids, it is converted into fumaric acid. It yields an anilide; oxidation converts it into mesotartaric acid. Maleic anhydride is obtained by distilling fumaric acid with phosphorus pentoxide. It forms triclinic crystals which melt at 60° C. and boil at 196° C.

Both acids are readily esterified by the action of alkyl halides on their silver salts, and the maleic ester is readily transformed into the fumaric ester by warming with iodine, the same result being obtained by esterification of maleic acid in alcoholic solution by means of hydrochloric acid. Both acids yield acetylene by the electrolysis of aqueous solutions of their alkali salts, and on reduction both yield succinic acid, whilst by the addition of hydrobromic acid they both yield monobromosuccinic acid (R. Fittig, *Ann.*, 1877, 188, p. 96). From these results it follows that the two acids are structurally identical, and the isomerism has consequently to be explained on other grounds. This was accomplished by W. Wislicenus ("Über die räumliche Anordnung der Atome," &c., *Trans. of the Saxon Acad. of Sciences* (Math. Phys. Section), 1887, p. 14) by an extension of the van't Hoff hypothesis (see STEREO-ISOMERISM). The formulae of the acids are written thus:



These account for maleic acid readily yielding an anhydride, whereas fumaric acid does not, and for the behaviour of the acids towards bromine, fumaric acid yielding ordinary dibromosuccinic acid, and maleic acid the isomeric di-dibromosuccinic acid.

FUMAROLE, a vent from which volcanic vapours issue, named indirectly from the Lat. *fumarolium*, a smoke-hole.

The vapours from fumaroles were studied first by R. W. Bunsen, on his visit to Iceland, and afterwards by H. Sainte-Claire Deville and other chemists and geologists in France, who examined the vapours from Santorin, Etna, &c. The hottest vapours issue from dry fumaroles, at temperatures of at least 500° C., and consist chiefly of anhydrous chlorides, notably sodium chloride. The acid fumaroles yield vapours of lower temperature (300° to 400°) containing much water vapour, with hydrogen chloride and sulphur dioxide. The alkaline fumaroles are still cooler, though above 100°, and evolve ammonium chloride with other vapours. Cold fumaroles, below 100°, discharge principally aqueous vapour, with carbon dioxide, and perhaps hydrogen sulphide. The fumaroles of Mont Pelé in Martinique during the eruption of 1902 were examined by A. Lacroix, and the vapours analysed by H. Moissan, who found that they consisted chiefly of water vapour, with hydrogen chloride, sulphur, carbon dioxide, carbon monoxide, methane, hydrogen, nitrogen, oxygen and argon. These vapours issued at a temperature of about 400°. Armand Gautier has pointed out that these gases are practically of the same composition as those which he obtained on heating granite and certain other rocks. (See VOLCANO).

FUMIGATION (from Lat. *fumigare*, to smoke), the process of producing smoke or fumes, as by burning sulphur, frankincense, tobacco, &c., whether as a ceremony of incantation, or for perfuming a room, or for purposes of disinfection or destruction of vermin. In medicine the term has been used of the exposure of the body, or a portion of it, to fumes such as those of nitre, sal-ammoniac, mercury, &c.; fumigation, by the injection of tobacco smoke into the great bowel, was a recognized procedure in the 18th century for the resuscitation of the apparently drowned. "Fumigated" or "fumed" oak is oak which has been darkened by exposure to ammonia vapour.

FUMITORY, in botany, the popular name for the British species of *Fumaria*, a genus of small, branched, often climbing annual herbs with much-divided leaves and racemes of small flowers. The flowers are tubular with a spurred base, and in the British species are pink to purplish in colour. They are weeds of cultivation growing in fields and waste places. *F. capreolata* climbs by means of twisting petioles. In past times fumitory was in esteem for its reputed cholagogue and other medicinal properties; and in England, boiled in water, milk or whey, it was used as a cosmetic. The root of the allied species (*Corydalis cava* or *tuberosa*) is known as *radix aristolochia*, and has been used medicinally for various cutaneous and other disorders, in doses of 10 to 30 grains. Some eleven alkaloids have been isolated from it. The herbage of *Fumaria officinalis* and *F. racemosa* is used in China under the name of *Tsue-hwo-li-ting* as an application for glandular swellings, carbuncles and abscesses, and was formerly valued in jaundice, and in cases of accidental swallowing of the beard of grain (see F. Porter Smith, *Contrib. towards the Mat. Medica . . . of China*, p. 99, 1871). The name fumitory, Latin *fumus terrae*, has been supposed to be derived from the fact that its juice irritates the eyes like smoke (see Fuchs, *De historia stirpium*, p. 338, 1542); but *The Grete Herball*, cap. cxlix., 1529, fol., following the *De simplicis medicina* of Platearius, fo. xciii. (see in *Nicolai Praepositi dispensatorium ad aromatarios*, 1536), says: "It is called *Fumus terre fume* or smoke of the erthe bycause it is engendred of a cours fumosyte rysynge from the erthe in grete quantyte lyke smoke: this grosse or cours fumosyte of the erthe wyndeth and wyreth out: and by workynge of the ayre and sonne it turneth into this herbe."

FUNCHAL, the capital of the Portuguese archipelago of the Madeiras; on the south coast of Madeira, in 32° 37' N. and 16° 54' W. Pop. (1900) 20,850. Funchal is the see of a bishop, in the archiepiscopal province of Lisbon; it is also the administrative centre of the archipelago, and the residence of the governor and foreign consuls. The city has an attractive appearance from the sea. Its whitewashed houses, in their gardens full of tropical plants, are built along the curving shore of Funchal Bay, and on the lower slopes of an amphitheatre of mountains, which form a background 4000 ft. high. Numerous country houses (*quintas*), with terraced gardens, vineyards and

sugar-cane plantations occupy the surrounding heights. Three mountain streams traverse the city through deep channels, which in summer are dry, owing to the diversion of the water for irrigation. A small fort, on an isolated rock off shore, guards the entrance to the bay, and a larger and more powerfully armed fort crowns an eminence inland. The chief buildings include the cathedral, Anglican and Presbyterian churches, hospitals, opera-house, museum and casino. There are small public gardens and a meteorological observatory. In the steep and narrow streets, which are lighted by electricity, wheeled traffic is impossible; sledges drawn by oxen, and other primitive conveyances are used instead (see MADEIRA). In winter the fine climate and scenery attract numerous invalids and other visitors, for whose accommodation there are good hotels; many foreigners engaged in the coal and wine trades also reside here permanently. The majority of these belong to the British community, which was first established here in the 18th century. Funchal is the headquarters of Madeiran industry and commerce (see MADEIRA). It has no docks and no facilities for landing passengers or goods; vessels are obliged to anchor in the roadstead, which, however, is sheltered from every wind except the south. Funchal is connected by cable with Carcavelos (for Lisbon), Porthcurnow (for Falmouth, England) and St Vincent in the Cape Verde Islands (for Pernambuco, Brazil).

FUNCTION,¹ in mathematics, a variable number the value of which depends upon the values of one or more other variable numbers. The theory of functions is conveniently divided into (I.) Functions of Real Variables, wherein real, and only real, numbers are involved, and (II.) Functions of Complex Variables, wherein complex or imaginary numbers are involved.

I. FUNCTIONS OF REAL VARIABLES

1. *Historical*.—The word function, defined in the above sense, was introduced by Leibnitz in a short note of date 1694 concerning the construction of what we now call an "envelope" (*Leibnizens mathematische Schriften*, edited by C. I. Gerhardt, Bd. v. p. 306), and was there used to denote a variable length related in a defined way to a variable point of a curve. In 1698 James Bernoulli used the word in a special sense in connexion with some isoperimetric problems (Joh. Bernoulli, *Opera*, t. i. p. 255). He said that when it is a question of selecting from an infinite set of like curves that one which best fulfils some function, then of two curves whose intersection determines the thing sought one is always the "line of the function" (*Linea functionis*). In 1718 John Bernoulli (*Opera*, t. ii. p. 241) defined a "function of a variable magnitude" as a quantity made up in any way of this variable magnitude and constants; and in 1730 (*Opera*, t. iii. p. 174) he noted a distinction between "algebraic" and "transcendental" functions. By the latter he meant integrals of algebraic functions. The notation $f(x)$ for a function of a variable x was introduced by Leonhard Euler in 1734 (*Comm. Acad. Petropol.* t. vii. p. 186), in connexion with the theorem of the interchange of the order of differentiations. The notion of functionality or functional relation of two magnitudes was thus of geometrical origin; but a function soon came to be regarded as an analytical expression, not necessarily an algebraic expression, containing the variable or variables. Thus we may have rational integral algebraic functions such as $ax^2 + bx + c$, or rational algebraic functions which are not integral, such as

$$\frac{a_1x^n + a_2x^{n-1} + \dots + a_n}{b_1x^m + b_2x^{m-1} + \dots + b_m}$$

or irrational algebraic functions, such as \sqrt{x} , or, more generally the algebraic functions that are determined implicitly by an algebraic equation, as, for instance,

$$f_n(x,y) + f_{n-1}(x,y) + \dots + f_0 = 0$$

¹The word "function" (from Lat. *fungi*, to perform) has many uses, but the fundamental sense of an activity special or proper to an office, business or profession, or to an organ of an animal or plant; the definite work for which the organ is an apparatus. From the use of the word, as in the Italian *funzione*, for a ceremony of the Roman Church, "function" is often employed for a public ceremony of any kind, and loosely of a social entertainment or gathering.

where $f_0(x, y), \dots$ mean homogeneous expressions in x and y having constant coefficients, and having the degrees indicated by the suffixes, and f_0 is a constant. Or again we may have trigonometrical functions, such as $\sin x$ and $\tan x$, or inverse trigonometrical functions, such as $\sin^{-1}x$, or exponential functions, such as e^x and e^y , or logarithmic functions, such as $\log x$ and $\log(1+x)$. We may have these functional symbols combined in various ways, and thus there arises a great number of functions. Further we may have functions of more than one variable, as, for instance, the expression $xy/(x^2 + y^2)$, in which both x and y are regarded as variable. Such functions were introduced into analysis somewhat unsystematically as the need for them arose, and the later developments of analysis led to the introduction of other classes of functions.

2. *Graphic Representation.*—In the case of a function of one variable x , any value of x and the corresponding value y of the function can be the co-ordinates of a point in a plane. To any value of x there corresponds a point N on the axis of x , in accordance with the rule that x is the abscissa of N . The corresponding value of y determines a point P in accordance with the rule that x is the abscissa and y the ordinate of P . The ordinate y gives the value of the function which corresponds to that value of the variable x which is specified by N ; and it may be described as "the value of the function at N ." Since there is a one-to-one correspondence of the points N and the numbers x , we may also describe the ordinate as "the value of the function at x ." In simple cases the aggregate of the points P which are determined by any particular function (of one variable) is a curve, called the "graph of the function" (see § 14). In like manner a function of two variables defines a surface.

3. *The Variable.*—Graphic methods of representation, such as those just described, enabled mathematicians to deal with irrational values of functions and variables at the time when there was no theory of irrational numbers other than Euclid's theory of incommensurables. In that theory an irrational number was the ratio of two incommensurable geometric magnitudes. In the modern theory of number irrational numbers are defined in a purely arithmetical manner, independent of the measurement of any quantities or magnitudes, whether geometric or of any other kind. The definition is effected by means of the system of ordinal numbers (see NUMBER). When this formal system is established, the theory of measurement may be founded upon it; and, in particular, the co-ordinates of a point are defined as numbers (not lengths), which are assigned in accordance with a rule. This rule involves the measurement of lengths. The theory of functions can be developed without any reference to graphs, or co-ordinates or lengths. The process by which analysis has been freed from any consideration of measurable quantities has been called the "arithmetization of analysis." In the theory so developed, the variable upon which a function depends is always to be regarded as a number, and the corresponding value of the function is also a number. Any reference to points or co-ordinates is to be regarded as a picturesque mode of expression, pointing to a possible application of the theory to geometry. The development of "arithmetized analysis" in the 19th century is associated with the name of Karl Weierstrass.

All possible values of a variable are numbers. In what follows we shall confine our attention to the case where the numbers are real. When complex numbers are introduced, instead of real ones, the theory of functions receives a wide extension, which is accompanied by appropriate limitations (see below, II. Functions of Complex Variables). The set of all real numbers forms a *continuum*. In fact the notion of a one-dimensional continuum first becomes precise in virtue of the establishment of the system of real numbers.

4. *Domain of a Variable.—Theory of Aggregates.*—The notion of a "variable" is that of a number to which we may assign at pleasure any one of the values that belong to some chosen set, or *aggregate*, of numbers; and this set, or aggregate, is called the "domain of the variable." This domain may be an "interval," that is to say it may consist of two terminal numbers, all the numbers between them and no others. When this is

the case the number is said to be "continuously variable." When the domain consists of all real numbers, the variable is said to be "unrestricted." A domain which consists of all the real numbers which exceed some fixed number may be described as an "interval unlimited towards the right"; similarly we may have an interval "unlimited towards the left."

In more complicated cases we must have some rule or process for assigning the aggregate of numbers which constitute the domain of a variable. The methods of definition of particular types of aggregates, and the theorems relating to them, form a branch of analysis called the "theory of aggregates" (*Mengenlehre, Théorie des ensembles, Theory of sets of points*). The notion of an "aggregate" in general underlies the system of ordinal numbers. An aggregate is said to be "infinite" when it is possible to effect a one-to-one correspondence of all its elements to some of its elements. For example, we may make all the integers correspond to the even integers, by making 1 correspond to 2, 2 to 4, and generally n to $2n$. The aggregate of positive integers is an infinite aggregate. The aggregates of all rational numbers and of all real numbers and of points on a line are other examples of infinite aggregates. An aggregate whose elements are real numbers is said to "extend to infinite values" if, after any number N , however great, is specified, it is possible to find in the aggregate numbers which exceed N in absolute value. Such an aggregate is always infinite. The "neighbourhood of a number (or point) a for a positive number h " is the aggregate of all numbers (or points) x for which the absolute value of $x-a$ denoted by $|x-a|$, does not exceed h .

5. *General Notion of Functionality.*—A function of one variable was for a long time commonly regarded as the ordinate of a curve; and the two notions (1) that which is determined by a curve supposed drawn, and (2) that which is determined by an analytical expression supposed written down, were not for a long time clearly distinguished. It was for this reason that Fourier's discovery that a single analytical expression is capable of representing (in different parts of an interval) what would in his time have been called different functions so profoundly struck mathematicians (§ 23). The analysts who, in the middle of the 19th century, occupied themselves with the theory of the convergence of Fourier's series were led to impose a restriction on the character of a function in order that it should admit of such representation, and thus the door was opened for the introduction of the general notion of functional dependence. This notion may be expressed as follows: We have a variable number, y , and another variable number, x , a domain of the variable x , and a rule for assigning one or more definite values to y when x is any point in the domain; then y is said to be a "function" of the variable x , and x is called the "argument" of the function. According to this notion a function is, as it were, an indefinitely extended table, like a table of logarithms; to each point in the domain of the argument there correspond values for the function, but it remains arbitrary what values the function is to have at any such point.

For the specification of any particular function two things are requisite: (1) a statement of the values of the variable, or of the aggregate of points, to which values of the function are to be made to correspond, i.e. of the "domain of the argument"; (2) a rule for assigning the value or values of the function that correspond to any point in this domain. We may refer to the second of these two essentials as "the rule of calculation." The relation of functions to analytical expressions may then be stated in the form that the rule of calculation is: "Give the function the value of the expression at any point at which the expression has a determinate value," or again more generally, "Give the function the value of the expression at all points of a definite aggregate included in the domain of the argument." The former of these is the rule of those among the earlier analysts who regarded an analytical expression and a function as the same thing, and their usage may be retained without causing confusion and with the advantage of brevity, the analytical expression serving to specify the domain of the argument as well as the rule of calculation, e.g. we may speak of "the function $1/x$." This function is defined by the analytical expression $1/x$ at all points except the point $x=0$. But in complicated cases separate statements of the domain of the argument and the rule of calculation cannot be dispensed with. In general, when the rule of calculation is determined as above by an analytical expression at any aggregate of points, the function is said to be "represented" by the expression at those points.

When the rule of calculation assigns a single definite value for a function at each point in the domain of the argument the function is "uniform" or "one-valued." In what follows it is to be understood that all the functions considered are one-valued, and the values

assigned by the rule of calculation real. In the most important cases the domain of the argument of a function of one variable is an interval, with the possible exception of isolated points.

6. *Limits*.—Let $f(x)$ be a function of a variable number x ; and let a be a point such that there are points of the domain of the argument x in the neighbourhood of a for any number h , however small. If there is a number L which has the property that, after any positive number ϵ , however small, has been specified, it is possible to find a positive number h , so that $|L - f(x)| < \epsilon$ for all points x of the domain (other than a) for which $|x - a| < h$, then L is the "limit of $f(x)$ at the point a ." The condition for the existence of L is that, after the positive number ϵ has been specified, it must be possible to find a positive number h , so that $|f(x') - f(x)| < \epsilon$ for all points x and x' of the domain (other than a) for which $|x - a| < h$ and $|x' - a| < h$.

It is a fundamental theorem that, when this condition is satisfied, there exists a perfectly definite number L which is the limit of $f(x)$ at the point a as defined above. The limit of $f(x)$ at the point a is denoted by $L \lim_{x \rightarrow a} f(x)$, or by $\lim_{x \rightarrow a} f(x)$.

If $f(x)$ is a function of one variable x in a domain which extends to infinite values, and if, after a has been specified, it is possible to find a number N , so that $|f(x') - f(x)| < \epsilon$ for all values of x and x' which are in the domain and exceed N , then there is a number L which has the property that $|f(x) - L| < \epsilon$ for all such values of x . In this case $f(x)$ has a limit L at $x = \infty$. In like manner $f(x)$ may have a limit at $x = -\infty$. This statement includes the case where the domain of the argument consists exclusively of positive integers. The values of the function then form a "sequence," $u_1, u_2, \dots, u_n, \dots$, and this sequence can have a limit at $n = \infty$.

The principle common to the above definitions and theorems is called, after P. du Bois Reymond, "the general principle of convergence to a limit."

It must be understood that the phrase " $x = \infty$ " does not mean that x takes some particular value which is infinite. There is no such value. The phrase always refers to a limiting process in which, as the process is carried out, the variable number x increases without limit; it may, as in the above example of a sequence, increase by taking successively the values of all the integral numbers; in other cases it may increase by taking the values that belong to any domain which "extends to infinite values."

A very important type of limits is furnished by *infinite series*. When a sequence of numbers $u_1, u_2, \dots, u_n, \dots$ is given, we may form a new sequence $s_1, s_2, \dots, s_n, \dots$ from it by the rules $s_1 = u_1, s_2 = u_1 + u_2, \dots, s_n = u_1 + u_2 + \dots + u_n$, or by the equivalent rules $s_1 = u_1, s_n - s_{n-1} = u_n (n = 2, 3, \dots)$. If the new sequence has a limit at $n = \infty$, this limit is called the "sum of the infinite series" $u_1 + u_2 + \dots$, and the series is said to be "convergent" (see SERIES).

A function which has not a limit at a point a may be such that, if a certain aggregate of points is chosen out of the domain of the argument, and the points x in the neighbourhood of a are restricted to belong to this aggregate, then the function has a limit at a . For example, $\sin(1/x)$ has limit zero at 0 if x is restricted to the aggregate $1/x, 1/2x, \dots, 1/nx, \dots$ or to the aggregate $1/2\pi, 2/5\pi, \dots, n/(n^2+1)\pi, \dots$, but if x takes all values in the neighbourhood of 0, $\sin(1/x)$ has not a limit at 0. Again, there may be a limit at a if the points x in the neighbourhood of a are restricted by the condition that $x - a$ is positive; then we have a "limit on the right" at a ; similarly we may have a "limit on the left" at a point. Any such limit is described as a "limit for a restricted domain." The limits on the left and on the right are denoted by $f(a-0)$ and $f(a+0)$.

The limit L of $f(x)$ at a stands in no necessary relation to the value of $f(x)$ at a . If the point a is in the domain of the argument, the value of $f(x)$ at a is assigned by the rule of calculation, and may be different from L . In case $f(a) = L$ the limit is said to be "attained." If the point a is not in the domain of the argument, there is no value for $f(x)$ at a . In the case where $f(x)$ is defined for all points in an interval containing a , except the point a , and has a limit L at a , we may arbitrarily annex the point a to the domain of the argument and assign to $f(a)$ the value L ; the function may then be said to be "extrinsically defined." The so-called "indeterminate forms" (see INFINITESIMAL CALCULUS) are examples.

7. *Superior and Inferior Limits; Infinities*.—The value of a function at every point in the domain of its argument is finite, since, by definition, the value can be assigned, but this does not necessarily imply that there is a number N which exceeds all the values (or is less than all the values). It may happen that, however great a number N we take, there are among the values of the function numbers which exceed N (or are less than $-N$).

If a number can be found which is greater than every value of the function, then either (a) there is one value of the function

which exceeds all the others, or (b) there is a number S which exceeds every value of the function but is such that, however small a positive number ϵ we take, there are values of the function which exceed $S - \epsilon$. In the case (a) the function has a greatest value; in case (b) the function has a "superior limit" S , and then there must be a point a which has the property that there are points of the domain of the argument, in the neighbourhood of a for any h , at which the values of the function differ from S by less than ϵ . Thus S is the limit of the function at a , either for the domain of the argument or for some more restricted domain. If a is in the domain of the argument, and if, after omission of a , there is a superior limit S which is in this way the limit of the function at a , if further $f(a) = S$, then S is the greatest value of the function; in this case the greatest value is a limit (at any rate for a restricted domain) which is attained; it may be called a "superior limit which is attained." In like manner we may have a "smallest value" or an "inferior limit," and a smallest value may be an "inferior limit which is attained."

All that has been said here may be adapted to the description of greatest values, superior limits, &c., of a function in a restricted domain contained in the domain of the argument. In particular, the domain of the argument may contain an interval; and therein the function may have a superior limit, or an inferior limit, which is attained. Such a limit is a maximum value or a minimum value of the function.

Again, if, after any number N , however great, has been specified, it is possible to find points of the domain of the argument at which the value of the function exceeds N , the values of the function are said to have an "infinite superior limit," and then there must be a point a which has the property that there are points of the domain, in the neighbourhood of a for any h , at which the value of the function exceeds N . If the point a is in the domain of the argument the function is said to "tend to become infinite" at a ; it has of course a finite value at a . If the point a is not in the domain of the argument the function is said to "become infinite" at a ; it has of course no value at a . In like manner we may have a (negatively) infinite inferior limit. Again, after any number N , however great, has been specified and a number k found, so that all the values of the function, at points in the neighbourhood of a for h , exceed N in absolute value, all these values may have the same sign; the function is then said to become, or to tend to become, "determinately (positively or negatively) infinite"; otherwise it is said to become or to tend to become, "indeterminately infinite."

All the infinities that occur in the theory of functions are of the nature of variable finite numbers, with the single exception of the infinity of an infinite aggregate. The latter is described as an "actual infinity," the former as "improper infinities." There is no "actual infinitely small" corresponding to the actual infinity. The only "infinitely small" is zero. All "infinite values" are of the nature of superior and inferior limits which are not attained.

8. *Increasing and Decreasing Functions*.—A function $f(x)$ of one variable x , defined in the interval between a and b , is "increasing throughout the interval" if, whenever x and x' are two numbers in the interval and $x' > x$, then $f(x') > f(x)$; the function "never decreases throughout the interval" if, x' and x being as before, $f(x') > f(x)$. Similarly for decreasing functions, and for functions which never increase throughout an interval. A function which either never increases or never diminishes throughout an interval is said to be "monotonous throughout" the interval. If we take in the above definition $b > a$, the definition may apply to a function under the restriction that x' is not b and x is not a ; such a function is "monotonous within" the interval. In this case we have the theorem that the function (if it never decreases) has a limit on the left at b and a limit on the right at a , and these are the superior and inferior limits of its values at all points within the interval (the ends excluded); the like holds *mutatis mutandis* if the function never increases. If the function is monotonous throughout the interval, $f(b)$ is the greatest (or least) value of $f(x)$ in the interval; and if $f(b)$ is the limit of $f(x)$ on the left at b , such a greatest (or least) value is an example of a superior (or inferior) limit which is attained. In these cases the function tends continually to its limit.

These theorems and definitions can be extended, with obvious modifications, to the cases of a domain which is not an interval, or extends to infinite values. By means of them we arrive at sufficient, but not necessary, criteria for the existence of a limit; and these are frequently easier to apply than the general principle of convergence to a limit (§ 6), of which principle they are particular cases. For example, the function represented by $x \log(1/x)$ continually

diminishes when $1/c > x > 0$ and x diminishes towards zero, and it never becomes negative. It therefore has a limit on the right at $x=0$. This limit is zero. The function represented by $x \sin (1/x)$ does not continually diminish towards zero as x diminishes towards zero, but is sometimes greater than zero and sometimes less than zero, in any neighbourhood of $x=0$, however small. Nevertheless, the function has the limit zero at $x=0$.

9. *Continuity of Functions.*—A function $f(x)$ of one variable x is said to be continuous at a point a if (1) $f(x)$ is defined in an interval containing a ; (2) $f(x)$ has a limit at a ; (3) $f(a)$ is equal to this limit. The limit in question must be a limit for continuous variation, not for a restricted domain. If $f(x)$ has a limit on the left at a and $f(a)$ is equal to this limit, the function may be said to be "continuous to the left" at a ; similarly the function may be "continuous to the right" at a .

A function is said to be "continuous throughout an interval" when it is continuous at every point of the interval. This implies continuity to the right at the smaller end-value and continuity to the left at the greater end-value. When these conditions at the ends are not satisfied the function is said to be continuous "within" the interval. By a "continuous function" of one variable we always mean a function which is continuous throughout an interval.

The principal properties of a continuous function are:

1. The function is practically constant throughout sufficiently small intervals. This means that, after any point a of the interval has been chosen, and any positive number ϵ , however small, has been specified, it is possible to find a number δ , so that the difference between any two values of the function in the interval between $a-\delta$ and $a+\delta$ is less than ϵ . There is an obvious modification if a is an end-point of the interval.

2. The continuity of the function is "uniform." This means that the number δ which corresponds to any ϵ as in (1) may be the same at all points of the interval, or, in other words, that the numbers δ which correspond to ϵ for different values of a have a positive inferior limit.

3. The function has a greatest value and a least value in the interval, and these are superior and inferior limits which are attained.

4. There is at least one point of the interval at which the function takes any value between its greatest and least values in the interval.

5. If the interval is unlimited towards the right (or towards the left), the function has a limit at ∞ (or at $-\infty$).

10. *Discontinuity of Functions.*—The discontinuities of a function of one variable, defined in an interval with the possible exception of isolated points, may be classified as follows:

(1) The function may become infinite, or tend to become infinite, at a point.

(2) The function may be undefined at a point.

(3) The function may have a limit on the left and a limit on the right at the same point; these may be different from each other, and at least one of them must be different from the value of the function at the point.

(4) The function may have no limit at a point, or no limit on the left, or no limit on the right, at a point.

In case a function $f(x)$, defined as above, has no limit at a point a , there are four limiting values which come into consideration. Whatever positive number ϵ we take, the values of the function at points between a and $a+\epsilon$ (excluded) have a superior limit (or a greatest value), and an inferior limit (or a least value); further, as ϵ decreases, the former never increases and the latter never decreases; accordingly each of them tends to a limit. We have in this way two limits on the right—the inferior limit of the superior limits in diminishing neighbourhoods, and the superior limit of the inferior limits in diminishing neighbourhoods. These are denoted by $\overline{f(a+0)}$ and $\underline{f(a+0)}$, and they are called the "limits of indefiniteness" on the right. Similar limits on the left are denoted by $\overline{f(a-0)}$ and $\underline{f(a-0)}$. Unless $f(x)$ becomes, or tends to become, infinite at a , all these must exist, any two of them may be equal, and at least one of them must be different from $f(a)$, if $f(a)$ exists. If the first two are equal there is a limit on the right denoted by $f(a+0)$; if the second two are equal, there is a limit on the left denoted by $f(a-0)$. In case the function becomes, or tends to become, infinite at a , one or more of these limits is infinite in the sense explained in § 7; and now it is to be noted that, e.g. the superior limit of the inferior limits in diminishing neighbourhoods on the right of a may be negatively infinite; this happens if, after any number N , however great, has been specified, it is possible to find a positive number δ , so that all the values of the function in the interval between a and $a+\delta$ (a excluded) are less than $-N$; in such a case $f(x)$ tends to become negatively infinite when x decreases towards a ; other modes of tending to infinite limits may be described in similar terms.

11. *Oscillation of Functions.*—The difference between the greatest and least of the numbers $f(a)$, $f(a+0)$, $\overline{f(a+0)}$, $\underline{f(a+0)}$, $f(a-0)$, when they are all finite, is called the "oscillation" or "fluctuation" of the function $f(x)$ at the point a . This difference is the limit for $h=0$ of the difference between the superior and inferior limits of the values of the function at points in the interval between $a-h$ and $a+h$. The corresponding difference for points in a finite interval is called the "oscillation of the function in the interval." When any of the four limits of indefiniteness is infinite the oscillation is infinite in the sense explained in § 7.

For the further classification of functions we divide the domain of the argument into partial intervals by means of points between the end-points. Suppose that the domain is the interval between a and b . Let intermediate points x_0, x_1, \dots, x_{n-1} be taken so that $b > x_{n-1} > x_{n-2} > \dots > x_1 > a$. We may devise a rule by which, as n increases indefinitely, all the differences $b-x_{n-1}, x_{n-1}-x_{n-2}, \dots, x_1-a$ tend to zero as a limit. The interval is then said to be divided into "indefinitely small partial intervals."

A function defined in an interval with the possible exception of isolated points may be such that the interval can be divided into a set of finite partial intervals within each of which the function is monotonous (§ 8). When this is the case the sum of the oscillations of the function in those partial intervals is finite, provided the function does not tend to become infinite. Further, in such a case the sum of the oscillations will remain below a fixed number for any mode of dividing the interval into indefinitely small partial intervals. A class of functions may be defined by the condition that the sum of the oscillations has this property, and such functions are said to have "restricted oscillation." Sometimes the phrase "limited fluctuation" is used. It can be proved that any function with restricted oscillation is capable of being expressed as the sum of two monotonous functions, of which one never increases and the other never diminishes throughout the interval. Such a function has a limit on the right and a limit on the left at every point of the interval. This class of functions includes all those which have a finite number of maxima and minima in a finite interval, and some which have an infinite number. It is to be noted that the class does not include all continuous functions.

12. *Differentiable Function.*—The idea of the differentiation of a continuous function is that of a process for measuring the rate of growth; the increment of the function is compared with the increment of the variable. If $f(x)$ is defined in an interval containing the point a , and $a-h$ and $a+h$ are points of the interval, the expression

$$\frac{f(a+h)-f(a)}{h} \quad (1)$$

represents a function of h , which we may call $\phi(h)$, defined at all points of an interval for h between $-h$ and h except the point a . Thus the four limits $\phi(+0)$, $\phi(+0)$, $\phi(-0)$, $\phi(-0)$ exist, and two or more of them may be equal. When the first two are equal either of them is the "progressive differential coefficient" of $f(x)$ at the point a ; when the last two are equal either of them is the "regressive differential coefficient" of $f(x)$ at a ; when all four are equal the function is said to be "differentiable" at a , and either of them is the "differential coefficient" of $f(x)$ at a , or the "first derived function" of $f(x)$ at a . It is denoted by $\frac{df(x)}{dx}$ or by $f'(x)$. In this case $\phi(h)$ has a definite limit at $h=0$, or is determinately infinite at $h=0$ (§ 7). The four limits here in question are called, after Dini, the "four derivatives" of $f(x)$ at a . In accordance with the notation for derived functions they may be denoted by

$$\overline{f'_+(a)}, f'_+(a), \overline{f'_-(a)}, f'_-(a).$$

A function which has a finite differential coefficient at all points of an interval is continuous throughout the interval, but if the differential coefficient becomes infinite at a point of the interval the function may or may not be continuous throughout the interval; on the other hand a function may be continuous without being differentiable. This result, comparable in importance, from the point of view of the general theory of functions, with the discovery of Fourier's theorem, is due to G. F. B. Riemann; but the failure of an attempt made by Ampère to prove that every continuous function must be differentiable may be regarded as the first step in the theory. Examples of analytical expressions which represent continuous functions that are not differentiable have been given by Riemann, Weierstrass, Darboux and Dini (see § 24). The most important theorem in regard to differentiable functions is the "theorem of intermediate value." (See INFINITESIMAL CALCULUS.)

13. *Analytic Function.*—If $f(x)$ and its first n differential coefficients, denoted by $f'(x), f''(x), \dots, f^{(n)}(x)$, are continuous in the interval between a and $a+h$, then

$$f(a+h) = f(a) + hf'(a) + \frac{h^2}{2!}f''(a) + \dots + \frac{h^{n-1}}{(n-1)!}f^{(n-1)}(a) + R_n$$

where R_n may have various forms, some of which are given in the article INFINITESIMAL CALCULUS. This result is known as "Taylor's theorem."

When Taylor's theorem leads to a representation of the function by means of an infinite series, the function is said to be "analytic" (cf. § 21).

14. *Ordinary Function.*—The idea of a curve representing a continuous function in an interval is that of a line which has the following properties: (1) the co-ordinates of a point of the curve are a value x of the argument and the corresponding value y of the function; (2) at every point the curve has a definite tangent; (3) the interval can be divided into a finite number of partial intervals within each of which the function is monotonous; (4) the property of monotony within partial intervals is retained after interchange of the axes of co-ordinates x and y . According to condition (2) y is a continuous and differentiable function of x , but this condition does not include conditions (3) and (4): there are continuous partially monotonous functions which are not differentiable, there are continuous differentiable functions which are not monotonous in any interval however small; and there are continuous, differentiable and monotonous functions which do not satisfy condition (4) (cf. § 24). A function which can be represented by a curve, in the sense explained above, is said to be "ordinary," and the curve is the graph of the function (§2). All analytic functions are ordinary, but not all ordinary functions are analytic.

15. *Integrable Function.*—The idea of integration is twofold. We may seek the function which has a given function as its differential coefficient, or we may generalize the question of finding the area of a curve. The first inquiry leads directly to the indefinite integral, the second directly to the definite integral. Following the second method we define "the definite integral of the function $f(x)$ through the interval between a and b " to be the limit of the sum

$$\sum_{r=1}^n f(x'_r)(x_r - x_{r-1})$$

when the interval is divided into ultimately indefinitely small partial intervals by points x_1, x_2, \dots, x_n . Here x'_r denotes any point in the r th partial interval, x_0 is put for a , and x_n for b . It can be shown that the limit in question is finite and independent of the mode of division into partial intervals, and of the choice of the points such as x'_r , provided (1) the function is defined for all points of the interval, and does not tend to become infinite at any of them; (2) for any one mode of division of the interval into ultimately indefinitely small partial intervals, the sum of the products of the oscillation of the function in each partial interval and the difference of the end-values of that partial interval has limit zero when n is increased indefinitely. When these conditions are satisfied the function is said to be "integrable" in the interval. The numbers a and b which limit the interval are usually called the "lower and upper limits." We shall call them the "nearer and further end-values." The above definition of integration was introduced by Riemann in his memoir on trigonometric series (1854). A still more general definition has been given by Lebesgue. As the more general definition cannot be made intelligible without the introduction of some rather recondite notions belonging to the theory of aggregates, we shall, in what follows, adhere to Riemann's definition.

We have the following theorems:—

1. Any continuous function is integrable.
2. Any function with restricted oscillation is integrable.
3. A discontinuous function is integrable if it does not tend to become infinite, and if the points at which the oscillation of the function exceeds a given number ϵ , however small, can be enclosed

in partial intervals the sum of whose breadths can be diminished indefinitely.

These partial intervals must be a set chosen out of some complete set obtained by the process used in the definition of integration.

4. The sum or product of two integrable functions is integrable.

As regards integrable functions we have the following theorems:

1. If S and I are the superior and inferior limits (or greatest and least values) of $f(x)$ in the interval between a and b , $\int_a^b f(x)dx$ is intermediate between $S(b-a)$ and $I(b-a)$.

2. The integral is a continuous function of each of the end-values.

3. If the further end-value b is variable, and if $\int_a^b f(x)dx = F(x)$, then if $f(x)$ is continuous at b , $F(x)$ is differentiable at b , and $F'(b) = f(b)$.

4. In case $f(x)$ is continuous throughout the interval $F(x)$ is continuous and differentiable throughout the interval, and $F'(x) = f(x)$ throughout the interval.

5. In case $f'(x)$ is continuous throughout the interval between a and b ,

$$\int_a^b f'(x)dx = f(b) - f(a).$$

6. In case $f(x)$ is discontinuous at one or more points of the interval between a and b , in which it is integrable,

$$\int_a^b f(x)dx$$

is a function of x , of which the four derivatives at any point of the interval are equal to the limits of indefiniteness of $f(x)$ at the point.

7. It may be that there exist functions which are differentiable throughout an interval in which their differential coefficients are not integrable; if, however, $F(x)$ is a function whose differential coefficient, $F'(x)$, is integrable in an interval, then

$$F(x) = \int_a^x F'(x)dx + \text{const.},$$

where a is a fixed point, and x a variable point, of the interval. Similarly, if any one of the four derivatives of a function is integrable in an interval, all are integrable, and the integral of either differs from the original function by a constant only.

The theorems (4), (6), (7) show that there is some discrepancy between the indefinite integral considered as the function which has a given function as its differential coefficient, and as a definite integral with a variable end-value.

We have also two theorems concerning the integral of the product of two integrable functions $f(x)$ and $\phi(x)$: these are known as "the first and second theorems of the mean." The first theorem of the mean is that, if $\phi(x)$ is one-signed throughout the interval between a and b , there is a number M intermediate between the superior and inferior limits, or greatest and least values, of $f(x)$ in the interval, which has the property expressed by the equation

$$M \int_a^b \phi(x)dx = \int_a^b f(x)\phi(x)dx.$$

The second theorem of the mean is that, if $f(x)$ is monotonous throughout the interval, there is a number ξ between a and b which has the property expressed by the equation

$$\int_a^b f(x)\phi(x)dx = f(a) \int_a^\xi \phi(x)dx + f(b) \int_\xi^b \phi(x)dx.$$

(See FOURIER'S SERIES.)

16. *Improper Definite Integrals.*—We may extend the idea of integration to cases of functions which are not defined at some point, or which tend to become infinite in the neighbourhood of some point, and to cases where the domain of the argument extends to infinite values. If c is a point in the interval between a and b at which $f(x)$ is not defined, we impose a restriction on the points x' of the definition: none of them is to be the point c .

This comes to the same thing as defining $\int_a^b f(x)dx$ to be

$$L\epsilon \int_a^{c-\epsilon} f(x)dx + L\epsilon \int_{c+\epsilon}^b f(x)dx, \tag{1}$$

where, to fix ideas, b is taken $> a$, and ϵ and δ are positive. The same definition applies to the case where $f(x)$ becomes infinite, or tends to become infinite, at c , provided both the limits exist. This definition may be otherwise expressed by saying that a partial interval containing the point c is omitted from the interval of integration, and a limit taken by diminishing the breadth of this partial interval indefinitely; in this form it applies to the cases where c is a or b .

Again, when the interval of integration is unlimited to the right, or extends to positively infinite values, we have as a definition

$$\int_a^\infty f(x)dx = L\epsilon \int_a^\infty f(x)dx,$$

provided this limit exists. Similar definitions apply to

$$\int_a^{-\infty} f(x)dx, \text{ and to } \int_{-\infty}^a f(x)dx.$$

All such definite integrals as the above are said to be "improper." For example, $\int_0^{\infty} \frac{\sin x}{x} dx$ is improper in two ways. It means

$$L\lim_{b \rightarrow \infty} \int_a^b f(x)dx, \text{ and } L\lim_{a \rightarrow -\infty} \int_a^b f(x)dx,$$

in which the positive number ϵ is first diminished indefinitely, and the positive number h is afterwards increased indefinitely.

The "theorems of the mean" (§ 15) require modification when the integrals are improper (see FOURIER'S SERIES).

When the improper definite integral of a function which becomes, or tends to become, infinite, exists, the integral is said to be "convergent." If $f(x)$ tends to become infinite at a point c in the interval between a and b , and the expression (1) does not exist, then the expression $\int_a^b f(x)dx$, which has no value, is called a "divergent integral," and it may happen that there is a definite value for

$$L\left\{ \int_a^c f(x)dx + \int_c^b f(x)dx \right\}$$

provided that ϵ and δ are connected by some definite relation, and both, remaining positive, tend to limit zero. The value of the above limit is then called a "principal value" of the divergent integral. Cauchy's principal value is obtained by making $\delta = \epsilon$, i.e. by taking the omitted interval so that the infinity is at its middle point. A divergent integral which has one or more principal values is sometimes described as "semi-convergent."

17. *Domain of a Set of Variables.*—The numerical continuum of n dimensions (C_n) is the aggregate that is arrived at by attributing simultaneous values to each of n variables x_1, x_2, \dots, x_n , these values being any real numbers. The elements of such an aggregate are called "points," and the numbers x_1, x_2, \dots, x_n the "co-ordinates" of a point. Denoting in general the points (x_1, x_2, \dots, x_n) and $(x'_1, x'_2, \dots, x'_n)$ by x and x' , the sum of the differences $|x_1 - x'_1| + |x_2 - x'_2| + \dots + |x_n - x'_n|$ may be denoted by $|x - x'|$ and called the "difference of the two points." We can in various ways choose out of the continuum an aggregate of points, which may be an infinite aggregate, and any such aggregate can be the "domain" of a "variable point." The domain is said to "extend to an infinite distance" if, after any number N , however great, has been specified, it is possible to find in the domain points of which one or more co-ordinates exceed N in absolute value. The "neighbourhood" of a point a for a (positive) number h is the aggregate constituted of all the points x , which are such that the "difference" denoted by $|x - a| < h$. If an infinite aggregate of points does not extend to an infinite distance, there must be at least one point a , which has the property that the points of the aggregate which are in the neighbourhood of a for any number h , however small, themselves constitute an infinite aggregate, and then the point a is called a "limiting point" of the aggregate; it may or may not be a point of the aggregate. An aggregate of points is "perfect" when all its points are limiting points of it, and all its limiting points are points of it; it is "connected" when, after taking any two points a, b of it, and choosing any positive number ϵ , however small, a number m and points $x', x'', \dots, x^{(m)}$ of the aggregate can be found so that all the differences denoted by $|x' - a|, |x'' - x'|, \dots, |b - x^{(m)}|$ are less than ϵ . A perfect connected aggregate is a *continuum*. This is G. Cantor's definition.

The definition of a continuum in C_n leaves open the question of the number of dimensions of the continuum, and a further explanation is necessary in order to define arithmetically what is meant by a "homogeneous part" H_n of C_n . Such a part would correspond to an interval in C_1 , or to an area bounded by a simple closed contour in C_2 ; and, besides being perfect and connected, it would have the following properties: (1) There are points of C_n , which are not points of H_n ; these form a complementary aggregate H'_n . (2) There are points "within" H_n ; this means that for any such point there is a neighbourhood consisting exclusively of points of H_n . (3) The points of H_n which do not lie "within" H_n are limiting points of H_n ; they are not points of H'_n , but the neighbourhood of any such point for any number h , however small, contains points within H_n and points of H'_n ; the aggregate of these points is called the

"boundary" of H_n . (4) When any two points a, b within H_n are taken, it is possible to find a number ϵ and a corresponding number m , and to choose points $x', x'', \dots, x^{(m)}$, so that the neighbourhood of a for ϵ contains x' , and consists exclusively of points within H_n , and similarly for x' and x'', x'' , and $x^{(m)}$, and b . Condition (3) would exclude such an aggregate as that of the points within and upon two circles external to each other and a line joining a point on one to a point on the other, and condition (4) would exclude such an aggregate as that of the points within and upon two circles which touch externally.

18. *Functions of Several Variables.*—A function of several variables differs from a function of one variable in that the argument of the function consists of a set of variables, or is a variable point in a C_n , when there are n variables. The function is definable by means of the domain of the argument and the rule of calculation. In the most important cases the domain of the argument is a homogeneous part H_n of C_n , with the possible exception of isolated points, and the rule of calculation is that the value of the function in any assigned part of the domain of the argument is that value which is assumed at the point by an assigned analytical expression. The limit of a function at a point a is defined in the same way as in the case of a function of one variable.

We take a positive fraction ϵ and consider the neighbourhood of a for h , and from this neighbourhood we exclude the point a , and we also exclude any point which is not in the domain of the argument. Then we take x and x' to be any two of the retained points in the neighbourhood. The function f has a limit at a if for any positive ϵ , however small, there is a corresponding h which has the property that $|f(x') - f(x)| < \epsilon$, whatever points x, x' in the neighbourhood of a for h we take (a excluded). For example, when there are two variables x_1, x_2 , and both are unrestricted, the domain of the argument is represented by a plane, and the values of the function are correlated with the points of the plane. The function has a limit at a point a , if we can mark out on the plane a region containing the point a within it, and such that the difference of the values of the function which correspond to any two points of the region [neither of the points being a] can be made as small as we please in absolute value by contracting all the linear dimensions of the region sufficiently. When the domain of the argument of a function of n variables extends to an infinite distance, there is a "limit at an infinite distance" if, after any number N , however small, has been specified, a number N' can be found which is such that $|f(x') - f(x)| < \epsilon$, for all points x and x' (of the domain) of which one or more co-ordinates exceed N in absolute value. In the case of functions of several variables great importance attaches to limits for a restricted domain. The definition of such a limit is verbally the same as the corresponding definition in the case of functions of one variable (§ 6). For example, a function of x_1 and x_2 may have a limit at $(x_1 = 0, x_2 = 0)$ if we first diminish x_1 without limit, keeping x_2 constant, and afterwards diminish x_2 without limit. Expressed in geometrical language, this process amounts to approaching the origin along the axis of x_2 . The definitions of superior and inferior limits, and of maxima and minima, and the explanations of what is meant by saying that a function of several variables becomes infinite, or tends to become infinite, at a point, are almost identical verbally with the corresponding definitions and explanations in the case of a function of one variable (§ 7). The definition of a continuous function (§ 9) admits of immediate extension; but it is very important to observe that a function of two or more variables may be a continuous function of each of the variables, when the rest are kept constant, without being a continuous function of its argument. For example, a function of x and y may be defined by the conditions that when $x = 0$ it is zero whatever value y may have, and when $x \neq 0$ it has the value of $\sin \left[\frac{1}{2} \tan^{-1} \left(\frac{y}{x} \right) \right]$. When y has any particular value this function is a continuous function of x , and, when x has any particular value this function is a continuous function of y ; but the function of x and y is discontinuous at $(x = 0, y = 0)$.

19. *Differentiation and Integration.*—The definition of partial differentiation of a function of several variables presents no difficulty. The most important theorems concerning differentiable functions are the "theorem of the total differential," the theorem of the interchangeability of the order of partial differentiations, and the extension of Taylor's theorem (see INFINITESIMAL CALCULUS).

With a view to the establishment of the notion of integration through a domain, we must define the "extent" of the domain. Take first a domain consisting of the point a and all the points x for which $|x - a| < \frac{1}{2}h$, where h is a chosen positive number; the extent of this domain is h^n , n being the number of variables; such a domain may be described as a "square," and the number h may be called its "breadth"; it is a homogeneous part of the

numerical continuum of n dimensions, and its boundary consists of all the points for which $|x-a| = \frac{1}{2}k$. Now the points of any domain, which does not extend to an infinite distance, may be assigned to a finite number m of square domains of finite breadths, so that every point of the domain is either within one of these square domains or on its boundary, and so that no point is within two of the square domains; also we may devise a rule by which, as the number m increases indefinitely, the breadths of all the square domains are diminished indefinitely. When this process is applied to a homogeneous part, H , of the numerical continuum C_n , then, at any stage of the process, there will be some square domains of which all the points belong to H , and there will generally be others of which some, but not all, of the points belong to H . As the number m is increased indefinitely the sums of the extents of both these categories of square domains will tend to definite limits, which cannot be negative; when the second of these limits is zero the domain H is said to be "measurable," and the first of these limits is its "extent"; it is independent of the rule adopted for constructing the square domains and contracting their breadths. The notion thus introduced may be adapted by suitable modifications to continua of lower dimensions in C_n .

The integral of a function $f(x)$ through a measurable domain H , which is a homogeneous part of the numerical continuum of n dimensions, is defined in just the same way as the integral through an interval, the extent of a square domain taking the place of the difference of the end-values of a partial interval; and the condition of integrability takes the same form as in the simple case. In particular, the condition is satisfied when the function is continuous throughout the domain. The definition of an integral through a domain may be adapted to any domain of measurable extent. The extensions to "improper" definite integrals may be made in the same way as for a function of one variable; in the particular case of a function which tends to become infinite at a point in the domain of integration, the point is enclosed in a partial domain which is omitted from the integration, and a limit is taken when the extent of the omitted partial domain is diminished indefinitely; a divergent integral may have different (principal) values for different modes of contracting the extent of the omitted partial domain. In applications to mathematical physics great importance attaches to convergent integrals and to principal values of divergent integrals. For example, any component of magnetic force at a point within a magnet, and the corresponding component of magnetic induction at the same point are expressed by different principal values of the same divergent integral. Delicate questions arise as to the possibility of representing the integral of a function of n variables through a domain H_n , as a repeated integral, of evaluating it by successive integrations with respect to the variables one at a time and of interchanging the order of such integrations. These questions have been discussed very completely by C. Jordan, and we may quote the result that all the transformations in question are valid when the function is continuous throughout the domain.

20. *Representation of Functions in General.*—We have seen that the notion of a function is wider than the notion of an analytical expression, and that the same function may be "represented" by one expression in one part of the domain of the argument and by some other expression in another part of the domain (§ 5). Thus there arises the general problem of the representation of functions. The function may be given by specifying the domain of the argument and the rule of calculation, or else the function may have to be determined in accordance with certain conditions; for example, it may have to satisfy in a prescribed domain an assigned differential equation. In either case the problem is to determine, when possible, a single analytical expression which shall have the same value as the function at all points in the domain of the argument. For the representation of most functions for which the problem can be solved recourse must be had to limiting processes. Thus we may utilize infinite series, or infinite products, or definite integrals; or again we may represent a function of one variable as the limit of an expression containing two variables in a domain in which one variable remains constant and another varies. An example of this process is afforded by the expression $L_n = ax/(x^2y+1)$, which represents a function of x vanishing at $x=0$ and at all other values of x having the value of $1/x$. The method of series falls under this more general process (cf. § 6). When the terms u_1, u_2, \dots of a series are functions of a variable

x , the sum s_n of the first n terms of the series is a function of x and n ; and, when the series is convergent, its sum, which is $L_n = s_\infty$, can represent a function of x . In most cases the series converges for some values of x and not for others, and the values for which it converges form the "domain of convergence." The sum of the series represents a function in this domain.

The apparently more general method of representation of a function of one variable as the limit of a function of two variables has been shown by R. Baire to be identical in scope with the method of series, and it has been developed by him so as to give a very complete account of the possibility of representing functions by analytical expressions. For example, he has shown that Riemann's totally discontinuous function, which is equal to 1 when x is rational and to 0 when x is irrational, can be represented by an analytical expression. An infinite process of a different kind has been adapted to the problem of the representation of a continuous function by T. Broden. He begins with a function having a graph in the form of a regular polygon, and interpolates additional angular points in an ordered sequence without limit. The representation of a function by means of an infinite product falls clearly under Baire's method, while the representation by means of a definite integral is analogous to Broden's method. As an example of these two latter processes we may cite the Gamma function $\Gamma(x)$ defined for positive values of x by the definite integral

$$\int_0^\infty e^{-t} t^{x-1} dt,$$

or by the infinite product

$$L_n = n^x/x(1+x)(1+\frac{1}{2}x) \dots \left(1 + \frac{x}{n-1}\right).$$

The second of these expressions avails for the representation of the function at all points at which x is not a negative integer.

21. *Power Series.*—Taylor's theorem leads in certain cases to a representation of a function by an infinite series. We have under certain conditions (§ 13)

$$f(x) = f(a) + \sum_{r=1}^{\infty} \frac{(x-a)^r}{r!} f^{(r)}(a) + R_n,$$

and this becomes

$$f(x) = f(a) + \sum_{r=1}^{\infty} \frac{(x-a)^r}{r!} f^{(r)}(a),$$

provided that (a) a positive number k can be found so that at all points in the interval between a and $a+k$ (except these points) $f(x)$ has continuous differential coefficients of all finite orders, and at a has progressive differential coefficients of all finite orders; (b) Cauchy's form of the remainder R_n , viz. $\frac{(x-a)^n}{(n-1)!} (t-\theta)^{n-1} f^{(n)}(a+\theta(x-a))$, has the limit zero when n increases indefinitely, for all values of θ between 0 and 1, and for all values of x in the interval between a and $a+k$, except possibly $a+k$. When these conditions are satisfied, the series (1) represents the function at all points of the interval between a and $a+k$, except possibly $a+k$, and the function is "analytic" (§ 13) in this domain. Obvious modifications admit of extension to an interval between a and $a-k$, or between $a-k$ and $a+k$. When a series of the form (1) represents a function it is called "the Taylor's series for the function."

Taylor's series is a power series, i.e. a series of the form $\sum a_n(x-a)^n$.

As regards power series we have the following theorems:

1. If the power series converges at any point except a there is a number k which has the property that the series converges absolutely in the interval between $a-k$ and $a+k$, with the possible exception of one or both end-points.

2. The power series represents a continuous function in its domain of convergence (the end-points may have to be excluded).

3. This function is analytic in the domain, and the power series representing it is the Taylor's series for the function.

The theory of power series has been developed chiefly from the point of view of the theory of functions of complex variables.

22. *Uniform Convergence.*—We shall suppose that the domain of convergence of an infinite series of functions is an interval with the possible exception of isolated points. Let $f(x)$ be the sum of the series at any point x of the domain, and $f_n(x)$ the sum of the first $n+1$ terms. The condition of convergence at a point a is that, after any positive number ϵ , however small, has been specified, it must be possible to find a number n so that $|f_n(a) - f(a)| < \epsilon$ for all values of m and p which exceed n . The sum, $f(a)$, is the limit of the sequence of numbers $f_n(a)$ at

$n = \infty$. The convergence is said to be "uniform" in an interval if, after specification of ϵ , the same number n suffices at all points of the interval to make $|f(x) - f_n(x)| < \epsilon$ for all values of x which exceed n . The numbers n corresponding to any ϵ , however small, are all finite, but, when ϵ is less than some fixed finite number, they may have an infinite superior limit (§ 7); when this is the case there must be at least one point, a , of the interval which has the property that, whatever number N we take, ϵ can be taken so small that, at some point in the neighbourhood of a , n must be taken $> N$ to make $|f(x) - f_n(x)| < \epsilon$ when $m > n$; then the series does not converge uniformly in the neighbourhood of a . The distinction may be otherwise expressed thus: Choose ϵ first and a afterwards, then the number n is finite; choose ϵ first and allow a to vary, then the number n becomes a function of a , which may tend to become infinite, or may remain below a fixed number; if such a fixed number exists, however small ϵ may be, the convergence is uniform.

For example, the series $\sin x - \frac{1}{2} \sin 2x + \frac{1}{3} \sin 3x - \dots$ is convergent for all real values of x , and, when $x > -\pi$ its sum is $\frac{1}{2} x$; but, when x is but a little less than π , the number of terms which must be taken in order to bring the sum at all near to the value of $\frac{1}{2} x$ is very large, and this number tends to increase indefinitely as x approaches π . This series does not converge uniformly in the neighbourhood of $x = \pi$. Another example is afforded by the series $\sum_{n=0}^{\infty} \frac{\pi x}{n^2 x^2 + 1} - \frac{(n+1)x}{(n+1)x^2 + 1}$, of which the remainder after n terms is $\frac{\pi x}{(n^2 x^2 + 1)}$. If we put $x = 1/n$, for any value of n , however great, the remainder is $\frac{1}{2}$; and the number of terms required to be taken to make the remainder tend to zero depends upon the value of x when x is near to zero—it must, in fact, be large compared with $1/x$. The series does not converge uniformly in the neighbourhood of $x = 0$.

As regards series whose terms represent continuous functions we have the following theorems:

(1) If the series converges uniformly in an interval it represents a function which is continuous throughout the interval.

(2) If the series represents a function which is discontinuous in an interval it cannot converge uniformly in the interval.

(3) A series which does not converge uniformly in an interval may nevertheless represent a function which is continuous throughout the interval.

(4) A power series converges uniformly in any interval contained within its domain of convergence, the end-points being excluded.

(5) If $\sum_{r=0}^{\infty} f_r(x) = f(x)$ converges uniformly in the interval between a and b

$$\int_a^b f(x) dx = \sum_{r=0}^{\infty} \int_a^b f_r(x) dx,$$

or a series which converges uniformly may be integrated term by term.

(6) If $\sum_{r=0}^{\infty} f_r(x)$ converges uniformly in an interval, then

$\sum_{r=0}^{\infty} f_r(x)$ converges in the interval, and represents a continuous

differentiable function, $\phi(x)$; in fact we have

$$\phi'(x) = \sum_{r=0}^{\infty} f_r'(x),$$

or a series can be differentiated term by term if the series of derived functions converges uniformly.

A series whose terms represent functions which are not continuous throughout an interval may converge uniformly in the interval. If $\sum_{r=0}^{\infty} f_r(x) = f(x)$, is such a series, and if all the functions $f_r(x)$ have limits at a , then $f(x)$ has a limit at a , which is $\sum_{r=0}^{\infty} L f_r(x)$. A similar theorem holds for limits on the left or on the right.

23. *Fourier's Series*.—An extensive class of functions admit of being represented by series of the form

$$a_0 + \sum_{n=1}^{\infty} \left(a_n \cos \frac{n\pi x}{c} + b_n \sin \frac{n\pi x}{c} \right), \quad (i.)$$

and the rule for determining the coefficients a_n , b_n of such a series, in order that it may represent a given function $f(x)$ in

the interval between $-c$ and c , was given by Fourier, viz. we have

$$a_0 = \frac{1}{2c} \int_{-c}^c f(x) dx, \quad a_n = \frac{1}{c} \int_{-c}^c f(x) \cos \frac{n\pi x}{c} dx, \quad b_n = \frac{1}{c} \int_{-c}^c f(x) \sin \frac{n\pi x}{c} dx.$$

The interval between $-c$ and c may be called the "periodic interval," and we may replace it by any other interval, e.g. that between 0 and 1 , without any restriction of generality. When this is done the sum of the series takes the form

$$L \sum_{n=0}^{\infty} \int_0^1 f(x) \cos [2n\pi(x-x')] dx,$$

and this is

$$L \sum_{n=0}^{\infty} \int_0^1 f(x) \frac{\sin \frac{(2n+1)\pi(x-x')}{2}}{\sin \frac{(x-x')\pi}{2}} dx. \quad (ii.)$$

Fourier's theorem is that, if the periodic interval can be divided into a finite number of partial intervals within each of which the function is ordinary (§ 14), the series represents the function within each of those partial intervals. In Fourier's time a function of this character was regarded as completely arbitrary.

By a discussion of the integral (ii.) based on the Second Theorem of the Mean (§ 15) it can be shown that, if $f(x)$ has restricted oscillation in the interval (§ 11), the sum of the series is equal to $\frac{1}{2} [f(x+0) + f(x-0)]$ at any point x within the interval, and that it is equal to $\frac{1}{2} [f(+0) + f(-0)]$ at each end of the interval. (See the article *FOURIER'S SERIES*.) It therefore represents the function at any point of the periodic interval at which the function is continuous (except possibly the end-points), and has a definite value at each point of discontinuity. The condition of restricted oscillation includes all the functions contemplated in the statement of the theorem and some others. Further, it can be shown that, in any partial interval throughout which $f(x)$ is continuous, the series converges uniformly, and that no series of the form (i), with coefficients other than those determined by Fourier's rule, can represent the function at all points, except points of discontinuity, in the same periodic interval. The result can be extended to a function $f(x)$ which tends to become infinite at a finite number of points a of the interval, provided (1) $f(x)$ tends to become determinately infinite at each of the points a , (2) the improper definite integral of $f(x)$ through the interval is convergent, (3) $f(x)$ has not an infinite number of discontinuities or of maxima or minima in the interval.

24. *Representation of Continuous Functions by Series*.—If the series for $f(x)$ formed by Fourier's rule converges at the point a of the periodic interval, and if $f(x)$ is continuous at a , the sum of the series is $f(a)$; but it has been proved by P. du Bois Reymond that the function may be continuous at a , and yet the series formed by Fourier's rule may be divergent at a . Thus some continuous functions do not admit of representation by Fourier's series. All continuous functions, however, admit of being represented with arbitrarily close approximation in either of two forms, which may be described as "terminated Fourier's series" and "terminated power series," according to the two following theorems:

(1) If $f(x)$ is continuous throughout the interval between 0 and 2π , and if any positive number ϵ however small is specified, it is possible to find an integer n , so that the difference between the value of $f(x)$ and the sum of the first n terms of the series for $f(x)$, formed by Fourier's rule with periodic interval from 0 to 2π , shall be less than ϵ at all points of the interval. This result can be extended to a function which is continuous in any given interval.

(2) If $f(x)$ is continuous throughout an interval, and any positive number ϵ however small is specified, it is possible to find an integer n and a polynomial in x of the n th degree, so that the difference between the value of $f(x)$ and the value of the polynomial shall be less than ϵ at all points of the interval.

Again it can be proved that, if $f(x)$ is continuous throughout a given interval, polynomials in x of finite degrees can be found, so as to form an infinite series of polynomials whose sum is equal to $f(x)$ at all points of the interval. Methods of representation of continuous functions by infinite series of rational fractional functions have also been devised.

Particular interest attaches to continuous functions which are not differentiable. Weierstrass gave as an example the function represented by the series $\sum_{n=0}^{\infty} a^n \cos(b^n \pi x)$, where a is positive and less than unity, and b is an odd integer exceeding $(1 + \frac{1}{a})/a$. It can be shown that this series is uniformly convergent in every interval,

and that the continuous function $f(x)$ represented by it has the property that there is, in the neighbourhood of any point x_0 , an infinite aggregate of points x' , having x_0 as a limiting point, for which $|f(x') - f(x_0)| / (x' - x_0)$ tends to become infinite with one sign when $x' - x_0$ approaches zero through positive values, and infinite with the opposite sign when $x' - x_0$ approaches zero through negative values. Accordingly the function is not differentiable at any point. The definite integral of such a function $f(x)$ through the interval between a fixed point and a variable point x , is a continuous differentiable function $F(x)$, for which $F'(x) = f(x)$; and, if $f(x)$ is one-signed throughout any interval $F(x)$ is monotonous throughout that interval, but yet $F(x)$ cannot be represented by a curve. In any interval, however small, the tangent would have to take the same direction for infinitely many points, and yet there is no interval in which the tangent has everywhere the same direction. Further, it can be shown that all functions which are everywhere continuous and nowhere differentiable are capable of representation by series of the form $\sum a_n \phi_n(x)$, where $\sum a_n$ is an absolutely convergent series of numbers, and $\phi_n(x)$ is an analytic function whose absolute value never exceeds unity.

25. *Calculations with Divergent Series.*—When the series described in (1) and (2) of § 24 diverge, they may, nevertheless, be used for the approximate numerical calculation of the values of the function, provided the calculation is not carried beyond a certain number of terms. Expansions in series which have the property of representing a function approximately when the expansion is not carried too far are called "asymptotic expansions." Sometimes they are called "semi-convergent series"; but this term is avoided in the best modern usage, because it is often used to describe series whose convergence depends upon the order of the terms, such as the series $1 - \frac{1}{2} + \frac{1}{3} - \dots$.

In general, let $f_0(x) + f_1(x) + \dots$ be a series of functions which does not converge in a certain domain. It may happen that, if any number ϵ , however small, is first specified, a number n can afterwards be found so that, at a point a of the domain, the value $f(a)$ of a certain function $f(x)$ is connected with the sum of the first $n+1$

terms of the series by the relation $|f(a) - \sum_{k=0}^n f_k(a)| < \epsilon$. It must also happen that, if any number N , however great, is specified, a number $n' (> n)$ can be found so that, for all values of m which exceed n' , $|\sum_{k=0}^m f_k(a)| > N$. The divergent series $f_0(x) + f_1(x) + \dots$ is then an asymptotic expansion for the function $f(x)$ in the domain.

The best known example of an asymptotic expansion is Stirling's formula for $n!$ when n is large, viz.

$$n! = \sqrt{(2\pi)} n^{n+\frac{1}{2}} e^{-n} \Gamma(n),$$

where θ is some number lying between 0 and 1. This formula is included in the asymptotic expansion for the Gamma function. We have in fact

$$\log \Gamma(x) = (x-1) \log x - x + \frac{1}{2} \log 2\pi + \theta(x),$$

where $\theta(x)$ is the function defined by the definite integral

$$\theta(x) = \int_0^{\infty} \{(1-e^{-t})^{-1} - t^{-1} - \frac{1}{2}t\} e^{-xt} dt.$$

The multiplier of e^{-t} under the sign of integration can be expanded in the power series

$$\frac{B_1}{2!} - \frac{B_2}{4!} t + \frac{B_3}{6!} t^2 - \dots,$$

where B_1, B_2, \dots are "Bernoulli's numbers" given by the formula

$$B_n = \frac{2.2m!}{(2\pi)^{2m}} \sum_{r=1}^{2m} (r^{-2m}).$$

When the series is integrated term by term, the right-hand member of the equation for $\theta(x)$ takes the form

$$\frac{B_1}{1.2} - \frac{B_2}{3.4} \frac{1}{x^2} + \frac{B_3}{5.6} \frac{1}{x^3} - \dots$$

This series is divergent; but, if it is stopped at any term, the difference between the sum of the series so terminated and the value of $\theta(x)$ is less than the last of the retained terms. Stirling's formula is obtained by retaining the first term only. Other well-known examples of asymptotic expansions are afforded by the descending series for Bessel's functions. Methods of obtaining such expansions for the solutions of linear differential equations of the second order were investigated by G. G. Stokes (*Math. and Phys. Papers*, vol. ii, p. 329), and a general theory of asymptotic expansions has been developed by H. Poincaré. A still more general theory of divergent series, and of the conditions in which they can be used, as above, for the purposes of approximate calculation has been worked out by É. Borel. The great merit of asymptotic expansions is that they admit of addition, subtraction, multiplication and division, term by term, in the same way as absolutely convergent series, and they admit also of integration term by term; that is to say, the results of such operations are

asymptotic expansions for the sum, difference, product, quotient, or integral, as the case may be.

26. *Interchange of the Order of Limiting Operations.*—When we require to perform any limiting operation upon a function which is itself represented by the result of a limiting process, the question of the possibility of interchanging the order of the two processes always arises. In the more elementary problems of analysis it generally happens that such an interchange is possible; but in general it is not possible. In other words, the performance of the two processes in different orders may lead to two different results; or the performance of them in one of the two orders may lead to no result. The fact that the interchange is possible under suitable restrictions for a particular class of operations is a theorem to be proved.

Among examples of such interchanges we have the differentiation and integration of an infinite series term by term (§ 22), and the differentiation and integration of a definite integral with respect to a parameter by performing the like processes upon the subject of integration (§ 19). As a last example we may take the limit of the sum of an infinite series of functions at a point in the domain of

convergence. Suppose that the series $\sum_{k=0}^{\infty} f_k(x)$ represents a function $f(x)$ in an interval containing a point a , and that each of the functions $f_k(x)$ has a limit at a . If we first put $x = a$, and then sum the series, we have the value $f(a)$; if we first sum the series for any x , and afterwards take the limit of the sum at $x = a$, we have the limit of $f(x)$ at a : if we first replace each function $f_k(x)$ by its limit at a , and then sum the series, we may arrive at a value different from either of the foregoing. If the function $f(x)$ is continuous at a , the first and second results are equal; if the functions $f_k(x)$ are all continuous at a , the first and third results are equal; if the series is uniformly convergent, the second and third results are equal. This last case is an example of the interchange of the order of two limiting operations, and a sufficient, though not always a necessary, condition, for the validity of such an interchange will usually be found in some suitable extension of the notion of uniform convergence.

AUTHORITIES.—Among the more important treatises and memoirs connected with the subject are: R. Baire, *Fonctions discontinues* (Paris, 1908); O. Biermann, *Analytische Funktionen* (Leipzig, 1887); É. Borel, *Théorie des fonctions* (Paris, 1898) (containing an introductory account of the Theory of Aggregates), and *Séries divergentes* (Paris, 1901), also *Fonctions de variables réelles* (Paris, 1905); T. J. A. Bromwich, *Introduction to the Theory of Infinite Series* (London, 1908); H. S. Carslaw, *Introduction to the Theory of Fourier's Series and Integrals* (London, 1906); U. Dini, *Funzioni e. reellen Grösse* (Leipzig, 1892), and *Series di Fourier* (Pisa, 1880); A. Genocchi u. G. Peano, *Diff.- u. Int.-Rechnung* (Leipzig, 1899); J. Harkness and F. Morley, *Introduction to the Theory of Analytic Functions* (London, 1898); A. Harnack, *Diff. and Int. Calculus* (London, 1891); E. W. Hobson, *The Theory of Functions of a real Variable and the Theory of Fourier's Series* (Cambridge, 1907); C. Jordan, *Cours d'analyse* (Paris, 1893-1896); L. Kronecker, *Théorie d. einfachen u. vielfachen Integrale* (Leipzig, 1894); H. Lebesgue, *Leçons sur l'intégration* (Paris, 1904); M. Pasch, *Diff.- u. Int.-Rechnung* (Leipzig, 1882); E. Picard, *Traité d'analyse* (Paris, 1891); O. Stolz, *Allgemeine Arithmetik* (Leipzig, 1885), and *Diff.- u. Int.-Rechnung* (Leipzig, 1893-1899); J. Tannery, *Théorie des fonctions* (Paris, 1886); W. H. and G. C. Young, *The Theory of Sets of Points* (Cambridge, 1906); *Proden*, "Stetige Funktionen e. reellen Veränderlichen," *Crelle*, Bd. cxviii.; G. Cantor, A series of memoirs on the "Theory of Aggregates" and on "Trigonometric series" in *Acta Math.* ii, ii, vii, and *Math. Ann.* Bde. iv.-xxiii.; Darboux, "Fonctions discontinues," *Ann. Sci. École normale sup.* (2), t. iv.; Dedekind, *Was sind u. was sollen d. Zahlen?* (Brunswick, 1887); Dirichlet, "Convergence des séries trigonométriques," *Crelle*, Bd. iv.; P. Du Bois Reymond, *Allgemeine Functionentheorie* (Tübingen, 1882), and many memoirs in *Crelle* and in *Math. Ann.*; Heine, "Functionenlehre," *Crelle*, Bd. lxxiv.; J. Pierpont, *The Theory of Functions of a real Variable* (Boston, 1905); F. Klein, "Allgemeine Functionsbegriff," *Math. Ann.* Bd. xxii.; W. F. Osgood, "On Uniform Convergence," *Amer. J. of Math.* vol. xix.; Pincherle, "Funzioni analitiche secondo Weierstrass," *Giorn. di mat.* t. xviii.; Pringsheim, "Bedingungen d. Taylorischen Lehrsatzes," *Math. Ann.* Bd. xliii.; Riemann, "Trigonometrische Reihe," *Ges. Werke* (Leipzig, 1876); Schoenflies, "Entwicklung d. Lehre v. d. Punktmannigfaltigkeiten," *Jahresber. d. deutschen Math.-Vereinigung*, Bd. viii.; Study, *Memoir on Functions with Restricted Oscillation*, *Math. Ann.* Bd. xlvii.; Weierstrass, *Memoir on "Continuous Functions that are not Differentiable"*, *Ges. math. Werke*, Bd. ii, p. 71, (Berlin, 1895), and on the "Representation of Arbitrary Functions," *ibid.* Bd. iii, p. 1; W. H. Young, "On Uniform and Non-uniform Convergence," *Proc. London Math. Soc.* (Ser. 2) t. 6. Further information and very full references will be found in the articles by Pringsheim, Schoenflies and Voss in the *Encyclopädie der math. Wissenschaften*, Bde. i., ii. (Leipzig, 1898, 1899). (A. E. H. L.)

II.—FUNCTIONS OF COMPLEX VARIABLES

In the preceding section the doctrine of functionality is discussed with respect to real quantities; in this section the theory when complex or imaginary quantities are involved receives treatment. The following abstract explains the arrangement of the subject matter: (§ 1), *Complex numbers*, states what a complex number is, (§ 2), *Plotting of simple expressions involving complex numbers*, illustrates the meaning in some simple cases, introducing the notion of conformal representation and proving that an algebraic equation has complex, if not real, roots; (§ 3), *Limiting operations*, defines certain simple functions of a complex variable which are obtained by passing to a limit, in particular the exponential function, and the generalized logarithm, here denoted by $\lambda(z)$; (§ 4), *Functions of a complex variable in general*, after explaining briefly what is to be understood by a region of the complex plane and by a path, and expounding a logical principle of some importance, gives the accepted definition of a function of a complex variable, establishes the existence of a complex integral, and proves Cauchy's theorem relating thereto; (§ 5), *Applications*, considers the differentiation and integration of series of functions of a complex variable, proves Laurent's theorem, and establishes the expansion of a function of a complex variable as a power series, leading, in (§ 6), *Singular points*, to a definition of the region of existence and singular points of a function of a complex variable, and thence, in (§ 7), *Monogenic Functions*, to what the writer believes to be the simplest definition of a function of a complex variable, that of Weierstrass; (§ 8), *Some elementary properties of single valued functions*, first discusses the meaning of a pole, proves that a single valued function with only poles is rational, gives Mittag-Leffler's theorem, and Weierstrass's theorem for the primary factors of an integral function, stating generalized forms for these, leading to the theorem of (§ 9), *The construction of a monogenic function with a given region of existence*, with which is connected (§ 10), *Expression of a monogenic function by rational functions in a given region*, of which the method is applied in (§ 11), *Expression of $(1-z)^{-1}$ by polynomials*, to a definite example, used here to obtain (§ 12), *An expansion of an arbitrary function by means of a series of polynomials, over a star region*, also obtained in the original manner of Mittag-Leffler; (§ 13), *An application of Cauchy's theorem to the determination of definite integrals*, gives two examples of this method; (§ 14), *Doubly Periodic Functions*, is introduced at this stage as furnishing an excellent example of the preceding principles. The reader who wishes to approach the matter from the point of view of Integral Calculus should first consult the section (§ 20) below, dealing with *Elliptic Integrals*; (§ 15), *Potential Functions, Conformal representation in general*, gives a sketch of the connexion of the theory of potential functions with the theory of conformal representation, enunciating the Schwarz-Christoffel theorem for the representation of a polygon, with the application to the case of an equilateral triangle; (§ 16), *Multiple-valued Functions, Algebraic Functions*, deals for the most part with algebraic functions, proving the residue theorem, and establishing that an algebraic function has a definite Order; (§ 17), *Integrals of Algebraic Functions*, enunciating Abel's theorem; (§ 18), *Indeterminateness of Algebraic Integrals*, deals with the periods associated with an algebraic integral, establishing that for an elliptic integral the number of these is two; (§ 19), *Reversion of an algebraic integral*, mentions a problem considered below in detail for an elliptic integral; (§ 20), *Elliptic Integrals*, considers the algebraic reduction of any elliptic integral to one of three standard forms, and proves that the function obtained by reversion is single-valued; (§ 21), *Modular Functions*, gives a statement of some of the more elementary properties of some functions of great importance, with a definition of Automorphic Functions, and a hint of the connexion with the theory of linear differential equations; (§ 22), *A property of integral functions, deduced from the theory of modular functions*, proves that there cannot be more than one value not assumed by an integral function, and gives the basis of the well-known expression of the modulus of the elliptic functions in terms of the ratio of the

periods; (§ 23), *Geometrical applications of Elliptic Functions*, shows that any plane curve of deficiency unity can be expressed by elliptic functions, and gives a geometrical proof of the addition theorem for the function $\mathfrak{P}(u)$; (§ 24), *Integrals of Algebraic Functions in connexion with the theory of plane curves*, discusses the generalization to curves of any deficiency, (§ 25), *Monogenic Functions of several independent variables*, describes briefly the beginnings of this theory, with a mention of some fundamental theorems: (§ 26), *Multiply-Periodic Functions and the Theory of Surfaces*, attempts to show the nature of some problems now being actively pursued.

Beside the brevity necessarily attaching to the account here given of advanced parts of the subject, some of the more elementary results are stated only, without proof, as, for instance: the monogeneity of an algebraic function, no reference being made, moreover, to the cases of differential equations whose integrals are monogenic, that a function possessing an algebraic addition theorem is necessarily an elliptic function (or a particular case of such); that any area can be conformally represented on a half plane, a theorem requiring further much more detailed consideration of the meaning of *area* than we have given; while the character and properties, including the connectivity, of a Riemann surface have not been referred to. The theta functions are referred to only once, and the principles of the theory of Abelian Functions have been illustrated only by the developments given for elliptic functions.

§ 1. *Complex Numbers*.—Complex numbers are numbers of the form $x+iy$, where x, y are ordinary real numbers, and i is a symbol imagined capable of combination with itself and the ordinary real numbers, by way of addition, subtraction, multiplication and division, according to the ordinary commutative, associative and distributive laws; the symbol i is further such that $i^2 = -1$.

Taking in a plane two rectangular axes Ox, Oy , we assume that every point of the plane is definitely associated with two real numbers x, y (its co-ordinates) and conversely; thus any point of the plane is associated with a single complex number; in particular, for every point of the axis Ox , for which $y=0$, the associated number is an ordinary real number; the complex numbers thus include the real numbers. The axis Ox is often called the real axis, and the axis Oy the imaginary axis. If P be the point associated with the complex variable $z=x+iy$, the distance OP be called r , and the positive angle less than 2π between Ox and OP be called θ , we may write $z=r(\cos\theta+i\sin\theta)$; then r is called the modulus or absolute value of z and often denoted by $|z|$ and θ is called the phase or amplitude of z , and often denoted by $\text{ph}(z)$; strictly the phase is ambiguous by additive multiples of 2π . If $z'=x'+iy'$ be represented by P' , the complex argument $z'+z$ is represented by a point P'' obtained by drawing from P' a line equal to and parallel to OP ; the geometrical representation involves for its validity certain properties of the plane; as, for instance, the equation $z'+z=z+z'$ involves the possibility of constructing a parallelogram (with OP'' as diagonal). It is important constantly to bear in mind, what is capable of easy algebraic proof (and geometrically is Euclid's proposition III. 7), that the modulus of a sum or difference of two complex numbers is generally less than (and is never greater than) the sum of their moduli, and is greater than (or equal to) the difference of their moduli; the former statement thus holds for the sum of any number of complex numbers. We shall write $E(\theta)$ for $\cos\theta+i\sin\theta$; it is at once verified that $E(i\alpha) \cdot E(i\beta) = E(i(\alpha+\beta))$, so that the phase of a product of complex quantities is obtained by addition of their respective phases.

§ 2. *Plotting and Properties of Simple Expressions involving a Complex Number*.—If we put $\zeta=(z-i)/(z+i)$, and, putting $\zeta=\xi+i\eta$, take a new plane upon which ξ, η are rectangular co-ordinates, the equations $\xi=(x^2+y^2-1)/[x^2+(y+1)^2]$, $\eta=-2xy/[x^2+(y+1)^2]$ will determine, corresponding to any point of the first plane, a point of the second plane. There is the one exception of $z=-i$, that is, $x=0, y=-1$, of which the corresponding point is at infinity. It can now be easily proved that as z describes the real axis in its plane the point ζ describes once a circle of radius unity, with centre at $\zeta=0$, and that there is a definite correspondence of point to point between points in the z -plane which are above the real axis and points of the ζ -plane which are interior to this circle; in particular $z=i$ corresponds to $\zeta=0$.

Moreover, ζ being a rational function of z , both ξ and η are continuous differentiable functions of x and y , save when ζ is infinite:

writing $f = f(x, y) = f(z - iy, y)$, the fact that this is really independent of y leads at once to $\partial f/\partial x + i\partial f/\partial y = 0$, and hence to

$$\frac{\partial \xi}{\partial x} - \frac{\partial \eta}{\partial y} + \frac{\partial \xi}{\partial y} - \frac{\partial \eta}{\partial x} = 0;$$

so that ξ is not any arbitrary function of x, y , and when ξ is known η is determinate save for an additive constant. Also, in virtue of these equations, if f, f' be the values of f corresponding to two near values of z , say s and s' , the ratio $(f' - f)/(s' - s)$ has a definite limit when $s' \rightarrow s$, independent of the ultimate phase of $s' - s$, this limit being therefore equal to $\partial f/\partial z$, that is, $\partial \xi/\partial x + i\partial \eta/\partial x$. Geometrically this fact is interpreted by saying that if two curves in the z -plane intersect at a point P , at which both the differential coefficients $\partial \xi/\partial x, \partial \eta/\partial x$ are not zero, and P', P'' be two points near to P on these curves respectively, and the corresponding points of the f -plane be Q, Q', Q'' , then (1) the ratios $PP'/PP'', QQ'/QQ''$ are ultimately equal, (2) the angle $PP'P''$ is equal to $QQ'Q''$, (3) the rotation from PP' to PP'' is in the same sense as from QQ' to QQ'' ; it being understood that the axes of ξ, η in the one plane are related as are the axes of x, y . Thus any diagram of the z -plane becomes a diagram of the f -plane with the same angles; the magnification, however, which is equal to $\left[\left(\frac{\partial \xi}{\partial x} \right)^2 + \left(\frac{\partial \eta}{\partial x} \right)^2 \right]^{1/2}$ varies from point to point. Conversely, it appears subsequently that the expression of any copy of a diagram (say, a map) which preserves angles requires the intervention of the complex variable.

As another illustration consider the case when f is a polynomial in z ,

$$f = p_n z^n + p_{n-1} z^{n-1} + \dots + p_0;$$

H being an arbitrary real positive number, it can be shown that a radius R can be found such for every $|z| > R$ we have $|f(z)| > H$; consider the lower limit of $|f|$ for $|z| < R$; as f is a real continuous function of x, y for $|z| < R$, there is a point (x_0, y_0) , say (z_0, η_0) , at which $|f|$ is least, say equal to ρ , and therefore within a circle in the f -plane whose centre is the origin, of radius ρ , there are no points f representing values corresponding to $|z| < R$. But if f_0 be the value of f corresponding to (z_0, η_0) , and the expression of $f - f_0$ near $z_0 = z_0 + i\eta_0$, in terms of $s - z_0$, be $A(s - z_0)^m + B(s - z_0)^{m+1} + \dots$, where $A \neq 0$, is not zero, to two points near to (z_0, η_0) , say (z_1, η_1) or z_1 and $z_2 = z_0 + (z_1 - z_0) \left(\cos \frac{\pi}{m} + i \sin \frac{\pi}{m} \right)$, will correspond two points near to f_0 , say f_1 , and $2f_1 - f_0$, situated so that f_0 is between them. One of these must be within the circle (ρ) . We infer then that $\rho = 0$, and have proved that every polynomial in z vanishes for some value of z , and can therefore be written as a product of factors of the form $s - a$, where a denotes a complex number. This proposition alone suffices to suggest the importance of complex numbers.

§ 3. Limiting Operations.—In order that a complex number $\xi = \xi + i\eta$ may have a limit it is necessary and sufficient that each of ξ and η has a limit. Thus an infinite series $w_0 + w_1 + w_2 + \dots$ whose terms are complex numbers, is convergent if the real series formed by taking the real parts of its terms and that formed by the imaginary terms are both convergent. The series is also convergent if the real series formed by the moduli of its terms is convergent; in that case the series is said to be absolutely convergent, and it can be shown that its sum is unaltered by taking the terms in any other order. Generally the necessary and sufficient condition of convergence is that, for a given real positive ϵ , a number m exists such that for every $n > m$, and every positive p , the batch of terms $w_n + w_{n+1} + \dots + w_{n+p}$, is less than ϵ in absolute value. If the terms depend upon a complex variable z , the convergence is called uniform for a range of values of z , when the inequality holds, for the same ϵ and m , for all the points z of this range.

The infinite series of most importance are those of which the general term is $a_n z^n$, wherein a_n is a constant, and z is regarded as variable, $n = 0, 1, 2, 3, \dots$. Such a series is called a power series. If a real and positive number M exists such that for $z = z_0$ and every n , $|a_n z_0^n| < M$, a condition which is satisfied, for instance, if the series converges for $z = z_0$, then it is at once proved that the series converges absolutely for every z for which $|z| < |z_0|$, and converges uniformly over every range $|z| < r'$ for which $r' < |z_0|$. To every power series there belongs then a circle of convergence within which it converges absolutely and uniformly; the function of z represented by it is thus continuous within the circle (this being the result of a general property of uniformly convergent series of continuous functions); the sum for an interior point z is, however, continuous with the sum for a point z_0 on the circumference, as z approaches to z_0 provided the series converges for $z = z_0$, as can be shown without much difficulty. Within a common circle of convergence two power series $\sum a_n z^n, \sum b_n z^n$ can be multiplied together according to the ordinary rule, this being a consequence of a theorem for absolutely convergent series. If r_1 be less than the radius of convergence of a series $\sum a_n z^n$ and for $|z| = r_1$, the sum of the series

be in absolute value less than a real positive quantity M , it can be shown that for $|z| = r_1$ every term is also less than M in absolute value, namely, $|a_n r_1^n| < M r_1^{n-1}$. If in every arbitrarily small neighbourhood of $z = 0$ there be a point for which two converging power series $\sum a_n z^n, \sum b_n z^n$ agree in value, then the series are identical, or $a_n = b_n$; thus also if $\sum a_n z^n$ vanish at $z = 0$ there is a circle of finite radius about $z = 0$ in which the sum of the series is zero. Considering a power series $f(z) = \sum a_n z^n$ of radius of convergence R , if $|z_0| < R$ and we put $z = z_0 + t$ with $|t| < R - |z_0|$, the resulting series $\sum a_n (z_0 + t)^n$ may be regarded as a double series in z_0 and t , which, since $|z_0| - |t| < R$, is absolutely convergent; it may then be arranged according to powers of t . Thus we may write $f(z) = \sum A_n t^n$; hence $A_n = f^{(n)}(z_0)$, and we have $|f(z_0 + t) - f(z_0)|/t = \sum A_n t^{n-1}$, wherein the continuous series on the right reduces to A_1 for $t = 0$; thus the ratio on the left has a definite limit when $t = 0$, equal namely to A_1 or $\sum a_n n z_0^{n-1}$. In other words, the original series may legitimately be differentiated at any interior point z_0 of its circle of convergence. Repeating this process we find $f^{(n)}(z_0 + t) = \sum a_n n! z_0^{n-n} t^{n-n}$, where $f^{(n)}(z_0)$ is the n th differential coefficient. Repeating for this power series, in t , the argument applied about $z = 0$ for $\sum a_n z^n$, we infer that for the series $f(z)$ every point which reduces it to zero is an isolated point, and of such points only a finite number lie within a circle which is within the circle of convergence of $f(z)$. Perhaps the simplest possible power series is $e^z = \exp(z) = 1 + z + z^2/2! + \dots$, of which the radius of convergence is infinite. By multiplication we have $\exp(z) \cdot \exp(z') = \exp(z + z')$. In particular when x, y are real, and $z = x + iy$, $\exp(z) = \exp(x) \exp(iy)$. Now the functions

$$U_n = \cos y, V_n = 1 - \cos y, U_1 = y - \sin y, \\ V_1 = 1/2 y^2 - 1 + \cos y, U_2 = 1/2 y^2 - y + \sin y, V_2 = 1/6 y^3 - 1/2 y^2 + 1 - \cos y, \dots$$

all vanish for $y = 0$, and the differential coefficient of any one after the first is the preceding one; as a function (of a real variable) is increasing when its differential coefficient is positive, we infer, for y positive, that each of these functions is positive; proceeding to a limit we hence infer that

$$\cos y = 1 - 1/2 y^2 + 1/24 y^4 - \dots, \quad \sin y = y - 1/6 y^3 + 1/120 y^5 - \dots$$

for positive, and hence, for all values of y . We thus have $\exp(iy) = \cos y + i \sin y$, and $\exp(z) = \exp(x) (\cos y + i \sin y)$. In other words, the modulus of $\exp(z)$ is $\exp(x)$ and the phase is y . Hence also

$$\exp(z + 2\pi i) = \exp(z) [\cos(y + 2\pi) + i \sin(y + 2\pi)],$$

which we express by saying that $\exp(z)$ has the period $2\pi i$, and hence also the period $2k\pi i$, where k is an arbitrary integer. From the fact that the constantly increasing function $\exp(x)$ can vanish only for $x = 0$, we at once prove that $\exp(z)$ has no other periods.

Taking in the plane of z an infinite strip lying between the lines $y = 0, y = 2\pi$ and plotting the function $f = \exp(z)$ upon a new plane, it follows at once from what has been said that every complex value of f arises when z takes in turn all positions in this strip, and that no value arises twice over. The equation $f = \exp(z)$ thus defines z , regarded as depending upon f , with only an additive ambiguity $2k\pi i$, where k is an integer. We write $z = \lambda(f)$; when f is real this becomes the logarithm of f ; in general $\lambda(f) = \log |f| + i \text{ph}(f) + 2k\pi i$, where k is an integer; and when f describes a closed circuit surrounding the origin the phase of f increases by 2π , or k increases by unity. Differentiating the series for f we have $d f/dz = f$, so that f , regarded as depending upon f , is also differentiable, with $d z/d f = f^{-1}$. On the other hand, consider the series $f - 1 = \frac{1}{2}(f-1)^2 + \frac{1}{6}(f-1)^3 - \dots$; it converges when $|f-1| < 2$ and hence converges for $|f-1| < 1$; its differential coefficient is, however, $1 - (f-1) + (f-1)^2 - \dots$, that is, $(1+f-1)^{-1}$. Wherefore if $\phi(f)$ denote this series, for $|f-1| < 1$, the difference $\lambda(f) - \phi(f)$, regarded as a function of f and η , has vanishing differential coefficients; if we take the value of $\lambda(f)$ which vanishes when $f = 1$ we infer thence that for $|f-1| < 1$, $\lambda(f) = \sum_{n=1}^{\infty} \frac{(f-1)^{n-1}}{n}$. It is to be remarked that it is impossible for f , while subject to $|f-1| < 1$ to make a circuit about the origin. For values of f for which $|f-1| < 1$, we can also calculate $\lambda(f)$ with the help of infinite series, utilizing the fact that $\lambda(f f') = \lambda(f) + \lambda(f')$.

The function $\lambda(f)$ is required to define f^a when f and a are complex numbers; this is defined as $\exp [a \lambda(f)]$, that is as $\sum a^n [\lambda(f)]^n/n!$. When a is a real integer the ambiguity of $\lambda(f)$ is immaterial here, since $\exp [a \lambda(f) + 2k\pi i] = \exp [a \lambda(f)]$; when a is of the form $1/q$, where q is a positive integer, there are q values possible for f^a , of the form $\exp \left[\frac{1}{q} \lambda(f) \right] \exp \left(\frac{2k\pi i}{q} \right)$, with $k = 0, 1, \dots, q-1$, all other values of k leading to one of these; the q th power of any one of these values is f ; when $a = p/q$, where p, q are integers without common factor, q being positive, we have $f^{p/q} = (f^p)^{1/q}$. The definition of the symbol f^a is thus a generalization of the ordinary definition of a power, when the numbers are real. As an example, let it be required to find the meaning of i^i ; the number i is of modulus unity and phase $\frac{1}{2}\pi$; thus $\lambda(i) = i(\frac{1}{2}\pi + 2k\pi)$; and $i^i = \exp(-\frac{1}{2}\pi - 2k\pi) = \exp(-\frac{1}{2}\pi) \exp(-2k\pi)$, is always real, but has an infinite number of values.

The function $\exp(z)$ is used also to define a generalized form of the cosine and sine functions when z is complex; we write, namely, $\cos z = \frac{1}{2}[\exp(iz) + \exp(-iz)]$ and $\sin z = \frac{1}{2i}[\exp(iz) - \exp(-iz)]$. It will be found that these obey the ordinary relations holding when z is real, except that their moduli are not inferior to unity. For example, $\cos z = 1 + \frac{1}{2!}z^2 + \frac{1}{4!}z^4 + \dots$ is obviously greater than unity.

§4. *Of Functions of a Complex Variable in General.*—We have in what precedes shown how to generalize the ordinary rational, algebraic and logarithmic functions, and considered more general cases, of functions expressible by power series in z . With the suggestions furnished by these cases we can frame a general definition. So far our use of the plane upon which z is represented has been only illustrative, the results being capable of analytical statement. In what follows this representation is vital to the mode of expression we adopt; as then the properties of numbers cannot be ultimately based upon spatial intuitions, it is necessary to indicate what are the geometrical ideas requiring elucidation.

Consider a square of side a , to whose perimeter is attached a definite direction of description, which we take to be counter-clockwise; another square, also of side a , may be added to this, so that there is a side common; this common side being erased we have a composite region with a definite direction of perimeter; to this a third square of the same size may be attached, so that there is a side common to it and one of the former squares, and this common side may be erased. If this process be continued any number of times we obtain a region of the plane bounded by one or more polygonal closed lines, no two of which intersect; and at each portion of the perimeter there is a definite direction of description, which is such that the region is on the left of the describing point. Similarly we may construct a region by piecing together triangles, so that every consecutive two have a side in common, it being understood that there is assigned an upper limit for the greatest side of a triangle, and a lower limit for the smallest angle. In the former method, each square may be divided into four others by lines through its centre parallel to its sides; in the latter method each triangle may be divided into four others by lines joining the middle points of its sides; this halves the sides and preserves the angles. When we speak of a region of the plane in general, unless the contrary is stated, we shall suppose it capable of being generated in this latter way by means of a finite number of triangles, there being an upper limit to the length of a side of the triangle and a lower limit to the size of an angle of the triangle. We shall also require to speak of a path in the plane; this is to be understood as capable of arising as a limit of a polygonal path of finite length, there being a definite direction or sense of description at every point of the path, which therefore never meets itself. From this the meaning of a closed path is clear. The boundary points of a region form one or more closed paths, but, in general, it is only in a limiting sense that the interior points of a closed path are a region.

There is a logical principle also which must be referred to. We frequently have cases where, about every interior or boundary point z_0 of a certain region a circle can be put, say of radius r_0 , such that for all points z of the region which are interior to this circle, for which, that is, $|z - z_0| < r_0$, a certain property holds. Assuming that to r_0 is given the value which is the upper limit for z_0 of the possible values, we may call the points $|z - z_0| < r_0$, the neighbourhood belonging to or proper to z_0 , and may speak of the property as the property (z, z_0) . The value of r_0 will in general vary with z_0 ; what is in most cases of importance is the question whether the lower limit of r_0 for all positions is zero or greater than zero. (A) This lower limit is certainly greater than zero provided the property (z, z_0) is of a kind which we may call *extensive*; such, namely, that if it holds, for some position of z_0 and all positions of z , within a certain region, then the property (z, z_0) holds within a circle of radius r about any interior point z_1 of this region for all points z for which the circle $|z - z_1| = r$ is within the region. Also in this case r_0 varies continuously with z_0 . (B) Whether the property is of this extensive character or not we can prove that the region can be divided into a finite number of sub-regions such that, for every one of these, the property holds, (1) for some point z_0 within or upon the boundary of the sub-region, (2) for every point z within or upon the boundary of the sub-region.

We prove these statements (A), (B) in reverse order. To prove (B) let a region for which the property (z, z_0) holds for all points z and some point z_0 of the region, be called *suitable*; if each of the triangles of which the region is built up is suitable, what is desired is proved; if not let an unsuitable triangle be subdivided into four, as before explained; if one of these subdivisions is unsuitable let it be again subdivided; and so on. Either the process terminates and then what is required is proved; or else we obtain an indefinitely continued sequence of unsuitable triangles, each contained in the preceding, which converge to a point, say f ; after a certain stage all these will be interior to the proper region of f ; this, however, is contrary to the supposition that they are all unsuitable.

We now make some applications of this result (B). Suppose a

definite finite real value attached to every interior or boundary point of the region, say $f(x, y)$. It may have a finite upper limit H for the region, so that no point (x, y) exists for which $f(x, y) > H$, but points (x, y) exist for which $f(x, y) > H - \epsilon$, however small ϵ may be; if not we say that its upper limit is infinite. There is then at least one point of the region such that, for points of the region within a circle about this point, the upper limit of $f(x, y)$ is H , however small the radius of the circle be taken; for if not we can put about every point of the region a circle within which the upper limit of $f(x, y)$ is less than H ; then by the result (B) above the region consists of a finite number of sub-regions within each of which the upper limit is less than H ; this is inconsistent with the hypothesis that the upper limit for the whole region is H . A similar statement holds for the lower limit. A case of such a function $f(x, y)$ is the radius r_0 of the neighbourhood proper to any point z_0 spoken of above. We can hence prove the statement (A) above.

Suppose the property (z, z_0) extensive, and, if possible, that the lower limit of r_0 is zero. Let then f be a point such that the lower limit of r_0 is zero for points z_0 within a circle about f however small; let r be the radius of the neighbourhood proper to f ; take z_0 so that $|z_0 - f| < \frac{1}{2}r$; the property (z, z_0) , being extensive, holds within a circle, centre z_0 , of radius $r - |z_0 - f|$, which is greater than $\frac{1}{2}r - |z_0 - f|$, and increases to r as $|z_0 - f|$ diminishes; this being true for all points z_0 near f , the lower limit of r_0 is not zero for the neighbourhood of f , contrary to what was supposed. This proves (A). Also, as is here shown that $r_0 \rightarrow 0$ as $|z_0 - f| \rightarrow 0$, may similarly be shown that $r_0 \rightarrow 0$ as $|z_0 - f| \rightarrow 0$. Thus r_0 differs arbitrarily little from r when $|z_0 - f|$ is sufficiently small; that is, r_0 varies continuously with z_0 . Next suppose the function $f(x, y)$, which has a definite finite value at every point of the region considered, to be continuous but not necessarily real, so that about every point z_0 , within or upon the boundary of the region, η being an arbitrary real positive quantity assigned beforehand, a circle is possible, so that for all points z of the region interior to this circle, we have $|f(x, y) - f(x_0, y_0)| < \eta$, and therefore (x, y) being any other point interior to this circle, $|f(x, y) - f(x_0, y_0)| < \eta$. We can then apply the result (A) obtained above, taking for the neighbourhood proper to any point z_0 the circular area within which, for any two points (x, y) , (x', y') , we have $|f(x, y) - f(x', y')| < \eta$. This is clearly an extensive property. Thus, a number r is assignable, greater than zero, such that, for any two points (x, y) , (x', y') within a circle $|z - z_0| = r$ about any point z_0 , we have $|f(x, y) - f(x', y')| < \eta$, and, in particular, $|f(x, y) - f(x_0, y_0)| < \eta$, where η is an arbitrary real positive quantity agreed upon beforehand.

Take now any path in the region, whose extreme points are z_0, z_1 and let z_2, \dots, z_{n-1} be intermediate points of the path, in order; denote the continuous function $f(x, y)$ by $f(z)$, and let f_i denote any quantity such that $|f_i - f(z_i)| \leq |f(z_{i+1}) - f(z_i)|$; consider the sum

$$(z_1 - z_0)f_0 + (z_2 - z_1)f_1 + \dots + (z_n - z_{n-1})f_{n-1}.$$

By the definition of a path we can suppose, n being large enough, that the intermediate points z_1, \dots, z_{n-1} are so taken that if z, z_{i+1} be any two points intermediate, in order, to z_i and z_{i+1} , we have $|z_{i+1} - z_i| < |z_{i+1} - z_i|$; we can thus suppose $|z_1 - z_0|, |z_2 - z_1|, \dots, |z_n - z_{n-1}|$ all to converge constantly to zero. This being so, we can show that the sum above has a definite limit. For this it is sufficient, as in the case of an integral of a function of one real variable, to prove this to be so when the convergence is obtained by taking new points of division intermediate to the former ones. If, however, $z_i, z_{i+1}, \dots, z_{i+m-1}$ be intermediate in order to z_i and z_{i+1} , and $|f_i - f(z_i)| < |f(z_{i+1}) - f(z_i)|$, the difference between $\Sigma(z_{i+1} - z_i)f_i$ and

$$\Sigma[(z_{i+1} - z_i)f_{i+1} + (z_{i+2} - z_{i+1})f_{i+2} + \dots + (z_{i+m} - z_{i+m-1})f_{i+m-1}],$$

which is equal to

$$\Sigma \Sigma (z_{i+j} - z_i - z_{i+j-1} + z_{i+j-1}) (f_{i+j} - f_i),$$

is, when $|z_{i+1} - z_i|$ is small enough, to ensure $|f(z_{i+1}) - f(z_i)| < \eta$, less in absolute value than

$$\Sigma \eta \Sigma |z_{i+j} - z_i - z_{i+j-1}|,$$

which, if S be the upper limit of the perimeter of the polygon from which the path is generated, is $< \eta S$, and is therefore arbitrarily small.

The limit in question is called $\int f(z) dz$. In particular when $f(z) = 1$, it is obvious from the definition that its value is $z - z_0$; when $f(z) = z$, by taking $f_i = z_i(z_{i+1} - z_i)$, it is equally clear that its value is $\frac{1}{2}(z^2 - z_0^2)$; these results will be applied immediately.

Suppose now that to every interior and boundary point z_0 of a certain region there belong two definite finite numbers $f(z_0)$, $F(z_0)$, such that, whatever real positive quantity η may be, a real positive number ϵ exists for which the condition

$$\left| \frac{f(z) - f(z_0)}{z - z_0} - F(z_0) \right| < \eta,$$

which we describe as the condition (z, z_0) , is satisfied for every point z , within or upon the boundary of the region, satisfying the limitation $|z - z_0| < \epsilon$. Then $F(z_0)$ is called a differential function of the complex variable z_0 over this region, its differential coefficient being $F(z_0)$. The function $f(z_0)$ is thus a continuous function of the real

variables z_0, z_1 , where $z_0 = z_0 + i\eta_0$, over the region; it will appear that $F(z_0)$ is also continuous and in fact also a differentiable function of z_0 .

Supposing η to be retained the same for all points z_0 of the region, and ϵ_0 to be the upper limit of the possible values of ϵ for the point z_0 , it is to be presumed that ϵ_0 will vary with z_0 , and it is not obvious as yet that the lower limit of the values of ϵ_0 as z_0 varies over the region may not be zero. We can, however, show that the region can be divided into a finite number of sub-regions for each of which the condition (s, z_0) , above, is satisfied for all points z , within or upon the boundary of this sub-region, for an appropriate position of z_0 , within or upon the boundary of this sub-region. This is proved above as result (B).

Hence it can be proved that, for a differentiable function $f(z)$, the integral $\int_{\gamma} f(z) dz$ has the same value by whatever path within the region we pass from s_1 to s_2 . This we prove by showing that when taken round a closed path in the region the integral $\int f(z) dz$ vanishes. Consider first a triangle over which the condition (s, z_0) holds, for some position of z_0 and every position of z , within or upon the boundary of the triangle. Then as

$$f(z) = f(z_0) + (z - z_0)F'(z_0) + \theta(z - z_0)^2, \text{ where } |\theta| < 1,$$

we have

$$\int f(z) dz = [f(z_0) - z_0 F'(z_0)] \int dz + F'(z_0) \int z dz + \eta \theta \int (z - z_0)^2 dz,$$

which, as the path is closed, is $\eta \theta \int (s - z_0) dz$. Now, from the theorem that the absolute value of a sum is less than the sum of the absolute values of the terms, this last is less, in absolute value, than $\eta \theta a^2$, where a is the greatest side of the triangle and θ is its perimeter; if Δ be the area of the triangle, we have $\Delta = \frac{1}{2} ab \sin C > \frac{1}{2} (a+b)c$, where c is the least angle of the triangle, and hence $\Delta > \frac{1}{2} (a+b+c) > 2a(b+c) < 4\eta \theta \Delta a$; the integral $\int f(z) dz$ round the perimeter of the triangle is thus $< 4\eta \theta \Delta a$. Now consider any region made up of triangles, as before explained, in each of which the condition (s, z_0) holds, as in the triangle just taken. The integral $\int f(z) dz$ round the boundary of the region is equal to the sum of the values of the integral round the component triangles, and thus less in absolute value than $4\eta \theta K a$, where K is the whole area of the region, and a is the smallest angle of the component triangles. However small η be taken, such a division of the region into a finite number of component triangles has been shown possible; the integral round the perimeter of the region is thus arbitrarily small. Thus it is actually zero, which it was desired to prove. Two remarks should be added: (1) The theorem is proved only on condition that the closed path of integration belongs to the region at every point of which the conditions are satisfied. (2) The theorem, though proved only when the region consists of triangles, holds also when the boundary points of the region consist of one or more closed paths, no two of which meet.

Hence we can deduce the remarkable result that the value of $f(z)$ at any interior point of a region is expressible in terms of the value of $f(z)$ at the boundary points. For consider in the original region the function $f(z)/(z - z_0)$, where z_0 is an interior point; this satisfies the same conditions as $f(z)$ except in the immediate neighbourhood of z_0 . Taking out then from the original region a small regular polygonal region with z_0 as centre, the theorem holds for the remaining portion. Proceeding to the limit when the polygon becomes a circle, it appears that the integral $\int_{\gamma} \frac{f(z) dz}{z - z_0}$ round the boundary of the original region is equal to the same integral taken counter-clockwise round a small circle having z_0 as centre; on this circle, however, if $s - z_0 = rE(i\theta)$, $dz/(z - z_0) = i d\theta$, and $f(z)$ differs arbitrarily little from $f(z_0)$ if r is sufficiently small; the value of the integral round this circle is therefore, ultimately, when r vanishes, equal to

$$2\pi i f(z_0). \text{ Hence } f(z_0) = \frac{1}{2\pi i} \int_{\gamma} \frac{f(z) dz}{z - z_0}, \text{ where this integral is round the boundary of the original region. From this it appears that}$$

$$F(z_0) = \lim_{z \rightarrow z_0} \frac{f(z) - f(z_0)}{z - z_0} = \frac{1}{2\pi i} \int_{\gamma} \frac{df(z)}{(z - z_0)^2}$$

also round the boundary of the original region. This form shows, however, that $F(z_0)$ is a continuous, finite, differentiable function of z_0 over the whole interior of the original region.

§ 5. Applications.—The previous results have manifold applications.

(1) If an infinite series of differentiable functions of z be uniformly convergent along a certain path lying within the region of definition of the functions, so that $S(z) = s_0(z) + s_1(z) + \dots + s_{n-1}(z) + R_n(z)$, where $|R_n(z)| < \epsilon$ for all points of the path, we have $\int_{\gamma} S(z) dz = \int_{\gamma} s_0(z) dz + \int_{\gamma} s_1(z) dz + \dots + \int_{\gamma} s_{n-1}(z) dz + \int_{\gamma} R_n(z) dz$, wherein, in absolute value, $\int_{\gamma} R_n(z) dz < \epsilon L$, if L be the length of the path. Thus the series may be integrated, and the resulting series is also uniformly convergent.

(2) If $f(x, y)$ be definite, finite and continuous at every point of a region, and over any closed path in the region $\int f(x, y) dz = 0$, then

$\psi(z) = \int_{z_0}^z f(x, y) dz$, for interior points z_0, z , is a differentiable function of z , having for its differential coefficient the function $f(x, y)$, which is therefore also a differentiable function of z at interior points.

(3) Hence if the series $s_0(z) + s_1(z) + \dots$ to ∞ be uniformly convergent over a region, its terms being differentiable functions of z , then its sum $S(z)$ is a differentiable function of z , whose differential

coefficient, given by $\frac{1}{2\pi i} \int_{\gamma} \frac{S(z) dz}{(z - z_0)}$, is obtainable by differentiating the series. This theorem, unlike (1), does not hold for functions of a real variable.

(4) If the region of definition of a differentiable function $f(z)$ include the region bounded by two concentric circles of radii r, R , with centre at the origin, and z_0 be an interior point of this region,

$$f(z_0) = \frac{1}{2\pi i} \int_{\gamma} \frac{f(z) dz}{z - z_0} - \frac{1}{2\pi i} \int_{\gamma'} \frac{f(z) dz}{z - z_0}, \text{ where the integrals are both counter-clockwise round the two circumferences respectively; putting in the first } (z - z_0)^{-1} = \sum_{n=0}^{\infty} z^n / r^{n+1}, \text{ and in the second } (z - z_0)^{-1} = -\sum_{n=0}^{\infty} z^n / R^{n+1},$$

we find $f(z_0) = \sum_{n=0}^{\infty} A_n z_0^n$, wherein $A_n = \frac{1}{2\pi i} \int_{\gamma} \frac{f(z) dz}{z^{n+1}}$, taken round any

circle, centre the origin, of radius intermediate between r and R . Particular cases are: (a) when the region of definition of the function includes the whole interior of the outer circle; then we may take $r = 0$, the coefficients A_n for which $n < 0$ all vanish, and the function $f(z_0)$ is expressed for the whole interior $|z_0| < R$ by a power series $\sum A_n z_0^n$. In other words, about every interior point c of the region of definition a differentiable function of z is expressible by a power series in $z - c$; a very important result.

(B) If the region of definition, though not including the origin, extends to within arbitrary nearness of this on all sides, and at the same time the product $z^n f(z)$ has a finite limit when $|z|$ diminishes to zero, all the coefficients A_n for which $n < -m$ vanish, and we have

$$f(z_0) = A_{-m} z_0^{-m} + A_{-m+1} z_0^{-m+1} + \dots + A_{-1} z_0^{-1} + A_0 + A_1 z_0 + \dots \text{ to } \infty.$$

Such a case occurs, for instance, when $f(z) = \cos z$, the number m being unity.

§ 6. Singular Points.—The region of existence of a differentiable function of z is an unclosed aggregate of points, each of which is an interior point of a neighbourhood consisting wholly of points of the aggregate, at every point of which the function is definite and finite and possesses a unique finite differential coefficient. Every point of the plane, not belonging to the aggregate, which is a limiting point of points of the aggregate, such, that is, that points of the aggregate lie in every neighbourhood of this, is called a singular point of the function.

About every interior point z_0 of the region of existence the function may be represented by a power series in $z - z_0$, and the series converges and represents the function over any circle centre at z_0 which contains no singular point in its interior. This has been proved above. And it can be similarly proved, putting $s = 1/z$, that if the region of existence of the function contains all points of the plane for which $|z| > R$, then the function is representable for all such points by a power series in s^{-1} or z ; in such case we say that the region of existence of the function contains the point $s = \infty$. A series in s^{-1} has a finite limit when $|z| = \infty$; a series in z cannot remain finite for all points z for which $|z| > R$; for if, for $|z| = R$, the sum of a power series $\sum a_n z^n$ in z is in absolute value less than M , we have $|a_n| < M r^{-n}$, and therefore, if M remains finite for all values of r however great, $a_n = 0$. Thus the region of existence of a function if it contains all finite points of the plane cannot contain the point $s = \infty$; such is, for instance, the case of the function $\exp(z) = \sum z^n/n!$. This may be regarded as a particular case of a well-known result (§ 7), that the circumference of convergence of any power series representing the function contains at least one singular point. As an extreme case functions exist whose region of existence is circular, there being a singular point in every arc of the circumference, however small; for instance, this is the case for the functions represented for $|z| < 1$ by the series $\sum z^n$, where $m = n^2$, the series $\sum z^n$ where $m = n!$, and the series $\sum z^n/(n+1)(n+2)$ where $m = n^2$,

a being a positive integer, although in the last case the series actually converges for every point of the circle of convergence $|z| = 1$. If z be a point interior to the circle of convergence of a series representing the function, the series may be rearranged in powers of $z - z_0$; as z_0 approaches to a singular point of the function, lying on the circle of convergence, the radii of convergence of these derived series in $z - z_0$ diminish to zero; when, however, a circle can be put about z_0 not containing any singular point of the function, but containing points outside the circle of convergence of the original series, then the series in $z - z_0$ gives the value of the function for these external points. If the function be supposed to be given only for the interior of the original circle, by the original power series, the series in $z - z_0$ converging beyond the original circle gives what is known as an analytical continuation of the function. It appears from what has

been proved that the value of the function at all points of its region of existence can be obtained from its value, supposed given by a series in one original circle, by a succession of such processes of analytical continuation.

§ 7. *Monogenic Functions.*—This suggests an entirely different way of formulating the fundamental parts of the theory of functions of a complex variable, which appears to be preferable to that so far followed here.

Starting with a convergent power series, say in powers of z , this series can be arranged in powers of $z - z_0$, about any point z_0 interior to its circle of convergence, and the new series converges certainly for $|z - z_0| < r - |z_0|$, if r be the original radius of convergence. If for every position of z_0 this is the greatest radius of convergence of the derived series, then the original series represents a function existing only within its circle of convergence. If for some position of z_0 the derived series converges for $|z - z_0| < r - |z_0| + D$, then it can be shown that for points z_1 interior to the original circle, lying in the annulus $r - |z_0| < |z - z_0| < r - |z_0| + D$, the value represented by the derived series agrees with that represented by the original series. If for another point z_2 interior to the original circle the derived series converges for $|z - z_1| < r - |z_1| + E$, and the two circles $|z - z_0| = r - |z_0| + D$, $|z - z_1| = r - |z_1| + E$ have interior points common, lying beyond $|z| = r$, then it can be shown that the values represented by these series at these common points agree. Either series then can be used to furnish an analytical continuation of the function as originally defined. Continuing this process of continuation as far as possible, we arrive at the conception of the function as defined by an aggregate of power series of which every one has points of convergence common with some one or more others; the whole aggregate of points of the plane which can be so reached constitutes the region of existence of the function; the limiting points of this region are the points in whose neighbourhood the derived series have radii of convergence diminishing indefinitely to zero; those are the singular points. The circle of convergence of any of the series has at least one such singular point upon its circumference. So regarded the function is called a *monogenic function*, the epithet having reference to the single origin, by one power series, of the expressions representing the function; it is also sometimes called a *monogenic analytical function*, or simply an *analytical function*; all that is necessary to define it is the value of the function and of all its differential coefficients, at some one point of the plane; in the method previously followed here it was necessary to suppose the function differentiable at every point of its region of existence. The theory of the integration of a monogenic function, and Cauchy's theorem, that $\int f(z) dz = 0$ over a closed path, are at once deducible from the corresponding results applied to a single power series for the interior of its circle of convergence. There is another advantage belonging to the theory of monogenic functions: the theory as originally given here applies in the first instance only to single valued functions; a monogenic function is by no means necessarily single valued—it may quite well happen that starting from a particular power series, converging over a certain circle, and applying the process of analytical continuation over a closed path back to an interior point of this circle, the value obtained does not agree with the initial value. The notion of basing the theory of functions on the theory of power series is, after Newton, largely due to Lagrange, who has some interesting remarks in this regard at the beginning of his *Théorie des fonctions analytiques*. He applies the idea, however, primarily to functions of a real variable for which the expression by power series is only of very limited validity; for functions of a complex variable probably the systematization of the theory owes most to Weierstrass, whose use of the word monogenic is that adopted above. In what follows we generally suppose this point of view to be regarded as fundamental.

§ 8. *Some Elementary Properties of Single Valued Functions.*—A *pole* is a singular point of the function $f(z)$ which is not a singularity of the function $1/f(z)$; this latter function is therefore, by the definition, capable of representation about this point, z_0 , by a series $\{f(z)\}^{-1} = \sum a_n (z - z_0)^n$. If herein a_0 is not zero we can hence derive a representation for $f(z)$ as a power series about z_0 , contrary to the hypothesis that z_0 is a singular point for this function. Hence $a_0 = 0$; suppose also $a_1 = 0, a_2 = 0, \dots, a_{m-1} = 0$, but $a_m \neq 0$. Then $\{f(z)\}^{-1} = (z - z_0)^m [a_m + a_{m+1}(z - z_0) + \dots]$, and hence $(z - z_0)^m f(z) = a_m^{-1} + 2b_1(z - z_0) + \dots$, namely, the expression of $f(z)$ about $z = z_0$ contains a finite number of negative powers of $z - z_0$ and a (finite or) infinite number of positive powers. Thus a pole is always an isolated singularity.

The integral $\int f(z) dz$ taken by a closed circuit about the pole not containing any other singularity is at once seen to be $2\pi i A_1$, where A_1 is the coefficient of $(z - z_0)^{-1}$ in the expansion of $f(z)$ at the pole; this coefficient has therefore a certain uniqueness, and it is called the *residue of $f(z)$ at the pole*. Considering a region in which there are no other singularities than poles, all these being interior points, the integral $\int_{\partial R} f(z) dz$ round the boundary of this region is equal to

the sum of the residues at the included poles, a very important result. Any singular point of a function which is not a pole is called an *essential singularity*; if it is isolated the function is capable, in the neighbourhood of this point, of approaching arbitrarily near to any assigned value. For, the point being isolated, the function can be represented, in its neighbourhood, as we have proved, by a series $\sum a_n (z - z_0)^n$; it thus cannot remain finite in the immediate neighbourhood of the point. The point is necessarily an isolated essential singularity also of the function $|f(z) - A|^{-1}$, for if this were expressible by a power series about the point, so would also the function $f(z)$; as $|f(z) - A|^{-1}$ approaches infinity, so does $f(z)$ approach the arbitrary value A . Similar remarks apply to the point $z = \infty$, the function being regarded as a function of $f = z^{-1}$. In the neighbourhood of an essential singularity, which is a limiting point also of poles, the function clearly becomes infinite. For an essential singularity which is not isolated the same result does not necessarily hold.

A single valued function is said to be an *integral function* when it has no singular points except $z = \infty$. Such is, for instance, an integral polynomial, which has $z = \infty$ for a pole, and the functions $\exp(z)$ which has $z = \infty$ as an essential singularity. A function which has no singular points for finite values of z other than poles is called a *meromorphic function*. If it also have a pole at $z = \infty$ it is a *rational function*. For then, if a_1, \dots, a_r be its finite poles, of orders m_1, m_2, \dots, m_r , the product $(z - a_1)^{m_1} \dots (z - a_r)^{m_r} f(z)$ is an integral function with a pole at infinity, capable therefore, for large values of z , of an expression $(z^{-1})^{-\mu} = \sum b_n (z^{-1})^n$; thus $(z - a_1)^{m_1} \dots (z - a_r)^{m_r} f(z)$ is capable of a form $\sum b_n z^n$, but $z^{-\mu} \sum b_n z^n$ remains finite for $z = \infty$. Therefore $b_{-\mu+1} = b_{-\mu+2} = \dots = 0$, and $f(z)$ is a rational function.

If for a single valued function $F(z)$ every singular point in the finite part of the plane is isolated there can only be a finite number of these in any finite part of the plane, and they can be taken to be a_1, a_2, a_3, \dots with $|a_n| \leq |a_{n+1}|$, and limit $|a_n| = \infty$. About a_n the function is expressible as $\sum A_n (z - a_n)^{-\nu_n}$; let $f_n(z) = \sum A_n (z - a_n)^{-\nu_n}$ be the sum of the negative powers in this expansion. Assuming $z = 0$ not to be a singular point, let $f_0(z)$ be expanded in powers of z , in the form $\sum C_n z^n$, and μ_n be chosen so that $F_n(z) = f_n(z) - \sum C_n z^n = \sum C_n z^{\mu_n}$, for $|z| < r, < |a_n|$, less in absolute value than the general term c_n of a fore-agreed convergent series of real positive terms. Then the series $\phi(z) = \sum F_n(z)$ converges uniformly in any finite region of the plane, other than at the points a_n , and is expressible about any point by a power series, and near a_n $\phi(z) - f_n(z)$ is expressible by a power series in $z - a_n$. Thus $F(z) - \phi(z)$ is an integral function. In particular when all the finite singularities of $F(z)$ are poles, $F(z)$ is hereby expressed as the sum of an integral function and a series of rational functions. The condition $|F_n(z)| < c_n$ is imposed only to render the series $\sum F_n(z)$ uniformly convergent; this condition may in particular cases be satisfied by a series $\sum G_n(z)$ where $G_n(z) = f_n(z) - \sum_{r=1}^{\nu_n-1} C_n z^r$ and $\nu_n < \mu_n$.

An example of the theorem is the function $\pi \cot \pi z = \pi^{-1}$ for which, taking at first only half the poles, $f_n(z) = 1/(z - n)$; in this case the series $\sum F_n(z)$ where $F_n(z) = (z - n)^{-1} + z^{-1}$ is uniformly convergent; thus $\pi \cot \pi z = \pi^{-1} \sum (z - n)^{-1} + z^{-1}$, where $z = 0$ is excluded from the summation, is an integral function. It can be proved that this integral function vanishes.

Considering an integral function $f(z)$, if there be no finite positions of z for which this function vanishes, the function $1/f(z)$ is at once seen to be an integral function, $\phi(z)$, or $f(z) = \exp[\phi(z)]$; if however great R may be there be only a finite number of values of z for which $f(z)$ vanishes, say $z = a_1, \dots, a_m$, then it is at once seen that $f(z) = \exp[\phi(z)] \cdot (z - a_1)^{\mu_1} \dots (z - a_m)^{\mu_m}$, where $\phi(z)$ is an integral function, and μ_1, \dots, μ_m are positive integers. If, however, $f(z)$ vanish for $z = a_1, a_2, \dots$ where $|a_n| \leq |a_{n+1}|$ and limit $|a_n| = \infty$, and if for simplicity we assume that $z = 0$ is not a zero and all the zeros a_1, a_2, \dots are of the first order, we find, by applying the preceding theorem to the function $\int \frac{df(z)}{f(z)} dz$, that $f(z) = \exp[\phi(z)] \prod_{n=1}^{\infty} [(1 - z/a_n) \exp \phi_n(z)]$, where $\phi(z)$ is an integral function, and $\phi_n(z)$ is an integral polynomial of the form $\phi_n(z) = \frac{z}{a_n} + \frac{z^2}{2a_n^2} + \dots + \frac{z^{\nu_n}}{\nu_n a_n^{\nu_n}}$. The number ν_n may be the same for all values of n , or it may increase indefinitely with n ; it is sufficient in any case to take $\nu_n = n$. In particular for the function

$\frac{\sin \pi x}{x}$, we have

$$\frac{\sin \pi x}{x} = \prod_{n=1}^{\infty} \left\{ \left(1 - \frac{x}{n} \right) \exp \left(\frac{x}{n} \right) \right\},$$

where $n=0$ is excluded from the product (Or again we have

$$\frac{1}{\Gamma(x)} = x e^{\gamma x} \prod_{n=1}^{\infty} \left\{ \left(1 + \frac{x}{n} \right) \exp \left(-\frac{x}{n} \right) \right\},$$

where γ is a constant, and $\Gamma(x)$ is a function expressible when x is real and positive by the integral $\int_0^{\infty} e^{-t} t^{x-1} dt$

There exist interesting investigations as to the connexion of the value of s above, the law of increase of the modulus of the integral function $f(s)$, and the law of increase of the coefficients in the series $f(z) = \sum a_n z^n$ as n increases (see the bibliography below under *Integral Functions*). It can be shown, moreover, that an integral function actually assumes every finite complex value, save, in exceptional cases, one value at most. For instance, the function $\exp(z)$ assumes every finite value except zero (see below under § 21, *Modular Functions*).

The two theorems given above, the one, known as Mittag-Leffler's theorem, relating to the expression as a sum of simpler functions of a function whose singular points have the point $s = \infty$ as their only limiting point, the other, Weierstrass's factor theorem, giving the expression of an integral function as a product of factors each with only one zero in the finite part of the plane, may be respectively generalized as follows:—

I. If a_1, a_2, a_3, \dots be an infinite series of isolated points having the points of the aggregate (c) as their limiting points, so that in any neighbourhood of a point of (c) there exists an infinite number of the points a_1, a_2, \dots , and with every point a_n there be associated a polynomial $(z - a_n)^{-r_n}$, say g_n ; then there exists a single valued function whose region of existence excludes only the points (a) and the points (c) , having in a point a_n a pole whereat the expansion consists of the terms g_n , together with a power series in $z - a_n$; the function is expressible as an infinite series of terms $g_n \gamma_n$, where γ_n is also a rational function.

II. With a similar aggregate (a) , with limiting points (c) , suppose with every point a_n there is associated a positive integer r_n . Then there exists a single valued function whose region of existence excludes only the points (c) , vanishing to order r_n at the point a_n , but not elsewhere, expressible in the form

$$\prod_{n=1}^{\infty} \left(1 - \frac{z - c_n}{z - a_n} \right)^{r_n} \exp(g_n),$$

where with every point a_n is associated a proper point c_n of (c) , and

$$g_n = r_n \sum_{s=1}^{r_n} \left(\frac{z - c_n}{z - a_n} \right)^s,$$

r_n being a properly chosen positive integer.

If it should happen that the points (c) determine a path dividing the plane into separated regions, as, for instance, if $a_n = R(1 - n^{-1}) \exp(i\pi \sqrt{2}n)$, when (c) consists of the points of the circle $|z| = R$, the product expression above denotes different monogenic functions in the different regions, not continuable into one another.

§ 9. *Construction of a Monogenic Function with a given Region of Existence*.—A series of isolated points interior to a given region can be constructed in infinitely many ways whose limiting points are the boundary points of the region, or are boundary points of the region of such denseness that one of them is found in the neighbourhood of every point of the boundary, however small. Then the application of the last enunciated theorem gives rise to a function having no singularities in the interior of the region, but having a singularity in a boundary point in every small neighbourhood of every boundary point; this function has the given region as region of existence.

§ 10. *Expression of a Monogenic Function by means of Rational Functions in a given Region*.—Suppose that we have a region R_0 of the plane, as previously explained, for all the interior or boundary points of which s is finite, and let its boundary points, consisting of one or more closed polygonal paths, no two of which have a point in common, be called C_0 . Further suppose that all the points of this region, including the boundary points, are interior points of another region R , whose boundary is denoted by C . Let s be restricted to be within or upon the boundary of C_0 ; let a, b, \dots be finite points upon C or outside R . Then when b is near enough to a , the fraction $(a-b)/(t-b)$ is arbitrarily small for all positions of s ; say

$$\left| \frac{a-b}{t-b} \right| < \epsilon, \text{ for } |a-b| < \eta;$$

the rational function of the complex variable t ,

$$\frac{1}{t-a} \left[1 - \left(\frac{a-b}{t-b} \right)^n \right],$$

in which n is a positive integer, is not infinite at $t=a$, but has a pole at $t=b$. By taking n large enough, the value of this function, for all positions of t belonging to R_0 , differs as little as may be desired from $(t-a)^{-1}$. By taking a sum of terms such as

$$F = \sum A_p \left\{ \frac{1}{t-a} \left[1 - \left(\frac{a-b}{t-b} \right)^n \right] \right\}^p,$$

we can thus build a rational function differing, in value, in R_0 , as little as may be desired from a given rational function $f = \sum A_p (t-a)^{-p}$,

and differing, outside R or upon the boundary of R , from f , in the fact that while f is infinite at $t=a$, F is infinite only at $t=b$. By a succession of steps of this kind we thus have the theorem that, given a rational function of t whose poles are outside R or upon the boundary of R , and an arbitrary point c outside R or upon the boundary of R , which can be reached by a finite continuous path outside R from all the poles of the rational function, we can build another rational function differing in R_0 arbitrarily little from the former, whose poles are all at the point c .

Now any monogenic function $f(t)$ whose region of definition includes C and the interior of R can be represented at all points s in R_0 by

$$f(s) = \frac{1}{2\pi i} \int_{\Gamma} \frac{f(t) dt}{t-s},$$

where the path of integration is Γ . This integral is the limit of a sum

$$S = \frac{1}{2\pi i} \sum \frac{f(t_i)(t_i - t_i)}{t_i - s},$$

where the points t_i are upon Γ ; and the proof we have given of the existence of the limit shows that the sum S converges to $f(s)$ uniformly in regard to s , when s is in R_0 , so that we can suppose, when the subdivision of C into intervals $t_{i+1} - t_i$, has been carried sufficiently far, that

$$|S - f(s)| < \epsilon,$$

for all points s of R_0 , where ϵ is arbitrary and agreed upon beforehand. The function S is, however, a rational function of s with poles upon C , that is external to R_0 . We can thus find a rational function differing arbitrarily little from S , and therefore arbitrarily little from $f(s)$, for all points s of R_0 , with poles at arbitrary positions outside R_0 which can be reached by finite continuous curves lying outside R from the points of C .

In particular, to take the simplest case, if C_0, C be simple closed polygons, and Γ be a path to which C approximates by taking the number of sides of C continually greater, we can find a rational function differing arbitrarily little from $f(s)$, for all points of R_0 , whose poles are at one finite point c external to Γ . By a transformation of the form $t - c = r^2$, with the appropriate change in the rational function, we can suppose this point c to be at infinity, in which case the rational function becomes a polynomial. Suppose a_1, a_2, \dots to be an indefinitely continued sequence of real positive numbers, converging to zero, and P_r to be the polynomial such that, within C_0 , $|P_r - f(s)| < \epsilon$; then the infinite series of polynomials

$$P_1(s) + [P_2(s) - P_1(s)] + [P_3(s) - P_2(s)] + \dots$$

whose sum to n terms is $P_n(s)$, converges for all finite values of s and represents $f(s)$ within C_0 .

When C consists of a series of disconnected polygons, some of which may include others, and, by increasing indefinitely the number of sides of the polygons C , the points C become the boundary points Γ of a region, we can suppose the poles of the rational function, constructed to approximate to $f(s)$ within R_0 , to be at points of Γ . A series of rational functions of the form

$$H_1(z) + [H_2(z) - H_1(z)] + [H_3(z) - H_2(z)] + \dots$$

then, as before, represents $f(s)$ within R_0 . And R_0 may be taken to coincide as nearly as desired with the interior of the region bounded by Γ .

§ 11. *Expression of $(1-z)^{-1}$ by means of Polynomials*. *Applications*.—We pursue the ideas just cursorily explained in some further detail.

Let c be an arbitrary real positive quantity; putting the complex variable $\xi = \xi + i\eta$, enclose the points $\xi = 1$, $\xi = 1 + c$ by means of (i.) the straight lines $\eta = \pm a$, from $\xi = 1$ to $\xi = 1 + c$, (ii.) a semicircle convex to $\xi = 0$ of equation $(\xi - 1)^2 + \eta^2 = a^2$, (iii.) a semicircle concave to $\xi = 0$ of equation $(\xi - 1 - c)^2 + \eta^2 = a^2$. The quantities c and a are to remain fixed. Take a positive integer r so that

$$\frac{1}{r} \left(\frac{c}{a} \right) \text{ is less than unity, and put } \sigma = \frac{1}{r} \left(\frac{c}{a} \right).$$

$$a_1 = 1 + c/r, a_2 = 1 + 2c/r, \dots, a_r = 1 + c;$$

If n_1, n_2, \dots, n_r be positive integers, the rational function

$$\frac{1}{1-z} \left\{ 1 - \left(\frac{z-1}{c_1-z} \right)^{n_1} \right\}$$

is finite at $z=1$, and has a pole of order n_1 at $z=c_1$; the rational function

$$\frac{1}{1-z} \left\{ 1 - \left(\frac{z-1}{c_1-z} \right)^{n_1} \right\} \left\{ 1 - \left(\frac{z-c_1}{c_2-z} \right)^{n_2} \right\}^{n_2}$$

is thus finite except for $z=c_2$, where it has a pole of order $n_1 n_2$; finally, writing

$$x_i = \left(\frac{c_i - c_{i-1}}{c_i - z} \right)^{n_i}$$

the rational function

$$U = (1-z)^{-1} (1-x_1)(1-x_2) \dots (1-x_r)^{n_1 n_2 \dots n_r} \dots (1-x_{r-1})^{n_1 n_2 \dots n_{r-1}}$$

has a pole only at $z=1+c$, of order $n_1 n_2 \dots n_r$. The difference $(1-z)^{-1} U$ is of the form $(1-z)^{-1} P$, where P , of the form

$$\frac{1-(1-p_1)(1-p_2) \dots (1-p_r)}{2\beta_1 - 2\beta_2 p_1 + 2\beta_3 p_1 p_2 - \dots}$$

in which there are equalities among $\beta_1, \beta_2, \dots, \beta_r$ is of the form $\sum \beta_i - \sum \beta_i p_i + \sum \beta_i p_i p_j - \dots$; therefore, if $|\beta_i| = |\beta_j|$, we have $|P| < \sum r_i + \sum r_i r_j + \dots < (1+r_1)(1+r_2) \dots (1+r_r) - 1$; now, so long as β is without the closed curve above described round $z=1$, $\beta = 1 + \epsilon$, we have

$$\left| \frac{1}{1-\beta} \right| < \frac{1}{\epsilon} \left| \frac{c_m - c_{m-1}}{c_m - \beta} \right| < \frac{c_l r}{\epsilon} < \sigma,$$

and hence

$$|(1-z)^{-1} U| < \sigma^{-1} (1 + \sigma^{n_1}) (1 + \sigma^{n_1 n_2}) (1 + \sigma^{n_1 n_2 n_3}) \dots (1 + \sigma^{n_1 n_2 \dots n_r})$$

Take an arbitrary real positive ϵ , and μ , a positive number, so that $\sigma^{\mu-1} < \epsilon$, then a value of n_1 such that $\sigma^{n_1} < \mu/(1+\mu)$ and therefore $\sigma^{n_1}/(1-\sigma^{n_1}) < \mu$, and values for n_2, n_3, \dots such that $\sigma^{n_i} < \frac{1}{n_i} \sigma^{n_1}$,

$\sigma^{n_i} < \frac{1}{n_i n_2} \sigma^{n_1} \dots \sigma^{n_i} < \frac{1}{n_1 \dots n_{i-1}} \sigma^{n_1}$; then, as $1+x < e^x$, we have

$$|(1-z)^{-1} U| < \sigma^{-1} \exp(\sigma^{n_1} + n_1 \sigma^{n_1} + n_1 n_2 \sigma^{n_1} + \dots + n_1 n_2 \dots n_{r-1} \sigma^{n_1}) - 1,$$

and therefore less than

$$\sigma^{-1} \exp(\sigma^{n_1} + \sigma^{2n_1} + \dots + \sigma^{n_1 n_2} - 1),$$

which is less than

$$\frac{1}{\epsilon} \left[\exp \left(\frac{\sigma^{n_1}}{1-\sigma^{n_1}} \right) - 1 \right]$$

and therefore less than ϵ .

The rational function U , with a pole at $z=1+c$, differs therefore from $(1-z)^{-1}$, for all points outside the closed region put about $z=1$, $\beta = 1 + \epsilon$, by a quantity numerically less than ϵ . So long as ϵ remains the same, r and σ will remain the same, and a less value of ϵ will require at most an increase of the numbers n_1, n_2, \dots, n_r ; but if ϵ be taken smaller it may be necessary to increase r , and with this the complexity of the function U .

Now put

$$z = \frac{c}{c+1-\xi}, \quad \xi = \frac{c+1}{c+\beta};$$

thereby the points $z=0, 1, 1+c$ become the points $\xi=0, 1, \infty$, the function $(1-z)^{-1}$ being given by $(1-\xi)^{-1} = c(c+1)^{-1} (1-\xi)^{-2} + (c+1)^{-1}$; the function U becomes a rational function of ξ with a pole only at $\xi = \infty$, that is, it becomes a polynomial in ξ , say $\frac{c+1}{c} H - \frac{1}{c}$, where H is also a polynomial in ξ , and

$$\frac{1}{1-\xi} H = \frac{c}{c+1} \left[\frac{1}{1-\xi} U \right];$$

the lines $\eta = a\theta$ become the two circles expressed, if $z = x + iy$, by

$$(x+\epsilon)^2 + y^2 = \frac{c(c+1)}{a} y,$$

the points $(\eta=0, \xi=1-a)$, $(\eta=0, \xi=1+c+a)$ become respectively the points $(y=0, x=c(1-a)/(c+a))$, $(y=0, x=c(1+c+a)/a)$, whose limiting positions for $a=0$ are respectively $(y=0, x=1)$, $(y=0, x=\infty)$. The circle $(x+\epsilon)^2 + y^2 = c(c+1)y/a$ can be written

$$y = \frac{(x+\epsilon)^2}{2\mu} + \frac{(x+\epsilon)^2}{2\mu} \left[\mu + \sqrt{\mu^2 + (x+\epsilon)^2} \right]^{-1}$$

where $\mu = \frac{1}{2}c(c+1)/a$; its ordinate y , for a given value of x , can therefore be supposed arbitrarily small by taking a sufficiently small.

We have thus proved the following result; taking in the plane of ξ any finite region of which every interior and boundary point is at a finite distance, however short, from the points of the real axis for which $1 \leq \xi \leq \infty$, we can take a quantity a , and hence, with an arbitrary ϵ , determine a number r ; then corresponding to an arbitrary ϵ , we can determine a polynomial P_r , such that, for all points interior to the region, we have

$$|(1-\xi)^{-1} - P_r| < \epsilon;$$

thus the series of polynomials

$$P_1 + (P_2 - P_1) + (P_3 - P_2) + \dots$$

constructed with an arbitrary aggregate of real positive numbers $\epsilon_1, \epsilon_2, \epsilon_3, \dots$ with zero as their limit, converges uniformly and represents $(1-\xi)^{-1}$ for the whole region considered.

§ 12. *Expansion of a Monogenic Function in Polynomials, over a Star Region.*—Now consider any monogenic function $f(z)$ of which the origin is not a singular point; joining the origin to any singular point by a straight line, let the part of this straight line, produced beyond the singular point, lying between the singular point and $z = \infty$, be regarded as a barrier in the plane, the portion of this straight line from the origin to the singular point being erased. Consider next any finite region of the plane, whose boundary points constitute a path of integration, in a sense previously explained, of which every point is at a finite distance greater than zero from each of the barriers before explained; we suppose this region to be such that any line joining the origin to a boundary point, when produced, does not meet the boundary again. For every point x in this region R we can then write

$$2\pi i f(x) = \int \frac{dt}{t} \frac{f(t)}{1-t},$$

where $f(x)$ represents a monogenic branch of the function, in case it be not everywhere single valued, and t is on the boundary of the region. Describe now another region R_0 lying entirely within R , and let x be restricted to be within R_0 or upon its boundary; then for any point t on the boundary of R , the points s of the plane for which xs^{-1} is real and positive and equal to or greater than 1, being points for which $|s|=|t|$ or $|s|>|t|$, are without the region R_0 , and not infinitely near to its boundary points. Taking then an arbitrary real positive ϵ we can determine a polynomial in xs^{-1} , say $P(xs^{-1})$, such that for all points s in R_0 we have

$$|(1-xs^{-1})^{-1} - P(xs^{-1})| < \epsilon;$$

the form of this polynomial may be taken the same for all points t on the boundary of R , and hence, if E be a proper variable quantity of modulus not greater than ϵ ,

$$\left| 2\pi i f(x) - \int \frac{dt}{t} f(t) P(xs^{-1}) \right| = \left| \int \frac{dt}{t} f(t) E \right| \leq L M,$$

where L is the length of the path of integration, the boundary of R , and M is a real positive quantity such that upon this boundary $|t^{-1} f(t)| < M$. If now

$$P(xs^{-1}) = c_0 + c_1 x t^{-1} + \dots + c_n x^n t^{-n},$$

and

$$\frac{1}{2\pi i} \int_{R_0} t^{-1} f(t) dt = \mu,$$

this gives

$$|f(x) - [c_0 \mu + c_1 \mu x + \dots + c_n \mu x^n]| \leq \epsilon L M / 2\pi,$$

where the quantities $\mu_0, \mu_1, \mu_2, \dots$ are the coefficients in the expansion of $f(x)$ about the origin.

If then an arbitrary finite region be constructed of the kind explained, excluding the barriers joining the singular points of $f(x)$ to $x = \infty$, it is possible, corresponding to an arbitrary real positive number ϵ , to determine a number m , and a polynomial $Q(x)$, of order m , such that for all interior points of this region

$$|f(x) - Q(x)| < \epsilon.$$

Hence as before, within this region $f(x)$ can be represented by a series of polynomials, converging uniformly; when $f(x)$ is not a single valued function the series represents one branch of the function.

The same result can be obtained without the use of Cauchy's integral. We explain briefly the character of the proof. If a monogenic function of t , $\phi(t)$ be capable of expression as a power series in $t-x$ about a point x , for $|t-x| \leq \rho$, and for all points of this circle $|\phi(t)| < g$, we know that $|\phi^{(n)}(x)| < g \rho^{-n} (n!)$. Hence, taking $|z| < \frac{1}{2}\rho$, and, for any assigned positive integer μ , taking m so that for $n > m$ we have $(\mu+n)! < (n!)^2$, we have

$$\left| \frac{\phi^{(\mu+n)}(x) z^n}{(\mu+n)!} \right| < \frac{\phi^{(\mu+n)}(x)}{(\mu+n)!} (\mu+n)! |z|^n < \frac{g}{\mu+n} \left(\frac{1}{2} \right)^n \left(\frac{n}{2} \right)^n < \frac{g}{\mu 2^{2\mu}}$$

and therefore

$$\phi^{(\mu)}(x+z) = \sum_{n=0}^{\infty} \frac{\phi^{(\mu+n)}(x)}{n!} z^n + \epsilon_{\mu},$$

where

$$|\epsilon_{\mu}| < \frac{g}{\rho^{\mu}} \sum_{n=\mu+1}^{\infty} \frac{1}{2^n} < \frac{g}{\rho^{\mu} 2^{\mu}}.$$

Now draw barriers as before, directed from the origin, joining the singular point of $\phi(z)$ to $z = \infty$, take a finite region excluding all these barriers, let ρ be a quantity less than the radii of convergence of all the power series developments of $\phi(z)$ about interior points of this region, so chosen moreover that no circle of radius ρ with centre at an interior point of the region includes any singular point of $\phi(z)$, let g be such that $|g(z)| < g$ for all circles of radius ρ whose centres are interior points of the region, and, x being any interior point of the region, choose the positive integer μ so that $\frac{1}{2}|x| < \frac{1}{2}\rho$; then take the points $a_1 = x/\mu$, $a_2 = 2x/\mu$, $a_3 = 3x/\mu, \dots, a_n = x$; it is supposed that the region is so taken that, whatever x may be, all these are interior points of the region. Then by what has been said, replacing x, z respectively by 0 and x/μ , we have

$$\phi^{(n)}(a_2) = \sum_{\lambda_1=0}^{m_1} \frac{\phi^{(n+\lambda_1)}(a_1)}{\lambda_1!} \left(\frac{x}{n}\right)^{\lambda_1} + \beta_n$$

with

provided $(n+m_1+1)^n < (1!)^{m_1+1}$; in fact for $\mu \in \mathbb{Z}^{m_1+1}$ it is sufficient to take $m_1 = n^{\mu}$; by another application of the same inequality, replacing x, z respectively by a_1 and x/n , we have

$$\phi^{(n)}(a_2) = \sum_{\lambda_2=0}^{m_2} \frac{\phi^{(n+\lambda_2)}(a_1)}{\lambda_2!} \left(\frac{x}{n}\right)^{\lambda_2} + \beta_n'$$

where

$$|\beta_n'| < 2g/\rho^{2m_2}$$

provided $(n+m_2+1)^n < (1!)^{m_2+1}$; we take $m_2 = n^{2m_1}$, supposing $\mu < n^{2m_1-1}$. So long as $\lambda_1 \in \mathbb{Z}^{m_1+1}$ and $\mu < n^{2m_1-1}$ we have $n+\lambda_2 < 2n^{2m_1-1}$, and we can use the previous inequality to substitute here for $\phi^{(n+\lambda_2)}(a_1)$. When this is done we find

$$\phi^{(n)}(a_2) = \sum_{\lambda_1=0}^{m_1} \sum_{\lambda_2=0}^{m_2} \frac{\phi^{(n+\lambda_1+\lambda_2)}(a_1)}{\lambda_1! \lambda_2!} \left(\frac{x}{n}\right)^{\lambda_1+\lambda_2} + \beta_n''$$

where $|\beta_n''| < 2g/\rho^{2m_2}$, the numbers m_1, m_2 being respectively n^{μ} and n^{2m_1} .

Applying then the original inequality to $\phi^{(n)}(a_2) = \phi^{(n)}(a_1 + \pi/n)$, and then using the series just obtained, we find a series for $\phi^{(n)}(a_2)$. This process being continued, we finally obtain

$$\phi(x) = \sum_{\lambda_1=0}^{m_1} \sum_{\lambda_2=0}^{m_2} \dots \sum_{\lambda_k=0}^{m_k} \frac{\phi^{(k)}(a_1)}{k!} \left(\frac{x}{n}\right)^{\lambda_1+\lambda_2+\dots+\lambda_k}$$

where $k = \lambda_1 + \lambda_2 + \dots + \lambda_m$, $K = \lambda_1! \lambda_2! \dots \lambda_m!$, $m_1 = n^{\mu}$, $m_2 = n^{2m_1}, \dots, m_m = n^{\mu^m}$, $|\epsilon| < 2g/2^m$.

By this formula $\phi(x)$ is represented, with any required degree of accuracy, by a polynomial, within the region in question; and thence can be expressed as before by a series of polynomials converging uniformly (and absolutely) within this region.

§ 13. Application of Cauchy's Theorem to the Determination of Definite Integrals.—Some reference must be made to a method whereby real definite integrals may frequently be evaluated by use of the theorem of the vanishing of the integral of a function of a complex variable round a contour within which the function is single valued and non-singular.

We are to evaluate an integral $\int_a^b f(x)dx$; we form a closed contour of which the portion of the real axis from $x=a$ to $x=b$ forms a part, and consider the integral $\int f(z)dz$ round this contour, supposing that the value of this integral can be determined along the curve forming the completion of the contour. The contour being supposed such that, within it, $f(z)$ is a single valued and finite function of the complex variable z save at a finite number of isolated interior points, the contour integral is equal to the sum of the values of $\int f(z)dz$ taken round these points. Two instances will suffice to explain the method. (1) The integral $\int_0^{\infty} \frac{\tan x}{x} dx$ is convergent if it be understood to mean the limit when a, ϵ, \dots all vanish of the sum of the integrals

$$\int_a^{a+\pi} \frac{\tan x}{x} dx, \int_{1+\pi}^{1+2\pi} \frac{\tan x}{x} dx, \int_{1+2\pi}^{1+3\pi} \frac{\tan x}{x} dx, \dots$$

Now draw a contour consisting in part of the whole of the positive and negative real axis from $x=-n\pi$ to $x=+n\pi$, where n is a positive integer, broken by semicircles of small radius whose centres are the points $x = \pm i\pi, x = \pm 3i\pi, \dots$, the contour containing also the lines $x = n\pi$ and $x = -n\pi$ for values of y between 0 and $n\pi \tan a$, where a is a small fixed angle, the contour being completed by the portion of a semicircle of radius $n\pi \sec a$ which lies in the upper half of the plane and is terminated at the points $x = \pm n\pi, y = n\pi \tan a$. Round this contour the integral $\int \frac{\tan z}{z} dz$ has the value zero. The contributions to this contour integral arising from the semicircles of centres $\pm i(2s-1)\pi, \pm i(2s-1)3\pi$, supposed of the same radius, are at once seen to have a sum which ultimately vanishes when the radius of the semicircles diminishes to zero. The part of the contour lying on the real axis gives what is meant by $\int_0^{\infty} \frac{\tan x}{x} dx$. The contribution to the contour integral from the two straight portions at $x = \pm n\pi$ is

$$\int_0^{n\pi \tan a} \frac{\tan iy}{n\pi + iy} dy - \int_0^{n\pi \tan a} \frac{\tan iy}{-n\pi + iy} dy$$

where $i \tan iy = -[\exp(iy) - \exp(-iy)] / [\exp(iy) + \exp(-iy)]$, is a real quantity which is numerically less than unity, so that the contribution in question is numerically less than

$$\int_0^{n\pi \tan a} dy \frac{2n\pi}{n^2\pi^2 + y^2}, \text{ that is than } 2a.$$

Finally, for the remaining part of the contour, for which, with $R = n\pi \sec a$, we have $z = R(\cos \theta + i \sin \theta) = RE(i\theta)$, we have

$$\frac{dz}{z} = i d\theta, i \tan z = \frac{\exp(-R \sin \theta) E(iR \cos \theta) - \exp(R \sin \theta) E(-iR \cos \theta)}{\exp(-R \sin \theta) E(iR \cos \theta) + \exp(R \sin \theta) E(-iR \cos \theta)}$$

when n and therefore R is very large, the limit of this contribution to the contour integral is thus

$$-\int_{-\pi/2}^{\pi/2} d\theta = -(\pi - 2a).$$

Making n very large the result obtained for the whole contour is

$$2 \int_0^{\infty} \frac{\tan x}{x} dx - (\pi - 2a) - 2a = 0,$$

where a is numerically less than unity. Now supposing a to diminish to zero we finally obtain

$$\int_0^{\infty} \frac{\tan x}{x} dx = \frac{\pi}{2}.$$

(2) For another case, to illustrate a different point, we may take the integral

$$\int_{-1}^{+1} \frac{z^a}{1+z} dz,$$

wherein a is real quantity such that $0 < a < 1$, and the contour consists of a small circle, $z = rE(i\theta)$, terminated at the points $x = r \cos a, y = r \sin a$, where a is small, of the two lines $y = r \sin a$ for $r \cos a \in \mathbb{R} \cos \beta$, where $R \sin \beta = r \sin a$, and finally of a large circle $z = RE(i\theta)$, terminated at the points $x = R \cos \beta, y = R \sin \beta$. We suppose a and β both zero, and that the phase of z is zero for $r \cos a \in \mathbb{R} \cos \beta, y = r \sin a = R \sin \beta$. Then on $r \cos a \in \mathbb{R} \cos \beta, y = r \sin a$, the phase of z will be πr , and z^{a-1} will be equal to $z^{a-1} \exp[\pi i r(a-1)]$, where r is real and positive. The two straight portions of the contour will thus together give a contribution

$$[1 - \exp(\pi i a)] \int_{r \cos a}^{R \cos \beta} \frac{z^{a-1}}{1+z} dz.$$

It can easily be shown that if the limit of $f(z)$ for $z \rightarrow \infty$ is zero, the integral $\int f(z)dz$ taken round an arc, of given angle, of a small circle enclosing the origin is ultimately zero when the radius of the circle diminishes to zero, and if the limit of $f(z)$ for $z \rightarrow \infty$ is zero, the same integral taken round an arc, of given angle, of a large circle whose centre is the origin is ultimately zero when the radius of the circle increases indefinitely; in our case with $f(z) = z^{a-1}/(1+z)$, we have $f(z) = z^{a-1}/(1+z)$, which, for $0 < a < 1$, diminishes to zero both for $z \rightarrow 0$ and for $z \rightarrow \infty$. Thus, finally the limit of the contour integral when $r \rightarrow 0, R \rightarrow \infty$ is

$$[1 - \exp(\pi i a)] \int_0^{\infty} \frac{z^{a-1}}{1+z} dz.$$

Within the contour $f(z)$ is single valued, and has a pole at $z = -1$; at this point the phase of z is π and $z^{a-1} = \exp[i\pi(a-1)] = -\exp(i\pi a)$; this is then the residue of $f(z)$ at $z = -1$; we thus have

$$[1 - \exp(\pi i a)] \int_0^{\infty} \frac{z^{a-1}}{1+z} dz = -2\pi i \exp(i\pi a).$$

that is

$$\int_0^{\infty} \frac{z^{a-1}}{1+z} dz = \pi \operatorname{cosec}(\pi a).$$

§ 14. Doubly Periodic Functions.—An excellent illustration of the preceding principles is furnished by the theory of single valued functions having in the finite part of the plane no singularities but poles, which have two periods.

Before passing to this it may be convenient to make here a few remarks as to the periodicity of (single valued) monogenic functions. To say that $f(z)$ is periodic is to say that there exists a constant ω such that for every point z of the interior of the region of existence of $f(z)$ we have $f(z+\omega) = f(z)$. This involves, considering all existing periods $\omega = \rho + i\sigma$, that there exists a lower limit of $\rho^2 + \sigma^2$ other than zero; for otherwise all the differential coefficients of $f(z)$ would be zero, and $f(z)$ a constant; we can then suppose that not both ρ and σ are numerically less than a , where $a > 0$. Hence, if g be any real quantity, since the range $(-g, \dots, g)$ contains only a finite number of intervals of length a , and there cannot be two periods $\omega = \rho + i\sigma$ such that $\mu\omega \in (-\mu+1)a, \nu\omega \in (-\nu+1)a$, where μ, ν are integers, it follows that there is only a finite number of periods for which both ρ and σ are in the interval $(-g, \dots, g)$. Considering then all the periods of the function which are real multiples of one period ω_0 , and in particular those periods $\lambda\omega_0$ wherein $0 < \lambda \leq 1$, there is a lower limit for λ , greater than zero, and therefore, since there is only a finite number of such periods for which the real and imaginary parts both lie between $-g$ and g , a least value of λ , say λ_0 . If $\Omega = \lambda_0\omega_0$ and $\lambda = M\lambda_0 + \lambda'$, where M is an integer and $0 < \lambda' < \lambda_0$, any period $\lambda\omega_0$ is of the form $M\Omega + \lambda'\omega_0$; since, however, $\Omega, M\Omega$ and $\lambda_0\omega_0$ are periods, so also is $\lambda'\omega_0$, and hence, by the construction of λ_0 , we have $\lambda' = 0$, thus all periods which are real multiples of ω_0 are expressible in the form $M\Omega$, where M is an integer, and Ω a period.

If beside ω the functions have a period ω' which is not a real multiple of ω , consider all existing periods of the form $\mu\omega + \nu\omega'$ wherein μ, ν are real, and of these those for which $0 < \mu \leq 1, 0 < \nu \leq 1$;

as before there is a least value for ν , actually occurring in one or more periods, say in the period $\Omega = \mu\omega + m\omega'$; now take, if $\mu\omega + m\omega'$ be a period, $\nu = N'\omega + \nu'$, where N' is an integer, and $0 \leq \nu' < \omega$; whence $\mu\omega + m\omega' = \mu\omega + N'\omega + \nu'$; take then $\mu - N'\omega = N\omega + \lambda$; where N is an integer and λ is as above, and $0 \leq \lambda < \omega$, we thus have a period $N\Omega + N'\Omega + \lambda + \nu'$, and hence a period $N\omega + \nu'$, wherein $N < \lambda$, $\nu' < \omega$; hence $\nu' = 0$ and $N' = 0$. All periods of the form $\mu\omega + m\omega'$ are thus expressible in the form $N\Omega + N'\Omega$, where Ω, Ω' are periods and N, N' are integers. But in fact any complex quantity, $P + iQ$, and in particular any other possible period of the function, is expressible, with μ, ν real, in the form $\mu\omega + m\omega'$; for if $\omega = p + i\sigma$, $\omega' = p' + i\sigma'$, this requires only $P = \mu p + m p'$, $Q = \mu \sigma + m \sigma'$, equations which, since ω/ω' is not real, always give finite values for μ and ν .

It thus appears that if a single valued monogenic function of z be periodic, either all its periods are real multiples of one of them, and then all are of the form $M\Omega$, where Ω is a period and M is an integer, or else, if the function have two periods whose ratio is not real, then all its periods are expressible in the form $N\Omega + N'\Omega'$, where Ω, Ω' are periods, and N, N' are integers. In the former case, putting $f = z\pi i/\Omega$, and the function $f(z) = \phi(f)$, the function $\phi(f)$ has, like $\exp(\Omega z)$, the period $2\pi i$, and if we take $t = \exp(\Omega z)$ or $f = \lambda(t)$ the function is a single valued function of t . If in particular $f(z)$ is an integral function, regarded as a function of t , it has singularities only for $t = 0$ and $t = \infty$, and may be expanded in the form $\sum a_n t^n$.

Taking the case when the single valued monogenic function has two periods ω, ω' whose ratio is not real, we can form a network of parallelograms covering the plane of z whose angular points are the points $c + m\omega + m'\omega'$, wherein c is some constant and m, m' are all possible positive and negative integers, choosing arbitrarily one of these parallelograms, and calling it the primary parallelogram, all the values of which the function is at all capable occur for points of this primary parallelogram, any point, z' , of the plane being, as it is called, congruent to a definite point, z , of the primary parallelogram, z' being of the form $m\omega + m'\omega'$, where m, m' are integers. Such a function cannot be an integral function, since then, if, in the primary parallelogram $f(z) < M$, it would also be the case, on a circle of centre the origin and radius R , that $f(z) < M$, and therefore, if $\sum a_n z^n$ be the expansion of the function, which is valid for an integral function for all finite values of z , we should have $|a_n| < MR^{-n}$, which can be made arbitrarily small by taking R large enough. The function must then have singularities for finite values of z .

We consider only functions for which these are poles. Of these there cannot be an infinite number in the primary parallelogram, since then those of these poles which are sufficiently near to one of the necessarily existing limiting points of the poles would be arbitrarily near to one another, contrary to the character of a pole. Supposing the constant ϵ used in naming the corners of the parallelograms so chosen that no pole falls on the perimeter of a parallelogram,

it is clear that the integral $\frac{1}{2\pi i} \int f(z) dz$ round the perimeter of the primary parallelogram vanishes; for the elements of the integral corresponding to two such opposite perimeter points as $z, z + \omega$ (or as $z, z + \omega'$) are mutually destructive. This integral is, however, equal to the sum of the residues of $f(z)$ at the poles interior to the parallelogram. Which sum is therefore zero. There cannot therefore be such a function having only one pole of the first order in any parallelogram; we shall see that there can be such a function with two poles only in any parallelogram, each of the first order, with residues whose sum is zero, and that there can be such a function with one pole of the second order, having an expansion near this pole of the form $(z-a)^{-2} + (\text{power series in } z-a)$.

Considering next the function $\phi(z) = [f(z)]^{-1} \frac{df(z)}{dz}$, it is easily seen that an ordinary point of $f(z)$ is an ordinary point of $\phi(z)$, that a zero of order m for $f(z)$ in the neighbourhood of which $f(z)$ has a form, $(z-a)^m$ multiplied by a power series, is a pole of $\phi(z)$ of residue m , and that a pole of $f(z)$ of order n is a pole of $\phi(z)$ of residue $-n$; manifestly $\phi(z)$ has the two periods of $f(z)$. We thus infer, since the sum of the residues of $\phi(z)$ is zero, that for the function $f(z)$, the sum of the orders of its vanishing at points belonging to one parallelogram, $\sum m$, is equal to the sum of the orders of its poles, $\sum n$; which is briefly expressed by saying that the number of its zeros is equal to the number of its poles. Applying this theorem to the function $f(z) = A$, where A is an arbitrary constant, we have the result, that the function $f(z)$ assumes the value A in one of the parallelograms as many times as it becomes infinite. Thus, by what is proved above, every conceivable complex value does arise as a value for the doubly periodic function $f(z)$ in any one of its parallelograms, and in fact at least twice. The number of times it arises is called the order of the function; the result suggests a property of rational functions.

Consider further the integral $\int \frac{f'(z)}{f(z)} dz$, where $f'(z) = \frac{df(z)}{dz}$, taken round the perimeter of the primary parallelogram; the contribution to this arising from two opposite perimeter points such as z and $z + \omega$ is of the form $-\omega \int \frac{f'(z)}{f(z)} dz$, which, as z increases from z_0 to $z_0 + \omega'$, gives,

if λ denote the generalized logarithm, $-\omega \lambda[f(z_0 + \omega)] - \lambda[f(z_0)]$, that is, since $f(z_0 + \omega) = f(z_0)$, gives $2\pi i N\omega$, where N is an integer; similarly the result of the integration along the other two opposite sides is of the form $2\pi i N'\omega'$, where N' is an integer. The integral, however, is equal to $2\pi i$ times the sum of the residues of $f'(z)/f(z)$ at the poles interior to the parallelogram. For a zero, of order m , of $f(z)$ at $z = a$, the contribution to this sum is $2\pi i m a$; for a pole of order n at $z = b$ the contribution is $-2\pi i n b$; we thus infer that $\sum m a - \sum n b = N\omega + N'\omega'$; this we express in words by saying that the sum of the values of z where $f(z) = 0$ within any parallelogram is equal to the sum of the values of z where $f(z) = \infty$ save for integral multiples of the periods. By considering similarly the function $f(z) - A$ where A is an arbitrary constant, we prove that each of these sums is equal to the sum of the values of z where the function takes the value A in the parallelogram.

We pass now to the construction of a function having two arbitrary periods ω, ω' of unreal ratio, which has a single pole of the second order in any one of its parallelograms.

For this consider first the network of parallelograms whose corners are the points $\Omega = m\omega + m'\omega'$, where m, m' take all positive and negative integer values, putting a small circle about each corner of this network, let P be a point outside all these circles; this will be interior to a parallelogram whose corners in order may be denoted by $z_0, z_0 + \omega, z_0 + \omega + \omega', z_0 + \omega'$; we shall denote $z_0, z_0 + \omega$ by A_0, B_0 ; this parallelogram Π_0 is surrounded by eight other parallelograms, forming with Π_0 a larger parallelogram Π_1 , of which one side, for instance, contains the points $z_0 - \omega - \omega', z_0 - \omega', z_0 - \omega' + \omega, z_0 - \omega' + 2\omega$, which we shall denote by A_1, B_1, C_1, D_1 . This parallelogram Π_1 is surrounded by sixteen of the original parallelograms, forming with Π_1 a still larger parallelogram Π_2 of which one side, for instance, contains the points $z_0 - 2\omega - 2\omega', z_0 - 2\omega', z_0 + \omega - 2\omega', z_0 + 2\omega - 2\omega', z_0 + 3\omega - 2\omega'$, which we shall denote by $A_2, B_2, C_2, D_2, E_2, F_2$. And so on. Now consider the sum of the inverse cubes of the distances of the point P from the corners of all the original parallelograms. The sum will contain the terms

$$S_0 = \frac{1}{PA_0^3} + \left(\frac{1}{PA_1^3} + \frac{1}{PB_1^3} + \frac{1}{PC_1^3} \right) + \left(\frac{1}{PA_2^3} + \frac{1}{PB_2^3} + \dots + \frac{1}{PF_2^3} \right) + \dots$$

and three other sets of terms, each infinite in number, formed in a similar way. If the perpendiculars from P to the sides $A_0 B_0, A_1 B_1 C_1, A_2 B_2 C_2 D_2 E_2$, and so on, be $p, p + q, p + 2q$ and so on, the sum S_0 is at most equal to

$$\frac{1}{p^3} + \frac{3}{(p+q)^3} + \frac{5}{(p+2q)^3} + \dots + \frac{2n+1}{(p+nq)^3} + \dots$$

of which the general term is ultimately, when n is large, in a ratio of equality with $2q^{-3}n^{-3}$, so that the series S_0 is convergent, as we know the sum $\sum n^{-3}$ to be, this assumes that $p \neq 0$; if P be on $A_0 B_0$ the proof for the convergence of $S_0 = 1/PA_0^3$ is the same. Taking the three other sums analogous to S_0 we thus reach the result that the series

$$\phi(z) = -2\pi(z - \Omega)^{-2}$$

where Ω is $m\omega + m'\omega'$, and m, m' are to take all positive and negative integer values, and z is any point outside small circles described with the points Ω as centres, is absolutely convergent. Its sum is therefore independent of the order of its terms. By the nature of the proof, which holds for all positions of z outside the small circles spoken of, the series is also clearly uniformly convergent outside these circles. Each term of the series being a monogenic function of z , the series may therefore be differentiated and integrated outside these circles, and represents a monogenic function. It is clearly periodic with the periods ω, ω' ; for $\phi(z + \omega)$ is the same sum as $\phi(z)$ with the terms in a slightly different order. Thus $\phi(z + \omega) = \phi(z)$ and $\phi(z + \omega') = \phi(z)$.

Consider now the function

$$f(z) = \frac{1}{z^2} + \sum_0^{\infty} \left\{ \phi(z) + \frac{2}{z^2} \right\} dz,$$

where, for the subject of integration, the area of uniform convergence clearly includes the point $z = 0$; this gives

$$\frac{df(z)}{dz} = \phi(z)$$

and

$$f(z) = \frac{1}{z^2} + \sum' \left\{ \frac{1}{(z-\Omega)^2} - \frac{1}{\Omega^2} \right\},$$

wherein \sum' is a sum excluding the term for which $m = 0$ and $m' = 0$. Hence $f(z + \omega) - f(z)$ and $f(z + \omega') - f(z)$ are both independent of z . Noticing, however, that, by its form, $f(z)$ is an even function of z , and putting $z = -\omega, z = -\omega'$ respectively, we infer that also $f(z)$ has the two periods ω and ω' . In the primary parallelogram Π_0 , however, $f(z)$ is only infinite at $z = 0$ in the neighbourhood of which its expansion is of the form $z^{-2} + (\text{power series in } z)$. Thus $f(z)$ is such a doubly periodic function as was to be constructed, having in any parallelogram of periods only one pole, of the second order.

It can be shown that any single valued meromorphic function of z with ω and ω' as periods can be expressed rationally in terms of $f(z)$ and $\phi(z)$, and that $[\phi(z)]^2$ is of the form $4f(z)^2 + Af(z) + B$, where A, B are constants.

To prove the last of these results, we write, for $|x| < 1$,

$$\frac{1}{(x-1)^2} = \frac{2x}{1-x} + \frac{3x^2}{1-x^2} + \dots$$

and hence, if $x^m = a$, since $x^{m-1} = 0$, we have, for sufficiently small x greater than zero,

$$f(x) = x^{-2} + 3x^m + 5x^{2m} + \dots$$

and

$$\phi(x) = -2x^{-2} + 6x^m + 20x^{2m} + \dots$$

using these series we find that the function

$$F(x) = [\phi(x)]^2 - 4[f(x)]^2 + 60x^m f(x) + 140x^{2m}$$

contains no negative powers of x , being equal to a power series in x^m beginning with a term in x^m . The function $F(x)$ is, however, doubly periodic, with periods ω, ω' , and can only be infinite when either $f(x)$ or $\phi(x)$ is infinite; this follows from its form in $f(x)$ and $\phi(x)$; thus in one parallelogram of periods it can be infinite only when $x=0$; we have proved, however, that it is not infinite, but, on the contrary, vanishes, when $x=0$. Being, therefore, never infinite for finite values of x it is a constant, and therefore necessarily always zero. Putting therefore $f(x) = f$ and $\phi(x) = \phi$ we find we see that

$$\frac{d^2 f}{dx^2} = (4f^2 - 60x^m f - 140x^{2m})^{-1}$$

Historically it was in the discussion of integrals such as

$$\int dx \sqrt{4x^2 - 60x^m - 140x^{2m}}$$

regarded as a branch of Integral Calculus, that the doubly periodic functions arose. As in the familiar case

$$y = \int_0^x \sqrt{1-t^2} dt$$

where $t = \sin x$, it has proved finally to be simpler to regard f as a function of x . We shall come to the other point of view below, under § 20, *Elliptic Integrals*.

To prove that any doubly periodic function $F(x)$ with periods ω, ω' , having poles at the points $x = a_1, \dots, x = a_m$ of a parallelogram, these being, for simplicity of explanation, supposed to be all of the first order, is rationally expressible in terms of $\phi(x)$ and $f(x)$, and we proceed as follows:—

Consider the expression

$$\Phi(x) = \frac{(f-1)_m + \eta(f-1)_{m-1}}{(f-A_1)(f-A_2) \dots (f-A_m)}$$

where $A_s = f(a_s)$, f is an abbreviation for $f(x)$ and η for $\phi(x)$, and $(f-1)_m, (f-1)_{m-1}, \dots$ denote integral polynomials in f , of respective orders m and $m-1$, so that there are $2m$ unspecified, homogeneously entering, constants in the numerator. It is supposed that no one of the points a_1, \dots, a_m is one of the points $m\omega + m'\omega'$ where $f(x) = \infty$. The function $\Phi(x)$ is a meromorphic function of x with the periods ω, ω' , becoming infinite (and having singularities) only when (1) $f = \infty$ or (2) one of the factors $f - A_s$ is zero. In a period parallelogram including $x=0$ the first arises only for $x=0$; since for $f = \infty, \eta$ is in a finite ratio to $f^{3/2}$, the function $\Phi(x)$ for $f = \infty$ is not infinite provided the coefficient of f^m in $(f-1)_m$ is not zero; thus $\Phi(x)$ is regular about $x=0$. When $f = A_s = 0$, that is $f(x) = f(a_s)$, we have $\eta = a_s + m\omega + m'\omega'$, and no other values of x, m and m' being integers; suppose the unspecified coefficients in the numerator so taken that the numerator vanished to the first order in each of the m points $-a_1, -a_2, \dots, -a_m$; that is, if $\phi(a_s) = B_s$, and therefore $\phi(-a_s) = -B_s$ so that we have the m relations

$$(A_s, 1)_m - B_s(A_s, 1)_{m-1} = 0$$

then the function $\Phi(x)$ will only have the m poles a_1, \dots, a_m . Denoting further the m zeros of $F(x)$ by a'_1, \dots, a'_m , putting $f(a'_s) = A'_s, \phi(a'_s) = B'_s$, suppose the coefficients of the numerator of $\Phi(x)$ to satisfy the further $m-1$ conditions

$$(A'_s, 1)_m + B'_s(A'_s, 1)_{m-1} = 0$$

for $s=1, 2, \dots, (m-1)$. The ratios of the $2m$ coefficients in the numerator of $\Phi(x)$ can always be chosen so that the $m+1$ linear conditions are all satisfied. Consider then the ratio

$$F(x) = \Phi(x)$$

it is a doubly periodic function with no singularity other than the one pole a'_m . It is therefore a constant, the numerator of $\Phi(x)$ vanishing spontaneously in a'_m . We have

$$F(x) = A\phi(x),$$

where A is a constant; by which $F(x)$ is expressed rationally in terms of $f(x)$ and $\phi(x)$, as was desired.

When $x=0$ is a pole of $F(x)$, say of order r , the other poles, each of the first order, being a_1, \dots, a_m , similar reasoning can be applied to a function

$$\frac{(f, 1)_k + \eta(f, 1)_k}{(f-A_1) \dots (f-A_m)}$$

where k, k' are such that the greater of $2k-2m, 2k'+3-2m$ is equal to r ; the case where some of the poles a_1, \dots, a_m are multiple is to be met by introducing corresponding multiple factors in the denominator and taking a corresponding numerator. We give a solution of the general problem below, of a different form.

One important application of the result is the theorem that the

functions $f(x+\theta), \phi(x+\theta)$, which are such doubly periodic function of x as have been discussed, can each be expressed, so far as they depend on x , rationally in terms of $f(x)$ and $\phi(x)$, and therefore, so far as they depend on x and t , rationally in terms of $f(x), f(t), \phi(x)$ and $\phi(t)$. It can in fact be shown, by reasoning analogous to that given above, that

$$f(x+\theta) + f(x) + f(t) = \frac{1}{2} \left[\frac{\phi(x) - \phi(t)}{f(x) - f(t)} \right]^2$$

This shows that if $F(x)$ be any single valued meromorphic function which is doubly periodic and of meromorphic character, then $F(x+\theta)$ is an algebraic function of $F(x)$ and $F(t)$. Conversely any single valued meromorphic function of meromorphic character, $F(x)$, which is such that $F(x+\theta)$ is an algebraic function of $F(x)$ and $F(t)$, can be shown to be a doubly periodic function, or a function obtained from such by degeneration (in virtue of special relations connecting the fundamental constants).

The functions $f(x), \phi(x)$ above are usually denoted by $\mathfrak{F}(x), \mathfrak{F}'(x)$; further the fundamental differential equation is usually written

$$(\mathfrak{F}'(x))^2 = 4(\mathfrak{F}(x))^2 - g_2\mathfrak{F}(x) - g_3$$

and the roots of the cubic on the right are denoted by e_1, e_2, e_3 ; for the odd function, $\mathfrak{F}'(x)$ we have, for the congruent arguments $-\frac{1}{2}\omega$ and $\frac{1}{2}\omega, \mathfrak{F}'(\frac{1}{2}\omega) = -\mathfrak{F}'(-\frac{1}{2}\omega)$, and hence $\mathfrak{F}(\frac{1}{2}\omega) = e_1$; hence we can take $e_1 = \mathfrak{F}(\frac{1}{2}\omega), e_2 = \mathfrak{F}(\frac{1}{2}\omega + \frac{1}{2}\omega'), e_3 = \mathfrak{F}(\frac{1}{2}\omega')$. It can then be proved that $[\mathfrak{F}(x) - e_1][\mathfrak{F}(x + \frac{1}{2}\omega) - e_1] = (e_1 - e_2)(e_1 - e_3)$, with similar equations for the other half periods. Consider more particularly the function $\mathfrak{F}(x) - e_1$; like $\mathfrak{F}(x)$ it has a pole of the second order at $x=0$, its expansion in its neighbourhood being of the form $x^{-2}(1 - e_1x^2 + A_2x^4 + \dots)$, having no other pole, it has therefore either two zeros, or a double zero in a period parallelogram (ω, ω') . In fact near its zero $\frac{1}{2}\omega$ its expansion is $(x - \frac{1}{2}\omega)\mathfrak{F}'(\frac{1}{2}\omega) + \frac{1}{2}(x - \frac{1}{2}\omega)^2 \mathfrak{F}''(\frac{1}{2}\omega) + \dots$; we have seen that $\mathfrak{F}'(\frac{1}{2}\omega) = 0$; thus it has a zero of the second order wherever it vanishes. Thus it appears that the square root

$[\mathfrak{F}(x) - e_1]^{\frac{1}{2}}$, if we attach a definite sign to it for some particular value of x , is a single valued function of x ; for it can at most have two values, and the only small circuits in the plane which could lead to an interchange of these values are those about either a pole or a zero, neither of which, as we have seen, has this effect; the function is therefore single valued for any circuit. Denoting the function, for a moment, by $f_1(x)$, we have $f_1(x+\omega) = \pm f_1(x), f_1(x+\omega') = \pm f_1(x)$; it can be seen by considerations of continuity that the right sign in either of these equations does not vary with x ; not both these signs can be positive, since the function has only one pole, of the first order, in a parallelogram (ω, ω') , from the expansion of $f_1(x)$ about $x=0$, namely $x^{-1}(1 - \frac{1}{2}e_1x^2 + \dots)$, it follows that $f_1(x)$ is an odd function, and hence $f_1(-\frac{1}{2}\omega) = -f_1(\frac{1}{2}\omega)$, which is not zero since $[f_1(\frac{1}{2}\omega)]^2 = e_2 - e_1$, so that we have $f_1(x+\omega) = -f_1(x)$, an equation $f_1(x+\omega) = -f_1(x)$ would then give $f_1(x+\omega+\omega') = f_1(x)$, and hence $f_1(\frac{1}{2}\omega + \frac{1}{2}\omega') = f_1(-\frac{1}{2}\omega - \frac{1}{2}\omega')$, of which the latter is $-f_1(\frac{1}{2}\omega + \frac{1}{2}\omega')$, this would give $f_1(\frac{1}{2}\omega + \frac{1}{2}\omega') = 0$, while $[f_1(\frac{1}{2}\omega + \frac{1}{2}\omega')]^2 = e_3 - e_1$. We thus infer that $f_1(x+\omega) = f_1(x), f_1(x+\omega') = -f_1(x), f_1(x+\omega+\omega') = -f_1(x)$. The function $f_1(x)$ is thus doubly periodic with the periods ω and $2\omega'$; in a parallelogram of which two sides are ω and $2\omega'$ it has poles at $x=0, x=\omega$ each of the first order, and zeros of the first order at $x=\frac{1}{2}\omega, x=\frac{1}{2}\omega + \omega'$; it is thus a doubly periodic function of the second order with two different poles of the first order in its parallelogram $(\omega, 2\omega')$. We may similarly consider the functions $f_2(x) = [\mathfrak{F}(x) - e_2]^{\frac{1}{2}}, f_3(x) = [\mathfrak{F}(x) - e_3]^{\frac{1}{2}}$; they give

$$f_2(x+\omega+\omega') = f_2(x), f_2(x+\omega) = -f_2(x), f_2(x+\omega') = -f_2(x), f_2(x+\omega+\omega') = f_2(x), f_3(x+\omega+\omega') = -f_3(x), f_3(x+\omega) = -f_3(x), f_3(x+\omega') = f_3(x).$$

Taking $u = \pm(e_1 - e_2)^{\frac{1}{2}}$, with a definite determination of the constant $(e_1 - e_2)^{\frac{1}{2}}$, it is usual, taking the preliminary signs so that for $x=0$ each of $2f_1(x), 2f_2(x), 2f_3(x)$ is equal to $+1$, to put

$$sn(u) = \frac{(e_1 - e_2)^{\frac{1}{2}}}{f_1(x)}, cn(u) = \frac{f_2(x)}{f_1(x)}, dn(u) = \frac{f_3(x)}{f_1(x)}$$

$$k^2 = (e_1 - e_2)/(e_1 - e_3), K = \frac{1}{2}\omega(e_1 - e_2), iK' = \frac{1}{2}\omega'(e_1 - e_2);$$

thus $sn(u)$ is an odd doubly periodic function of the second order with the periods $4K, 2iK'$, having poles of the first order at $u = iK', u = 2K + iK'$, and zeros of the first order at $u = 0, u = 2K$, similarly $cn(u), dn(u)$ are even doubly periodic functions whose periods can be written down, and $sn^2(u) + cn^2(u) = 1, k^2 sn^2(u) + dn^2(u) = 1$; if $x = sn(u)$ we at once find, from the relations given here, that

$$\frac{du}{dx} = [(1-x^2)(1-k^2x^2)]^{-\frac{1}{2}}$$

if we put $x = \sin \phi$ we have

$$\frac{du}{d\phi} = [1 - k^2 \sin^2 \phi]^{-\frac{1}{2}}$$

and if we call ϕ the amplitude of u , we may write $\phi = am(u), x = \sin am(u)$, which explains the origin of the notation $am(u)$. Similarly $cn(u)$ is an abbreviation of $\cos am(u)$, and $dn(u)$ of $\Delta am(u)$, where $\Delta(\phi)$ meant $(1 - k^2 \sin^2 \phi)^{\frac{1}{2}}$. The addition equation for each of the functions $f_1(x), f_2(x), f_3(x)$ is very simple, being

$$f(x+\theta) = \frac{1}{2} \left(\frac{\partial}{\partial x} + \frac{\partial}{\partial t} \right) \log \frac{f(x) + f(t)}{f(x) - f(t)} = \frac{f(x)f'(t) - f(t)f'(x)}{f^2(x) - f^2(t)}$$

where $f'(x)$ means $df(x)/dx$, which is equal to $-f_2(x)f_3(x)$, and $f^2(x)$

takes each real value once as s passes along the perimeter of the triangle ODE, being as can be shown respectively $\infty, 1, 0, -1$ at O, D, H, E, and takes every complex value of imaginary part positive once in the interior of this triangle. This leads to

$$s = \frac{1}{2} \int_0^{\infty} (t-1)^{-s} dt$$

in accordance with the general theory.

It can be deduced that $\tau = e^s$ represents the triangle ODH on the upper half plane of τ , and $\tau = (1-\tau^{-1})^s$ represents similarly the triangle OBD.

§ 16. *Multiple valued Functions. Algebraic Functions.*—The explanations and definitions of a monogenic function hitherto given have been framed for the most part with a view to single valued functions. But starting from a power series, say in $s-c$, which represents a single value at all points of its circle of convergence, suppose that, by means of a derived series in $s-c'$ where c' is interior to the circle of convergence, we can continue the function beyond this, and then by means of a series derived from the first derived series we can make a further continuation, and so on; it may well be that when, after a closed circuit, we again consider points in the first circle of convergence, the value represented may not agree with the original value. One example is the case $s^{\frac{1}{2}}$, for which two values exist for any value of s ; another is the generalized logarithm $\lambda(s)$, for which there is an infinite number of values. In such cases, as before, the region of existence of the function consists of all points which can be reached by such continuations with power series, and the singular points, which are the limiting points of the point-aggregate constituting the region of existence, are those points in whose neighbourhood the radii of convergence of derived series have zero for limit. In this description the point $s=\infty$ does not occupy an exceptional position, a power series in $s-c$ being transformed to a series in $1/s$ when s is near enough to c by means of $s-c = c(x-\alpha^{-1})[x-(1-\alpha^{-1})]^{-1}$, and a series in $1/s$ of the form $s-c$, when s is near enough to c , by means of $\frac{1}{s} = \frac{1}{c} \left(1 + \frac{s-c}{c}\right)^{-1}$.

The commonest case of the occurrence of multiple valued functions is that in which the function s satisfies an algebraic equation $f(s, z) = p_0 s^n + p_1 s^{n-1} + \dots + p_n = 0$, wherein p_0, p_1, \dots, p_n are integral polynomials in z . Assuming $f(s, z)$ incapable of being written as a product of polynomials rational in s and z , and excepting values of z for which the polynomial coefficient of s^n vanishes, as also the values of z for which beside $f(s, z) = 0$ we have also $\partial f(s, z) / \partial s = 0$, and also in general the point $s = \infty$, the roots of this equation about any point $s=c$ are given by n -power series in $s-c$. About a finite point $s=c$ for which the equation $\partial f(s, z) / \partial s = 0$ is satisfied by one or more of the roots z of $f(s, z) = 0$, the n roots break up into a certain number of cycles, the r roots of a cycle being given by a set of power series in a radical $(s-c)^{1/r}$; these series of the cycle being obtainable from one another by replacing $(s-c)^{1/r}$ by $\omega(s-c)^{1/r}$, where ω , equal to $\exp(2\pi i h/r)$, is one of the r th roots of unity. Putting then $s-c = r t$ we may say that the r roots of a cycle are given by a single power series in t , an increase of 2π in the phase of t giving an increase of $2\pi r$ in the phase of $s-c$. This single series in t , giving the values of s belonging to one cycle in the neighbourhood of $s=c$ when the phase of $s-c$ varies through $2\pi r$, is to be looked upon as defining a single place among the aggregate of values of s and z which satisfy $f(s, z) = 0$; two such places may be at the same point ($s=c, z=d$) without coinciding, the corresponding power series for the neighbouring points being different. Thus for an ordinary value of $s, z=c$, there are n places for which the neighbouring values of s are given by n power series in $s-c$; for a value of s for which $\partial f(s, z) / \partial s = 0$ there are less than n places. Similar remarks hold for the neighbourhood of $s = \infty$; there may be n places whose neighbourhood is given by n power series in s^{-1} or fewer, one of these being associated with a series in t , where $t = (s^{-1})^{1/r}$; the sum of the values of r which thus arise is always n . In general, then, we may say, with t of one of the forms $(s-c), (s-c)^{1/r}, s^{-1}, (s^{-1})^{1/r}$, that the neighbourhood of any place (c, d) for which $f(c, d) = 0$ is given by a pair of expressions $s=c+P(t), z=d+Q(t)$, where $P(t)$ is a (particular case of a) power series vanishing for $t=0$, and $Q(t)$ is a power series vanishing for $t=0$, and t vanishes at (c, d) ; the expression $s-c$ being replaced by s^{-1} when c is infinite, and similarly the expression $s-d$ by t^{-1} when d is infinite. The last case arises when we consider the finite values of z for which the polynomial coefficient of s^n vanishes. Of such a pair of expressions we may obtain a continuation by writing $t = t_0 + \lambda \tau + \lambda^2 \tau^2 + \dots$, where τ is a new variable and λ_1 is not zero; in particular for an ordinary finite place this equation simply becomes $t = t_0 + \tau$. It can be shown that all the pairs of power series $s=c+P(t), z=d+Q(t)$ which are necessary to represent all pairs of values of s, z satisfying the equation $f(s, z) = 0$ can be obtained from one

of them by this process of continuation, a fact which we express by saying that the equation $f(s, z) = 0$ defines a *monogenic algebraic construct*. With less accuracy we may say that an irreducible algebraic equation $f(s, z) = 0$ determines a single monogenic function s of z .

Any rational function of s and z , where $f(s, z) = 0$, may be considered in the neighbourhood of any place (c, d) by substituting therein $s=c+P(t), z=d+Q(t)$; the result is necessarily of the form $t^m H(t)$, where $H(t)$ is a power series in t not vanishing for $t=0$ and m is an integer. If this integer is positive, the function is said to vanish to order m at the place; if this integer is negative, $m=-\mu$, the function is infinite to order μ at the place. More generally, if A be an arbitrary constant, and near (c, d) , $R(s, z) - A$ is of the form $t^m H(t)$, where m is positive, we say that $R(s, z)$ becomes m times equal to A at the place; if $R(s, z)$ is infinite of order μ at the place, so also is $R(s, z) - A$. It can be shown that the sum of the values of m at all the places, including the places $z = \infty$, where $R(s, z)$ vanishes, which we call the number of zeros of $R(s, z)$ on the algebraic construct, is finite, and equal to the sum of the values of μ where $R(s, z)$ is infinite, and more generally equal to the sum of the values of m where $R(s, z) = A$; this we express by saying that a rational function $R(s, z)$ takes any value (including ∞) the same number of times or the algebraic construct; this number is called the *order* of the rational function.

That the total number of zeros of $R(s, z)$ is finite is at once obvious, these values being obtainable by rational elimination of s between $f(s, z) = 0, R(s, z) = 0$. That the number is equal to the total number of infinities is best deduced by means of a theorem which is also of more general utility. Let $R(s, z)$ be any rational function of s, z , which are connected by $f(s, z) = 0$; about any place (c, d) for which $s=c+P(t), z=d+Q(t)$, expand the product

$$R(s, z) \frac{dz}{dt}$$

in powers of t and pick out the coefficient of t^{-1} . There is only a finite number of places of this kind. The theorem is that the sum of these coefficients of t^{-1} is zero. This we express by

$$\left[R(s, z) \frac{dz}{dt} \right]_{t^{-1}} = 0.$$

The theorem holds for the case $n=1$, that is, for rational functions of one variable z ; in that case, about any finite point we have $s-c=t$, and about $s=\infty$ we have $s^{-1}=t$, and therefore $dz/dt = -t^{-2}$; in that case, then, the theorem is that in any rational function of z ,

$$\Sigma \left(\frac{A_1}{z-a} + \frac{A_2}{z-b} + \dots + \frac{A_m}{z-a^m} \right) + Pz^2 + Qz^{m+1} + \dots + R,$$

the sum ΣA_i of the sum of the residues at the finite poles is equal to the coefficient of $1/z$ in the expansion, in ascending powers of $1/z$, about $z = \infty$; an obvious result. In general, if for a finite place of the algebraic construct associated with $f(s, z) = 0$, whose neighbourhood is given by $s=c+P, z=d+Q(t)$, there be a coefficient of t^{-1} in $R(s, z) dz/dt$, this will be r times the coefficient of t^{-1} in $R(s, z)$ or $R(d+Q(t), c+t)$, namely will be the coefficient of t^{-1} in the sum of the r series obtainable from $R(d+Q(t), c+t)$ by replacing t by ωt , where ω is an r th root of unity; thus the sum of the coefficients of t^{-1} in $R(s, z) dz/dt$ for all the places which arise for $s=c$, and the corresponding values of z , is equal to the coefficient of $(s-c)^{-1}$ in $R(s, z) + R(s, z_1) + \dots + R(s, z_r)$, where z_1, \dots, z_r are the n values of s for a value of s near to $s=c$; this latter sum $\Sigma R(s, z)$ is, however, a rational function of s only. Similarly, near $s = \infty$, for a place given by $s^{-1} = t, z = d+Q(t)$, or $t^{-1} = Q(t)$, the coefficient of t^{-1} in $R(s, z) dz/dt$ is equal to $-r$ times the coefficient of t^{-1} in $R(d+Q(t), t^{-1})$, that is equal to the negative coefficient of t^{-1} in the sum of the r series $R(d+Q(\omega t), t^{-1})$, so that, as before, the sum of the coefficients of t^{-1} in $R(s, z) dz/dt$ at the various places which arise for $s = \infty$ is equal to the negative coefficient of s^{-1} in the same rational function of $s, \Sigma R(s, z)$. Thus, from the corresponding theorem for rational functions of one variable, the general theorem now being proved is seen to follow.

Apply this theorem now to the rational function of s and z ,

$$\frac{1}{R(s, z)} \frac{dR(s, z)}{ds};$$

at a zero of $R(s, z)$ near which $R(s, z) = t^m H(t)$, we have

$$-\frac{1}{R(s, z)} \frac{dR(s, z)}{ds} \frac{ds}{dt} = \frac{d}{dt} \left[\lambda R(s, z) \right],$$

where λ denotes the generalized logarithmic function, that is equal to

$$m t^{-1} + \text{power series in } t;$$

similarly at a place for which $R(s, z) = t^{-\mu} K(t)$; the theorem

$$\left[\frac{1}{R(s, z)} \frac{dR(s, z)}{ds} \frac{dz}{dt} \right]_{t^{-1}} = 0$$

thus gives $\Sigma m = \Sigma \mu$, or, in words, the total number of zeros of $R(s, z)$ on the algebraic construct is equal to the total number of its poles. The same is therefore true of the function $R(s, z) - A$, where A is an arbitrary constant; thus the number in question, being equal to the number of poles of $R(s, z) - A$, is equal also to the number of times that $R(s, z) = A$ on the algebraic construct.

We have seen above that all single valued doubly periodic meromorphic functions, with the same periods, are rational functions of two variables s, z connected by an equation of the form $s^2 = as^2 + As + B$. Taking account of the relation connecting these variables s, z with the argument of the doubly periodic functions (which was above denoted by θ), it can then easily be seen that the theorem now proved is a generalization of the theorem proved previously establishing for a doubly periodic function a definite order. There exists a generalization of another theorem also proved above for doubly periodic functions, namely, that the sum of the values of the argument in one parallelogram of periods for which a doubly periodic function takes a given value is independent of that value; this generalization, known as Abel's Theorem, is given § 17 below.

§ 17. *Integrals of Algebraic Functions.*—In treatises on Integral Calculus it is proved that if $R(s, z)$ denote any rational function, an indefinite integral $\int R(s, z) dz$ can be evaluated in terms of rational and logarithmic functions, including the inverse trigonometrical functions. In generalization of this it was long ago discovered that if $s^2 = as^2 + bs + c$ and $R(s, z)$ be any rational function of s, z any integral $\int R(s, z) dz$ can be evaluated in terms of rational functions of s, z and logarithms of such functions; the simplest case is $\int s^{-1} dz$ or $\int (as^2 + bs + c)^{-1/2} dz$. More generally if $f(s, z) = 0$ be such a relation connecting s, z that when θ is an appropriate rational function of s and z both s and z are rationally expressible, in virtue of $f(s, z) = 0$ in terms of θ , the integral $\int R(s, z) dz$ is reducible to a form $\int H(\theta) d\theta$, where $H(\theta)$ is rational in θ , and can therefore also be evaluated by rational functions and logarithms of rational functions of s and z . It was natural to inquire whether a similar theorem holds for integrals $\int R(s, z) dz$ wherein s^2 is a cubic polynomial in z . The answer is in the negative. For instance, no one of the three integrals

$$\int \frac{dz}{s}, \int \frac{dz}{s^2}, \int \frac{dz}{(s-c)^2}$$

can be expressed by rational and logarithms of rational functions of s and z ; but it can be shown that every integral $\int R(s, z) dz$ can be expressed by means of integrals of these three types together with rational and logarithms of rational functions of s and z (see below under § 20, *Elliptic Integrals*). A similar theorem is true when $s^2 = \text{quartic polynomial in } z$; in fact when $s^2 = A(s-a)(s-b)(s-c)(s-d)$, putting $y = s(s-a)^{-1/2}$, $x = (s-a)^{-1/2}$, we obtain $y^2 = \text{cubic polynomial in } x$. Much less is the theorem true when the fundamental relation $f(s, z) = 0$ is of more general type. There exists then, however, a very general theorem, known as *Abel's Theorem*, which may be enunciated as follows: Beside the rational function $R(s, z)$ occurring in the integral $\int R(s, z) dz$, consider another rational function $H(s, z)$; let $(a_1), \dots, (a_m)$ denote the places of the construct associated with the fundamental equation $f(s, z) = 0$, for which $H(s, z)$ is equal to one value A , each taken with its proper multiplicity, and let $(b_1), \dots, (b_n)$ denote the places for which $H(s, z) = B$, where B is another value; then the sum of the m integrals $\int_{(a_i)}^{(b_j)} R(s, z) dz$ is equal to the sum of the coefficients of t^{-1} in the expansions of the function

$$R(s, z) \frac{dx}{dt} \lambda \left(\frac{H(s, z) - B}{H(s, z) - A} \right),$$

where λ denotes the generalized logarithmic function, at the various places where the expansion of $R(s, z) dx/dt$ contains negative powers of t . This fact may be obtained at once from the equation

$$\left[\frac{1}{H(s, z) - \mu} R(s, z) \frac{dx}{dt} \right]_{t=0} = 0,$$

wherein μ is a constant. (For illustrations see below, under § 20, *Elliptic Integrals*.)

§ 18. *Indeterminateness of Algebraic Integrals.*—The theorem that the integral $\int^x f(z) dz$ is independent of the path from a to x , holds only on the hypothesis that any two such paths are equivalent, that is, taken together from the complete boundary of a region of the plane within which $f(z)$ is finite and single valued, besides being differentiable. Suppose that these conditions fail only at a finite number of isolated points in the finite part of the plane. Then any path from a to x is equivalent, in the sense explained, to any other path together with closed

paths beginning and ending at the arbitrary point a each enclosing one or more of the exceptional points, these closed paths being chosen, when $f(z)$ is not a single valued function, so that the final value of $f(z)$ at a is equal to its initial value. It is necessary for the statement that this condition may be capable of being satisfied.

For instance, the integral $\int^x s^{-1} dz$ is liable to an additive indeterminateness equal to the value obtained by a closed path about $s=0$, which is equal to $2\pi i$; if we put $u = \int^x s^{-1} dz$, and consider s as a function of u , then we must regard this function as unaffected by the addition of $2\pi i$ to its argument u ; we know in fact that $s = \exp(u)$ and is a single valued function of u , with the period $2\pi i$. Or again the integral $\int^x (1+s^2)^{-1} dz$ is liable to an additive indeterminateness equal to the value obtained by a closed path about either of the points $s = \pm i$; thus if we put $u = \int^x (1+s^2)^{-1} dz$, the function s of u is periodic with period π , this being the function $\tan(u)$. Next we take the integral $u = \int_{(a)}^{(b)} (1-s^2)^{-1/2} dz$, agreeing that the upper and lower limits refer not only to definite values of s , but to definite values of s each associated with a definite determination of the sign of the associated radical $(1-s^2)^{-1/2}$. We suppose $1+s, 1-s$ each to have phase zero for $s=0$; then a single closed circuit of $s=1$ will lead back to $s=0$ with $(1-s^2)^{-1/2} = -1$; the additive indeterminateness of the integral, obtained by a closed path which restores the initial value of the subject of integration, may be obtained by a closed circuit containing both the points ± 1 in its interior; this gives, since the integral taken about a vanishing circle whose centre is either of the points $s = \pm 1$ has ultimately the value zero, the sum

$$\int_0^1 \frac{dz}{(1-s^2)^{1/2}} + \int_{-1}^0 \frac{dz}{-(1-s^2)^{1/2}} + \int_0^{-1} \frac{dz}{-(1-s^2)^{1/2}} + \int_{-1}^0 \frac{dz}{(1-s^2)^{1/2}},$$

where, in each case, $(1-s^2)^{1/2}$ is real and positive; that is, it gives

$$-\int_0^1 \frac{dz}{(1-s^2)^{1/2}}$$

or 2π . Thus the additive indeterminateness of the integral is of the form $2k\pi$, where k is an integer, and the function s of u , which is $\sin(u)$, has 2π for period. Take now the case

$$u = \int_{(a_0)}^{(a_1)} \frac{dz}{\sqrt{(s-a)(s-b)(s-c)(s-d)}}$$

adopting a definite determination for the phase of each of the factors $s-a, s-b, s-c, s-d$ at the arbitrary point a_0 , and supposing the upper limit to refer, not only to a definite value of s , but also to a definite determination of the radical under the sign of integration. From a_0 describe a closed loop about the point $s=a$, consisting, suppose, of a straight path from a_0 to a , followed by a vanishing circle whose centre is at a , completed by the straight path from a to a_0 . Let similar loops be imagined for each of the points b, c, d , no two of these having a point in common. Let A denote the value obtained by the positive circuit of the first loop; this will be in fact equal to twice the integral taken from a_0 along the straight path to a ; for the contribution due to the vanishing circle is ultimately zero, and the effect of the circuit of this circle is to change the sign of the subject of integration. After the circuit about a , we arrive back at a_0 with the subject of integration changed in sign; let B, C, D denote the values of the integral taken by the loops enclosing respectively b, c and d when in each case the initial determination of the subject of integration is that adopted in calculating A . If then we take a circuit from a_0 enclosing both a and b but not either c or d , the value obtained will be $A-B$, and on returning to a_0 the subject of integration will have its initial value. It appears thus that the integral is subject to an additive indeterminateness equal to any one of the six differences such as $A-B$. Of these there are only two linearly independent; for clearly only $A-B, A-C, A-D$ are linearly independent, and in fact, as we see by taking a closed circuit enclosing all of a, b, c, d , we have $A-B+C-D=0$; for there is no other point in the plane beside a, b, c, d about which the subject of integration suffers a change of sign, and a circuit enclosing all of a, b, c, d may by putting $s=1/t$ be reduced to a circuit about $t=0$ about which the value of the integral is zero. The general value of the integral for any position of s and the associated sign of the radical, when we start with a definite determination of the subject of integration, is thus seen to be of the form $m(A-B) + n(A-C)$, where m and n are integers. The value of $A-B$ is independent of the position of a_0 , being obtainable by a single closed positive circuit about a and b only; it is thus equal to twice the integral taken once from a to b , with a proper initial determination of the radical under the sign of integration. Similar remarks to the above apply to any integral $\int^x f(z) dz$, in which $H(z)$ is an algebraic function of z ; in any such case $H(z)$ is a rational function of z and a quantity s connected therewith by an irreducible rational algebraic

equation $f(s, z) = 0$. Such an integral $\int fK(s, z)ds$ is called an Abelian integral.

§ 19. *Reversion of an Algebraic Integral.*—In a limited number of cases the equation $z = \int H(s)ds$, in which $H(s)$ is an algebraic function of s , defines z as a single valued function of s . Several cases of this have been mentioned in the previous section; from what was previously proved under § 14, *Doubly Periodic Functions*, it appears that it is necessary for this that the integral should have at most two linearly independent additive constants of indeterminateness; for instance, for an integral

$$u = \int_a^x [(s-a)(s-b)(s-c)(s-d)(s-e)(s-f)]^{-1/2} ds,$$

there are three such constants, of the form $A-B, A-C, A-D$, which are not connected by any linear equation with integral coefficients, and z is not a single valued function of s .

§ 20. *Elliptic Integrals.*—An integral of the form $\int R(s, z)ds$, where s denotes the square root of a quartic polynomial in z , which may reduce to a cubic polynomial, and R denotes a rational function of s and z , is called an *elliptic integral*.

To each value of s belong two values of z , of opposite sign; starting, for some particular value of z , with a definite one of these two values, the sign to be attached to s for any other value of z will be determined by the path of integration for z . When s is in the neighbourhood of any finite value s_0 for which the radical z is not zero, if we put $z - z_0 = t$, we can find $z - z_0 = a$ a power series in t , say $z - z_0 = Q(t)$; when t is in the neighbourhood of a value, a , for which s vanishes, if we put $z = a + \beta$, we shall obtain $z = R(t)$, where $Q(t)$ is a power series in t ; when s is very large and z^2 is a quartic polynomial in z , if we put $z^2 = t$, we shall find $z^2 = P(Q(t))$; when s is very large and z^2 is a cubic polynomial in z , if we put $z^2 = P$, we shall find $z^2 = P(Q(t))$. By means of substitutions of these forms the character of the integral $\int R(s, z)ds$ may be investigated for any position of z ; in any case it takes a form $\int [Ht^m + Kr^{-m-1} + Pt^{-1} + R + St + \dots] dt$ involving only a finite number of negative powers of t in the subject of integration. Consider first the particular case $\int s^{-1/2} dz$; it is easily seen that neither for any finite nor for any infinite values of z can negative powers of t enter; the integral is everywhere finite, and is said to be of the *first kind*; it can, moreover, be shown without difficulty that no integral $\int R(s, z)ds$, save a constant multiple of $\int s^{-1/2} dz$, has this property. Consider next, z^2 being of the form $a_0 z^4 + 2a_1 z^2 + \dots$, wherein a_0 may be zero, the integral $\int (a_0 z^2 + 2a_1 z) s^{-1/2} dz$; for any finite value of z this integral is easily proved to be everywhere finite; but for infinite values of z its value is of the form $Az^{-1} + Q(t)$, where $Q(t)$ is a power series; denoting by $\sqrt{a_0}$ a particular square root of a_0 when a_0 is not zero, the integral becomes infinite for $z = \infty$ for both signs of z , the value of A being $+\sqrt{a_0}$ or $-\sqrt{a_0}$ according as s is $+\sqrt{a_0} z^2 (1 + \frac{2a_1}{a_0} z^{-2} + \dots)$ or is the negative of this; hence the integral $J_2 = \int (\frac{2a_1 z + 2a_0}{s} + \sqrt{a_0}) ds$ becomes infinite when s is infinite, for the former sign of z , its infinite term being $2\sqrt{a_0} z^{-1}$ or $2\sqrt{a_0} z$, but does not become infinite for s infinite for the other sign of z . When $a_0 = 0$ the signs of s for $z = \infty$ are not separated, being obtained one from the other by a circuit of z about an infinitely large circle, and the form obtained represents an integral becoming infinite as before for $z = \infty$, its infinite part being $2\sqrt{a_1} z^{-1}$ or $2\sqrt{a_1} \sqrt{z}$. Similarly H may be any finite value of z which is not a root of the polynomial $f(z)$ to which z^2 is equal, and z_0 denotes a particular one of the determinations of z for $s = z_0$, the integral

$$J_3 = \int \left\{ \frac{f'(z)}{f(z)} + \frac{f'(z_0)}{(z-z_0)^2} \right\} dz,$$

wherein $f'(z) = df(z)/dz$, becomes infinite for $z = z_0$, $z = z_0$, but not for $z = z_0, z = -z_0$, its infinite term in the former case being the negative of $\frac{f'(z_0)}{f(z_0)}$. For no other finite or infinite value of z is the integral infinite. If $s = \theta$ be a root of $f(s)$, in which case the corresponding value of z is zero, the integral

$$J_4 = \int \frac{f'(s)}{(s-\theta)^2} ds$$

becomes infinite for $s = \theta$, its infinite part being, if $z - \theta = \beta$, equal to $-\frac{1}{2} f'(\theta) \theta^{-1/2}$; and this integral is not elsewhere infinite. In each of these cases, of the integrals J_1, J_2, J_3, J_4 , the subject of integration has been chosen so that when the integral is written near its point of infinity in the form $\int AR^m + Bz^{-1} + Q(t) dz$, the coefficient B is zero, so that the infinity is of algebraic kind, and so that, when there are two signs distinguishable for the critical value of z , the integral becomes infinite for only one of these. An integral having only algebraic infinities, for finite or infinite values of z , is called an integral of the *second kind*; and it appears that such an integral can be formed with only one such infinity, that is, for an infinity arising only for one particular, and arbitrary, pair of values (z, z) satisfying the equation $s^2 = f(z)$, this infinity being of the first order. A function having an algebraic infinity of the m th order ($m > 1$), only for one sign of z when these signs are separable, at (1) $z = \infty$, (2) $z = z_0$, (3) $z = s$, is given respectively by $\int \frac{dz}{z^m}, \int \frac{dz}{(z-z_0)^m}, \int \frac{dz}{z^m}$,

$(\frac{d}{dz})^{-1} J_3$, as we easily see. If then we have any elliptic integral having algebraic infinities we can, by subtraction from it of an appropriate sum of constant multiples of J_1, J_2, J_3 and their differential coefficients just written down, obtain, as the result, an integral without algebraic infinities. But, in fact, if J, J' denote any two of the three integrals J_1, J_2, J_3 , there exists an equation $AJ + BJ' + C/z^2 = \text{rational function of } z, z$, where A, B, C are properly chosen constants. For the rational function

$$\frac{z+z_0}{z-z_0} + \sqrt{a_0}$$

is at once found to become infinite for (z_0, z_0) , not for $(z_0, -z_0)$, its infinite part for the first point being $2z_0/(z-z_0)$, and to become infinite for z infinitely large, and one sign of z only when these are separable, its infinite part there being $2z\sqrt{a_0}$ or $2\sqrt{a_0}\sqrt{z}$ when $a_0 = 0$. It does not become infinite for any other pair (z, z) satisfying the relation $s^2 = f(z)$; this is in accordance with the easily verified equation

$$\frac{z+z_0}{z-z_0} + \sqrt{a_0} - J_1 + J_2 + (a_0 z^2 + 2a_1 z_0) \frac{dz}{z} = 0;$$

and there exists the analogous equation

$$\frac{z}{z-\theta} + \sqrt{a_0} - J_1 + J_3 + (a_0 z^2 + 2a_0 \theta) \frac{dz}{z} = 0.$$

Consider now the integral

$$P = \int \left(\frac{z+z_0}{z-z_0} + \sqrt{a_0} \right) \frac{dz}{2s};$$

this is at once found to be infinite, for finite values of z , only for (z_0, z_0) , its infinite part being $\log(z-z_0)$, and for $z = \infty$, for one sign of z only when these are separable, its infinite part being $-\log t$, that is $-\log s$ when $a_0 \neq 0$, and $-\log(z^2)$ when $a_0 = 0$. And, if $f(\theta) = 0$, the integral

$$P_1 = \int \left(\frac{z}{z-\theta} + \sqrt{a_0} \right) \frac{dz}{2s}.$$

is infinite at $z = \theta, z = 0$ with an infinite part $\log t$, that is $\log(z-\theta)$, is not infinite for any other finite value of z , and is infinite like P for $z = \infty$. An integral possessing such logarithmic infinities is said to be of the *third kind*.

Hence it appears that any elliptic integral, by subtraction from it of an appropriate sum formed with constant multiples of the integral J_2 and the rational functions of the form $(\frac{d}{dz})^{-1} J_1$, with constant multiples of integrals such as P or P_1 , with constant multiples of the integral $u = \int s^{-1/2} dz$, and with rational functions, can be reduced to an integral H becoming infinite only for $z = \infty$, for one sign of z only when these are separable, its infinite part being of the form $A \log t$, that is, $A \log s$ or $A \log(z^2)$. Such an integral $H = \int R(z, z) dz$ does not exist, however, as we at once find by writing $R(z, z) = P(z) + sQ(z)$, where $P(z), Q(z)$ are rational functions of z , and examining the forms possible for these in order that the integral may have only the specified infinity. An analogous theorem holds for rational functions of z and z ; there exists no rational function which is finite for finite values of z and is infinite only for $z = \infty$ for one sign of z and to the first order only; but there exists a rational function infinite in all to the first order for each of two or more pairs (z, z) , however they may be situated, or infinite to the second order for an arbitrary pair (z, z) ; and any rational function may be formed by a sum of constant multiples of functions such as

$$\frac{z+z_0}{z-z_0} + \sqrt{a_0} \text{ or } \frac{z}{z-\theta} + \sqrt{a_0}$$

and their differential coefficients.

The consideration of elliptic integrals is therefore reducible to that of the three

$$u = \int \frac{dz}{s}, \quad J = \int \left(\frac{2a_1 z + 2a_0}{s} + \sqrt{a_0} \right) dz, \quad P = \int \left(\frac{z+z_0}{z-z_0} + \sqrt{a_0} \right) \frac{dz}{2s}$$

respectively of the first, second and third kind. Now the equation $s^2 = a_0 z^4 + \dots = a_0(z-\theta)(z-\phi)(z-\chi)$, by putting

$$y = 2z(z-\theta)^{-1/2} a_0(\theta-\phi)(\theta-\chi)^{-1/2} \\ x = \frac{z}{z-\theta} + \frac{1}{2} \left(\frac{1}{\theta-\phi} + \frac{1}{\theta-\chi} + \frac{1}{\theta-\chi} \right)$$

is at once reduced to the form $y^2 = 4x^2 - g_2 x - g_3 = 4(x-e_1)(x-e_2)$, say; and these equations enable us to express s and z rationally in terms of x and y . It is therefore sufficient to consider three elliptic integrals

$$u = \int \frac{dx}{y}, \quad J = \int \frac{x dx}{y}, \quad P = \int \frac{y+z_0}{x-z_0} \frac{dx}{2y}$$

Of these consider the first, putting

$$u = \int_{(1)}^{(m)} \frac{dx}{y}$$

where the limits involve not only a value for x , but a definite sign for the radical y . When x is very large, if we put $x^{-1} = \beta, y^{-1} = 2\beta^2(1 - \frac{1}{2}g_2\beta^2 - \frac{1}{2}g_3\beta^4) + \dots$, we have

$$u = \int_0^1 (1 + \frac{1}{2}g_2\beta^2 + \dots) d\beta = 1 + \frac{1}{2}g_2\beta^2 + \dots$$

whereby a definite power series in u , valid for sufficiently small value of u , is found for t , and hence a definite power series for x , of the form

$$x = u^{-2} + h_1 u^2 + \dots$$

Let this expression be valid for $0 < |u| < R$, and the function defined thereby, which has a pole of the second order for $u=0$, be denoted by $\phi(u)$. In the range in question it is single valued and satisfies the differential equation

$$[\phi'(u)]^2 = 4[\phi(u)]^2 - g_2\phi(u) - g_3;$$

in terms of it we can write $x = \phi(u)$, $y = -\phi'(u)$, and $\phi'(u)$ being an odd function, the sign attached to y in the original integral for $x = \infty$ is immaterial. Now for any two values u, v in the range in question consider the function

$$F(u, v) = \frac{1}{2} \left[\frac{\phi'(u) - \phi'(v)}{\phi(u) - \phi(v)} \right]^2 - \phi(u) - \phi(v);$$

it is at once seen, from the differential equation, to be such that $\partial F/\partial u = \partial F/\partial v$; it is therefore a function of $u+v$; supposing $|u+v| < R$ we infer therefore, by putting $v=0$, that

$$\phi(u+v) = \frac{1}{2} \left[\frac{\phi'(u) - \phi'(v)}{\phi(u) - \phi(v)} \right]^2 - \phi(u) - \phi(v).$$

By repetition of this equation we infer that if u_1, \dots, u_n be any arguments each of which is in absolute value less than R , whose sum is also in absolute value less than R , then $\phi(u_1 + \dots + u_n)$ is a rational function of the $2n$ functions $\phi(u_i)$, $\phi'(u_i)$; and hence, if $|u| < R$, that

$$\phi(u) = H \left[\phi \left(\frac{u}{n} \right), \phi' \left(\frac{u}{n} \right) \right],$$

where H is some rational function of the arguments $\phi(u/n)$, $\phi'(u/n)$. In fact, however, so long as $|u/n| < R$, each of the functions $\phi(u/n)$, $\phi'(u/n)$ is single valued and without singularity save for the pole at $u=0$; and a rational function of single valued functions, each of which has no singularities other than poles in a certain region, is also a single valued function without singularities other than poles in this region. We infer, therefore, that the function of u expressed by

$$H \left[\phi \left(\frac{u}{n} \right), \phi' \left(\frac{u}{n} \right) \right]$$

than poles so long as $|u| < nR$; it agrees with $\phi(u)$ when $|u| < R$, and hence furnishes a continuation of this function over the extended range $|u| < nR$. Moreover, from the method of its derivation, it satisfies the differential equation $[\phi'(u)]^2 = 4[\phi(u)]^2 - g_2\phi(u) - g_3$. This equation has therefore one solution which is a single valued monogenic function with no singularities other than poles for any finite part of the plane, having in particular for $u=0$, a pole of the second order; and the method adopted for obtaining this near $u=0$ shows that the differential equation has no other such solution. This, however, is not the only solution which is a single valued meromorphic function, all the functions $\phi(u+a)$, wherein a is arbitrary, being such. Taking now any range of values of u , so that $\gamma^2 = 4x^2 - g_2x - g_3$ we clearly have

$$u = \int_{(x_0, y_0)}^{\gamma} \frac{dx}{\gamma^2}$$

conversely if $x_0 = \phi(u_0)$, $y_0 = -\phi'(u_0)$ and ξ, η be any values satisfying $\eta^2 = 4\xi^2 - g_2\xi - g_3$, which are sufficiently near respectively to x_0, y_0 while v is defined by

$$v - u_0 = - \int_{(u_0, y_0)}^{\xi, \eta} \frac{d\xi}{\eta^2}$$

then ξ, η are respectively $\phi(v)$ and $-\phi'(v)$; for this equation leads to an expansion for $\xi - x_0$ in terms of $v - u_0$, and only one such expansion, and this is obtained by the same work as would be necessary to expand $\phi(v)$ when v is near to u_0 ; the function $\phi(u)$ can therefore be continued by the help of this equation, from $v = u_0$, provided the lower limit of $|\xi - x_0|$ necessary for the expansions is not zero in the neighbourhood of any value (x_0, y_0) . In fact the function $\phi(u)$ can have only a finite number of poles in any finite part of the plane of u ; each of these can be surrounded by a small circle, and in the portion of the finite part of the plane of u which is outside these circles, the lower limit of the radii of convergence of the expansions of $\phi(u)$ is greater than zero; the same will therefore be the case for the lower limit of the radii $|\xi - x_0|$ necessary for the continuations spoken of above provided that the values of (ξ, η) considered do not lead to infinitely increasing values of v ; there does not exist, however, any definite point (x_0, y_0) in the neighbourhood of which the

integral $\int_{(x_0, y_0)}^{\xi, \eta} \frac{d\xi}{\eta^2}$ increases indefinitely, it is only by a path of infinite length that the integral can so increase. We infer therefore that if (ξ, η) be any point, where $\eta^2 = 4\xi^2 - g_2\xi - g_3$, and v be defined by

$$v = \int_{(x_0, y_0)}^{\xi, \eta} \frac{d\xi}{\eta^2}$$

then $\xi = \phi(v)$ and $\eta = -\phi'(v)$. Thus this equation determines (ξ, η) without ambiguity. In particular the additive indeterminateness of the integral obtained by closed circuits of the point of integration are periods of the function $\phi(u)$; by considerations advanced above

it appears that these periods are sums of integral multiples of two which may be taken to be

$$\omega = 2 \int_{x_1}^x \frac{dx}{\gamma}, \quad \omega' = 2 \int_{x_2}^x \frac{dx}{\gamma};$$

these quantities cannot therefore have a real ratio, for else, being periods of a monogenic function, they would, as we have previously seen, be each integral multiples of another period; there would then be a closed path for (x, y) , starting from an arbitrary point (x_0, y_0) , other than one enclosing two of the points $(e_1, 0)$, $(e_2, 0)$, $(e_3, 0)$, (∞, ∞) , which leads back to the initial point (x_0, y_0) , which is impossible. On the whole, therefore, it appears that the function $\phi(u)$ agrees with the function $\mathfrak{P}(u)$ previously discussed, and the discussion of the elliptic integrals can be continued in the manner given under § 14, *Doubly Periodic Functions*.

§ 21. *Modular Functions*.—One result of the previous theory is the remarkable fact that if

$$\omega = 2 \int_{x_1}^x \frac{dx}{\gamma}, \quad \omega' = 2 \int_{x_2}^x \frac{dx}{\gamma},$$

where $\gamma^2 = 4(x - e_1)(x - e_2)(x - e_3)$, then we have

$$e_1 = (\frac{1}{2}\omega)^2 + 2 \sum [(m+1)\omega + m'\omega']^2 - (m\omega + m'\omega')^2,$$

and a similar equation for e_2 , where the summation refers to all integer values of m and m' other than the one pair $m=0, m'=0$. This, with similar results, has led to the consideration of functions of the complex ratio ω'/ω .

It is easy to see that the series for $\mathfrak{P}(u)$, $u^2 + 2 \sum [(u + m\omega + m'\omega')^2 - (m\omega + m'\omega')^2]$, is unaffected by replacing ω, ω' by two quantities Ω, Ω' equal respectively to $\rho\omega + \rho'\omega', \rho''\omega + \rho'''\omega'$, where $\rho, \rho', \rho'', \rho'''$ are any integers for which $\rho\rho'' - \rho'\rho''' = 1$; furthermore it can be proved that all substitutions with integer coefficients $\Omega = \rho\omega + \rho'\omega', \Omega' = \rho''\omega + \rho'''\omega'$, wherein $\rho\rho'' - \rho'\rho''' = 1$, can be built up by repetitions of the two particular substitutions $(\Omega = \omega', \Omega' = \omega), (\Omega = \omega + \omega', \Omega' = \omega)$ expressed by

$$h = -\mathfrak{P}(\frac{1}{2}\omega) \mathfrak{P}(\frac{1}{2}\omega');$$

it is at once seen from the properties of the function $\mathfrak{P}(u)$ that by the two particular substitutions referred to we obtain the corresponding substitutions for h expressed by

$$h' = 1/h, \quad h'' = 1 - h;$$

thus, by all the integer substitutions $\Omega = \rho\omega + \rho'\omega', \Omega' = \rho''\omega + \rho'''\omega'$, in which $\rho\rho'' - \rho'\rho''' = 1$, the function h can only take one of the six values $h, 1/h, 1-h, 1/(1-h), h/(h-1), (h-1)/h$, which are the roots of an equation in θ ,

$$\frac{(1-\theta+\theta^2)^3}{\theta^2(1-\theta)^2} = \frac{(1-h+h^2)^3}{h^2(1-h)^2};$$

the function of τ , $\omega = i\tau$, expressed by the right side, is thus unaltered by every one of the substitutions $\tau' = \frac{\rho + q\tau}{\rho + q\tau'}$, wherein

ρ, q, ρ', q' are integers having $\rho q' - \rho' q = 1$. If the imaginary part σ of τ , which we may write $\tau = \rho + i\sigma$, is positive, the imaginary part of τ' , which is equal to $\sigma(\rho q' - \rho' q)/(\rho + q\tau)^2 + \sigma^2$, is also positive; suppose σ to be positive; it can be shown that the upper half of the infinite plane of the complex variable τ can be divided into regions, all bounded by arcs of circles (or straight lines), no two of these regions overlapping, such that any substitution of the kind under consideration, $\tau' = (\rho + q\tau)/(\rho + q\tau')$ leads from an arbitrary point τ , of one of these regions, to a point τ' of another; taking $\tau = \rho + i\sigma$, one of these regions may be taken to be that for which $-\frac{1}{2} < \rho < \frac{1}{2}$, $\rho^2 + \sigma^2 > 1$, together with the points for which ρ is negative on the curves limiting this region; then every other region is obtained from this so-called fundamental region by one and only one of the substitutions $\tau' = (\rho + q\tau)/(\rho + q\tau')$, and hence by a definite combination of the substitutions $\tau' = -1/\tau, \tau' = 1 + \tau$. Upon the infinite half plane of τ , the function considered above,

$$z(\tau) = \frac{\mathfrak{P}(\frac{1}{2}\omega) + \mathfrak{P}(\frac{1}{2}\omega') \mathfrak{P}(\tau) + \mathfrak{P}(\frac{1}{2}\omega')^2}{\mathfrak{P}(\frac{1}{2}\omega) \mathfrak{P}(\tau) + \mathfrak{P}(\frac{1}{2}\omega') \mathfrak{P}(\tau) + \mathfrak{P}(\frac{1}{2}\omega')^2}$$

is a single valued monogenic function, whose only essential singularities are the points $\tau' = (\rho' + q'\tau)/(\rho + q\tau)$ for which $\tau = \infty$, namely those for which τ' is any real rational value; the real axis is thus a line over which the function $z(\tau)$ cannot be continued, having an essential singularity in every arc of it, however short; in the fundamental region, $z(\tau)$ has thus only the single essential singularity, $\tau = \rho + i\sigma$; in this fundamental region $z(\tau)$ takes any assigned complex value just once, the relation $z(\tau') = z(\tau)$ requiring, as can be shown, that τ' is of the form $(\rho' + q'\tau)/(\rho + q\tau)$, in which ρ, q, ρ', q' are integers with $\rho q' - \rho' q = 1$; the function $z(\tau)$ has thus a similar behaviour in every other of the regions. The division of the plane into regions is analogous to the division of the plane, in the case of doubly periodic functions, into parallelograms; in that case we considered only functions without essential singularities, and in each of the regions the function assumed every complex value twice, at least. Putting, as another function of τ , $J(\tau) = z(\tau) [z(\tau) - 1]$, it can be shown that $J(\tau) = 0$ for $\tau = \exp(\frac{1}{2}\pi i)$, that $J(\tau) = 1$ for $\tau = i$, these being values of τ on the boundary of the fundamental region; like $z(\tau)$ it has an essential singularity for $\tau = \rho + i\sigma, \sigma = +\infty$. In the

theory of linear differential equations it is important to consider the inverse function $J(\tau)$, this is infinitely many valued, having a cycle of three values for circulation of J about $J=0$ (the circuit of this point leading to a linear substitution for τ of period 3, such as $\tau' = -(1+\tau)^{-1}$), having a cycle of two values about $J=1$ (the circuit leading to a linear substitution for τ of period 2, such as $\tau' = \tau^{-1}$), and having a cycle of infinitely many values about $J=\infty$ (the circuit leading to a linear substitution for τ which is not periodic, such as $\tau' = 1+\tau$). These are the only singularities for the function $\tau(J)$. Each of the functions

$$J(\tau) \parallel, J(\tau-1) \parallel, \left[-\frac{\mathfrak{B}(\lambda\omega) + 2\mathfrak{B}(\frac{1}{2}\omega)}{\mathfrak{B}(\omega) - \mathfrak{B}(\frac{1}{2}\omega)} \right] \parallel,$$

beside many others (see below), is a single valued function of τ , and is expressible without ambiguity in terms of the single valued function of τ ,

$$\eta(\tau) = \exp \left(\frac{i\pi\tau}{12} \right) \prod_{n=1}^{\infty} [1 - \exp(i\pi n\tau)],$$

$$= \exp \left(\frac{i\pi\tau}{12} \right) \sum_{n=-\infty}^{\infty} (-1)^n \exp [(3n^2 + m)\pi i\tau].$$

It should be remarked, however, that $\eta(\tau)$ is not unaltered by all the substitutions we have considered; in fact

$$\eta(-\tau) = (-i)\eta(\tau), \quad \eta(1+\tau) = \exp \left(\frac{i\pi}{12} \right) \eta(\tau).$$

The aggregate of the substitutions $\tau' = (\rho' + q'\tau)/(\rho + q\tau)$, wherein ρ, q, ρ', q' are integers with $\rho q' - \rho'q = 1$, represents a Group; the function $J(\tau)$, unaltered by all these substitutions, is called a *Modular Function*. More generally any function unaltered by all the substitutions of a group of linear substitutions of its variable is called an *Automorphic Function*. A rational function, of its variable h , of this character, is the function $(1-h+h^2)^{-1/2} (1-h)^{-1/2}$ presenting itself incidentally above; and there are other rational functions with a similar property, the group of substitutions belonging to any one of these being what is a very curious fact, associable with that of the rotations of one of the regular solids, about an axis through its centre, which bring the solid into coincidence with itself. Other automorphic functions are the double periodic functions already discussed; these, as we have seen, enable us to solve the algebraic equation $y^2 = 4x^3 - g_2y - g_3$ (and in fact many other algebraic equations, see below, under § 23, *Geometrical Applications of Elliptic Functions*) in terms of single valued functions $x = \mathfrak{B}(u), y = \mathfrak{B}'(u)$. A similar utility, of a more extended kind, belongs to automorphic functions in general; but it can be shown that such functions necessarily have an infinite number of essential singularities except for the simplest cases.

The modular function $J(\tau)$ considered above, unaltered by the group of linear substitutions $\tau' = (\rho' + q'\tau)/(\rho + q\tau)$, where ρ, q, ρ', q' are integers with $\rho q' - \rho'q = 1$, may be taken as the independent variable x of a differential equation of the third order, of the form

$$\frac{s'''}{s'} - \frac{3}{2} \left(\frac{s''}{s'} \right)^2 = \frac{1-a^2}{2(x-1)^2} + \frac{1-\beta^2}{2x^2} + \frac{a^2 + \beta^2 - \gamma^2 - 1}{2x(x-1)},$$

where $s' = ds/dx$, &c., of which the dependent variable s is equal to τ . A differential equation of this form is satisfied by the quotient of two independent integrals of the linear differential equation of the second order satisfied by the hypergeometric functions. If the solution of the differential equation for s be written $s(a, \beta, \gamma, x)$, we have in fact $\tau = s(\frac{1}{2}, \frac{1}{2}, 0)$. If we introduce also the function of τ given by

$$\lambda = \frac{2\mathfrak{B}(\frac{1}{2}\omega) + \mathfrak{B}(\omega)}{\mathfrak{B}(\frac{1}{2}\omega) - \mathfrak{B}(\omega)},$$

we similarly have $\tau = s(0, 0, \lambda)$; this function λ is a single valued function of τ , which is also a modular function, being unaltered by a group of integral substitutions also of the form $\tau' = (\rho' + q'\tau)/(\rho + q\tau)$, with $\rho q' - \rho'q = 1$, but with the restriction that ρ' and q' are even integers, and therefore ρ and q are odd integers. This group is thus a subgroup of the general modular group, and is in fact of the kind called a self-conjugate subgroup. As in the general case this subgroup is associated with a subdivision of the plane into regions of which any one is obtained from a particular region, called the fundamental region, by a regular one of the substitutions of the subgroup. This fundamental region, putting $\tau = \rho + i\sigma$, may be taken to be that given by $-1 < \rho < 1, (\rho + \frac{1}{2})^2 + \sigma^2 > \frac{1}{4}, (\rho - \frac{1}{2})^2 + \sigma^2 > \frac{1}{4}$, and is built up of six of the regions which arose for the general modular group associated with $J(\tau)$. Within this fundamental region, λ takes every complex value just once, except the values $\lambda = 0, 1, \infty$, which arise only at the angular points $\tau = 0, \tau = \infty, \tau = -1$ and the equivalent point $\tau = 1$; these angular points are essential singularities for the function $\lambda(\tau)$. For $\lambda(\tau)$ as for $J(\tau)$, the region of existence is the upper half plane of τ , there being an essential singularity in every length of the real axis, however short.

If, beside the plane of τ , we take a plane to represent the values of λ , the function $\tau = s(0, 0, \lambda)$ being considered thereon, the values of τ belonging to the interior of the fundamental region of the τ -plane considered above, will require the consideration of the whole of the λ -plane taken once with the exception of the portions of the real axis lying between $-\infty$ and 0 and between 1 and $+\infty$, the two sides of the first portion corresponding to the circumferences of the

τ -plane expressed by $(\rho + \frac{1}{2})^2 + \sigma^2 = \frac{1}{4}, (\rho - \frac{1}{2})^2 + \sigma^2 = \frac{1}{4}$, while the two sides of the latter portion, for which λ is real and > 1 , correspond to the lines of the τ -plane expressed by $\rho = \pm 1$. The line for which λ is real, positive and less than unity corresponds to the imaginary axis of the τ -plane, lying in the interior of the fundamental region. All the values of $\tau = s(0, 0, \lambda)$ may then be derived from those belonging to the fundamental region of the τ -plane by making λ describe a proper succession of circuits about the points $\lambda = 0, \lambda = 1$; any such circuit subjects τ to a linear substitution of the subgroup of τ considered, and corresponds to a change of τ from a point of the fundamental region to a corresponding point of one of the other regions.

§ 22. *A Property of Integral Functions deduced from the Theory of Modular Functions.*—Consider now the function $\exp(s)$, for finite values of s ; for such values of s , $\exp(s)$ never vanishes, and it is impossible to assign a closed circuit for s in the finite part of the plane of s which will make the function $\lambda = \exp(s)$ pass through a closed succession of values in the plane of λ having $\lambda = 0$ in its interior; the function $s(0, 0, \lambda)$, however s vary in the finite part of the plane, will therefore never be subjected to those linear substitutions imposed upon $s(0, 0, \lambda)$ by a circuit of λ about $\lambda = 0$; more generally, if $\phi(s)$ be an integral function of s , never becoming either zero or unity for finite values of s , the function $\lambda = \phi(s)$, however s vary in the finite part of the plane, will never make, in the plane of λ , a circuit about either $\lambda = 0$ or $\lambda = 1$, and $s(0, 0, \lambda)$, that is $s(0, 0, \phi(s))$, will be single valued for all finite values of s ; it will moreover remain finite, and be monogenic. In other words, $s(0, 0, \phi(s))$ is also an integral function—whose imaginary part, moreover, by the property of $s(0, 0, \lambda)$, remains positive for all finite values of s . In that case, however, $\exp\{i s(0, 0, \phi(s))\}$ would also be an integral function of s with modulus less than unity for all finite values of s . If, however, we describe a circle of radius R in the s plane, and consider the greatest value of the modulus of an integral function upon this circle, this certainly increases indefinitely as R increases. We can infer therefore that an integral function $\phi(s)$ which does not vanish for any finite value of s , takes the value unity and hence (by considering the function $A - \phi(s)$) takes every other value for some definite value of s ; or, an integral function for which both the equations $\phi(s) = A, \phi(s) = B$ are unsatisfied by definite values of s , does not exist, A and B being arbitrary constants.

A similar theorem can be proved in regard to the values assumed by the function $\phi(s)$ for points s of modulus greater than R , however great R may be, also with the help of modular functions. In general terms it may be stated that it is a very exceptional thing for an integral function not to assume every complex value an infinite number of times.

Another application of modular functions is to prove that the function $s(a, \beta, \gamma, \lambda)$ is a single valued function of $\tau = s(0, 0, \lambda)$; for, putting $\tau' = (\rho' + q'\tau)/(\rho + q\tau)$, the values of τ' which correspond to the singular points $\lambda = 0, 1, \infty$ of $s(a, \beta, \gamma, \lambda)$, though infinite in number, all lie on the circumference of the circle $|\tau| = 1$, within which therefore $s(a, \beta, \gamma, x)$ is expressible in a form $\sum_{n=0}^{\infty} a_n \tau^n$. More generally any monogenic function of λ which is single valued save for circuits of the points $\lambda = 0, 1, \infty$, is a single valued function of $\tau = s(0, 0, \lambda)$. Identifying λ with the square of the modulus in Legendre's form of the elliptical integral, we have $\tau = iK'/K$, where

$$K = \int_0^1 \frac{dt}{\sqrt{(1-t^2)(1-\lambda t^2)}}, \quad K' = \int_0^1 \frac{dt}{\sqrt{(1-t^2)(1-(1-\lambda)t^2)}};$$

functions such as $\lambda^{\frac{1}{2}}, (1-\lambda)^{\frac{1}{2}}, \lambda(1-\lambda)^{\frac{1}{2}}$, which have only $\lambda = 0, 1, \infty$ as singular points, were expressed by Jacobi as power series in $q = e^{i\pi\tau}$, and therefore, at least for a limited range of values of τ , as single valued functions of τ ; it follows by the theorem given that any product of a root of λ and a root of $1-\lambda$ is a single valued function of τ . More generally the differential equation

$$x(1-x) \frac{d^2y}{dx^2} + \gamma(-a+\beta+1)x \frac{dy}{dx} - a\beta y = 0$$

may be solved by expressing both the independent and dependent variables as single valued functions of a single variable τ , the expression for the independent variable being $x = \lambda(\tau)$.

§ 23. *Geometrical Applications of Elliptic Functions.*—Consider any irreducible algebraic equation rational in $x, y, f(x, y) = 0$, of such a form that the equation represents a plane curve of order n with $\frac{1}{2}n(n-3)$ double points; taking upon this curve $n-3$ arbitrary fixed points, draw through these and the double points the most general curve of order $n-2$; this will intersect

f in $n(n-2) - n(n-3) - (n-3) = 3$ other points, and will contain homogeneously at least $\frac{1}{2}(n-1)n - \frac{1}{2}n(n-3) - (n-3) = 3$ arbitrary constants, and so will be of the form $\lambda\phi + \lambda_1\phi_1 + \lambda_2\phi_2 + \dots = 0$, wherein $\lambda, \lambda_1, \dots$ are in general zero. Put now $\xi = \phi_1/\phi, \eta = \phi_2/\phi$, and eliminate x, y between these equations and $f(x, y) = 0$, so obtaining a rational irreducible equation $F(\xi, \eta) = 0$, representing a further plane curve. To any point (x, y) of f will then correspond a definite point (ξ, η) of F .

For a general position of (x, y) upon f the equations $\phi_1(x', y')/\phi(x', y') = \phi_1(x, y)/\phi(x, y), \phi_2(x', y')/\phi(x', y') = \phi_2(x, y)/\phi(x, y)$, subject to $f(x', y') = 0$, will have the same number of solutions (x', y') ; if their only solution is $x' = x, y' = y$, then to any position (ξ, η) of F will conversely correspond only one position (x, y) of f . If these equations have another solution beside (x, y) , then any curve $\lambda\phi + \lambda_1\phi_1 + \lambda_2\phi_2 = 0$ which passes (through the double points of f and) through the $n-2$ points of f constituted by the fixed $n-3$ points and a point (x_0, y_0) , will necessarily pass through a further point, say (x_0', y_0') , and will have only one further intersection with f ; such a curve, with the $n-2$ assigned points, beside the double points, of f , will be of the form $\mu_1\phi + \mu_2\phi_1 + \dots = 0$, where μ_1, μ_2, \dots are generally zero; considering the curves $\psi + \lambda\phi_i = 0$, for variable λ , one of these passes through a further arbitrary point of f , by choosing λ properly, and conversely an arbitrary value of λ determines a single further point of f ; the co-ordinates of the points of f are thus rational functions of a parameter λ , which is itself expressible rationally by the co-ordinates of the point; it can be shown algebraically that such a curve has not $\frac{1}{2}(n-3)n$ but $\frac{1}{2}(n-3)n + 1$ double points.

We may therefore assume that to every point of F corresponds only one point of f , and there is a birational transformation between these curves; the coefficients in this transformation will involve rationally the co-ordinates of the $n-3$ fixed points taken upon f , that is, at the least, by taking these to be consecutive points, will involve the co-ordinates of one point of f , and will not be rational in the coefficients of f unless we can specify a point of f whose co-ordinates are rational in these. The curve F is intersected by a straight line $ax + by + c = 0$, in as many points as the number of unspecified intersections of f with $\lambda\phi + \lambda_1\phi_1 + \lambda_2\phi_2 = 0$, that is, 3; or F will be a cubic curve, without double points.

Such a cubic curve has at least one point of inflection Y , and if a variable line $Y'PQ$ be drawn through Y to cut the curve again in P and Q , the locus of a point R such that YR is the harmonic mean of YP and YQ , is easily proved to be a straight line. Take now a triangle of reference for homogeneous co-ordinates XYZ , of which this straight line is $Y = 0$, and the inflexional tangent at Y is $Z = 0$; the equation of the cubic curve will then be of the form

$$ZV^3 = aX^3 + bX^2Z + cXZ^2 + dZ^3;$$

by putting X equal to $\lambda X + \mu Z$, that is, choosing a suitable line through Y to be $X = 0$, and choosing λ properly, this is reduced to the form

$$ZV^3 = 4X^3 - g_2XZ^2 - g_3Z^3,$$

of which a representation is given, valid for every point, in terms of the elliptic functions $\wp(u), \wp'(u)$, by taking $X = Z\wp(u), Y = Z\wp'(u)$. The value of u belonging to any point is definite save for sums of integral multiples of the periods of the elliptic functions, being given by

$$u = \int_{(\infty)}^{(x,y)} \frac{ZdX - XdZ}{ZV},$$

where (∞) denotes the point of inflection.

It thus appears that the co-ordinates of any point of a plane curve, f , of order n with $\frac{1}{2}(n-3)n$ double points are expressible as elliptic functions, there being, save for periods, a definite value of the argument u belonging to every point of the curve. It can then be shown that if a variable curve, ϕ , of order m be drawn, passing through the double points of the curve, the values of the argument u at the remaining intersections of ϕ with f , have a sum which is unaffected by variation of the coefficients of ϕ , save for additive aggregates of the periods. In virtue of the birational transformation this theorem can be deduced from the theorem that if any straight line cut the cubic $y^2 = 4x^3 - g_2x - g_3$, in points $(u_1), (u_2), (u_3)$, the sum $u_1 + u_2 + u_3$ is zero, or a period; or the general theorem is a corollary from Abel's theorem proved under § 17, *Integrals of Algebraic Functions*. To prove the result directly for the cubic we remark that the variation of one of the intersections (x, y) of the cubic with the straight line $y = mx + n$, due to a variation $\delta m, \delta n$ in m and n , is obtained by differentiation of the equation for the three abscissae, namely the equation

$$F(x) = 4x^3 - g_2x - g_3 - (mx + n)^2 = 0,$$

and is thus given by

$$\frac{dx}{y} = \frac{2\delta m + \delta n}{F'(x)},$$

and the sum of three such fractions as that on the right for the three roots of $F(x) = 0$ is zero; hence $u_1 + u_2 + u_3$ is independent of the straight line considered, if in particular this become the inflexional tangent each of u_1, u_2, u_3 vanishes. It may be remarked in passing

that $x_1 + x_2 + x_3 = \frac{1}{2}m^2$, and hence is $\frac{1}{2}(y_1 - y_2)(y_1 - y_3)/F$; so that we have another proof of the addition equation for the function $\wp(u)$. From this theorem for the cubic curve many of its geometrical properties, as for example those of its inflections, the properties of inscribed polygons, of the three kinds of corresponding points, and the theory of residuation, are at once obvious. And similar results hold for the curve of order n with $\frac{1}{2}(n-3)n$ double points.

§ 24. *Integrals of Algebraic Functions in Connection with the Theory of Plane Curves.*—The developments which have been explained in connection with elliptic functions may enable the reader to appreciate the vastly more extensive theory similarly arising for any algebraical irrationality, $f(x, y) = 0$.

The algebraical integrals $\int R(x, y)dx$ associated with this may as before be divided into those of the first kind, which have no infinities, those of the second kind, possessing only algebraical infinities, and those of the third kind, for which logarithmic infinities enter. Here there is a certain number, p , greater than unity, of linearly independent integrals of the first kind; and this number p is unaltered by any birational transformation of the fundamental equation $f(x, y) = 0$; a rational function can be constructed with poles of the first order at $p+1$ arbitrary positions (x, y) , satisfying $f(x, y) = 0$, but not with a fewer number unless their positions are chosen properly, a property we found for the case $p=1$; and p is the number of linearly independent curves of order $n-3$ passing through the double points of the curve of order n expressed by $f(x, y) = 0$. Again any integral of the second kind can be expressed as a sum of p integrals of this kind, with poles of the first order at arbitrary positions, together with rational functions and integrals of the first kind; and an integral of the second kind can be found with one pole of the first order of arbitrary position, and an integral of the third kind with two logarithmic infinities, at arbitrary position; the corresponding properties for $p=1$ are proved above.

There is, however, a difference of essential kind in regard to the inversion of integrals of the first kind; if $u = \int R(x, y)dx$ be such an integral, it can be shown, in common with all algebraic integrals associated with $f(x, y) = 0$, to have $2p$ linearly independent additive constants of indeterminateness; the upper limit of the integral cannot therefore, as we have shown, be a single valued function of the value of the integral. The corresponding theorem, if $\int R(x, y)dx$ denote one of the integrals of the first kind, is that the p equations

$$\int R_1(x, y)dx + \dots + \int R_p(x, y)dx = u_i,$$

determine the rational symmetric functions of the p positions $(x, y), \dots (x, y_p)$ as single valued functions of the p variables, u_1, \dots, u_p . It is thus necessary to enter into the theory of functions of several independent variables; and the equation $f(x, y) = 0$ is thus not, in this way, capable of solution by single valued functions of one variable. That solution in fact is to be sought with the help of automorphic functions, which, however, as has been remarked, have, for $p > 1$, an infinite number of essential singularities.

§ 25. *Monogenic Functions of Several Independent Variables.*—A monogenic function of several independent complex variables u_1, \dots, u_p is to be regarded as given by an aggregate of power series all obtainable by continuation from any one of them in a manner analogous to that before explained in the case of one independent variable. The singular points, defined as the limiting points of the range over which such continuation is possible, may either be poles, or polar points of indetermination, or essential singularities.

A pole is a point $(u_1^{(0)}, \dots, u_p^{(0)})$ in the neighbourhood of which the function is expressible as a quotient of converging power series in $u_1 - u_1^{(0)}, \dots, u_p - u_p^{(0)}$; of these the denominator series D must vanish at $(u_1^{(0)}, \dots, u_p^{(0)})$, since else the fraction is expressible as a power series and the point is not a singular point, but the numerator series N must not also vanish at $(u_1^{(0)}, \dots, u_p^{(0)})$, or if it does, it must be possible to write $D = MD_0, N = MN_0$, where M is a converging power series vanishing at $(u_1^{(0)}, \dots, u_p^{(0)})$, and N_0 is a converging power series, in $u_1 - u_1^{(0)}, \dots, u_p - u_p^{(0)}$, not so vanishing. A polar point of indetermination is a point about which the function can be expressed as a quotient of two converging power series, both of which vanish at the point. As in such a simple case as $(Ax + By)/(ax + by)$, about $x = 0, y = 0$, it can be proved that then the function can be made to approach to any arbitrarily assigned value by making the variables u_1, \dots, u_p approach to $u_1^{(0)}, \dots, u_p^{(0)}$ by a proper path. It is the necessary existence of such polar points of indetermination, which in case $p > 2$ are not merely isolated points, which renders the theory essentially more difficult than that of functions of one variable. An essential singularity is any which does not come under one of the two former descriptions and includes very various possibilities. A point at infinity in this theory is one for which any one of the variables u_1, \dots, u_p is indefinitely great; such points are brought under the preceding definitions by means

of the convention that for $u_i^{(0)} = \infty$, the difference $u_i - u_i^{(0)}$ is to be understood to stand for u_i^{-1} . This being so, a single valued function of u_1, \dots, u_p without essential singularities for infinite or finite values of the variables can be shown, by induction, to be, as in the case of $p=1$, necessarily a rational function of the variables. A function having no singularities for finite values of all the variables is as before called an integral function; it is expressible by a power series converging for all finite values of the variables; a single valued function having for finite values of the variables no singularities other than poles or polar points of indetermination is called a meromorphic function; as for $p=1$ such a function can be expressed as a quotient of two integral functions having no common zero point other than the points of indetermination of the function, but the proof of this theorem is difficult.

The proof of this theorem is difficult, as explained above, in the inversion of algebraic integrals of the first kind, for $p>1$, are meromorphic. They must also be periodic, unaffected that is when the variables u_1, \dots, u_p are simultaneously increased each by a proper constant, these being the additive constants of indeterminateness for the p integrals $\int R(x,y)dx$ arising when (x,y) makes a closed circuit, the same for each integral. The theory of such single valued meromorphic periodic functions is simpler than that of meromorphic functions of several variables in general, as it is sufficient to consider only finite values of the variables; it is the natural extension of the theory of doubly periodic functions previously discussed. It can be shown to reduce, though the proof of this requires considerable developments of which we cannot speak, to the theory of a single integral function of u_1, \dots, u_p , called the *Theta Function*. This is expressible as a series of positive and negative integral powers of quantities $\exp(c_1 u_1), \exp(c_2 u_2), \dots, \exp(c_p u_p)$, wherein c_1, \dots, c_p are proper constants; for $p=1$ this theta function is essentially the same as that above given under a different form (see § 14, *Doubly Periodic Functions*); the function $\vartheta(u)$. In the case of $p=1$, all meromorphic functions periodic with the same two periods have been shown to be rational functions of two of them connected by a single algebraic equation; in the same way all meromorphic functions of p variables, periodic with the same sets of simultaneous periods, $2p$ sets in all, can be shown to be expressible rationally in terms of $p+1$ such periodic functions connected by a single algebraic equation. Let x_1, \dots, x_p, y denote $p+1$ such functions; then each of the partial derivatives dx_i/du_j will equally be a meromorphic function of the same periods, and so expressible rationally in terms of x_1, \dots, x_p, y ; thus there will exist p equations of the form

$$dx_i = R_i dx_1 + \dots + R_p dx_p,$$

and hence p equations of the form

$$du_i = H_{i1} dx_1 + \dots + H_{ip} dx_p,$$

wherein H_{ij} are rational functions of x_1, \dots, x_p, y , these being connected by a fundamental algebraic (rational) equation, say $f(x_1, \dots, x_p, y) = 0$. This then is the generalized form of the corresponding equation for $p=1$.

§ 26. *Multiply-Periodic Functions and the Theory of Surfaces.*—The theory of algebraic integrals $\int R(x,y)dx$, wherein x,y are connected by a rational equation $f(x,y)=0$, has developed concurrently with the theory of algebraic curves; in particular the existence of the number p invariant by all birational transformations is one result of an extensive theory in which curves capable of birational correspondence are regarded as equivalent; this point of view has made possible a general theory of what might otherwise have remained a collection of isolated theorems.

In recent years developments have been made which point to a similar unity of conception as possible for surfaces, or indeed for algebraic constructs of any number of dimensions. These developments have been in two directions, at first followed independently, but now happily brought into the most intimate connexion. On the analytical side, E. Picard has considered the possibility of classifying integrals of the form $\int R(dx+Sy)$, belonging to a surface $f(x,y,z)=0$, wherein R and S are rational functions of x, y, z , according as they are (1) everywhere finite, (2) have poles, which then lie along curves upon the surface, or (3) have logarithmic infinities, also then lying along curves, and has brought the theory to a high degree of perfection. On the geometrical side A. Clebsch and M. Noether, and more recently the Italian school, have considered the geometrical characteristics of a surface which are unaltered by birational transformation. It was first remarked that for surfaces of order n there are associated surfaces of order $n-4$, having properties in relation thereto analogous to those of curves of order $n-3$ for a plane curve of order n ; if such a surface $f(x,y,z)=0$ have a double curve with triple points triple also for the surface, and $\phi(x,y,z)=0$ be a surface of order $n-4$ passing through the double curve, the double integral

$$\iint \frac{\phi dx dy}{\partial f/\partial z}$$

is everywhere finite; and, the most general everywhere finite integral of this form remains invariant in a birational transformation of the surface f , the theorem being capable of generalization to

algebraic constructs of any number of dimensions. The number of linearly independent surfaces of order $n-4$, possessing the requisite particularity in regard to the singular lines and points of the surface, is thus a number invariant by birational transformation, and the equality of these numbers for two surfaces is a necessary condition of their being capable of such transformation. The number of surfaces of order n having the assigned particularity in regard to the singular points and lines of the fundamental surface can be given by a formula for a surface of given singularity; but the value of this formula for $m=n-4$ is not in all cases equal to the actual number of surfaces of order $n-4$ with the assigned particularity, and for a cone (or ruled surface) is in fact negative, being the negative of the deficiency of the plane section of the cone. Nevertheless this number for $m=n-4$ is also found to be invariant for birational transformation. This number, now denoted by p_2 , is then a second invariant of birational transformation. The former number, of actual surfaces of order $n-4$ with the assigned particularity in regard to the singularities of the surface, is now denoted by p_1 . The difference $p_1 - p_2$, which is never negative, is a most important characteristic of a surface. When it is zero, as in the case of the general surface of order n , and in a vast number of other ordinary cases, the surface is called regular.

On a plane algebraical curve we may consider linear series of sets of points, obtained by the intersection with it of curves $\lambda_0 + \lambda_1 \phi_1 + \dots = 0$, wherein $\lambda, \lambda_1, \dots$ are variable coefficients; such a series consists of the sets of points where a rational function of given poles, belonging to the construct $f(x,y)=0$, has constant values. And we may consider series of sets of points determined by variable curves whose coefficients are algebraical functions, not necessarily rational functions, of parameters. Similarly on a surface we may consider linear systems of curves, obtained by the intersection with the given surface of variable surfaces $\lambda_0 + \lambda_1 \phi_1 + \dots = 0$, and may consider algebraic systems, of which the individual curve is given by variable surfaces whose coefficients are algebraical, not necessarily rational, functions of parameters. Of a linear series upon a plane curve there are two numbers manifestly invariant in birational transformation, the *order*, which is the number of points forming a set of the series, and the *dimension*, which is the number of parameters $\lambda_1/\lambda, \lambda_2/\lambda, \dots$ entering linearly in the equation of the series. The series is *complete* when it is not contained in a series of the same order but of higher dimension. So for a linear system of curves upon a surface, we have three invariants for birational transformation; the *order*, being in the number of variable intersections of two curves of the system, the *dimension*, being the number of linear parameters $\lambda_1/\lambda, \lambda_2/\lambda, \dots$ in the equation for the system, and the *deficiency* of the individual curves of the system. Upon any curve of the linear system the other curves of the system define a linear series, called the *characteristic series*; but even when the linear system is complete, that is, not contained in another linear system of the same order and higher dimension, it does not follow that the characteristic series is complete; it may be contained in a series whose dimension is greater by $p_2 - p_1$ than its own dimension. When this is so it can be shown that the linear system of curves is contained in an algebraic system whose dimension is greater by $p_2 - p_1$ than the dimension of the linear system. The extra $p_2 - p_1$ variable parameters so entering may be regarded as the independent co-ordinates of an algebraic construct $f(y_1, \dots, y_{p_2-p_1})=0$; this construct has the property that its co-ordinates are single valued meromorphic functions of p variables, which are periodic, possessing $2p$ systems of periods; the p variables are expressible in the forms

$$u_i = \int R_i(x,y) dx_1 + \dots + \int R_p(x,y) dx_p,$$

wherein $R_i(x,y)$ denotes a rational function of x_1, \dots, x_p and y . The original surface has correspondingly p integrals of the form $\int (R dx + S dy)$, wherein R, S are rational in x, y, z , which are everywhere finite; and it can be shown that it has no other such integrals. From this point of view, then, the number $p_1 - p_2$ is, for a surface, analogous to the deficiency of a plane curve; another analogy arises in the comparison of the theorems: for a plane curve of zero deficiency there exists no algebraic series of sets of points which does not consist of sets belonging to a linear series; for a surface for which $p_2 - p_1 = 0$ there exists no algebraic system of curves not contained in a linear system.

But whereas for a plane curve of deficiency zero, the co-ordinates of the points of the curve are rational functions of a single parameter, it is not necessarily the case that for a surface having $p_2 - p_1 = 0$ the co-ordinates of the points are rational functions of two parameters; it is necessary that $p_2 - p_1 = 0$, but this is not sufficient. For surfaces, beside the p_1 linearly independent surfaces of order $n-4$ having a definite particularity at the singularities of the surface, it is useful to consider surfaces of order $k(n-4)$, also having each a definite particularity at the singularities, the number of these, not containing the original surface as component, which are linearly independent, is denoted by P_k . It can then be stated that a sufficient condition for a surface to be rational consists of the two conditions $p_2 = 0, P_1 = 0$. More generally it becomes a problem to classify surfaces according to the values of the various numbers which are invariant under birational transformation, and to determine for each the simplest form of surface to which it is birationally equivalent. Thus, for example, the hyperelliptic surface discussed by Humbert,

of which the co-ordinates are meromorphic functions of two variables of the simplest kind, with four sets of periods, is characterized by $p_2=1$, $p_3=-1$; or again, any surface possessing a linear system of curves of which the order exceeds twice the deficiency of the individual curves diminished by two, is reducible by birational transformation to a ruled surface or is a rational surface. But beyond the general statement that much progress has already been made in this direction, of great interest to the student of the theory of functions, nothing further can be added here.

BIBLIOGRAPHY.—The learner will find a lucid introduction to the theory in E. Goursat, *Cours d'analyse mathématique*, t. ii. (Paris, 1905), or, with much greater detail, in A. R. Forsyth, *Theory of Functions of a Complex Variable* (2nd ed., Cambridge, 1900); for logical rigour in the more difficult theorems, he should consult W. F. Osgood, *Lehrbuch der Functionentheorie*, Bd. i. (Leipzig, 1906-1907); for greater precision in regard to the necessary quasi-geometrical axioms, beside the indications attempted here, he should consult W. H. Young, *The Theory of Sets of Points* (Cambridge, 1906), chs. viii.-xiii., and C. Jordan, *Cours d'analyse*, t. i. (Paris, 1893), chs. i., ii.; a comprehensive account of the *Theory of Functions of Real Variables* is by E. W. Hobson (Cambridge, 1907). Of the theory regarded as based after Weierstrass upon the theory of power series, there is J. Harkness and F. Morley, *Introduction to the Theory of Analytic Functions* (London, 1898), an elementary treatise; for the theory of the convergence of series there is also T. J. L'A. Bromwich, *An Introduction to the Theory of Infinite Series* (London, 1908); but the student should consult the collected works of Weierstrass (Berlin, 1894 ff.), and the writings of Mittag-Leffler in the early volumes of the *Acta mathematica*; earlier expositions of the theory of functions on the basis of power series are in C. Méray, *Leçons nouvelles sur l'analyse infinitésimale* (Paris, 1894) and in Lagrange's books on the Theory of Functions. An account of the theory of potential in its applications to the present theory is found in most treatises; in particular consult E. Picard, *Traité d'analyse*, t. ii. (Paris, 1893). For elliptic functions there is an introductory book, P. Appell and E. Lacour, *Principes de la théorie des fonctions elliptiques et applications* (Paris, 1897), beside the treatises of G. H. Halphen, *Traité des fonctions elliptiques et de leurs applications* (three parts, Paris, 1886 ff.), and J. Tannery et J. Molk, *Éléments de la théorie des fonctions elliptiques* (Paris, 1893 ff.); a book, A. G. Greenhill, *The Applications of Elliptic Functions* (London, 1892), shows how the functions enter in problems of many kinds. For modular functions there is an extensive treatise, F. Klein and R. Fricke, *Theorie der elliptischen Modulfunctionen* (Leipzig, 1890); see also the most interesting smaller volume, F. Klein, *Über das Ikosaeder* (Leipzig, 1884) (also obtainable in English). For the theory of Riemann's surface, and algebraic integrals, an interesting introduction is P. Appell and E. Goursat, *Théorie des fonctions algébriques et de leurs intégrales*; for Abelian functions see also H. Stahl, *Théorie der Abel'schen Functionen* (Leipzig, 1896), and H. F. Baker, *An Introduction to the Theory of Multiply Periodic Functions* (Cambridge, 1907), and H. F. Baker, *Abel's Theorem and the Allied Theory, including the Theory of the Theta Functions* (Cambridge, 1897); for theta functions of one variable a standard work is C. G. Jacobi, *Fundamenta nova*, &c. (Königsberg, 1828); for the general theory of theta functions, consult W. Wirtinger, *Untersuchungen über Theta-Functionen* (Leipzig, 1895). For a history of the theory of algebraic functions consult A. Brill and M. Noether, *Die Entwicklung der Theorie der algebraischen Functionen in älterer und neuerer Zeit, Bericht der deutschen Mathematiker-Vereinigung* (1894); and for a special theory of algebraic functions, K. Hensel and G. Landsberg, *Theorie der algebraischen Function u. s. w.* (Leipzig, 1902). The student will, of course, consult also Riemann's and Weierstrass's *Ges. Werke*. For the applications to geometry in general an important contribution, of permanent value, is E. Picard and G. Simart, *Théorie des fonctions algébriques de deux variables indépendantes* (Paris, 1897-1906). This work contains, as Note v. t. ii. p. 485, a valuable summary by M. M. Castelnuovo and Enriques, *Sur quelques résultats nouveaux dans la théorie des surfaces algébriques*, containing many references to the numerous memoirs to be found, for the most part, in the transactions of scientific societies and the mathematical journals of Italy.

Beside the books above enumerated there exists an unlimited number of individual memoirs, often of permanent importance and only imperfectly, or too elaborately, reproduced in the pages of the volumes in which the student will find references to them. The German *Encyclopædia of Mathematics*, and the Royal Society's *Reference Catalogue of Current Scientific Literature, Pure Mathematics*, published yearly, should also be consulted. (H. F. BA.)

FUNDY, BAY OF, an inlet of the North Atlantic, separating New Brunswick from Nova Scotia. It is 145 m. long and 48 m. wide at the mouth, but gradually narrows towards the head, where it divides into Chignecto Bay to the north, which subdivides into Shepody Bay and Cumberland Basin (the French Beaubassin), and Minas Channel, leading into Minas Basin, to the east and south. Off its western shore opens Passamaquoddy Bay, a magnificent sheet of deep water with good anchorage,

receiving the waters of the St Croix river and forming part of the boundary between New Brunswick and the state of Maine. The Bay of Fundy is remarkable for the great rise and fall of the tide, which at the head of the bay has been known to reach 62 ft. In Passamaquoddy Bay the rise and fall is about 25 ft., which gradually increases toward the narrow upper reaches. At spring tides the water in the Bay of Fundy is 10 ft. higher than it is in Bay Verte, in Northumberland Strait, only 15 m. distant. Though the bay is deep, navigation is rendered dangerous by the violence and rapidity of the tide, and in summer by frequent fogs. At low tide, at such points as Moncton or Amherst, only an expanse of red mud can be seen, and the tide rushes in a bore or crest from 3 to 6 ft. in height. Large areas of fertile marshes are situated at the head of the bay, and the remains of a submerged forest show that the land has subsided in the latest geological period at least 40 ft. The bay receives the waters of the St Croix and St John rivers, and has numerous harbours, of which the chief are St Andrews (on Passamaquoddy Bay) and St John in New Brunswick, and Digby and Annapolis (on an inlet known as Annapolis Basin) in Nova Scotia. It was first explored by the Sieur de Monts (d. c. 1628) in 1604 and named by him *La Baye Française*.

FUNERAL RITES, the ceremonies associated with different methods of disposing of the dead. (See also BURIAL AND BURIAL ACTS; CEMETERY; and CREMATION.) In general we have little record, except in their tombs, of races which, in a past measured not merely by hundreds but by thousands of years, occupied the earth; and exploration of these often furnishes our only clue to the religions, opinions, customs, institutions and arts of long vanished societies. In the case of the great culture folks of antiquity, the Babylonians, Egyptians, Hindus, Persians, Greeks and Romans, we have, besides their monuments, the evidence of their literatures, and so can know nearly as much of their rites as we do of our own. The rites of modern savages not only help us to interpret prehistoric monuments, but explain peculiarities in our own rituals and in those of the culture folks of the past of which the significance was lost or buried under etiological myths. We must not then confine ourselves to the rites of a few leading races, neglecting their less fortunate brethren who have never achieved civilization. It is better to try to classify the rites of all races alike according as they embody certain leading conceptions of death, certain fears, hopes, beliefs entertained about the dead, about their future, and their relations with the living.

The main ideas, then, underlying funeral rites may roughly be enumerated as follows:

1. The pollution or taboo attaching to a corpse.
 2. Mourning.
 3. The continued life of the dead as evinced in the housing and equipment of the dead, in the furnishing of food for them, and in the orientation and posture assigned to the body.
 4. Communion with the dead in a funeral feast and otherwise.
 5. Sacrifice for the dead and expiation of their sins.
 6. Death witchery.
 7. Protection of the dead from ghouls.
 8. Fear of ghosts.
1. A dead body is unclean, and the uncleanness extends to things and persons which touch it. Hence the Jewish law (Num. v. 2) enacted that "whoever is unclean by the dead shall be put outside the camp, that they defile not the camp in the midst whereof the Lord dwells." Such persons were unclean until the even, and might not eat of the holy things unless they bathed their flesh in water. A high priest might on no account "go in to any dead body" (Lev. xxi. 11). Why a corpse is so widely tabooed is not certain; but it is natural to see one reason in the corruption which in warm climates soon sets in. The common experience that where one has died another is likely to do so may also have contributed, though, of course, there was no scientific idea of infection. The old Persian scriptures are full of this taboo. He who has touched a corpse is "powerless in mind, tongue and hand" (*Zend Avesta in Sacred Books of the East*, pt. i. p. 120), and the paralysis is inflicted by the innumerable *drugs* or evil spirits which invest a corpse. Fire and earth, being alike creations of the good and pure god

Ahuramazda, a body must not be burned or buried; and so the ancient Persians and their descendants the Parsees build Dakmas or "towers of silence" on hill-tops far from human habitations. Inside these the corpses are laid on a flagged terrace which drains into a central pit. Twice a year the bones, picked clean by dogs and birds of prey, are collected in the pit, and when it is full another tower is built. In ancient times perhaps the bodies of the magi or priests alone were exposed at such expense; the common folk were covered with wax and laid in the earth, the wax saving the earth from pollution. In Rome and Greece the corpse was buried by night, lest it should pollute the sunlight; and a trough of water was set at the door of the house of death that men might purify themselves when they came out, before mixing in general society. Priests and magistrates in Rome might not meet or look on a corpse, for they were thereby rendered unclean and incapable of fulfilling their official duties without undergoing troublesome rites of purification. At a Roman funeral, when the remains had been laid in the tomb, all present were sprinkled with lustral water from a branch of olive or laurel called *aspergillum*; and when they had gone home they were asperged afresh and stepped over a fire. The house was also swept out with a broom, probably lest the ghost of the dead should be lying about the floor. Many races, to avoid pollution, destroy the house and property of the deceased. Thus the Navahos pull down the hut in which he died, leaving its ruins on the ground; but if it be an expensive hut, a shanty is extemporized alongside, into which the dying man is transferred before death. No one will use the timbers of a hut so ruined. A burial custom of the Solomon Islands, noted by R. H. Codrington (*The Melanesians*, p. 255), may be dictated by the same scruple. There "the mourners having hung up a dead man's arms on his house make great lamentations; all remains afterwards untouched, the house goes to ruin, mantled, as time goes on, with the vines of the growing yams, a picturesque and indeed, perhaps, a touching sight; for these things are not set up that they may in a ghostly manner accompany their former owner." H. Oldenberg (*Religion des Veda*, p. 426) describes how Hindus shave themselves and cut off their nails after a death, at the same time that they wash, renew the hearth fire, and furnish themselves with new vessels. For the hair and nails may harbour pollution, just as the medieval Greeks believed that evil spirits could lurk in a man's beard (Leo Allatius, *De opinionibus quorundam Græcorum*). The dead man's body is shorn and the nails cut for a kindred reason; for it must be purified as much as can be before it is burned as an offering on the pyre and before he enters on a new sphere of existence.

2. We are accustomed to regard mourning costume as primarily an outward sign of our grief. Originally, however, the special garb seems to have been intended to warn the general public that persons so attired were unclean. In ancient Rome mourners stayed at home and avoided all feasts and amusements; laying aside gold, purple and jewels, they wore black dresses called *lugubria* or even skins. They cut neither hair nor beard, nor lighted fire. Under the emperors women began to wear white. On the west coast of Africa negroes wear white, on the Gold Coast red. The Chinese wear hemp, which is cheap, for mourning dress must as a rule be destroyed when the season of grief is past to get rid of the taboo. Among the Aruntas of Australia the wives of a dead man smear themselves with white pipe-clay until the last ceremonies are finished, sometimes adding ashes—this not to conceal themselves from the ghost (which may partly be the aim of some mourning costumes), but to show the ghost that they are duly sorrowing for their loss. These widows must not talk except on their hands for a whole year. "Among the Maoris," says Frazer (*Golden Bough*, i. 323), "anyone who had handled a corpse, helped to convey it to the grave, or touched a dead man's bones, was cut off from all intercourse and almost all communication with mankind. He could not enter any house, or come into contact with any person or thing, without utterly bedevilling them. He might not even touch food with his hands, which had become so frightfully tabooed or unclean as to be quite useless. Food would be set for him on the ground,

and he would then sit or kneel down, and, with his hands carefully held behind his back, would gnaw at it as best he could." Often a degraded outcast was kept in a village to feed mourners. Such a taboo is strictly similar to those which surround a sacred chief or his property, a menstruous woman or a homicide, rendering them dangerous to themselves and to all who approach them.

3. Primitive folk cannot conceive of a man's soul surviving apart from his body, nor of another life as differing from this, and the dead must continue to enjoy what they had here. Accordingly the Patagonians kill horses at the grave that the dead may ride to *Alhucmapu*, or country of the dead. After a year they collect a chief's bones, arrange them, tie them together and dress them in his best garments with beads and feathers. Then they lay him with his weapons in a square pit, round which dead horses are placed set upright on their feet by stakes. As late as 1781 in Poland F. Casimir's horse was slain and buried with him. In the Caucasus a Christian lady's jewels are buried with her. The Hindus used to burn a man's widow on his pyre, because he could not do without her; and St Boniface commends the self-sacrifice of the Wend widows who in his day burned themselves alive on their husbands' pyres.

The tumuli met with all over the north of Europe (in the Orkneys alone 2000 remain) are regular houses of the dead, models of those they occupied in life. The greater the dignity of the deceased, the loftier was his barrow. Silbury hill is 170 ft. high; the tomb of Alyattes, father of Croesus, was a fourth of a league round; the Pyramids are still the largest buildings in existence; at Oberea in Tahiti is a barrow 267 ft. long, 87 wide and 44 high. Some Eskimo just leave a dead man's body in his house, and shut it up, often leaving by his side a dog's head to guide him on his last journey, along with his tools and kayak. The Sea Dyaks set a chief adrift in his war canoe with his weapons. So in Norse story Hake "was laid wounded on a ship with the dead men and arms; the ship was taken out to sea and set on fire." The Viking was regularly buried in his ship or boat under a great mound. He sailed after death to Valhalla. In the ship was laid a stone as anchor and the tools, clothes, weapons and treasures of the dead. The Egyptians, whose land was the gift of the river Nile, equally believed that the dead crossed over water, and fashioned the barge in the form of a boat. Hence perhaps was derived the Greek myth of Charon and the Styx, and the custom, which still survives in parts of Europe, of placing a coin in the mouth of the dead with which to pay the ferryman. The Egyptians placed in the tomb books of a kind to guide the dead to the next world. The Copts in a later age did the same, and to this custom we owe the recovery in Egypt of much ancient literature. The Armenians till lately buried with a priest his missal or gospel.

In Egyptian entombments of the XIIth to the XIVth dynasties were added above the sepulchres what Professor Petrie terms soul-houses, viz, small models of houses furnished with couch and table, &c., for the use of the *ka* or double whenever it might wish to come above ground and partake of meats and drinks. They recall, in point of size, the hut-urns of the Etruscans, but the latter had another use, for they contain incinerated remains. Etruscan tombs, like those of Egypt and Asia Minor, were made to resemble the dwelling-houses of the living, and furnished with coffered ceilings, panelled walls, couches, stools, easy chairs with footstools attached, all hewn out of the living rock (Dennis, *Cities and Cemeteries of Etruria*, vol. i. p. lxx.).

Of the old Peruvian mummies in the Kircherian Museum at Rome, several are of women with babies in their arms, whence it is evident that a mother had her suckling buried with her; it would console her in the next world and could hardly survive her in this. The practice of burying ornaments, tools and weapons with the dead characterizes the Inhumations of the Quaternary epoch, as if in that dim and remote age death was already regarded as the portal of another life closely resembling this. The cups, tools, weapons, ornaments and other articles deposited with the dead are often carefully broken or turned upside down and inside out; for the soul or *manes* of objects is liberated by such fracture or inversion and so passes into the

dead man's use and possession. For the same reason where the dead are burned, their properties are committed to the flames. The ghost of the warrior has a ghostly sword and buckler to fight with and a ghostly cup to drink from, and he is also nourished by the impalpable odour and reek of the animal victims sacrificed over his grave. Instead of valuable objects cheap images and models are often substituted; and why not, if the mere ghosts of the things are all that the wraith can enjoy? Thus Marco Polo (ii. 76) describes how in the land of Kinsay (Hang-chau) "the friends and relations make a great mourning for the deceased, and clothe themselves in hempen garments, and follow the corpse, playing on a variety of instruments and singing hymns to their idols. And when they come to the burning place they take representations of things cut out of parchment, such as caparisoned horses, male and female slaves, camels, armour, suits of cloth of gold (and money), in great quantities, and these things they put on the fire along with the corpse so that they are all burned with it. And they tell you that the dead man shall have all these slaves and animals of which the effigies are burned, alive in flesh and blood, and the money in gold, at his disposal in the next world; and that the instruments which they have caused to be played at his funeral, and the idol hymns that have been chaunted shall also be produced again to welcome him in the next world." The manufacture of such paper *simulacra* for consumption at funerals is still an important industry in Chinese cities. The ancient Egyptians, assured that a man's ka or double shall revivify his body, took pains to guard the flesh from corruption, steeping the corpse in natron and stuffing it with spices. A body so prepared is called a mummy (*g.v.*), and the custom was already of a hoary antiquity in 3200 B.C., when the oldest dated mummy we have was made. The bowels, removed in the process, were placed in jars over the corpse in the tomb, together with writing tablets, books, musical instruments, &c., of the dead. Cemeteries also remain full of mummies of crocodiles, cats, fish, cows and other sacred animals. The Greeks settled in Egypt learned to mummify their dead, but the custom was abhorrent to the Jews, although the Christian belief in the resurrection of the flesh must have been formed to a large extent under Egyptian influence. Half the superiority of the Jewish to other ancient religions lay in this, that it prescribed no funeral rites other than the simplest inhumation.

The dead all over the world and from remote antiquity have been laid not anyhow in the earth, but with the feet and face towards the region in which their future will be spent; the Samoans and Fijians towards the far west whither their souls have preceded them; the Guarayos with head turned eastwards because their god Tamoi has in that quarter "his happy hunting grounds where the dead will meet again" (Tylor, *Prim. Cult.* ii. 422). The legend is that Christ was buried with His head to the west, and the church follows the custom, more ancient than itself, of laying the dead looking to the East, because that is the attitude of prayer, and because at the last trump they will hurry eastwards. So in Eusebius (*Hist. Ecd.* 430. 10) a martyr explains to his pagan judge that the heavenly Jerusalem, the fatherland of the pious, lay exactly in the east at the rising place of the sun. Where the body is laid out straight it is difficult to discern the presence of any other idea than that it is at rest. In Scandinavian barrows, e.g. in the one opened at Goldhavn in 1830, the skeletons have been found seated on a low stone bench round the wall of the grave chamber facing its opening, which always looks south or east, never north. Here the dead were continuing the drinking bouts they enjoyed on earth.

The Peruvians mummified their dead and placed them jointed and huddled up with knees to chin, looking toward the sunset, with the hands held before the face. In the oldest prehistoric tombs along the Nile the bodies are doubled up in the same position. It would seem as if in these and numerous other similar cases the dead were deliberately given in their graves the attitude of a foetus in the womb, and, as Dr Budge remarks (*Egyptian Ideas of the Future Life*, London, 1899, p. 162), "we may perhaps be justified in seeing in this custom the symbol of a hope that, as the child is born from this position into the

world, so might the deceased be born into the life beyond the grave." The late Quaternary skeletons of the Mentone cave were laid in a layer of ferruginous earth specially laid down for them, and have contracted a red colour therefrom. Many other prehistoric skeletons found in Italy have a reddish colour, perhaps for the same reason, or because, as often to-day, the bones were stripped of flesh and painted. Ambrose relates that the skeletons of the martyrs Gervasius and Protasius, which he found and deposited A.D. 386 under the altar of his new basilica in Milan, were *mirae magnitudinis ut prisca actas ferebat*, and were also coloured red. He imagined the red to be the remains of the martyrs' blood! *Hic sanguis clamat coloris indicio*. Salomon Reinach has rightly divined that what Ambrose really hit upon was a prehistoric tomb. Red earth was probably chosen as a medium in which to lay a corpse because demons flee from red. Sacred trees and stones are painted red, and for the most solemn of their rites savages bedaub themselves with red clay. It is a favourite taboo colour.

4. A feast is an essential feature of every primitive funeral, and in the Irish "wake" it still survives. A dead man's soul or double has to be fed at the tomb itself, perhaps to keep it from prowling about the homes of the survivors in search of victuals; and such food must also be supplied to the dead at stated intervals for months or years. Many races leave a narrow passage or tube open down to the cavity in which the corpse lies, and through it pour down drinks for the dead. Traces of such tubes are visible in the prehistoric tombs of the British Isles. However, such provision of food is not properly a funeral feast unless the survivors participate. In the Eastern churches and in Russia the departed are thus fed on the ninth, twelfth and fortieth days from death. "Ye appease the shades of the dead with wine and meals," was the charge levelled at the Catholics by the 4th-century Manichaeans, and it has hardly ceased to be true even now after the lapse of sixteen centuries. The funeral feast proper, however, is either a meal of communion with or in the dead, which accompanies interment, or a banquet off the flesh of victims slain in atonement of the dead man's sins. Some anthropologists see in the common meal held at the grave "the pledge and witness of the unity of the kin, the chief means, if not of making, at least of repairing and renewing it."¹ The flesh provided at these banquets is occasionally that of the dead man himself; Herodotus and Strabo in antiquity relate this of several half-civilized races in the East and West, and a similar story is told by Marco Polo of certain Tatars. Nor among modern savages are funeral feasts off the flesh of the dead unknown, and they seem to be intended to effect and renew a sacramental union or kinship of the living with the dead. The Uaupes in the Amazons incinerate a corpse a month after death, pound up the ashes, and mix them with their fermented drink. They believe that the virtues of the dead will thus be passed on to his survivors. The life of the tribe is kept inside the tribe and not lost. Such cannibal sacraments, however, are rare, and, except in a very few cases, the evidence for them weak. The slaying and eating of animal victims, however, at the tomb is universal and bears several meanings, separately or all at once. The animals may be slain in order that their ghosts may accompany the deceased in his new life. This significance we have already dwelt upon. Or it is believed that the shade feeds upon them, as the shades came up from Hades and lapped up out of a trench the blood of the animals slain by Ulysses. The survivors by eating the flesh of a victim, whose blood and soul the dead thus consume, sacramentally confirm the mystic tie of blood kinship with the dead. Or lastly, the victim may be offered for the sins of the dead. His sins are even supposed to be transferred into it and eaten by the priest. Such expiatory sacrifices of animals for the dead survive in the Christian churches of Armenia, Syria and of the East generally. Their vicarious character is emphasized in the prayers which accompany them, but the popular understanding of them probably combines all the meanings above enumerated. It has been suggested by Robertson Smith (*Religion of the Semites*, 336) that the world-wide customs of

¹ E. S. Hartland, *Legend of Persens* (1895), ii. 278.

tearing the hair, rending the garments, and cutting and wounding the body were originally intended to establish a life-bond between the dead and the living. The survivors, he argues, in leaving portions of their hair and garments, and yet more by causing their own blood to stream over the corpse from self-inflicted wounds, by cutting off a finger and throwing it into the grave, leave what is eminently their own with the dead, so drawing closer their tie with him. Conversely, many savages daub themselves with the blood and other effluences of their dead kinsmen, and explain their custom by saying that in this way a portion of the dead is incorporated in themselves. Often the survivors, especially the widows, attach the bones or part of them to their persons and wear them, or at least keep them in their houses. The retention of the locks of the deceased and of parts of his dress is equally common. There is also another side to such customs. Having in their possession bits of the dead, and being so far in communion with him, the survivors are surer of his friendship. They have ensured themselves against ghosts who are apt to be by nature envious and mischievous. But whatever their original significance, the tearing of checks and hair and garments and cutting with knives are mostly expressions of real sorrow, and, as Robertson Smith remarks, of deprecation and supplication to an angry god or spirit. It must not be supposed that the savage or ancient man feels less than ourselves the poignancy of loss.

6. Death-witchery has close parallels in the witch and heretic hunts of the Christians, but, happily for us, only flourishes to-day among savages. Sixty % of the deaths which occur in West Africa are, according to Miss Mary Kingsley—a credible witness—believed to be due to witchcraft and sorcery. The blacks regard old age or effusion of blood as the sole legitimate causes of death. All ordinary diseases are in their opinion due to private magic on the part of neighbours, just as a widespread epidemic marks the active hatred "of some great outraged nature spirit, not of a mere human dabbler in devils."¹ Similarly in Christian countries an epidemic is set down to the wrath of a God offended by the presence of Jews, Arians and other heretics. The duty of an African witch-doctor is to find out who bewitched the deceased, just as it was of an inquisitor to discover the heretic. Every African post-mortem accordingly involves the murder of the person or persons who bewitched the dead man and caused him to die. The death-rate by these means is nearly doubled; but, since the use of poison against an obnoxious neighbour is common, the right person is occasionally executed. It is also well for neighbours not to quarrel, for, if they do and one of them dies of smallpox, the other is likely to be slain as a witch, and his lungs, liver and spleen impaled on a pole at the entrance of the village. It is the same case with the Australian blacks: "no such thing as natural death is realized by the native; a man who dies has of necessity been killed by some other man, or perhaps even by a woman, and sooner or later that man or woman will be attacked. In the normal condition of the tribe every death meant the killing of another individual."²

7. Lastly, a primitive interment guards against the double risk of the ghost haunting the living and of ghouls or vampires taking possession of the corpse. The latter end is likely to be achieved if the body is cremated, for then there is no nidus to harbour the demon; but whether, in the remote antiquity to which belong many barrows containing incinerated remains, this motive worked, cannot be ascertained. The Indo-European race seems to have cremated at an early epoch, perhaps before the several races of East and West separated. In Christian funeral rites many prayers are for the protection of the body from violation by vampires, and it would seem as if such a motive dictated the architectural solidity of some ancient tombs. Christian graves were for protection regularly sealed with the cross; and the following is a characteristic prayer from the old Armenian rite for the burial of a layman:

"Preserve, Almighty Lord, this man's spirit with all saints and with all lovers of Thy holy name. And do Thou seal and guard the sepulchre of Thy servant, Thou who shuttest up the depths and sealest them with Thy almighty right hand . . . so let the seal of Thy Lordship abide unmoved upon this man's dwelling-place and upon the shrine which guards Thy servant. And let not any filthy and unclean devil dare to approach him, such as assail the body and souls of the heathen, who possess not the birth of the holy font, and have not the dread seal laid upon their graves."

A terrible and revolting picture of the superstitious belief in ghouls which violate Christian tombs is given by Leo Allatius (who held it) in his tract *De opinionibus quorundam Graecorum* (Paris, 1646). It was probably the fear of such demonic assaults on the dead that inspired the insanitary custom of burying the dead under the floors of churches, and as near as possible to the altar. In the Greek Church this practice was happily forbidden by the code of Justinian as well as by the older law in the case of churches consecrated with *Encaenia* and deposition of relics. In the Armenian Church the same rule holds, and Ephrem Syrus in his testament particularly forbade his body to be laid within a church. Such prohibitions, however, are a witness to the tendency in question.

The custom of lighting candles round a dead body and watching at its side all night was originally due to the belief that a corpse, like a person asleep, is specially liable to the assaults of demons. The practice of tolling a bell at death must have had a similar origin, for it was a common medieval belief that the sound of a consecrated bell drives off the demons which when a man dies gather near in the air to waylay his fleeing soul. For a like reason the consecrated bread of the Eucharist was often buried with believers, and St Basil is said to have specially consecrated a Host to be placed in his coffin.

8. Some of the rites described under the previous heads may be really inspired by the fear of the dead haunting the living, but it must be kept in mind that the taboo attaching to a dead body is one thing and fear of a ghost another. A corpse is buried or burned, or scaffolded on a tree, a tower or a house-top, in order to get it out of the way and shield society from the dangerous infection of its taboo; but ghosts *quæ* ghosts need not be feared and a kinsman's ghost usually is not. On the contrary, it is fed and consoled with everything it needs, is asked not to go away but to stay, is in a thousand ways assured of the sorrow and sympathy of the survivors. Even if the body be eaten, it is merely to keep the soul of the deceased inside the circle of kinsmen, and Strabo asserts that the ancient Irish and Massagetæ regarded it as a high honour to be so consumed by relatives. In Santa Cruz in Melanesia they keep the bones for arrow heads and store a skull in a box and set food before it "saying that this is the man himself" (R. H. Codrington, *The Melanesians*, p. 264), or the skull and jaw bone are kept and "are called *uangite*, which are *saka*, hot with spiritual power, and by means of which the help of the *lio'o*, the powerful ghost of the man whose relics these are, can be obtained" (*ibid.* p. 262). Here we have the savage analogue to Christian relics. So the Australian natives make pointing sticks out of the small bones of the arm, with which to bewitch enemies.

We may conclude then that in the most primitive societies, where blood-kinship is the only social tie and root of social custom it is the shades, not of kinsmen, but of strangers, who as such are enemies, that are dangerous and uncanny. In more developed societies, however, all ghosts alike are held to be so; and if a ghost walks it is because its body has not been properly interred or because its owner was a malefactor. Still, even allowing for this, it remains true that for a friendly ghost the proper place is the grave and not the homes of the living, and accordingly the Aruntas with cries of *Wah! Wah!* with wearing of fantastic head-dresses, wild dancing and beating of the air with hands and weapons "drive the spirit away from the old camp which it is supposed to haunt," and which has been set fire to, and hunt it at a run into the grave prepared, and there stamp it down into the earth. "The loud shouting of the men and women shows him that they do not wish to be frightened by him in his present state, and that they will be angry with him if he does not rest."

¹ Mary Kingsley, *West African Studies* (1901), p. 178.

² B. Spencer and F. J. Gillen, *The Native Tribes of Central Australia* (1899), p. 48.

(Spencer and Gillen, *Native Tribes of Central Australia*, p. 508). In Mesopotamia cemeteries have been discovered where the sepulchral jars were set upside down, clearly by way of hindering the ghosts from escaping into the upper world. In the Dublin museum we see specimens of ancient Celtic tombs showing the same peculiarity. For a like reason perhaps the name of the dead must among the Aruntas not be uttered, nor the grave approached, by certain classes of kinsmen. The same repugnance to naming the dead exists all over the world, and leads survivors who share the dead man's name to adopt another, at least for a time. If the dead man's name was that of a plant, tree, animal or stream, that too is changed. Here is a potent cause of linguistic change, that also renders any historical tradition impossible. The survivors seem to fear that the ghost will come when he hears his name called; but it also hangs together with the taboo which hedges round the dead as it does kings, chieftains and priests.

AUTHORITIES.—B. Spencer and F. J. Gillen, *The Native Tribes of Central Australia* (London, 1899); F. B. Jevons, *Introduction to History of Religion* (London, 1896); E. S. Hartland, *The Legend of Perseus*, vol. ii.; J. G. Frazer, *The Golden Bough* (London, 1900); L. W. Faraday, "Custom and Belief in the Icelandic Sagas," in *Folk-lore*, vol. xvii. No. 4; E. B. Tylor, *Primitive Culture* (London, 1903); E. A. W. Budge, *The Mummy* (Cambridge, 1893); C. Royer, "Les Rites funéraires aux époques préhistoriques," *Revue d'anthropologie* (1876); Forrer, *Über die Totenbestattung bei den Pfahlbauern* (Australand, 1885); J. Lubbock, *Origin of Civilization* (London, 1875) and *Prehistoric Times* (London, 1865); L. A. Muratori, "De antiquis Christianorum sepulchris," *Anecd. Græca* (Fadua, 1709); Onaphr. Fanvinius, *De ritu sepeliendi mortuos apud veteres Christianos*, reprinted in *Volbeding's Thesaurus* (Leipzig, 1841). (F. C. C.)

FUNGI (pl. of Lat. *fungus*, a mushroom), the botanical name covering in the broad sense all the lower cellular Cryptogams devoid of chlorophyll, which arise from spores, and the thallus of which is either unicellular or composed of branched or unbranched tubes or cell-filaments (hyphae) with apical growth, or of more or less complex webbed sheets or tissue-like masses of such (mycelium). The latter may in certain cases attain large dimensions, and even undergo cell-divisions in their interior, resulting in the development of true tissues. The spores, which may be uni- or multi-cellular, are either abstracted free from the ends of hyphae (acrogenous), or formed from segments in their course (*chlamydospores*) or from protoplasm in their interior (endogenous). The want of chlorophyll restricts their mode of life—which is rarely aquatic—since they are therefore unable to decompose the carbon dioxide of the atmosphere, and renders them dependent on other plants or (rarely) animals for their carbonaceous food-materials. These they obtain usually in the form of carbohydrates from the dead remains of other organisms, or in this or other forms from the living cells of their hosts; in the former case they are termed saprophytes, in the latter parasites. While some moulds (*Penicillium*, *Aspergillus*) can utilize almost any organic food-materials, other fungi are more restricted in their choice—e.g. insect-parasites, horn- and feather-destroying fungi and parasites generally. It was formerly the custom to include with the Fungi the Schizomycetes or Bacteria, and the Myxomycetes or Mycetozoa; but the peculiar mode of growth and division, the cilia, spores and other peculiarities of the former, and the emission of naked amoeboid masses of protoplasm, which creep and fuse to streaming plasmodia, with special modes of nutrition and spore-formation of the latter, have led to their separation as groups of organisms independent of the true Fungi. On the other hand, lichens, previously regarded as autonomous plants, are now known to be dual organisms—fungi symbiotic with algae.

The number of species in 1889 was estimated by Saccardo at about 32,000, but of these 8500 were so-called *Fungi imperfecti*—i.e. forms of which we only know certain stages, such as conidia, pycnidia, &c., and which there are reasons for regarding as merely the corresponding stages of higher forms. Saccardo also included about 400 species of Myxomycetes and 650 of Schizomycetes. Allowing for these and for the cases, undoubtedly not few, where one and the same fungus has been described under different names, we obtain Schroeter's estimate (in 1892) of 20,000 species.

In illustration of the very different estimates that have been made, however, may be mentioned that of De Bary in 1872 of 150,000 species, and that of Cooke in 1895 of 40,000, and Massee in 1899 of over 50,000 species, the fact being that no sufficient data are as yet to hand for any accurate census. As regards their geographical distribution, fungi, like flowering plants, have no doubt their centres of origin and of dispersal; but we must not forget that every exchange of wood, wheat, fruits, plants, animals, or other commodities involves transmission of fungi from one country to another; while the migrations of birds and other animals, currents of air and water, and so forth, are particularly efficacious in transmitting these minute organisms. Against this, of course, it may be argued that parasitic forms can only go where their hosts grow, as is proved to be the case by records concerning the introduction of *Puccinia malvacearum*, *Peronospora viticola*, *Hemileia vastatrix*, &c. Some fungi—e.g. moulds and yeasts—appear to be distributed all over the earth. That the north temperate regions appear richest in fungi may be due only to the fact that North America and Europe have been much more thoroughly investigated than other countries; it is certain that the tropics are the home of very numerous species. Again, the accuracy of the statement that the fleshy Agaricini, Polyporei, *Psizae*, &c., are relatively rarer in the tropics may depend on the fact that they are more difficult to collect and remit for identification than the abundantly recorded woody and coriaceous forms of these regions. When we remember that many parts of the world are practically unexplored as regards fungi, and that new species are constantly being discovered in the United States, Australia and northern Europe—the best explored of all—it is clear that no very accurate census of fungi can as yet be made, and no generalizations of value as to their geographical distribution are possible.

The existence of fossil fungi is undoubted, though very few of the identifications can be relied on as regards species or genera. They extend back beyond the Carboniferous, where they occur as hyphae, &c., preserved in the fossil woods, but the best specimens are probably those in amber and in siliceous petrifications of more recent origin.

Organs.—Individual hyphae or their branches often exhibit specializations of form. In many Basidiomycetes minute branches arise below the septa; their tips curve over the outside of the latter, and fuse with the cell above just beyond it, forming a *clamp-connection*. Many parasitic hyphae put out minute lateral branches, which pierce the cell-wall of the host and form a peg-like (*Trichosphaeria*), sessile (*Cystopus*), or stalked (*Hemileia*), knot-like, or a

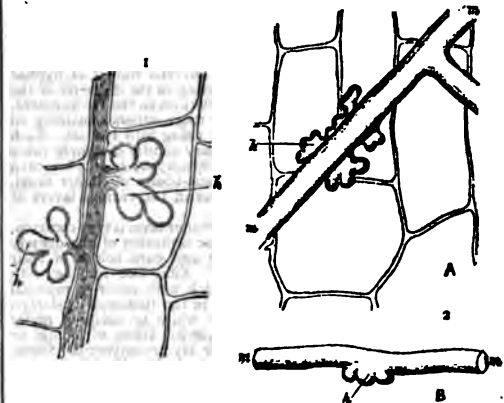

FIG. 1.—1. *Peronospora parasitica* (De Bary). Mycelium with haustoria (h); 2. *Erysiphe*; A and B, mycelium (m), with haustoria (h). (After De Bary.)

more or less branched (*Peronospora*) or coiled (*Protomyces*) haustorium. In *Rhizopus* certain hyphae creep horizontally on the surface of the substratum, and then anchor their tips to it by means of a tuft of short branches (*oppressorium*), the walls of which soften and gus

themselves to it, then another branch shoots out from the tuft and repeats the process, like a strawberry-runner. Appressoria are also formed by some parasitic fungi, as a minute flattening of the tip of a very short branch (*Erysiphe*), or the swollen end of any hypha which comes in contact with the surface of the host (*Piptocephalis*, *Synecephalis*), haustoria piercing in each case the cell-wall below. In *Botrytis* the appressoria assume the form of dense tassels of short branches. In *Atrichobotrys* side-branches of the mycelium sling themselves around the host (*Tylenchus*) much as tendrils round a support.

Many fungi (*Phallus*, *Agaricus*, *Fumago*, &c.) when strongly growing put out ribbon-like or cylindrical cords, or sheet-like mycelial plates of numerous parallel hyphae, all growing together equally, and fusing by anastomoses, and in this way extend long distances in the soil, or over the surfaces of leaves, branches, &c. These mycelial strands may be white and tender, or the outer hyphae may be hard and black, and very often the resemblance of the subterranean forms to a root is so marked that they are termed rhizomorphs. The outermost hyphae may even put forth thinner hyphae, radiating into the soil like root-hairs, and the convergent tips may be closely appressed and so divided by septa as to resemble the root-apex of a higher plant (*Armillaria mellea*).

Sclerotia.—Fungi, like other plants, are often found to store up large quantities of reserve materials (oil, glycogen, carbohydrates, &c.) in special parts of their vegetative tissues, where they lie accumulated between a period of active assimilation and one of renewed activity, forming reserves to be consumed particularly during the formation of large fructifications. These reserve stores may be packed away in single hyphae or in swollen cells, but the hyphae containing them are often gathered into thick cords or mycelial strands (*Phallus*, mushroom, &c.), or flattened and anastomosing ribbons and plates, often containing several kinds of hyphae (*Merulius lacrymans*). In other cases the strands undergo differentiation into an outer layer with blackened, hardened cell-walls and a core of ordinary hyphae, and are then termed rhizomorphs (*Armillaria mellea*), capable not only of extending the fungus in the soil, like roots, but also of lying dormant, protected by the outer casing. Such aggregations of hyphae frequently become knotted up into dense masses of interwoven and closely packed hyphae, varying in size from that of a pin's head or a pea (*Peziza Coprinus*) to that of a man's fist or head, and weighing 10 to 25 lb or more (*Polyporus Mytilus*, *P. tumulosus*, *Lentinus Woermanni*, *P. Sapurena*, &c.). The interwoven hyphae fuse and branch copiously, filling up all interstices. They also undergo cutting up by numerous septa into short cells, and these often divide again in all planes, so that a pseudoparenchyma results, the walls of which may be thickened and swollen internally, or hardened and black on the exterior. In many cases the swollen cell-walls serve as reserves, and sometimes the substance is so thickly deposited in strata as to obliterate the lumen, and the hyphae become nodular (*Polyporus sacer*, *P. rhinoceros*, *Lentinus Woermanni*). The various sclerotia, if kept moist, give rise to the fructifications of the fungus concerned, much as a potato tuber does to a potato plant, and in the same way the reserve materials are consumed. They are principally Polyperi, Agarici, Pezizae; none are known among the Phycomyces, Uredineae or Ustilagineae. The functions of mycelial strands, rhizomorphs and sclerotia are not only to collect and store materials, but also to extend the fungus, and in many cases similar strands act as organs of attack. The same functions of storage in advance of fructification are also exercised by the stromata so common in Ascomycetes.

Tissue Differentiations.—The simpler mycelia consist of hyphae all alike and thin-walled, or merely differing in the diameter of the branches of various orders, or in their relations to the environment, some plunging into the substratum like roots, others remaining on its surface, and others (aerial hyphae) rising into the air. Such hyphae may be multicellular, or they may consist of simple tubes with numerous nuclei and no septa (*Phycomyces*), and are then non-cellular. In the more complex tissue-bodies of higher fungi, however, we find considerable differences in the various layers or strands of hyphae.

An epidermis-like or cortical protective outer layer is very common, and is usually characterized by the close septation of the densely interwoven hyphae and the thickening and dark colour of their outer walls (sclerotia, *Xylaria*, &c.). Fibre-like hyphae with the lumen almost obliterated by the thick walls occur in mycelial cords (*Merulius*). Latex-tubes abound in the tissues of *Lactarius*, *Stereum*, *Mycena*, *Fistulina*, filled with white or coloured milky fluids, and Istvanffy has shown that similar tubes with fluid or oily contents are widely spread in other Hymenomycetes. Sometimes fatty oil or watery sap is found in swollen hyphal ends, or such tubes contain coloured sap. Cystidia and paraphyses may be also classed here. In *Merulius lacrymans* Hartig has observed thin-walled hyphae with large lumina, the septa of which are perforated like those of sieve-tubes.

As regards its composition, the cell-wall of fungi exhibits variations of the same kind as those met with in higher plants. While the fundamental constituent is a cellulose in many Mucorini and other Phycomyces, in others bodies like pectose, callose, &c., commonly occur, and Wesselingh's researches show that chitin, a

gluco-proteid common in animals, forms the main constituent in many cases, and is probably deposited directly as such, though, like the other substances, it may be mixed with cellulose. As in other cell-walls, so here the older membranes may be altered by deposits of various substances, such as resin, calcium oxalate, colouring matters; or more profoundly altered throughout, or in definite layers, by lignification, suberization (*Trametes*, *Daedalea*), or swelling to a gelatinous mucilage (*Tramella*, *Gymnosporangium*), while cutinization of the outer layers is common. One of the most striking alterations of cell-walls is that termed *carbonization*, in which the substance gradually turns black, hard and brittle, as if charred—e.g. *Xylaria*, *Ustilina*, some sclerotia. At the other extreme the cell-walls of many lichen-fungi are soft and colourless, but turn blue in iodine, as does starch. The young cell-wall is always tenuous and flexible, and may remain so throughout, but in many cases thickenings and structural differentiations, as well as the changes referred to above, alter the primary wall considerably. Such thickening may be localized, and pits (e.g. *Uredosporium*, septa of Basidiomycetes), spirals, reticulations, rings, &c. (capillitium fibres of *Podaxon*, *Calostoma*, *Battarrae*), occur as in the vessels of higher plants, while sclerotized networks, pittings and so forth are as common on fungus-spores as they are on pollen grains.

Cell-Contents.—The cells of fungi, in addition to protoplasm, nuclei and sap-vacuoles, like other vegetable cells, contain formed and amorphous bodies of various kinds. Among those directly visible to the microscope are oil drops, often coloured (*Uredineae*) crystals of calcium oxalate (*Phallus*, *Russula*), proteid crystals (*Mucor*, *Pilobolus*, &c.) and resin (Polyperi). The oidia of *Erysipheae* contain fibrous bodies and the hyphae of *Saprolegniae* cellulose bodies, but starch apparently never occurs. Invisible to the microscope, but rendered visible by reagents, are glycogen, *Mucor*, Ascomycetes, yeast, &c. In addition to these cell-contents we have good indirect evidence of the existence of large series of other bodies, such as proteids, carbohydrates, organic acids, alkaloids, enzymes, &c. These must not be confounded with the numerous substances obtained by chemical analysis of masses of the fungus, though we may conclude with a good show of probability that some of them also exist preformed in the living cell. Such are sugars (glucose, mannite, &c.), acids (acetic, citric and a whole series of lichen-acids), ethereal oils and resinous bodies, often combined with the intense colours of fungi and lichens, and a number of powerful alkaloid poisons, such as muscarin (*Amanita*), ergotin (*Claviceps*), &c.

Among the enzymes already extracted from fungi are *invertases* (yeasts, moulds, &c.), which split cane-sugar and other complex sugars with hydrolysis into simpler sugars such as dextrose and levulose; *diastases*, which convert starches into sugars (*Aspergillus*, &c.); *cytases*, which dissolve cellulose similarly (*Botrytis*, &c.); *peptases*, using the term as a general one for all enzymes which convert proteids into peptones and other bodies (*Penicillium*, &c.); *lipases*, which break up fatty oils (*Empusa*, *Phycomyces*, &c.); *oxydases*, which bring about the oxidations and changes of colour observed in *Boletus*, and *zymase*, extracted by Buchner from yeast, which brings about the conversion of sugar into alcohol and carbon dioxide. That such enzymes are formed in the protoplasm is evident from the behaviour of hyphae, which have been observed to pierce cell-membranes, the chitinous coats of insects, artificial collodion films and layers of wax, &c. That a fungus can secrete more than one enzyme, according to the materials its hyphae have to attack, has been shown by the extraction of diastase, inulase, trehalase, invertase, maltase, raffinase, malizitase, emulsin, trypsin and lipase from *Aspergillus* by Bourquelot, and similar events occur in other fungi. The same fact is indicated by the wide range of organic substances which can be utilized by *Penicillium* and other moulds, and by the behaviour of parasitic fungi which destroy various cell-contents and tissues. Many of the coloured pigments of fungi are fixed in the cell-walls or excreted to the outside (*Peziza aeruginosa*). Matruchot has used them for staining the living protoplasm of other fungi by growing the two together. Striking instances of coloured mycelia are afforded by *Corticium sanguineum*, blood-red; *Elaphomyces Levillei*, yellow-green; *Chlorosplenium aeruginosum*, verdigris green; and the *Demati*, brown or black.

Nuclei.—Although many fungi have been regarded as devoid of nuclei, and all have not as yet been proved to contain them, the numerous investigations of recent years have revealed them in the cells of all forms thoroughly examined, and we are justified in concluding that the nucleus is as essential to the cell of a fungus as to that of other organisms. The hyphae of many contain numerous, even hundreds of nuclei (Phycomyces); those of others have several (*Aspergillus*) in each segment, or only two (*Exoascus*) or one (*Erysiphe*) in each cell. Even the isolated cells of the yeast plant have each one nucleus. As a rule the nuclei of the mycelium are very minute (1.5–2 μ in *Phycomyces*), but those of many asci and spores are large and easily rendered visible. As with other plants, so in fungi the essential process of fertilization consists in the fusion of two nuclei, but owing to the absence of well-marked sexual organs from many fungi, a peculiar interest attaches to certain nuclear fusions in the vegetative cells or in young spores of many forms. Thus in Ustilagineae the chlamydozoospores, and in Uredineae

the teleutospores, each contain two nuclei when young, which fuse as the spores mature. In young asci a similar fusion of two nuclei occurs, and also in basidia, in each case the nucleus of the ascus or of the basidium resulting from the fusion subsequently giving rise by division to the nuclei of the ascospores and basidiospores respectively. The significance of these fusions will be discussed under the various groups. Nuclear division is usually accompanied by all the essential features of karyokinesis.

Spores.—No agreement has ever been arrived at regarding the consistent use of the term spore. This is apparently owing to the facts that too much has been attempted in the definition, and that differences arise according as we aim at a morphological or a physiological definition. Physiologically, any cell or group of cells separated off from a hypha or unicellular fungus and capable of itself growing out—germinating—to reproduce the fungus, is a spore; but it is evident that so wide a definition does not exclude the ordinary vegetative cells of sprouting fungi, such as yeasts, or small sclerotium like cell-aggregates of forms like *Corticium*. Morphologically considered, spores are marked by peculiarities of form, size, colour, place of origin, definiteness in number, mode of preparation, and so forth, such that they can be distinguished more or less sharply from the hyphae which produce them. The only physiological peculiarity exhibited in common by all spores is that they germinate and initiate the production of a new fungus-plant. Whether a spore results from the sexual union of two similar gametes (zygospore) or from the fertilization of an egg-cell by the protoplasm of a male organ (oospore); or is developed asexually as a motile (zoospore) or a quiescent body cut off from a hypha (conidium) or developed along its course (oidium or chlamydospore), or in its protoplasm (endospore), are matters of importance which have their uses in the classification and terminology of spores, though in many respects they are largely of academic interest.

Klebs has attempted to divide spores into three categories as follows: (1) kinospores, arising by relatively simple cell-divisions and subserving rapid dissemination and propagation, e.g. zoospores, conidia, endogonia, stylospores, &c.; (2) paulospores, due to simple rearrangement of cell-contents, and subserving the persistence of the fungus through periods of exigency, e.g. gemmae, chlamydospores, resting-cells, cysts, &c.; (3) carpospores, produced by a more or less complex formative process, often in special fructifications, and subserving either or both multiplication and persistence, e.g. zygospores, oospores, brand-spores, acidiospores, ascospores, basidiospores, &c. Little or nothing is gained by these definitions, however, which are especially physiological. In practice these various kinds of spores of fungi receive further special names in the separate groups, and names, moreover, which will appear, to those unacquainted with the history, to have been given without any consistency or regard to general principles; nevertheless, for ordinary purposes these names are far more useful in most cases, owing to their descriptive character, than the proposed new names, which have been only partially accepted.

Sporephores.—In some of the simpler fungi the spores are not borne on or in hyphae which can be distinguished from the vegetative parts or mycelium, but in the vast majority of cases the spore-bearing hyphae either ascend free into the air or radiate into the surrounding water as distinct branches, or are grouped into special columns, cushions, layers or complex masses obviously different in colour, consistency, shape and other characters from the parts which gather up and assimilate the food-materials. The term "receptacle" sometimes applied to these spore-bearing hyphae is better replaced by sporephore. The sporephore is obsolete when the spore-bearing hyphae are not sharply distinct from the mycelium, simple when the constituent hyphae are isolated, and compound when the latter are conjoined.

FIG. 2.—*Peronospora parasitica* (De Bary). Conidiophore with conidia.

The chief distinctive characters of the spore-bearing hyphae are their orientation, usually vertical; their limited apical growth; their peculiar branching, form, colour, contents, consistency; and their spore-production. According to the characters of the last, we might theoretically divide them into conidiophores, sporangio-phores, gametophores, oidiophores, &c.; but since the two latter rarely occur, and more than one kind of spore or spore-case may occur on a sporephore, it is impossible to carry such a scheme fully into practice.

A simple sporephore may be merely a single short hypha, the end of which stops growing and becomes cut off as a conidium by the formation of a septum, which then splits and allows the conidium to fall. More generally the hypha below the septum grows forwards again, and repeats this process several times before the terminal conidium falls, and so a chain of conidia results, the oldest of which terminates the series (*Erysiphe*); when the primary branch has thus formed a basipetal series, branches may arise from below and again repeat this process, thus forming a tuft (*Penicillium*). Or the primary hypha may first swell at its apex, and put forth a series of short peg-like branches (*sterigmata*) from the increased surface thus provided, each of which develops a similar basipetal chain of conidia (*Aspergillus*), and various combinations of these processes result in the development of numerous varieties of exquisitely branched sporephores of this type (*Botrytis*, *Botryosporium*, *Verticillium*, &c.).

A second type is developed as follows: the primary hypha forms a septum below its apex as before, and the terminal conidium, thus abstricted, puts out a branch at its apex, which starts as a mere point and rapidly swells to a second conidium; this repeats the process, and so on, so that we now have a chain of conidia developed in acropetal succession, the oldest being below, and, as in *Penicillium*, &c., branches put forth lower down may repeat the process (*Hormodendron*). In all these cases we may speak of simple conidiophores. The simple sporephore does not necessarily terminate in conidia, however. In *Mucor*, for example, the end of the primary hypha swells into a spheroidal head (sporangium), the protoplasm of which

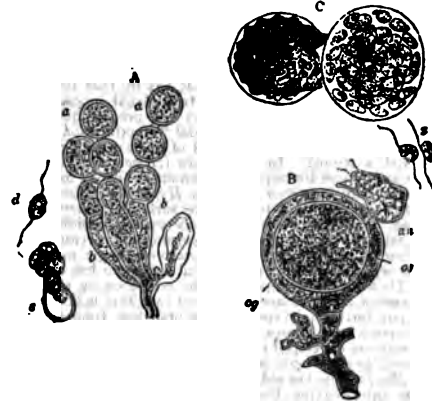

FIG. 3.—*Cystopus candidus*.

- A, a, Conidia.
- b, Conidiophores.
- c, Conidium emitting zoospores.
- d, Free zoospore.
- B, og, Oogonium.
- os, Oosphere.
- an, Antheridium.
- C, Formation of zoospores by oospores.
- s, Free zoospores. (After De Bary.)

undergoes segmentation into more or less numerous globular masses, each of which secretes an enveloping cell-wall and becomes a spore (endospore), and branched systems of sporangia may arise as before (*Thamnidium*). Such may be termed sporangiophores. In *Sporidinia* the branches give rise also to short branches, which meet and fuse their contents to form zygospores. In *Peronospora*, *Saprolegnia*, &c., the ends of the branches swell up into sporangia, which develop zoospores in their interior (zoosporangia), or their contents become oospheres, which may be fertilized by the contents of other branches (antheridia) and so form egg-cases (oogonia). Since in such cases the sporephore bears sexual cells, they may be conveniently termed gametophores.

Compound sporephores arise when any of the branched or unbranched types of spore-bearing hyphae described above ascend into the air in consort, and are more or less crowded into definite layers, cushions, columns or other complex masses. The same laws apply to the individual hyphae and their branches as to simple sporephores, and as long as the conidia, sporangia, gametes, &c., are borne on their external surfaces, it is quite consistent to speak of these as compound sporephores, &c., in the sense described, however complex they may become. Among the simplest cases are the sheet-like aggregates of spore-bearing hyphae in *Puccinia*, *Uromyces*, &c., or of basidia in *Exobasidium*, *Corticium*, &c., or of asci in *Exoascus*, *Ascocorticium*, &c. In the former, where the layer is small, it is often termed a sorus, but where, as in the latter, the spore-bearing layer is extensive, and spread out more or less sheet-like on the supporting tissues, it is more frequently termed a hymenium. Another simple case is that of the columnar aggregates of spore-bearing hyphae in forms like *Stilbum*, *Coremium*, &c. These lead

to cases where the main mass of the sporophore forms a supporting tissue of closely crowded or interwoven hyphae, the sporogenous terminal parts of the hyphae being found at the periphery or apical regions only. Here we have the cushion-like type (stroma) of *Nectria* and many Prenomycetes, the clavate "receptacle" of *Clavaria*, &c., passing into the complex forms met with in *Sparassis*, *Xylaria*, *Polypores*, and *Agaricini*, &c. In these cases the compound sporophore is often termed the hymenophore, and its various parts demand special names (pileus, stipes, gills, pores, &c.) to denote peculiarities of distribution of the hymenium over the surface.

Other series of modifications arise in which the tissues corresponding to the stroma invest the sporogenous hyphal ends, and thus enclose the spores, asci, basidia, &c., in a cavity. In the simplest case the stroma, after bearing its crop of conidia or oidia, develops ascogenous branches in the loosened meshes of its interior (e.g. *Oxygena*). Another simple case is where the plane or slightly convex surface of the stroma rises at its margins and overgrows the sporogenous hyphal ends, so that the spores, asci, &c., come to lie in the depression of a cavity—e.g. *Solenia*, *Cyphella*—and even simpler cases are met with in *Horteria*, where the zygospore is invested by the overgrowth of a dense mat of closely branching hyphae, and in *Gymnoascus*, where a loose mat of similarly barren hyphae covers in the tufts of asci as they develop.

In such examples as the above we may regard the hymenium (*Solenia*, *Cyphella*), zygospores, or asci as truly invested by later growth, but in the vast majority of cases the processes which result in the enclosure of the spores, asci, &c., in a "fructification" are much more involved, inasmuch as the latter is developed in the interior of hyphal tissues, which are by no means obviously homologous with a stroma. Thus in *Penicillium*, *Eurotium*, *Erysiphe*, &c., hyphal ends which are the initials of ascogenous branches, are invested by closely packed branches at an early stage of development, and the asci develop inside what has by that time become a complete investment. Whether a true sexual process precedes these processes or not does not affect the present question, the point being that the resulting spheroidal "fructification" (cleistocarp, perithecium) has a definite wall of its own not directly comparable with a stroma. In other cases (*Hypomyces*, *Nectria*) the perithecia arise on an already mature stroma, while yet more numerous examples can be seen in *Poronia*, *Hydomyces*, *Claviceps*, &c., where the perithecia originate below the surface of a stroma formed long before. Similarly with the various types of conidial or ooidal "fructifications," termed pycnidia, spermogonia, acedia, &c. In the simplest of these cases—e.g. *Fumago*—a single mycelial cell divides by septa in all three planes until a more or less solid clump results. Then a hollow appears in the centre owing to the more rapid extension of the outer parts, and into this hollow the cells lining it put forth short sporogenous branches, from the tips of which the spores (stylospores, conidia, spermatia) are abstricted. In a similar way are developed the pycnidia of *Cicinnobolus*, *Pleospora*, *Cucurbitaria*, *Leptosphaeria* and others. In other cases (*Diplodia*, *Aecidium*, &c.) conidial or ooidal "fructifications" arise by a number of hyphae interweaving themselves into a knot, as if they were forming a sclerotium. The outer parts of the mass then differentiate as a wall or investment, and the interior becomes a hollow, into which hyphal ends grow and abstrict the spores. Much more complicated are the processes in a large series of "fructifications," where the mycelium first develops a densely packed mass of hyphae, all alike, in which labyrinths of cavities subsequently form by separation of hyphae in the previously homogeneous mass, and the hymenium covers the walls of these cavities and passages as with a lining layer. Meanwhile differences in consistency appear in various strata, and a dense outer protective layer (peridium), soft gelatinous layers, and so on are formed, the whole eventually attaining great complexity—e.g. puff-balls, earth-stars and various *Phalloideae*.

Spore-Distribution.—Ordinary conidia and similarly abstricted dry spores are so minute, light and numerous that their dispersal is ensured by any current of air or water, and we also know that rats and other burrowing animals often carry them on their fur; similarly with birds, insects, slugs, worms, &c., on claws, feathers, proboscides, &c., or merely adherent to the slimy body. In addition to these accidental modes of dispersal, however, there is a series of interesting adaptations on the part of the fungus itself. Passing over the locomotor activity of zoospores (*Pythium*, *Peronospora*, *Saprolegnia*) we often find spores held under tension in sporangia (*Phobolus*) or in asci (*Peziza*) until ripe, and then forcibly shot out by the sudden rupture of the sporangial wall under the pressure of liquid behind—mechanism comparable to that of a pop-gun, if we suppose air replaced by watery sap. Even a single conidium, held tense to the last moment by the elastic cell-wall, may be thus shot forward by a spurt of liquid under pressure in the hypha abstricting it (e.g. *Empusa*), and similarly with basidiospores (*Coprinus*, *Agaricus*, &c.). A more complicated case is illustrated by *Sphaerobolus*, where the entire mass of spores, enclosed in a mortar by the elastic retroversion of a peculiar layer which, up to the last moment, surrounded the bomb, and then suddenly splits above, turns inside out, and drives the former as a projectile from a gun. Gelatinous or mucilaginous degenerations of cell-walls are frequently employed in the interests of spore dispersal. The mucilage surrounding

endospores of *Mucor*, conidia of *Empusa*, &c., serves to gum the spore to animals. Such gums are formed abundantly in pycnidia, and, absorbing water, swell and carry out the spores in long tendrils, which emerge for days and dry as they reach the air, the glued spores gradually being set free by rain, wind, &c. In ooidal chains (*Sclerotinia*) a minute double wedge of wall-substance arises in the middle lamella between each pair of contiguous oidia, and by its enlargement splits the separating lamella. These disjunctors serve as points of application for the elastic push of the swelling spore-ends, and as the connecting outer lamella of cell-wall suddenly gives way, the spores are jerked asunder. In many cases the slimy masses of spermatia (*Uredineae*), conidia (*Claviceps*), basidiospores (*Phallus*, *Coprinus*), &c., emit more or less powerful odours, which attract flies or other insects, and it has been shown that bees carry the fragrant oidia of *Sclerotinia* to the stigma of *Vaccinium* and infect it, and that flies carry away the foetid spores of *Phallus*, just as pollen is dispersed by such insects. Whether the strong odour of trimethylamine evolved by the spores of *Tilletia* attracts insects is not known.

The recent observations and exceedingly ingenious experiments of Falek have shown that the sporophores of the Basidiomycetes—especially the large sporophores of such forms as *Boletus*, *Polyporus*—contain quantities of reserve combustible material which are burnt up by the active metabolism occurring when the fruit-body is ripe. By this means the temperature of the sporophore is raised and the difference between it and the surrounding air may be one of several degrees. As a result convection currents are produced in the air which are sufficient to catch the basidiospores in their fall and carry them, away from the regions of comparative atmospheric stillness near the ground, to the upper air where more powerful air-currents can bring about their wide distribution.

Classification.—It has been accepted for some time now that the majority of the fungi proper fall into three main groups, the Phycocomycetes, Ascomycetes and Basidiomycetes, the Schizomycetes and Myxomycetes (Mycetozoa) being considered as independent groups not coming under the true fungi.

The chief schemes of classification put forward in detail have been those of P. A. Saccardo (1882-1892), of Oskar Brefeld and Von Tavel (1892), of P. E. L. Van Tieghem (1893) and of J. Schroeter (1892). The scheme of Brefeld, which was based on the view that the Ascomycetes and Basidiomycetes were completely asexual and that these two groups had been derived from one division (Zygomycetes) of the Phycocomycetes, has been very widely accepted. The recent work of the last twelve years has shown, however, that the two higher groups of fungi exhibit distinct sexuality, of either a normal or reduced type, and has also rendered very doubtful the view of the origin of these two groups from the Phycocomycetes. The real difficulty of classification of the fungi lies in the polyphyletic nature of the group. There is very little doubt that the primitive fungi have been derived by degradation from the lower algae. It appears, however, that such a degradation has occurred not only once in evolution but on several occasions, so that we have in the Phycocomycetes not a series of naturally related forms, but groups which have arisen perfectly independently of one another from various groups of the algae. It is also possible in the absence of satisfactory intermediate forms that the Ascomycetes and Basidiomycetes have also been derived from the algae independently of the Phycocomycetes, and perhaps of one another.

A natural classification on these lines would obviously be very complicated, so that in the present state of our knowledge it will be best to retain the three main groups mentioned above, bearing in mind that the Phycocomycetes especially are far from being a natural group. The following gives a tabular survey of the scheme adopted in the present article:

A. PHYCOMYCETES. Alga-like fungi with unicellular thallus and well-marked sexual organs.

CLASS I.—Oomycetes. Mycelium usually well developed, but sometimes poor or absent. Sexual reproduction by oogonia and antheridia; asexual reproduction by zoospores or conidia.

1. Monoblepharidaceae. Mycelium present, antheridia with antherozoids, oogonium with single oosphere: Monoblepharidaceae.
2. Peronosporiaceae. Mycelium present; antheridia but no antherozoids; oogonia with one or more oospheres: Peronosporaceae, Saprolegniaceae.
3. Chytridiaceae. Mycelium poorly developed or absent; oogonia and antheridia (without antherozoids) known in some cases; zoospores common: Chytridiaceae, Aestylitaceae.

CLASS II.—Zygomycetes. Mycelium well developed; sexual reproduction by zygospores; asexual reproduction by sporangia and conidia.

1. Mucorineae. Sexual reproduction as above, asexual by sporangia or conidia or both: Mucoraceae, Mortierellaceae, Chaetochladiaceae, Piptocephalidaceae.
2. Entomophthorineae. Sexual reproduction typical but with sometimes inequality of the fusing gametes (gametangia?): Entomophthoraceae.

B. HIGHER FUNGI. Fungi with segmental thallus; sexual reproduction sometimes with typical antheridia and oogonia (ascogonia) but usually much reduced.

CLASS I.—Ustilaginales. Forms with septate thallus, and reproduction by chlamydospores which on germination produce sporidia; sexuality doubtful.

CLASS II.—Ascomycetes. Thallus septate; spores developed in special type of sporangium, the ascus, the number of spores being usually eight. Sexual reproduction sometimes typical, usually reduced.

EXOASCEAE. Saccharomycetaceae, Perisporineae, Discomycetes, Pyrenomycetes, Tubercineae, Laboulbemiaceae.

CLASS III.—Basidiales. Thallus septate. Conidia (basidiospores) borne in fours on a special conidiophore, the basidium. Sexual reproduction always much reduced.

1. Uredineae. Life-history in some cases very complex and with well-marked sexual process and alternation of generations, in others much reduced; basidium (promycetium) derived usually from a thick-walled spore (teleospore).
2. Basidiomycetes. Life-history always very simple, no well-marked alternation of generations; basidium borne directly on the mycelium.

- (A) Protobasidiomycetes. Basidia septate.
Auriculariaceae, Pilacreaceae, Tremellinaceae.
(B) Autobasidiomycetes. Basidia non-septate.
Hymenomycetes, Gasteromycetes.

A. PHYCOMYCETES.—Most of the recent work of importance in this group deals with the cytology of sexual reproduction and of spore-formation, and the effect of external conditions on the production of reproductive organs.

Monoblepharidaceae consists of a very small group of aquatic forms living on fallen twigs in ponds and ditches. Only one genus, *Monoblepharis*, can certainly be placed here, though a somewhat similar genus, *Myrioblepharis*, with a peculiar multiciliate zoospore like that of *Vaucheria*, is provisionally placed in the same group. *Monoblepharis* was first described by Cornu in 1871, but from that time until 1895 when Roland Thaxter described several species from America the genus was completely lost sight of. *Monoblepharis* has oogonia with single oospores and antheridia developing a few amoeboid uniciliate antherozoids; these creep to the opening of the oogonium and then swim in. The resemblance between this genus and *Oedogonium* among the algae is very striking, as is also that of *Myrioblepharis* and *Vaucheria*.

Peronosporaceae are a group of endophytic parasites—about 100 species—of great importance as comprising the agents of "damping off" disease (*Pythium*), vine-mildew (*Plasmopara*), potato disease (*Phytophthora*), onion-mildew (*Peronospora*). *Pythium* is a semi-aquatic form attacking seedlings which are too plentifully supplied with water; its hyphae penetrate the cell-walls and rapidly destroy the watery tissues of the living plant; then the fungus lives in the dead remains. When the free ends of the hyphae emerge again into the air they swell up into spherical bodies which may either fall off and behave as conidia, each putting out a germ-tube and infecting the host; or the germ-tube itself swells up into a zoosporangium which develops a number of zoospores. In the rotting tissues branches of the older mycelium similarly swell up and form antheridia and oogonia (fig. 4). The contents of the antheridium are not set free, but that organ penetrates the oogonium by means of a narrow outgrowth, the fertilizing tube, and a male nucleus then passes over into the single oosphere, which at first multinucleate becomes uninnucleate before fertilization. *Pythium* is of interest as illustrating the dependence of zoospore-formation on conditions and the indeterminate nature of conidia. The other genera are more purely parasitic; the mycelium usually sends haustoria into the cells of the host and puts out branched, aerial conidiophores through the stomata, the branches of which abscise numerous "conidia"; these either germinate directly or their contents break up into zoospores (fig. 5). The development of the "conidia" as true conical spores or as zoosporangia may occur in one and the same species (*Cystopus candidus*, *Phytophthora infestans*) as in *Pythium* described above; in other cases the direct conidial germination is characteristic of genera—e.g. *Peronospora*; while others emit zoospores—e.g. *Plasmopara*, &c. In *Cystopus* (*Albugo*) the "conidia" are abscised in basipetal chain-like series from the ends of hyphae which come to the surface in tufts and break through the epidermis as white pustules. Each "conidium" contains numerous nuclei and is really a zoosporangium, as after dispersal it breaks up into a number of zoospores. The Peronosporaceae reproduce themselves sexually by means of antheridia and oogonia as described in *Pythium*,

In *Cystopus Bliti* the oosphere contains numerous nuclei, and all the male nuclei from the antheridium pass into it, the male and female nuclei then fusing in pairs. We thus have a process of "multiple fertilization"; the oosphere really represents a large

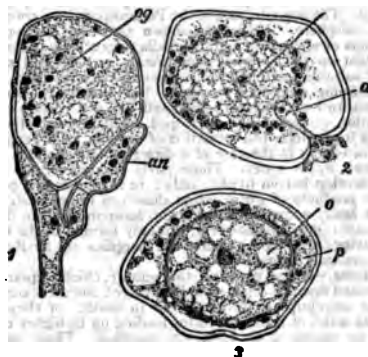

From Strasburger's *Lehrbuch der Botanik*, by permission of Gustav Fischer.

FIG. 4.—Fertilization of the Peronosporaceae. After Wager.
1. *Peronospora parasitica*. Young multinucleate oogonium (og) and antheridium (an).
2. *Albugo candida*. Oogonium with the central uninnucleate oosphere and the fertilizing tube (a) of the antheridium which introduces the male nucleus.
3. The same. Fertilized egg-cell (o) surrounded by the periplasm (p).
number of undifferentiated gametes and has been termed a coogamete. Between *Cystopus Bliti* on the one hand and *Pythium de Baryanum* on the other a number of cytologically intermediate forms are known. The oospore on germination usually gives origin

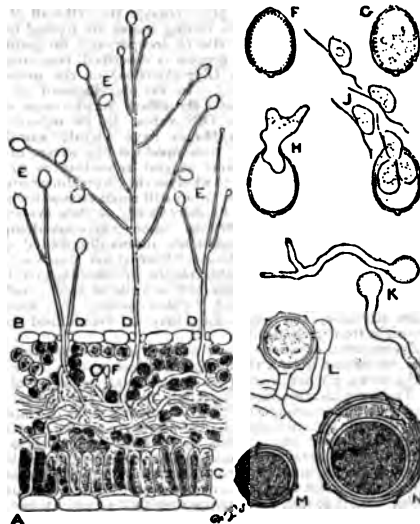

FIG. 5.—Phytophthora infestans. Fungus of Potato Disease.
A, B, Section of Leaf of Potato with sporangiohores of *Phytophthora infestans* passing through the stomata D, on the under surface of the leaf.
E, Sporangia.
F, G, H, J, Further development of the sporangia.
K, Germination of the zoospores formed in the sporangia.
L, M, N, Fertilization of the oogonium and development of the oospore in *Peronospora*.

to a zoosporangium, but may form directly a germ tube which infects the host.

Saprolegniaceae are aquatic forms found growing usually on dead insects lying in water but occasionally on living fish (e.g. the salmon disease associated with *Saprolegnia ferax*). The chief genera are

Saprolegnia, *Achlya*, *Pythiopsis*, *Dictyuchus*, *Aplanes*. Motile zoospores which escape from the zoosporangium are present except in *Aplanes*. The sexual reproduction shows all transitions between forms which are normally sexual, like the Peronosporaceae, to forms in which no antheridium is developed and the oospores develop parthenogenetically. The oogonia, unlike the Peronosporaceae, contain more than one oospore. Klebs has shown that the development of zoosporangia or of oogonia and pollinidia respectively in *Saprolegnia* is dependent on the external conditions; so long as a continued stream of suitable food-material is ensured the mycelium grows on without forming reproductive organs, but directly the supplies of nitrogenous and carbonaceous food fall below a certain degree of concentration sporangia are developed. Further reduction of the supplies of food effects the formation of oogonia. This explains the sequence of events in the case of a *Saprolegnia*-mycelium radiating from a dead fly in water. Those parts nearest the fly and best supplied develop barren hyphae only; in a zone at the periphery, where the products of putrefaction dissolved in the water form a dilute but easily accessible supply, the zoosporangia are developed in abundance; oogonia, however, are only formed in the depths of this radiating mycelium, where the supplies of available food materials are least abundant.

Chytridiaceae.—These parasitic and minute, chiefly aquatic, forms may be looked upon as degenerate Oomycetes, since sexual process and feeble unicellular mycelium occur in some; or they may be regarded as series of primitive forms leading up to higher members. There is no means of deciding the question. They are usually included in Oomycetes, but their simple structure, minute size, usually unilocular zoospores, and their negative characters would justify their retention as a separate group. It contains less than 200 species, chiefly parasitic on or in algae and other water-plants or animals, of various kinds, or in other fungi, seedlings, pollen and higher plants. They are often devoid of hyphae, or put forth fine protoplasmic filaments into the cells of their hosts. After absorbing the cell-contents of the latter, which it does in a few hours or days, the fungus puts out a sporangium, the contents of which break up into numerous minute swarm-spores, usually one-ciliate, rarely two-ciliate. Any one of these soon comes to rest on a host-cell, and either pierces it and empties its contents into its cavity, where the further development occurs (*Olpidium*), or merely sends in delicate protoplasmic filaments (*Rhizophydium*) or a short hyphal tube of, at most, two or three cells, which acts as a haustorium, the further development taking place outside the cell-wall of the host (*Chytridium*). In some cases resting spores are formed inside the host (*Chytridium*), and give rise to zoosporangia on germination. In a few species a sexual process is described, consisting in the conjugation of similar cells (*Zygochytrium*) or the union of two dissimilar ones (*Polyphagus*). In the development of distinct antheridial and oogonial cells the allied Ancylistineae show close alliances to *Pythium* and the Oomycetes. On the other hand, the unilocular zoospores of *Polyphagus* have slightly amoeboid movements, and in this and the pseudopodium-like nature of the protoplasmic processes, such forms suggest resemblances to the Myxomycetes. Opinions differ as to whether the Chytridiaceae are degraded or primitive forms, and the group still needs critical revision. Many new forms will doubtless be discovered, as they are rarely collected on account of their minuteness. Some forms cause damping off of seedlings—e.g. *Olpidium Brassicae*; others discoloured spots and even tumour-like swellings—e.g. *Synchytrium Scabosae*, *S. Succisae*, *Urophlyctis*, &c., on higher plants. Analogies have been pointed out between Chytridiaceae and unicellular algae, such as Chlorosphaeraceae, Protococccaceae, "Palmellaceae," &c., some of which are parasitic, and suggestions may be entertained as to possible origin from such algae.

The *Zygomycetes*, of which about 200 species are described, are especially important from a theoretical standpoint, since they furnished the series whence Brefeld derived the vast majority of the fungi. They are characterized especially by the zygospores, but the asexual organs (sporangia) exhibit interesting series of changes, beginning with the typical sporangium of *Mucor* containing numerous endospores, passing to cases where, as in *Thamnidium*, these are accompanied with more numerous small sporangia (sporangioles) containing few spores, and thence to *Chaetocladium* and *Piptocephalis*, where the sporangioles form but one spore and fall and germinate as a whole; that is to say, the monosporous sporangium has become a conidium, and Brefeld regarded these and similar series of changes as explaining the relation of ascus to conidium in higher fungi. According to his view, the ascus is in effect the sporangium with several spores, the conidium the sporangiole with but one spore, and that not loose but fused with the sporangiole wall. On this basis, with other interesting morphological comparisons, Brefeld erected his hypothesis, now untenable, that the Ascomycetes and Basidiomycetes diverge from the Zygomycetes, the former having particularly specialized the ascus (sporangial) mode of reproduction, the latter having specialized the conidial (indehiscent one-spored sporangiole) mode. In addition to sporangia and the conidial spores referred to, some Mucorini show a peculiar mode of vegetative reproduction by means of gemmae or chlamydozoospores—i.e. short segments of the hyphae become stored with fatty reserves and act as spores. The gemmae formed on submerged Mucors may bud like

a yeast, and even bring about alcoholic fermentation in a saccharine solution.

The segments of the hyphae in this group usually contain several nuclei. At the time of sporangial formation the protoplasm with numerous nuclei streams into the swollen end of the sporangiole and there becomes cut off by a cell-wall to form the sporangium. The protoplasm then becomes cut up by a series of clefts into a number of smaller and smaller pieces which are unicellular in *Piobolus*, multicellular in *Sporidinia*. These then become surrounded by a cell-wall and form the spores. This mode of spore-formation is totally different from that in the ascus; hence one of the difficulties of the acceptance of Brefeld's view of the homology of ascus and sporangium. The cytology of zygospore-formation is not known in detail; the so-called gametes which fuse are multinucleate and are no doubt of the nature of gametangia. The fate of these nuclei is doubtful, probably they fuse in pairs (fig. 6).

Blakeslee has lately made some very important observations on the Zygomycetes. It is well known that while in some forms, e.g. *Sporidinia*, zygospores are easily obtained, in others, e.g. most species of *Mucor*, they are very erratic in their appearance. This has now been explained by Blakeslee, who finds that the Mucorinae can be divided into two groups, termed homothallic and heterothallic respectively. In the first group zygospores can arise by the union of branches from the same mycelium and so can be produced by the growth from a single spore; this group includes *Sporidinia grandis*, *Spinellus fusiger*, some species of *Mucor*, &c. The majority of forms, however, fall into the heterothallic group, in which the association of branches from two mycelia different in nature is necessary for the formation of zygospores. These structures cannot then be produced from the product of a single spore nor even from the thalli derived from any two spores. The two kinds of thalli Blakeslee considers to have a differentiation of the nature of sex and he distinguishes them as (+) and (-) forms; the former being usually distinguished by a somewhat greater luxuriance of growth.

The classification of the Mucorini depends on the prevalence and characters of the conidia, and of the sporangia and zygospores—e.g. the presence or absence of a columella in the former, the formation of an investment round the latter. Most genera are asexual, but some—*Chaetocladium*, *Piptocephalis*—are parasites on other Mucorini, and one or two are associated casually with the rotting of tomatoes and other fruits, bulbs, &c., the fleshy parts of which are rapidly destroyed if once the hyphae gain entrance. Even more important is the question of mycosis in man and other animals, referred to species of *Mucor*, and investigated by Lucet and Costantin. Klebs has concluded that transpiration is the important factor in determining the formation of sporangia, while zygote-development depends on totally different conditions; these results have been called in question by Falck.

The *Entomophthoraceae* contain three genera, *Empusa*, *Entomophthora* and *Basidiobolus*. The two first genera consist of forms which are parasitic on insects. *Empusa Muscae* causes the well-known epidemic in house-flies during the autumn; the dead, affected flies are often found attached to the window surrounded by a white halo of conidia. *B. ranae* is found in the alimentary canal of the frog and growing on its excrement. In these three genera the conidia are cast off with a jerk somewhat in the same way as the sporangium of *Piobolus*.



From Strasburger's *Lehrbuch der Botanik*, by permission of Gustav Fischer.

FIG. 6.—*Mucor Mucedo*. Different stages in the formation and germination of the zygospore. (After Brefeld, 1-4. 5 from v. Tavel, *Pflanz.*)

1. Two conjugating branches in contact.
2. Separation of the conjugating cells (a) from the suspensors (b).
3. More advanced stage: the conjugating cells (a) are still distinct from one another; the warty thickenings of their walls have commenced to form.
4. Ripe zygospore (b) between the suspensors (a).
5. Germinating zygospore with a germ-tube bearing a sporangium.

B. HIGHER FUNGI.—Now that Brefeld's view of the origin of these forms from the Zygomycetes has been overthrown, the relationship of the higher and lower forms of fungi is left in obscurity. The term *Eumycetes* is sometimes applied to this group to distinguish them from the Phycmycetes, but as the same name is also applied to the fungi as a whole to differentiate them from the Mycetozoa and Bacteria, the term had best be dropped. The Higher Fungi fall into three groups: the *Ustilaginales*, of doubtful position, and the two very sharply marked groups *Basidiales* and *Ascomycetes*.

I. Ustilaginales.—This includes two families Ustilaginaceae (smuts) and Tilletiaceae (bunts). The bunts and smuts which damage our grain and fodder plants comprise about 400 species of internal parasites, found in all countries on herbaceous plants, and especially on Monocotyledons. They are remarkable for their dark spores developed in gall-like excrescences on the leaves, stems, &c. or in the fruits of the host. The discovery of the yeast-conidia of these fungi, and their thorough investigation by Brefeld, have thrown new lights on the group, as also have the results elucidating the nature of the ordinary dark spores—smuts, bunt, &c.—which by their mode of origin and development are chlamydo-spores. When the latter germinate a slender "promycium" is put out; in *Ustilago* and its allies this is transversely septate, and bears lateral conidia (sporidia); in *Tilletia* and its allies non-septate, and bears a terminal tuft of conidia (sporidia) (fig. 7). Brefeld regarded the promycium as a kind of *basidium*, bearing lateral or terminal conidia (comparable to *basidio-spores*), but since the number of basidiospores is not fixed, and the basidium has not yet assumed very definite morphological characters, Brefeld termed the group *Hemibasidia*, and regarded them as a half-way stage in the evolution of the true Basidiomycetes from Phycmycetes, the *Tilletia* type leading to the true basidium (Autobasidium), the *Ustilago* type to the protobasidium, with lateral spores; but this view is based on very poor evidence, so that it is best to place these forms as a separate group, the *Ustilaginales*. The yeast-conidia, which bud off from the conidia or their resulting mycelium when sown in nutrient solutions, are developed in successive crops by budding exactly as in the yeast plant, but they cannot ferment sugar solutions. It is the rapid spread of these yeast-conidia in manure and soil waters which makes it so difficult to get rid of smuts, &c., in the fields, and they, like the ordinary conidia, readily infect the seedling wheat, oats, barley or other cereals. Infection in these cases occurs in the seedling at the place where root and shoot meet, and the infecting hyphae having entered the plant goes on living in it and growing up with it as if it had no parasitic action at all. When the flowers form, however, the mycelium sends hyphae into the young ovaries and rapidly replaces the stores of sugar and starch, &c., which would have gone to make the grain, by the soot-like mass of spores so well known as smut, &c. These spores adhere to the grain, and unless destroyed, by "steeping" or other treatment, are sown with it, and again produce sporidia and yeast-conidia which infect the seedlings. In other species the infection occurs through the style of the flower, but the fungus after reaching the ovule develops no further during that year but remains dormant in the embryo of the seed. On germination, however, the fungus behaves in the same way as one which has entered in the seedling stage. The cytology of these forms is very little known; Dangeard states that there is a fusion of two nuclei in the chlamydo-spore, but this requires confirmation. Apart from this observation there is no other trace of sexuality in the group.

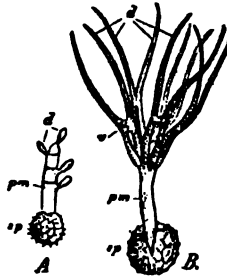

From Vine's Student's Text Book of Botany, by permission of Swan Sonnenschein & Co.

FIG. 7.—Germinating resting-gonidia. A, of *Ustilago receptaculorum*; B, of *Tilletia Caries*.
sp. The gonidium.
pm. The promycium.
d. The sporidia: in B the sporidia have coalesced in pairs at *v*.

II. Ascomycetes.—This, except in the case of a few of the simpler forms, is a very sharply marked group characterized by a special type of sporangium, the *ascus*. In the development of the ascus we find two nuclei at the base which fuse together to form the single nucleus of the young ascus. The single nucleus divides by three successive divisions to form eight nuclei lying free in the protoplasm of the ascus. Then by a special method, described first by Harper, a mass of protoplasm is cut out round each nucleus: thus eight unicellular ascospores are formed by free-cell formation. The protoplasm remaining over is termed *epiplasm* and often contains glycogen (fig. 8). In some cases nuclear division is carried further before spore-formation occurs, and the number of spores is then 16,

32 and 64, &c.; in a few cases the number of spores is less than eight by abortion of some of the eight nuclei. The ascus is thus one of the most sharply characterized structures among the fungi.

In some forms we find definite male and female sexual organs (*Sphaerotheca*, *Pyronema*, &c.), in others the antheridium is abortive or absent, but the ascogonium (ogonium) is still present and the female nuclei fuse in pairs (*Lachnea stercorea*, *Humaria granulata*, *Ascobolus furfuraceus*); while in other forms ascogonium and antheridium are both absent and fusion occurs between vegetative nuclei (*Humaria rutilans*, and probably the majority of other forms). In other cases the sexual fusion is apparently absent altogether, as in *Exoascus*. In the first case (fig. 9) we have a true sexual process, while in the second and third cases we have a reduced sexual process in which the fusion of other nuclei has replaced the fusion of the normal male and female nuclei. It is to be noted that all the forms exhibit the fusion of nuclei in the ascus, so that those with the normal or reduced sexual process described above have two nuclear fusions in their life-history. The advantage or significance of the second (ascus) fusion is not clearly understood.

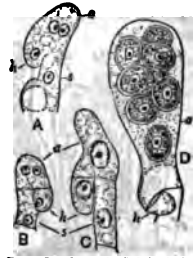

From Strasburger's Lehrbuch der Botanik, by permission of Gustav Fischer.

FIG. 8.—Development of the ascus.

A-C, *Pyronema confusus*. (After Harper.)
 D, Young ascus of *Bowdleria* with eight spores. (After Clausen.)

The group of the Hemiasci was founded by Brefeld to include forms which were supposed to be a connecting link between Phycmycetes and Ascomycetes. As mentioned before, the connexion between these two groups is very doubtful, and the derivation of the ascus from an ordinary sporangium of the Zygomycetes cannot be accepted. The majority of the forms which were formerly included in this group have been shown to be either true Phycmycetes (like *Ascoidea*) or true Ascomycetes (like *Thelebotia*, *Eremascus* and *Dipodascus*, which are often placed among the Hemiasci, possibly do not belong to the Ascomycetes series at all.

Exoascaceae are a small group of doubtful extent here used to include *Exoascus*, *Taphrina*, *Ascarticium* and *Endomyces*. The

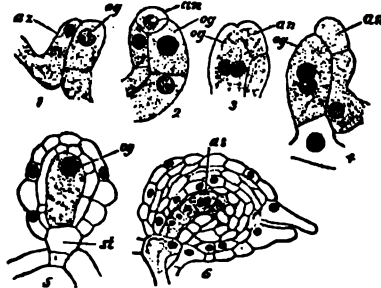

From Strasburger's Lehrbuch der Botanik, by permission of Gustav Fischer.

FIG. 9.—*Sphaerotheca Castagnei*. Fertilization and Development of the Perithecium. (After Harper.)

1. Oogonium (og) with the antheridial branch (az) applied to its surface.
2. Separation of antheridium (an).
3. Passage of the antheridial nucleus towards that of the oogonium.
4. Union of the nuclei.
5. Fertilized oogonium surrounded by two layers of hyphae derived from the stalk-cell (st).
6. The multicellular ascogonium derived by division from the oogonium; the terminal cell with the two nuclei (as) gives rise to the ascus.

mycelium is very much reduced in extent. The asci are borne directly on the mycelium and are therefore fully exposed, being devoid from the beginning of any investment. The *Taphrinae*, which include *Exoascus* and *Taphrina*, are important parasites—e.g. pocket-plums and witches' brooms on birches, &c.—are due to their action (fig. 10). *Exoascus* and *Ascarticium* present interesting parallels to *Exobasidium* and *Corticium* among the Basidiomycetes. *Saccharomycetaceae* include the well-known yeasts which belong mainly to the genus *Saccharomyces*. They are characterized by their unicellular nature, their power of rapid budding, their capacity for fermenting various sugars, and their power of forming endogenous

spores. The sporangium with its endogenous spores has been compared with an ascus, and on these grounds the group is placed among the Ascomycetes—a very doubtful association. The group has attained an importance of late even beyond that to which it was brought by Pasteur's researches on alcoholic fermentation, chiefly owing to the exact results of the investigations of Hansen, who first applied the methods of pure cultures to the study of these organisms, and showed that many of the inconsistencies hitherto



From Strashburger's *Lehrbuch der Botanik*, by permission of Gustav Fischer.

FIG. 10.—*Taphrina Pruni*. Transverse section through the epidermis of an infected plum. Four ripe asci, *a*₁, *a*₂, with eight spores, *a*₃, *a*₄, with yeast-like conidia abstracted from the spores. After Sadebeck.

- st*, Stalk-cells of the asci.
- m*, Filaments of the mycelium cut transversely.
- cut*, Cuticle.
- ep*, Epidermis.

and four spores are formed in the mother cell, a process obviously comparable to the typical development of ascospores in an ascus. Under yet other conditions the quiescent yeast-cells floating on the surface of the fermented liquor grow out into elongated sausage-shaped or cylindrical cells and branching cell-series, which mat together into mycelium-like veils. At the bottom of the fermented liquor the cells often obtain fatty contents and thick walls, and behave as resting cells (chlamydospores). The characters employed by experts for determining a species of yeast are the sum of its peculiarities as regards form and size: the shapes, colours, consistency, &c., of the colonies grown on certain definite media; the optimum temperature for spore-formation, and for the development of the "veils"; and the behaviour as regards the various sugars.

The following summary of some of the principal characteristics of half-a-dozen species will serve to show how such peculiarities can be utilized for systematic purposes:

Species.	Optimum Temperature for		Characters of			Sugars Fermented and Products, &c
	Spores	Veils.	Fermentation.	Cells.	Spores.	
<i>S. cerevisiae</i> L. . . .	30°	20°-28°	High	Rounded	Globoid	Inverts maltose and saccharose and form alcohol 4-6 vol. %
<i>S. Pastorianus</i> L. . . .	27°-5°	26°-28°	Low	Rounded	Globoid	
<i>S. ellipsoideus</i>	25°	33°-34°	Low	Rounded	Globoid	
<i>S. anomalus</i>	28°-31°	?	High	Elliptical	Hat-shaped	Ditto, and evolves a fragrant ether.
<i>S. Ludwigii</i>	30°-31°	?	?	Elongated	Globoid	
<i>S. membranaefaciens</i>	30°	?	High	Elongated	Globoid	Inverts neither maltose nor saccharose.

Two questions of great theoretical importance have been raised over and over again in connexion with yeasts, namely, (1) the morphological one as to whether yeasts are merely degraded forms of higher fungi, as would seem implied by their tendency to form elongated, hypha-like cells in the veils, and their development of "ascospores" as well as by the wide occurrence of yeast-like "sprouting forms" in other fungi (e.g. *Mucor*, *Exoascus*, *Ustilagineae*, higher Ascomycetes and Basidiomycetes); and (2) the question as to the physiological nature and meaning of fermentation. With regard to the first question no satisfactory proof has as yet been given that Saccharomycetes are derivable by culture from any higher form, the recent statements to that effect not having been confirmed. At the same time there are strong grounds for insisting on the resemblances between *Endomyces*, a hyphal fungus bearing yeast-like asci, and such a form as *Saccharomycetes anomalus*. Concerning the second question, the recent investigations of Buchner

and others have shown that a ferment (zymase) can be extracted from yeast-cells which causes sugar to break up into carbon dioxide and alcohol. It has since been shown by Buchner and Albert that yeast-cells which have been killed by alcohol and ether, or with acetone, still retain the enzyme. Such material is far more active than the zymase obtained originally by Buchner from the expressed juice of yeast-cells. Thus alcoholic fermentation is brought into line with the other fermentations.

Schizosaccharomycetes includes a few species in which the cells do not "bud" but become elongated and then divide transversely. In the formation of sporangia two cells fuse together by means of outgrowths, in a manner very similar to that of *Styragia*; sometimes, however, the wall between two cells merely breaks down. The fused cell becomes a sporangium, and in it eight spores are developed. In certain cases single cells develop parthenogenetically, without fusion, each cell producing, however, only four spores. In *Zygosaccharomycetes* described by Barker (1901) we have a form of the usual sprouting type, but here again there is a fusion of two cells to form a sporangium.

Cytology.—The study of the nucleus of yeast-cells is rendered difficult by the presence of other deeply staining granules termed by Guillermond *metachromatic granules*. These have often been mistaken for nuclei and have to be carefully distinguished by differential stains. In the process of budding the nucleus divides apparently by a process of direct division. In the formation of spores the nucleus of the cell divides, the protoplasm collects round the nuclei to form the spores by free-cell formation; the protoplasm (epiplasm) not used in this process becomes disorganized. A fusion of nuclei was originally described by Janssens and Leblanc, but it was observed neither by Wager nor Guillermond and is probably absent. In *Schizosaccharomycetes* and *Zygosaccharomycetes*, however, we have fusion of nuclei in connexion with the conjugation of cells which precedes sporangium-formation. The theory may be put forward that the ordinary forms have been derived from sexual forms like *Schizosaccharomycetes* and *Zygosaccharomycetes* by a loss of sexuality, the sporangium being formed parthenogenetically without any nuclear fusion. This suggests a possible relationship to *Eremiascus*, which can only doubtfully be placed in the Ascomycetes (*vide supra*).

Carposaccomycetes.—The other divisions of the Ascomycetes may be distinguished as Carposaccomycetes because they do not bear the asci free on the mycelium but enclosed in definite fruit bodies or ascocarps. The ascocarps can be distinguished into two portions, a mass of sterile or vegetative hyphae forming the main mass of the fruit body, and surrounding the fertile ascogenous hyphae which bear at their ends the asci. When the ascogonium (female organ) is present the ascogenous hyphae arise from it, with or without its previous fusion with an antheridium. In other cases the ascogenous hyphae arise directly from the vegetative hyphae. In connexion with this condition of reduction a fusion of nuclei has been observed in *Hymaria rutilans* and is probably of frequent occurrence. The asci may be derived from the terminal cell of the branches of the ascogenous hyphae, but usually they are derived from the penultimate cell, the tip curving over to form the so-called crozier. By this means the ascus cell is brought uppermost, and after the fusion of the two nuclei it develops enormously and produces the ascospores. The ascospores escape from the asci in various ways, sometimes by a special ejection-mechanism. The Ascomycetes, at least the Carposaccomycetes, exhibit a well-marked alternation of sexual and asexual generations. The ordinary mycelium is the gametophyte since it bears the ascogonia and antheridia when present; the

ascogenous hyphae with their asci represent the sporophyte since they are derived from the fertilized ascogonium. The matter is complicated by the apogamous transition from gametophyte to sporophyte in the absence of the ascogonium; also by the fact that there are normally two fusions in the life-history as mentioned earlier. If there are two fusions one would expect two reductions, and Harper has suggested that the division of the nuclei into eight in the ascus, instead of into four spores as in most reduction processes, is associated with a double reduction process in the ascus. Miss Fraser in *Hymaria rutilans* finds two reductions: a normal synaptic reduction in the first nuclear division of the ascus, and a peculiar reduction division termed *brachymiosis* in the third ascus division.

Various types of ascocarp are characteristic of the different divisions of the Carposaccomycetes: the cleistothecium, apothecium and perithecium.

Perisporiaceae.—This includes two chief families, Erysiphaceae and Perisporiaceae. They are characterized by an ascocarp without any opening to the exterior, the ascospores being set free by the decay or rupture of the ascocarp wall; such a fruit-body is termed a *cleistothecium* (cleistocarp). The Erysiphaceae are a sharply marked group of forms which live as parasites. They form a superficial mycelium on the surface of the plant, the hyphae not usually penetrating the tissues but merely sending haustoria into the epidermal cells. Only in rare cases is the mycelium intercellular. Owing to their appearance they go by the popular name of mildews. *Sphaerotheca Humuli* is the well known hop-mildew, *Sphaerotheca Mors-Uvae* is the gooseberry mildew, the recent advent of which has led to special legislation in Great Britain to prevent its spreading, as when rampant it makes the culture of gooseberries impossible. *Erysiphe*, *Uncinula* and *Phyllactinia* are other well-known genera. The form of the fruit body, the difference and the nature of special outgrowths upon it—the appendages—are characteristic of the various genera. Besides perithecia the members of the Erysiphaceae possess conidia borne in simple chains. De Bary brought forward very strong evidence for the origin of the ascocarp in *Sphaerotheca* and *Erysiphe* by a sexual process, but Harper in 1895 was the first to prove conclusively, by the observation of the nuclear fusion, that there was a definite fertilization in *Sphaerotheca Humuli* by the fusion of a male (antheridial) nucleus with a female, ascogonial (oogonial) nucleus. Since then Harper has shown that the same process occurs in *Erysiphe* and *Phyllactinia*.

The Perisporiaceae are saprophytic forms, the two chief genera being *Aspergillus* and *Penicillium*. The blue-green mould *P. crustaceum* and the green mould *A. herbariorum* (= *Eurotium herbariorum*) are extraordinarily widely distributed, moulds being found on almost any food-material which is exposed to the air. They have characteristic conidiophores bearing numerous conidia, and also cleistothecia which are spherical in form and yellowish in colour. The latter arise from the crown of a spirally coiled archicarp (bearing an ascogonium at its end) and a straight antheridium. Vegetative hyphae then grow up and surround these and enclose them in a continuous sheath of plectenchyma (fig. 11). It has lately been shown by Fraser and Chambers that in *Eurotium* both

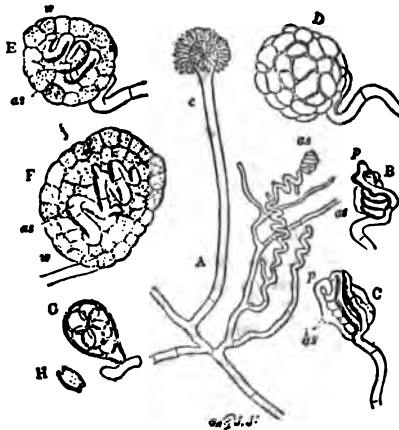

FIG. 11.—Development of *Eurotium repens*. (After De Bary.)
 A, Small portion of mycelium with conidiophore (c), and young archicarp (as). B, The spiral archicarp (as), with the antheridium (p). C, The same, beginning to be surrounded by the hyphae forming the perithecium wall. D, The perithecium. E, F, Sections of young perithecia. G, An ascus. H, An ascospore.

ascogonium and antheridium contain a number of nuclei (i.e. are coenogametes), but that the antheridium disorganizes without passing its contents into the ascogonium. There is apparently a reduced sexual process by the fusion of the ascogonial (female) nuclei in pairs. *Aspergillus Oryzae* plays an important part in saccharifying the starch of rice, maize, &c., by means of the abundant diastase it secretes, and, in symbiosis with a yeast which ferments the sugar formed, has long been used by the Japanese for the preparation of the alcoholic liquor sake. The process has now been successfully introduced into European commerce.

Discomycetes.—Used in its widest sense this includes the *Hysteriaceae*, *Phacidiaecae*, *Helvellaceae*, &c. The group is

characterized in general by the possession of an ascocarp which, though usually a completely closed structure during the earlier stages of development, at maturity opens out to form a bowl or saucer-shaped organ, thus completely exposing the layer of asci which forms the hymenium. Such an ascocarp goes by the name of *apothecium*. Owing to the shape of the fruit-body many of these forms are known as cup-fungi, the cup or apothecium often attaining a large size, sometimes several inches across (fig. 12). Functional male and female organs have been shown to exist in *Pyrenopeziza Boudiera*; in *Lachnea stercorae* both ascogonia and antheridia are present, but the antheridium is non-functional, the ascogonial (female) nuclei fusing in pairs; this is also the case in *Humaria granulata* and *Ascobolus furfuraceus*, where the antheridium is entirely absent. In *H. vulturna*, however, both sexual organs are absent and the ascogonium hyphae arise apogamously from the ordinary hyphae of the mycelium. In all these cases the



From Strasburger's *Lehrbuch der Botanik*, by permission of Gustav Fischer.
 FIG. 12.—*Pyrenopeziza aurantiaca*. (After Krombholz, nat. size.)

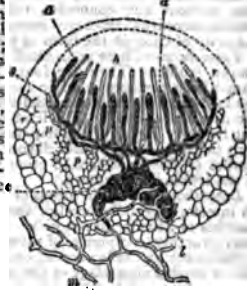

FIG. 13.—*Ascobolus furfuraceus*. Diagrammatic section of the fructification. (After Janczewski.)

- m, Mycelium.
- c, Archicarp.
- l, Pollinodium.
- s, Ascogonium filaments.
- a, Asci.
- p, Sterile tissue from which the paraphyses & spring.

ascogonium and antheridium contain numerous nuclei; they are to be looked upon as gametangia in which there is no differentiation of gametes, and since they act as single gametes they are termed coenogametes. In some forms as in *Ascobolus* the ascogonium is multicellular, the various cells communicating by pores in the transverse walls (fig. 13).

In the *Helvellaceae* there is no apothecium but a large irregular fruit body which at maturity bears the asci on its surface. The development is only slightly known, but there is some evidence for believing that the fruit-body is closed in its very early stages.

The genus *Peziza* (in its widest sense) may be taken as the type of the group. Most of them grow on living plants or on dead vegetable remains, very often on fallen wood; a number, however, are found growing on earth which is rich in humus. The genus *Sclerotinia* may be mentioned here; a number of forms have been investigated by Woronia. The conidia are fragrant and are carried by bees to the stigma of the bilberry; here they germinate with the pollen and the hyphae pass with the pollen tubes down the style; the former infect the ovules and produce sclerotia, therein reducing the fruits to a mummified condition. From the sclerotia later the apothecium develops. One species, *S. heterococa*, is *heterococous*; the ascospores infecting the leaves of *Vaccinium uliginosum*, while the conidia which then arise infect only *Ledum palustre*. This is the only case of heterococism known in the vegetable kingdom outside the *Uredineae*.

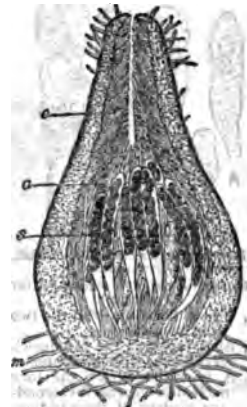

From Strasburger's *Lehrbuch der Botanik*, by permission of Gustav Fischer.
 FIG. 14.—Perithecium of *Pedospiza limicola* in longitudinal section. (After v. Tavel.)

- s, Asci.
- a, Paraphyses.
- e,Periphyses.
- m, Mycelial hyphae.

Pyrenomyces.—This is an extraordinarily large and varied group of forms which mostly live parasitically or saprophytically on vegetable tissue, but a few are parasitic on insect-larvae. The group

is characterized by a special type of ascocarp, the *perithecium*. This is typically of a flask-shaped form opening with a small pore at the top. The asci live at the bottom often mixed with paraphyses, while the upper "neck" of the flask is lined with special hyphae, the periphyses, which aid in the ejection of the spores (fig. 14). The simpler forms bear the perithecia directly on the mycelium, but the more highly developed forms often bear them on a special mycelial development—the stroma, which is often of large size and special shape and colour, and of dense consistency. The cytological details of development of the perithecia are not well known; most of them appear to develop their ascogenous hyphae in an apogamous way without any connexion with an ascogonium. Besides the special ascocarps, accessory reproductive organs are known in the majority of cases in the form of conidia.

Tuberineae.—These are a small group of fungi including the well-known truffles. They are found living saprophytically (in part parasitically) underground in forests. The asci are developed in the large dense fruit bodies (cleistothecia) and the spores escape by the decay of the wall. The fruit-body is of complicated structure, but its early stages of development are not known. Many of the fruit-bodies have a pleasant flavour and are eaten under the name of truffles (*Tuber brumale* and other species). The exact life-history of the truffle is not known.

Laboulbeniinae are a group of about 150 species of fungi found on insects, especially beetles, and principally known from the researches of Thaxter in America. The plant is a small, dark brown, erect structure (receptacle) of a few cells, and 1-10 mm. high, attached to the insect by the lowermost end (foot), and easily mistaken for a hair or similar appendage of the insect. The receptacle ends above in appendages, each consisting of one or a few cells, some of which are the male organs, others the female organs, and others again may be barren hairs. The male organ (antheridium) consists of a few cells, the terminal one of which either abstricts from its end, or arises from its interior the non-motile spermatia, reminding us of those of the Florideae. The female organ is essentially a flask-shaped structure; the neck of the flask growing out as the trichogyne, and the belly composed of an axial carpogenic cell surrounded by investing cells, and with one cell (trichophoric) between it and the trichogyne. These three elements—trichogyne, trichophoric cell, and carpogenic cell—are regarded as the procarp. The spermatia have been shown by Thaxter to fuse with the trichogyne, after which the axial cell below (carpogenic cell) undergoes divisions, and ultimately forms asci containing ascospores, while cells investing this form a perithecium, the whole structure reminding us essentially of the fructification of a Pyrenomycete. Many modifications in details occur, and the plants may be dioecious. No injury is done to the infested insects. It has lately been shown that there is a fusion of nuclei in connexion with ascus formation, so that there can be no doubt of the position of this extraordinary group of plants among the Ascomycetes. The various cells of these organisms are connected by thick protoplasmic threads connecting one cell with the next. In this point and in their method of fertilization the Laboulbeniinae suggest a possible relationship of Ascomycetes and the Red Algae.

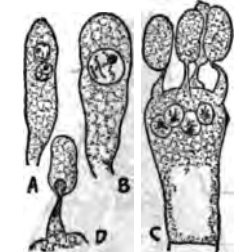

From Strasburger's *Lehrbuch der Botanik*, by permission of Gustav Fischer.

FIG. 15.—*Armillaria mellea*. (After Ruhland.)

- A, Young basidium with the two primary nuclei.
- B, After fusion of the two nuclei. *Hypoboloma appendiculatum*.
- C, A basidium before the four nuclei derived from the secondary nucleus of the basidium have passed into the four basidiospores.
- D, Passage of a nucleus through the sterigma into the basidiospore.

which later migrate respectively into the four basidiospores (fig. 15). The Basidiales are further characterized by the complete loss of normal sexuality, but at some time or other in the life-history there takes place an association of two nuclei in a cell; the two nuclei are derived from separate cells or possibly in some cases are sister nuclei of the same cell. The two nuclei when once associated are termed "conjugate" nuclei, and they always divide at the same time, a half of each passing into each cell. This conjugate condition is finally brought to a close by the nuclear fusion in the basidium. Between the nuclear association and the nuclear fusion in the basidium many thousands of cell generations may be intercalated.

This nuclear association of equivalent nuclei apparently represents a reduced sexual process (like the fusion of female nuclei in *Humaria granulata* and of vegetative nuclei in *H. rutilans*, among the Ascomycetes) in which, however, the actual fusion (normally, in a sexual process, occurring immediately after association) is delayed until the formation of the basidium. During the tetrad division in the basidium nuclear reduction occurs. There is thus in all the Basidiales an alternation of generations, obscured, however, by the apogamous transition from the gametophyte to sporophyte. The sporophyte may be considered to begin at the stage of nuclear association and end with the nuclear reduction in the basidium.

Uredineae.—This is a large group of about 2000 forms. They are all intercellular parasites living mostly on the leaves of higher plants. Owing to the presence of oily globules of an orange-yellow or rusty-red colour in their hyphae and spores they are termed Rust-Fungi. They are distinguished from the other fungi and the rest of the Basidiales by the great variety of the spores and the great elaboration of the life-history to be found in many cases. Five different kinds of spores may be present—teleutospores, sporidia (=basidiospores), aecidiospores, spermatia and uredospores (fig. 16). The teleutospore, with the sporidia which arise from it, is always present, and the division into genera is based chiefly on

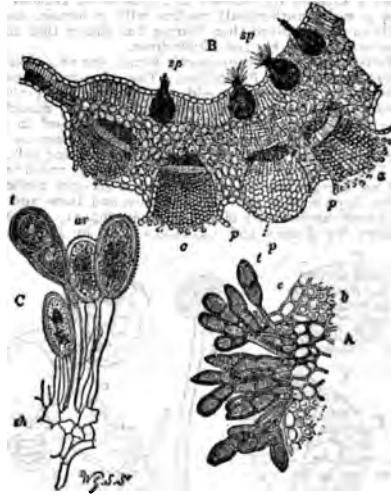

FIG. 16.—*Puccinia graminis*.

- A, Mass of teleutospores (*t*) on a leaf of couch-grass, with *s*, aecidium fruits, *p*, peridium, and *sp*, sporidia. (After Sachs.)
- B, Part of vertical section *sh*, sub-hyemal hyphae. (After De Bary.)
- C, Mass of uredospores (*ur*), with one teleutospore (*t*).
- D, Sub-epidermal fibres. (After De Bary.)
- E, Epidermis ruptured. (After De Bary.)
- F, Sub-epidermal fibres. (After De Bary.)

its characters. The teleutospore puts forth on germination a four-celled structure, the promycelium or basidium, and this bears later four sporidia or basidiospores, one on each cell. When the sporidia infect a plant the mycelium so produced gives origin to aecidiospores and spermatia; the aecidiospores on infection produce a mycelium which bears uredospores and later teleutospores. This is the life-history of the most complicated forms, of the so-called *eu* forms. In the *opsis* forms the uredospores are absent, the mycelium from the aecidiospores producing directly the teleutospores. In *brachy* and *hemi* the aecidiospores are absent, the mycelium from the sporidia giving origin directly to the uredospores; the former possess spermatia, in the latter they are absent. In *lepto* and *micro* forms both aecidiospores and uredospores are absent, the sporidia producing a mycelium which gives rise directly to teleutospores; in the *lepto* forms the teleutospores can germinate directly, in the *micro* forms only after a period of rest. We have thus a series showing a progressive reduction in the complexity of the life-history, the *lepto* and *micro* forms having a life-history like that of the Basidiomycetes. The *eu* and *opsis* forms may exhibit the remarkable phenomenon of heteroecism, i.e. the dependence of the fungus on two distinct host-plants for the completion of the life-history. Heteroecism is very common in this group and is now known in over one hundred and fifty species. In all cases of heteroecism the sporidia infect one host leading to the production of aecidiospores and spermatia (if present), while the aecidiospores are only able to infect another

host on which the uredospores (if present) and the teleutospores are developed. A few examples are appended:

Species.	Teleutospores on	Aecidiospores on
<i>Coleosporium Senecionis</i>	<i>Pinus</i>	<i>Senecio</i>
<i>Melanopus Rostkopi</i>	<i>Populus</i>	<i>Mecynialis</i>
<i>Pucciniastrum Goeppertiana</i>	<i>Vaccinium</i>	<i>Abies</i>
<i>Gymnosporangium Sabinae</i>	<i>Juniperus</i>	<i>Pyrus</i>
<i>Uromyces Pist</i>	<i>Pinus, etc.</i>	<i>Euphorbia</i>
<i>Puccinia graminis</i>	<i>Triticum, etc.</i>	<i>Berberis</i>
<i>P. dispersa</i>	<i>Socale, etc.</i>	<i>Anchusa</i>
<i>P. coronata</i>	<i>Agrostis</i>	<i>Rhamnus</i>
<i>P. Art-Phalaridis</i>	<i>Phalaris</i>	<i>Arum</i>
<i>P. Caricis</i>	<i>Carex</i>	<i>Urtica</i>
<i>Cronartium Ribicola</i>	<i>Ribes</i>	<i>Pinus</i>
<i>Chrysomyxa Rhododendri</i>	<i>Rhododendron</i>	<i>Picea</i>

Some of the Uredineae also exhibit the peculiarity of the development of biologic forms within a single morphological species, sometimes termed specialization of parasitism; this will be dealt with later under the section Physiology.

Cytology of Uredineae.—The study of the nuclear behaviour of the cells of the Uredineae has thrown great light on the question of sexuality. This group like the rest of the Basidiomycetes exhibits an association of nuclei at some point in its life-history, but unlike the case of the Basidiomycetes the point of association in the Uredineae is very well defined in all those forms which possess aecidiospores. We find thus that in the *es* and *obis* forms the association of nuclei takes place at the base of the aecidium which produces the aecidiospores. There we find an association of nuclei either by the fusion of two similar cells as described by Christmann or by the migration of the nucleus of a vegetative cell into a special cell of the aecidium. After this association the nuclei continue in the conjugate condition so that the aecidiospores, the uredospore-bearing mycelium, the uredospores and the young teleutospores all contain two paired nuclei in their cells (fig. 17). Before the teleutospore reaches maturity the nuclei fuse, and the uninucleate condition then continues again until aecidium formation. In the *hemi*, *brachy*, *micro* and *lepto* forms, which possess no aecidium, we find that the association takes place at various points in the ordinary mycelium but always before the formation of the uredospores in the *hemi* and *brachy* forms, and before the formation of teleutospores in the *micro* and *lepto* form. Whether the association of nuclei in the ordinary mycelium takes place by the migration of a nucleus from one cell to another or whether two daughter nuclei become conjugate in one cell, is not yet clear. The most reasonable interpretation of the spermatia is that they are abortive male cells. They have never been found to cause infection, and they have not the characters of conidia; the large size of their nuclei, the reduction of their cytoplasm and the absence of reserve material and their thin cell wall all point to their being male gametes. Although in the forms without aecidia the two generations are not sharply marked off from one another, we may look up the generation with single nuclei in the cells as the gametophyte and that with conjugate nuclei as the sporophyte. The subjoined diagram will indicate the relationship of the forms.

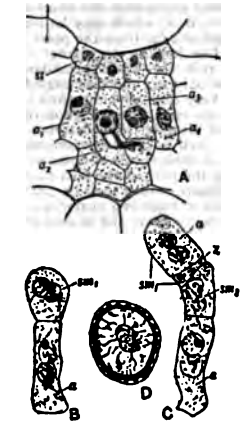

From Strasburger's *Lehrbuch der Botanik*, by permission of Gustav Fischer.
 FIG. 17.—*Phragmidium violaceum*. (After Blackman.)

- A. Portion of a young aecidium.
- a, Sterile cell
- a₁, Fertile cells; at a₁ the passage of a nucleus from the adjoining cell is seen.
- B. Formation of the first spore-mother-cell (*sm*) of one of the basal cells (*a*) of one of the rows of spores.
- C. A further stage in which from *sm*, the first aecidiospore (*a*) and the intercalary cell (*e*) have arisen.
- sm*₂, The second spore-mother-cell.
- D. Ripe aecidiospore.

infection, and they have not the characters of conidia; the large size of their nuclei, the reduction of their cytoplasm and the absence of reserve material and their thin cell wall all point to their being male gametes. Although in the forms without aecidia the two generations are not sharply marked off from one another, we may look up the generation with single nuclei in the cells as the gametophyte and that with conjugate nuclei as the sporophyte. The subjoined diagram will indicate the relationship of the forms.

Basidiomycetes.—This group is characterized by its greatly reduced life-history as compared with that of the *es* forms among the Uredineae. All the forms have the same life-history as the *lepto* forms of that group, so that there is no longer any trace of sexual organs. There is also a further reduction in that the basidium is not derived

from a teleutospore but is borne directly on the mycelium. Formerly, before the relationship of promycelium and basidium were understood, the Uredineae were considered as quite independent of the Basidiomycetes. Later, however, these Uredineae were placed as a mere subdivision of the Basidiomycetes, yet owing to their retaining clearly lead on to the Basidiomycetes, yet owing to their retaining in many cases definite traces of sexual organs they are clearly a more primitive group. Their marked parasitic habit also separates them off, so that they are best included with the Basidiomycetes in a larger cohort which may be called Basidiales. Most of Basidiomycetes are characterized by the large sporophore on which the basidia with its basidiospores are borne.

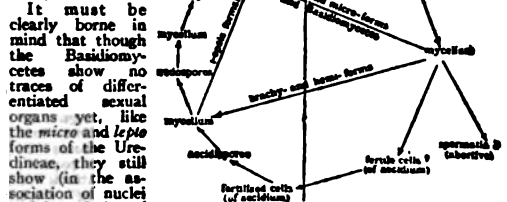

From *Annals of Botany*, by permission of the Clarendon Press.
 FIG. 18.

It must be clearly borne in mind that though the Basidiomycetes show no traces of differentiated sexual organs yet, like the *micro* and *lepto* forms of the Uredineae, they still show (in the association of nuclei and later fusion of nuclei in the basidium), a reduced fertilization which denotes their derivation, through the Uredineae, from more typically sexual forms. No one has yet made out in any form the exact way in which the association of nuclei takes place in the group. The mycelium is always found to contain conjugate nuclei before the formation of basidia, but the point at which the conjugate condition arises seems very variable. Miss Nichols finds that it occurs very soon after the germination of the spore in *Coprinus*, but no fusion of cells or migration of nuclei was to be observed.

Protobasidiomycetes.—This, by far the smaller division of Basidiomycetes, includes those forms which have a septate basidium. There are three families—Auriculariaceae, Pilacreaceae and Tremellinaceae.

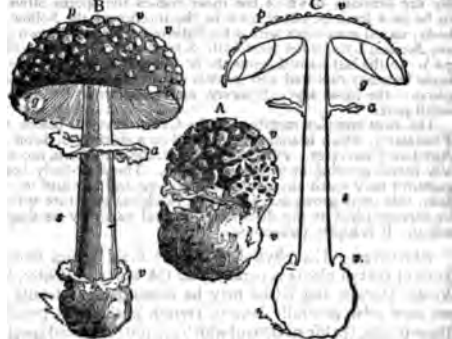

FIG. 19.—*Amanita muscaria*.
 A. The young plant.
 B. The mature plant. [plant.
 C. Longitudinal section of mature
 a, The *annulus*, or remnant of
 volva *partialis*.
 e, Remains of *volva* or *velum*
universale.
 p, The *pileus*.
 s, The stalk.

The first named contains a small number of forms with the basidium divided like the promycelium of the Uredineae. They are characterized by their gelatinous consistence and large size of their sporophore. *Hirneola (Auricularia) Auricularia-Judae* is the well-known Jew's Ear, so named from the resemblance of the sporophore to a human ear.

The Pilacreaceae are a family found by Brefeld to contain the genus *Pilacre*. *P. Petersii* has a transversely divided basidium as in Auriculariaceae, but the basidia are surrounded with a peridium-like sheath. The Tremellinaceae are characterized by the possession of basidia which are divided by two vertical walls at right angles to one another. From each of the four segments in the case of *Tremella* a long outgrowth arises which reaches to the surface of the hymenium

and bears the basidiospores. In *Dacryomyces* only two outgrowths and two spores are produced.

Autobasidiomycetes.—In this by far the larger division of the Basidiomycetes the basidia are undivided and the four basidiospores are borne on short sterigmata nearly always at the apex of the basidium. The group may be divided into two main divisions, *Hymenomycetes* and *Gasteromycetes*.

Hymenomycetes are a very large group containing over 11,000 species, most of which live in soil rich in humus or on fallen wood or stems, a few only being parasites. In the simplest forms (e.g. *Exobasidium*) the basidia are borne directly on the ordinary mycelium, but in the majority of cases the basidia are found developed in layers (hymenium) on special sporophores of characteristic form in the various groups. In these sporophores (such as the well-known toadstools and mushrooms where the ordinary vegetative mycelium is underground) we have structures specially developed for bearing the basidiospores and protecting them from rain, &c., and for the distribution of the spores—see earlier part of article on distribution of spores (figs. 19 and 20). The underground mycelium in many cases spreads wider and wider each year, often in a circular manner, and the sporophores springing from it appear in the form of a ring—the so-called fairy rings. *Armillaria melleus* and *Polyporus annosus* are examples of parasitic forms which attack and destroy living trees, while *Merulius lacrymans* is the well-known "dry rot" fungus.

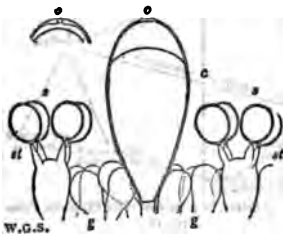

FIG. 20.—*Agaricus mucidus*. Portion of hymenium. *a*, Steridia; *b*, sterigmata; *c*, sterile cells; *e*, cystidium, closed sporophore or fruit-bodies which only open after the spores are with operculum *o*.

ripe and then often merely by a small pore. The fruit-bodies are of very various shapes, showing a differentiation into an outer peridium and an inner spore-bearing mass, the gleba. The gleba is usually differentiated into a number of chambers which are lined directly by the hymenium (basidial layer), or else the chambers contain an interwoven mass of hyphae, the branches of which bear the basidia. By the breaking down of the inner tissues the spores often come to lie as a loose powdery mass in the interior of the hollow fruit-body, mixed sometimes with a capillitium. The best-known genera are *Bonisia*, *Lycoperdon* (puff-ball) *Sclerotium*, *Geaster* (earth-star, &c.). In the last-named genus the peridium is double and the outer layer becomes ruptured and spreads out in the form of star-shaped pieces; the inner layer, however, merely opens at the apex by a small pore.

The most complex members of the Gasteromycetes belong to the *Phalloidaceae*, which is sometimes placed as a distinct division of the Autobasidiomycetes. *Phallus impudicus*, the stinkhorn, is occasionally found growing in woods in Britain. The fruit-body before it ruptures may reach the size of a hen's egg and is white in colour; from this there grows out a hollow cylindrical structure which can be distinguished at the distance of several yards by its disgusting odour. It is highly poisonous.

Physiology.—The physiology of the fungi comes under the head of that of plants generally, and the works of Pfeffer, Sachs, Vines, Darwin and Klebs may be consulted for details. But we may refer generally here to certain phenomena peculiar to these plants, the life-actions of which are restricted and specialized by their peculiar dependence on organic supplies of carbon and nitrogen, so that most fungi resemble the colourless cells of higher plants in their nutrition. Like these they require water, small but indispensable quantities of salts of potassium, magnesium, sulphur and phosphorus, and supplies of carbonaceous and nitrogenous materials in different stages of complexity in the different cases. Like these, also, they respire oxygen, and are independent of light; and their various powers of growth, secretion, and general metabolism, irritability, and response to external factors show similar specific variations in both cases. It is quite a mistake to suppose that, apart from the chlorophyll function, the physiology of the fungus-cell is fundamentally different from that of ordinary plant-cells. Nevertheless, certain biological phenomena in fungi are especially pronounced, and of these the following require particular notice.

Parasitism.—Some fungi, though able to live as saprophytes, occasionally enter the body of living plants, and are thus termed

facultative parasites. The occasion may be a wound (e.g. *Nectria*, *Dactyloctenium*, &c.), or the enfeeblement of the tissues of the host, or invigoration of the fungus, the mycelium of which then becomes strong enough to overcome the host's resistance (*Botrytis*). Many fungi, however, cannot complete their life-history apart from the host-plant. Such obligate parasites may be epiphytic (*Erysipheae*), the mycelium remaining on the outside and at most merely sending haustoria into the epidermal cells, or endophytic (*Uredineae*, *Ustilagineae*, &c.), when the mycelium is entirely inside the organs of the host. An epiphytic fungus is not necessarily a parasite, however, as many saprophytes (moulds, &c.) germinate and develop a loose mycelium on living leaves, but only enter and destroy the tissues after the leaf has fallen; in some cases, however, these saprophytic epiphytes can do harm by intercepting light and air from the leaf (*Fumago*, &c.), and such cases make it difficult to draw the line between saprophytism and parasitism. Endophytic parasites may be intracellular, when the fungus or its mycelium plunges into the cells and destroys their contents directly (*Olpidium*, *Lagenidium*, *Sclerotium*, &c.), but they are far more frequently intercellular, at any rate while young, the mycelium growing in the lacunae between the cells (*Peronospora*, *Uredineae*) into which it may send short (*Cystopus*), or long and branched (*Peronospora Galiothaeae*) haustoria, or it extends in the middle lamella (*Ustilago*), or even in the solid substance of the cell-wall (*Botrytis*). No sharp lines can be drawn, however, since many mycelia are intercellular at first and subsequently become intracellular (*Ustilagineae*), and the various stages doubtless depend on the degrees of resistance which the host tissues are able to offer. Similar gradations are observed in the direct effect of the parasite on the host, which may be local (*Hemileia*) when the mycelium never extends far from the point of infection, or general (*Phytophthora*) when it runs throughout the plant. Destructive parasites rapidly ruin the whole plant-body (*Pythium*), whereas restrained parasites only tax the host slightly, and ill effects may not be visible for a long time, or only when the fungus is epidemic (*Rhizium*). A parasite may be restricted during a long incubation-period, however, and rampant and destructive later (*Ustilago*). The latter fact, as well as the extraordinary fastidiousness, so to speak, of parasites in their choice of hosts or of organs for attack, point to reactions on the part of the host-plant, as well as capacities on that of the parasite, which may be partly explained in the light of what we now know regarding enzymes and chemotropism. Some parasites attack many hosts and almost any tissue or organ (*Botrytis cinerea*), others are restricted to one family (*Cystopus candidus*) or genus (*Phytophthora infestans*) or even species (*Pucciniastrum Padi*), and it is customary to speak of root-parasites, leaf-parasites, &c., in expression of the fact that a given parasite occurs only on such organs—e.g. *Dematiophora necatrix* on roots, *Calyptospora Goepfertiana* on stems, *Ustilago Scabiosae* in anthers, *Claviceps purpurea* in ovaries, &c. Associated with these relations are the specializations which parasites show in regard to the age of the host. Many parasites can enter a seedling, but are unable to attack the same host when older—e.g. *Pythium*, *Phytophthora omnivora*.

Chemotropism.—Taken in conjunction with Pfeffer's beautiful discovery that certain chemicals exert a distinct attractive influence on fungus hyphae (*chemotropism*), and the results of Miyoshi's experimental application of it, the phenomena of enzyme-secretion throw considerable light on the processes of infection and parasitism of fungi. Pfeffer showed that certain substances in definite concentrations cause the tips of hyphae to turn towards them; other substances, though not in nutritive, repel them, as also do nutritive bodies if too highly concentrated. Marshall Ward showed that the hyphae of *Botrytis* pierce the cell-walls of a lily by secreting a cyase and dissolving a hole through the membrane. Miyoshi then demonstrated that if *Botrytis* is sown in a lamella of gelatine, and this lamella is superposed on another similar one to which a chemotropic substance is added, the tips of the hyphae at once turn from the former and enter the latter. If a thin cellulose membrane is interposed between the lamellae, the hyphae nevertheless turn chemotropically from the one lamella to the other and pierce the cellulose membrane in the process. The hyphae will also dissolve their way through a lamella of collodion, paraffin, parchment paper, elder-pith, or even cork or the wing of a fly, to do which it must secrete very different enzymes. If the membrane is of some impermeable substance, like gold leaf, the hyphae cannot dissolve its way through, but the tip finds the most minute pore and traverses the barrier by means of it, as it does a stoma on a leaf. We may hence conclude that a parasitic hyphae pierces some plants or their stomata and refuses to enter others, because in the former case there are chemotropically attractive substances present which are absent from the latter, or are there replaced by repellent poisonous or protective substances such as enzymes or antitoxins.

Specialization of Parasitism.—The careful investigations of recent years have shown that in several groups of fungi we cannot be content to distinguish as units morphologically different species, but we are compelled to go deeper and analyse further the species. It has been shown especially in the *Uredineae* and *Erysiphaceae* that many forms which can hardly be distinguished morphologically, or which cannot be differentiated at all by structural characters, are not really homogeneous but consist of a number of forms which are

sharply distinguishable by their infecting power. Eriksson found, for example, that the well-known species *Puccinia graminis* could be split up into a number of forms which though morphologically similar were physiologically distinct. He found that the species really consisted of six distinct races, each having a more or less narrow range of grasses on which it can live. The six races he named *P. graminis Secalis*, *Triticis*, *Avenae*, *Aivae*, *Agrostis*, *Poa*. The first named will grow on rye and barley but not on wheat or oat. The form *Triticis* is the least sharply marked and will grow on wheat, barley, rye and oat but not on the other grasses. The form *Avenae* will grow on oat and many grasses but not on the other three cereals mentioned. The last three forms grow only on the genera *Aira*, *Agrostis* and *Poa* respectively. All these forms have of course their acidium-stage on the barberry. The terms biologic forms, biological species, physiological species, physiological races, specialized forms have all been applied to these; perhaps the term biologic forms is the most satisfactory. A similar specialization has been observed by Marshall Ward in the *Puccinia* parasitic on species of *Bromus*, and by Neger, Marchal and especially Salmon in the Erysiphaceae. In the last-named family the single morphological species *Erysiphe graminis* is found growing on the cereals, barley, oat, wheat, rye and a number of wild grasses (such as *Poa*, *Bromus*, *Dactylis*). On each of these host-plants the fungus has become specialized so that the form on barley cannot infect the other three cereals or the wild grasses and so on. Just as the uredospores and aecidiospores both show these specialized characters in the case of *Puccinia graminis* so we find that both the conidia and ascospores of *E. graminis* show this phenomenon. Salmon has further shown in investigating the relation of *E. graminis* to various species of the genus *Bromus*, that certain species may act as "bridging species," enabling the transfer of a biologic form to a host-plant which it cannot normally infect. Thus the biologic form on *B. racemosus* cannot infect *B. commutatus*. It, however, conidia from *B. racemosus* are sown on *B. hordeaceus*, the conidia which develop on that plant are now able to infect *B. commutatus*; thus *B. hordeaceus* acts as a bridging species. Salmon also found that injury of a leaf by mechanical means, by heat, by anaesthetics, &c., would affect the immunity of the plant and allow infection by conidia which was not able to enter a normal leaf. The effect of the abnormal conditions is probably to stop the production of, or weaken or destroy the protective enzymes or antitoxins, the presence of which normally confers immunity on the leaf.

Symbiosis.—The remarkable case of life in common first observed in lichens, where a fungus and an alga unite to form a compound organism—the lichen—totally different from either, has now been proved to be universal in these plants, and lichens are in all cases merely algae enmeshed in the interwoven hyphae of fungi (see LICHENS). This dualism, where the one constituent (alga) furnishes carbohydrates, and the other (fungus) ensures a supply of mineral matters, shade and moisture, has been termed *symbiosis*. Since then numerous other cases of symbiosis have been demonstrated. Many trees are found to have their smaller roots invaded by fungi and deformed by their action, but so far from these being injurious, experiments go to show that this mycorrhiza (fungus-root) is necessary for the well-being of the tree. This is also the case with numerous other plants of moors and woodlands—e.g. Ericaceae, Pyrolaceae, Gentianaceae, Orchidaceae, ferns, &c. Recent experiments have shown that the difficulties of getting orchid seeds to germinate are due to the absence of the necessary fungus, which must be in readiness to infect the young seedling immediately it emerges from the seed. The well-known failures with rhododendrons, heaths, &c., in ordinary garden soils are also explained by the need of the fungus-infected peat for their roots. The rôle of the fungus appears to be to supply materials from the leaf-mould around, in forms which ordinary root-hairs are incapable of providing for the plant; in return the latter supports the fungus at slight expense from its abundant stores of reserve materials. Numerous other cases of symbiosis have been discovered among the fungi of fermentation, of which those between *Aspergillus* and yeast in salt manufacture, and between yeasts and bacteria in kefir and in the ginger-beer plant are best worked out. For cases of symbiosis see BACTERIOLOGY.

AUTHORITIES.—General: Engler and Prantl, *Die natürlichen Pflanzenfamilien*, i. Teil (1892 onwards); Zopf, *Die Pilze* (Breslau, 1890); De Bary, *Comparative Morphology of Fungi*, &c. (Oxford, 1887); von Tafel, *Vergleichende Morphologie der Pilze* (Jena, 1892); Brefeld, *Unters. aus dem Gesamtgebiete der Mykologie*, Heft 1: 13 (1872-1905); Lotsy, *Vorträge über botanische Stammesgeschichte* (Jena, 1907); *Distribution*, &c.; Cooke, *Introduction to the Study of Fungi* (London, 1895); Feix in *Zeitschr. d. deutsch. geologisch. Gesellsch.* (1894-1896); Staub, *Sitzungsber. d. bot. Sec. d. Kgl. ungarischen naturwiss. Gesellsch. zu Budapest* (1897). *Anatomy*, &c.: Bommer, "Sclerotes et cordons mycéliens," *Mém. de l'Acad. Roy. de Belg.* (1894); Mangin, "Observ. sur la membrane des mucorinées," *Journ. de Bot.* (1899); Zimmermann, *Die Morph. und Physiologie des Pflanzenzellkernes* (Jena, 1896); Wisslingh, "Microchem. Unters. über die Zellwände d. Fungi," *Pringsh. Jahrb.* B. 37, p. 619 (1898); Istvanilvi, "Unters. über die phys. Anat. der Pilze," *Pringsh. Jahrb.* (1896). *Spore Distribution*: Fulton, "Dispersal of the Spores of Fungi by Insects," *Ann. Bot.* (1889); Falck, "Die Sporenverbreitung bei den Basidiomyceten," *Beitr.*

zur Biol. d. Pflanzen, ix. (1904). *Spores and Sporophores*: Zopf, *Die Pilze*; also the works of von Tafel and Brefeld. *Classification*: van Tieghem, *Journ. de bot.* p. 77 (1893), and the works of Brefeld, Engler and Prantl, von Tafel, Saccardo and Lotsy already cited. *Oomyces*: Wager, "On the Fertilization of *Peronospora parasitica*," *Ann. Bot.* vol. xiv. (1900); Stevens, "The Compound Oosphere of *Albugo Bliii*," *Bot. Gaz.* vol. 28 (1899); "Gametogenesis and Fertilization in *Albugo*," *ibid.* vol. 32 (1901); Miyake, "The Fertilization of *Pythium d. Baryanum*," *Ann. of Bot.* vol. xv. (1901); Trow, "On Fertilization in the Saprolegniae," *Ann. of Bot.* vol. xviii. (1904); Thaxter, "New and Peculiar Aquatic Fungi," *Bot. Gaz.* vol. 20 (1895); Lagerheim, "Unters. über die Monoblepharideae," *Bih. Svenska Vet. Akad. Handlingar*, 25. Afd. iii. (1900); Woronin, "Beitrag zur Kenntnis der Monoblepharideen," *Mém. de l'Acad. Imp. d. Sc. de St.-Petersbourg*, 8 sér. vol. 16 (1902). *Zygomycetes*: Harper, "Cell-division in Sporangia and Asci," *Ann. Bot.* vol. xiii. (1899); Klebs, *Die Bedingungen der Pflanzung*, &c. (Jena, 1896); and "Zur Physiologie des Fortpflanzung," *Pringsh. Jahrb.* (1898 and 1899); "Über *Sporodinia grandis*," *Bot. Zeit.* (1902); Falck, "Die Bedingungen der Zygotenbildung bei *Sporodinia grandis*," *Cohn's Beitr. z. Biol. d. Pflanzen*, Bd. 8 (1902); Gruber, "Verhalten der Zellerne in den Zygosporien von *Sporodinia grandis*," *Ber. d. deutschen bot. Ges.* Bd. 19 (1901); Blakeslee, "Sexual Reproduction in the Mucorineae," *Proc. Am. Acad.* (1904); "Zygospor germination in the Mucorineae," *Ann. mycologici* (1906). *Ustilagineae*: Plowright, *British Uredineae and Ustilagineae* (London, 1889); Mance, *British Fungi* (Phycomycetes and Ustilagineae) (London, 1891); Brefeld, *Unters. aus dem Gesamtgeb. der Mykol.* Hefte xi. and xii.; and Falck, "Die Blüteninfektion bei den Brandpilzen," *ibid.* Heft xiii. 1905; Dangeard, "La Reproduction sexuelle des Ustilagineae," *C.R.*, Oct. 9, 1893; Maire, "Recherches cytologiques et taxonomiques sur les Basidiomycètes," *Annexé au Bull. de la Soc. Mycol. de France* (1902). *Saccharomycetaceae*: Jorgensen, *The Micro-organisms of Fermentation* (1899); Barker, *Ann. of Bot.* vol. xiv. (1901); "On Sporulation among the Saccharomycetes," *Journ. of the Fed. Institute of Brewing*, vol. 8 (1902); Guillemerod, *Recherches cytologiques sur les levures* (Paris, 1902); Hansen, *Centralbl. f. Bakt. u. Parasitenk.* Abt. II, Bd. 12 (1904). *Exozoa*: Guesenhop, "The phrynia, *Exozoa*, *Magnusiella*" (complete literature given), *Bot. Zeit.* Bd. 7 (1901). *Erysiphaceae*: Harper, "Die Entwicklung des Perithecium bei *Sphaerotheca castagnei*," *Ber. d. deut. bot. Ges.* (1896); "Sexual Reproduction and the Organization of the Nucleus in certain Mildews," *Publ. Carnegie Institution* (Washington, 1906); Blackman & Fraser, "Fertilization in *Sphaerotheca*," *Ann. of Bot.* (1905). *Perisporiaceae*: Brefeld, *Untersuchungen aus dem Gesamtgeb. der Mykol.* Heft 10 (1891); Fraser and Chamber, *Annuaire mycologique* (1907). *Discomycetes*: Harper, "Über das Verhalten der Kerne bei Ascomyceten," *Jahr. f. wiss. Bot.* 29 (1890); "Sexual Reproduction in *Pyrenopeziza confusae*," *Ann. of Bot.* 14 (1900); Clausen, "Zur Entw. der Ascomyceten," *Boudiera, Bot. Zeit.* Bd. 63 (1905); Dangeard, "Sur le *Pyrenopeziza confusae*," *Le Botaniste*, 9 série (1903) (and numerous papers in same journal earlier and later); Ramlow, "Zur Entw. von *Theobolus stercorae*," *Bot. Zeit.* (1906); Woronin, "Über die Sclerotienkrankheit der Vaccinæ Beeren," *Mém. de l'Acad. Imp. des Sciences de St.-Petersbourg*, 7 série, 36 (1888); Dietrich, "Zur Entwicklungsgeschichte der Helvelliden," *Cohn's Beitr. z. Biol. d. Pflanzen* (1892). *Pyrenomyces*: Fisch, "Beitr. z. Entwicklungsgeschichte einiger Ascomyceten," *Bot. Zeit.* (1882); Frank, "Über einige neue u. weniger bekannte Pflanzenkrankh.," *Landw. Jahrb.* Bd. 12 (1883); Ward, "Onygena aquina, a horn-destroying fungus," *Phil. Trans.* vol. 191 (1890); Dawson, "On the Biology of *Poronia punctata*," *Ann. of Bot.* 14 (1900). *Tuberineae*: Buchholz, "Zur Morphologie u. Systematik der Fungi hypogaei," *Ann. Mycol.* Bd. 1 (1903); Fischer in Engler and Prantl, *Die natürlichen Pflanzenfamilien* (1896). *Laboulbeniaceae*: Thaxter, "Monograph of the Laboulbeniaceae," *Mem. Amer. Acad. of Arts and Sciences*, vol. 12 (1895). *Uredineae*: Eriksson and Henning, *Die Getreideroste* (Stockholm, 1896); Eriksson, *Botan. Gaz.* vol. 25 (1896); "On the Vegetative Life of some Uredineae," *Ann. of Bot.* (1905); Klebahn, *Die wirt. wechselnden Rostpilze* (Berlin, 1904); Sapin-Trouffy, "Recherches histologiques sur la famille des Uredines," *Le Botaniste* (1896-1897); Blackman, "On the Fertilization, Alternation of Generations and General Cytology of the Uredineae," *Ann. of Bot.* vol. 18 (1904); Blackman and Fraser, "Further Studies on the Sexuality of Uredineae," *Ann. of Bot.* vol. 20 (1906); Christman, "Sexual Reproduction of Rusts," *Ann. of Bot.* vol. 20 (1906); Ward, "The Brooms and their Rust Fungus," *Ann. of Bot.* vol. 15 (1901). *Basidiomycetes*: Dangeard, "La Reprod. sexuelle des Basidiomycètes," *Le Botaniste* (1894 and 1900); Maire, "Recherches cytologiques et taxonomiques sur les Basidiomycètes," *Annexé au Bull. de la Soc. Mycol. de France* (1902); Müller, "Protobasidiomyceten," *Schimper's Mitt. aus den Tropen*, Heft 8 (Jena, 1895); Nichols, "The Nature and Origin of the Binucleated Cells in certain Basidiomycetes," *Trans. Wisconsin Acad. of Sciences*, vol. 15 (1905); Wager, "The Sexuality of the Fungi," *Ann. of Bot.* 13 (1899); Woronin, "Exobasidium Vaccinii," *Verh. Naturf. Ges. zu Freiburg*, Bd. 4 (1867). *Fermentation*: Buchner, "Gährung ohne Hefezellen," *Bot. Zeit.* Bd. 18 (1898); Albert, *Cent. f. Bakt.* Bd. 17 (1900).

Green, *The Soluble Ferments and Fermentation* (Cambridge, 1899); *Parasitism*: "On some Relations between Host and Parasite," *Proc. Roy. Soc.* vol. 47 (1890); "A Lily Disease," *Ann. of Botany*, vol. 2 (1888); Eriksson & Hennings, *Die Getreiderost* (vide *supra*); Ward, "On the Question of Predisposition and Immunity in Plants," *Proc. Cambridge Phil. Soc.* vol. 11 (1902); also *Annals of Bot.* vol. 16 (1902) and vol. 19 (1905); Neger, "Beitr. z. Biol. d. Erysipheer," *Flora*, Bde. 88 and 90 (1901-1902); Salmon, "Cultural Experiments with 'Biologic Forms' of the Erysiphaceae," *Phil. Trans.* (1904); "On Erysiphe graminis and its adaptive parasitism within the genus *Bromus*," *Ann. Mycol.* vol. 11 (1904); also *Ann. of Bot.* vol. 19 (1905). *Symbiosis*: Ward, "The Ginger-Beer Plant," *Phil. Trans. Roy. Soc.* (1892); "Symbiosis," *Ann. of Bot.* 13 (1899); Shalk, "Der Sinn der Mykorrhizenbildung," *Jahrb. f. wiss. Bot.* Bd. 34 (1900); Bernard, "On some Different Cases of Germination," *Gardener's Chronicle* (1900); Pierce, *Publ. Univ. California* (1900). (H. M. W.; V. H. B.)

FUNJ (FUNNIYER, FUNG, FUNGHA), a very mixed negroid race, occupying parts of Sennar and the hilly country to the south between the White and Blue Niles. They traditionally come from west of the White Nile and are affiliated by some to the Kordofan Nubas, by others, more justifiably, to the negro Shilluks. These Funj, who became the dominant race in Sennar in the 15th century, almost everywhere assimilated the speech, religion and habits of the Arabs settled in that region. Until the 19th century they were one of the most powerful of African peoples in the eastern Sudan. About the end of the 15th century they overthrew the kingdom of Aloa, between the two Niles, and conquered the neighbouring peoples of the Sudan, Nubia and even Kordofan. The Funj had mixed much with the Arabs before their conquests, and had been converted to Islam. But they were still in many ways savages, for James Bruce (who traversed the district in 1772) says that their most famous king, Malek-el-Gahman, preferred human liver to any other food, and the Belgian traveller E. Prussenaere (1826-1864) found them still performing pagan rites on their sacred Mount Gula. Ernst Marno declared that as late as 1870 the most southern branch of the race, the Boruns, a non-Arabic speaking tribe, were cannibals. The Funj kings were content with levying tribute on their neighbours, and in this loose way Shendi, Berber and Dongola were once tributary. The Arab viziers gradually absorbed all power, the Funj sovereignty becoming nominal; and in 1821 the Egyptians easily destroyed the Funj domination. To-day the Funj are few, and represent no real type. They are a bright, hospitable folk. Many of them are skilful surgeons and go far afield in their work. The fellahin, indeed, call surgeons "Senaari" (men of Sennar). See further SENNAR and SUDAN (Anglo-Egyptian).

FUNKIA, in botany, a genus of rather handsome, hardy, herbaceous plants belonging to the natural order Liliaceae, and natives of China and Japan. They are tuberous, with broadly ovate or heart-shaped leaves and racemes of white or pale lilac, drooping, funnel-shaped flowers. They are useful for the borders of a shrubbery, the lawn or rock-work, or may be grown in pots for the greenhouse. The plants are propagated by dividing the crowns in autumn or when growth begins in spring.

FUNNEL (through an O. Fr. *founil*, found in Breton, from Lat. *infundibulum*, that through which anything is poured, from *fundere*, to pour), a vessel shaped like a cone having a small tube at the apex through which powder, liquid, &c., may be easily passed into another vessel with a small opening. The term is used in metal-casting of the hole through which the metal is poured into a mould, and in anatomy and zoology of an *infundibulum* or funnel-shaped organ. The word is thus used generally of any shaft or passage to convey light, air or smoke, as of the chimney of an engine or a steam-boat, or the flue of an ordinary chimney. It is also used of a shaft or channel in rocks, and in the decoying of wild-fowl is applied to the cone-shaped passage leading from a pond and covered with a net, a "funnel-net," into which the birds are decoyed.

FUR (connected with O. Fr. *forre*, a sheath or case; so "an outer covering"), the name specially given to the covering of the skin in certain animals which are natives of the colder climates, lying alongside of another and longer covering, called

the overhair. The fur differs from the overhair, in that it is soft, silky, curly, downy and barbed lengthwise, while the overhair is straight, smooth and comparatively rigid. These properties of fur constitute its essential value for felting purposes, and mark its difference from wool and silk; the first, after some slight preparation by the aid of hot water, readily unites its fibres into a strong and compact mass; the others can best be managed by spinning and weaving.

On the living animal the overhair keeps the fur filaments apart, prevents their tendency to felt, and protects them from injury—thus securing to the animal an immunity from cold and storm; while, as a matter of fact, this very overhair, though of an humbler name, is most generally the beauty and pride of the pelt, and marks its chief value with the furrier. We arrive thus at two distinct and opposite uses and values of fur. Regarded as useful for felt it is denominated staple fur, while with respect to its use with and on the pelt it is called fancy fur.

History.—The manufacture of fur into a felt is of comparatively modern origin, while the use of fur pelts as a covering for the body, for the couch, or for the tent is coeval with the earliest history of all northern tribes and nations. Their use was not simply a barbarous expedient to defend man from the rigours of an arctic winter; woven wool alone cannot, in its most perfect form, accomplish this. The pelt or skin is requisite to keep out the piercing wind and driving storm, while the fur and overhair ward off the cold; and "furs" are as much a necessity to-day among more northern peoples as they ever were in the days of barbarism. With them the providing of this necessary covering became the first purpose of their toil; subsequently it grew into an object of barter and traffic, at first among themselves, and afterwards with their neighbours of more temperate climes; and with the latter it naturally became an article of fashion, of ornament and of luxury. This, in brief, has been the history of its use in China, Tataria, Russia, Siberia and North America, and at present the employment of fancy furs among civilized nations has grown to be more extensive than at any former period.

The supply of this demand in earlier times led to such severe competition as to terminate in tribal pillages and even national wars; and in modern times it has led to commercial ventures on the part of individuals and companies, the account of which, told in its plainest form, reads like the pages of romance. Furs have constituted the price of redemption for royal captives, the gifts of emperors and kings, and the peculiar badge of state functionaries. At the present day they vie with precious gems and gold as ornaments and garniture for wealth and fashion; but by their abundance, and the cheapness of some varieties, they have recently come within the reach of men of moderate incomes. The history of furs can be read in Marco Polo, as he grows eloquent with the description of the rich skins of the khan of Tataria; in the early fathers of the church, who lament their introduction into Rome and Byzantium as an evidence of barbaric and debasing luxury; in the political history of Russia, stretching out a powerful arm over Siberia to secure her rich treasures; in the story of the French occupation of Canada, and the ascent of the St. Lawrence to Lake Superior, and the subsequent contest to retain possession against England; in the history of early settlements of New England, New York and Virginia; in Irving's *Astoria*; in the records of the Hudson's Bay Company; and in the annals of the fairs held at Nizhny Novgorod and Leipzig. Here it may suffice to give some account of the present condition of the trade in fancy furs. The collection of skins is now chiefly a matter of private enterprise. Few, if any, monopolies exist.

Natural Supplies.—We are dependent upon the Carnivora, Rodentia, Ungulata and Marsupialia for our supplies of furs, the first two classes being by far of the greatest importance. The Carnivora include bears, wolverines, wolves, raccoons, foxes, sables, martens, skunks, kolinskis, fish, tigers, ermines, cats, sea otters, fur seals, hair seals, lions, fishers, leopards, lynxes, jackals, &c. The Rodentia include beavers, nutrias, musk-rats or musquash, marmots, hamsters, chinchillas, hares, rabbits, squirrels, &c. The Ungulata include Persian, Astrachan, Crimæan,

Chinese and Tibet lambs, mouflon, guanaco, goats, ponies, &c. The Marsupialia include opossums, wallabies and kangaroos. These, of course, could be subdivided, but for general purposes of the fur trade the above is deemed sufficient.

The question frequently arises, not only for those interested in the production of fur apparel, but for those who derive so much comfort and pleasure from its use, whether the supply of fur-bearing animals is likely to be exhausted. Although it is a fact that the demand is ever increasing, and that some of the rarer animals are decreasing in numbers, yet on the other hand some kinds of furs are occasionally neglected through vagaries of fashion, which give nature an opportunity to replenish their source. These respites are, however, becoming fewer every day, and what were formerly the most neglected kinds of furs are becoming more and more sought after. The supply of some of the most valuable, such as sable, silver and natural black fox, sea otter and ermine, which are all taken from animals of a more or less shy nature, does very gradually decrease with persistent hunting and the encroachment of man upon the districts where they live, but the climate of these vast regions is so cold and inhospitable that the probabilities of man ever permanently inhabiting them in numbers sufficient to scare away or exterminate the fur-bearing wild animals is unlikely. Besides these there are many useful, though commonplace, fur-bearing animals like mink, musquash, skunk, raccoon, opossum, hamster, rabbit, hares and moles, that thrive by depredations upon cultivated land. Some of these are reared upon extensive wild farms. In addition there are domestic fur-bearing animals, such as Persian, Astrachan and Chinese lambs, and goats, easily bred and available.

With regard to the rearing of the Persian lamb, there is a prevalent idea that the skins of the unborn lamb are frequently used; this, however, is a mistake. A few such skins have been taken, but they are too delicate to be of any service. The youngest, known as "broadtails," are killed when a few days old, but for the well-developed curly fur, the lambs must be six or seven weeks old. During these weeks their bodies are covered with leather so that the fur may develop in close, light and clean curls. The experiment has been tried of rearing rare, wild, fur-bearing animals in captivity, and although climatic conditions and food have been precisely as in their natural environment, the fur has been poor in quality and bad in colour, totally unlike that taken from animals in the wild state. The sensation of fear or the restriction of movement and the obtaining of food without exertion evidently prevent the normal development of the creature.

In mountainous districts in the more temperate zones some good supplies are found. Chinchillas and nutrias are obtained from South America, whence come also civet cats, jaguars, ocelots and pumas. Opossums and wallabies, good useful furs, come from Australia and New Zealand. The martens, foxes and otters imported from southern Europe and southern Asia, are very mixed in quality, and the majority are poor compared with those of Canada and the north.

Certain characteristics in the skin reveal to the expert from what section of territory they come, but in classifying them it is considered sufficient to mention territories only.

Some of the poorer sorts of furs, such as hamster, marmot, Chinese goats and lambs, Tatar ponies, weasels, kaluga, various monkeys, antelopes, foxes, otters, jackals and others from the warmer zones, which until recently were neglected on account of their inferior quality of colour, by the better class of the trade, are now being deftly dressed or dyed in Europe and America, and good effects are produced, although the lack of quality when compared with the better furs from colder climates which possess full top hair, close underwool and supple leathers, is readily manifest. It is only the pressure of increasing demand that makes marketable hard pelts with harsh brittle hair of nondescript hue, and these would, naturally, be the last to attract the notice of dealers.

As it is impossible that we shall ever discover any new fur-bearing animals other than those we know, it behoves responsible authorities to enforce close seasons and restrictions, as to the

sex and age, in the killing for the purpose of equalizing the numbers of the catches. As evidence of indiscriminate slaughter the case of the American buffaloes may be cited. At one time thousands of buffalo skins were obtainable and provided material for most useful coats and rugs for rough wear in cold regions, but to-day only a herd or so of the animals remain, and in captivity.

The majority of animals taken for their fur are trapped or snared, the gun being avoided as much as possible in order that the coat may be quite undamaged. Many weary hours are spent in setting baits, traps and wires, and, frequently, when the hunter retraces his steps to collect the quarry it is only to find it gone, devoured by some large animal that has visited his traps before him. After the skins have been carefully removed—the sooner after death the better for the subsequent condition of the fur—they are lightly tacked out, pelt outwards, and, without being exposed to the sun or close contact with a fire, allowed to dry in a hut or shady place where there is some warmth or movement of air. With the exception of sealskins, which are pickled in brine, all raw skins come to the various trade markets simply dried like this.

Quality and Colour.—The best fur is obtained by killing animals when the winter is at its height and the colder the season the better its quality and colour. Fur skins taken out of season are indifferent, and the hair is liable to shed itself freely; a good furrier will, however, reject such faulty specimens in the manufacturing. The finest furs are obtained from the Arctic and northern regions, and the lower the latitude the less full and silky the fur, till, at the torrid zone, fur gives place to harsh hair without any underwool. The finest and closest wools are possessed by the amphibious Carnivora and Rodentia, viz. seals, otters, beavers, nutrias and musquash, the beauty of which is not seen until after the stiff water or top hairs are pulled out or otherwise removed. In this class of animal the underneath wool of the belly is thicker than that of the back, while the opposite is true of those found on the land. The sea otter, one of the richest and rarest of furs, especially for men's wear, is an exception to this unhairing process, which it does not require, the hair being of the same length as the wool, silky and bright, quite the reverse of the case of other aquatic animals.

Of sealskins there are two distinct classes, the fur seals and the hair seals. The latter have no growth of fur under the stiff top hair and are killed, with few exceptions (generally of the marbled seals), on account of the oil and leather they yield. The best fur seals are found off the Alaska coast and down as far south as San Francisco.

It is found that in densely wooded districts furs are darker in colour than in exposed regions, and that the quality of wool and hair is softer and more silky than those from bare tracts of country, where nature exacts from its creatures greater efforts to secure food, thereby developing stronger limbs and a consequently coarser body covering.

As regards density of colour the skunk or black marten has the blackest fur, and some cats of the domestic kind, specially reared for their fur, are nearly black. Black bears have occasionally very black coats, but the majority have a brownish underwool. The natural black fox is a member of the silver fox family and is very rare, the skins bringing a high price. Most silver foxes have dark necks and in some the dark shade runs a quarter, half-way, or three-quarters, or even the whole length of the skin, but it is rather of a brownish hue. Some Russian sables are of a very dense bluish brown almost a black, which is the origin undoubtedly of the term "sables," while some, from one district in particular, have a quantity of silver hairs, evenly interspersed in the fur, a peculiarity which has nothing to do with age. The best sea otters have very dark coats which are highly esteemed, a few with silver hairs in parts; where these are equally and evenly spread the skins are very valuable. Otters and beavers that run dark in the hair or wool are more valuable than the paler ones, the wools of which are frequently touched with a chemical to produce a golden shade. This is also done with nutrias after unhairing. The darker sorts of mink,

musquash, raccoon and wolverine are more valuable than the peler skins.

Collective Supplies and Sales.—There are ten large American and Canadian companies with extensive systems for gathering the annual hauls of skins from the far-scattered trappers. These are the Hudson's Bay Co., Russian Fur Co., Alaska Commercial Co., North American Commercial Co., Russian Sealskin Co., Harmony Fur Co., Royal Greenland Fur Co., American Fur Co., Missouri Co. and Pacific Co. Most of the raw skins are forwarded to about half-a-dozen brokers in London, who roughly sort them in convenient lots, issuing catalogues to the traders of the world, and after due time for examination of the goods by intending purchasers, the lots are sold by public auction. The principal sales of general furs are held in London in January and March, smaller offerings being made in June and October; while the bulk of fur sealskins is sold separately in December. The Hudson's Bay Co.'s sales take place before the others, and, as no reserves are placed on any lot, the results are taken as exactly indicating current values. While many buyers from America and Russia are personally in attendance at the sales, many more are represented by London and Leipzig agents who buy for them upon commission. In addition to the fur skins coming from North America vast numbers from Russia, Siberia, China, Japan, Australia and South America are offered during the same periods at public auction. Fairs are also held in Siberia, Russia and Germany for the distribution of fur skins as follows:—

January:	Frankfort-on-the-Oder	Small collection of provincial produce, such as otter, fox, fitch and marten.
February:	Irbit, Siberia	General Russian furs.
Easter:	Leipzig, Germany	General furs.
August:	Nizhny Novgorod, Russia	Persian lamb and general furs.
August:	Kiakhta, Siberia	Chinese furs and ermine.
December:	Ishim, Siberia	Chiefly squirrels.

Of course there are many transactions, generally in the cheaper and coarser kinds of furs, used only in central Europe, Russia and Asia which in no way interest the London market, and there are many direct consignments of skins from collectors in America and Russia to London, New York and Leipzig merchants. But the bulk of the fine furs of the world is sold at the large public trade auction sales in London. The chief exceptions are the Persian and Astrachan lambs, which are bought at the Russian fairs, and are dressed and dyed in Leipzig, and the ermine and Russian squirrels, which are dressed and manufactured into linings either in Russia or Germany before offered for sale to the wholesale merchants or manufacturers.

The annual collection of fur skins varies considerably in quantity according to the demand and to the good or bad climatic conditions of the season; and it is impossible to give a complete record, as many skins are used in the country of their origin or exported direct to merchants. But a fairly exact statement of the numbers sold in the great public trade auction sales in London during the year 1905-1906 is herewith set out.

Year ending 31st of March 1906. Total Number of Skins

Badger	28,634
Badger, Japanese	6,026
Bear	18,576
Beaver	80,514
Cat, Civet	157,915
Cat, House	126,703
Wild	37,253
Chinchilla (La Plata), known also as Bastard	43,578
Peruvian finest	5,603
Deer, Chinese	124,355
Ermine	40,641
Fisher	5,949
Fitch	77,578
Fox, Blue	1,893
Cross	10,276
Grey	59,561
Japanese	81,429
Kit	4,023
Red	158,961
Silver	2,510
White	27,463

Goats, Chinese	261,190
Hares	41,256
Kangaroo	7,115
Kid, Chinese linings and skins equal to	5,080,047
Kolinsky	114,251
Lamb, Mongolian linings and skins equal to	214,072
" Slink	167,372
" Tibet	794,130
Leopard	3,574
Lynx	88,822
Marmot, linings and skins equal to	1,600,600
Marten, Baum	4,573
" Japanese	16,461
" Stone	12,939
Mink, Canadian and American	299,254
" Japanese	360,373
Mouflon	23,594
Musk-rat or Musquash, Brown	5,126,339
" Black	41,788
Nutria	82,474
Opossum, American	902,065
" Australian	4,161,685
Otter, River	21,235
" Sea	522
Raccoon	310,712
Sable, Canadian and American	97,282
" Japanese	556
" Russian	26,399
Seals, Fur	77,000
" Hair	31,943
Skunk	1,068,408
Squirrel	194,596
" Linings each averaging 126 skins	1,982,736
Tiger	392
Wallaby	60,956
Wolf	56,642
Wolverine	1,726
Wombat	193,625

A brief account of the different qualities of the pelts, with some general remarks as to their customary uses, follows. The prices quoted are subject to constant fluctuation and represent purely trade prices for bulk, and it should be explained that the very great variations are due to different sizes, qualities and colours, and moreover are only *first cost*, before skins are dressed and prepared. These preparations are in some cases expensive, and there is generally a considerable percentage of waste. The prices cannot be taken as a guide to the wholesale price of a single and finished skin, but simply as *relative value*.

The fullest and darkest skins of each kind are the most valuable, and, in cases of bluish grey or white, the fuller, clearer and brighter are the more expensive. A few albinos are found in every species, but whatever their value to a museum, they are of little commercial importance. Some odd lots of skins arrive designated simply as "sundries," so no classification is possible, and this will account for the absence of a few names of skins of which the imports are insignificant in quantity, or are received direct by the wholesale merchants.

*Names, Qualities and Uses of Pelts.*¹

ASTRACHAN.—See *Lambs*, below.
BADGER.—Size 2X1 ft. American sorts have coarse thick under-wool of a pale fawn or stone colour with a growth of longer black and white hairs, 3 or 4 in. long; a very durable but clumsy fur. The best skins are exported to France, Spain and Italy, and used for carriage rugs and military purposes. Asiatic, including Japanese, skins are more woolly. Russian and Prussian kinds are coarser and darker, and used mostly for brush trade. Value 6d. to 19s.

BEAR, AUSTRALIAN.—See *Wombat*, below.
BEAR, BLACK.—Size 6X3 ft. Fine dark brown under-wool with bright black and flowing top hair 4 in. long. Cubs are nearly as long in the hair although only about half the size and not only softer and better, but have the advantage of being very much lighter in pelt. Widely distributed in North America, the best come from Canada, are costly and are used for military caps, coats, muffs, trimmings, carriage rugs and coachmen's capes, and the fur wears exceedingly well. Value 17s. 6d. to 86s. Those from East India and warm climates are harsh, poor and only fit for floor rugs.

BEAR, BROWN.—Size 6X3 ft. Similar in quality to the black, but far more limited in number; the colours range from light yellow to a rich dark brown. The best come from Hudson Bay territory and are valuable. Used for muffs, trimmings, coats, and carriage

¹The measurements given are from nose to root of tail of average large sizes after the dressing process, which has a shrinking tendency. The depths of fur quoted are the greatest, but there are plenty of good useful skins possessing a lesser depth.

rugs. Inferior sorts, almost grizzly in effect and some very pale, are found in Europe and Asia and are mostly used locally. In India there is a species called Isabelle bear, which was formerly imported to Great Britain, but does not now arrive in any quantity worth mentioning. Value 10s. 6d. to 60s., Isabelle sort 10s. 6d. to 78s.

BEAR, GRIZZLY.—Size 8X4 ft. Coarse hair, heavy pelt, mostly dark yellowish and brown colours, only found in western parts of United States, Russia and Siberia. Used as carriage rugs and floor rugs, most durable for latter purpose and of fine effect. They are about half the value of brown bear. Value 15s. to 54s.

BEAR, ISABELLE.—See *Bear, Brown*, above

BEAR, WHITE.—Size 10X5 ft. The largest of all bears. Short close hair except on flanks, colour white to yellow. An inhabitant of the Arctic circle, best from Greenland. Used for floor rugs, very durable; and very white specimens are valuable. Value 20s. to 520s.

BEAVER.—Size 3X2 ft. The largest of rodents, it possesses a close underwool of bluish-brown hue, nearly an inch in depth, with coarse, bright, black or reddish-brown top hair, 3 in. long. Found widely in North America. After being unhaird the darkest wools are the most valuable, although many people prefer the bright, lighter brown tones. Used for collars, cuffs, boas, muffs, trimmings, coat linings and carriage aprons, and is of a most durable nature, in addition to having a rich and good appearance. Value 10s to 39s. 6d.

BROADTAIL.—See *Lamb*, below.

CARACAL.—A small lynx from India, the fur very poor, seldom imported.

CARACUL.—See *Goats and Lamb*, below.

CAT, CIVET.—Size 9X4½ in., short, thick and dark underwool with silky black top hair with irregular and unique white markings. It is similar to skunk, but is much lighter in weight, softer and less full, without any disagreeable odour. Used for coat linings it is very warm and durable. A few come from China, but the fur is yellowish-grey, slightly spotted and worth little. Value 1s. 1d. to 1s. 11d.

CAT, HOUSE, &c.—18X9 in., mostly black and dark brown, imported from Holland, Bavaria, America and Russia, where they are reared for their coats. The best, from Holland, are used for coat linings. Although in colour, weight and warmth they are excellent, the fur is apt to become loose and to fall off with friction of wear. The black are known as genet, although the true genet is a spotted wild cat. Wild sorts of the tabby order are coarser, and not so good and silky in effect as when domestically reared. Value of the black sorts 2d. to 3s. Wild 9d. to 14s. Some small wild cats, very poor flat fur of a pale fawn colour with yellow spots, are imported from Australia and used for linings. Value 5½d. to 1s. 1d.

CHEETAH.—Size of a small leopard and similar in colour, but has black spots in lieu of rings. Only a few are now imported, which are used for mats. Value 2s. 6d. to 18s.

CHINCHILLA, PERUVIAN and BOLIVIAN.—Size 12X7 in., fur 1 to 1½ in. deep. Delicate blue-grey with black shadings, one of nature's most beautiful productions, though not a durable one. Used for ladies' coats, stoles, muffs, hats and trimmings. Yearly becoming scarcer and most costly. Value 8s. 6d. to 56s. 8d.

CHINCHILLA, LA PLATA, incorrectly named and known in the trade as "bastard chinchilla," size 9X4 in., in a similar species, but owing to lower altitudes and warmer climatic conditions of habitation is smaller, with shorter and less beautiful fur, the underwool colour being darker and the top colour less pure. Used exactly as the better kind, and the picked skins are most effective. As with the best sort it is not serviceable for constant wear. Value 4s. 2d. to 27s. 6d.

CHINCHILLONE.—Size 13X8 in., obtained also from South America. Fur is longer and weaker and poorer and yellower than chinchilla. Probably a crossbred animal, very limited importation. Value 3s. 6d. to 16s. 8d.

DEER, CHINESE and EAST INDIAN.—Small, light, pelted skins, the majority of which are used for mats. Reindeer and other varieties are of little interest for use other than trophy mats. Thousands are taken for the leather trade. Value of Chinese 1s. 2d. to 1s. 6d. each.

DOG.—The only dogs that are used in the fur trade in civilized countries are those imported from China, which are heavy and coarse, and only used in the cheaper trade, chiefly for rugs. Value 6d. to 1s.

DOG WOLF.—See *Wolf*, below.

ERMINE.—Size 12X2½ in. Underwool short and even, with a shade longer top hair. Pelt light and close in texture, and durable. In the height of winter the colour is pure white with exception of the tip of tail, which is quite black. Supplies are obtained from Siberia and America. Best are from Ishim in Siberia. Used for cloak linings, stoles, muffs and trimmings, also for embellishment of British state, parliamentary and legal robes. When this fur is symmetrically spotted with black lamb pieces it is styled miniver, in which form it is used at the grand coronation functions of British sovereigns. Value 1s. 3d. to 8s. 6d.

FISHER.—Size 30X12 in., tail 12 to 18 in. long, the largest of the martens; has a dark shaded deep underwool with fine, glossy, dark and strong top hair 2 in. or more long. Best obtained from British America. The tails are almost black and make up most handsomely

into trimmings, muffs, &c. Tails worked separately in these forms are as rich and fine and more durable than any other fur suitable for a like purpose. The fur of the skin itself is something like a dark silky raccoon, but is not as attractive as the tails. Value 12s. to 46s.

FITCH.—Size 12X3 in., of the marten species, also known as the pole cat. Yellow underwool ½ in. deep, black top hair, 1½ to 1½ in. long, very fine and open in growth, and not close as in martens. Largest skins come from Denmark, Holland and Germany. The Russian are smaller, but more silky and, as now dyed, make a cheap and fair substitute for sable. They are excellent for linings of ladies' coats, being of light weight and fairly strong in the pelt. English mayors' and civic officials' robes are frequently trimmed with this fur in lieu of sable. Value of the German variety 2s. to 5s. 6d. and of the Russian 7d. to 1s. 4d.

FOX, BLUE.—Size 24X8 in. Underwool thick and long. Top hair fine and not so plentiful as in other foxes. Found in Alaska, Hudson Bay territory, Archangel and Greenland. Although called blue, the colour is a slaty or drab tone. Those from Archangel are more silky and of a smoky bluish colour and are the most valuable. These are scarce and consequently dear. The white foxes that are dyed smoke and celestial blue are brilliant and totally unlike the browner shades of this fox. Value 34s. to 195s.

FOX, COMMON.—The variation of size and quality is considerable, and the colour is anything from grey to red. In Great Britain the animal is now only regarded for the sport it provides. On the European continent, however, some hundreds of thousands of skins, principally German, Russian and Norwegian, are sold annually, for home use, and for dyeing and exportation, chiefly to the United States. The qualities do not compare with those species found in North America and the Arctic circle. The Asiatic, African and South American varieties are, with the exception of those taken in the mountains, poorly furred and usually brittle and therefore of no great service. No commercial value can be quoted.

FOX, CROSS.—Size 20X7 in., are about as large as the silver and generally have a pale yellowish or orange tone with some silvery points and a darkish cross marking on the shoulders. Some are very similar to the pale red fox from the North-West of America and a few are exceptionally large. The darkest and best come from Labrador and Hudson Bay, and the ordinary sorts from the northwest of the United States and, as with silver and other kinds, the quality is inferior when taken from warmer latitudes. Value 10s. 6d. to 60s.

FOX, GREY.—Size 27X10 in. Has a close dark drab underwool with yellowish grizzly, grey, regular and coarse top hair. The majority used for the trade come from Virginia and the southern and western parts of the United States. Those from the west are larger than the average, with more fur of a brighter tone. The fur is fairly serviceable for carriage rugs, the leather being stout, but its harshness of quality and nondescript colour does not contribute to make it a favourite. Value 9d. to 4s. 9d.

FOX, JAPANESE.—See *Fox, Red*, and *Raccoon*, below.

FOX, KIT.—Size 20X6 in. The underwool is short and soft, as is also the top hair, which is of very pale grey mixed with some yellowish-white hair. It is the smallest of foxes, and is found in Canada and the northern section of the United States. It is similar in colour and quality to the prairie fox and to many kinds from the warmer zones, such as from Turkey, eastern Asia and elsewhere. Value 1s. 3d. to 5s. 6d.

FOX, RED.—Size 24X8 in., though a few kinds are much larger. The underwool is long and soft and the hair plentiful and strong. It is found widely in the northern parts of America and in smaller numbers south of the United States, also in China, Japan and Australia. The colours vary from pale yellowish to a dark red, some being very brilliant. Those of Kamshatka are rich and fine in quality. Farther north, especially near the sea, the fur is coarse. Where the best coloured skins are not used for carriage rugs they are extensively dyed, and badger and other white hairs are inserted to resemble silver fox. They are also dyed a sable colour. The skins, being the strongest of foxes, both in the fur and pelt, are serviceable. The preparations in imitation of the natural black and silver sorts are very good and attractive. Value 1s. to 41s.

FOX, SILVER. Size 30X10 in. Underwool close and fine. Top hair black to silvery, 3 in. long. The fur upon the necks usually runs dark, almost black, and in some cases the fur is black halfway down the length of the skin, in rarer cases three-quarters of the length and, in the most exceptional instances, the whole length, and when this is the case they are known as "Natural Black Foxes" and fetch enormous prices. The even silvery sorts are highly esteemed, and the fur is one of the most effective and precious. The finest are taken in Labrador. The farther south they are found, the poorer and coarser the fur. The brush has invariably a white tip. Value £1 to £120.

FOX, WHITE.—Size 20X7 in. Animals of this species are generally small in size and inhabit the extreme northern sections of Hudson Bay, Newfoundland, Greenland, Labrador and Siberia. The Canadian are silky in nature and inclined to a creamy colour, while the Siberian are more woolly and rather whiter. Those taken in central Asia near or in Chinese territory are poorer and yellowish. The underwool in all sorts is generally of a bluish-grey tone, but the top hair in the depth of winter is usually full enough in quantity to

hide any such variation. Those skins in which the underwool is quite white are rare and much more expensive. In summer specimens of this species, as with other white furred animals, have slightly discoloured coats. The skins that are not perfectly white are dyed jet black, dark or light smoke, violet-blue, blue-grey, and also in imitation of the drab shades of the natural blue. Value 18s. to 66s.

GENET.—Size 10X4 in. The genet proper is a small white spotted cat found in Europe, but the quantity is too small to be of commercial interest. The name has been adopted for the black cats used so much in the trade. (See *Cats*, above.) Value 1s. to 6s. 6d.

GOATS.—Size varies greatly. The European, Arabian and East Indian kinds are seldom used for rugs, the skins are chiefly dressed as leather for books and furniture, and the kids for boots and gloves, and the finer wool and hair are woven into various materials. Many from Russia are dyed black for floor and carriage rugs; the hair is brittle, with poor underwool and not very durable; the cost, however, is small. The Chinese export thousands of similar skins in black, grey and white, usually ready dressed and made into rugs of two skins each. A great many are dyed black and brown, in imitation of bear, and are used largely in the western parts of the United States and Canada for sleigh and carriage rugs. Many are used for their leather. Thousands of the kids are also dyed black and worked into cross-shaped pieces, in which shape they are largely exported to Germany, France, Great Britain and America, and sold by the retail as caracal, kid or caracul. The grey ones are in good demand for motor coats. The word caracul has been adopted from the Turkish and signifies black-cared. See also *Lambs, caracul*. Value of Chinese white 3s. 6d. to 6s. 6d.; grey, 4s. to 6s. 9d.

The Angora from the heights of central Asia Minor has curly, fleecy, silky, white wool, 4 to 7 in. long. The fur is not used in Great Britain, as formerly, and the greater quantity, known as mohair, is now imported for purposes of weaving. This species of goat was some years since introduced into Cape Colony, but its wool is not so good as the Asiatic breed. Good business, however, is done with the product, but chiefly for leather. Value 4s. to 12s. 6d.

The Mongolian goat has a very soft silk underwool, and after the long top hair is removed it is dressed and imported and erroneously named mouflon. The colour is a light fawn, but it is so pale that it lends itself to be dyed any colour. It was popular some years since in the cheaper trade, but it is not now much seen in England. Value 2s. to 6s.

The Tibet goat is similar to the Angora in the fineness of its wool, and many are used in the making of cashmere shawls. The Tibet lamb so largely imported and used for children's wear is often mis-called Tibet goat. Value 3s. to 7s. 6d.

GUANACO.—Size 30X15 in. Is a species of goat found in Patagonia and other parts of South America. It has a very long neck and exceedingly soft woolly fur of a light reddish-fawn colour with very white flanks. It is usually imported in small quantities, native dressed, and ready made into rugs. The dressing is hard and brittle. If the skins are dressed in Europe they afford a very comfortable rug, though a very marked one in effect. They have a similar wool to the vicuña, but coarser and redder; both are largely used in South America. Value 1s. to 4s. 6d.

HAMSTER.—Size 8X3 in. A destructive rodent, is found in great numbers in Russia and Germany. The fur is very flat and poor, of a yellowish pale brown with a little marking of black. Being of a light weight it is used for linings. Value 3d. to 1s.

HARE.—Size 24X9 in. The common hare of Europe does not much interest the furrier, the fur being chiefly used by makers of hatters' felt. The white hares, however, of Russia, Siberia and other regions in the Arctic circle are very largely used in the cheaper trade of Europe, America and the British colonies. The fur is of the whitest when killed in winter, and that upon the flanks of the animal is very much longer than that upon its back. The flanks are usually cut off and made into muffs and stoles. The hair is, however, brittle and is not at all durable. This fur is dyed jet black and various shades of brown and grey, and manufactured into articles for the small drapers and for exportation. The North American hares are also dyed black and brown and used in the same way. Value of white 2d. to 5d.

JACKAL.—Size 2 to 3 ft. long. Is found in India and north and south Africa. Indian are light brown and reddish, those from the Cape are dark grey and rather silvery. Few are imported. Fur generally poor and harsh, only suitable for carriage rugs. Value 1s. to 3s. 6d.

JAGUAR.—Size 7 to 10 ft. long. Is found in Mexico and British Honduras. The markings are an irregular ring formation with a spot in the centre. Leopards have rings only and cheetahs solid spots. Suitable only for hearthrugs. Supply very limited. Value 5s. to 45s.

KALUGA.—See *Souslik*, below.

KANGAROO.—The sizes vary considerably, some being huge, others quite small. The larger varieties, viz. the red and the great, do not usually interest furriers, the fur being harsh and poor without underwool. They are tanned for the leather trade. The sorts used for carriage aprons, coat linings and the outside of motor coats include: blue kangaroo, bush kangaroo, bridled kangaroo, wallaroo, yellow kangaroo, rock wallaby, swamp wallaby and short-tailed wallaby. Many of the swamp sort are dyed to imitate skunk and

look well. Generally the colours are yellowish or brown. Some are dark brown as in the swamp, which being strong are suitable for motor coats. The rock wallabies are soft and woolly and often of a pretty bluish tone, and make moderately useful carriage rugs and perambulator aprons. The redder and browner sorts are also good for rugs as they are thick in the pelt. On the European continent many of these are dyed. The best of the lighter weights are frequently insufficiently strong in the hair to stand the friction of wear in a coat lining. Value, kangaroo 9d. to 3s., wallaby 1d. to 5s. 3d., wallaroo 1s. to 5s. 6d.

KIDS.—See *Goats*, above.

KOLINSKY.—Size 12X2½ in. Is one of the marten tribe. The underwool is short and rather weak, but regular, as is also the top hair; the colour is usually yellow. They have been successfully dyed and used as a substitute for sable. They are found in Siberia, Amoor, China and Japan, but the best are from Siberia. They are light in weight and therefore suitable for linings of coats. The tails are used for artists' "sable" brushes. The fur has often been designated as red or Tatar sable. Value 1s. 6d. to 4s. 6d.

LAMBS.—The sorts that primarily interest the fur trade in Europe and America are those from south Russia, Persia and Afghanistan, which are included under the following wholesale or retail commercial terms: Persian lamb, broadtail, astrachan, Shiraz, Bokharan and caracul lamb. With the public the general term astrachan is an old one, embracing all the above curly sorts; the flatter kinds, as broadtail and caracul lamb, have always been named separately. The Persian lambs, size 18X9 in., are the finest and the best of them. When dressed and dyed they should have regular, close and bright curl, varying from a small to a very large one, and if of equal size, regularity, tightness and brightness, the value is comparatively a matter of fancy. Those that are dull and loose, or very coarse and flat in the curl, are of far less market value.

All the above enumerated lambs are naturally a rusty black or brown, and with very few exceptions are dyed a jet black. Lustre, however, cannot be imparted unless the wool was originally of a silky nature. Broadtails, size 10X5 in., are the very young of the Persian sheep, and are killed before the wool has time to develop beyond the flat wavy state which can be best compared to a piece of moiré silk. They are naturally exceedingly light in weight, and those that are of an even pattern, possessing a lustrous sheen, are costly. There is, notwithstanding, a great demand for these from the fashionable world, as not only are they very effective, but being so flat in the wool the figure of the wearer can be shown as perfectly as in a garment made of silk. It cannot be regarded as an economical fur, as the pelt is too delicate to resist larval wear.

Persian Lamb price 12s. 6d. to 25s.
Broadtail " 10s. " 35s.

Astrachan, Shiraz and Bokharan lambs, size 22 by 9 in., are of a coarser, looser curl, and chiefly used for coat linings, while the Persians are used for outside of garments, collars, cuffs, stoles, muffs, hats and trimmings and gloves. The so-called caracul lambs, size 12X6 in., are the very young of the astrachan sheep, and the pick of them are almost as effective as broadtails, although less fine in the texture. See also remarks as to caracul kid under *Goats*, above.

Astrachan price 1s. to 5s. 6d.
Caracul Lamb " 2s. 6d. " 10s. 6d.
Shiraz " 4s. 6d. " 10s.
Bokharan " 1s. 6d. " 3s. 6d.

Grey lambs, size 24X10 in., are obtained from the Crimea and known in the trade as "crimmers." They are of a similar nature to the caracul lambs, but looser in curl, ranging from a very light to a dark grey. The best are the pale bluish greys, and are chiefly used for ladies' coats, stoles, muffs and hats. Price 2s. to 6s. Mongolian lambs, size 24X15 in., are of a short wavy loose curl, creamy white colour, and are usually exported from China dressed, the majority being ready-made into cross-shaped coats or linings. They are used principally for linings of good evening wraps for ladies. Price 1s. to 2s. 6d. Slink lambs come from South America and China. The former are very small and generally those that are stillborn. They have a particularly thin pelt with very close wool of minute curl. The China sorts are much larger. The smallest are used for glove linings and the others for opera cloak linings. Price 1s. to 6s. 6d.

LEOPARD.—Size 3 to 6 ft. long. There are several kinds, the chief being the snow or ounce, Chinese, Bengal, Persian, East Indian and African. The first variety inhabit the Himalayas and are beautifully covered with a deep soft fur quite long compared to the flat harsh hair of the Bengal sort. The colours are pale orange and white with very dark markings, a strong contrast making a fine effect. Most artists prize these skins above all others. The Chinese are of a medium orange brown colour, but full in fur. The East Indian are less full and not so dark. The Bengal are dark and medium in colour, short and hard hair, but useful for floor rugs, as they do not hold the dust like the fuller and softer hair of the kinds previously named. They are also used for drummers' aprons and saddle cloths in the Indian army. The African are small with pale lemon colour grounds very closely marked with black spots on the skin, the strong contrast making a pleasing effect. Occasionally, where something very marked is wanted, skating jackets and carriage aprons are made

from the softest and flattest of skins, but usually they are made into settee covers, floor rugs and foot muffs. Value 2s. to 40s.

LION.—Size 5 to 6 ft. long. These skins are found in Africa, Arabia and part of India, and are every year becoming scarcer. They are only used for floor rugs, and the males are more highly esteemed on account of the set-off of the mane. Value, lions' £10 to £100; lionesses' £5 to £25.

LYNX.—Size 45 X 20 in. The underwool is thinner than fox, but the top hair is fine, silky and flowing, 4 in. long, of a pale grey, slightly mottled with fine streaks and dark spots. The fur upon the flanks is longer and white with very pronounced markings of dark spots, and this part of the skin is generally worked separately from the rest and is very effective for gown trimmings. Where the colour is of a sandy and reddish hue the value is far less than where it is of a bluish tone. They inhabit North America as far south as California, also Norway and Sweden. Those from the Hudson Bay district and Sweden are the best and are very similar. Those taken in Central Asia are mostly used locally. For attire the skins manufactured in Europe are generally dyed black or brown, in which state it has a similar appearance to dyed fox, but having less thick underwool and finer hair flows freely. The finest skins when dyed black are used very largely in America in place of the dyed black fox so fashionable for mourning wear in Great Britain and France. The British Hussar bushes are made of the dark brown lynx, and it is the free silky easy movement of the fur with the least disturbance in the atmosphere that gives it such a pleasing effect. It is used for rugs in its natural state and also in Turkey as trimmings for garments. Value 13s. 6d. to 56s.

LYNX CAT or BAY LYNX.—Is about half the size and depth of fur of a lynx proper, and inhabits the central United States. It is a flat and reddish fur compared to the lynx and is suitable for cheap carriage aprons. A few come from Canada and are of better quality. Value 5s. to 15s.

MARMOT.—Size 18 X 12 in. Is a rodent and is found in considerable numbers in the south of Prussia. The fur is a yellowish brown and rather harsh and brittle and has no underwool. Since, however, the value of all good furs has advanced, dyers and manufacturers have made very successful efforts with this fur. The Viennese have been particularly successful, and their method has been to dye the skins a good brown and then put in the dark stripes, which exist in sable and mink, until the garment or article is finished, thus obtaining as perfectly symmetrical effects as if the articles were made of small skins instead of large ones. Marmots are also found in North America, Canada and China; the best, however, come from Russia. It should always be a cheap fur, having so few good qualities to recommend it. Value 9d. to 5s. 6d.

MARTEN, AMERICAN.—See *Sable*, below.

MARTEN, BAUM.—Size 16 X 5 in. Is sometimes called the pine marten, and is found in quantity in the wooded and mountainous districts of Russia, Norway, Germany and Switzerland. It possesses a thick underwool with strong top hair, and ranges from a pale to a dark bluish brown. The best, from Norway, are very durable and of good appearance and an excellent substitute for American sable. The tails when split into two or three, with small strips of narrow tape so as to separate the otherwise dense fur, formerly made very handsome sets of trimmings, ties and muffs, and the probabilities are, as with other fashions, such use will have its period of revival. Value 6s. to 85s.

MARTEN, BLACK.—See *Siskak*, below.

MARTEN, JAPANESE.—Size 16 X 5 in. Is of a woolly nature with rather coarse top hair and quite yellow in colour. It is dyed for the cheap trade for boas and muffs, but it is not an attractive fur at the best of times. It lacks a silky, bright and fresh appearance, and therefore is unlikely to be in great demand, except where economy is an object. Value 6s. 6d. to 18s. 6d.

MARTEN, STONE.—Size and quality similar to the baum; the colour, however, of the underwool is a stony white and the top hair is very dark, almost black. They live in rocky and stony districts. Skins of a pale bluish tone are generally used in their natural state for stoles, boas and muffs, but the less clear coloured skins are dyed in beautiful shades similar in density to the dark and valuable sables from Russia, and are the most effective skins that can be purchased at a reasonable price. The tails have also been worked, in the manner explained with regard to the baum marten, as sets of trimmings and in other forms. Stone martens are found in Russia, Bosnia, Turkey, Greece, Germany, the Alps and France. The Bosnian and the French are the best in colour. The Asiatic sorts are less woolly, but being silky are useful when dyed. There are many from Afghanistan and India which are too poor to interest the European markets. Value 7s. 6d. to 26s.

MINK.—Size 16 X 5 in. Is of the amphibious class and is found throughout North America and in Russia, China and Japan. The underwool is short, close and even, as is also the top hair, which is very strong. The best skins are very dark and are obtained from Nova Scotia. In the central states of America the colour is a good brown, but in the north-west and south-west the fur is coarse and generally pale. It is very durable for linings, and is an economical substitute for sable for coats, capes, boas and trimmings. Values have greatly increased, and the fur possessing good qualities as to colour and durability will doubtless always be in good request.

The Russian species is dark but flat and poor in quality, and the Chinese and Japanese are so pale that they are invariably dyed. These, however, are of very inferior nature. Value of American 3s. 3d. to 40s., Japanese 3d. to 2s. 3d.

MOLE.—Size 3½ X 2½ in. Moles are plentiful in the British Isles and Europe, and owing to their lovely velvety coats of exquisite blue shade and to the cleanness of other furs are much in demand. Though the fur is cheap in itself, the expense of dressing and working up these little skins is considerable, and they possess the unique charm of an exceptional colour with little weight of pelt; the quality of resistance to friction is, however, so slight as to make them expensive in wear. The best are the dark blue from the Fen district of Cambridgeshire in England. Value 4d. to 2d.

MONGOLIAN LAMBS.—See *Lambs*, above.

MONKEY, BLACK.—Size 18 X 10 in. Among the species of monkeys only one interests to any extent the fur trade, and that is the black monkey taken on the west coast of Africa (*Colobus satanas*). The hair is very long, very black and bright with no underwool, and the white pelt of the base of the hair, by reason of the great contrast of colour, is very noticeable. The skins were in 1850 very fashionable in England for stoles, muffs and trimmings, and in America also as recently as 1890. They are now mostly bought for Germany and the continent. Value 6d. to 1s. 6d.

MOUNTAIN.—Size 30 X 15 in. Is a sheep found in Russia and Corsica and now very little in demand, and but few are imported into Great Britain. Many Mongolian goats with the long hairs pulled out are sold as mouflon. Value 4s. to 10s. 6d.

MUSK-OX.—Size 6 X 3 ft. These animals have a dense coat of fine, long brown wool, with very long dark brown hair on the head, flanks and tail, and, in the centre, a peculiar pale oval marking. There is no other fur that is so thick, and it is eminently suitable for sleighing rugs, for which purpose it is highly prized in Canada. The musk-ox inhabits the north part of Greenland and part of Canada, but in very limited numbers. Value 10s. to 130s.

MUSQUASH or MUSK-RAT, BROWN and BLACK RUSSIAN.—Size 12 X 8 in. A very prolific rodent of the amphibious class obtained from Canada and the United States, similar in habit to the English vole, with a fairly thick and even brown underwool and rather strong top dark hair of medium density. It is a very useful fur for men's coat linings and ladies' driving or motoring coats, being warm, durable and not too heavy; the colour were less motley and the joints between the skins could be made less noticeable, it would be largely in demand for stoles, ties and muffs. As it is, this fur is only used for these smaller articles for the cheaper trade. It has, however, of later years been "unhaired," the underwool clipped very even and then dyed seal colour, in which way very useful and attractive garments are supplied at less than half the cost of the cheaper sealskins. They do not wear as well, however, as the pelt and the wool are not of a strength comparable to those of sealskin. With care, however, such a garment lasts sufficiently long to warrant the present outlay. Value 5½d. to 1s. 9d.

There is a so-called black variety found in Delaware and New Jersey, but the number is very small compared to the brown species. They are excellent for men's coat linings and the outside of ladies' coats, for stoles, muffs, collars and cuffs. Value 10d. to 3s. 7d.

The Russian musquash is very small, 7 X 3 in., and is limited in numbers compared to the brown. Only a few thousands are imported to London. It is of a very pretty silvery-blue shade of even wool with very little silky top hair, having silvery-white sides and altogether a very marked effect. The odour, however, even after dressing is rather pungent of musk, which is generally an objection. Value 4s. to 6s. 6d.

NUTRIA.—Size 30 X 12 in. Is a rodent known in natural history as the coypu, about half the size of a beaver, and when unhaired has not more than half, generally less, the depth of fur, which is also not so close. Formerly the fur was only used for hatters' felt, but with the rise in prices of furs these skins have been more carefully removed and—with improved dressing, unhairing and silvering processes—the best provides a very effective and suitable fur for ladies' coats, capes, stoles, muffs, hats and gloves, while the lower qualities make very useful, light-weighted and inexpensive linings for men's or women's driving coats. It is also dyed sealskin colour, but its woolly nature renders it less effective than the more silky musquash. They are obtained from the northern part of South America. Value 1s. 6d. to 6s. 6d.

OCELOT.—Size 36 X 13 in. Is of the nature of a leopard and prettily marked with stripes and oblong spots. Only a few are now imported from South America for carriage aprons or mats. The numbers are very limited. Value 1s. to 2s. 6d.

OPOSSUM, AMERICAN.—Size 18 X 10 in. Is a marsupial, a class with this exception not met with out of Australia. The underwool is of a very close frizzy nature, and nearly white, with long bluish grey mixed with some black top hair. It is only found in the central sections of the United States. About 1870 in England it was dyed dark brown or black and used for boas, muffs and trimmings, but until recently has been neglected on the continent. With, however, recent experiments in brown and skunk coloured dyes, it bids fair to become a popular fur. Value 2½d. to 5s. 6d.

OPOSSUM, AUSTRALIAN.—Size 16 X 8 in. Is a totally different nature of fur to the American. Although it has wool and top hair,

the latter is so sparse and fine that the coat may be considered as one of close even wool. The colour varies according to the district of origin, from a blue grey to yellow with reddish tones. Those from the neighbourhood of Sydney are light clear blue, while those from Victoria are dark iron grey and stronger in the wool. These animals are most prolific and evidently increasing in numbers. Their fur is pretty, warm and as yet inexpensive, and is useful for rugs, coat linings, stoles, muffis, trimmings and perambulator aprons. The worst coloured ones are frequently dyed black and brown. The most pleasing natural grey come from Adelaide. The reddest are the cheapest. Value 3jd. to 3s. 6d.

OPOSSUM, RINGTAILED.—Size 7X4 in. Has a very short close and dark grey wool, some being almost black. There are but a few thousands imported, and being so flat they are only of use for coat linings, but they are very warm and light in weight. Value 6d. to 10d.

OPOSSUM, TASMANIAN (grey and black).—Size 20X10 in. Is of a similar description, but darker and stronger in the wool and larger. Besides these there are some very rich brown skins which were formerly in such request in Europe, especially Russia, that undue killing occurred until 1899, when the government stopped for a time the taking of any of this class. They are excellent for carriage aprons, being not only very light in weight and warm, but handsome. Value 2s. 6d. to 8s. 6d.

OTTER, RIVER.—The size varies considerably, as does the underwool and the top hair, according to the country of origin. There are few rivers in the world where they do not live. But it is in the colder northern regions that they are found in the greatest numbers and with the best fur or underwool, the top hair, which, with the exception of the scarce and very rich dark brown specimens they have in common with most aquatic animals, is pulled out before the skins are manufactured. Most of the best river otter comes from Canada and the United States and averages 36X18 in. in size. Skins from Germany and China are smaller, and shorter in the wool. The colours of the underwools of river otters vary, some being very dark, others almost yellow. Both as a fur and as a pelt it is extremely strong, but owing to its short and close wool it is usually made up for the linings, collars and cuffs of men's coats. A large number of skins, after unhairing, is dyed seal colour and used in America. Those from hot climates are very poor in quality. Value 28s. to 118s.

OTTER, SEA.—Size 50X25 in. Possesses one of the most beautiful of coats. Unlike other aquatic animals the skin undergoes no process of unhairing, the fur being of a rich dense silky wool with the softest and shortest of water hairs. The colours vary from pale grey brown to a rich black, and many have even or uneven sprinkling of white or silvery-white hairs. The blacker the wool and the more regular the silver points, the more valuable the skin. Sea otters are, unfortunately, decreasing in numbers, while the demand is increasing. The fur is most highly esteemed in Russia and China; in the latter country it is used to trim mandarins' state robes. In Europe and America it is much used for collar, long facings and cuffs of a gentleman's coat; such a set may cost from £200 to £600, and in all probability will soon cost more. Taking into consideration the size, it is not so costly as the natural black fox, or the darkest Russian sable, which is now the most expensive of all. The smaller and young sea otters of a grey or brown colour are of small value compared to the large dark and silvery ones. Value £10 to £220. A single skin has been known to fetch £400.

OUZCE.—See *Leopard*, above.

PERSIAN LAMBS.—See *Lambs*, above.

PLATYPUS.—Size 12X8 in. One of the most singular of fur-bearing animals, being the link between bird and beast. It has fur similar to otter, is of aquatic habits, being web-footed with spurs of a cock and the bill of a duck. The skins are not obtained in any numbers, but being brought over by travellers as curiosities and used for muffis, collars and cuffs, &c., they are included here for reference. Value 2s. to 3s. 6d.

PONY or TATAR FOAL.—Size 36X20 in. These skins are of comparatively recent importation to the civilized world. They are obtained from the young of the numerous herds of wild horses that roam over the plains of Turkestan. The coat is usually a shade of brown, sometimes greyish, fairly bright and with a suggestion of waviness. Useful for motor coats. Value 3s. to 10s. 6d.

PUMA.—Size 41X3 ft. Is a native of South America, similar to a lion in habits and colour of coat. The hair and pelt is, however, of less strength, and only a few are now used for floor rugs. Value 5s. to 10s.

RACCOON.—Size 20X12 in. Is an animal varying considerably in size and in quality and colour of fur, according to the part of North America in which it is found. In common parlance, it may be described as a species of wild dog with close affinity to the bear. The underwool is 1 to 1½ in. deep, pale brown, with long top hairs of a dark and silvery-grey mixture of a grizzly type, the best having a bluish tone and the cheapest a yellowish or reddish-brown. A limited number of very dark and black sorts exist and are highly valued for trimmings. The very finest skins are chiefly used for stoles and muffis, and the general run for coachmen's capes and carriage rugs, which are very handsome when the tails, which are marked with rings of dark and light fur alternately, are left on. *Raccoons are used in enormous quantities in Canada for men's*

coats, the fur outside. The poorer qualities are extensively bought and made up in a similar way for Austria-Hungary and Germany. These make excellent linings for coats or footsacks for open driving in very cold climates. The worst coloured skins are dyed black or brown and are used for British military busbies, or caps, stoles, boas, muffis and coachmen's capes. The best skins come from the northern parts of the United States. A smaller and poorer species inhabits South America, and a very few are found in the north of India, but these do not interest the European trade. From Japan a similar animal is obtained in smaller quantities with very good but longer fur, of yellowish mottled light-brown shades. It is more often imported and sold as Japanese fox, but its resemblance to the fur of the American raccoon is so marked as to surely identify it. When dyed dark blue or skunk colour it is good-looking and is sold widely in Europe. Raccoon skins are also frequently unhairing, and if the underwool is of good quality the effect is similar to beaver. It is the most useful fur for use in America or Russia, having a full quantity of fur which will retain heat. Value 10d. to 26s.

SABLE, AMERICAN and CANADIAN.—Size 17X5 in. The skins are sold in the trade sale as martens, but as there are many that are of a very dark colour and the majority are almost as silky as the Russian sable, the retail trade has for generations back applied the term of sable to this fur. The prevailing colour is a medium brown, and many are quite yellow. The dyeing of these very pale skins has been for so long well executed that it has been possible to make very good useful and effective articles of them at a moderate price compared to Russian sable. The finest skins are found in the East Main and the Esquimaux Bay, in the Hudson's Bay Company's districts, and the poorest in Alaska. They are not found very far south of the northern boundary of the United States. The best skins are excellent in quality, colour and effect, and wear well. Value 27s. 3d. to 290s.

SABLE, CHINESE and JAPANESE.—Size 14X4½ in. These are similar to the Amur skins previously referred to, but of much poorer quality and generally only suitable for linings. The very palest skins are dyed and made by the Chinese into mandarins' coats, in which form they are found in the London trade sales, but being overdressed they are inclined to be loose in the hair and the colour of the dye is not good. The Japanese kind are imported raw, but are few in numbers, very pale and require dyeing. Value 15s. to 150s.

SABLE, RUSSIAN.—Size 15X4 in. These skins belong to a species of marten, very similar to the European and American, but much more silky in the nature of their fur. They have long been known as "sables," doubtless owing to the density of colour to which many of them attain, and they have always been held in the highest esteem by connoisseurs as possessing a combination of rare qualities. The underwool is close, fine and very soft, the top hair is regular, fine, silky and flowing, varying from 1½ to 2½ in. in depth. In colour they range from a pale stony or yellowish shade to a rich dark brown, almost black with a bluish tone. The pelts are exceedingly fine and close in texture and, although of little weight, are very durable, and articles made of them produce a sensation of warmth immediately they are put upon the body.

The Yakutsk, Okhotsk and Kamtschatka sorts are good, the last being the largest and fullest furred, but of less density of colour than the others. Many from other districts are pale or yellowish brown, and those from Saghalien are poor in quality. The most valuable are the darkest from Yakutsk in Siberia, particularly those that have silvery hairs evenly distributed over the skin. These however are exceedingly scarce, and when a number are required to match for a large garment, considerable time may be necessary to collect them. This class of skin is the most expensive fur in the world, reckoning values by a square foot unit.

The Amur skins are paler, but often of a pretty bluish stony tone with many frequently interspersed silvery hairs. The quality too is lower, that is, the fur is not so close or deep, but they are very effective, particularly for close-fitting garments, as they possess the least appearance of bulk. The paler skins from all districts in Siberia are now cleverly coloured or "topped," that is, just the tips of the hair are stained dark, and it is only an expert who can detect them from perfectly natural shades. If this colouring process is properly executed it remains fairly fast. Notwithstanding the reported rights of the Russian imperial authorities over some regions with respect to these and other valuable fur-bearing animals, there are in addition to the numbers regularly sent to the trade auction sales in London many good parcels of raw skins to be easily bought direct, provided price is not the first consideration. Value 25s. to 980s.

SEAL, FUR.—Sizes range from 24X15 in. to 55X25 in., the width being taken at the widest part of the skin after preparation. The centre of the skin between the fins is very narrow and the skins taper at each end, particularly at the tail. The very small pups are of a beautiful quality, but too tiny to make into garments, and, as the aim of a good furrier is to avoid all lateral or cross seams, skins are selected that are the length of the garment that is to be made. The most useful skins for coats are the large pups 42 in. long, and the quality is very good and uniform. The largest skins, known in the trade as "wigs," which range up to 8 ft. in length, are uneven and weak in the fur, and hunters do not seek to obtain them. The supply of the best sort is chiefly from the North Pacific, viz. Pribilof

Islands, Alaska, north-west coast of America, Copper Island of the Aleutian group near to Kamchatka, Kobben Island and Japan. Other kinds are taken from the South Pacific and South Atlantic Oceans, around Cape Horn, the Falkland Islands up to Lobos Islands at the entrance of the La Plata river, off the Cape of Good Hope and Crozet Isles. With, however, the exception of the pick of the Lobos Island seals the fur of the southern sea seals is very poor and only suitable for the cheapest market. Formerly many skins were obtained from New Zealand and Australia, but the importation is now small and the quality not good. The preparation of seal skin occupies a longer time than any other fur skin, but its fine rich effect when finished and its many properties of warmth and durability well repay it. Value 10s. to 232s.

SEAL HAIR.—There are several varieties of these seals in the seas stretching north from Scotland, around Newfoundland, Greenland and the north-west coast of America, and they are far more numerous than fur seals. Generally they have coarse rigid hair and some possess any underwool. They are taken principally for the oil and leather they yield. Some of the better haired sorts are dyed black and brown and used for men's motor coats when quite a waterproof garment is wanted, and they are used also for this quality in China. The young of the Greenland seals are called whitecoats on account of the early growth being of a yellowish white colour; the hair is $\frac{1}{2}$ to 1 in. long, and at this early stage of their life is soft compared to that of the older seals. These fur skins are dyed black or dark brown and are used for military caps and hearth-rugs. Value 2s. to 15s. There are fewer hair seals in the southern than in the northern seas.

SHEEP.—Vary much in size and in quality of wool. Many of the domestic kind in central and northern Europe and Canada are used for drivers' and peasants' coat linings, &c. In Great Britain many coats of the home-reared sheep, having wools two and a half to five inches long, are dyed various colours and used as floor rugs. Skins with very short wool are dyed black and used for military saddle-cloths. The bulk, however, is used in the wool trade. The Hungarian peasants are very fond of their natural brown sheep coats, the leather side of which is not lined, but embellished by a very close fancy embroidery, worked upon the leather itself; these garments are reversible, the fur being worn inside when the weather is cold. Chinese sheep are largely used for cheap rugs. Value of English sheep from 3s. to 10s.

SKUNK OR BLACK MARTEN.—Size 15x18 in. The underwool is full and fairly close with glossy, flowing top hair about 2½ in. long. The majority have two stripes of white hair, extending the whole length of the skin, but these are cut out by the manufacturing furrier and sold to the dealers in pieces for exportation. The animals are found widely spread throughout North and South America. The skins which are of the greatest interest to the European trade are those from North America, the South American species being small, coarse and generally brown. The best skins come from Ohio and New York. If it were not for its disagreeable odour, skunk would be worth much more than the usual market value, as it is naturally the blackest fur, silky in appearance and most durable. The improved dressing processes have to a large extent removed the naturally pungent scent. The fur is excellent for stoles, boas, collars, cuffs, muffs and trimmings. Value 1s. 6d. to 11s.

SOURCE.—Size 7 in. x 2½. Is a small rodent found in the south of Russia and also in parts of America. It has very short hair and is a poor fur even for the cheapest linings, which is the only use to which the skin could be put. It is known as kaluga when imported in ready-made linings from Russia where the skins are dressed and worked in an inferior way. Value 1d. to 3d.

SQUIRREL.—Size 10x5 in. This measurement refers to the Russian and Siberian sorts, which are the only kind imported for the fur. The numerous other species are too poor in their coats to attract notice from fur dealers. The back of the Russian squirrel has an even close fur varying from a clear bluish-grey to a reddish-brown, the bellies in the former being of a flat quality and white, in the latter yellowish. The backs are worked into linings separately, as are the bellies or "locks." The pelts, although very light, are tough and durable, hence their good reputation for linings for ladies' walking or driving coats. The best skins also provide excellent material for coats, capes, stoles, ties, collars, cuffs, gloves, muffs, hoods and light-weight carriage aprons. The tails are dark and very small, and when required for ends of boas three or four are made as one. Value per skin from 2½d. to 1s. 1d.

TIBET LAMB.—Size 27 x 13 in. These pretty animals have a long, very fine, silky and curly fleece of a creamy white. The majority are consigned to the trade auction sales in London ready dressed and worked into cross-shaped coats, and the remainder, a fourth of the total, come as dressed skins. They are excellent for trimmings of evening mantles and for children's ties, muffs and perambulator aprons. The fur is too long and bulky for linings. Value per skin from 4s. 6d. to 8s. 6d.

TIGER.—Size varies considerably, largest about 10 ft. from nose to root of tail. Tigers are found throughout India, Turkestan, China, Mongolia and the East Indies. The coats of the Bengal kind are short and of a dark orange brown with black stripes, those from east or further India are similar in colour, but longer in the hair, while those from north of the Himalayas and the mountains of China are not only huge in size, but have a very long soft hair of delicate

orange brown with very white flanks, and marked generally with the blackest of stripes. The last are of a noble appearance and exceedingly scarce. They all make handsome floor rugs.

Value of the Indian . . . from 15 to 115.
" " Chinese . . . 10 to 165.

VICUNA is a species of long-necked sheep native to South America, bearing some resemblance to the guanaco, but the fur is shorter, closer and much finer. The colour is a pale golden-brown and the fur is held in great repute in South America for carriage rugs. The supply is evidently small as the prices are high. There is scarcely a commercial quotation in London, few coming in except from private sources. 2s. 6d. to 5s. 6d. may be considered as the average value.

WALLABY.—See *Kangaroo*, above.

WALLAROO.—See *Kangaroo*, above.

WOLF.—Size 50x25 in. Is closely allied to the dog tribe and, like the jackals, is found through a wide range of the world,—North and South America, Europe and Asia. Good supplies are available from North America and Siberia and a very few from China. The best are the full furred ones of a very pale bluish-grey with fine flowing black top hair, which are obtained from the Hudson Bay district. Those from the United States and Asia are harsher in quality and browner. A few black American specimens come into the market, but usually the quality is poor compared to the lighter furred animal. The Siberian is smaller than the North American and the Russian still smaller. Besides the wolf proper a large number of prairie or dog wolves from America and Asia are used for cheaper rugs. In size they are less than half that of a large wolf and are of a motley sandy colour. Numbers of the Russian are retained for home use. The finest wolves are very light weighted and most suitable for carriage aprons, in fact, ideal for the purpose, though lacking the strength of some other furs.

Wolves . . . value 2s. 6d. to 64s.

Dog wolves . . . 1s. to 2s. 6d.

WOLFHIRE.—Size 16x18 in. Is native to America, Siberia, Russia and Scandinavia and generally partakes of the nature of a bear. The underwool is full and thick with strong and bright top hair about 2½ in. long. The colour is of two or three shades of brown in one skin, the centre being an oval dark saddle, edged as it were with quite a pale tone and merging to a darker one towards the flanks. This peculiar character alone stamps it as a distinguished fur, in addition to which it has the excellent advantage of being the most durable fur for carriage aprons, as well as the richest in colour. It is not prolific, added to which it is very difficult to match a number of skins in quality as well as colour. Hence it is an expensive fur, but its excellent qualities make it valuable. The darkest of the least coarse skins are worth the most. Prices from 6s. to 37s.

WOMBAT, KOALA OR AUSTRALIAN BEAR.—Size 20x12 in. Has light grey or brown close thick wool half an inch deep without any top hair, with a rather thick spongy pelt. It is quite inexpensive and only suitable for cheap rough coats, carriage rugs, perambulator aprons and linings for footbags. The coats are largely used in western America and Canada. Value 3d. to 1s. 8½d.

Preparing and Dressing.—A furrier or skin merchant must possess a good eye for colour to be successful, the difference in value on this subtle matter solely (in the rarer precious sorts, especially sables, natural black, silver and blue fox, sea otters, chinchillas, fine mink, &c.) being so considerable that not only a practised but an intuitive sense of colour is necessary to accurately determine the exact merits of every skin. In addition to this a knowledge is required of what the condition of a pelt should be; a good judge knows by experience whether a skin will turn out soft and strong, after dressing, and whether the hair is in the best condition of strength and beauty. The dressing of the pelt or skin that is to be preserved for fur is totally different to the making of leather; in the latter tannic acid is used, but never should be with a fur skin, as is so often done by natives of districts where a regular fur trade is not carried on. The results of applying tannic acid are to harden the pelt and discolour and weaken the fur. The best methods for dressing fur skins are those of a tawer or currier, the aim being to retain all the natural oil in the pelt, in order to preserve the natural colour of the fur, and to render the pelt as supple as possible. Generally the skins are placed in an alkali bath, then by hand with a blunt wooden instrument the moisture of the pelt is worked out and it is drawn carefully to and fro over a straight, dull-edged knife to remove any superfluous flesh and unevenness. Special grease is then rubbed in and the skin placed in a machine which softly and continuously beats in the softening mixture, after which it is put into a slowly revolving drum, fitted with wooden paddles, partly filled with various kinds of fine hard sawdust according to the nature of the furs dealt with. This process with a moderate degree of heat thoroughly cleans it of external greasy matter,

and all that is necessary before manufacturing is to gently tap the fur upon a leather cushion stuffed with horsehair with smooth canes of a flexibility suited to the strength of the fur. After dressing most skins alter in shape and decrease in size.

With regard to the merits of European dressing, it may be fairly taken that English, German and French dressers have specialties of excellence. In England, for instance, the dressing of sables, martens, foxes, otters, seals, bears, lions, tigers and leopards is first rate; while with skunk, mink, musquash, chinchillas, beavers, lambs and squirrels, the Germans show better results, particularly in the last. The pelt after the German dressing is dry, soft and white, which is due to a finishing process where meal is used, thus they compare favourably with the moister and consequently heavier English finish. In France they do well with cheaper skins, such as musquash, rabbit and hare, which they dye in addition to dressing. Russian dressing is seldom reliable; not only is there an unpleasant odour, but in damp weather the pelts often become clammy, which is due to the saline matter in the dressing mixture. Chinese dressing is white and supple, but contains much powder, which is disagreeable and difficult to get rid of, and in many instances the skin is rendered so thin that the roots of the fur are weakened, which means that it is liable to shed itself freely, when subject to ordinary friction in handling or wearing. American and Canadian dressing is gradually improving, but hitherto their results have been inferior to the older European methods.

In the case of seal and beaver skins the process is a much more difficult one, as the water or hard top hairs have to be removed by hand after the pelt has been carefully rendered moist and warm. With seal skins the process is longer than with any other fur preparation and the series of processes engage many specialists, each man being constantly kept upon one section of the work. The skins arrive simply salted. After being purchased at the auction sales they are washed, then stretched upon a hoop, when all blubber and unnecessary flesh is removed, and the pelt is reduced to an equal thickness, but not so thin as it is finally rendered. Subsequently the hard top hairs are taken out as in the case of otters and beavers and the whole thoroughly cleaned in the revolving drums. The close underwool, which is of a slightly wavy nature and mostly of a pale drab colour, is then dyed by repeated applications of a rich dark brown colour, one coat after another, each being allowed to thoroughly dry before the next is put on, till the effect is almost a lustrous black on the top. The whole is again put through the cleaning process and evenly reduced in thickness by revolving emery wheels, and eventually finished off in the palest buff colour.

The English dye for seals is to-day undoubtedly the best; its constituents are more or less of a trade secret, but the principal ingredients comprise gall nuts, copper dust, camphor and antimony, and it would appear after years of careful watching that the atmosphere and particularly the water of London are partly responsible for good and lasting results. The Paris dyers do excellent work in this direction, but the colour is not so durable, probably owing to a less pure water. In America of late, strides have been made in seal dyeing, but preference is still given to London work. In Paris, too, they obtain beautiful results in the "topping" or colouring Russian sables and the Germans are particularly successful in dyeing Persian lambs and foxes in all blue, grey, black and smoke colours and in the insertion of white hairs in imitation of the real silver fox. Small quantities of good beaver are dyed in Russia occasionally, and white hairs put in so well that an effect similar to sea otter is obtained.

The process of inserting white hairs is called in the trade "pointing," and is either done by stitching them in with a needle or by adhesive caoutchouc.

The Viennese are successful in dyeing marmot well, and their cleverness in colouring it with a series of stripes to represent the natural markings of sable which has been done after the garments have been made, so as to obtain symmetry of lines, has secured for them a large trade among the dealers of cheap furs in England and the continent.

Manufacturing Methods and Specialties.—In the olden times

the Skinners' Company of the city of London was an association of furriers and skin dressers established under royal charter granted by Edward III. At that period the chief concern of the body was to prevent buyers from being imposed upon by sellers who were much given to offering old furs as new; a century later the Skinners' Company received other charters empowering them to inspect not only warehouses and open markets, but workrooms. In 1667 they were given power to scrutinize the preparing of rabbit or cony wool for the wool trade and the registration of the then customary seven years' apprenticeship. To-day all these privileges and powers are in abeyance, and the interest that they took in the fur trade has been gradually transferred to the leather-dressing craft.

The work done by English furriers was generally good, but since about 1865 has considerably improved on account of the influx of German workmen, who have long been celebrated for excellent fur work, being in their own country obliged to satisfy officially appointed experts and to obtain a certificate of capacity before they can be there employed. The French influence upon the trade has been, and still is, primarily one of style and combination of colour, bad judgment in which will mar the beauty of the most valuable furs. It is a recognized law among high-class furriers that furs should be simply arranged, that is, that an article should consist of one fur or of two furs of a suitable contrast, to which lace may be in some cases added with advantage. As illustrative of this, it may be explained that any brown tone of fur such as sable, marten, mink, black marten, beaver, nutria, &c., will go well upon black or very dark-brown furs, while those of a white or grey nature, such as ermine, white lamb, chinchilla, blue fox, silver fox, opossum, grey squirrel, grey lamb, will set well upon seal or black furs, as Persian lamb, broadtail, astrachan, caracul lamb, &c. White is also permissible upon some light browns and greys, but brown motley colours and greys should never be in contrast. One neutralizes the other and the effect is bad. The qualities, too have to be considered—the fulness of one, the flatness of the other, or the coarseness or fineness of the furs. The introduction of a third fur in the same garment or indiscriminate selection of colours of silk linings, braids, buttons, &c., often spoils an otherwise good article.

With regard to the natural colours of furs, the browns that command the highest prices are those that are of a bluish rather than a reddish tendency. With greys it is those that are bluish, not yellow, and with white those that are purest, and with black the most dense, that are most esteemed and that are the rarest.

Perhaps for ingenuity and the latest methods of manipulating skins in the manufacturing of furs the Americans lead the way, but as fur cutters are more or less of a roving and cosmopolitan character the larger fur businesses in London, Berlin, Vienna, St Petersburg, Paris and New York are guided by the same thorough and comparatively advanced principles.

During the period just mentioned the tailors' methods of scientific pattern cutting have been adopted by the leading furriers in place of the old chance methods of fur cutters, so that to-day a fur garment may be as accurately and gracefully fitted as plush or velvet, and with all good houses a material pattern is fitted and approved before the skins are cut.

Through the advent of German and American fur sewing-machines since about 1890 fur work has been done better and cheaper. There are, however, certain parts of a garment, such as the putting in of sleeves and placing on of collars, &c., that can only be sewn by hand. For straight seams the machines are excellent, making as neat a seam as is found in glove work, unless, of course, the pelts are especially heavy, such as bears and sheep rugs.

A very great feature of German and Russian work is the fur linings called rotondes, sacques or plates, which are made for their home use and exportation chiefly to Great Britain, America and France.

In Weissenfels, near Leipzig, the dressing of Russian grey squirrel and the making it into linings is a gigantic industry, and is the principal support of the place. After the dressing process the backs of the squirrels are made up separately from the under

and thinner white and grey parts, the first being known as squirrel-back and the other as squirrel-lock linings. A few linings are made from entire skins and others are made from the quite white pieces, which in some instances are spotted with the black ear tips of the animals to resemble ermine. The smaller and uneven pieces of heads and legs are made up into linings, so there is absolutely no waste. Similar work is done in Russia on almost as extensive a scale, but neither the dressing nor the work is so good as the German.

The majority of heads, gills or throats, sides or flanks, paws and pieces of skins cut up in the fur workshops of Great Britain, America and France, weighing many tons, are chiefly exported to Leipzig, and made up in neighbouring countries and Greece, where labour can be obtained at an alarmingly low rate. Although the sewing, which is necessarily done by hand, the sections being of so unequal and tortuous a character, is rather roughly executed, the matching of colours and qualities is excellent. The enormous quantities of pieces admit of good selection and where odd colours prevail in a lining it is dyed. Many squirrel-lock linings are dyed blue and brown and used for the outside of cheap garments. They are of little weight, warm and effective, but not of great durability.

The principal linings are as follows: Sable sides, sable heads and paws, sable gills, mink sides, heads and gills, martens sides, heads and gills, Persian lamb pieces and paws, caracul lamb pieces or paws, musquash sides and heads, nutria sides, genet pieces, raccoon sides or flanks, fox sides, kolinski whole skins, and small rodents as kaluga and hamster. The white stripes cut out of skunks are made into rugs.

Another great source of inexpensive furs is China, and for many years past enormous quantities of dressed furs, many of which are made up in the form of linings and Chinese loose-shaped garments, have been imported by England, Germany and France for the lower class of business; the garments are only regarded as so much fur and are reworked. With, however, the exception of the best white Tibet lambs, the majority of Chinese furs can only be regarded as inferior material. While the work is often cleverly done as to matching and manipulation of the pelt which is very soft, there are great objections in the odour and the brittleness or weakness of the fur. One of the most remarkable results of the European intervention in the Boxer rising in China (1900) was the absurd price paid for so-called "loot" of furs, particularly in mandarins' coats of dyed and natural fox skins and pieces, and natural ermine, poor in quality and yellowish in colour; from three to ten times their value was paid for them when at the same time huge parcels of similar quality were warehoused in the London docks, because purchasers could not be found for them.

With regard to Japanese furs, there is little to commend them. The best are a species of raccoon usually sold as fox, and, being of close long quality of fur, they are serviceable for coats, collars, muffs and carriage aprons. The sables, martens, minks and otters are poor in quality, and all of a very yellow colour and they are generally dyed for the cheap trade. A small number of very pretty guanaco and vicuna carriage rugs are imported into Europe, and many come through travellers and private sources, but generally they are so badly dressed that they are quite brittle upon the leather side. Similar remarks are applicable to opossum rugs made in Australia. From South Africa a quantity of jackal, hyena, fox, leopard and sheep karosses, *i.e.* a peculiarly shaped rug or covering used by native chiefs, is privately brought over. The skins are invariably tanned and beautifully sewn, the furs are generally flat in quality and not very strong in the hair, and are retained more as curiosities than for use as a warm covering.

Hatters' Furs and Cloths and Showls.—The hat trade is largely interested in the fur piece trade, the best felt hats being made from beaver and musquash wool and the cheaper sorts from nutria, hare and rabbit wools. For weaving, the most valuable pieces are mohair taken from the angora and vicuna. They are limited in quantity and costly, and the trade depends upon various sorts of other sheep and goat wools for the bulk of its productions.

Frauds and Imitations.—The opportunities for cheating in the fur trade are very considerable, and most serious frauds have been perpetrated in the selling of sables that have been coloured or "topped"; that is, just the tips of the hair stained dark to represent more expensive skins. It is only by years of experience that some of these colourings can be detected. Where the skins are heavily dyed it is comparatively easy to see the difference between a natural and a dyed colour, as the underwool and top hair become almost alike and the leather is also dark, whereas in natural skins the base of the underwool is much paler than the top, or of a different colour, and the leather is white unless finished in a pale reddish tone as is sometimes the case when mahogany sawdust is used in the final cleaning. As has been explained, sable is a term applied for centuries past to the darker sorts of the Russian Siberian martens, and for years past the same term has been bestowed by the retail trade upon the American and Canadian martens. The baum and stone martens caught in France, the north of Turkey and Norway are of the same family, but coarser in underwool and the top hair is less in quantity and not so silky. The kolinski, or as it is sometimes styled Tatar sable, is the animal, the tail of which supplies hair for artists' brushes. This is also of the marten species and has been frequently offered, when dyed dark, as have baum and stone martens, as Russian sables. Hares, too, are dyed a sable colour and advertised as sable. The fur, apart from a clumsy appearance, is so brittle, however, as to be of scarcely any service whatever.

Among the principal imitations of other furs is musquash, out of which the top hair has been pulled and the undergrowth of wool clipped and dyed exactly the same colour as is used for seal, which is then offered as seal or red river seal. Its durability, however, is far less than that of seal. Rabbit is prepared and dyed and frequently offered as "electric sealskin." Nutria also is prepared to represent sealskin, and in its natural colour, after the long hairs are plucked out, it is sold as otter or beaver. The wool is, however, poor compared to the otter and beaver, and the pelt thin and in no way comparable to them in strength. White hares are frequently sold as white fox, but the fur is weak, brittle and exceedingly poor compared to fox and possesses no thick underwool. Foxes, too, and badger are dyed a brownish black, and white hairs inserted to imitate silver fox, but the white hairs are too coarse and the colour too dense to mislead any one who knows the real article. But if sold upon its own merits, pointed fox is a durable fur.

Garments made of sealskin pieces and Persian lamb pieces are frequently sold as if they were made of solid skins, the term "pieces" being simply suppressed. The London Chamber of Commerce have issued to the British trade a notice that any misleading term in advertising and all attempts at deception are illegal and offenders are liable under the Merchandise Marks Act 1887.

The most usual misnaming of manufactured furs is as follow:—

Musquash, pulled and dyed	Sold as seal.
Nutria, pulled and dyed	Sold as seal.
Nutria, pulled and natural	Sold as beaver.
Rabbit, sheared and dyed	Sold as seal or electric seal.
Otter, pulled and dyed.	Sold as seal.
Marmot, dyed	Sold as mink or sable.
Fitch, dyed	Sold as sable.
Rabbit, dyed	Sold as sable or French sable.
Hare, dyed	Sold as sable, or fox, or lynx.
Musquash, dyed	Sold as mink or sable.
Wallaby, dyed	Sold as skunk.
White Rabbit	Sold as ermine.
White Rabbit, dyed	Sold as chinchilla.
White Hare, dyed or natural	Sold as fox, foxaline, and other similar names.
Goat, dyed	Sold as bear, leopard, &c.
Dyed manufactured articles of all kinds.	Sold as "natural."
White hairs inserted in foxes and sables	Sold as real or natural furs.
Kids	Sold as lamb or broadtails.
American sable	Sold as real Russian sable.
Mink	Sold as sable.

The Preservation of Furs.—For many years the stability

have been preserved in cold storage, but it is only within a recent period owing to the difficulty there was in obtaining the necessary perfectly dry atmosphere, that dressed and made-up furs have been preserved by freezing. Furs kept in such a condition are not only immune from the ravages of the larvae of moth, but all the natural oils in the pelt and fur are conserved, so that its colour and life are prolonged, and the natural deterioration is arrested. Sunlight has a tendency to bleach furs and to encourage the development of moth eggs, therefore continued exposure is to be avoided. When furs are wetted by rain they should be well shaken and allowed to dry in a current of air without exposure to sun or open fire.

Where a freezing store for furs is not accessible, furs should be well shaken and afterwards packed in linen and kept in a perfectly cool dry place, and examined in the summer at periods of not less than five weeks. Naphthalene and the usual malodorous powders are not only very disagreeable, but quite useless. Any chemical that is strong enough to destroy the life in a moth egg would also be sufficiently potent to injure the fur itself. In England moth life is practically continuous all the year round, that is, as regards those moths that attack furs, though the destructive element exists to a far greater extent during spring and summer.

Comparative Durability of Various Furs and Weight of Unlined Skins per Square Foot.

The following estimates of durability refer to the use of fur when made up "hair outside" in garments or stoles, not as a lining. The durability of fur used as linings, which is affected by other conditions, is set forth separately. Otter, with its water hairs removed, the strongest of furs for external use, is, in this table, taken as the standard at 100 and other furs marked accordingly:—

The Precious Furs.

	Points of Durability.	Weight in oz. per sq. ft.
Sable	60	2½
Seal	75	3
Fox, Silver or Black	40	3
" White	30	3
Ermine	25	3½
Chinchilla	15	3½
Sea-otter (for stoles or collars)	100	4½

The Less Valuable Furs.

	Points of Durability.	Weight in oz. per sq. ft.
Sable "topped," i.e. top hairs coloured	55	2½
" tinted, i.e. fur all coloured	50	2½
Baum Marten, natural	65	2½
" " tinted	45	2½
Stone Marten	40	2½
Nutria	27	3½
Musquash, natural	37	3½
" water hairs removed, sheared and seal finished,	33	3½
Skunk	70	2½
Mink	70	3½
Lynx, natural	25	2½
" tinted black	20	2½
Marmot, tinted	10	3
Fox, tinted black	25	3
" blue	20	3
Opossum	37	3
Otter (with water hairs)	100	4
" (water hairs removed)	95	3½
Beaver (water hairs cut level with fur) (water hairs removed)	85	4
Moleskin	7	3½
Persian Lamb	65	3½
Grey	30	3½
Broadtail	15	3½
Caracul Kid	10	3½
" Lamb	15	3½
Squirrel	25	1½
Hare	5	1½
Rabbit	5	2½

¹ Stout, old-fashioned boxcloth is almost the only cloth that (after a soft, heavy lining has been added to it) affords even two-

Quantities of Fur needed, in Square Feet.

The "Paris Model" figure is the basis of these estimates for ladies' garments, the standard measurements being height 5 ft. 6 in., waist 23 in., bust 38 in.

	Sq. Ft. (approximate).
Straight stole ¼ length (just below the waist line)	2½
Straight stole ½ length (just below the knee)	3½
Stole, broad enough at the neck to cover the top of arm ¼ length	5
The same, full length (to hem of skirt)	6
Eton jacket, without collar	13
Plain cape, 15 in. long	6½
Deep cape, 30 in. long	15
Full cape with broad stole front, ¾ length	15
Inverness cape (to knee)	25
Double-breasted, straight, semi-fitting coat, covering hips	16
Double-breasted sacque jacket, 36 in. long, full sleeves	20
Same, 30 in. long	18
Same, 22 in. long	15
Long, full, shawl cape with points at back and front, well below knee	15
Shorter shawl cape	16
Motoring or driving coat, ¾ length	27
Motoring or driving coat, full length	27

Weight and Durability of Furs for Men's Coat Linings.

Otter with the water hairs removed, the strongest fur suited for linings, is here taken as the standard.

	Points of Durability.	Weight in oz. per sq. ft.
Otter (the water hairs removed)	100	3½
Beaver " "	90	3½
Mink " "	90	3½
Sealskin	75	3
Raccoon	75	4½
Persian lamb or astrachan	70	3½
Sable	65	2½
Musquash	55	3½
Nutria	40	3½
Grey Opossum	40	3
Wallaby	30	3½
Squirrel	30	1½
Hamster	15	1½
Rabbit	10	2½

Durability and Weight of Linings for Ladies' Coats or Wraps.

Sable gills, the strongest fur suited for ladies' linings, is taken as the standard.

	Points of Durability.	Weight in oz. per sq. ft.
Sable gills	100	2½
Sable	85	2½
Sable paws	64	1½
Ermine	57	1½
Squirrel back	50	1½
Squirrel heads	36	2½
Squirrel lock	21	1½
Hamster	10	1½
Rabbit	7	2½

Durability and Weight of Motoring Furs made up with Fur outside.

Otter with the water hairs, the strongest fur suited for motoring garments, is taken as the standard.

	Points of Durability.	Weight in oz. per sq. ft.
Otter (with water hairs)	100	4
Sealskin, marble	80	3
" Hair Sealskin " (tinted) with water hairs (a special variety of seal)	75	3½
Raccoon	65	4½
Russian Pony	35	2½

thirds as much protection against cold as does fur. It weighs 4.273 oz. per sq. ft. more than the heaviest of coat-furs, and is so rigid as to be uncomfortable, while the subtleness of fur makes it "kind" to the body.

Durability and Weight of Furs for Rugs and Foot-sacks.*

	Points of Durability.	Weight in oz. per sq. ft.
Wolverine	100	6
Bear (black or brown natural)	94	7
Bear (tinted black)	88	7½
Beaver	88	4
Raccoon	77	4½
Opossum	61	3
Wolf	50	6½
Jackal	27	4½
Australian Bear	16	6
Goat	11	4½

Wolverine, the strongest fur suited for rugs and foot-sacks, is taken as the standard.

For a rug about 20 to 25 sq. ft. of fur are needed, for a foot-sack 14.

FURAZANES (*fu-ro-a-n'-diazoles*), organic compounds obtained by heating the glyoximes (dioximes of ortho-diketones) with alkalis or ammonia. Dimethylfurazane is prepared by heating dimethylglyoxime with excess of ammonia for six hours at 165° C. (L. Wolff, *Ber.*, 1895, 28, p. 70). It is a liquid (at ordinary temperature) which boils at 156° C. (744 mm.). Potassium permanganate oxidizes it first to methylfurazane-carboxylic acid and then to furazanedicarboxylic acid. Methyl-ethylfurazane and diphenylfurazane are also known. By warming oxyfurazane acetic acid with excess of potassium permanganate to 100° C. oxyfurazanecarboxylic acid is obtained (A. Hantzsch and J. Urbahn, *Ber.*, 1895, 28, p. 764). It crystallizes in prisms, which melt at 175° C. Furazanecarboxylic acid is prepared by the action of a large excess of potassium permanganate on a hot solution of furazanepropionic acid. It melts at 107° C., and dissolves in caustic soda, with a deep yellow colour and formation of nitrosocyanacetic acid (L. Wolff and P. F. Ganz, *Ber.*, 1891, 24, p. 1167). Furoxane is an oxide of furazane, considered by H. Wicland to be identical with glyoxime peroxide; Kekulé's dibromnitroacetoneitrile is dibrom-furoxane.

The formulae of the compounds above mentioned are:

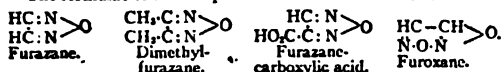

FURETIÈRE, ANTOINE (1619-1688), French scholar and miscellaneous writer, was born in Paris on the 28th of December 1619. He first studied law, and practised for a time as an advocate, but eventually took orders and after various preferments became abbé of Chalvivy in the diocese of Bourges in 1662. In his leisure moments he devoted himself to letters, and in virtue of his satires—*Nouvelle Allégorique, ou histoire des derniers troubles arrivés au royaume d'éloquence* (1658); *Voyage de Mercure* (1653)—he was admitted a member of the French Academy in 1662. That learned body had long promised a complete dictionary of the French tongue; and when they heard that Furetière was on the point of issuing a work of a similar nature, they intererred, alleging that he had purloined from their stores, and that they possessed the exclusive privilege of publishing such a book. After much bitter recrimination on both sides the offender was expelled in 1685; but for this act of injustice he took a severe revenge in his satire, *Couches de l'académie* (Amsterdam, 1687). His *Dictionnaire universel* was posthumously published in 1690 (Rotterdam, 2 vols.). It was afterwards revised and improved by the Protestant jurist, Henri Basnage de Beauval (1656-1710), who published his edition (3 vols.) in 1701; and it was only superseded by the compilation known as the *Dictionnaire de Trévoux* (Paris, 3 vols., 1704; 7th ed., 8 vols., 1772), which was in fact little more than a reimpression of Basnage's edition. Furetière is perhaps even better known as the author of *Le Roman bourgeois* (1666). It cast ridicule on the fashionable romances of Mlle de Scudéry and of La Calprenède, and is of interest as descriptive of the

everyday life of his times. There is no element of burlesque, as in Scarron's *Roman comique*, but the author contents himself with stringing together a number of episodes and portraits; obviously drawn from life, without much attempt at poeuvre. The book was edited in 1854 by Edward Fournier and Charles Asselineau and by P. Jannet.

The *Fureteriano*, which appeared in Paris eight years after Furetière's death, which took place on the 14th of May 1688, is a collection of but little value.

FURFOOZ, a village some 10 m. from Dinant in the Ardennes, Belgium. Three caves containing prehistoric remains were here excavated in 1872. Of these the *Trou de Frontal* is the most famous. In it were found human skeletons with brachycephalic skulls, associated with animal bones, those of the reindeer being particularly plentiful. Among the skeletons was discovered an oval vase of pottery. The Furfooz type of mankind is believed to date from the close of the Quaternary age. G. de Mortillet dates the type in the Robenhausen epoch of the Neolithic period. His theory is that the bones are those of men of that period buried in what had been a cave-dwelling of the Madelenian epoch.

FURFURANE, or **FURANE**, C₄H₄O, a colourless liquid boiling at 32° C., found in the distillation products of pine wood. It was first synthetically prepared by H. Limpricht (*Ann.*, 1873, 165, p. 281) by distilling barium mucate with soda lime, pyromucic acid C₆H₄O·CO₂H being formed, which, on further loss of carbon dioxide, yielded furfuran. A. Hennig (*Ann. chim. phys.*, 1886 [2], 7, p. 220), by distilling erythrite with formic acid, obtained a dihydrofurfuran

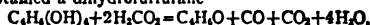

which, on treatment with phosphorus pentachloride, yielded furfuran. Furfuran is insoluble in water and possesses a characteristic smell. It does not react with sodium or with phenylhydrazine, but yields dye-stuffs with isatin and phenanthrenequinone. It reacts violently with hydrochloric acid, producing a brown amorphous substance. Methyl and phenyl derivatives have been prepared by C. Paal (*Ber.*, 1884, 17, p. 915). Paal prepared acetylonyl acetophenone by condensing sodium acetoacetate with phenacylbromide, and this substance on dehydration yields *aa'*-phenylmethylfurfuran, the acetylonyl acetophenone probably reacting in the tautomeric "enolic" form, CH₂:CO·CHNa·COOR + C₆H₅:CO·CH·Br = CH₂:CO·CH(CH₂COC₆H₅)·COOR.

This ester readily hydrolyses, and the acid formed yields acetylonyl acetophenone (by loss of carbon dioxide), which then on dehydration yields the furfuran derivative, thus

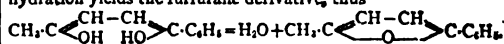

L. Knorr (*Ber.*, 1889, 22, p. 158) obtained diacetosuccinic ester by condensing sodium acetoacetate with iodine, and by dehydrating the ester he prepared *aa'*-dimethylfurfuran *ββ'*-dicarboxylic acid (carbopyrotitric acid), which on distillation yields *aa'*-dimethylfurfuran as a liquid boiling at 94° C. Paal also obtained this compound by using monochloracetone in the place of phenacylbromide. By the distillation of mucic acid or isosaccharic acid, furfuran-*a*-carboxylic acid (pyromucic acid), C₆H₄O·CO₂H, is obtained; it crystallizes in needles or leaflets, and melts at 134° C.

Furfurol (furol), C₆H₄O·CHO, is the aldehyde of pyromucic acid, and is formed on distilling bran, sugar, wood and most carbohydrates with dilute sulphuric acid, or by distilling the pentoses with hydrochloric acid. It is a colourless liquid which boils at 162° C., and is moderately soluble in water; it turns brown on exposure to air and has a characteristic aromatic smell. It shows all the usual properties of an aldehyde, forming a bisulphite compound, an oxime and a hydrazone; whilst it can be reduced to the corresponding furfuryl alcohol by means of sodium amalgam, and oxidized to pyromucic acid by means of silver oxide. It also shows all the condensation reactions of benzaldehyde (*q.v.*); condensing with aldehydes and ketones in the presence of caustic soda to form more complex aldehydes and ketones with unsaturated side chains,

such as furfuralacrolein, $C_5H_4O \cdot CH:CH \cdot CHO$, and furfuralacetone, $C_5H_4O \cdot CH:CH \cdot CO \cdot CH_3$. With alcoholic potassium cyanide it changes to furoin, $C_5H_4O \cdot CHO \cdot CO \cdot C_2H_5O$, which can be oxidized to furil, $C_5H_4O \cdot CO \cdot CO \cdot C_2H_5O$, whilst alcoholic potash converts it into furfuryl alcohol. With fatty acids and acid anhydrides it gives the "Perkin" reaction (see CINNAMIC ACID). Furfuroil is shown to have its aldehydic group in the α position, by conversion into furfurpropionic acid, $C_5H_4O \cdot CH_2 \cdot CH_2 \cdot CO \cdot H$, which on oxidation by bromine water and subsequent reduction of the oxidized product is converted into π -pimelic acid, $HO_2C(CH_2)_4CO_2H$. Furfuroil in minute quantities can be detected by the red colour it forms with a solution of aniline acetate.

Furfurane-*aa'*-dicarboxylic acid or dehydronucic acid, $C_5H_4O(CO_2H)_2$, is formed when mucic acid is heated with hydrochloric acid at $100^\circ C$. On being heated, it loses carbon dioxide and gives pyromucic acid. By digesting acetoacetic ester with sodium succinate and acetic anhydride, methronic acid, $C_5H_8O_5$, is obtained; for the constitution of this acid, see L. Knorr, *Ber.*, 1889, 22, p. 152, and R. Fittig, *Ann.*, 1889, 259, p. 166.

Di- and tetrahydrofurfurane compounds are also known (see A. Lipp, *Ber.*, 1889, 22, p. 1196; W. H. Perkin, *junr. Journ. Chem. Soc.*, 1890, 57, p. 944; and S. Rubemann, *ibid.*, 1896, 69, p. 1383).

FURIES (Lat. *Furiae*, also called *DIRAE*), in Roman mythology an adaptation of the Greek Erinyes (*g.*), with whom they are generally identical. A special aspect of them in Virgil is that of agents employed by the higher gods to stir up mischief, strife and hatred upon earth. Mention may here be made of an old Italian deity Furina (or Furrina), whose worship fell early into disuse, and who was almost forgotten in the time of Varro. By the mythologists of Cicero's time the name was connected with the verb *furere* and the noun *furia*, which in the plural (not being used in the singular in this sense) was accepted as the equivalent of the Greek Erinyes. But it is more probably related to *furvus*, *fuscus*, and signifies one of the spirits of darkness, who watched over men's lives and haunted their abodes. This goddess had her own special priest, a grove across the Tiber where Gaius Gracchus was slain, and a festival on the 25th of July. Authorities differ as to the existence of more than one goddess called Furina, and their identity with the *Forinae* mentioned in two inscriptions found at Rome (*C.I.L.* vi. 422 and 10,200).

FURLONG (from the O. Eng. *furlang*, *i.e.* "farrow-long"), a measure of length, originally the length of a furrow in the "common field" system. As the field in this system was generally taken to be a square, 10 acres in extent, and as the acre varied in different districts and at different times, the "furlong" also varied. The side of a square containing 10 statute acres is 220 yds. or 40 poles, which was the usually accepted length of the furlong. This is also the length of $\frac{1}{4}$ th of the statute mile. "Furlong" was as early as the 9th century used to translate the Latin *stadium*, $\frac{1}{4}$ th of the Roman mile.

FURNACE, a contrivance for the production and utilization of heat by the combustion of fuel. The word is common to all the Romance tongues, appearing in more or less modified forms of the Latin *forname*. But in all those languages the word has a more extended meaning than in English, as it covers every variety of heating apparatus; while here, in addition to furnaces proper, we distinguish other varieties as *ovens*, *stoves* and *kilns*. The first of these, in the form *Ofen*, is used in German as a general term like the French *four*; but in English it has been restricted to those apparatus in which only a moderate temperature, usually below a red heat, is produced in a close chamber. Our bakers' ovens, hot-air ovens or stoves, annealing ovens for glass or metal, &c., would all be called *fours* in French and *Ofen* in German, in common with furnaces of all kinds. Stove, an equivalent of oven, is from the German *Stube*, *i.e.* a heated room, and is commonly so understood; but is also applied to open fire-places, which appears to be somewhat of a departure from the original signification.

Furnaces are constructed according to many different patterns with varying degrees of complexity in arrangement; but all may be considered as combining three essential parts, namely,

the fire-place in which the fuel is consumed, the heated chamber, laboratory, hearth or working bed, as it is variously called, where the heat is applied to the special work for which the furnace is designed, and the apparatus for producing rapid combustion by the supply of air under pressure to the fire. In the simplest cases the functions of two or more of these parts may be combined into one, as in the smith's forge, where the fire-place and heating chamber are united, the iron being placed among the coals, only the air for burning being supplied under pressure from a blowing engine by a second special contrivance, the tuyere, tuiroin, twyer or blast-pipe; but in the more refined modern furnaces, where great economy of fuel is an object, the different functions are distributed over separate and distinct apparatus, the fuel being converted into gas in one, dried in another, and heated in a third, before arriving at the point of combustion in the working chamber of the furnace proper.

Furnaces may be classified according as the products of combustion are employed (1) only for heating purposes, or (2) both for heating and bringing about some chemical change. The furnaces employed for steam-raising or for heating buildings are invariably of the first type (see **BOILER** and **HEATING**), while those employed in metallurgy are generally of the second. The essential difference in construction is that in the first class the substances heated do not come into contact with either the fuel or the furnace gases, whereas in the second they do. Metallurgical furnaces of the first class are termed crucible, muffle or retort furnaces, and of the second shaft and reverberatory furnaces. The following is a detailed subdivision:—

- (1) Fuel and substance in contact.
 - (a) Height of furnace greater than diameter = shaft furnaces.
 - (a) No blast = kilns.
 - (b) With blast = blast furnaces.
 - (b) Height not much greater than diameter = hearth furnaces.
- (2) Substance heated by products of combustion = reverberatory furnaces.
 - (a) Charge not melted = roasting or calcining furnaces.
 - (b) Charge melted = melting furnaces.
- (3) Substance is not directly heated by the fuel or by the products of combustion.
 - (a) Heating chamber fixed and forming part of furnace = muffle furnaces.
 - (b) Crucible furnaces.
 - (c) Retort furnaces.

Another classification may be based upon the nature of the heating agent, according as it is coal (or some similar combustible) oil, gas or electricity. In this article the general principles of metallurgical furnaces will be treated; the subject of gas- and oil-heated furnaces is treated in the article **FUEL**, and of the electric furnace in the article **ELECTROMETALLURGY**. For special furnaces reference should be made to the articles on the industry concerned, *e.g.* **GLASS**, **GAS**, & **Manufacture**, &c.

Shaft, Blast and Hearth Furnaces.—The blast furnace in its simplest form is among the oldest, if not the oldest, of metallurgical contrivances. In the old copper-smelting district of Arabia Petraea, clay blast-pipes dating back to the earlier dynasties of ancient Egypt have been found buried in slag heaps; and in India the native smiths and iron-workers continue to use furnaces of similar types. These, when reduced to their most simple expression, are mere basin-shaped hollows in the ground, containing ignited charcoal and the substances to be heated, the fire being urged by a blast of air blown in through one or more nozzles from a bellows at or near the top. They are essentially the same as the smith's forge. This class of furnace is usually known as an open fire or hearth, and is represented in a more advanced stage of development by the Catalan, German and Walloon forges formerly used in the production of malleable iron.

Fig. 1 represents a Catalan forge. The cavity in the ground is represented by a pit of square or rectangular section lined with brick or stone of a kind not readily acted on by heat, about 1½ or 2 ft. deep, usually somewhat larger above than below, with a tuyere or blast-pipe of copper penetrating one of the walls near the top, with a considerable downward inclination, so that the air meets the fuel some way down. In iron-smelting the ore is laid in a heap upon the fuel (charcoal) filling up the hearth, and is gradually brought to the metallic state by the reducing action of the carbon monoxide formed at the tuyere. The metal sinks through the ignited fuel, forming, in the hearth, a spongy mass or ball, which is lifted out by the smelters at the end of each operation, and carried to the forge hammer. The earthy matters form a fusible glass or slag melt, and

collect at the lowest point of the hearth, whence they are removed by opening a hole pierced through the front wall at the bottom. The active portion of such a furnace is essentially that above the blast-pipe, the function of the lower part being merely the collection of the reduced metal; the fire may therefore be regarded as burning in an unconfined space, with the waste of a large amount of its heating power. By continuing the walls of the hearth above the

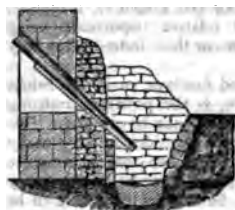

FIG. 1.—Elevation of Catalan Forge.

resist crushing, under the weight due to the head adopted, and the power of the blowing engine to supply blast of sufficient density to overcome the resistance of the closely packed materials to the free passage of the spent gases. The consuming power of the furnace or the rate at which it can burn the fuel supplied is measured by the number of tuyeres and their section.

The development of blast furnaces is practically the development of iron-smelting. The profile has been very much varied at different times. The earliest examples were square or rectangular in horizontal section, but the general tendency of modern practice is to substitute round sections, their construction being facilitated by the use of specially moulded bricks which have entirely superseded the sandstone blocks formerly used. The vertical section, on the other hand, is subject to considerable variation according to the work to which the furnace is applied. Where the operation is simply one of fusion, as in the iron-founder's cupola, in which there is no very great change in volume in the materials on their descent to the tuyeres, the stack is nearly or quite straight-sided; but when, as is the case with the smelting of iron ores with limestone flux, a large proportion of volatile matter has to be removed in the process, a wall of varying inclination is used, so that the body of the furnace is formed of two dissimilar truncated cones, joined by their bases, the lower one passing downwards into a short, nearly cylindrical, position. For further consideration of this subject see IRON AND STEEL.

Hearth furnaces are employed in certain metallurgical operations, e.g. in the air-reduction process for smelting lead ores. The principle is essentially that of the Catalan forge. Such furnaces are very wasteful, and have little to recommend them (see Schnabel, *Metallurgy*, 1905, vol. i. p. 409).

Reverberatory Furnaces.—Blast furnaces are, from the intimate contact between the burden to be smelted and the fuel, the least wasteful of heat; but their use supposes the possibility of obtaining fuel of good quality and free from sulphur or other substances likely to deteriorate the metal produced. In all cases, therefore, where it is desired to do the work out of contact with the solid fuel, the operation of burning or heat-producing must be performed in a special fire-place or combustion chamber, the body of flame and heated gas being afterwards made to act upon the surface of the material exposed in a broad thin layer in the working bed or laboratory of the furnace by reverberation from the low vaulted roof covering the bed. Such furnaces are known by the general name of reverberatory or reverberatory furnaces, also as air or wind furnaces, to distinguish them from those worked with compressed air or blast.

Originally the term cupola was used for the reverberatory furnace, but in the course of time it has changed its meaning, and is now given to a small blast furnace such as that used by iron-founders—reverberatory smelting furnaces in the same trade being called air furnaces.

Figs. 2, 3 and 4 represent a reverberatory furnace such as is used for the fusion of copper ores for regulus, and may be taken as gener-

ally representing its class. The fire-place A is divided from the working bed B by a low wall C known as the fire bridge, and at the opposite end there is sometimes, though not invariably, a second bridge of less height called the flue bridge D. A short diagonal flue

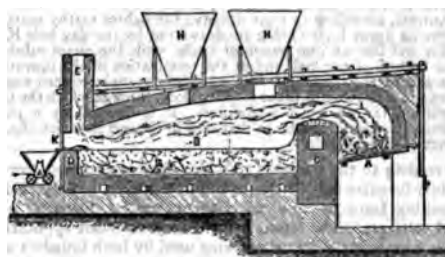

FIG. 2.—Longitudinal section of Reverberatory Furnace.

or up-take E conveys the current of spent flame to the chimney F, which is of square section, diminishing by steps at two or three different heights, and provided at the top with a covering plate or

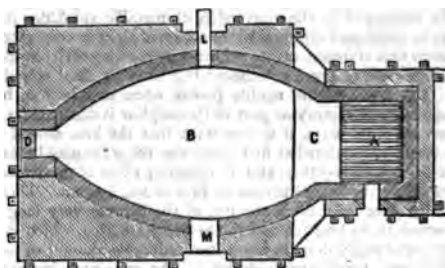

FIG. 3.—Reverberatory Furnace (horizontal section).

damper G, which may be raised or lowered by a chain reaching to the ground, and serves for regulating the speed of the exhaust gases, and thereby the draught of air through the fire. Where several

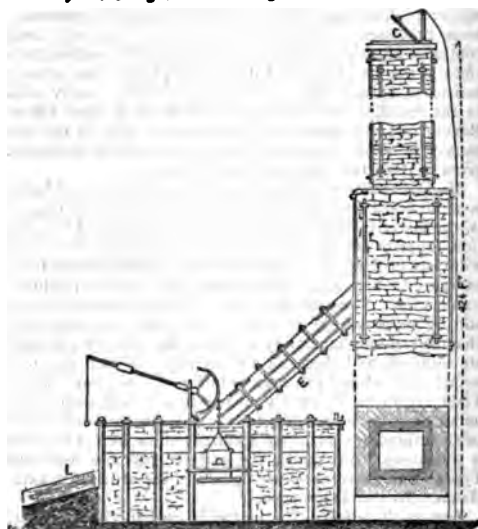

FIG. 4.—Reverberatory Furnace (elevation at flue end).

furnaces are connected with the same chimney stack, the damper takes the form of a sliding plate in the mouth of the connecting flue, so that the draught in one may be modified without affecting the others. The fire bridge is partially protected against the incense

heat of the body of flame issuing through the fire arch by a passage to which the air has free access. The material to be melted is introduced into the furnace from the hoppers HH through the charging holes in the roof. When melted the products separate on the bed (which is made of closely packed sand or other infusible substances), according to their density; the lighter earthy matters forming an upper layer of slag are drawn out by the slag hole K at the fire end into an iron wagon or bogie, while the metal subsides to the bottom of the bed, and at the termination of the operation is run out by the tap hole L into moulds or granulated into water. The opposite opening M is the working door, through which the tool for stirring the charge is introduced. It is covered by a plate suspended to a lever, similar to that seen in the end elevation (fig. 4) in front of the slag hole.

According to the purposes to which they are applied, reverberatory furnaces may be classed into two groups, namely, fusion or melting furnaces, and calcining or wasting furnaces, also called calciners. The former have a very extended application in many branches of industry, being used by both founders and smelters in the fusion of metals; in the concentration of poor metallic compounds by fusion into regulus; in the reduction of lead and tin ores; for refining copper and silver; and for making malleable iron by the puddling processes and welding. Calcining furnaces have a less extended application, being chiefly employed in the conversion of metallic sulphides into oxides by continued exposure to the action of air at a temperature far below that of fusion, or into chlorides by roasting with common salt. As some of these substances (for example, lead sulphide and copper pyrites) are readily fusible when first heated, but become more refractory as part of the sulphur is dissipated and oxygen takes its place, it is important that the heat should be very carefully regulated at first, otherwise the mass may become clotted or fritted together, and the oxidizing effect of the air soon ceases unless the fritted masses be broken small again. This is generally done by making the bed of the furnace very long in proportion to its breadth and to the fire-grate area, which may be the more easily done as a not inconsiderable amount of heat is given out during the oxidation of the ore—such increased length being often obtained by placing two or even three working beds one above the other, and allowing the flame to pass over them in order from below upwards. Such calciners are used especially in roasting zinc blende into zinc oxide, and in the conversion of copper sulphides into chlorides in the wet extraction process. In some processes of lead-smelting, where the minerals treated contain sand, the long calciner is provided with a melting bottom close to the fire-place, so that the desulphurized ore leaves the furnace as a glassy slag or silicate, which is subsequently reduced to the metallic state by fusion with fluxes in blast furnaces. Reverberatory furnaces play an important part in the manufacture of sodium carbonate; descriptions and illustrations are given in the article ALKALI MANUFACTURE.

Muffle, Crucible and Retort Furnaces.—A third class of furnaces is so arranged that the work is done by indirect heating; that is, the material under treatment, whether subjected to calcination, fusion or any other process, is not brought in contact either with fuel or flame, but is raised to the proper temperature by exposure in a chamber heated externally by the products of combustion. These are known as muffle or chamber furnaces; and by supposing the crucibles or retorts to represent similar chambers of only temporary duration, the ordinary pot melting air furnaces, and those for the reduction of zinc ores or the manufacture of coal gas, may be included in the same category. These are almost invariably air furnaces, though sometimes air under pressure is used, as, for example, in the combustion of small anthracitic coal, where a current of air from a fan-blower is sometimes blown under the grate to promote combustion. Types of muffle furnaces are figured in the article ANNEALING, HARDENING AND TEMPERING.

Furnace Materials.—The materials used in the construction of furnaces are divisible into two classes, namely, ordinary refractory or fire-resisting. The former are used principally as casing, walls, pillars or other supporting parts of the structure, and includes ordinary red or yellow bricks, clay-slate, granite and most building stones; the latter are reserved for the parts

immediately in contact with the fuel and flame, such as the lining of the fire-place, the arches, roof and flues, the lower part if not the whole of the chimney lining in reverberatory furnaces, and the whole of the internal walls of blast furnaces. Among such substances are fireclay and firebricks, certain sandstones, silica in the form of ganister, and Dinas stone and bricks, ferric oxide and alumina, carbon (as coke and graphite), magnesia, lime and chromium oxide—their relative importance being indicated by their order, the last two or three indeed being only of limited use.

The most essential point in good fireclays, or in the bricks or other objects made from them, is the power of resisting fusion at the highest heat to which they may be exposed. This supposes them to be free from metallic oxides forming easily fusible compounds with silica, such as lime or iron, the presence of the former even in comparatively small proportion being very detrimental. As clays they must be sufficiently plastic to be readily moulded, but at the same time possess sufficient stiffness not to contract too strongly in drying, whereby the objects produced would be liable to be warped or cracked before firing. In most cases, however, the latter tendency is guarded against, in making up the paste for moulding, by adding to the fresh clay a certain proportion of burnt material of the same kind, such as old bricks or potsherds, ground to a coarse powder. Coke dust or graphite is used for the same purpose in crucible making (see FIREBRICK).

The most highly valued fireclays are derived from the Coal Measures. Among the chief localities are the neighbourhood of Stourbridge in Worcestershire and Stanning near Sheffield, which supply most of the materials for crucibles used in steel and brass melting, and the pots for glass houses; Newcastle-on-Tyne and Glenboig near Glasgow, where heavy blast furnace and other firebricks, gas retorts, &c., are made in large quantities. Coarse-grained but very strong firebricks are also made of the waste of china clay works.

In Belgium the clay raised at Andenne is very largely used for making retorts for zinc furnaces. The principal French fireclays are derived from the Tertiary strata in the south, and more nearly resemble porcelain clays than those of the Coal Measures. They give wares of remarkably fine texture and surface, combined with high refractory character.

In Germany, Ips and Passau on the Danube, and Gross Almerode in Hesse, are the best known localities producing fireclay goods, the crucibles from the last-mentioned place, known as Hessian crucibles, going all over the world. These, though not showing a great resistance to extreme heat, are very slightly affected by sudden alternations in heating, as they may be plunged cold into a strongly heated furnace without cracking, a treatment to which French and Stourbridge pots cannot be subjected with safety.

Plumbago or graphite is largely used in the production of crucibles, not in the pure state but in admixture with fireclay; the proportion of the former varies with the quality from 25 to nearly 50%. These are the most enduring of all crucibles, the best lasting out 70 or 80 meltings in brass foundries, about 50 with bronze, and 8 to 10 in steel-melting.

Silica is used in furnace-building in the forms of sand, ganister, a finely ground sandstone from the Coal Measures of Yorkshire, and the analogous substance known as Dinas clay, which is really nearly pure silica, containing at most about 2½% of bases. Dinas clay is found at various places in the Vale of Neath in South Wales, in the form of a loose disintegrated sandstone, which is crushed between rollers, mixed with about 1% of lime, and moulded into bricks that are fired in kilns at a very high temperature. These bricks are specially used for the roof, fire arches, and other parts subjected to intense heat in reverberatory steel-melting furnaces, and, although infusible under ordinary conditions, are often fairly melted by the heat without fluxing or corrosion after a certain amount of exposure. Ganister, a slightly plastic siliceous sand, is similarly used for the lining of Bessemer steel converters; it is found in the neighbourhood of Sheffield.

Alumina as a refractory material is chiefly used in the form of bauxite, but its applications are somewhat special. It has been found to stand well for the linings of rotatory puddling furnaces, where, under long-continued heating, it changes into a substance as hard and infusible as natural emery. In the

Paris Exhibition of 1878 bricks very hard and dense in character, said to be of pure alumina, were exhibited by Muller & Co. of Paris, as well as bricks of magnesia, the latter being specially remarkable for their great weight. They are intended for use at the extreme temperatures obtainable in steel furnaces, or for the melting of platinum before the oxy-hydrogen blowpipe. For the latter purpose, however, lime is generally used; but as this substance has only small stability, it is usually bedded in a casing of firebrick. Oxide of chromium and chrome iron ore have been proposed as refractory crucible materials. The former may be used as a bed for melting platinum in the same way as lime or magnesia, without affecting the quality of the metal.

Ferric oxide, though not strictly infusible, is largely used as a protecting lining for furnaces in which malleable iron is made, a portion of the ore being reduced and recovered in the process. In an oxidizing atmosphere it is indifferent to silica, and therefore siliceous bricks containing a considerable proportion of ferric oxide, when used in flues of boilers, brewers' coppers, &c. and similar situations, are perfectly fire-resisting so long as the heated gas contains a large proportion of unconsumed air. The red firebricks known as Windsor bricks, which are practically similar in composition to soft red sandstone, are of this character.

The electric furnace has led to the discovery of several important materials, which have been employed as furnace linings. Carborundum (*g.v.*) was applied by Engels in 1899, firebricks being washed with carborundum paste and then baked. Siloxicon, a compound of carbon, silicon and oxygen, formed from carbon and silica in the electric furnace, was patented by E. G. Acheson in 1903. It is very refractory, and is applied by mixing with water and some bond, such as sodium silicate or gas-tar. An amorphous, soft silicon carbide, also formed in the electric furnace, was patented by B. Talbot in 1899. For basic linings, magnesia crystallized in the electric furnace is being extensively used, replacing dolomite to some extent (see E. Kilburn Scott, "Refractory Materials for Furnace Linings," *Faraday Soc.*, 1906, p. 289).

Furnace Construction.—In the construction of furnaces provision has to be made for the unequal expansion of the different parts under the effect of heat. This is especially necessary in the case of reverberatory furnaces, which are essentially weak structures, and therefore require to be bound together by complicated systems of tie rods and uprights or buck staves. The latter are very commonly made of old flat bottom rails, laid with the flat of the flange against the wall. Puddling furnaces are usually entirely cased with iron plates, and blast furnaces with hoops round each course of the stack, or in those of thinner constructions the firebrick work is entirely enclosed in a wrought iron casing or jacket. Such parts as may be subjected to extreme heat and the fretting action of molten material, as the tuyere and slag breasts of blast furnaces, and the fire bridges and bed plates of reverberatory furnaces, are often made in cast iron with double walls, a current of water or air being kept circulating through the intermediate space. In this way the metal, owing to its high conductivity and low specific heat as compared to that of water, is kept at a temperature far below its melting point if the water is renewed quickly enough. It is of course necessary in such cases that the circulation shall be perfectly free, in order to prevent the accumulation of steam under pressure in the interior of the casting. This method has received considerable extension, notably in furnace-smelting of iron ores containing manganese, where the entire hearth is often completely water-cased, and in some lead furnaces where no firebrick lining is used, the lower part of the furnace stack being a mere double iron box cooled by water sufficiently to keep a coating of slag adhering to the inner shell which prevents the metal from being acted upon.

Mechanical Furnaces.—The introduction and withdrawal of the charges in fusion furnaces is effected by gravitation, the solid masses of raw ore, fuel and flux being thrown in at the top, and flowing out of the furnace at the taphole or slag run at the bottom. Vertical kilns, such as those used for burning limestone, are worked in a similar manner—the raw stone going in at the top, and the burnt product falling through holes in the bottom when allowed to do so. With reverberatory calciners, however, where the work is done upon a horizontal bed, a considerable amount of hand labour is expended in raking out the charge when finished, and in drawing slags from fusion furnaces; and more particularly in the puddling process of refining iron the amount of manual exertion required is very much greater. To diminish the item of expenditure on this head, various kinds of mechanical furnaces have been adopted, all of which can be classified under three heads of gravitating furnaces, mechanical stirrers and revolving furnaces.

1. In *gravitating furnaces* the bed is laid at a slope just within the

angle of repose of the charge, which is introduced at the upper end, and is pushed down the slope by fresh material, when necessary, in the contrary direction to the flame which enters at the lower end. Gerstenhofer's pyrites burner is a furnace of this class. It has a tall vertical chamber heated from below, and traversed by numerous narrow horizontal cross bars at different heights. The ore in fine powder is fed in at the top, through a hopper, in a regular thin stream, by a pair of rollers, and in falling lodges on the flats of the bars, forming a talus upon each of the height corresponding to the angle of rest of the material, which is, however, at short intervals removed to lower levels by the arrival of fresh ore from above. In this way a very large surface is exposed to the heat, and the ore, if containing sufficient sulphur to maintain the combustion, is perfectly burned when it arrives at the bottom; if, however, it is imperfectly sized or damp, or if it contains much earthy matter, the result is not very satisfactory. There are many other furnaces in which the same principle is utilized.

2. *Mechanical stirrers* constitute a second division of mechanical furnaces, in which the labour of ruffling or stirring the charges is performed by combinations of levers and wheel-work taking motion from a rotating shaft, and more or less perfectly imitating the action of hand labour. They are almost entirely confined to puddling furnaces.

3. *Revolving furnaces*, the third and most important division of mechanical furnaces, are of two kinds. The first of these resemble an ordinary reverberatory furnace by having a flat bed which, however, has the form of a circular disk mounted on a central shaft, and receives a slow movement of rotation from a water-wheel or other motor, so that every part of the surface is brought successively under the action of the fire, the charge being stirred and ultimately removed by passing under a series of fixed scraper arms placed above the surface at various points. Bruntton's calciner, used in the "burning" of the pyritic minerals associated with tin ore, is a familiar example of this type. The hearth may either rotate on an inclined axis, so that the path of its surface is oblique to that of the flame, or the working part may be a hollow cylinder, between the fireplace and flue, with its axis horizontal or nearly so, whose inner surface represents the working bed, mounted upon friction rollers, and receiving motion from a special steam-engine by means of a central belt of spur gearing. Furnaces of the second kind were first used in alkali works for the conversion of sulphate into carbonate of sodium in the process known as black ash fusion, but have since been applied to other processes. As calciners they are used in tin mines and for the chlorination of silver ores. Mechanical furnaces are figured in the article **ALKALI MANUFACTURE**.

Use of Heated Air.—The calorific intensity of fuel is found to be very considerably enhanced, if the combustion be effected with air previously heated to any temperature between that of boiling water and a dull red heat, the same effect being observed both with solid and gaseous fuel. The latter, especially when brought to the burning point at a high temperature, produces a heat that can be resisted by the most refractory substances only, such as silica, alumina and magnesia. This is attained in the regenerative furnace of Siemens, detailed consideration of which belongs more properly to the subject of iron.

Economy of Waste Heat.—In every system of artificial heating, the amount of heat usefully applied is but a small proportion of that developed by combustion. Even under the most advantageous application, that of evaporation of water in a steam boiler where the gases of the fire have to travel through a great length of flues bounded by thin iron surfaces of great heat-absorbing capacity, the temperature of the current at the chimney is generally much above that required to maintain an active draught in the fireplace; and other tubes containing water, often in considerable numbers, forming the so-called fuel economizers, may often be interposed between the boiler and the chimney with marked advantage as regards saving of fuel. In reverberatory and air furnaces used in the different operations of iron manufacture, where an extremely high temperature has to be maintained in spaces of comparatively small extent, such as the beds of puddling, welding and steel-melting furnaces, the temperature of the exhaust gases is exceedingly high, and if allowed to pass directly into the chimney they appear as a great body of flame at the top. It is now general to save a portion of this heat by passing the flame through flues of steam boilers, air-heating apparatus, or both—so that the steam required for the necessary operations of the forge and heated blast for the furnace itself may be obtained without further expenditure of fuel. The most perfect method of utilizing the waste heat hitherto applied is that of the Siemens regenerator, in which the spent gases are made to travel through chambers, known as regenerators or recuperators of heat, containing a quantity of thin firebricks piled into a cellular mass so as to offer a very large heat-absorbing surface, whereby their temperature is very considerably reduced, and they arrive at the chimney at a heat not exceeding 300 or 400 degrees. As soon as the bricks have become red hot, the current is diverted to an adjacent chamber or pair of chambers, and the acquired heat is removed by a current of cool gas or air passing towards the furnace, where it arrives at a temperature sufficiently high to ensure the greatest possible ~~beneficial~~ effect in combustion.

In iron-smelting blast furnaces the waste gases are of considerable fuel value, and may render important services if properly applied. Owing to the conditions of the work, which require the maintenance of a sensibly reducing atmosphere, they contain a very notable proportion of carbonic oxide, and are drawn off by large wrought iron tubes near the top of the furnace and conveyed by branch pipes to the different boilers and air-heating apparatus, which are now entirely heated by the combustion of such gases, or mixed with air and exploded in gas engines. Formerly they were allowed to burn to waste at the mouth of a short chimney place above the furnace top, forming a huge body of flame, which was one of the most striking features of the Black Country landscape at night.

Laboratory and Portable Furnaces.—Small air-furnaces with hot plates or sand bath flues were formerly much employed in chemical laboratories, as well as small blast furnaces for crucibles heated with charcoal or coke. The use of such furnaces has very considerably diminished, owing to the general introduction of coal-gas for heating purposes in laboratories, which has been rendered possible by the invention of the Bunsen burner, in which the mixture of air and gas giving the least luminous but most powerfully heating flame is effected automatically by the effluent gas. These burners, or modifications of them, have also been applied to muffle furnaces, which are convenient when only a few assays have to be made—the furnace being a mere clay shell and soon brought to a working temperature; but the fuel is too expensive to allow of their being used habitually or on a large scale. Petroleum, or rather the heavy oils obtained in tar refineries, having an equal or superior heating power to coal-gas, may also be used in laboratories for producing high temperatures. The oil is introduced in a thin stream upon a series of inclined and channelled bars, where it is almost immediately volatilized and burnt by air flowing in through parallel orifices. Furnaces of this kind may be used for melting cast iron or bronze in small quantities, and were employed by H. Sainte Claire Deville in experiments in the metallurgy of the platinum group of metals.

Selstrom's blast furnace, used in Sweden for the assay of iron ores, is a convenient form of portable furnace applied to melting in crucibles. It consists of a sheet-iron cylinder about 8 or 9 in. in diameter, within which is fixed one of smaller size lined with fire-clay. The space between the two cylinders serves as a heater and distributor for the blast, which is introduced through the nozzle at the bottom, and enters the furnace through a series of several small tuyeres arranged round the inner lining. Charcoal is the fuel used, and the crucibles stand upon the bottom of the clay lining. When a large body of fuel is required, the cylinder can be lengthened by an iron hoop which fits over the top ring. Deville's portable blast furnace is very similar in principle to the above, but the body of the furnace is formed of a single cast iron cylinder lined with fireclay, closed below by a cast iron plate perforated by a ring of small holes—a hemispherical basin below forming the air-heating chamber.

FURNEAUX, TOBIAS (1735-1781), English navigator, was born at Swilly near Plymouth on the 21st of August 1735. He entered the royal navy, and was employed on the French and African coasts and in the West Indies during the latter part of the Seven Years' War (1760-1763). He served as second lieutenant of the "Dolphin" under Captain Samuel Wallis on the latter's voyage round the globe (August 1766-May 1768); was made a commander in November 1771; and commanded the "Adventure" which accompanied Captain Cook (in the "Resolution") in Cook's second voyage. On this expedition Furneaux was twice separated from his leader (February 8-May 19, 1773; October 22, 1773-July 14, 1774, the date of his return to England). On the former occasion he explored a great part of the south and east coasts of Tasmania, and made the earliest British chart of the same. Most of his names here survive; Cook, visiting this shore-line on his third voyage, confirmed Furneaux's account and delineation of it (with certain minor criticisms and emendations), and named after him the islands in Banks Straits, opening into Bass's Straits, and the group now known as the Low Archipelago. After the "Adventure" was finally separated from the "Resolution" off New Zealand in October 1773, Furneaux returned home alone, bringing with him Omai of Ulaieta. This first South Sea Islander seen in the British Isles returned to his home with Cook in 1776-1777. Furneaux was made a captain in 1775, and commanded the "Syren" in the British attack of the 28th of June 1776 upon Charleston, South Carolina. His successful efforts to introduce domestic animals and potatoes into the South Sea Islands are worthy of note. He died at Swilly on the 19th of September 1781.

See *Hawkesworth's Narrative of Wallis's Voyage*; Captain Cook's *Narrative of His Second Voyage*; also T. Furneaux's life by Rev. Henry Furneaux in the *Dictionary of National Biography*.

FURNES (Flem. *Vurne*), an old-fashioned little town amid the dunes near the coast in West Flanders, Belgium, about 26 m. S.W. of Bruges. Pop. (1904) 6099. It is the centre of a considerable area extending to the French frontier, and its market is an important one for the disposal of corn, stock, hops and dairy produce. During the Norman raids Furnes was destroyed, and the present town was built by Baldwin Bras de Fer, first count of Flanders, about the year 870. At the height of the prosperity of the Flemish communes in the 14th century there were dependent on the barony of Furnes not fewer than fifty-two rich villages, but these have all disappeared, partly no doubt as the consequence of repeated French invasions down to the end of the 18th century, but chiefly through the encroachment of the sea followed by the accumulation of sand along the whole of this portion of the coast. Furnes contains many curious old houses and the church of St Walburga, which is a fine survival of the 13th century with some older portions. The old church and buildings, grouped round the Grand Place, which is the scene of the weekly market, present a quaint picture which is perhaps not to be equalled in the country. Near Furnes on the seashore is the fashionable bathing place called La Panne.

Furnes one day a year becomes a centre of attraction to all the people of Flanders. This is the last Sunday in July, when the fête of Calvary and the Crucifixion is celebrated. Of all popular festivities in Belgium this is the nearest approach to the old Passion Play. The whole story of Christ is told with great precision by means of succeeding groups which typify the different phases of the subject. The people of Furnes pose as Roman soldiers or Jewish priests, as the apostles or mere spectators, while the women put on long black veils so that they may figure in the procession as the just women.

FURNESS, HORACE HOWARD (1833-), American Shakespearian scholar, was born in Philadelphia on the 2nd of November 1833, being the son of William Henry Furness (1802-1896) minister of the First Unitarian church in that city, a powerful preacher and writer. He graduated at Harvard in 1854, and was admitted to the bar in 1859, but soon devoted himself to the study of Shakespeare. He accumulated a collection of illustrative material of great richness and extent, and brought out in 1871 the first volume of a new Variorum edition, designed to represent and summarize the conclusions of the best authorities in all languages—textual, critical and annotative. The volumes appeared as follows: *Romeo and Juliet* (1871); *Macbeth* (1873) (revised edition, 1903); *Hamlet* (2 vols., 1877); *King Lear* (1880); *Othello* (1886); *The Merchant of Venice* (1888); *As You Like It* (1890); *The Tempest* (1892); *A Midsummer Night's Dream* (1895); *The Winter's Tale* (1898); *Much Ado about Nothing* (1899); *Twelfth Night* (1901); *Love's Labour's Lost* (1904). The edition has been generally accepted as a thorough and scholarly piece of work; its chief fault is that, beginning with *Othello* (1886), the editor used the First Folio text as his basis, while in others he makes the text of the Cambridge (Globe) editors his foundation. His wife, Helen Kate Furness (1837-1883), compiled *A Concordance to the Poems of Shakespeare* (1872).

FURNESS, a district of Lancashire, England, separated from the major portion of the county by Morecambe Bay. It is bounded S.E. by this inlet of the Irish Sea, S.W. by the sea, W. by the Duddon estuary and Cumberland, and N. and E. by Westmorland. Its area is about 250 sq. m. It forms the greater part of the North Lonsdale parliamentary division of Lancashire, and contains the parliamentary borough of Barrow-in-Furness. The surface is almost entirely hilly. The northern half is included in the celebrated Lake District, and contains such eminences as the Old Man of Conistone and Wetherlam. Apart from the Duddon, which forms part of the western boundary, the principal rivers are the Leven and Crake, flowing southward into a common estuary in Morecambe Bay. The Leven drains Windermere and the Crake Conistone Lake. The usage of the term "Lake District," however, tends to limit the name of Furness in common thought to the district south of the Lakes, where several of the place-names are suffixed with that of the district, as Barrow-in-Furness, Dalton-in-Furness, Broughton-in-Furness. Between

the Duddon and Morecambe Bay lies Walney Island, 8 m. in length, and in the shallow strait between it and the mainland are several smaller islands. That part of Furness which forms a peninsula between the Leven estuary and Morecambe Bay, and the Duddon estuary, is rich in hematite iron ore, which has been worked from very early times. It was known and smelted by British and Romans, and by the monks of Furness Abbey and Conishead Priory, both in the district. It was owing to the existence of this ore that the town of Barrow grew up in the 19th century; at first as a port from which the ore was exported to South Wales, while later furnaces were established on the spot, and acquired additional importance on the introduction of the Bessemer process, which requires a non-phosphoric ore such as is found here. The hematite is also worked at Ulverston, Askam, Dalton and elsewhere, but the furnaces now depend in part upon ore imported from Spain. The supposed extension of the ore under the sands of the Duddon estuary led to the construction of a sea wall to facilitate the working. The district is served by the main line of the Furness railway, from Carnforth (junction with the London & North-Western railway), passing the pleasant watering-place of Grange, and approximately following the coast by Ulverston, Dalton and Barrow, with branches to Lake Side, Windermere, and to Conistown.

Apart from its industrial importance and scenic attractions, Furness has an especial interest on account of its famous abbey.

The ruins of this, beautifully situated in a wooded valley, are extensive, and mainly of fine transitional Norman and Early English date, acquiring additional picturesqueness from the warm colour of the red sandstone of which they are built. The abbey of Furness, otherwise Furdensia or the further *nese* (promontory), which was dedicated to St. Mary, was founded in 1127 by a small body of monks belonging to the Benedictine order of Savigny. In 1124 they had settled at Tulketh, near Preston, but migrated in 1127 to Furness under the auspices of Stephen, count of Boulogne, afterwards king, at that time lord of the liberty of Furness. In 1148 the brotherhood joined the Cistercian order. Stephen granted to the monks the lordship of Furness, and his charter was confirmed by Henry I., Henry II. and subsequent kings. The abbot's power throughout the lordship was almost absolute; he had a market and fair at Dalton, was free from service to the county and wapentake, and held a sheriff's tourn. By a succession of gifts the abbey became one of the richest in England and was the largest Cistercian foundation in the kingdom. At the Dissolution its revenues amounted to between £750 and £800 a year, exclusive of meadows, pastures, fisheries, mines, mills and salt works, and the wealth of the monks enabled them to practise a regal hospitality. The abbot was one of the twenty Cistercian abbots summoned to the parliament of 1264, but was not cited after 1330, as he did not hold of the king *in capite per baroniam*. The abbey founded several offshoot houses, one of the most important being Rushen Abbey in the Isle of Man. In 1535 the royal commissioners visited the abbey and reported four of its inmates, including the abbot, for incontinence. In 1536 the abbot was charged with complicity in the Pilgrimage of Grace, and on the 7th of April 1537, under compulsion, surrendered the abbey to the king. A few monks were granted pensions, and the abbot was endowed with the profits of the rectory of Dalton, valued at £33, 6s. 8d. per annum. In 1540 the estates and revenues were annexed by act of parliament to the Duchy of Lancaster. About James I.'s reign the site and territories were alienated to the Prestons of Preston-Patrick, from whom they descended to the dukes of Devonshire.

Conishead Priory, near Ulverston, an Augustinian foundation of the reign of Henry II., has left no remains, but of the priory of Cartmel (1188) the fine church is still in use. It is a cruciform structure of transitional Norman and later dates, its central tower having the upper storey set diagonally upon the lower. The chancel contains some superb Jacobean carved oak screens, with stalls of earlier date.

FURNISS, HARRY (1854-), British caricaturist and illustrator, was born at Wexford, Ireland, of English and Scottish

parents. He was educated in Dublin, and in his schooldays edited a *Schoolboy's Punch* in close imitation of the original. He came to London when he was nineteen, and began to draw for the illustrated papers, being for some years a regular contributor to the *Illustrated London News*. His first drawing in *Punch* appeared in 1880, and he joined its staff in 1884. He illustrated Lucy's "Diary of Toby, M.P.," in *Punch*, where his political caricatures became a popular feature. Among his other successes were a series of "Puzzle Heads," and his annual "Royal Academy guy'd." In *Royal Academy Antics* (1890) he published a volume of caricatures of the work of leading artists. He resigned from the staff of *Punch* in 1894, produced for a short time a weekly comic paper *Like Joko*, and in 1898 began a humorous monthly, *Fair Game*; but these were short-lived. Among the numerous books he illustrated were James Payn's *Talk of the Town*, Lewis Carroll's *Sylvie and Bruno*, Gilbert & Beckett's *Comic Blackstone*, G. E. Farrow's *Wallypug Book*, and his own novel, *Poorly Bay* (1905). *Our Joe, his great Fight* (1903), was a collection of original cartoons. His volume of reminiscences, *Confessions of a Caricaturist* (1901), was followed by *Harry Furniss at Home* (1904). In 1905 he published *How to draw in Pen and Ink*, and produced the first number of *Harry Furniss's Christmas Annual*.

FURNITURE (from "furnish," Fr. *fournir*), a general term of obscure origin, used to describe the chattels and fittings required to adapt houses and other buildings for use. Wood, ivory, precious stones, bronze, silver and gold have been used from the most ancient times in the construction or for the decoration of furniture. The kinds of objects required for furniture have varied according to the changes of manners and customs, as well as with reference to the materials at the command of the workman, in different climates and countries. Of really ancient furniture there are very few surviving examples, partly by reason of the perishable materials of which it was usually constructed, and partly because, however great may have been the splendour of Egypt, however consummate the taste of Greece, however luxurious the life of Rome, the number of household appliances was very limited. The chair, the couch, the table, the bed, were virtually the entire furniture of early peoples, whatever the degree of their civilization, and so they remained until the close of what are known in European history as the middle ages. During the long empire-strewn centuries which intervened between the lapse of Egypt and the obliteration of Babylon, the extinction of Greece and the dismemberment of Rome and the great awakening of the Renaissance, household comfort developed but little. The Ptolemies were as well lodged as the Plantagenets, and peoples who spent their lives in the open air, going to bed in the early hours of darkness, and rising as soon as it was light, needed but little household furniture.

Indoor life and the growth of sedentary habits exercised a powerful influence upon the development of furniture. From being splendid, or at least massive, and exceedingly sparse and costly, it gradually became light, plentiful and cheap. In the ancient civilizations, as in the periods when our own was slowly growing, household plenishings, save in the rudest and most elementary forms, were the privilege of the great—no person of mean degree could have obtained, or would have dared to use if he could, what is now the commonest object in every house, the chair (*q.v.*). Sparse examples of the furniture of Egypt, Nineveh, Greece and Rome are to be found in museums; but our chief sources of information are mural and sepulchral paintings and sculptures. The Egyptians used wooden furniture carved and gilded, covered with splendid textiles, and supported upon the legs of wild animals; they employed chests and coffers as receptacles for clothes, valuables and small objects generally. Wild animals and beasts of the chase were carved upon the furniture of Nineveh also; the lion, the bull and the ram were especially characteristic. The Assyrians were magnificent in their household appointments; their tables and couches were inlaid with ivory and precious metals. Cedar and ebony were much used by these great Eastern peoples, and it is probable that they were familiar with rosewood, walnut and teak. Solomon's

bed was of cedar of Lebanon. Greek furniture was essentially Oriental in form; the more sumptuous varieties were of bronze, damascened with gold and silver. The Romans employed Greek artists and workmen and absorbed or adapted many of their mobiliary fashions, especially in chairs and couches. The Roman tables were of splendid marbles or rare woods. In the later ages of the empire, in Rome and afterwards in Constantinople, gold and silver were plentifully used in furniture; such indeed was the abundance of these precious metals that even cooking utensils and common domestic vessels were made of them.

The architectural features so prominent in much of the medieval furniture begin in these Byzantine and late Roman thrones and other seats. These features became paramount as Pointed architecture became general in Europe, and scarcely less so during the Renaissance. Most of the medieval furniture, chests, seats, trays, &c., of Italian make were richly gilt and painted. In northern Europe carved oak was more generally used. State seats in feudal halls were benches with ends carved in tracery, backs panelled or hung with cloths (called cloths of estate), and canopies projecting above. Bedsteads were square frames, the testers of panelled wood, resting on carved posts. Chests of oak carved with panels of tracery, or of Italian cypress (when they could be imported), were used to hold and to carry clothes, tapestries, &c., to distant castles and manor houses; for house furniture, owing to its scarcity and cost, had to be moved from place to place. Copes and other ecclesiastical vestments were kept in chests with ornamental lock plates and iron hinges. The splendour of most feudal houses depended on pictorial tapestries which could be packed and carried from place to place. Wardrobes were rooms fitted for the reception of dresses, as well as for spices and other valuable stores. Excellent carving in relief was executed on caskets, which were of wood or of ivory, with painting and gilding, and decorated with delicate hinge and lock metal-work. The general subjects of sculpture were taken from legends of the saints or from metrical romances. Renaissance art made a great change in architecture, and this change was exemplified in furniture. Cabinets (*g.e.*) and panelling took the outlines of palaces and temples. In Florence, Rome, Venice, Milan and other capitals of Italy, sumptuous cabinets, tables, chairs, chests, &c., were made to the orders of the native princes. Vasari (*Lives of Painters*) speaks of scientific diagrams and mathematical problems illustrated in costly materials, by the best artists of the day, on furniture made for the Medici family. The great extent of the rule of Charles V. helped to give a uniform training to artists from various countries resorting to Italy, so that cabinets, &c., which were made in vast numbers in Spain, Flanders and Germany, can hardly be distinguished from those executed in Italy. Francis I. and Henry VIII. encouraged the revived arts in their respective dominions. *Pietra dura*, or inlay of hard pebbles, agate, lapis lazuli, and other stones, ivory carved and inlaid, carved and gilt wood, marquetry or veneering with thin woods, tortoiseshell, brass, &c., were used in making sumptuous furniture during the first period of the Renaissance. Subjects of carving or relief were generally drawn from the theological and cardinal virtues, from classical mythology, from the seasons, months, &c. Carved altarpieces and woodwork in churches partook of the change in style.

The great period of furniture in almost every country was, however, unquestionably the 18th century. That century saw many extravagances in this, as in other forms of art, but on the whole it saw the richest *floraison* of taste, and the widest sense of invention. This is the more remarkable since the furniture of the 17th century has often been criticized as heavy and coarse. The criticism is only partly justified. Throughout the first three-quarters of the period between the accession of James I. and that of Queen Anne, massiveness and solidity were the distinguishing characteristics of all work. Towards the reign of James II., however, there came in one of the most pleasing and elegant styles ever known in England. Nearly a generation before then Boule was developing in France the splendid and palatial method of inlay which, although he did not invent it,

is inseparably associated with his name. We owe it perhaps to the fact that France, as the neighbour of Italy, was touched more immediately by the Renaissance than England that the reign of heaviness came earlier to an end in that country than on the other side of the Channel. But there is a heaviness which is pleasing as well as one which is forbidding, and much of the furniture made in England any time after the middle of the 17th century was highly attractive. If English furniture of the Stuart period be not sought after to the same extent as that of a hundred years later, it is yet highly prized and exceedingly decorative. Angularity it often still possessed, but generally speaking its elegance of form and richness of upholstery lent it an attraction which not long before had been entirely lacking. Alike in France and in England, the most attractive achievements of the cabinetmaker belong to the 18th century—English Queen Anne and early Georgian work is universally charming; the regency and the reigns of Louis XV. and XVI. formed a period of the greatest artistic splendour. The inspiration of much of the work of the great English school was derived from France, although the groupings after the Chinese taste and the earlier Gothic manner were mainly indigenous. The French styles of the century, which began with excessive flamboyance, closed before the Revolution with a chaste perfection of detail which is perhaps more delightful than anything that has ever been done in furniture. In the achievements of Riesener, David Röntgen, Gouthière, Oeben and Rousseau de la Rotière we have the high-water mark of craftsmanship. The marquetry of the period, although not always beautiful in itself, was executed with extraordinary smoothness and finish; the mounts of gilded bronze, which were the leading characteristic of most of the work of the century, were finished with a minute delicacy of touch which was until then unknown, and has never been rivalled since. If the periods of Francis I. and Henry II., of Louis XIV. and the regency produced much that was sumptuous and even elegant, that of Louis XVI., while men's minds were as yet undisturbed by violent political convulsions, stands out as, on the whole, the one consummate era in the annals of furniture. Times of great achievement are almost invariably followed directly by those in which no tall thistles grow and in which every little shrub is magnified to the dimensions of a forest tree; and the so-called "empire style" which had begun even while the last monarch of the *ancien régime* still reigned, lacked alike the graceful conception and the superb execution of the preceding style. Heavy and usually uninspired, it was nurtured in tragedy and perished amid disaster. Yet it is a profoundly interesting style, both by reason of the classical roots from which it sprang and the attempt, which it finally reflected, to establish new ideas in every department of life. Founded upon the wreck of a lingering feudalism it reached back to Rome and Greece, and even to Egypt. If it is rarely charming, it is often impressive by its severity. Mahogany, satinwood and other rich timbers were characteristic of the style of the end of the 18th century; rosewood was most commonly employed for the choicer work of the beginning of the 19th. Bronze mounts were in high favour, although their artistic character varied materially.

Previously to the middle of the 18th century the only cabinetmaker who gained sufficient personal distinction to have had his name preserved was André Charles Boule; beginning with that period France and England produced many men whose renown is hardly less than that of artists in other media. With Chippendale there arose a marvellously brilliant school of English cabinetmakers, in which the most outstanding names are those of Sheraton, Heppelwhite, Shearer and the Adams. But if the school was splendid it was lamentably short-lived, and the 19th century produced no single name in the least worthy to be placed beside these giants. Whether, in an age of machinery, much room is left for fine individual execution may be doubted, and the manufacture of furniture now, to a great extent, takes place in large factories both in England and on the continent. Owing to the necessary subdivision of labour in these establishments, each piece of furniture passes through numerous distinct workshops. The master and a few artificers formerly

FURNITURE

PLATE I.



Fig. 1.—Venetian Folding Chair of carved and silt walnut, leather back and seat; about 1532.



Fig. 2.—Oak Arm-chair, English, 17th century.

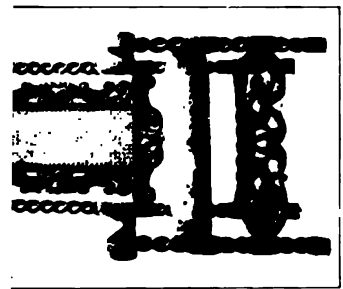

Fig. 3.—Arm-chair, solid seat, cane back; about 1660.



Fig. 4.—Arm-chair, stuffed back and seat; about 1650.



Fig. 5.—Painted and carved High-Back chair with cane back and seat; about 1660.



Fig. 6.—Carved Walnut Chairs, English, early 18th century. The arm-chair is inlaid.

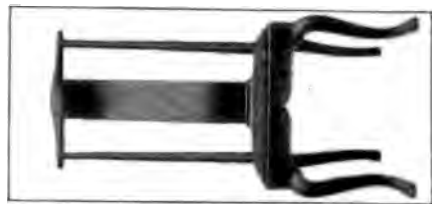

Fig. 7.—Walnut Chair; about 1710.

The chairs in Figs. 1, 2, 6, are in the Victoria and Albert Museum. The rest were lent to the Bethnal Green Exhibition, 1892, and are the property of Lord Zouche (3 and 7), and Earl Brownlow (4).

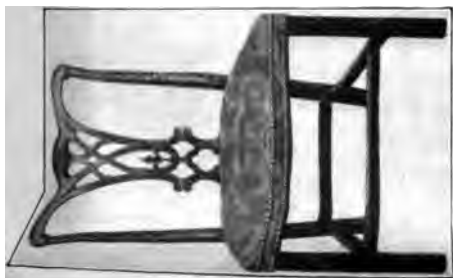

Fig. 8.—Carved Mahogany Chair in the style of Chippendale; and half of 18th century.

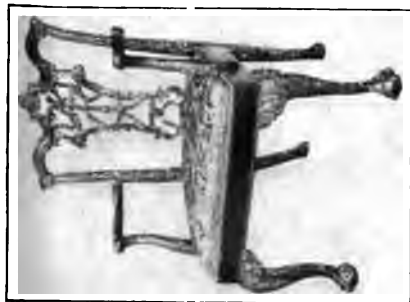

Fig. 9.—Carved Mahogany Arm-chair, in the style of Chippendale, with ribbon pattern.

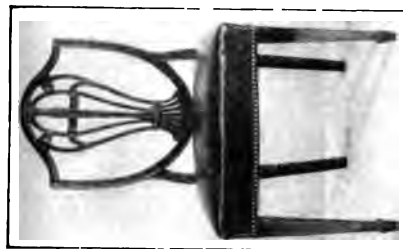

Fig. 10.—Carved and Inlaid Mahogany Chair, in the style of Hepplewhite; late 18th century.

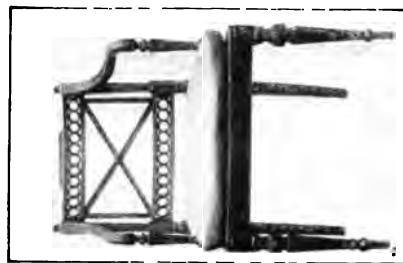

Fig. 11.—Mahogany Chair in the style of Sheraton; about 1780.

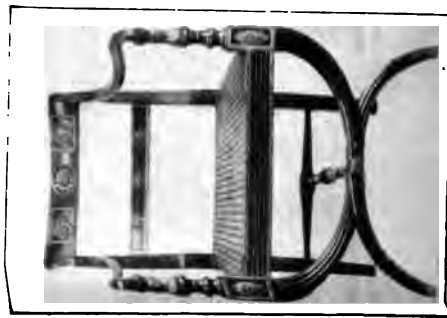

Fig. 12.—Painted and gilt Arm-chair with cane seat, in the style of Adam; about 1790.



Fig. 13.—Arm-chair of carved and gilt wood with stuffed back, seat, and arms. French, Louis XV. style.



Fig. 14.—Mahogany Arm-chair, Empire style, early 19th century, said to have belonged to the Bonaparte family.

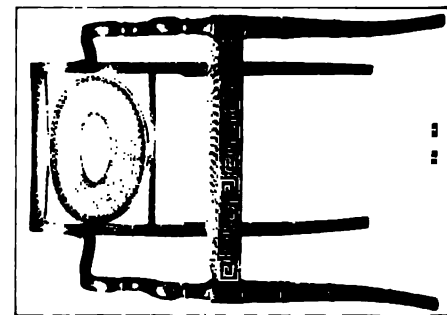

Fig. 15.—Painted and gilt Bench Chair, English, about 1800.

The chairs in Figs. 8, 9, 10, 11, 12, 13, are in the Victoria and Albert Museum, 1862. Fig. 12 is the property of the Bethnal Green Exhibition, 1862. Fig. 13 is the property of St. Spencer Mansions, Park, C.C. The rest by J. H. FitzHenry. Vol. 1.

FURNITURE



Fig. 1.—Front of Oak Coffin with wrought iron bands.
French, 2nd half of 13th century.



Fig. 2.—English Oak Chest, dated 1637.

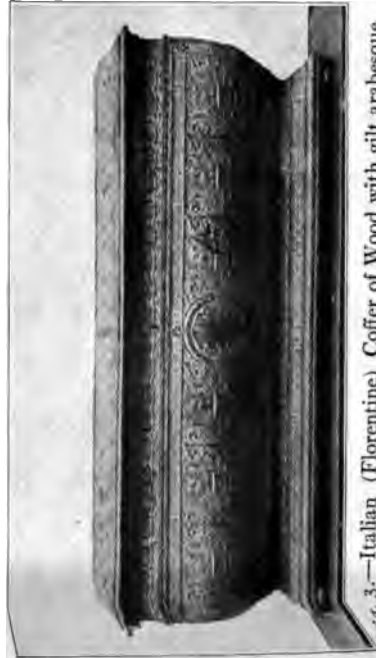

Fig. 3.—Italian (Florentine) Coffin of Wood with gilt arabesque
stucco ornament, about 1480.

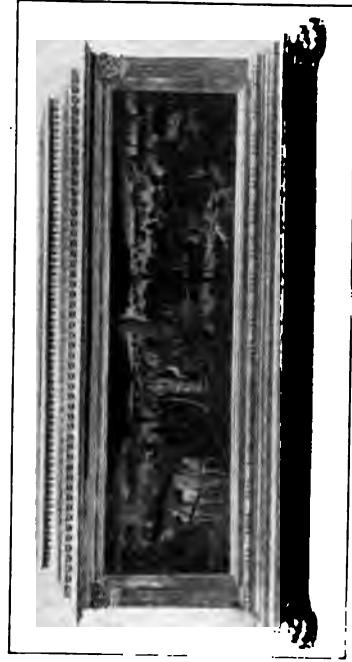

Fig. 4.—Italian "Cassone" or Marriage Coffin, 15th century.
Carved and gilt wood with painted front and ends.

The above are in the Victoria and Albert Museum.



Fig. 6.—Oak Gate-legged Table. English, 17th century.



Fig. 5.—Walnut Table with expanding leaves. Swiss, 17th century.

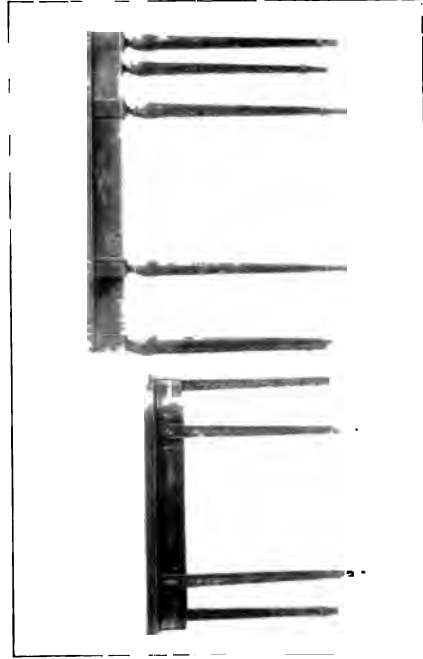

Fig. 8.—Painted Satin-wood Tables, in the style of Sheraton, about 1790.

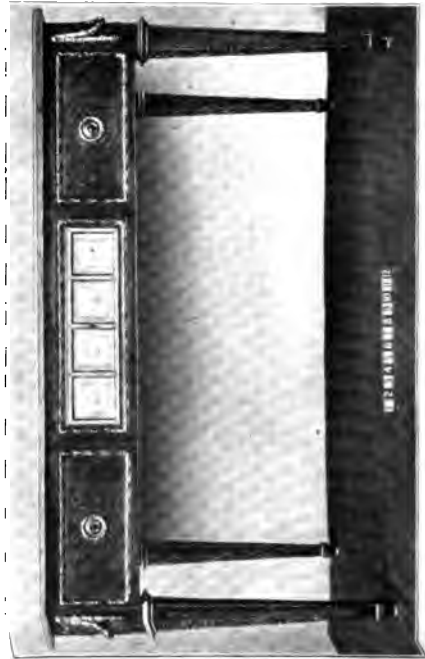

Fig. 7.—Writing Table, French, end of Louis XV. period. Riesener marquetry, ornate mounts and Sévres plaques. The above are in the Victoria and Albert Museum, except Fig. 8, which were in the Bethnal Green Exhibition, 1892.

FURNITURE

PLATE V.



1. Carved Oak Sideboard. English, 17th century. Victoria and Albert Museum.



2. Carved Oak Court Cupboard. English, early 17th century. Victoria and Albert Museum.



3. Ebony Carved Cabinet. The interior decorated with inlaid ivory and coloured woods; French or Dutch, middle of 17th century. Victoria and Albert Museum.



5. Ebony Armoire. With tortoise-shell panels inlaid with brass and other metals, and ormolu mountings. Designed by Bérain, and executed by André Boulle. French, Louis XIV, period. Victoria and Albert Museum.



6. Glass-Fronted Bookcase and Cabinet. Of mahogany. In the style of Sheraton, about 1790. Lent to the Bethnal Green Exhibition by the late Vincent J. Robinson, C.I.E.



4. Veneered Chest of Drawers. About 1690. Lent to Bethnal Green Exhibition by Sir Spencer Ponsonby-Fane, G.C.B.



1. Commode of Pine. With marquetry of brass, ebony, tortoise-shell, mother-of-pearl, ivory, and green-stained bone. "Bouille" work with designs in the style of Pérain. French, late period of Louis XIV.

2. Commode. With panels of Japanese lacquer and ormolu mountings, in the style of Caffieri. French, Louis XV. period.

3. Table of King and Tulip Woods. With ormolu mountings. Louis XV. period.

4. Escritoire à Toilette. Formerly belonging to Marie Antoinette. Of tulip and sycamore woods inlaid with other coloured woods, ormolu mounts. Louis XV. period.



5. Four-Post Bedstead. Of oak inlaid with bog-oak and holly, from the "Inlaid Room" at Sizergh Castle, Westmorland. Latter half of sixteenth century.

6. Carved and Gilt Bedstead. With blue silk damask coverings and hangings. French, late 18th century. Louis XVI. period.





Photos, Mansell & Co.

The "Bureau du Roi," made for Louis XV., now in the Louvre. For description, see Desk.

superintended each piece of work, which, therefore, was never far removed from the designer's eye. Though accomplished artists are retained by the manufacturers of London, Paris and other capitals, there can no longer be the same relation between the designer and his work. Many operations in these modern factories are carried on by machinery. This, though an economy of labour, entails loss of artistic effect. The chisel and the knife are no longer in such cases guided and controlled by the sensitive touch of the human hand.

A decided, if not always intelligent, effort to devise a new style in furniture began during the last few years of the 19th century, which gained the name of "*l'art nouveau*." Its pioneers professed to be free from all old traditions and to seek inspiration from nature alone. Happily nature is less forbidding than many of these interpretations of it, and much of the "new art" is a remarkable exemplification of the impossibility of altogether ignoring traditional forms. The style was not long in degenerating into extreme extravagance. Perhaps the most striking consequence of this effort has been, especially in England, the revival of the use of oak. Lightly polished, or waxed, the cheap foreign oaks often produce very agreeable results, especially when there is applied to them a simple inlay of boxwood and stained holly, or a modern form of pewter. The simplicity of these English forms is in remarkable contrast to the tortured and ungainly outlines of continental seekers after a conscious and unpleasing "originality."

Until a very recent period the most famous collections of historic furniture were to be found in such French museums as the Louvre, Cluny and the Garde Meuble. Now, however, they are rivaled, if not surpassed, by the magnificent collections of the Victoria and Albert Museum at South Kensington, and the Wallace collection at Hertford House, London. The latter, in conjunction with the Jones bequest at South Kensington, forms the finest of all gatherings of French furniture of the great periods, notwithstanding that in the Bureau du Roi the Louvre possesses the most magnificent individual example in existence. In America there are a number of admirable collections representative of the graceful and homely "colonial furniture" made in England and the United States during the Queen Anne and Georgian periods.

See also the separate articles in this work on particular forms of furniture. The literature of the subject has become very extensive, and it is needless to multiply here the references to books. Perrot and Chippiez, in their great *Histoire de l'art dans l'antiquité* (1882 et seq.), deal with ancient times, and A. de Champeaux, in *Le Meuble* (1885), with the middle ages and later period; English furniture is admirably treated by Percy Macquoid in his *History of English Furniture* (1905); and Lady Dilke's *French Furniture in the 18th Century* (1901), and Luke Vincent Lockwood's *Colonial Furniture in America* (1901), should also be consulted. (J. P.-B.)

FURNIVALL, FREDERICK JAMES (1825-1910), English philologist and editor, was born at Egham, Surrey, on the 4th of February 1825, the son of a surgeon. He was called to the bar in 1849, but his attention was soon diverted to philological studies and social problems. He gave Frederick Denison Maurice valuable assistance in the Christian Socialist movement, and was one of the founders of the Working Men's College. For half a century he indefatigably promoted the study of early English literature, partly by his own work as editor, and still more efficaciously by the agency of the numerous learned societies of which he was both founder and director, especially the Early English Text Society (1864), which has been of inestimable service in promoting the study of early and middle English. He also established and conducted the Chaucer, Ballad, New Shakespeare and Wycliff Societies, and at a later period societies for the special study of Browning and Shelley. He edited texts for the Early English Text Society, for the Roxburghe Club and the Rolls Series; but his most important labours were devoted to Chaucer, whose study he as an editor greatly assisted by his "Six-Text" edition of the *Canterbury Tales*, and other publications of the Chaucer Society. He was the honorary secretary of the Philological Society, and was one of the original promoters of the Oxford *New English Dictionary*. He co-operated

with its first editor, Herbert Coleridge, and after his death was for some time principal editor during the preliminary period of the collection of material. The completion of his half-century of labour was acknowledged in 1900 by a handsome testimonial, including the preparation by his friends of a volume of philological essays specially dedicated to him, *An English Miscellany* (Oxford, 1901), and a considerable donation to the Early English Text Society. Dr Furnivall was always an enthusiastic oarsman, and till the end kept up his interest in rowing; with John Beesley in 1845 he introduced the new type of narrow sculling boat, and in 1886 started races on the Thames for sculling fours and sculling eights. He died on the 2nd of July 1910.

FURSE, CHARLES WELLINGTON (1868-1904), English painter, born at Staines, the son of the Rev. C. W. Furse, archdeacon of Westminster, was descended collaterally from Sir Joshua Reynolds, and in his short span of life achieved such rare excellence as a portrait and figure painter that he forms an important link in the chain of British portraiture which extends from the time when Van Dyck was called to the court of Charles I. to our own day. His talent was precocious; at the age of seven he gave indications of it in a number of drawings illustrating Scott's novels. He entered the Slade school in 1884, winning the Slade scholarship in the following year, and completed his education at Julian's atelier in Paris. Hard worker as he was, his activity was frequently interrupted by spells of illness, for he had developed signs of consumption when he was still attending the Slade school. An important canvas called "Cain" was his first contribution (1888) to the Royal Academy, to the associateship of which he was elected in the year of his death. For some years before he had been a staunch supporter of the New English Art Club, to the exhibitions of which he was a regular contributor. He was married in October 1900 to Katherine, daughter of John Addington Symonds. His fondness for sport and of an open-air life found expression in his art and introduced a new, fresh and vigorous note into portraiture. There is never a suggestion of the studio or of the fatiguing pose in his portraits. The sitters appear unconscious of being painted, and are generally seen in the pursuit of their favourite outdoor sport or pastime, in the full enjoyment of life. Such are the "Diana of the Uplands," the "Lord Roberts" and "The Return from the Ride" at the Tate Gallery; the four children in the "Cubbing with the York and Ainsty," "The Lilac Gown," "Mr and Mrs Oliver Fishing" and the portrait of Lord Charles Beresford. Most of these pictures, and indeed nearly all the work completed in the few years of Furse's activity, show a pronounced decorative tendency. His sense of space, composition and decorative design can best be judged by his admirable mural decorations for Liverpool town hall, executed between 1899 and 1902. A memorial exhibition of Furse's paintings and sketches was held at the Burlington Fine Arts Club in 1906.

FÜRST, JULIUS (1805-1873), German Orientalist, was born of Jewish parents at Zerkowo in Posen, on the 12th of May 1805. He studied philosophy and philology at Berlin, and oriental literature at Posen, Breslau and Halle. In 1857 he was appointed to a lectureship at the university of Leipzig, and he was promoted to a professorship in 1864, which he held until his death at Leipzig on the 9th of February 1873. Among his writings may be mentioned *Lehrgebäude der aramäischen Idiome* (Leipzig, 1835); *Librorum sacrorum Veteris Testamenti concordantias Hebraicas atque Chaldaicas* (Leipzig, 1837-1840); *Hebräisches und chaldäisches Wörterbuch* (1851, English translation by S. Davidson 1867); *Kultur und Literaturgeschichte der Juden in Asien* (1849). Fürst also edited a valuable *Bibliotheca Judaica* (Leipzig, 1849-1863), and was the author of some other works of minor importance. From 1840 to 1851 he was editor of *Der Orient*, a journal devoted to the language, literature, history and antiquities of the Jews.

FÜRSTENBERG, the name of two noble houses of Germany. 1. The more important is in possession of a mediatised principality in the district of the Black Forest and the Upper Danube, which comprises the countship of Heiligenberg, about 7 m. to the N. of the Lake of Constance, the landgraviates of Stühlingen and Baar, and the lordships of Jungnau, Trochtelringen, Haxenau

and Möskirch or Messkirch. The territory is discontinuous; and as it lies partly in Baden, partly in Württemberg, and partly in the Prussian province of Sigmaringen, the head of the family is an hereditary member of the first chamber of Baden and of the chamber of peers in Württemberg and in Prussia. The relations of the principality with Baden are defined by the treaty of May 1825, and its relations with Württemberg by the royal declaration of 1839. The *Stammort* or ancestral seat of the family is Fürstenberg in the Black Forest, about 13 m. N. of Schaffhausen, but the principal residence of the present representatives of the main line is at Donaueschingen.

The family of Fürstenberg claims descent from a certain Count Unruoch, a contemporary of Charlemagne, but their authentic pedigree is only traceable to Egino II., count of Urach, who died before 1136. In 1218 his successors inherited the possessions of the house of Zähringen in the Baar district of the Black Forest, where they built the town and castle of Fürstenberg. Of the two sons of Egino V. of Urach, Conrad, the elder, inherited the Breisgau and founded the line of the counts of Freiburg, while the younger, Heinrich (1215-1284), received the territories lying in the Kinzigthal and Baar, and from 1250 onward styled himself first lord, then count, of Fürstenberg. His territories were subsequently divided among several branches of his descendants, though temporarily reunited under Count Friedrich III., whose wife, Anna, heiress of the last count of Wardenberg, brought him the countship of Heiligenberg and lordships of Jungnau and Trochteltingen in 1534. On Friedrich's death (1559) his territories were divided between his two sons, Joachim and Christof I. Of these the former founded the line of Heiligenberg, the latter that of Kinzigthal. The Kinzigthal branch was again subdivided in the 17th century between the two sons of Christof II. (d. 1614), the elder, Wratislaw II. (d. 1642), founding the line of Mösskirch, the younger, Friedrich Rudolf (d. 1655), that of Stühlingen. The Heiligenberg branch received an accession of dignity by the elevation of Count Hermann Egon (d. 1674) to the rank of prince of the Empire in 1664, but his line became extinct with the death of his son Prince Anton Egon, favourite of King Augustus the Strong and regent of Saxony, in 1716. The heads of both the Mösskirch and Stühlingen lines were now raised to the dignity of princes of the Empire (1716). The Mösskirch branch died out with Prince Karl Friedrich (d. 1744); the territories of the Stühlingen branch had been divided on the death of Count Prosper Ferdinand (1662-1704) between his two sons, Joseph Wilhelm Ernst (1699-1762) and Ludwig August Egon (1705-1759). The first of these was created prince of the Empire on the 10th of December 1716, and founded the princely line of the Swabian Fürstenbergs; in 1772 he obtained from the emperor Francis I. for all his legitimate sons and their descendants the right to bear, instead of the style of landgrave, that of prince, which had so far been confined to the reigning head of the family. Ludwig, on the other hand, founded the family of the landgraves of Fürstenberg, who, since their territories lay in Austria and Moravia, were known as the "cadet line in Austria." The princely line became extinct with the death of Karl Joachim in 1804, and the inheritance passed to the Bohemian branch of the Austrian cadet line in the person of Karl Egon II. (see below). Two years later the principality was mediatised.

In 1909 there were two branches of the princely house of Fürstenberg: (1) the main branch, that of Fürstenberg-Donaueschingen, the head of which was Prince Maximilian Egon (b. 1863), who succeeded his cousin Karl Egon III. in 1896; (2) that of Fürstenberg-Königshof, in Bohemia, the head of which was Prince Emil Egon (b. 1876), chamberlain and secretary of legation to the Austro-Hungarian embassy in London (1907). The cadet line of the landgraves of Fürstenberg is now extinct, its last representative having been the landgrave Joseph Friedrich Ernst of Fürstenberg-Weitra (1860-1896), son of the *landgrave Ernst* (1816-1889) by a morganatic marriage. He was not recognised as *ebenbürtig* by the family. The landgraves of Fürstenberg were in 1909 represented only by the landgraves

Theresa (b. 1839) and Gabrielle (b. 1844), daughters of the landgrave Johann Egon (1802-1870).

From the days of Heinrich of Urach, a relative and notable supporter of Rudolph of Habsburg, the Fürstenbergs have played a stirring part in German history as statesmen, ecclesiastics and notably soldiers. There was a popular saying that "the emperor fights no great battle but a Fürstenberg falls." In the Heiligenberg line the following may be more particularly noticed.

FRANZ EGON (1625-1682), bishop of Strassburg, was the elder son of Egon VII., count of Fürstenberg (1588-1635), who served with distinction as a Bavarian general in the Thirty Years' War. He began life as a soldier in the imperial service, but on the elevation of his friend Maximilian Henry of Bavaria to the electorate of Cologne in 1650, he went to his court and embraced the ecclesiastical career. He soon gained a complete ascendancy over the weak-minded elector, and with his brother William Egon (see below), was mainly instrumental in making him the tool of the aggressive policy of Louis XIV. of France. Ecclesiastical preferments were heaped upon him. As a child he had been appointed to a canonry of Cologne; to these he added others at Strassburg, Liège, Hildesheim and Spire; he became also suffragan bishop and dean of Cologne and provost of Hildesheim, and in 1663 bishop of Strassburg. Later he was also prince-abbot of Lüders and Murbach and abbot of Stablo and Malmedy. On the conclusion of a treaty between the emperor and the elector of Cologne, on the 11th of May 1674, Franz was deprived of all his preferments in Germany, and was compelled to take refuge in France. He was, however, amnestied with his brother William by a special article of the treaty of Nijmegen (1679), whereupon he returned to Cologne. After the French occupation of Strassburg (1681) he took up his residence there and died on the 1st of April 1682.

His brother WILLIAM EGON (1629-1704), bishop of Strassburg, began his career as a soldier in the French service. He went to the court of the elector of Cologne at the same time as Franz Egon, whose zeal for the cause of Louis XIV. of France he shared. In 1672 the intrigues of the two Fürstenbergs had resulted in a treaty of offensive alliance between the French monarchy and the electorate of Cologne, and, the brothers being regarded by the Imperialists as the main cause of this disaster, William was seized by imperial soldiers in the monastery of St Pantaleon at Cologne, hurried off to Vienna and there tried for his life. He was saved by the intervention of the papal nuncio, but was kept in prison till the signature of the treaty of Nijmegen (1679). As a reward for his services Louis XIV. appointed him bishop of Strassburg in succession to his brother in 1682; in 1686 obtained for him from Pope Innocent XI. the cardinal's hat, and in 1688 succeeded in obtaining his election as coadjutor-archbishop of Cologne and successor to the elector Maximilian Henry. At the instance of the emperor, however, the pope interposed his veto; the canons followed the papal lead, and, the progress of the Allies against Louis XIV. depriving him of all prospect of success, William Egon retired to France. Here he took up his abode at his abbey of St Germain des Prés near Paris, where he died on the 10th of April 1704.

In the Stühlingen line the most notable was KARL EGON (1796-1854), prince of Fürstenberg, the son of Prince Karl Alois of Fürstenberg, a general in the Austrian service, who was killed at the battle of Loptingen on the 25th of March 1799. In 1804 he inherited the Swabian principality of Fürstenberg and all the possessions of the family except the Moravian estates. He studied at Freiburg and Würzburg, and in 1815 accompanied Prince Schwarzenberg to Paris as staff-officer. In 1817 he came of age, and in the following year married the princess Amalie of Baden. By the mediatisation of his principality in 1806 the greater part of his vast estates had fallen under the sovereignty of the grand-duke of Baden, and Prince Fürstenberg took a conspicuous part in the upper house of the grand-duchy. In politics he distinguished himself by a liberalism rare in a great German noble, carrying through by his personal influence with his peers the abolition of tithes and feudal dues and staunchly

advocating the freedom of the press. He was not less distinguished by his large charities: among other foundations he established a hospital at Donaueschingen. For the industrial development of the country, too, he did much, and proved himself also a notable patron of the arts. His palace of Donaueschingen, with its collections of paintings, engravings and coins, was a centre of culture, where poets, painters and musicians met with princely entertainment. He died on the 14th of September 1869, and was succeeded by his son Karl Egon II. (1820-1892), with the death of whose son, Karl Egon III., in 1896, the title and estates passed to Prince Maximilian Egon, head of the cadet line of Fürstenberg-Pürglitz.

See Münch, *Gesch. des Hauses und des Landes Fürstenberg*, 4 vols. (Aix-la-Chapelle, 1829-1847); S. Riezler, *Gesch. des fürstlichen Hauses Fürstenberg bis 1507* (Tübingen, 1883); *Fürstenbergisches Urkundenbuch*, edited by S. Riezler and F. L. Baumann, vols. i.-vii. (Tübingen, 1877-1891), continued s. tit. *Mitteilungen aus dem fürstlich Fürstenbergischem Archiv* by Baumann and G. Tumbült, 2 vols. (ib. 1899-1902); Stokvis, *Manuel d'histoire* (Leiden, 1890-1893); *Almanach de Gotha*; *Allgemeine deutsche Biographie*.

2. The second Fürstenberg family has its possessions in Westphalia and the country of the Rhine, and takes its name from the castle of Fürstenberg on the Ruhr. The two most remarkable men whom it has produced are Franz Friedrich Wilhelm, freiherr von Fürstenberg, and Franz Egon, count von Fürstenberg-Stammheim. The former (1728-1810) became ultimately vicar-general of the prince-bishop of Münster, and effected a great number of important reforms in the administration of the country, besides doing much for its educational and industrial development. The latter (1797-1859) was an enthusiastic patron of art, who zealously advocated the completion of the Cologne cathedral, and erected the beautiful church of St Apollinaris near Remagen on the Rhine. He was a member of the Prussian Upper House in 1849, collaborated in founding the *Preussisches Wochenblatt*, and was an ardent defender of Catholic interests. His son, Count Gisbert von Fürstenberg-Stammheim (b. 1836), was in 1909 head of the Rhenish line of the house of Fürstenberg.

FÜRSTENWALDE, a town of Germany, in the Prussian province of Brandenburg, on the right bank of the Spree, and on the railway from Berlin to Frankfurt-on-Oder, 28 m. E. of the former city. Pop. (1905) 20,498. Its beautiful cathedral church contains several old monuments. The industries are important, including, besides brewing and malting, manufactures of starch, vinegar, electric lamps and gas-fittings, stoves, &c., iron-founding and wool-weaving. Fürstenwalde is one of the oldest towns of Brandenburg. From 1385 it was the seat of the bishop of Lebus, whose bishopric was incorporated with the electorate of Brunswick in 1595.

FÜRTH, a manufacturing town of Germany, in the kingdom of Bavaria, at the confluence of the Pegnitz with the Regnitz, 5 m. N.W. from Nuremberg by rail, at the junction of lines to Hof and Würzburg. Pop. (1885) 35,455; (1905) 60,638. It is a modern town in appearance, with broad streets and palatial business houses. Of its four Evangelical churches, the old St Michaeliskirche is a handsome structure; but its chief edifices are the new town hall, with a tower 175 ft. high and the magnificent synagogue. The Jews have also a high school, which enjoys a great reputation. There are besides a classical, a wood-carving and an agricultural school and a library. Fürth is the seat of several important industries; particularly, the production of chromolithographs and picture-books, the manufacture of mirrors and mirror-frames, bronze and gold-leaf wares, pencils, toys, haberdashery, optical instruments, silver work, turnery, chicory, machinery, fancy boxes and cases, and an extensive trade is carried on in these goods as also in hops, metals, wool, groceries and coal. A large annual fair is held at Michaelmas and lasts for eleven days. The earliest railway in Germany was that between Nuremberg and Fürth (opened on the 7th of December 1835).

Fürth was founded, according to tradition, by Charlemagne, who erected a chapel there. It was for a time a *Vogtei* (advocateship) under the burgraves of Nuremberg, but about 1314 it was

bequeathed to the see of Bamberg, and in 1806 it came into the possession of Bavaria. In 1632 Gustavus Adolphus besieged it in vain, and in 1634 it was pillaged and burnt by the Croats. It owes its rise to prosperity to the tolerance it meted out to the Jews, who found here an asylum from the oppression under which they suffered in Nuremberg.

See Frommüller, *Chronik der Stadt Fürth* (1887).

FURTWÄNGLER, ADOLF (1853-1907), German archaeologist, was born at Freiburg im Breisgau, and was educated there, at Leipzig and at Munich, where he was a pupil of H. Brunn, whose comparative method in art-criticism he much developed. He took part in the excavations at Olympia in 1878, became an assistant in the Berlin Museum in 1880, and professor at Berlin (1884) and later at Munich. His latest excavation work was at Aegina. He was a prolific writer, with a prodigious knowledge and memory, and a most ingenious and confident critic; and his work not only dominated the field of archaeological criticism but also raised its standing both at home and abroad. Among his numerous publications the most important were a volume on the bronzes found at Olympia, vast works on ancient gems and Greek vases, and the invaluable *Masterpieces of Greek Sculpture* (English translation by Eugénie Strong). He died at Athens on the 10th of October 1907.

FURZE, GORSE or WHIN; botanical name *Ulex* (Ger. *Stechginster*, Fr. *ajonc*), a genus of thorny papilionaceous shrubs, of few species, confined to west and central Europe and north-west Africa. Common furze, *U. europaeus*, is found on heaths and commons in western Europe from Denmark to Italy and Greece, and in the Canaries and Azores, and is abundant in nearly all parts of the British Isles. It grows to a height of 2-6 ft.; it has hairy stems, and the smaller branches end each in a spine; the leaves, sometimes lanceolate on the lowermost branches, are mostly represented by spines from 2 to 6 lines long, and branching at their base; and the flowers, about three-quarters of an inch in length, have a shaggy, yellowish-olive calyx, with two small ovate bracts at its base, and appear in early spring and late autumn. They are yellow and sweet-scented and visited by bees. The pods are few-seeded; their crackling as they burst may often be heard in hot weather. This species comprises the varieties *vulgaris*, or *U. europaeus* proper, which has spreading branches, and strong, many-ridged spines, and *strictus* (Irish furze), with erect branches, and slender 4-edged spines. The other British species of furze is *U. nanus*, dwarf furze, a native of Belgium, Spain and the west of France; it is a procumbent plant, less hairy than *U. europaeus*, with smaller and more orange-coloured flowers, which spring from the primary spines, and have a nearly smooth calyx, with minute basal bracts. Furze, or gorse, is sometimes employed for fences.

Notwithstanding its formidable spines, the young shoots yield a palatable and nutritious winter forage for horses and cattle. To fit it for this purpose it must be chopped and bruised to destroy the spines. This is sometimes done in a primitive and laborious way by laying the gorse upon a block of wood and beating it with a mallet, flat at one end and armed with crossed knife-edges at the other, by the alternate use of which it is bruised and chopped. There are now a variety of machines by which this is done rapidly and efficiently, and which are in use where this kind of forage is used to any extent. The agricultural value of this plant has often been over-rated by theoretical writers. In the case of very poor, dry soils it does, however, yield much valuable food at a season when green forage is not otherwise to be had. It is on this account of importance to dairymen; and to them it has this further recommendation, that cows fed upon it give much rich milk, which is free from any unpleasant flavour. To turn it to good account, it must be sown in drills, kept clean by hoeing, and treated as a regular green crop. If sown in March, on land fitly prepared and afterwards duly cared for, it is ready for use in the autumn of the following year. A succession of cuttings of proper age is obtained for several years from the same field. It is cut by a short stout scythe, and must be brought from the field daily; for when put in a heap it becomes

chopped and bruised it heats rapidly. It is given to horses and cows in combination with chopped hay or straw. An acre will produce about 2000 faggots of green two-year-old gorse, weighing 50 lb each.

This plant is invaluable in mountain sheep-walks. The rounded form of the furze bushes that are met with in such situations shows how diligently the annual growth, as far as it is accessible, is nibbled by the sheep. The food and shelter afforded to them in snowstorms by clusters of such bushes is of such importance that the wonder is our sheep farmers do not bestow more pains to have it in adequate quantity. Young plants of whin are so kept down by the sheep that they can seldom attain to a profitable size unless protected by a fence for a few years. In various parts of England it is cut for fuel. The ashes contain a large proportion of alkali, and are a good manure, especially for peaty land.

FUSARO, LAGO, a lake of Campania, Italy, $\frac{1}{2}$ m. W. of Baia, and 1 m. S. of the acropolis of Cumae. It is the ancient *Acherusia palus*, separated from the sea on the W. by a line of sandhills. It may have been the harbour of Cumae in early antiquity. In the 1st century A.D. an artificial outlet was dug for it at its S. end, with a tunnel, lined with *opus reticulatum* and brick, under the hill of Torregaveta. This hill is covered with the remains of a large villa, which is almost certainly that of Servilius Vatia, described by Seneca (*Epist.* 55). There are remains of other villas on the shores of the lake. Oyster cultivation is carried on there.

See J. Beloch, *Campanien* (2nd ed., Breslau, 1890), 188. (T. As.)

FUSELI, HENRY (1741–1825), English painter and writer on art, of German-Swiss family, was born at Zürich in Switzerland on the 7th of February 1741; he himself asserted in 1745, but this appears to have been a mere whim. He was the second child in a family of eighteen. His father was John Caspar Füssli, of some note as a painter of portraits and landscapes, and author of *Lives of the Helvetic Painters*. This parent destined his son for the church, and with this view sent him to the Caroline college of his native town, where he received an excellent classical education. One of his schoolmates there was Lavater, with whom he formed an intimate friendship.

After taking orders in 1761 Fuseli was obliged to leave his country for a while in consequence of having aided Lavater to expose an unjust magistrate, whose family was still powerful enough to make its vengeance felt. He first travelled through Germany, and then, in 1765, visited England, where he supported himself for some time by miscellaneous writing; there was a sort of project of promoting through his means a regular literary communication between England and Germany. He became in course of time acquainted with Sir Joshua Reynolds, to whom he showed his drawings. By Sir Joshua's advice he then devoted himself wholly to art. In 1770 he made an art-pilgrimage to Italy, where he remained till 1778, changing his name from Füssli to Fuseli, as more Italian-sounding. Early in 1779 he returned to England, taking Zürich on his way. He found a commission awaiting him from Alderman Boydell, who was then organizing his celebrated Shakespeare gallery. Fuseli painted a number of pieces for this patron, and about this time published an English edition of Lavater's work on physiognomy. He likewise gave Cowper some valuable assistance in preparing the translation of Homer. In 1788 Fuseli married Miss Sophia Rawlins (who it appears was originally one of his models, and who proved an affectionate wife), and he soon after became an associate of the Royal Academy. Two years later he was promoted to the grade of Academician. In 1790 he exhibited a series of paintings from subjects furnished by the works of Milton, with a view to forming a Milton gallery corresponding to Boydell's Shakespeare gallery. The number of the Milton paintings was forty-seven, many of them very large; they were executed at intervals within nine years. This exhibition, which closed in 1800, proved a failure as regards profit. In 1799 also he was appointed professor of painting to the Academy. Four years afterwards he was chosen keeper, and resigned his professorship; but he resumed it in 1810, and continued to hold

both offices till his death. In 1805 he brought out an edition of Pilkington's *Lives of the Painters*, which, however, did not add much to his reputation. Canova, when on his visit to England, was much taken with Fuseli's works, and on returning to Rome in 1817 caused him to be elected a member of the first class in the Academy of St Luke. Fuseli, after a life of uninterrupted good health, died at Putney Hill on the 16th of April 1825, at the advanced age of eighty-four, and was buried in the crypt of St Paul's cathedral. He was comparatively rich at his death, though his professional gains had always appeared to be meagre.

As a painter, Fuseli had a daring invention, was original, fertile in resource, and ever aspiring after the highest forms of excellence. His mind was capable of grasping and realizing the loftiest conceptions, which, however, he often spoiled on the canvas by exaggerating the due proportions of the parts, and throwing his figures into attitudes of fantastic and over-strained contortion. He delighted to select from the region of the supernatural, and pitched everything upon an ideal scale, believing a certain amount of exaggeration necessary in the higher branches of historical painting. "Damn Nature! she always puts me out," was his characteristic exclamation. In this theory he was confirmed by the study of Michelangelo's works and the marble statues of the Monte Cavallo, which, when at Rome, he used often to contemplate in the evening, relieved against a murky sky or illuminated by lightning. But this idea was by him carried out to an excess, not only in the forms, but also in the attitudes of his figures; and the violent and intemperate action which he often displays destroys the grand effect which many of his pieces would otherwise produce. A striking illustration of this occurs in his famous picture of "Hamlet breaking from his Attendants to follow the Ghost": Hamlet, it has been said, looks as though he would burst his clothes with convulsive cramps in all his muscles. This intemperance is the grand defect of nearly all Fuseli's compositions. On the other hand, his paintings are never either languid or cold. His figures are full of life and earnestness, and seem to have an object in view which they follow with rigid intensity. Like Rubens he excelled in the art of setting his figures in motion. Though the lofty and terrible was his proper sphere, Fuseli had a fine perception of the ludicrous. The grotesque humpur of his fairy scenes, especially those taken from *A Midsummer-Night's Dream*, is in its way not less remarkable than the poetic power of his more ambitious works. As a colourist Fuseli has but small claims to distinction. He scorned to set a palette as most artists do; he merely dashed his tints recklessly over it. Not unfrequently he used his paints in the form of a dry powder, which he rubbed up with his pencil with oil, or turpentine, or gold size, regardless of the quantity, and depending for accident on the general effect. This recklessness may perhaps be explained by the fact that he did not paint in oil till he was twenty-five years of age. Despite these drawbacks he possessed the elements of a great painter.

Fuseli painted more than 200 pictures, but he exhibited only a minority of them. His earliest painting represented "Joseph interpreting the Dreams of the Baker and Butler"; the first to excite particular attention was the "Nightmare," exhibited in 1782. He produced only two portraits. His sketches or designs numbered about 800; they have admirable qualities of invention and design, and are frequently superior to his paintings.

His general powers of mind were large. He was a thorough master of French, Italian, English and German, and could write in all these tongues with equal facility and vigour, though he preferred German as the vehicle of his thoughts. His writings contain passages of the best art-criticism that English literature can show. The principal work is his series of *Lectures* in the Royal Academy, twelve in number, commenced in 1801.

Many interesting anecdotes of Fuseli, and his relations to contemporary artists, are given in his *Life* by John Knowles, who also edited his works in 3 vols. 8vo, London, 1831. (W. M. R.)

FUSEL OIL (from the Ger. *Fusel*, bad spirits), the name applied to the volatile oily liquids, of a nauseous fiery taste and smell, which are obtained in the rectification of spirituous liquors made by the fermentation of grain, potatoes, the marc of grapes, and

other material, and which, as they are of higher boiling point than ethyl alcohol, occur in largest quantity in the last portions of the distillate. Besides ethyl or ordinary alcohol, and amyl alcohol, which are present in them all, there have been found in fusel oil several other bodies of the $C_nH_{2n+1}OH$ series, also certain ethers, and members of the $C_nH_{2n+1}CO_2H$ series of fatty acids. Normal propyl alcohol is contained in the fusel oil of the marc brandy of the south of France, and isopropyl butyl alcohol in that of beet-root molasses. The chief constituent of the fusel oil procured in the manufacture of alcohol from potatoes and grain, usually known as fusel oil and potato-spirit, is isopropyl amyl alcohol, or isobutylcarbinol. Ordinary fusel oil yields also an isomeric amyl alcohol (active amyl alcohol) boiling at about 128° . Variable quantities of fusel oil, less or greater according to the stage of ripening, exist in commercial spirits (see SPIRITS).

Fusel oil and its chief constituent, amyl alcohol, are direct nerve poisons. In small doses it causes only thirst and headache, with furred tongue and some excitement. In large doses it is a convulsant poison. Impure beverages induce all the graver neurotic and visceral disorders in alcoholism; and, like fusel oil, furfural and the essence of absinthe, are convulsant poisons. Pure ethyl alcohol intoxication, indeed, is rarely seen, being modified in the case of spirits by the higher alcohols contained in fusel oil. According to Rabuteau the toxic properties of the higher alcohols increase with their molecular weight and boiling point. Richet considers that the fusel oil contained in spirits constitutes the chief danger in the consumption of alcoholic beverages. The expert can immediately detect the peculiarly virulent characters of the mixed intoxication due to the consumption of spirits containing a large percentage of fusel oil.

FUSIBLE METAL, a term applied to certain alloys, generally composed of bismuth, lead and tin, which possess the property of melting at comparatively low temperatures. Newton's fusible metal (named after Sir Isaac Newton) contains 50 parts of bismuth, 31.25 of lead and 18.75 of tin; that of Jean Darcelet (1725-1801), 50 parts of bismuth with 25 each of lead and tin; and that of Valentin Rose the elder, 50 of bismuth with 28.1 of lead and 24.1 of tin. These melt between 91° and 95° C. The addition of cadmium gives still greater fusibility; in Wood's metal, for instance, which is Darcelet's metal with half the tin replaced by cadmium, the melting point is lowered to $66^\circ-71^\circ$ C.; while another described by Lipowitz and containing 15 parts of bismuth, 8 of lead, 4 of tin and 3 of cadmium, softens at about 55° and is completely liquid a little above 60° . By the addition of mercury to Darcelet's metal the melting point may be reduced so low as 45° . These fusible metals have the peculiarity of expanding as they cool; Rose's metal, for instance, remains pasty for a considerable range of temperature below its fusing point, contracts somewhat rapidly from 80° to 55° , expands from 55° to 35° , and contracts again from 35° to 0° . For this reason they may be used for taking casts of anatomical specimens or making *dichés* from wood-blocks, the expansion on cooling securing sharp impressions. By suitable modification in the proportions of the components, a series of alloys can be made which melt at various temperatures above the boiling point of water; for example, with 8 parts of bismuth, 8 of lead and 3 of tin the melting point is 123° , and with 8 of bismuth, 30 of lead and 24 of tin it is 172° . With tin and lead only in equal proportions it is 241° . Such alloys are used for making the fusible plugs inserted in the furnace-crowns of steam boilers, as a safeguard in the event of the water-level being allowed to fall too low. When this happens the plug being no longer covered with water is heated to such a temperature that it melts and allows the contents of the boiler to escape into the furnace. In automatic fire-sprinklers the orifices of the pipes are closed with fusible metal, which melts and liberates the water when, owing to an outbreak of fire in the room, the temperature rises above a predetermined limit.

FUSILIER, originally (in French about 1670, in English about 1680) the name of a soldier armed with a light flintlock musket called the fusil; now a regimental designation. Various forms of flintlock small arms had been used in warfare since the middle

of the 16th century. At the time of the English civil war (1642-1652) the term "firelock" was usually employed to distinguish these weapons from the more common matchlock musket. The special value of the firelock in armies of the 17th century lay in the fact that the artillery of the time used open powder barrels for the service of the guns, making it unsafe to allow lighted matches in the muskets of the escort. Further, a military escort was required, not only for the protection, but also for the surveillance of the artillerymen of those days. Companies of "firelocks" were therefore organized for these duties, and out of these companies grew the "fusiliers" who were employed in the same way in the wars of Louis XIV. In the latter part of the Thirty Years' War (1643) fusiliers were simply mounted troops armed with the fusil, as carabiniers were with the carbine. But the escort companies of artillery came to be known by the name shortly afterwards, and the regiment of French Royal Fusiliers, organized in 1671 by Vauban, was considered the model for Europe. The general adoption of the flintlock musket and the suppression of the pike in the armies of Europe put an end to the original special duties of fusiliers, and they were subsequently employed to a large extent in light infantry work, perhaps on account of the greater individual aptitude for detached duties naturally shown by soldiers who had never been restricted to a fixed and unchangeable place in the line of battle. The senior fusilier regiment in the British service, the (7th) Royal Fusiliers (City of London Regiment), was formed on the French model in 1685; the 5th foot (now Northumberland Fusiliers), senior to the 7th in the army, was not at that time a fusilier regiment. The distinctive head-dress of fusiliers in the British service is a fur cap, generally resembling, but smaller than and different in details from, that of the Foot Guards.

In Germany the name "fusilier" is borne by certain infantry regiments and by one battalion in each grenadier regiment.

FUSION, the term generally applied to the melting of a solid substance, or the change of state of aggregation from the solid to the liquid. The term "liquefaction" is frequently employed in the same sense, but is often restricted to the condensation of a gas or vapour. The converse process of freezing or solidification, the change from the liquid to the solid state, is subject to the same laws, and must be considered together with fusion. The solution of a solid in a foreign liquid, and the deposition or crystallization of a solid from a solution, are so closely related to the fusion of a pure substance, that it will also be necessary to consider some of the analogies which they present.

1. *General Phenomena.*—There are two chief varieties of the process of fusion, namely, crystalline and amorphous, which are in many ways distinct, although it is possible to find intermediate cases which partake of the characteristics of both. The melting of ice may be taken as a typical case of crystalline fusion. The passage from rigid solid to mobile liquid occurs at a definite surface without any intermediate stage or plastic condition. The change takes place at a definite temperature, the fusing or freezing point (abbreviated F.P.), and requires the addition of a definite quantity of heat to the solid, which is called the latent heat of fusion. There is also in general a considerable change of volume during fusion, which amounts in the case of ice to a contraction of 9%. Typical cases of amorphous solidification are those of silica, glass, plastic sulphur, pitch, alcohol and many organic liquids. In this type the liquid gradually becomes more and more viscous as the temperature falls, and ultimately attains the rigidity characteristic of a solid, without any definite freezing point or latent heat. The condition of the substance remains uniform throughout, if its temperature is uniform; there is no separation into the two distinct phases of solid and liquid, and there is no sudden change of volume at any temperature.

A change or transition from one crystalline form to another may occur in the solid state with evolution or absorption of heat at a definite temperature, and is analogous to the change from solid to liquid, but usually takes place more slowly owing to the small molecular mobility of the solid state. Thus rhombic sulphur when heated passes slowly at 95.6° C. into the

monosymmetric form which melts at 120°, but if heated rapidly the rhombic form melts at 114.5°. The two forms, rhombic and monosymmetric, can exist in equilibrium at 95.6°, the transition point at which they have the same vapour pressure. Similarly a solid solution of carbon in iron, when cooled slowly, passes at about 700° C., with considerable evolution of heat, into the form of "pearlite," which is soft when cold, but if rapidly chilled the carbon remains in solution and the steel is very hard (see also ALLOYS).

In the case of crystalline fusion it is necessary to distinguish two cases, the homogeneous and the heterogeneous. In the first case the composition of the solid and liquid phases are the same, and the temperature remains constant during the whole process of fusion. In the second case the solid and liquid phases differ in composition; that of the liquid phase changes continuously, and the temperature does not remain constant during the fusion. The first case comprises the fusion of pure substances, and that of eutectics, or cryohydrates; the second is the general case of an alloy or a solution. These have been very fully studied and their phenomena greatly elucidated in recent years.

There is also a sub-variety of amorphous fusion, which may be styled colloid or gelatinous, and may be illustrated by the behaviour of solutions of water in gelatin. Many of these jellies melt at a fairly definite temperature on heating, and coagulate or set at a definite temperature on cooling. But in some cases the process is not reversible, and there is generally marked hysteresis, the temperature of setting and other phenomena depending on the rate of cooling. This case has not yet been fully worked out; but it appears probable that in many cases the jelly possesses a spongy framework of solid, holding liquid in its meshes or interstices. It might be regarded as a case of "heterogeneous" amorphous fusion, in which the liquid separates into two phases of different composition, one of which solidifies before the other. The two phases cannot, as a rule, be distinguished optically, but it is generally possible to squeeze out some of the liquid phase when the jelly has set, which proves that the substance is not really homogeneous. In very complicated mixtures, such as acid lavas or slags containing a large proportion of silica, amorphous and crystalline solidification may occur together. In this case the crystals separate first during the process of cooling, the mother liquor increases gradually in viscosity, and finally sets as an amorphous ground-mass or matrix, in which crystals of different kinds and sizes, formed at different stages of the cooling, remain embedded. The formation of crystals in an amorphous solid after it has set is also of frequent occurrence. It is termed devitrification, but is a very slow process unless the solid is in a plastic state.

2. *Homogeneous Crystalline Fusion.*—The fusion of a solid of this type is characterized most clearly by the perfect constancy of temperature during the process. In fact, the law of constant temperature, which is generally stated as the first of the so-called "laws of fusion," does not strictly apply except to this case. The constancy of the F.P. of a pure substance is so characteristic that change of the F.P. is often one of the most convenient tests of the presence of foreign material. In the case of substances like ice, which melt at a low temperature and are easily obtained in large quantities in a state of purity, the point of fusion may be very accurately determined by observing the temperature of an intimate mixture of the solid and liquid while slowly melting as it absorbs heat from surrounding bodies. But in the majority of cases it is more convenient to observe the freezing point as the liquid is cooled. By this method it is possible to ensure perfect uniformity of temperature throughout the mass by stirring the liquid continuously during the process of freezing, whereas it is difficult to ensure uniformity of temperature in melting a solid, however gradually the heat is supplied, unless the solid can be mixed with the liquid. It is also possible to observe the F.P. in other ways, as by noting the temperature at the moment of the breaking of a wire, of the stoppage of a stirrer, or of the maximum rate of change of volume, but these methods are generally less certain in their indications than the

point of greatest constancy of temperature in the case of homogeneous crystalline solids.

Fusing Points of Common Metals.

Mercury	-38.8°	Antimony	630°
Potassium	62.5°	Aluminium	655°
Sodium	95.6°	Silver	962°
Tin	231.9°	Gold	1064*
Bismuth	269.2°	Copper	1082°
Cadmium	320.7°	Nickel	1427°
Lead	327.7°	Palladium	1535°
Zinc	419.0°	Platinum	1710°

The above table contains some of the most recent values of fusing points of metals determined (except the first three and the last three) with platinum thermometers. The last three values are those obtained by extrapolation with platinum-rhodium and platinum-iridium couples. (See Harker, *Proc. Roy. Soc. A* 76, p. 235, 1905.) Some doubt has recently been raised with regard to the value for platinum, which is much lower than that previously accepted, namely 1775°.

3. *Superfusion, Supersaturation.*—It is generally possible to cool a liquid several degrees below its normal freezing point without a separation of crystals, especially if it is protected from agitation, which would assist the molecules to rearrange themselves. A liquid in this state is said to be "undercooled" or "superfused." The phenomenon is even more familiar in the case of solutions (e.g. sodium sulphate or acetate) which may remain in the "metastable" condition for an indefinite time if protected from dust, &c. The introduction into the liquid under this condition of the smallest fragment of the crystal, with respect to which the solution is supersaturated, will produce immediate crystallization, which will continue until the temperature is raised to the saturation point by the liberation of the latent heat of fusion. The constancy of temperature at the normal freezing point is due to the equilibrium of exchange existing between the liquid and solid. Unless both solid and liquid are present, there is no condition of equilibrium, and the temperature is indeterminate.

It has been shown by H. A. Miers (*Jour. Chem. Soc.*, 1906, 89, p. 413) that for a supersaturated solution in metastable equilibrium there is an inferior limit of temperature, at which it passes into the "labile" state, i.e. spontaneous crystallization occurs throughout the mass in a fine shower. This seems to be analogous to the fine misty condensation which occurs in a supersaturated vapour in the absence of nuclei (see VAPORIZATION) when the supersaturation exceeds a certain limit.

4. *Effect of Pressure on the F.P.*—The effect of pressure on the fusing-point depends on the change of volume during fusion. Substances which expand on freezing, like ice, have their freezing points lowered by increase of pressure; substances which expand on fusing, like wax, have their melting points raised by pressure. In each case the effect of pressure is to retard increase of volume. This effect was first predicted by James-Thomson on the analogy of the effect of pressure on the boiling point, and was numerically verified by Lord Kelvin in the case of ice, and later by Bunsen in the case of paraffin and spermaceti. The equation by which the change of the F.P. is calculated may be proved by a simple application of the Carnot cycle, exactly as in the case of vapour and liquid. (See THERMODYNAMICS.) If L be the latent heat of fusion in mechanical units, v' the volume of unit mass of the solid, and v'' that of the liquid, the work done in an elementary Carnot cycle of range $d\theta$ will be $dp(v''-v')$, if dp is the increase of pressure required to produce a change $d\theta$ in the F.P. Since the ratio of the work-difference or cycle-area to the heat-transferred L must be equal to $d\theta/\theta$, we have the relation

$$d\theta/dp = \theta(v'' - v')/L. \quad (1)$$

The sign of $d\theta$, the change of the F.P., is the same as that of the change of volume ($v'' - v'$). Since the change of volume seldom exceeds 0.1 c.c. per gramme, the change of the F.P. per atmosphere is so small that it is not as a rule necessary to take account of variations of atmospheric pressure in observing a freezing point. A variation of 1 cm. in the height of the barometer would correspond to a change of .001° C. only in the F.P. of ice. This is far beyond the limits of accuracy of most observations. Although the effect of pressure is so small, it produces, as is well known, remarkable results in the motion of glaciers, the moulding and regelation of ice, and many other phenomena. It has also been employed to explain the apparent inversion of the order of crystallization in rocks like granite, in which the arrangement of the crystals indicates that the quartz matrix solidified subsequently to the crystals of

felspar, mica or hornblende embedded in it, although the quartz has a higher melting point. It is contended that under enormous pressure the freezing points of the more fusible constituents might be raised above that of the quartz, if the latter is less affected by pressure. Thus Bunsen found the F.P. of paraffin wax 1.4°C . below that of spermaceti at atmospheric pressure. At 100 atmospheres the two melted at the same temperature. At higher pressures the paraffin would solidify first. The effect of pressure on the silicates, however, is much smaller, and it is not so easy to explain a change of several hundred degrees in the F.P. It seems more likely in this particular case that the order of crystallization depends on the action of superheated water or steam at high temperatures and pressures, which is well known to exert a highly solvent and metamorphic action on silicates.

5. *Variation of Latent Heat.*—C. C. Person in 1847 endeavoured to show by the application of the first law of thermodynamics that the increase of the latent heat per degree should be equal to the difference ($s' - s''$) between the specific heats of the liquid and solid. If, for instance, water at 0°C . were first frozen and then cooled to -1°C ., the heat abstracted per gramme would be $(L' + s't)$ calories. But if the water were first cooled to -1°C ., and then frozen at -1°C ., by abstracting heat L'' , the heat abstracted would be $L'' + s't$. Assuming that the heat abstracted should be the same in the two cases, we evidently obtain $L' - L'' = (s' - s'')t$. This theory has been approximately verified by Petterson, by observing the freezing of a liquid cooled below its normal F.P. (*Jour. Chem. Soc.* 24, p. 151). But his method does not represent the true variation of the latent heat with temperature, since the freezing, in the case of a supercooled liquid, really takes place at the normal freezing point. A quantity of heat $s't$ is abstracted in cooling to $-t$, ($L' - s't$) in raising to 0° and freezing at 0° , and $s''t$ in cooling the ice to $-t$. The latent heat L'' at $-t$ does not really enter into the experiment. In order to make the liquid freeze at a different temperature, it is necessary to subject it to pressure, and the effect of the pressure on the latent heat cannot be neglected. The entropy of a liquid ϕ'' at its F.P. reckoned from any convenient zero ϕ_0 in the solid state may be represented by the expression

$$\phi'' - \phi_0 = \int s' d\theta/\theta + L/\theta. \quad (2)$$

Since $\theta ds'/d\theta = s''$, we obtain by differentiation the relation

$$dL/d\theta = s'' - s' + L/\theta, \quad (3)$$

which is exactly similar to the equation for the specific heat of a vapour maintained in the saturated condition. If we suppose that the specific heats s' and s'' of the solid and liquid at equilibrium pressure are nearly the same as those ordinarily observed at constant pressure, the relation (3) differs from that of Person only by the addition of the term L/θ . Since s' is greater than s'' in all cases hitherto investigated, and L/θ is necessarily positive, it is clear that the latent heat of fusion must increase with rise of temperature, or diminish with fall of temperature. It is possible to imagine the F.P. so lowered by pressure (positive or negative) that the latent heat should vanish, in which case we should probably obtain a continuous passage from the liquid to the solid state similar to that which occurs in the case of amorphous substances. According to equation (3), the rate of change of the latent heat of water is approximately 0.80 calorie per degree at 0°C . (as compared with 0.50, Person), if we assume $s' = 1$, and $s'' = 0.5$. Putting $(s' - s'') = 0.5$ in equation (2), we find $L = 0$ at -160°C . approximately, but no stress can be laid on this estimate, as the variation of $(s' - s'')$ is so uncertain.

6. *Freezing of Solutions and Alloys.*—The phenomena of freezing of heterogeneous crystalline mixtures may be illustrated by the case of aqueous solutions and of metallic solutions or alloys, which have been most widely studied. The usual effect of an impurity, such as salt or sugar in solution in water, is to lower the freezing point, so that no crystallization occurs until the temperature has fallen below the normal F.P. of the pure solvent, the depression of F.P. being nearly proportional to the concentration of the solution. When freezing begins, the solvent generally separates out from the solution in the pure state. This separation of the solvent involves an increase in the strength of the remaining solution, so that the temperature does not remain constant during the freezing, but continues to fall as more of the solvent is separated. There is a perfectly definite relation between temperature and concentration at each stage of the process, which may be represented in the form of a curve as AC in fig. 1, called the freezing point curve. The equilibrium temperature, at the surface of contact between the solid and liquid, depends only on the composition of the liquid phase and not at all on the quantity of solid present. The abscissa of the F.P. curve represents the composition of that portion of the original solution which remains liquid at any temperature. If instead of starting with a dilute solution we start with a strong solution represented by a point N, and cool it as shown by the

vertical line ND, a point D is generally reached at which the solution becomes "saturated." The dissolved substance or "solute" then separates out as the solution is further cooled, and the concentration diminishes with fall of temperature in a definite relation, as indicated by the curve CB, which is called the solubility curve. Though often called by different names, the two curves AC and CB are essentially of a similar nature. To take the case of an aqueous solution of salt as an example, along CB the solution is saturated with respect to salt, along AC the solution is saturated with respect to ice. When the point C is reached along either curve, the solution is saturated with respect to both salt and ice. The concentration cannot vary further, and the temperature remains constant, while the salt and ice crystallize out together, maintaining the exact proportions in which they exist in the solution. The resulting solid was termed a cryohydrate by F. Guthrie, but it is really an intimate mixture of two kinds of crystals, and not a chemical compound or hydrate containing the constituents in chemically equivalent proportions. The lowest temperature attainable by means of a freezing mixture is the temperature of the F.P. of the corresponding cryohydrate. In a mixture of salt and ice with the least trace of water a saturated brine is quickly formed, which dissolves the ice and falls rapidly in temperature, owing to the absorption of the latent heat of fusion. So long as both ice and salt are present, if the mixture is well stirred, the solution must necessarily become saturated with respect to both ice and salt, and this can only occur at the cryohydric temperature, at which the two curves of solubility intersect.



FIG. 1.—F.P. or Solubility Curve: simple case.

The curves in fig. 1 also illustrate the simplest type of freezing point curve in the case of alloys of two metals A and B which do not form mixed crystals of chemical compounds. The alloy corresponding to the cryohydrate, possessing the lowest melting point, is called the eutectic alloy, as it is most easily cast and worked. It generally possesses a very fine-grained structure, and is not a chemical compound. (See ALLOYS.)

To obtain a complete F.P. curve even for a binary alloy is a laborious and complicated process, but the information contained in such a curve is often very valuable. It is necessary to operate with a number of different alloys of suitably chosen composition, and to observe the freezing points of each separately. Each alloy should also be analysed after the process if there is any risk of its composition having been altered by oxidation or otherwise. The freezing points are generally best determined by observing the gradual cooling of a considerable mass, which is well stirred so long as it remains liquid. The curve of cooling may most conveniently be recorded, either photographically, using a thermocouple and galvanometer, as in the method of Sir W. Roberts-Austen, or with pen and ink, if a platinum thermometer is available, according to the method put in practice by C. T. Heycock and F. H. Neville. A typical set of curves obtained in this manner is shown in fig. 2.

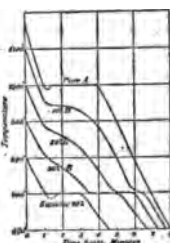

FIG. 2.—Cooling Curves of Alloys: typical case.

When the pure metal A in cooling reaches its F.P. the temperature suddenly becomes stationary, and remains accurately constant for a considerable period. Often it falls slightly below the F.P. owing to superfusion, but rises to the F.P. and remains constant as soon as freezing begins. The second curve shows the cooling of A with 10% of another metal B added. The freezing begins at a lower temperature with the separation of pure A. The temperature

no longer remains constant during freezing, but falls more and more rapidly as the proportion of B in the liquid increases. When the eutectic temperature is reached there is a second F.P. or arrest at which the whole of the remaining liquid solidifies. With 20% of B the first F.P. is further lowered, and the temperature falls faster. The eutectic F.P. is of longer duration, but still at the same temperature. For an alloy of the composition of the eutectic itself there is no arrest until the eutectic temperature is reached, at which the whole solidifies without change of temperature. There is a great advantage in recording these curves automatically, as the primary arrest is often very slight, and difficult to observe in any other way.

7. *Change of Solubility with Temperature.*—The lowering of the F.P. of a solution with increase of concentration, as shown by the F.P. or solubility curves, may be explained and calculated by equation (1) in terms of the osmotic pressure of the dissolved substance by analogy with the effect of mechanical pressure. It is possible in salt solutions to strain out the salt mechanically by a suitable filter or "semi-permeable membrane," which permits the water to pass, but retains the salt. To separate 1 gramme of salt requires the performance of work PV against the osmotic pressure P , where V is the corresponding diminution in the volume of the solution. In dilute solutions, to which alone the following calculation can be applied, the volume V is the reciprocal of the concentration C of the solution in grammes per unit volume, and the osmotic pressure P is equal to that of an equal number of molecules of gas in the same space, and may be deduced from the usual equation of a gas,

$$P = R\theta / VM = R\theta C / M, \quad (4)$$

where M is the molecular weight of the salt in solution, θ the absolute temperature, and R a constant which has the value 8.32 joules, or nearly 2 calories, per degree C. It is necessary to consider two cases, corresponding to the curves CB and AB in fig. 1, in which the solution is saturated with respect to salt and water respectively. To facilitate description we take the case of a salt dissolved in water, but similar results apply to solutions in other liquids and alloys of metals.

(a) If unit mass of salt is separated in the solid state from a saturated solution of salt (curve CB) by forcing out through a semi-permeable membrane against the osmotic pressure P the corresponding volume of water V in which it is dissolved, the heat evolved is the latent heat of saturated solution of the salt Q together with the work done PV . Writing $(Q+PV)$ for L , and V for $(v^* - v')$ in equation (1), and substituting P for p , we obtain

$$Q + PV = V\theta dP/d\theta, \quad (5)$$

which is equivalent to equation (1), and may be established by similar reasoning. Substituting for P and V in terms of C from equation (4), if Q is measured in calories, $R=2$, and we obtain

$$QC = 2PdC/d\theta, \quad (6)$$

which may be integrated, assuming Q constant, with the result

$$2 \log_e C' / C'' = Q(\theta' - \theta''), \quad (7)$$

where C' , C'' are the concentrations of the saturated solution corresponding to the temperatures θ' and θ'' . This equation may be employed to calculate the latent heat of solution Q from two observations of the solubility. It follows from these equations that Q is of the same sign as $dC/d\theta$, that is to say, the solubility increases with rise of temperature if heat is absorbed in the formation of the saturated solution, which is the usual case. If, on the other hand, heat is liberated on solution, as in the case of caustic potash or sulphate of calcium, the solubility diminishes with rise of temperature.

(b) In the case of a solution saturated with respect to ice (curve AC), if one gramme of water having a volume v is separated by freezing, we obtain a precisely similar equation to (5), but with L the latent heat of fusion of water instead of Q , and v instead of V . If the solution is dilute, we may neglect the external work Pv in comparison with L , and also the heat of dilution, and may write P/v for $dP/d\theta$, where t is the depression of the F.P. below that of the pure solvent. Substituting for P in terms of V from equation (4), we obtain

$$t = 2\theta^2 w / LV M = 2\theta^2 w / LW M, \quad (8)$$

where W is the weight of water and w that of salt in a given volume of solution. If M grammes of salt are dissolved in 100 of water, $w=M$ and $W=100$. The depression of the F.P. in this case is called by van t' Hoff the "Molecular Depression of the F.P." and is given by the simple formula

$$t = 0.2\theta^2 / L. \quad (9)$$

Equation (8) may be used to calculate L or M , if either is known, from observations of t , θ , and w/W . The results obtained are sufficiently approximate to be of use in many cases in spite of the rather liberal assumptions and approximations effected in the course of the reasoning. In any case the equations give a simple theoretical basis with which to compare experimental data in order to estimate the order of error involved in the assumptions. We may thus estimate the variation of the osmotic pressure from the value given by the gaseous equation, as the concentration of the

solution or the molecular dissociation changes. The most uncertain factor in the formula is the molecular weight M , since the molecule in solution may be quite different from that denoted by the chemical formula of the solid. In many cases the molecule of a metal in dilute solution in another metal is either monatomic, or forms a compound molecule with the solvent containing one atom of the dissolved metal, in which case the molecular depression is given by putting the atomic weight for M . In other cases, as Cu, Hg, Zn, in solution in cadmium, the depression of the F.P. per atom, according to Heycock and Neville, is only half as great, which would imply a diatomic molecule. Similarly As and Au in Cd appear to be triatomic, and Sn in Pb tetraatomic. Intermediate cases may occur in which different molecules exist together in equilibrium in proportions which vary according to the temperature and concentration. The most familiar case is that of an electrolyte, in which the molecule of the dissolved substance is partly dissociated into ions. In such cases the degree of dissociation may be estimated by observing the depression of the F.P., but the results obtained cannot always be reconciled with those deduced by other methods, such as measurement of electrical conductivity, and there are many difficulties which await satisfactory interpretation.

Exactly similar relations to (8) and (9) apply to changes of boiling point or vapour pressure produced by substances in solution (see VAPORIZATION), the laws of which are very closely connected with the corresponding phenomena of fusion; but the consideration of the vapour phase may generally be omitted in dealing with the fusion of mixtures where the vapour pressure of either constituent is small.

8. *Hydrates.*—The simple case of a freezing point curve, illustrated in fig. 1, is generally modified by the occurrence of compounds of a character analogous to hydrates of soluble salts, in which the dissolved substance combines with one or more molecules of the solvent. These hydrates may exist as compound molecules in the solution, but their composition cannot be demonstrated unless they can be separated in the solid state. Corresponding to each crystalline hydrate there is generally a separate branch of the solubility curve along which the crystals of the hydrate are in equilibrium with the saturated solution. At any given temperature the hydrate possessing the least solubility is the most stable. If two are present in contact with the same solution, the more soluble will dissolve, and the less soluble will be formed at its expense until the conversion is complete. The two hydrates cannot be in equilibrium with the same solution except at the temperature at which their solubilities are equal, i.e. at the point where the corresponding curves of solubility intersect. This temperature is called the "Transition Point." In the case of $ZnSO_4$, as shown in fig. 3, the heptahydrate, with seven molecules of water, is the least soluble

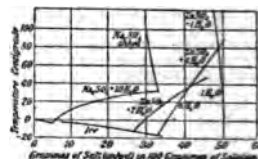

FIG. 3.—Solubility Curves of Hydrates.

greater than that of the heptahydrate below 39°, but increases more slowly with rise of temperature. At about 80° C. the hexahydrate gives place to the monohydrate, which dissolves in water with evolution of heat, and diminishes in solubility with rise of temperature. Intermediate hydrates exist, but they are more soluble, and cannot be readily isolated. Both the mono- and hexahydrates are capable of existing in equilibrium with saturated solutions at temperatures far below their transition points, provided that the less soluble hydrate is not present in the crystalline form. The solubility curves can therefore be traced, as in fig. 3, over an extended range of temperature. The equilibrium of each hydrate with the solvent, considered separately, would present a diagram of two branches similar to fig. 1, but as a rule only a small portion of each curve can be realized, and the complete solubility curve, as experimentally determined, is composed of a number of separate pieces corresponding to the ranges of minimum solubility of different hydrates. Failure to recognize this coupled with the

fact that in strong and viscous solutions the state of equilibrium is but slowly attained, is the probable explanation of the remarkable discrepancies existing in many recorded data of solubility.

Transition Points of Hydrates.

$\text{Na}_2\text{CrO}_4 \cdot 10\text{H}_2\text{O}$. . . 19.9°	$\text{NaBr} \cdot 2\text{H}_2\text{O}$. . . 50.7°
$\text{Na}_2\text{SO}_4 \cdot 10\text{H}_2\text{O}$. . . 32.4	$\text{MnCl}_2 \cdot 4\text{H}_2\text{O}$. . . 57.8°
$\text{Na}_2\text{CO}_3 \cdot 10\text{H}_2\text{O}$. . . 35.1*	$\text{Na}_3\text{PO}_4 \cdot 12\text{H}_2\text{O}$. . . 73.4°
$\text{Na}_2\text{S}_2\text{O}_7 \cdot 5\text{H}_2\text{O}$. . . 48.0°	$\text{Ba}(\text{OH})_2 \cdot 8\text{H}_2\text{O}$. . . 77.9°

The transition points of the hydrates given in the above list Richards, *Proc. Amer. Acad.*, 1899, 34, p. 277) afford well-marked constant temperatures which can be utilized as fixed points for experimental purposes.

9. *Formation of Mixed Crystals.*—An important exception to the general type already described, in which the addition of a dissolved substance lowers the F.P. of the solvent, is presented by the formation of mixed crystals, or "solid solutions," in which the solvent and solute occur mixed in varying proportions. This isomorphous replacement of one substance by another, in the same crystal with little or no change of form, has long been known and studied in the case of minerals and salts, but the relations between composition and melting-point have seldom been investigated, and much still remains obscure. In this case the process of freezing does not necessitate the performance of work of separation of the constituents of the solution, the F.P. is not necessarily depressed, and the effect cannot be calculated by the usual formula for dilute solutions. One of the simplest types of F.P. curve which may result from the occurrence of mixed crystals is illustrated by the case of alloys of gold and silver, or gold and platinum, in which the F.P. curve is nearly a straight line joining the freezing-points of the constituents. The equilibrium between the solid and liquid, in both of which the two metals are capable of mixing in all proportions, bears in this case an obvious and close analogy to the equilibrium between a mixed liquid (e.g. alcohol and water) and its vapour. In the latter case, as is well known, the vapour will contain a larger proportion of the more volatile constituent. Similarly in the case of the formation of mixed crystals, the liquid should contain a larger proportion of the more fusible constituent than the solid with which it is in equilibrium. The composition of the crystals which are being deposited at any moment will, therefore, necessarily change as solidification proceeds, following the change in the composition of the liquid, and the temperature will fall until the last portions of the liquid to solidify will consist chiefly of the more fusible constituent, at the F.P. of which the solidification will be complete. If, however, as seems to be frequently the case, the composition of the solid and liquid phases do not greatly differ from each other, the greater part of the solidification will occur within a comparatively small range of temperature, and the initial F.P. of the alloy will be well marked. It is possible in this case to draw a second curve representing the composition of the solid phase which is in equilibrium with the liquid at any temperature. This curve will not represent the average composition of the crystals, but that of the outer coating only which is in equilibrium with the liquid at the moment. H. W. B. Roozeboom (*Zeit. Phys. Chem.* xxx. p. 385) has attempted to classify some of the possible cases which may occur in the formation of mixed crystals on the basis of J. W. Gibbs's thermodynamic potential, the general properties of which may be qualitatively deduced from a consideration of observed phenomena. But although this method may enable us to classify different types, and even to predict results in a qualitative manner, it does not admit of numerical calculation similar to equation (8), as the Gibbs's function itself is of a purely abstract nature and its form is unknown. There is no doubt that the formation of mixed crystals may explain many apparent anomalies in the study of F.P. curves. The whole subject has been most fruitful of results in recent years, and appears full of promise for the future.

For further details in this particular branch the reader may consult a report by Neville (*Brit. Assoc. Rep.*, 1900), which contains numerous references to original papers by Roberts-Austen, Le Chatelier, Roozeboom and others. For the properties of solutions see SOLUTION.

(H. L. C.)

FUSSEN, a town of Germany, in the kingdom of Bavaria, at the foot of the Alps (Tirol), on the Lech, 2500 ft. above the sea, with a branch line to Oberdorf on the railway to Augsburg. Pop. 4000. It has six Roman Catholic churches, a Franciscan monastery and a castle. Rope-making is an important industry. The castle, lying on a rocky eminence, is remarkable for the peace signed here on the 22nd of April 1745 between the elector Maximilian III., Joseph of Bavaria and Maria Theresa. Two miles to the S.E., immediately on the Austrian frontier, romantically situated on a rock overlooking the Schwanensee, is the magnificent castle of Hohenschwangau, and a little to the north, on the site of an old castle, that of Neuschwanstein, built by Louis II. of Bavaria.

See H. Feistle, *Füssen und Umgebung* (1898).

FUST, JOHANN (?-1466), early German printer, belonged to a rich and respectable burgher family of Mainz, which is known to have flourished from 1423, and to have held many civil and religious offices. The name was always written Fust, but in 1506 Johann Schöffer, in dedicating the German translation of Livy to the emperor Maximilian, called his grandfather Faust, and thenceforward the family assumed this name, and the Fausts of Aschaffenburg, an old and quite distinct family, placed Johann Fust in their pedigree. Johann's brother Jacob, a goldsmith, was one of the burgomasters in 1462, when Mainz was stormed and sacked by the troops of Count Adolf of Nassau, on which occasion he seems to have perished (see a document, dated May 8, 1463, published by Wyss in *Quartalbl. des hist. Vereins für Hessen*, 1879, p. 24). There is no evidence that, as is commonly asserted, Johann Fust was a goldsmith, but he appears to have been a money-lender or banker. On account of his connexion with Gutenberg (q.v.), he has been represented by some as the inventor of printing, and the instructor as well as the partner of Gutenberg, by others as his patron and benefactor, who saw the value of his discovery and supplied him with means to carry it out, whereas others paint him as a greedy and crafty speculator, who took advantage of Gutenberg's necessity and robbed him of the fruits of his invention. However this may be, the Helmasperger document of November 6, 1455, shows that Fust advanced money to Gutenberg (apparently 800 guilders in 1450, and another 800 in 1452) for carrying on his work, and that Fust, in 1455, brought a suit against Gutenberg to recover the money he had lent, claiming 2020 (more correctly 2026) guilders for principal and interest. It appears that he had not paid in the 300 guilders a year which he had undertaken to furnish for expenses, wages, &c., and, according to Gutenberg, had said that he had no intention of claiming interest. The suit was apparently decided in Fust's favour, November 6, 1455, in the refectory of the Barefooted Friars of Mainz, when Fust made oath that he himself had borrowed 1550 guilders and given them to Gutenberg. There is no evidence that Fust, as is usually supposed, removed the portion of the printing materials covered by his mortgage to his own house, and carried on printing there with the aid of Peter Schöffer, of Gernsheim (who is known to have been a scribe at Paris in 1449), to whom, probably about 1455,¹ he gave his only daughter Dyna or Christina in marriage. Their first publication was the Psalter, August 14, 1457, a folio of 350 pages, the first printed book with a complete date, and remarkable for the beauty of the large initials printed each in two colours, red and blue, from types made in two pieces.² The Psalter was reprinted with the same types, 1459 (August 29), 1490, 1502 (Schöffer's last publication) and 1516. Fust and Schöffer's other works are given below.³ In 1464 Adolf

¹ This date is uncertain; some place the marriage in 1453 or soon after, others about 1464. It is probable that Fust alluded to this relationship when he spoke of Schöffer as *pueri mei* in the colophons of Cicero's *De officiis* of 1465 and 1466.

² This method was patented in England by Solomon Henry in 1780, and by Sir William Congreve in 1819.

³ (3) Durandus, *Rationale divinarum officiorum* (1459), folio, 160 leaves; (4) the *Clementine Constitutions*, with the gloss of Johannes Andreae (1460), 51 leaves; (5) *Biblia Sacra Latina* (1462), folio, 2 vols., 242 and 239 leaves, 48 lines to a full page; (6) the Sixth Book of Decretals, with Andreae's gloss, 17th December 1465, folio, 141 leaves; (7) Cicero, *De officiis* (1465), 410, 88 leaves, the first

of Nassau appointed for the parish of St Quintin three *Baumeisters* (master-builders) who were to choose twelve chief parishioners as assistants for life. One of the first of these "Vervaren," who were named on May-day 1464, was Johannes Fust, and in 1467 Adam von Hochheim was chosen instead of "the late" (*selig*) Johannes Fust. Fust is said to have gone to Paris in 1466 and to have died of the plague, which raged there in August and September. He certainly was in Paris on the 4th of July, when he gave Louis de Lavernade of the province of Forez, then chancellor of the duke of Bourbon and first president of the parliament of Toulouse, a copy of his second edition of Cicero, as appears from a note in Lavernade's own hand at the end of the book, which is now in the library of Geneva. But nothing further is known than that on the 30th of October, probably in 1471, an annual mass was instituted for him by Peter Schöffler, Conrad Henlif (for Henekes, or Henckis, Schöffler's partner? who married Fust's widow about 1468¹) and Johann Fust (the son), in the abbey-church of St Victor of Paris, where he was buried; and that Peter Schöffler founded a similar memorial service for Fust in 1473 in the church of the Dominicans at Mainz (Bockenheimer, *Gesch. der Stadt Mainz*, iv. 15).

Fust was formerly often confused with the famous magician Dr Johann Faust, who, though an historical figure, had nothing to do with him (see FAUST).

See further the articles GUTENBERG and TYPOGRAPHY. (J. H. H.)
FUSTEL DE COULANGES, NUMA DENIS (1830-1889), French historian, was born in Paris on the 18th of March 1830, of Breton descent. After studying at the École Normale Supérieure he was sent to the French school at Athens in 1853, directed some excavations in Chios, and wrote an historical account of the island. After his return he filled various educational offices, and took his doctor's degree with two theses, *Quid Vestae cultus in institutis veterum privatis publicisque valuerit* and *Polybe, ou la Grèce conquise par les Romains* (1858). In these works his distinctive qualities were already revealed. His minute knowledge of the language of the Greek and Roman institutions, coupled with his low estimate of the conclusions of contemporary scholars, led him to go direct to the original texts, which he read without political or religious bias. When, however, he had succeeded in extracting from the sources a general idea that seemed to him clear and simple, he attached himself to it as if to the truth itself, employing dialectic of the most penetrating, subtle and even paradoxical character in his deduction of the logical consequences. From 1860 to 1870 he was professor of history at the faculty of letters at Strassburg, where he had a brilliant career as a teacher, but never yielded to the influence exercised by the German universities in the field of classical and Germanic antiquities.

It was at Strassburg that he published his remarkable volume *La Cité antique* (1864), in which he showed forcibly the part played by religion in the political and social evolution of Greece and Rome. Although his making religion the sole factor of this evolution was a perversion of the historical facts, the book was so consistent throughout, so full of ingenious ideas, and written in so striking a style, that it ranks as one of the masterpieces of the French language in the 19th century. By this literary merit Fustel set little store, but he clung tenaciously to his edition of a Latin classic and the first book containing Greek characters, while in the colophon Fust for the first time calls Schöffler "puerum suum"; (8) the same, 4th February 1466; (9) *Grammatica rhythmica* (1466), folio, 11 leaves. They also printed in 1461-1462 several papal bulls, proclamations of Adolf of Nassau, &c. Nothing is known to have appeared for three years after the storming and capture of Mainz in 1462.

Some confusion in the history of the Fust family has arisen since the publication of Bernard's *Orig. de l'imprimerie* (1853). On p. 262, vol. I, he gave an extract from the correspondence between Oberlin and Bodmann (now preserved in the Paris Nat. Library), from which it would appear that Peter Schöffler was the son-in-law, not of Johann Fust, but of a brother of his, Conrad Fust. Of the latter, however, no other trace has been found, and he is no doubt a fiction of F. J. Bodmann, who, partly basing himself on the "Conrad" (Henlif, or Henckis) mentioned above, added the rest to gratify Oberlin (see *Wyns in Quartalsblätter des hist. Vereins für Hessen*, 1879, p. 17).

theories. When he revised the book in 1875, his modifications were very slight, and it is conceivable that, had he recast it, as he often expressed the desire to do in the last years of his life, he would not have abandoned any part of his fundamental thesis. The work is now largely superseded.

Fustel de Coulanges was the most conscientious of men, the most systematic and uncompromising of historians. Appointed to a lectureship at the École Normale Supérieure in February 1870, to a professorship at the Paris faculty of letters in 1875, and to the chair of medieval history created for him at the Sorbonne in 1878, he applied himself to the study of the political institutions of ancient France. The invasion of France by the German armies during the war of 1870-71 attracted his attention to the Germanic invasions under the Roman Empire. Pursuing the theory of J. B. Dubos, but singularly transforming it, he maintained that those invasions were not marked by the violent and destructive character usually attributed to them; that the penetration of the German barbarians into Gaul was a slow process; that the Germans submitted to the imperial administration; that the political institutions of the Merovingians had their origins in the Roman laws at least as much as, if not more than, in German usages; and, consequently, that there was no conquest of Gaul by the Germans. This thesis he sustained brilliantly in his *Histoire des institutions politiques de l'ancienne France*, the first volume of which appeared in 1874. It was the author's original intention to complete this work in four volumes, but as the first volume was keenly attacked in Germany as well as in France, Fustel was forced in self-defence to recast the book entirely. With admirable conscientiousness he re-examined all the texts and wrote a number of dissertations, of which, though several (e.g. those on the Germanic mark and on the *allodium* and *beneficium*) were models of learning and sagacity, all were dominated by his general idea and characterized by a total disregard for the results of such historical disciplines as diplomatic. From this crucible issued an entirely new work, less well arranged than the original, but richer in facts and critical comments. The first volume was expanded into three volumes, *La Gaule romaine* (1891), *L'Invasion germanique et la fin de l'empire* (1891) and *La Monarchie franque* (1888), followed by three other volumes, *L'Alleu et le domaine rural pendant l'époque mérovingienne* (1889), *Les Origines du système féodal: le bénéfice et le patronat* . . . (1890) and *Les Transformations de la royauté pendant l'époque carolingienne* (1892). Thus, in six volumes, he had carried the work no farther than the Carolingian period. The result of this enormous labour, albeit worthy of a great historian, clearly showed that the author lacked all sense of historical proportion. He was a diligent seeker after the truth, and was perfectly sincere when he informed a critic of the exact number of "truths" he had discovered, and when he remarked to one of his pupils a few days before his death, "Rest assured that what I have written in my book is the truth." Such superb self-confidence can accomplish much, and it undoubtedly helped to form Fustel's talent and to give to his style that admirable concision which subjugates even when it fails to convince; but a student instinctively distrusts an historian who settles the most controverted problems with such impassioned assurance. The dissertations not embodied in his great work were collected by himself and (after his death) by his pupil, Camille Julian, and published as volumes of miscellanies: *Recherches sur quelques problèmes d'histoire* (1885), dealing with the Roman colonate, the land system in Normandy, the Germanic mark, and the judiciary organization in the kingdom of the Franks; *Nouvelles recherches sur quelques problèmes d'histoire* (1891); and *Questions historiques* (1893), which contains his paper on Chios and his thesis on Polybius.

His life was devoted almost entirely to his teaching and his books. In 1875 he was elected member of the Académie des Sciences Morales, and in 1880 reluctantly accepted the post of director of the École Normale. Without intervening personally in French politics, he took a keen interest in the questions of administration and social reorganization arising from the fall of the imperialist régime and the disasters of the war. He wished

the institutions of the present to approximate more closely to those of the past, and devised for the new French constitution a body of reforms which reflected the opinions he had formed upon the democracy at Rome and in ancient France. But these were dreams which did not hold him long, and he would have been scandalized had he known that his name was subsequently used as the emblem of a political and religious party. He died at Massy (Seine-et-Oise) on the 12th of September 1889. Throughout his historical career—at the Ecole Normale and the Sorbonne and in his lectures delivered to the empress Eugénie—his sole aim was to ascertain the truth, and in the defence of truth his polemics against what he imagined to be the blindness and insincerity of his critics sometimes assumed a character of harshness and injustice. But, in France at least, these critics were the first to render justice to his learning, his talents and his disinterestedness.

See Paul Guiraud, *Fustel de Coulanges* (1896); H. d'Arbois de Jubainville, *Deux Manières d'écrire l'histoire: critique de Bossuet, d'Augustin Thierry et de Fustel de Coulanges* (1896); and Gabriel Monod, *Portraits et souvenirs* (1897). (C. B. *)

FUSTIAN, a term which includes a variety of heavy woven cotton fabrics, chiefly prepared for men's wear. It embraces plain twilled cloth called jean, and cut fabrics similar to velvet, known as velveteen, moleskin, corduroy, &c. The term was once applied to a coarse cloth made of cotton and flax; now, fustians are usually of cotton and dyed various colours. In the reign of Edward III. the name was given to a woollen fabric. The name is said to be derived from El-Fustat, a suburb of Cairo, where it was first made; and certainly a kind of cloth has long been known under that name. In a petition to parliament, *temp.* Philip and Mary, "fustian of Naples" is mentioned. In the 13th and 14th centuries priests' robes and women's dresses were made of fustian, but though dresses are still made from some kinds the chief use is for labourers' clothes.

FUSTIC (Fr. *justoc*, from Arab. *justuj*, Gr. *πυράριον*, pistachio) **YELLOW WOOD** or **OLD FUSTIC**, a dye-stuff consisting of the wood of *Chlorophora tinctoria*, a large tree of the natural order Moraceae, growing in the West Indies and tropical America. Fustic occurs in commerce in blocks, which are brown without, and of a brownish-yellow within. It is sometimes employed for inlaid work. The dye-stuff termed young fustic or Zante fustic, and also Venetian sumach, is the wood of *Rhus cotinus* (fustet, or smoke tree), a southern European and Asiatic shrub of the natural order Anacardiaceae, called by Gerarde "red sumach," and apparently the "coccygia" and "cotinus" of Pliny (*Nat. Hist.* xiii. 41, xvi. 30). Its colouring matter is fisetin, C₁₄H₁₀O₆, which was synthesized by S. von Kostanecki (*Ber.*, 1904, 37, p. 384). (See **DYEING**.)

FUTURES, a term used in the produce markets for purchases or sales of commodities to be completed at a future date, as opposed to cash or "spot" transactions, which are settled immediately. See **MARKET**, and (for a detailed discussion of the question as affecting cotton) **COTTON: Marketing and Supply**.

FUX, JOHANN JOSEPH (1660–1741), Austrian musician, was born at Hirtenfeld (Styria) in 1660. Of his youth and early training nothing is known. In 1696 he was organist at one of the principal churches of Vienna, and in 1698 was appointed by the emperor Leopold I. as his "imperial court-composer," with a salary of about £6 a month. At the court of Leopold and of his successors Joseph I. and Charles VI., Fux remained for the rest of his life. To his various court dignities that of organist at St Stephen's cathedral was added in 1704. He married the daughter of the government secretary Schnitzbaum. As a proof of the high favour in which he was held by the art-loving Charles VI., it is told that at the coronation of that emperor as king of Bohemia in 1723 an opera, *La Constanza e la Fortezza*, especially composed by Fux for the occasion, was given at Prague in an open-air theatre. Fux at the time was suffering from gout, but the emperor had him carried in a litter all the way from Vienna, and gave him a seat in the imperial box. Fux died at Vienna on the 13th of February 1741. His life, although passed in the great world, was eventless, and his only

troubles arose from the intrigues of his Italian rivals at court. Of the numerous operas which Fux wrote it is unnecessary to speak. They do not essentially differ from the style of the Italian *opera seria* of the time. Of greater importance are his sacred compositions, psalms, motets, oratorios and masses, the celebrated *Missa Canonica* amongst the latter. It is an all but unparalleled *tour de force* of learned musicianship, being written entirely in that most difficult of contrapuntal devices—the canon. As a contrapuntist and musical scholar generally, Fux was unsurpassed by any of his contemporaries, and his great theoretical work, the *Gradus ad Parnassum*, long remained by far the most thorough treatment of counterpoint and its various developments. The title of the original Latin edition is *Gradus ad Parnassum sive manuductio ad compositionem musicæ regularem, methodo nova ac certo nondum ante iam exacta ordine in lucem edita, elaborata a Joanne Josepho Fux* (Vienna, 1715). It was translated into most European languages during the 18th century, and is still studied by musicians interested in the history of their art. The expenses of the publication were defrayed by the emperor Charles VI.

Fux's biography was published by Ludwig von Köchel (Vienna, 1871). It is based on minute original research and contains, amongst other valuable materials, a complete catalogue of the composer's numerous works.

FUZE or **FUSE**, an appliance for firing explosives in blasting operations, military shells, &c. (see **BLASTING** and **AMMUNITION**, § *Shell*). The spelling is not governed by authority, but modern convenience has dictated the adoption of the "z" by military engineers as a general rule, in order to distinguish this sense from that of melting by heat (see below). The word, according to the *New English Dictionary*, is one of the forms in which the Lat. *fusis*, spindle, has been adapted through Romanic into English, the ordinary fuze taking the shape of a spindle-like tube. Similarly the term "fusee" (Fr. *fusée*, spindle full of tow, Late Lat. *fusata*) is applied to a coned spindle sometimes used in the wheel train of watches and spring clocks to equalize the action of the mainspring (see **WATCH**); and the application of the same term to a special kind of match may also be due to its resemblance to a spindle. Again, in heraldry, another form, "fusil," derived through the French from a Late Lat. diminutive (*fusillus* or *fusellus*) of this same *fusis*, is used of a bearing, an elongated lozenge. According to other etymological authorities, however (see Skeat, *Etym. Dict.*, 1898), "fuze" or "fuse," and "fusee" in the sense of match, are all forms derived through the Fr. *fusil*, from Late Lat. *foctile*, steel for striking fire from a flint, from Lat. *focus*, hearth. The Fr. *fusil* and English "fusil" were thus transferred to the "firelock," i.e. the light musket of the 17th century (see **FUSILIER**).

In electrical engineering a "fuse" (always so spelled) is a safety device, commonly consisting of a strip or wire of easily fusible metal, which melts and thus interrupts the circuit of which it forms part, whenever that circuit, through some accident or derangement, is caused to carry a current larger than that for which it is intended. In this sense the word must be connected with *fusis*, the past participle of Lat. *fundere*, to pour, whence comes the verb "fuse," to melt by heat, often used figuratively in the sense of blend, mix.

FYNE, LOCH, an inlet of the sea, Argyllshire, Scotland. From the head, 6 m. above Inveraray, to the mouth on the Sound of Bute, it has a south-westerly and then southerly trend and is 44 m. long, its width varying from ¼ m. to 6 m. It receives the Fyne, Shira, Aray and many other streams, and, on the western side, gives off Lochs Shira, Gair, Gilp (with Ardrishaig, the Crinan Canal and Lochgilphead) and East Tarbert (with Tarbert village). The glens debouching on the lake are Fyne, Shira, Aray, Kinglas and Hell's Glen. The coast generally is picturesque and in many parts well wooded. All vessels using the Crinan Canal navigate the loch to and from Ardrishaig, and there are daily excursions during the season, as far up as Inveraray. There are ferries at St Catherine's and Otter, and piers at Tarbert, Ardrishaig, Kilmory, Craræ, Furnace, Inveraray, Strachur and elsewhere. The industries comprise granite quarrying at Furnace

and Craræ, distilling at Ardrishaig, gunpowder-making at Furnace and Killinan, and, above all, fishing. Haddock, whiting and codling are taken, and the famous "Loch Fyne herrings" command the highest price in the market.

FYRD, the name given to the English army, or militia, during the Anglo-Saxon period (see *AMM*, 60). It is first mentioned in the *Anglo-Saxon Chronicle* under the date 605. The ealdorman, or sheriff, of the shire was probably charged with the duty of calling out and leading the fyrd, which appears always to have retained a local character, as during the time of the Danish invasions we read of the fyrd of Kent, of Somerset and of Devon. As attendance at the fyrd was included in the *trinoda necessitas* it was compulsory on all holders of land; but that it was not confined to them is shown by the following extract from the laws of Ine, king of the West Saxons, dated about 690, which prescribes the penalty for the serious offence of neglecting the fyrd: "If a *gesithcund* man owning land neglect the fyrd, let him pay 120 shillings, and forfeit his land; one not owning land 60 shillings; a ceorlsh man 30 shillings as *fyrdwite*." The fyrd was gradually superseded by the gathering of the thegns and their retainers, but it was occasionally called out for defensive purposes even after the Norman Conquest.

FYT, JOHANNES (1609-1661), Belgian animal painter, was born at Antwerp and christened on the 10th of August 1609. He was registered apprentice to Hans van den Berghe in 1621. Professionally van den Berghe was a restorer of old pictures rather than a painter of new ones. At twenty Johannes Fyt entered the guild of St Luke as a master, and from that time till his death in 1661 he produced a vast number of pictures in which the bold facility of Snyders is united to the powerful effects of Rembrandt, and harmonies of gorgeous tone are not less conspicuous than freedom of touch and a true semblance of nature. There never was such a master of technical processes as Fyt in the rendering of animal life in its most varied forms. He may have been less correct in outline, less bold in action than Snyders, but he was much more skilful and more true in the reproduction of the coat of deer, dogs, greyhounds, hares and monkeys, whilst in realizing the plumage of peacocks, woodcocks, ducks, hawks, and cocks and hens, he had not his equal, nor was any artist even of the Dutch school more effective in relieving his compositions with accessories of tinted cloth, porcelain ware, vases and fruit. He was not clever at figures, and he sometimes trusted for these to the co-operation of Cornelius Schut or Willeborts, whilst his architectural backgrounds were sometimes executed by Quellyn. "Silenus amongst Fruit and Flowers," in the Harrach collection at Vienna, "Diana and her Nymphs with the Produce of the Chase," in the Belvedere at Vienna, and "Dead Game and Fruit in front of a Triumphal Arch," belonging to Baron von Rothschild at Vienna, are specimens of the co-operation respectively of Schut, Willeborts and Quellyn. They are also Fyt's masterpieces. The earliest dated work of the master is a cat grabbing at a piece of dead poultry near a hare and birds, belonging to Baron Cetto at Munich, and executed in 1644. The latest is a "Dead Snipe

with Ducks," of 1660, sold with the Jäger collection at Cologne in 1871. Great power is shown in the bear and boar hunts at Munich and Ravensworth castle. A "Hunted Roedeer with Dogs in the Water," in the Berlin Museum, has some of the life and more of the roughness of Snyders, but lacks variety of tint and finish. A splendid specimen is the Page and Parrot near a table covered with game, guarded by a dog staring at a monkey, in the Wallace collection. With the needle and the brush Fyt was equally clever. He etched 16 plates, and those representing dogs are of their kind unique.

FYZABAD, or FAIZABAD, a city, district and division of British India in the United Provinces. The city stands on the left bank of the river Gogra, 78 m. by rail E. of Lucknow. Pop. (1901) 75,085. To the E. of Fyzabad, and now forming a suburb, is the ancient site of Ajodhya (*g.v.*). Fyzabad was founded about 1730 by Sa'adat Ali Khan, the first nawab wazir of Oudh, who built a hunting-lodge here. It received its present name in the reign of his successor; and Shuja-ud-daula, the third nawab, laid out a large town and fortified it, and here he was buried. It was afterwards the residence of the Begums of Oudh, famous in connexion with the impeachment of Warren Hastings. When the court of Oudh was removed to Lucknow in 1775 all the leading merchants and bankers abandoned the place. At the census of 1869 Fyzabad contained only 37,804 inhabitants; but it is now again advancing in prosperity and population. On the outbreak of the Mutiny in 1857, the cantonment contained two regiments of infantry, a squadron of cavalry, and a light field battery of artillery—all natives. Owing to their threatening demeanour after the Meerut massacre, many of the European women and children were sheltered by one of the great landholders of Oudh, and others were sent to less disturbed parts of the country. The troops rose, as was anticipated, and although they at first permitted their officers to take boats and proceed towards Dinapur, a message was afterwards sent to a rebel force lower down the river to intercept the fugitives. Of four boats, one, having passed the rebels unnoticed, succeeded in reaching Dinapur safely. Of those in the other three boats, one alone escaped. Fyzabad is now a station for European as well as for native troops. It is the headquarters of a brigade in the 8th division of the northern army. There is a government college. Sugar-refining and trade in agricultural produce are important.

The **DISTRICT OF FYZABAD**, lying between the two great rivers Gogra and Gumti, has an area of 1740 sq. m. It is entirely alluvial and well wooded, and has a good climate. Pop. (1901) 1,225,374, an increase of 7% in the decade. The district is traversed throughout its length by the Oudh and Rohilkhand railway from Lucknow to Benares, with a branch to Allahabad. Tanda, with a population in 1901 of 19,853, has the largest production of cotton goods in Oudh.

The **DIVISION OF FYZABAD** has an area of 12,113 sq. m., and comprises the six districts of Fyzabad, Gonda, Bahraich, Sultanpur, Partabgarh and Bara Banki. Pop. (1901) 6,855,991, an increase of 2% in the decade.

G The form of this letter which is familiar to us is an invention of the Romans, who had previously converted the third symbol of the alphabet into a representative of a *k*-sound (see C). Throughout the whole of Roman history C remained as the symbol for G in the abbreviations C and Cn. for the proper names Gaius and Gnaeus. According to Plutarch (*Roman Questions*, 54, 59) the symbol for G was invented by Spurius Carvilius Ruga about 293 B.C. This probably means that he was the first person to spell his cognomen RVGA instead of RVCA. G came to occupy the seventh place in the Roman alphabet which had earlier been taken by Z, because between 450 B.C. and 350 B.C. the *z*-sounds of Latin passed into *r*, names like *Papirius* and *Fusius* in that period becoming *Papirius* and *Furius* (see Z), so that the letter *z* had become superfluous. According to the late writer Martianus Capella *s* was removed from the alphabet by the censor Appius Claudius Caecus in 312 B.C. To Claudius the insertion of G into the alphabet is also sometimes ascribed.

In the earliest form the difference from C is very slight, the lower lip of the crescent merely rising up in a straight line **C**, but **C** and **G** are found also in republican times. In the earliest Roman inscription which was found in the Forum in 1899 the form is **G** written from right to left, but the hollow at the bottom lip of the crescent is an accidental pit in the stone and not a diacritical mark. The unvoiced sound in this inscription is represented by K. The use of the new form was not firmly established till after the middle of the 3rd century B.C.

In the Latin alphabet the sound was always the voiced stop (as in *gig*) in classical times. Later, before *e*, *g* passed into a sound like the English *y*, so that words began indifferently with *g* or *j*; hence from the Lat. *generum* (accusative) and *Ianuarium* we have in Ital. *genaro* and *Gennajo*, Fr. *gendre* and *janvier*. In the ancient Umbrian dialect *g* had made this change between vowels before the Christian era, the inhabitant of *Iguvium* (the modern Gubbio) being in the later form of his native speech *Iuvius*, Lat. *Iguvius*. In most cases in Mid. Eng. also *g* passed into a *y* sound; hence the old prefix *ge* of the past participle appears only as *y* in *yclept* and the like. But *ng* and *gg* took a different course, the *g* becoming an affricate *dg* (*dsh*), as in *singe*, *ridge*, *sedge*, which in English before 1500 were *senge*, *rigge*, *segge*, and in Scotch are still pronounced *sing*, *rig*, *seg*. The affricate in words like *gaol* is of French origin (*geulle*), from a Late Lat. *gabiola*, out of *caecola*, a diminutive of the Lat. *caeca*.

The composite origin of English makes it impossible to lay down rules for the pronunciation of English *g*; thus there are in the language five words *Gill*, three of which have the *g* hard, while two have it soft: viz. (1) *gill* of a fish, (2) *gill*, a ravine, both of which are Norse, and (3) *Gill*, the surname, which is mostly Gaelic=White; and (4) *gill* a liquid measure, from O. Fr. *gelle*, Late Lat. *gella* in the same sense, and (5) *Gill*, a girl's name, shortened from *Gillian*, *Juliana* (see Skeat's *Etymological Dictionary*). No one of these words is of native origin; otherwise the initial *g* would have changed to *y*, as in Eng. *yell* from the O. Eng. *gellan*, *giellan*. (P. Gr.)

GABBRO, in petrology, a group of plutonic basic rocks, holocrystalline and usually rather coarse-grained, consisting essentially of a basic plagioclase feldspar and one or more ferromagnesian minerals (such as augite, hornblende, hypersthene and olivine). The name was given originally in north Italy to certain coarsely crystalline dark green rocks, some of which are true gabbros, while others are serpentines. The gabbros are the plutonic or deep-seated representatives of the dolerites, basalts and diabases (also of some varieties of andesite) with which they agree closely in mineral composition, but not in minute structure. Of their minerals feldspar is usually the most abundant, and is principally labradorite and bytownite, though anorthite occurs in some, while oligoclase and orthoclase have been found in others.

The feldspar is sometimes very clear and fresh, its crystals being for the most part short and broad, with rather irregular or rounded outlines. Albite twinning is very frequent, but in these rocks it is often accompanied by pericline twinning by which the broad or narrow albite plates are cut transversely by many thin, bright and dark bars as seen in polarized light. Equally characteristic of the gabbros is the alteration of the feldspars to cloudy, semi-opaque masses of saussurite. These are compact, tough, devoid of cleavage, and have a waxy lustre and usually a greenish-white colour. When this substance can be resolved by the microscope it proves to consist usually of zoisite or epidote, with garnet and albite, but mixed with it are also chlorite, amphibole, serpentine, prehnite, sericite and other minerals. The augite is usually brown, but greenish, violet and colourless varieties may occur. Hypersthene, when present, is often strikingly pleochroic in colours varying from pink to bright green. It weathers readily to platy-pseudomorphs of bastite which are soft and yield low polarization colours. The olivine is colourless in itself, but in most cases is altered to green or yellow serpentine, often with bands of dark magnetite granules along its cleavages and cracks. Hornblende when primary is often brown, and may surround augite or be perthitically intergrown with it; original green hornblende probably occurs also, though it is more frequently secondary. Dark-brown biotite, although by no means an important constituent of these rocks, occurs in many of them. Quartz is rare, but is occasionally seen intergrown with feldspar as micropegmatite. Among the accessory minerals may be mentioned apatite, magnetite, ilmenite, picotite and garnet.

A peculiar feature, repeated so constantly in many of the minerals of these rocks as to be almost typical of them, is the occurrence of small black or dark brown enclosures often regularly arranged parallel to certain crystallographic planes. Reflection of light from the surfaces of these minute enclosures produces a shimmering or *Schiller*. In augite or hypersthene the effect is that the surface of the mineral has a bronzy sub-metallic appearance, and polished plates seen at a definite angle yield a bright coppery-red reflection, but polished sections of the feldspars may exhibit a brilliant play of colours, as is well seen in the Labrador spar, which is used as an ornamental or semi-precious stone. In olivine the black enclosures are not thin laminae, but branching growths resembling pieces of moss. The phenomenon is known as "schillerization"; its origin has been much discussed, some holding that it is secondary, while others regard these enclosures as original.

In many gabbros there is a tendency to a centric arrangement of the minerals, the first crystallized forming nuclei around which the others grow. Thus magnetite, apatite and picotite, with olivine, may be enclosed in augite, hornblende, and hypersthene, sometimes with a later growth of biotite, while the feldspars occupy the interspaces between the clusters of ferromagnesian minerals. In some cases there are borders around olivine consisting of fibrous hornblende or tremolite and rhombic pyroxene (kelyphitic or ocellar structures); spinels and garnet may occur in this zone, and as it is developed most frequently where olivine is in contact with feldspar it may be due to a chemical resorption at a late stage in the solidification of the rock. In some gabbros and norites reaction rims of fibrous hornblende are found around both hypersthene and diallage where these are in contact with feldspar. Typical orbicular structure such as characterizes some granites and diorites is rare in the gabbros, though it has been observed in a few instances in Norway, California, &c.

In a very large number of the rocks of this group the plagioclase feldspar has crystallized in large measure before the pyroxene, and is enveloped by it in optically exact manner exactly as occurs in the diabases. When these rocks become fine-grained they pass gradually into optically diabase and dolerite; only very rarely does olivine enclose

Actia Augusta) and an aqueduct. After the 3rd century Gabii practically disappears from history, though its bishops continue to be mentioned in ecclesiastical documents till the close of the 9th. The primitive city occupied the eastern bank of the lake, the citadel being now marked by the ruins of the medieval fortress of Castiglione, while the Roman town extended farther to the south. The most conspicuous relic of the latter is a ruined temple, generally attributed to Juno, which had six columns in the front and six on each side. The plan is interesting, but the style of architecture was apparently mixed. To the east of the temple lay the Forum, where excavations were made by Gavin Hamilton in 1792. All the objects found were placed in the Villa Borghese, but many of them were carried off to Paris by Napoleon, and still remain in the Louvre. The statues and busts are especially numerous and interesting; besides the deities Venus, Diana, Nemesis, &c., they comprise Agrippa, Tiberius, Germanicus, Caligula, Claudius, Nero, Trajan and Plotina, Hadrian and Sabina, M. Aurelius, Septimius Severus, Geta, Gordianus Pius and others. The inscriptions relate mainly to local and municipal matters.

See E. Q. Visconti, *Monumenti Gabini della Villa Pinciana* (Rome, 1797, and Milan, 1835); T. Ashby in *Papers of the British School at Rome*, i. 180 seq.; G. Pinza in *Bull. Com.* (1903), 321 seq. (T. As.)

GABINIUS, AULUS, Roman statesman and general, and supporter of Pompey, a prominent figure in the later days of the Roman republic. In 67 B.C., when tribune of the people, he brought forward the famous law (*Lex Gabinia*) conferring upon Pompey the command in the war against the Mediterranean pirates, with extensive powers which gave him absolute control over that sea and the coasts for 50 m. inland. By two other measures of Gabinius loans of money to foreign ambassadors in Rome were made non actionable (as a check on the corruption of the senate) and the senate was ordered to give audience to foreign envoys on certain fixed days (1st of Feb.—1st of March). In 61 Gabinius, then praetor, endeavoured to win the public favour by providing games on a scale of unusual splendour, and in 58 managed to secure the consulship, not without suspicion of bribery. During his term of office he aided Publius Clodius in bringing about the exile of Cicero. In 57 Gabinius went as proconsul to Syria. On his arrival he reinstated Hyrcanus in the high-priesthood at Jerusalem, suppressed revolts, introduced important changes in the government of Judaea, and rebuilt several towns. During his absence in Egypt, whither he had been sent by Pompey, without the consent of the senate, to restore Ptolemy Auletes to his kingdom, Syria had been devastated by robbers, and Alexander, son of Aristobulus, had again taken up arms with the object of depriving Hyrcanus of the high-priesthood. With some difficulty Gabinius restored order, and in 54 handed over the province to his successor, M. Licinius Crassus. The knights, who as farmers of the taxes had suffered heavy losses during the disturbances in Syria, were greatly embittered against Gabinius, and when he appeared in the senate to give an account of his governorship, he was brought to trial on three counts, all involving a capital offence. On the charge of *majestas* (high treason) incurred by having left his province for Egypt without the consent of the senate and in defiance of the Sibylline books, he was acquitted; it is said that the judges were bribed, and even Cicero, who had recently attacked Gabinius with the utmost virulence, was persuaded by Pompey to say as little as he could in his evidence to damage his former enemy. On the second charge, that of *repetundae* (extortion during the administration of his province), with especial reference to the 10,000 talents paid by Ptolemy for his restoration, he was found guilty, in spite of evidence offered on his behalf by Pompey and witnesses from Alexandria and the eloquence of Cicero, who had been induced to plead his cause. Nothing but Cicero's wish to do a favour to Pompey could have induced him to take up what must have been a distasteful task; indeed, it is hinted that the half-heartedness of the defence materially contributed to Gabinius's condemnation. The third charge, that of *ambitus* (illegalities committed during his canvass for the consulship),

was consequently dropped; Gabinius went into exile, and his property was confiscated. After the outbreak of the civil war, he was recalled by Caesar in 49, and entered his service, but took no active part against his old patron Pompey. After the battle of Pharsalus, he was commissioned to transport some recently levied troops to Illyricum. On his way thither by land, he was attacked by the Dalmatians and with difficulty made his way to Salonae (Dalmatia). Here he bravely defended himself against the attacks of the Pompeian commander, Marcus Octavius, but in a few months died of illness (48 or the beginning of 47).

See Dio Cassius xxxvi. 23-36, xxxviii. 13, 30, xxxix. 55-63; Plutarch, *Pompey*, 25, 48; Josephus, *Antiq.* xiv. 4-6; Appian, *Illyrica*, 12, *Bell. Civ.* ii. 24, 29; Cicero, *ad Att.* vi. 2, *ad Q. Fratrem*, ii. 13, *Post reditum in senatu*, 4-8, *Pro lege Manilia*, 17, 18, 19; exhaustive article by Bähr in Ersch and Gruber's *Allgemeine Encyclopädie*; and monograph by G. Stocchi, *Aulo Gabinio e i suoi processi* (1892).

GABION (a French word derived through Ital. *gabbione*, *gabbia*, from Lat. *cavea*, a cage), a cylindrical basket without top or bottom, used in revetting fortifications and for numerous other purposes of military engineering. The gabion is filled with earth when in position. The ordinary brushwood gabion in the British service has a diameter of 2 ft. and a height of 2 ft. 9 in. There are several forms of gabion in use, the best known being the Willesden paper band gabion and the Jones iron or steel band gabion.

GABLE, in architecture, the upper portion of a wall from the level of the eaves or gutter to the ridge of the roof. The word is a southern English form of the Scottish *gavel*, or of an O. Fr. word *gable* or *jable*, both ultimately derived from O. Norwegian *gast*. In other Teutonic languages, similar words, such as Ger. *Gabel* and Dutch *gaffel*, mean "fork," cf. Lat. *gabalus*, gallows, which is Teutonic in origin; "gable" is represented by such forms as Ger. *Giebel* and Dutch *gevel*. According to the *New English Dictionary* the primary meaning of all these words is probably "top" or "head," cf. Gr. *κεφαλῆ*, and refers to the forking timbers at the end of a roof. The gable corresponds to the pediment in classic buildings where the roof was of low pitch. If the roof is carried across on the top of the wall so that the purlins project beyond its face, they are masked or hidden by a "barge board," but as a rule the roof butts up against the back of the wall which is raised so as to form a parapet. In the middle ages the gable end was invariably parallel to the roof and was crowned by coping stones properly weathered on both sides to throw off the rain. In the 16th century in England variety was given to the outline of the gable by a series of alternating semi-circular and ogee curves. In Holland, Belgium and Scotland a succession of steps was employed, which in the latter country are known as crow gables or corbie steps. In Germany and the Netherlands in the 17th and 18th centuries the step gables assume very elaborate forms of an extremely rococo character, and they are sometimes of immense size, with windows in two or three storeys. Designs of a similar rococo character are found in England, but only in crests such as those which surmount the towers of Wollaton and the gatehouse of Hardwick Hall.

Gabled Towers, in architecture, are those towers which are finished with gables instead of parapets, as at Sompoting, Sussex. Many of the German Romanesque towers are gabled.

GABLER, GEORG ANDREAS (1786-1853), German Hegelian philosopher, son of J. P. Gabler (below), was born on the 30th of July 1786, at Altdorf in Bavaria. In 1804 he accompanied his father to Jena, where he completed his studies in philosophy and law, and became an enthusiastic disciple of Hegel. After holding various educational appointments, he was in 1827 appointed rector of the Bayreuth gymnasium, and in 1830 general superintendent of schools. In 1835 he succeeded Hegel in the Berlin chair. He died at Teplitz on the 13th of September 1853. His works include *Lehrbuch d. philos. Propädeutik* (1st vol., Erlangen, 1827), a popular exposition of the Hegelian system; *De verae philosophiae erga religionem Christianam pietate* (Berlin, 1836), and *Die Hegel'sche Philosophie* (ib., 1843), a defence of the Hegelian philosophy against Trendelenburg.

GABLER, JOHANN PHILIPP (1753-1826), German Protestant theologian of the school of J. J. Griesbach and J. G. Eichhorn, was born at Frankfurt-on-Main on the 4th of June 1753. In 1772 he entered the university of Jena as a theological student. In 1776 he was on the point of abandoning theological pursuits, when the arrival of Griesbach inspired him with new ardour. After having been successively *Repetent* in Göttingen and teacher in the public schools of Dortmund (Westphalia) and Altdorf (Bavaria), he was, in 1785, appointed second professor of theology in the university of Altdorf, whence he was translated to a chair in Jena in 1804, where he succeeded Griesbach in 1812. Here he died on the 17th of February 1826. At Altdorf Gabler published (1791-1793) a new edition, with introduction and notes, of Eichhorn's *Urgeschichte*; this was followed, two years afterwards, by a supplement entitled *Neuer Versuch über die mosaische Schöpfungsgeschichte*. He was also the author of many essays which were characterized by much critical acumen, and which had considerable influence on the course of German thought on theological and Biblical questions. From 1798 to 1800 he was editor of the *Neuestes theologisches Journal*, first conjointly with H. K. A. Hänlein (1762-1829), C. F. von Ammon (1766-1850) and H. E. G. Paulus, and afterwards unassisted; from 1801 to 1804 of the *Journal für theologische Literatur*; and from 1805 to 1811 of the *Journal für auserlesene theologische Literatur*.

Some of his essays were published by his sons (2 vols., 1831); and a memoir appeared in 1827 by W. Schröter.

GABLETS (diminutive of "gable"), in architecture, triangular terminations to buttresses, much in use in the Early English and Decorated periods, after which the buttresses generally terminated in pinnacles. The Early English gablets are generally plain, and very sharp in pitch. In the Decorated period they are often enriched with panelling and crockets. They are sometimes finished with small crosses, but oftener with finials.

GABLONZ (Czech, *Jablonec*), a town of Bohemia, Austria, 94 m. N. E. of Prague by rail. Pop. (1900) 21,086, mostly German. It is the chief seat of the glass pearl and imitation jewelry manufacture, and has also an important textile industry, and produces large quantities of hardware, papier mâché and other paper goods.

GABORIAU, ÉMILE (1833-1873), French novelist, was born at Saujon (Charente Inférieure) on the 9th of November 1833. He became secretary to Paul Féval, and, after publishing some novels and miscellaneous writings, found his real gift in *L'Affaire Lerouge* (1866), a detective novel which was published in the *Pays* and at once made his reputation. The story was produced on the stage in 1872. A long series of novels dealing with the annals of the police court followed, and proved very popular. Among them are: *Le Crime d'Orcinval* (1867), *Monsieur Lecocq* (1869), *La Vie infernale* (1870), *Les Esclaves de Paris* (1869), *L'Argent des autres* (1874). Gaboriau died in Paris on the 28th of September 1873.

GABRIEL (Heb. גַּבְרִיֵּאל, man of God), in the Bible, the heavenly messenger (see ANGEL) sent to Daniel to explain the vision of the ram and the he-goat, and to communicate the prediction of the Seventy Weeks (Dan. viii. 16, ix. 21). He was also employed to announce the birth of John the Baptist to Zacharias, and that of the Messiah to the Virgin Mary (Luke i. 19, 26). Because he stood in the divine presence (see Luke i. 19; Rev. viii. 2; and cf. Tobit xii. 15), both Jewish and Christian writers generally speak of him as an archangel. In the *Book of Enoch* "the four great archangels" are Michael, Uriel, Suriel or Raphael, and Gabriel, who is set over "all the powers" and shares the work of intercession. His name frequently occurs in the Jewish literature of the later post-Biblical period. Thus, according to the Targum Pseudo-Jonathan, he was the man who showed the way to Joseph (Gen. xxxvii. 15); and in Deut. xxxiv. 6 it is affirmed that he, along with Michael, Uriel, Jophiel, Jephphiah and the Metatron, buried the body of Moses. In the Targum on 2 Chron. xxxii. 21 he is named as the angel who destroyed the host of Sennacherib; and in similar writings of a still later period he is spoken of as the spirit who presides over fire, thunder, the ripening of the fruits of the earth and similar processes. In the

Koran great prominence is given to his function as the medium of divine revelation, and, according to the Mahomedan interpreters, he it is who is referred to by the appellations "Holy Spirit" and "Spirit of Truth." He is specially commemorated in the calendars of the Greek, Coptic and Armenian churches.

GABRIEL HOUNDS, a spectral pack supposed in the North of England to foretell death by their yelping at night. The legend is that they are the souls of unbaptized children wandering through the air till the day of judgment. They are also sometimes called Gabriel or Gable Ratchet. A very prosaic explanation of this nocturnal noise is given by J. C. Atkinson in his *Cleveland Glossary* (1868). "This," he writes, "is the name for a yelping sound heard at night, more or less resembling the cry of hounds or yelping of dogs, probably due to large flocks of wild geese which chance to be flying by night."

See further Joseph Lucas, *Studies in Nidderdale* (1882), pp. 156-157.

GABRIELI, GIOVANNI (1557-1612?), Italian musical composer, was born at Venice in 1557, and was a pupil of his uncle Andrea, a distinguished musician of the contrapuntal school and organist of St Mark's. He succeeded Claudio Merulo as first organist of the same church in 1585, and died at Venice either in 1612 or 1613. He was remarkable for his compositions for several choirs, writing frequently for 12 or 16 voices, and is important as an early experimenter in chromatic harmony. It was probably for this reason that he made a special point of combining voices with instruments, being thus one of the founders of choral and orchestral composition. Among his pupils was Heinrich Schütz; and the church of St Mark, from the time of the Gabriellis onwards down to that of Lotti, became one of the most important musical schools in Europe.

See also Winterfeld, *Johann Gabrieli und seine Zeit* (1834).

GABUN, a district on the west coast of Africa, one of the colonies forming French Congo (*q.v.*). It derives its designation from the settlements on the Gabun river or Rio de Gabão. The Gabun, in reality an estuary of the sea, lies immediately north of the equator. At the entrance, between Cape Joinville or Santa Clara on the N. and Cape Pangara or Sandy Point on the S., it has a width of about 10 m. It maintains a breadth of some 7 m. for a distance of 40 m. inland, when it contracts into what is known as the Rio Olambo, which is not more than 2 or 3 m. from bank to bank. Several rivers, of which the Komo is the chief, discharge their waters into the estuary. The Gabun was discovered by Portuguese navigators towards the close of the 15th century, and was named from its fanciful resemblance to a *gabão* or cabin. On the small island of Koniké, which lies about the centre of the estuary, scanty remains of a Portuguese fort have been discovered. The three principal tribes in the Gabun are the Mpongwe, the Fang and the Bakalai.

GACE BRULÉ (d. c. 1220), French *trouvère*, was a native of Champagne. It has generally been asserted that he taught Thibaut of Champagne the art of verse, an assumption which is based on a statement in the *Chroniques de Saint-Denis*: "Si fist entre lui [Thibaut] et Gace Brulé les plus belles chançons et les plus délitables et melodieuses qui onque fussent oïes." This has been taken as evidence of collaboration between the two poets. The passage will bear the interpretation that with those of Gace the songs of Thibaut were the best hitherto known. Paulin Paris, in the *Histoire littéraire de la France* (vol. xxiii.), quotes a number of facts that fix an earlier date for Gace's songs. Gace is the author of the earliest known *jeu parti*. The interlocutors are Gace and a count of Brittany who is identified with Geoffrey of Brittany, son of Henry II. of England. Gace appears to have been banished from Champagne and to have found refuge in Brittany. A deed dated 1212 attests a contract between Gatho Bruslé (Gace Brulé) and the Templars for a piece of land in Dreux. It seems most probable that Gace died before 1220, at the latest in 1225.

See Gédéon Busken Huet, *Chansons de Gace Brulé*, edited for the Société des anciens textes français (1902), with an exhaustive introduction. Dante quotes a song by Gace, *Ire d'amor qui en mon cuer repaire*, which he attributes erroneously to Thibaut of Navarre (*De vulgari eloquentia*, p. 151, ed. P. Rajna, Florence, 1893).

GACHARD, LOUIS PROSPER (1800–1885), Belgian man of letters, was born in Paris on the 12th of March 1800. He entered the administration of the royal archives in 1826, and was appointed director-general, a post which he held for fifty-five years. During this long period he reorganized the service, added to the records by copies taken in other European collections, travelled for purposes of study, and carried on a wide correspondence with other keepers of records, and with historical scholars. He also edited and published many valuable collections of state papers; a full list of his various publications was printed in the *Annuaire de l'Académie royale de Belgique* by Ch. Piot in 1888, pp. 220–236. It includes 246 entries. He was the author of several historical writings, of which the best known are *Don Carlos et Philippe II* (1867), *Études et notices historiques concernant l'histoire des Pays-Bas* (1863), *Histoire de la Belgique au commencement du XVIII^e siècle* (1880), *Histoire politique et diplomatique de P. P. Rubens* (1877), all published at Brussels. His chief editorial works are the *Actes des états généraux des Pays-Bas 1576–1585* (Brussels, 1861–1866), *Collection de documents inédits concernant l'histoire de la Belgique* (Brussels, 1833–1835), and the *Relations des ambassadeurs Vénitiens sur Charles V et Philippe II* (Brussels, 1855). Gachard died in Brussels on the 24th of December 1885.

GAD, in the Bible. 1. A prophet or rather a "seer" (cp. 1 Sam. ix. 9), who was a companion of David from his early days. He is first mentioned in 1 Sam. xxii. 5 as having warned David to take refuge in Judah, and appears again in 2 Sam. xxiv. 11 seq. to make known Yahweh's displeasure at the numbering of the people. Together with Nathan he is represented in post-exilic tradition as assisting to organize the musical service of the temple (2 Chron. xxix. 25), and like Nathan and Samuel he is said to have written an account of David's deeds (1 Chron. xxix. 29); a history of David in accordance with later tradition and upon the lines of later prophetic ideas is far from improbable.

2. Son of Jacob, by Zilpah, Leah's maid; a tribe of Israel (Gen. xxx. 11). The name is that of the god of "luck" or fortune, mentioned in Isa. lxx. 11 (R.V. mg.), and in several names of places, e.g. Baal-Gad (Josh. xi. 17, xii. 7), and possibly also in Dibon-Gad, Migdol-Gad and Nahal-Gad.¹ There is another etymology in Gen. xlix. 19, where the name is played on: "Gad, a plundering troop (*gadd*) shall plunder him (*yegudennu*), but he shall plunder at their heels." There are no traditions of the personal history of Gad. One of the earliest references to the name is the statement on the inscription of Mesha, king of Moab (about 850 B.C.), that the "men of Gad" had occupied Ataroth (E. of Dead Sea) from of old, and that the king of Israel had fortified the city. This is in the district ascribed to Reuben, with which tribe the fortunes of Gad were very closely connected. In Numbers xxxiii. 34 seq. the cities of Gad appear to lie chiefly to the south of Heshbon; in Joshua xiii. 24–28 they lie almost wholly to the north; while other texts present discrepancies which are not easily reconciled with either passage. Possibly some cities were common to both Reuben and Gad, and perhaps others more than once changed hands. That Gad, at one time at least, held territory as far south as Pisgah and Nebo would follow from Deut. xxxiii. 21, if the rendering of the Targums be accepted, "and he looked out the first part for himself, because there was the portion of the buried law-giver." It is certain, however, that, at a late period, this tribe was localized chiefly in Gilead, in the district which now goes by the name of Jebel Jil'ad. The traditions encircling this district point, it would seem, to the tribe having been of Aramaean origin (see the story of Jacob); at all events its position was extremely exposed, and its population at the best must have been a mixed one. Its richness and fertility made it a prey to the marauding nomads of the desert; but the allusion in the Blessing of Jacob gives the tribe a character for bravery, and David's men of Gad (1 Chron. xii. 8) were famous in tradition. Although rarely mentioned by name (the geographical term Gilead is usual), the history of Gad enters into the lives of Jephthah and Saul, and in the wars of Ammon and Moab it must have played some part. It followed

¹ See G. B. Gray, *Heb. Proper Names*, pp. 134 seq., 145.

Jeroboam in the great revolt against the house of David, and its later fortunes until 734 B.C. (1 Chron. v. 26) would be those of the northern kingdom.

See, for a critical discussion of the data, H. W. Hogg, *Ency. Bib. cols.* 1579 seq.; also GILEAD; MANASSEH; REUBEN.

GADAG, or GARAG, a town of British India, in the Dharwar district of Bombay, 43 m. E. of Dharwar town. Pop. (1901) 30,652. It is an important railway junction on the Southern Mahratta system, with a growing trade in raw cotton, and also in the weaving of cotton and silk. There are factories for ginning and pressing cotton, and a spinning mill. The town contains remains of a number of temples, some of which exhibit fine carving, while inscriptions in them indicate the existence of Gadag as early as the 7th century.

GADARA, an ancient town of the Syrian Decapolis, the capital of Peraea, and the political centre of the small district of Gadaris. It was a Greek city, probably entirely non-Syrian in origin. The earliest recorded event in its history is its capture by Antiochus III. of Syria in 218 B.C.; how long it may have existed before this date is unknown. About twenty years later it was besieged for ten months by Alexander Jannaeus. It was restored by Pompey, and in 30 B.C. was presented by Augustus to Herod the Great; on Herod's death it was reunited to Syria. The coins of the place bear Greek legends, and such inscriptions as have been found on its site are Greek. Its governing and wealthy classes were probably Greek, the common people being Hellenized and Judaized Aramaeans. The community was Hellenistically organized, and though dependent on Syria and acknowledging the supremacy of Rome it was governed by a democratic senate and managed its own internal affairs. In the Jewish war it surrendered to Vespasian, but in the Byzantine period it again flourished and was the seat of a bishop. It was renowned for its hot sulphur baths; the springs still exist and show the remains of bath-houses. The temperature of the springs is 110° F. This town was the birthplace of Meleager the anthologist. There is a confusion in the narrative of the healing of the demoniac between the very similar names *Gadara*, *Gerasa* and *Gergesa*; but the probabilities, both textual and geographical, are in favour of the reading of Mark (*Gerasenes*, ch. v. 1, revised version); and that the miracle has nothing to do with *Gadara*, but took place at *Kersa*, on the eastern shore of the Sea of Galilee.

Gadara is now represented by *Umm Kais*, a group of ruins about 6 m. S.E. of the Sea of Galilee, and 1104 ft. above the sea-level. There are very fine tombs with carved sarcophagi in the neighbourhood. There are the remains of two theatres and (probably) a temple, and many heaps of carved stones, representing ancient buildings of various kinds. The walls are, or were, traceable for a circuit of 2 m., and there are also the remains of a street of columns. The natives are rapidly destroying the ruins by quarrying building material out of them. (R. A. S. M.)

GADDI. Four painters of the early Florentine school—father, son and two grandsons—bore this name.

1. **GADDO GADDI** was, according to Vasari, an intimate friend of Cimabue, and afterwards of Giotto. The dates of birth and death have been given as 1230 and about 1312; these are probably too early; he may have been born towards 1260, and may have died in or about 1333. He was a painter and mosaicist, is said to have executed the great mosaic inside the portal of the cathedral of Florence, representing the coronation of the Virgin, and may with more certainty be credited with the mosaics inside the portico of the basilica of S. Maria Maggiore, Rome, relating to the legend of the foundation of that church; their date is probably 1308. In the original cathedral of St Peter in Rome he also executed the mosaics of the choir, and those of the front representing on a colossal scale God the Father, with many other figures; likewise an altarpiece in the church of S. Maria Novella, Florence; these works no longer exist. It is ordinarily held that no picture (as distinct from mosaics) by Gaddo Gaddi is now extant. Messrs Crowe & Cavalcaselle, however, consider that the mosaics of S. Maria Maggiore bear so strong a resemblance in style to four of the frescoes in the upper church of Assisi, representing incidents in the life of St Francis (frescoes 2, 3, 4

and especially 5, which shows Francis stripping himself, and protected by the bishop), that those frescoes likewise may, with considerable confidence, be ascribed to Gaddi. Some other extant mosaics are attributed to him, but without full authentication. This artist laid the foundation of a very large fortune, which continued increasing, and placed his progeny in a highly distinguished worldly position.

2. **TADDEO GADDI** (about 1300-1366, or later), son of Gaddo, was born in Florence, and is usually said to have been one of Giotto's most industrious assistants for a period of 24 years. This can hardly be other than an exaggeration; it is probable that he began painting on his own account towards 1330, when Giotto went to Naples. Taddeo also traded as a merchant, and had a branch establishment in Venice. He was a painter, mosaicist and architect. He executed in fresco, in the Baroncelli (now Giugni) chapel, in the Florentine church of S. Croce, the "Virgin and Child between Four Prophets," on the funeral monument at the entrance, and on the walls various incidents in the legend of the Virgin, from the expulsion of Joachim from the Temple up to the Nativity. In the subject of the "Presentation of the Virgin in the Temple" are the two heads traditionally accepted as portraits of Gaddo Gaddi and Andrea Tafi; they, at any rate, are not likely to be portraits of those artists from the life. On the ceiling of the same chapel are the "Eight Virtues." In the museum of Berlin is an altarpiece by Taddeo, the "Virgin and Child," and some other subjects, dated 1334; in the Naples gallery, a triptych, dated 1336, of the "Virgin enthroned along with Four Saints," the "Baptism of Jesus," and his "Deposition from the Cross"; in the sacristy of S. Pietro a Megogmano, near Poggibonsi, an altarpiece dated 1355, the "Virgin and Child enthroned amid Angels." A series of paintings, partly from the life of St. Francis, which Taddeo executed for the presses in S. Croce, are now divided between the Florentine Academy and the Berlin Museum; the compositions are taken from or founded on Giotto, to whom, indeed, the Berlin authorities have ascribed their examples. Taddeo also painted some frescoes still extant in Pisa, besides many in S. Croce and other Florentine buildings, which have perished. He deservedly ranks as one of the most eminent successors of Giotto; it may be said that he continued working up the material furnished by that great painter, with comparatively feeble inspiration of his own. His figures are vehement in action, long and slender in form; his execution rapid and somewhat conventional. To Taddeo are generally ascribed the celebrated frescoes—those of the ceiling and left or western wall—in the Cappella degli Spagnuoli, in the church of S. Maria Novella, Florence; this is, however, open to considerable doubt, although it may perhaps be conceded that the designs for the ceiling were furnished by Taddeo. Dubious also are the three pictures ascribed to him in the National Gallery, London. In mosaic he has left some work in the baptistery of Florence. As an architect he supplied in 1336 the plans for the present Ponte Vecchio, and those for the original (not the present) Ponte S. Trinita; in 1337 he was engaged on the church of Or San Michele; and he carried on after Giotto's death the work of the unrivalled Campanile.

3. **AGNOLO GADDI**, born in Florence, was the son of Taddeo; the date of his birth has been given as 1326, but possibly 1350 is nearer the mark. He was a painter and mosaicist, trained by his father, and a merchant as well; in middle age he settled down to commercial life in Venice, and he added greatly to the family wealth. He died in Florence in October 1396. His paintings show much early promise, hardly sustained as he advanced in life. One of the earliest, at S. Jacopo tra' Fossi, Florence, represents the "Resurrection of Lazarus." Another probably youthful performance is the series of frescoes of the Pieve di Prato—legends of the Virgin and of her Sacred Girdle, bestowed upon St. Thomas, and brought to Prato in the 11th century by Michele dei Dagomari; the "Marriage of Mary" is one of the best of this series, the later compositions in which have suffered much by renewals. In S. Croce he painted, in eight frescoes, the legend of the Cross, beginning with the archangel Michael giving Seth a branch from the tree of knowledge, and ending

with the emperor Heraclius carrying the Cross as he enters Jerusalem; in this picture is a portrait of the painter himself. Agnolo composed his subjects better than Taddeo; he had more dignity and individuality in the figures, and was a clear and bold colourist; the general effect is laudably decorative, but the drawing is poor, and the works show best from a distance. Various other productions of this master exist, and many have perished. Cennino Cennini, the author of the celebrated treatise on painting, was one of his pupils.

4. **GIOVANNI GADDI**, brother of Agnolo, was also a painter of promise. He died young in 1383.

Vasari, and Crowe and Cavalcaselle can be consulted as to the Gaddi. Other notices appear here and there—such as *La Cappella de' Rinuccini in S. Croce di Firenze*, by G. Ajazzi (1845). (W. M. R.)

GADE, NIELS WILHELM (1817-1890), Danish composer, was born at Copenhagen, on the 22nd of February 1817, his father being a musical instrument maker. He was intended for his father's trade, but his passion for a musician's career, made evident by the ease and skill with which he learnt to play upon a number of instruments, was not to be denied. Though he became proficient on the violin under Wexschall, and in the elements of theory under Weyse and Berggreen, he was to a great extent self-taught. His opportunities of hearing and playing in the great masterpieces were many, since he was a member of the court band. In 1840 his *Aladdin* and his overture of *Ossian* attracted attention, and in 1841 his *Nachklänge aus Ossian* overture gained the local musical society's prize, the judges being Spohr and Schneider. This work also attracted the notice of the king, who gave the composer a stipend which enabled him to go to Leipzig and Italy. In 1844 Gade conducted the Gewandhaus concerts in Leipzig during Mendelssohn's absence, and on the latter's death became chief conductor. In 1848, on the outbreak of the Holstein War, he returned to Copenhagen, where he was appointed organist and conductor of the Musik-Verein. In 1852 he married a daughter of the composer J. P. E. Hartmann. He became court conductor in 1861, and was pensioned by the government in 1876—the year in which he visited Birmingham to conduct his *Crusaders*. This work, and the *Frühlingsfantasie*, the *Erlkönigs Tochter*, *Frühlingsbotschaft* and *Psyche* (written for Birmingham in 1882) have enjoyed a wide popularity. Indeed, they represent the strength and the weakness of Gade's musical ability quite as well as any of his eight symphonies (the best of which are the first and fourth, while the fifth has an obligato pianoforte part). Gade was distinctly a romanticist, but his music is highly polished and beautifully finished, lyrical rather than dramatic and effective. Much of the pianoforte music, *Aquarellen*, *Spring Flowers*, for instance, enjoyed a considerable vogue, as did the *Noctelletten* trio; but Gade's opera *Mariotta* has not been heard outside the Copenhagen opera house. He died at Copenhagen on the 21st of December 1890.

GADOLINIUM (symbol Gd., atomic weight 157.3), one of the rare earth metals (see ERBIUM). The element was discovered in 1880 in the mineral samarskite by C. Marignac (*Comptes rendus*, 1880, 90, p. 899; *Ann. chim. phys.*, 1880 [5] 20, p. 535). G. Urbain (*Comptes rendus*, 1905, 140, p. 583) separates the metal by crystallizing the double nitrate of nickel and gadolinium. The salts show absorption bands in the ultra-violet. The oxide Gd₂O₃ is colourless (Lecoq de Boisbaudran).

GADSDEN, CHRISTOPHER (1724-1805), American patriot, was born in Charleston, South Carolina, in 1724. His father, Thomas Gadsden, was for a time the king's collector for the port of Charleston. Christopher went to school near Bristol, in England, returned to America in 1741, was afterwards employed in a counting house in Philadelphia, and became a merchant and planter at Charleston. In 1759 he was captain of an artillery company in an expedition against the Cherokees. He was a member of the South Carolina legislature almost continuously from 1760 to 1780, and represented his province in the Stamp Act Congress of 1765 and in the Continental Congress in 1774-1776. In February 1776 he was placed in command of all the military forces of South Carolina, and in October of the same

year was commissioned a brigadier-general and was taken into the Continental service; but on account of a dispute arising out of a conflict between state and Federal authority, resigned his command in 1777. He was lieutenant-governor of his state in 1780, when Charleston was surrendered to the British. For about three months following this event he was held as a prisoner on parole within the limits of Charleston; then, because of his influence in deterring others from exchanging their paroles for the privileges of British subjects, he was seized, taken to St Augustine, Florida, and there, because he would not give another parole to those who had violated the former agreement affecting him, he was confined for forty-two weeks in a dungeon. In 1782 Gadsden was again elected a member of his state legislature; he was also elected governor, but declined to serve on the ground that he was too old and infirm; in 1788 he was a member of the convention which ratified for South Carolina the Federal constitution; and in 1790 he was a member of the convention which framed the new state constitution. He died in Charleston on the 28th of August 1805. From the time that Governor Thomas Boone, in 1762, pronounced his election to the legislature improper, and dissolved the House in consequence, Gadsden was hostile to the British administration. He was an ardent leader of the opposition to the Stamp Act, advocating even then a separation of the colonies from the mother country; and in the Continental Congress of 1774 he discussed the situation on the basis of inalienable rights and liberties, and urged an immediate attack on General Thomas Gage, that he might be defeated before receiving reinforcements.

GADSDEN, JAMES (1788–1858), American soldier and diplomat, was born at Charleston, S.C., on the 15th of May 1788; the grandson of Christopher Gadsden. He graduated at Yale in 1806, became a merchant in his native city, and in the war of 1812 served in the regular U.S. Army as a lieutenant of engineers. In 1818 he served against the Seminoles, with the rank of captain, as aide on the staff of Gen. Andrew Jackson. In October 1820 he became inspector-general of the Southern Division, with the rank of colonel, and as such assisted in the occupation and the establishment of posts in Florida after its acquisition. From August 1821 to March 1822 he was adjutant-general, but, his appointment not being confirmed by the Senate, he left the army and became a planter in Florida. He served in the Territorial legislature, and as Federal commissioner superintended in 1823 the removal of the Seminole Indians to South Florida. In 1832 he negotiated with the Seminoles a treaty which provided for their removal within three years to lands in what is now the state of Oklahoma; but the Seminoles refused to move, hostilities again broke out, and in the second Seminole War Gadsden was quartermaster-general of the Florida Volunteers from February to April 1836. Returning to South Carolina he became a rice planter, and was president of the South Carolina railway. In 1853 President Franklin Pierce appointed him minister to Mexico, with which country he negotiated the so-called "Gadsden treaty" (signed the 30th of December 1853), which gave to the United States freedom of transit for mails, merchandise and troops across the Isthmus of Tehuantepec, and provided for a readjustment of the boundary established by the treaty of Guadalupe Hidalgo, the United States acquiring 45,535 sq. m. of land, since known as the "Gadsden Purchase," in what is now New Mexico and Arizona. In addition, Article XI. of the treaty of Guadalupe Hidalgo, which bound the United States to prevent incursions of Indians from the United States into Mexico, and to restore Mexican prisoners captured by such Indians, was abrogated, and for these considerations the United States paid to Mexico the sum of \$10,000,000. Ratifications of the treaty, slightly modified by the Senate, were exchanged on the 30th of June 1854; before this, however, Gadsden had retired from his post. The boundary line between Mexico and the "Gadsden Purchase" was marked by joint commissions appointed in 1855 and 1861, the second commission publishing its report in 1869. Gadsden died at Charleston, South Carolina, on the 25th of December 1858.

An elder brother, **CHRISTOPHER EDWARDS GADSDEN** (1785–

1852), was Protestant Episcopal bishop of South Carolina in 1839–1852.

GADWALL, a word of obscure origin,¹ the common English name of the duck, called by Linnaeus *Anas strepera*, but considered by many modern ornithologists to require removal from the genus *Anas* to that of *Chaulelasmus* or *Ctenorhynchus*, of either of which it is almost the sole species. Its geographical distribution is almost identical with that of the common wild duck or mallard (see DUCK), since it is found over the greater part of the northern hemisphere; but, save in India, where it is one of the most abundant species of duck during the cold weather, it is hardly anywhere so numerous, and both in the eastern parts of the United States and in the British Islands it is rather rare than otherwise. Its habits also, so far as they have been observed, greatly resemble those of the wild duck; but its appearance on the water is very different, its small head, flat back, elongated form and elevated stern rendering it recognizable by the former even at such a distance as hinders him from seeing its very distinct plumage. In coloration the two sexes appear almost equally sombre; but on closer inspection the drake exhibits a pencilled grey coloration and upper wing-coverts of a deep chestnut, which are almost wanting in his soberly clad partner. She closely resembles the female of the mallard in colour, but has, like her own male, some of the secondary quills of a pure white, presenting a patch of that colour which forms one of the most readily perceived distinctive characters of the species. The gadwall is a bird of some interest in England, since it is one of the few that have been induced, by the protection afforded them in certain localities, to resume the indigenous position they once filled, but had, through the draining and reclaiming of marshy lands, long since abandoned. In regard to the present species, this fact was due to the efforts of Andrew Fountaine, on whose property, in West Norfolk and its immediate neighbourhood, the gadwall, from 1850, annually bred in increasing numbers. It has been always esteemed one of the best of wild fowl for the table. (A. N.)

GAEKWAR, or **GUICOWAR**, the family name of the Mahratta rulers of Baroda (*q.v.*) in western India, which has been converted by the English into a dynastic title. It is derived from the vernacular word for the cow, but it is a mistake to suppose that the family are of the cowherd caste; they belong to the upper class of Mahrattas proper, sometimes claiming a Rajput origin. The dynasty was founded by a succession of three warriors, Damaji I., Pilaji and Damaji II., who established Mahratta supremacy throughout Gujarat during the first half of the 18th century. The present style of the ruler is Maharaja Gaekwar of Baroda.

GAETA (anc. *Caletae Portus*), a seaport and episcopal see of Campania, Italy, in the province of Caserta, from which it is 53 m. W.N.W. by rail via Sparanise. Pop. (1901) 5528. It occupies a lower projecting point of the promontory which forms the S.W. extremity of the Bay of Gaeta. The tomb of Munatius Plancus, on the summit of the promontory (see CAIETAE PORTUS), is now a naval signal station, and lies in the centre of the extensive earthworks of the modern fortifications. The harbour is well sheltered except on the E., but has little commercial importance, being mainly a naval station. To the N.W. is the suburb of Elena (formerly Borgo di Gaeta). Pop. (1901) 10,369. Above the town is a castle erected by the Angevin kings, and strengthened at various periods. The cathedral of St Erasmus (S. Elmo), consecrated in 1106, has a fine campanile begun in

¹ The *New English Dictionary* has nothing to say. Webster gives the etymology *gad well* = go about well. Dr R. G. Latham suggested that it was taken from the syllables *quedul*, of the Lat. *quercyuedula*, a teal. The spelling "gadwall" seems to be first found in Willughby in 1676, and has been generally adopted by later writers; but Merrett, in 1667, has "gaddel" (*Pisces verum naturalium Britannicarum*, p. 180), saying that it was so called by bird-dealers. The synonym "gray," given by Willughby and Ray, is doubtless derived from the general colour of the species, and has its analogue in the Icelandic *Gráand*, applied almost indifferently, or with some distinguishing epithet, to the female of any of the freshwater ducks, and especially to both sexes of the present, in which, as stated in the text, there is comparatively little conspicuous difference of plumage in drake and duck.

860 and completed in 1270, and a nave and four aisles; the interior has, however, been modernized. Opposite the door of the cathedral is a candelabrum with interesting sculptures of the end of the 13th century, consisting of 48 panels in bas-relief, with 24 representations from the life of Christ, and 24 of the life of St Erasmus (A. Venturi, *Storia dell' arte Italiana*, iii. Milan, 1904, 642 seq.). The cathedral possesses three fine *Exultet* rolls, with miniatures dating from the 11th to the beginning of the 13th century. Behind the high altar is the banner sent by Pope Pius V. to Don John of Austria, the victor of Lepanto. The constable of Bourbon, who fell in the sack of Rome of 1527, is buried here. The other churches are of minor interest; close to that of La Trinità is the Montagna Spaccata, where a vertical fissure from 6 to 15 ft. wide runs right down to the sea-level. Over the chasm is a chapel *dell' Crocifisso*, the mountain having split, it is said, at the death of Christ.

During the break-up of the Roman empire, Gaeta, like Amalfi and Naples, would seem to have established itself as a practically independent port and to have carried on a thriving trade with the Levant. Its history, however, is obscure until, in 823, it appears as a lordship ruled by hereditary *hypati* or consuls. In 844 the town fell into the hands of the Arabs, but four years later they were driven out with help supplied by Pope Leo IV. In 875 the town was in the hands of Pope John VIII., who gave it to the count of Capua as a fief of the Holy See, which had long claimed jurisdiction over it. In 877, however, the *hypatus* John (Ioannes) II. succeeded in recovering the lordship, which he established as a duchy under the suzerainty of the East Roman emperors. In the 11th century the duchy fell into the hands of the Norman counts of Aversa, afterwards princes of Capua, and in 1135 it was definitely annexed to his kingdom by Roger of Sicily. The town, however, had its own coinage as late as 1229.

In military history the town has played a conspicuous part. Its fortifications were strengthened in the 15th century. On the 30th of September 1707 it was stormed, after a three months' siege, by the Austrians under Daun; and on the 6th of August 1734 it was taken, after a siege of four months, by French, Spanish and Sardinian troops under the future King Charles of Naples. The fortifications were again strengthened; and in 1799 it was temporarily occupied by the French. On the 18th of July 1806 it was captured, after an heroic defence, by the French under Masséna; and on the 18th of July 1815 it capitulated, after a three months' siege, to the Austrians. In November 1848 Pope Pius IX., after his flight in disguise from Rome, found a refuge at Gaeta, where he remained till the 4th of September 1849. Finally, in 1860, it was the scene of the last stand of Francis II. of Naples against the forces of United Italy. Shut up in the fortress with 12,000 men, after Garibaldi's occupation of Naples, the king, inspired by the heroic example of Queen Maria, offered a stubborn resistance, and it was not till the 13th of February 1861 that, the withdrawal of the French fleet having made bombardment from the sea possible, he was forced to capitulate.

See C. B. Federici, *Depli antichi duchi, consoli o ipati della città di Gaeta* (Naples, 1791); Onorato Gaetani d' Aragona, *Mem. stor. della città di Gaeta* (Milan, 1879); C. Ravizza, *Il Golfo di Gaeta* (Novara, 1876) (T. As.)

GAETANI, or **CAETANI**, the name of the oldest of the Roman princely families which played a great part in the history of the city and of the papacy. The Gaetani are of Longobard origin, and the founder of the house is said to be one Dominus Constantinus Caetanus, who flourished in the 10th century, but the family had no great importance until the election of Benedetto Gaetani to the papacy as Boniface VIII. in 1294, when they at once became the most notable in the city. The pope conferred on them the fiefs of Sermoneta, Bassiano, Ninfa and San Donato (1297-1300), and the marquise of Ancona in 1300, while Charles II. of Anjou created the pope's brother count of Caserta. Giordano Loffredo Gaetani by his marriage with Giovanna dell' Aquila, heiress of the counts of Fondi and Traetto, in 1297 added the name of Aquila to his own, and his grandson Giacomo acquired the lordships of Piedimonte and Gioia. The Gaetani

proved brave warriors and formed a bodyguard to protect Boniface VIII. from his many foes. During the 14th and 15th centuries their feuds with the Colonna caused frequent disturbances in Rome and the Campagna, sometimes amounting to civil war. They also played an important rôle as Neapolitan nobles. In 1500 Alexander VI., in his attempt to crush the great Roman feudal nobility, confiscated the Gaetani fiefs and gave them to his daughter Lucrezia Borgia (q.v.); but they afterwards regained them.

At present there are two lines of Gaetani: (1) Gaetani, princes of Teano and dukes of Sermoneta, founded by Giacobello Gaetani, whose grandson, Guglielmo Gaetani, was granted the duchy of Sermoneta by Pius III. in 1503, the marquise of Cisterna being conferred on the family by Sixtus V. in 1585. In 1642, Francesco, the 7th duke of Sermoneta, acquired by marriage the county of Caserta, which was exchanged for the principality of Teano in 1750. The present head of the house, Onorato Gaetani, 14th duke of Sermoneta, 4th prince of Teano, duke of San Marco, marquis of Cisterna, &c., is a senator of the kingdom of Italy, and was minister for foreign affairs for a short time. (2) Gaetani dell' Aquila d' Aragona, princes of Piedimonte, and dukes of Laurenzana, founded by Onorato Gaetani dell' Aquila, count of Fondi, Traetto, Alife and Morcone, lord of Piedimonte and Gioia, in 1454. The additional surname of Aragona was assumed after the marriage of Onorato Gaetani, duke of Traetto (d. 1529), with Lucrezia of Aragon, natural daughter of King Ferdinand I. of Naples. The duchy of Laurenzana, in the kingdom of Naples, was acquired by Alfonso Gaetani by his marriage in 1606 with Giulia di Ruggiero, duchess of Laurenzana. The lordship of Piedimonte was raised to a principality in 1715. The present (1908) head of the house is Nicola Gaetani dell' Aquila d' Aragona (b. 1857), 7th prince of Piedimonte and 12th duke of Laurenzana.

See A. von Reumont, *Geschichte der Stadt Rom* (Berlin, 1868); F. Gregorovius, *Geschichte der Stadt Rom* (Stuttgart, 1872); *Almanach de Gotha* (1907 and 1908).

GAETULIA, an ancient district in northern Africa, which in the usage of Roman writers comprised the wandering tribes of the southern slopes of Mount Aures and the Atlas, as far as the Atlantic, and the oases in the northern part of the Sahara. They were always distinguished from the Negro people to the south, and beyond doubt belonged to the same Berber race which formed the basis of the population of Numidia and Mauretania (q.v.). The tribes to be found there at the present day are probably of the same race, and retain the same wandering habits; and it is possible that they still bear in certain places the name of their Gaetulian ancestors (see Vivien St Martin, *Le Nord de l' Afrique*, 1863). A few only seem to have mingled with the Negroes of the Sahara, if we may thus interpret Ptolemy's allusion to Melano-Gaetuli (4. 6. 5). They were noted for the rearing of horses, and according to Strabo had 100,000 foals in a single year. They were clad in skins, lived on flesh and milk, and the only manufacture connected with their name is that of the purple dye which became famous from the time of Augustus onwards, and was made from the purple fish found on the coast, apparently both in the Syrtis and on the Atlantic.

We first hear of this people in the Jugurthine War (111-106 B.C.), when, as Sallust tells us, they did not even know the name of Rome. They took part with Jugurtha against Rome; but when we next hear of them they are in alliance with Caesar against Juba I. (*Bell. Afr.* 32). In 25 B.C. Augustus seems to have given a part of Gaetulia to Juba II., together with his kingdom of Mauretania, doubtless with the object of controlling the turbulent tribes; but the Gaetulians rose and massacred the Roman residents, and it was not till a severe defeat had been inflicted on them by Lentulus Cossus (who thus acquired the surname Gaetulicus) in A.D. 6 that they submitted to the king. After Mauretania became a Roman province in A.D. 40, the Roman governors made frequent expeditions into the Gaetulian territory to the south, and the official view seems to be expressed by Pliny (v. 4. 30) when he says that all Gaetulia as far as the Niger and the Ethiopian frontier was reckoned as subject to the

Empire. How far this represents the fact is not clear; but inscriptions prove that Gaetulians served in the auxiliary troops of the empire, and it may be assumed that the country passed within the sphere of Roman influence, though hardly within the pale of Roman civilization.

For bibliography see AFRICA, ROMAN.

GAGE, LYMAN JUDSON (1836-), American financier, was born at De Ruyter, Madison county, New York, on the 28th of June 1836. He was educated at an academy at Rome, New York, where at the age of seventeen he became a bank clerk. In 1855 he removed to Chicago, served for three years as book-keeper in a planing-mill, and in 1858 entered the banking house of the Merchant's Loan and Trust Company, of which he was cashier in 1861-1868. Afterwards he became successively assistant cashier (1868), vice-president (1882), and president (1891) of the First National Bank of Chicago, one of the strongest financial institutions in the middle west. He was chosen in 1892 president of the board of directors of the World's Columbian Exposition, the successful financing of which was due more to him than to any other man. In politics he was originally a Republican, and was a delegate to the national convention of the party in 1880, and chairman of its finance committee. In 1884, however, he supported Grover Cleveland for the presidency, and came to be looked upon as a Democrat. In 1892 President Cleveland, after his second election, offered Gage the post of secretary of the treasury, but the offer was declined. In the "free-silver" campaign of 1896 Gage laboured effectively for the election of William McKinley, and from March 1897 until January 1902 he was secretary of the treasury in the cabinets successively of Presidents McKinley and Roosevelt. From April 1902 until 1906 he was president of the United States Trust Company in New York City. His administration of the treasury department, through a more than ordinarily trying period, was marked by a conservative policy, looking toward the strengthening of the gold standard, the securing of greater flexibility in the currency, and a more perfect adjustment of the relations between the government and the National banks.

GAGE, THOMAS (1721-1787), British general and governor of Massachusetts, second son of the first Viscount Gage, was born in 1721. He entered the army in 1741 and saw service in Flanders and in the campaign of Culloden, becoming lieutenant-colonel in the 44th foot in March 1751. In 1754 he served in America, and he took part in the following year in General Braddock's disastrous expedition. In 1758 he became colonel of a new regiment, and served in Amherst's operations against Montreal. He was made governor of Montreal, and promoted major-general in 1761, and in 1763 succeeded Amherst in the command of the British forces in America; in 1770 he was made a lieutenant-general. In 1774 he was appointed governor of Massachusetts, and in that capacity was entrusted with carrying into effect the Boston Port Act. The difficulties which surrounded him in the execution of his office at this time of the gravest unrest culminated in 1775, and the action of the 19th of April at Lexington initiated the American War of Independence. After the battle of Bunker Hill, Gage was superseded by General (Sir William) Howe, and returned to England. He became general in 1782, and died on the 2nd of April 1787.

GAGE, a pledge, something deposited as security for the performance of an agreement, and liable to be forfeited on failure to carry it out. The word also appears in "engage," and is taken from the O. Fr., as are "wage," payment for services, and "wager," bet, stake, from the collateral O. Fr. *waige*. These two words are from the Low Lat. *wadiare, vodiare*, to pledge, *vadium*, classical Lat. *vas, vadis*, but may be from the old Teutonic cognate base seen in Gothic *wadi*, a pledge (cf. Ger. *wetten*, to wager); this Teutonic base is seen in Eng. "wed," to marry, i.e. to engage by a pledge (cf. Goth. *gawadjon*, to betrothe). A particular form of giving a "gage" or pledge was that of throwing down a glove or gauntlet as a challenge to a judicial combat, the glove being the "pledge" that the parties would appear on the field; hence the common phrase "to throw down the gage of defiance" for any challenge (see *GLOVE* and *WAER*).

GAGERN, HANS CHRISTOPH ERNST, BARON VON (1766-1852), German statesman and political writer, was born at Kleinniedesheim, near Worms, on the 25th of January 1766. After studying law at the universities of Leipzig and Göttingen, he entered the service of the prince of Nassau-Weilburg, whom in 1791 he represented at the imperial diet. He was afterwards appointed the prince's envoy at Paris, where he remained till the decree of Napoleon, forbidding all persons born on the left side of the Rhine to serve any other state than France, compelled him to resign his office (1811). He then retired to Vienna, and in 1812 he took part in the attempt to excite a second insurrection against Napoleon in Tirol. On the failure of this attempt he left Austria and joined the headquarters of the Prussian army (1813), and became a member of the board of administration for north Germany. In 1814 he was appointed administrator of the Orange principalities; and, when the prince of Orange became king of the Netherlands, Baron Gager became his prime minister. In 1815 he represented him at the congress of Vienna, and succeeded in obtaining for the Netherlands a considerable augmentation of territory. From 1816 to 1818 he was Luxemburg envoy at the German diet, but was recalled, at the instance of Metternich, owing to his too independent advocacy of state constitutions. In 1820 he retired with a pension to his estate at Hornau, near Höchst, in Hesse-Darmstadt; but as a member of the first chamber of the states of the grand-duchy he continued to take an active share in the promotion of measures for the welfare of his country. He retired from public life in 1848, and died at Hornau on the 22nd of October 1852. Baron von Gager wrote a history of the German nation (Vienna, 1813; 2nd ed., 2 vols., Frankfurt, 1825-1826), and several other books on subjects connected with history and social and political science. Of most permanent value, however, is his autobiography, *Mein Anteil an der Politik*, 5 vols. (Stuttgart and Leipzig, 1823-1845).

Of Hans Christoph von Gager's sons three attained considerable eminence:—

FRIEDRICH BALDUIN, Freiherr von Gager (1794-1848), the eldest, was born at Weilburg on the 24th of October 1794. He entered the university of Göttingen, but soon left, and, taking service in the Austrian army, took part in the Russian campaign of 1812, and fought in the following year at Dresden, Kulm and Leipzig. He then entered the Dutch service, took part in the campaigns of 1815, and, after studying another year at Heidelberg, was member for Luxemburg of the military commission of the German federal diet (1824, 1825). In 1830 and 1831 he took part in the Dutch campaign in Belgium, and in 1844, after being promoted to the rank of general, was sent on an important mission to the Dutch East Indies to inquire into the state of their military defences. In 1847 he was appointed governor at the Hague, and commandant in South Holland. In the spring of 1848 he was in Germany, and on the outbreak of the revolutionary troubles he accepted the invitation of the government of Baden to take the command against the insurgent "free companies" (*Freischaren*). At Kandern, on the 20th of April, he made a vain effort to persuade the leaders to submit, and was about to order his troops to attack when he was mortally wounded by the bullets of the insurgents. His *Life*, in 3 vols. (Heidelberg and Leipzig, 1856-1857), was written by his brother Heinrich von Gager.

HEINRICH WILHELM AUGUST, Freiherr von Gager (1799-1880), the third son, was born at Bayreuth on the 20th of August 1799, educated at the military academy at Munich, and, as an officer in the service of the duke of Nassau, fought at Waterloo. Leaving the service after the war, he studied jurisprudence at Heidelberg, Göttingen and Jena, and in 1819 went for a while to Geneva to complete his studies. In 1821 he began his official career as a lawyer in the grand-duchy of Hesse, and in 1832 was elected to the second chamber. Already at the universities he had proclaimed his Liberal sympathies as a member of the *Burschenschaft*, and he now threw himself into open opposition to the unconstitutional spirit of the Hessian government, an attitude which led to his dismissal from the state service in 1833. Henceforth he lived in comparative retirement, cultivating a

farm rented by his father at Monsheim, and occasionally publishing criticisms of public affairs, until the February revolution of 1848 and its echoes in Germany recalled him to active political life. For a short while he was at the head of the new Hessian administration; but his ambition was to share in the creation of a united Germany. At the Heidelberg meeting and the preliminary convention (*Vorparlament*) of Frankfurt he deeply impressed the assemblies with the breadth and moderation of his views; with the result that when the German national parliament met (May 18), he was elected its first president. His influence was at first paramount, both with the Unionist party and with the more moderate elements of the Left, and it was he who was mainly instrumental in imposing the principle of a united empire with a common parliament, and in carrying the election of the Archduke John as regent. With the growing split between the Great Germans (*Grossdeutschen*), who wished the new empire to include the Austrian provinces, and the Little Germans (*Kleindeutschen*), who realized that German unity could only be attained by excluding them, his position was shaken. On the 15th of December, when Schmerling and the Austrian members had left the cabinet, Gagern became head of the imperial ministry, and on the 18th he introduced a programme (known as the *Gagernsche Programm*) according to which Austria was to be excluded from the new federal state, but bound to it by a treaty of union. After a severe struggle this proposal was accepted; but the academic discussion on the constitution continued for weary months, and on the 20th of May, realizing the hopelessness of coming to terms with the ultra-democrats, Gagern and his friends resigned. Later on he attempted to influence the Prussian Northern Union in the direction of the national policy, and he took part in the sessions of the Erfurt parliament; but, soon realizing the hopelessness of any good results from the vacillating policy of Prussia, he retired from the contest, and, as a major in the service of the Schleswig-Holstein government, took part in the Danish War of 1850. After the war he retired into private life at Heidelberg. In 1862, misled by the constitutional tendency of Austrian politics, he publicly declared in favour of the Great German party. In 1864 he went as Hessian envoy to Vienna, retiring in 1872 when the post was abolished. He died at Darmstadt on the 22nd of May 1880.

MAXIMILIAN, Freiherr von Gagern (1810–1880), the youngest son, was born at Weilburg on the 26th of March 1810. Up to 1848 he was a government official in Nassau; in that year he became a member of the German national parliament and under-secretary of state for foreign affairs. Throughout the revolutionary years he supported his brother's policy, became a member of the Erfurt parliament, and, after the collapse of the national movement, returned to the service of the duchy of Nassau. In 1855 he turned Roman Catholic and entered the Austrian service as court and ministerial councillor in the department of foreign affairs. In 1871 he retired, and in 1881 was nominated a life member of the Upper Chamber (*Herrenhaus*). He died at Vienna on the 17th of October 1889.

See *Allgemeine deutsche Biographie*, Band viii. p. 301, &c. (1878) and Band xlix. p. 654 (1904).

GAHANBAR, festivals of the ancient Avesta calendar celebrated by the Parsees at six seasons of the year which correspond with the six periods of creation: (1) *Maidhyozaremaya* (mid spring), (2) *Maidhyashema* (midsummer), (3) *Paitishahya* (season of corn), (4) *Ayathrema* (season of flocks), (5) *Maidhyarya* (winter solstice), (6) *Hamaspahmaedha* (festival of sacrifices).

GAIGNIÈRES, FRANÇOIS ROGER DE (1642–1715), French genealogist, antiquary and collector, was the son of Aimé de Gaignières, secretary to the governor of Burgundy, and was born on the 30th of December 1642. He became écuyer (esquire) to Louis Joseph, duke of Guise, and afterwards to Louis Joseph's aunt, Marie of Guise, by whom in 1679 he was appointed governor of her principality of Joinville. At an early age he began to make a collection of original materials for history generally, and, in particular, for that of the French church and court. He brought together a large collection of original letters and other

documents, together with portraits and prints, and had copies made of a great number of the most curious antiquarian objects, such as seals, tombstones, stained glass, miniatures and tapestry. In 1711 he presented the whole of his collections to the king. The bulk of them is preserved in the Bibliothèque Nationale at Paris, and a certain number in the Bodleian library at Oxford.

See G. Duplessis, *Roger de Gaignières* (Paris, 1870); L. Delisle, *Cabinet des manuscrits*, t. i. pp. 335–356; H. Bouchot, *Les Portraits aux crayons des XVI^e et XVII^e siècles* (Paris, 1884); Ch. de Grandmaison, *Gaignières, ses correspondants et ses collections de portraits* (Niort, 1892).

GAIL, JEAN BAPTISTE (1755–1829), French hellenist, was born in Paris on the 4th of July 1755. In 1791 he was appointed deputy, and in 1792 titular professor at the Collège de France. During the Revolution he quietly performed his professional duties, taking no part in politics, although he possessed the faculty of ingratiating himself with those in authority. In 1815 he was appointed by the king keeper of Greek MSS. in the royal library over the heads of the candidates proposed by the other conservators, an appointment which made him many enemies. Gail imagined that there was an organized conspiracy to belittle his learning and professional success, and there was a standing quarrel between him and his literary opponents, the most distinguished of whom was P. L. Courier. He died on the 5th of February 1829. Without being a great Greek scholar, Gail was a man of unweary industry, whose whole life was devoted to his favourite studies, and he deserves every credit for having rescued Greek from the neglect into which it had fallen during the troublous times in which he lived. The list of Gail's published works filled 500 quarto pages of the introduction to his edition of Xenophon. The best of these is his edition of Theocritus (1828). He also wrote a number of elementary educational works, based on the principles of the school of Port Royal. His communications to the Académie des Inscriptions being coldly received and seldom accorded the honour of print, he inserted them in a vast compilation in 24 volumes, which he called *Le Philologue*, containing a mass of ill-digested notes on Greek grammar, geography, archaeology, and various authors.

See "Notice historique sur la vie et les ouvrages de J. B. G." in *Mém. de l'Acad. des Inscriptions*, ix.; the articles in *Biographie universelle* (by A. Pillon) and Ersch and Gruber's *Allgemeine Encyclopädie* (by C. F. Bähr); a list of his works will be found in J. M. Quérard, *La France littéraire* (1829), including the contents of the volumes of *Le Philologue*.

GAILLAC, a town of south-western France, capital of an arrondissement in the department of Tarn, on the right bank of the Tarn, 15 m. W. of Albi on the railway from that city to Toulouse. Pop. (1906) town, 5388; commune, 7535. The churches of St Michel and St Pierre, both dating from the 13th and 14th centuries, have little architectural importance. There are some interesting houses, one of which, the Maison Yversen, of the Renaissance, is remarkable for the rich carving of its doors. The public institutions include the sub-prefecture, a tribunal of first instance, and a communal college. Its industries include the manufacture of lime and wooden shoes, while dyeing, wood-sawing and flour-milling are also carried on; it has a considerable trade in grain, flour, vegetables, dried plums, anise, coriander, &c., and in wine, the white and red wines of the arrondissement having a high reputation. Gaillac grew up round the Benedictine abbey of St Michel, founded in the 10th century.

GAILLARD, GABRIEL HENRI (1726–1806), French historian, was born at Ostel, Picardy, in 1726. He was educated for the bar, but after finishing his studies adopted a literary career, ultimately devoting his chief attention to history. He was already a member of the Academy of Inscriptions and Belles-lettres (1760), when, after the publication of the three first volumes of his *Histoire de la rivalité de la France et d'Angleterre*, he was elected to the French Academy (1771); and when Napoleon created the Institute he was admitted into its third class (*Académie française*) in 1803. For forty years he was the intimate friend of Malesherbes, whose life (1805) he wrote. He died at St Firmin, near Chantilly, on the 13th of February 1806. Gaillard is painstaking and impartial in his statement of facts,

and his style is correct and elegant, but the unity of his narrative is somewhat destroyed by digressions, and by his method of treating war, politics, civil administration, and ecclesiastical affairs under separate heads. His most important work is his *Histoire de la rivalité de la France et de l'Angleterre* (in 11 vols., 1771-1777); and among his other works may be mentioned *Essai de rhétorique française, et l'usage des jeunes demoiselles* (1745), often reprinted, and in 1822 with a life of the author; *Histoire de Marie de Bourgogne* (1757); *Histoire de François I^r* (7 vols., 1776-1779); *Histoire des grandes querelles entre Charles V. et François I^r* (2 vols., 1777); *Histoire de Charlemagne* (2 vols., 1782); *Histoire de la rivalité de la France et de l'Espagne* (8 vols., 1801); *Dictionnaire historique* (6 vols., 1789-1804), making part of the *Encyclopédie méthodique*; and *Mélanges littéraires*, containing *éloges* on Charles V., Henry IV., Descartes, Corneille, La Fontaine, Malesherbes and others.

GAINESVILLE, a city and the county-seat of Alachua county, Florida, U.S.A., about 70 m. S.W. of Jacksonville. Pop. (1890) 2790; (1900) 3633, of whom 1803 were negroes; (1905) 5413; (1910) 6183. Gainesville is served by the Atlantic Coast Line, the Seaboard Air Line, and the Tampa & Jacksonville railways, and is an important railway junction. It is the seat of the University of the State of Florida, established at Lake City in 1905 and removed to Gainesville in 1906. The university includes a school of language and literature, a general scientific school, a school of agriculture, a technological school, a school of pedagogy, a normal school, and an agricultural experiment station. In 1908 the university had 15 instructors and 103 students. The Florida Winter Bible Conference and Chautauqua is held here. Gainesville is well known as a winter resort, and its climate is especially beneficial to persons affected by pulmonary troubles. In the neighbourhood are the Alachua Sink, Payne's Prairie, Newman's Lake, the Devil's Mill Hopper and other objects of interest. The surrounding country produces Sea Island cotton, melons, citrus and other fruits, vegetables and naval stores. About 15 m. W. of the city there is a rich phosphate mining district. The city has bottling works, and manufactures fertilizers, lumber, coffins, ice, &c. The municipality owns and operates the water-works; the water-supply comes from a spring 2 m. from the city, and the water closely resembles that of the Poland Springs in Maine. Gainesville is in the midst of the famous Seminole country. The first settlement was made here about 1850; and Gainesville, named in honour of General E. P. Gaines, was incorporated as a town in 1869, and was chartered as a city in 1907.

GAINESVILLE, a city and the county-seat of Cooke county, Texas, U.S.A., about 6 m. S. of the Red river, and about 60 m. N. of Fort Worth. Pop. (1890) 6594; (1900) 7874 (1201 negroes and 260 foreign-born); (1910) 7624. The city is served by the Gulf, Colorado & Santa Fé, and the Missouri, Kansas & Texas railways, and by an interurban electric railway. Gainesville is a trading centre and market for the surrounding country, in which cotton, grains, garden truck, fruit and alfalfa are grown and live-stock is raised; and a wholesale distributing point for the neighbouring region in Texas and Oklahoma. The city has cotton-compresses and cotton-gins, and among its manufactures are cotton-seed oil, flour, cement blocks, pressed bricks, canned goods, foundry products, waggon-beds and creamery products. Gainesville was settled about 1851, was incorporated in 1873, and was chartered as a city in 1879; it was named in honour of General Edmund Pendleton Gaines (1777-1849), who served with distinction in the War of 1812, becoming a brigadier-general in March 1814 and receiving the brevet of major-general and the thanks of Congress for his defence of Fort Erie in August 1814. Gaines took a prominent part in the operations against the Seminoles in Florida in 1817 (when he was in command of the Southern Military District) and in 1836 and during the Mexican War commanded the department of the South-West, with headquarters at New Orleans.

GAINSBOROUGH, THOMAS (1727-1788), English painter, one of the greatest masters of the English school in portraiture, and only less so in landscape, was born at Sudbury, Suffolk, in

the spring of 1727. His father, who carried on the business of a woollen crape-maker in that town, was of a respectable character and family, and was noted for his skill in fencing; his mother excelled in flower-painting, and encouraged her son in the use of the pencil. There were nine children of the marriage, two of the painter's brothers being of a very ingenious turn.

At ten years old, Gainsborough "had sketched every fine tree and picturesque cottage near Sudbury," and at fourteen, having filled his task-books with caricatures of his schoolmaster, and sketched the portrait of a man whom he had detected on the watch for robbing his father's orchard, he was allowed to follow the bent of his genius in London, with some instruction in etching from Gravelot, and under such advantages as Hayman, the historical painter, and the academy in St Martin's Lane could afford. Three years of study in the metropolis, where he did some modelling and a few landscapes, were succeeded by two years in the country. Here he fell in love with Margaret Burr, a young lady of many charms, including an annuity of £200, married her after painting her portrait, and a short courtship, and, at the age of twenty, became a householder in Ipswich, his rent being £6 a year. The annuity was reported to come from Margaret's real (not her putative) father, who was one of the exiled Stuart princes or else the duke of Bedford. She was sister of a young man employed by Gainsborough's father as a traveller. At Ipswich, Gainsborough tells us, he was "chiefly in the face-way"; his sitters were not so numerous as to prevent him from often rambling with his friend Joshua Kirby (president of the Society of Artists) on the banks of the Orwell, from painting many landscapes with an attention to details which his later works never exhibited, or from joining a musical club and entertaining himself and his fellow-townsmen by giving concerts. As he advanced in years he became ambitious of advancing in reputation. Bath was then the general resort of wealth and fashion, and to that city, towards the close of the year 1750, he removed with his wife and two daughters, the only issue of their marriage. His studio in the circus was soon thronged with visitors; he gradually raised his price for a half-length portrait from 5 to 40 guineas, and for a whole-length from 8 to 100 guineas; and he rapidly developed beyond the comparatively plain and humdrum quality of his Ipswich paintings. Among his sitters at this period were the authors Sterne and Richardson, and the actors Quin, Henderson and Garrick. Meanwhile he contributed both portraits and landscapes to the annual exhibitions in London. He indulged his taste for music by learning to play the viol-di-gamba, the harp, the hautboy, the violoncello. His house harboured Italian, German, French and English musicians. He haunted the green-room of Palmer's theatre, and painted gratuitously the portraits of many of the actors: he constantly gave away his sketches and landscapes. In the summer of 1774, having already attained a position of great prosperity, he took his departure for London, and fixed his residence at Schomberg House, Pall Mall, a noble mansion still standing, for a part of which the artist paid £300 a year.

Gainsborough had not been many months in London ere he received a summons to the palace, and to the end of his career he divided with West the favour of the court, and with Reynolds the favour of the town. Sheridan, Burke, Johnson, Franklin, Canning, Lady Mary Wortley Montagu, Mrs Siddons, Clive, Blackstone, Hurd, were among the number of those who sat to him. But in London as in Bath his landscapes were exhibited, were commended, and were year after year returned to him, "till they stood," says Sir William Beechey, "ranged in long lines from his hall to his painting-room." Gainsborough was a member of the Royal Academy, one of the original 36 elected in 1768; but in 1784, being dissatisfied with the position assigned on the exhibition walls to his portrait of the three princesses, he withdrew that and his other pictures, and he never afterwards exhibited there. Even before this he had taken no part in the business of the Institution. After seceding he got up an exhibition in his own house, not successfully. In February 1788, while witnessing the trial of Warren Hastings, he felt an extraordinary chill at the back of his neck; this was the beginning of a cancer

(or, as some say, a malignant wen) which proved fatal on the 2nd of August of the same year. He lies buried at Kew.

Gainsborough was tall, fair and handsome, generous, impulsive to the point of capriciousness, easily irritated, not of bookish likings, a lively talker, good at repartee. He was a most thorough embodiment of the artistic temperament; delighting in nature and "the look of things," insatiable in working, fond of music and the theatre hardly less than of painting—a warm, rich personality, to whom severe principle was perhaps as foreign as deliberate wrong-doing. The property which he left at his death was not large. One of his daughters, Mary, had married the musician Fischer contrary to his wishes, and was subject to fits of mental aberration. The other daughter, Margaret, died unmarried. Mrs Gainsborough, an extremely sweet-tempered woman, survived her husband ten years. There is a pretty anecdote that Gainsborough, if he ever had a tiff with her, would write a pacifying note, confiding it to his dog Fox, who delivered it to the lady's pet spaniel Tristram. The note was worded as in the person of Fox to Tristram, and Mrs Gainsborough replied in the best of humours, as from Tristram to Fox.

Gainsborough and Reynolds rank side by side as the greatest portrait-painters of the English school. They were at variance; but Gainsborough on his death-bed sought and obtained a reconciliation. It is difficult to say which stands the higher of the two, although Reynolds may claim to have worked with a nearer approach to even and demonstrable excellence. In grace, spirit, and lightness of insight and of touch, Gainsborough is peculiarly eminent. His handling was slight for the most part, and somewhat arbitrary, but in a high degree masterly; and his landscapes and rustic compositions are not less gifted than his portraits. Among his finest works are portraits of "Lady Ligonier," "Georgiana, duchess of Devonshire," "Master Buttall (the Blue Boy)," now in Grosvenor House, "Mrs Sheridan and Mrs Tickell," "Orpin, the parish clerk" (National Gallery), "the Hon. Mrs Graham" (Scottish National Gallery), his own portrait (Royal Academy), "Mrs Siddons" (National Gallery); also "the Cottage Door," "the Market Cart," "the Return from Harvest," "the Woodman and his Dog in a Storm" (destroyed by fire), and "Waggon and Horses passing a Brook" (National Gallery—this was a favourite with its painter). He made a vast number of drawings and sketches.

A few observations may be added: (1) as to individual works by Gainsborough, and (2) as to his general characteristics as a painter.

Two of his first portraits, executed when he was settled at Ipswich, were separate likenesses of Mr and Mrs Hingeston. His first great hit was made at Bath with a portrait of Lord Nugent. With a likeness of Mr Poyntz, 1762, we find a decided advance in artistic type, and his style became fixed towards 1768. The date of the "Blue Boy" is somewhat uncertain: most accounts name 1779, but perhaps 1770 is nearer the mark. This point is not without interest for dilettanti; because it is said that Gainsborough painted the picture with a view to confuting a dictum of Reynolds, to the effect that blue was a colour unsuitable for the main light of a work. But, if the picture was produced before 1778, the date of Reynolds's dictum, this long-cherished and often-repeated tradition must be given up. A full-length of the duke of Norfolk was perhaps the latest work to which Gainsborough set his hand. His portrait of Elizabeth, duchess of Devonshire, famous for its long disappearance, has aroused much controversy; whether this painting, produced not long after Gainsborough had settled in London, and termed "the Duchess of Devonshire," does really represent that lady, is by no means certain. It was mysteriously stolen in 1876 in London immediately after it had been purchased by Messrs Agnew at the Wynn Ellis sale at a huge price, and a long time elapsed before it was retraced. The picture was taken to New York, and eventually to Chicago; and in April 1901, through the agency of a man named Pat Sheedy, it was given up to the American detectives working for Messrs Agnew; it was then sold to Mr Pierpont Morgan.

Gainsborough's total output of paintings exceeded 300,

including 220 portraits: he also etched at least 18 plates, and 3 in aquatint. At the date of his death 56 paintings remained on hand: these, along with 148 drawings, were then exhibited. In his earlier days he made a practice of copying works by Vandyck (the object of his more special admiration), Titian, Rubens, Teniers, Hobbema, Claude and some others, but not in a spirit of servile reproduction.

Gainsborough was pre-eminent in that very essential element of portraiture—truthful likeness. In process of time he advanced in the rendering of immediate expression, while he somewhat receded in general character. He always made his sitters look pleasant, and, after a while, distinguished. Unity of impression is one of the most marked qualities in his work; he seems to have seen his subject as an integer, and he wrought at the various parts of it together, every touch (and very wilful some of his touches look) tending towards the foreseen result. He painted with arrowy speed, more especially in his later years. For portraits he used at times brushes upon sticks 6 ft. long; there was but little light in his painting-room, and he often worked in the evenings. He kept his landscape work distinct from his portraiture, not ever adding to the latter a fully realized landscape background; his views he never signed or dated—his likenesses only once or twice. His skies are constantly cloudy, the country represented is rough and broken; the scenes are of a pastoral kind, with an effect generally of coming rain, or else of calm sun-setting. The prevalent feeling of his landscapes is somewhat sad, and to children, whether in subject-groups or in portraits, he mostly lent an expression rather plaintive than mirthful. It should be acknowledged that, whether in portraiture or in landscape, the painter's mannerisms of execution increased in process of time—patchings of the brush, tufty foliage, &c.; some of his portraits are hurried and flimsy, with a minimum of solid content, though not other than artistic in feeling. Here are a few of his axioms:—"What makes the difference between man and man is real performance, and not genius or conception." "I don't think it would be more ridiculous for a person to put his nose close to the canvas and say the colours smelt offensive than to say how rough the paint lies, for one is just as material as the other with regard to hurting the effect and drawing of a picture." "The eye is the only perspective-master needed by a landscape-painter."

AUTHORITIES.—In 1788 Philip Thicknesse, Lieutenant-Governor of Landguard Fort, Ipswich, who had been active in promoting the artist's fortunes at starting, published *A Sketch of the Life and Paintings of Thomas Gainsborough*. He had quarrelled with the painter at Bath, partly because the latter had undertaken to do a portrait of him as a gift, and then neglected the work, and finally, in a huff, bundled it off only half done. The crucial question here is whether or not Gainsborough was reasonably pledged to perform any such gratuitous work, and this point has been contested. Thicknesse's book is in part adverse to Gainsborough, and more particularly so to his wife. Reynolds's "Lecture" on Gainsborough, replete with critical insight, should never be lost sight of as a leading document. In 1856 a heedfully compiled *Life of Thomas Gainsborough* was brought out by T. W. Fulcher. This was the first substantial work about him subsequent to Allan Cunningham's lively account (1829) in his *Lives of the Painters*. Of late years a great deal has been written, mainly but not by any means exclusively from the critical or technical point of view:—Sir Walter Armstrong (two works, 1896 and 1898); Mrs Arthur Bell (1902); Sir W. M. Conway, *Artistic Development of Reynolds and Gainsborough* (1886); Lord Ronald Sutherland Gower (1903); G. M. Brock-Arnold (1881). G. Pauli has brought out an illustrated work in Germany (1904) under the title *Gainsborough*. (W. M. R.)

GAINSBOROUGH, a market town in the W. Lindsey or Gainsborough parliamentary division of Lincolnshire, England; on the right (E.) bank of the Trent. Pop. of urban district (1901) 17,660. It is served by the Lincoln-Doncaster joint line of the Great Northern and Great Eastern railways, by which it is 16 m. N.W. of Lincoln, and by the Great Central railway. The parish church of All Saints is classic of the 18th century, excepting the Perpendicular tower. The two other parish churches are modern. The Old Hall, of the 15th century, enlarged in the 16th, is a picturesque building, forming three sides of a quadrangle, partially timber-framed, but having a beautiful oriel window and other parts of stone. There is also

a Tudor tower of brick. A literary and scientific institute occupy part of the building. Gainsborough possesses a grammar school (founded in 1589 by a charter of Queen Elizabeth) and other schools, town-hall, county court-house, Albert Hall and Church of England Institute. There is a large carrying trade by water on the Trent and neighbouring canals. Shipbuilding and iron-founding are carried on, and there are manufactures of linseed cake, and agricultural and other machinery.

Gainsborough (*Gegnesburh*) was probably inhabited by the Saxons on account of the fishing in the Trent. The *Saxon Chronicle* states that in 1013 the Danish king Sweyn landed here and subjugated the inhabitants. Gainsborough, though not a chartered borough, was probably one by prescription, for mention is made of burghal tenure in 1280. The privilege of the return of writs was conferred on the lord of the manor, Aymer de Valence, earl of Pembroke, in 1233, and confirmed to Ralph de Percy in 1283. Mention is made in 1204 of a Wednesday market, but there is no extant grant before 1258, when Henry III. granted a Tuesday market to William de Valence, earl of Pembroke, who also obtained from Edward I. in 1291 licence for an annual fair on All Saints' Day, and the seven preceding and eight following days. In 1243 Henry III. granted to John Talbot licence for a yearly fair on the eve, day and morrow of St James the Apostle. Queen Elizabeth in 1592 granted to Thomas Lord Burgh two fairs, to begin on Easter Monday and on the 9th of October, each lasting three days. Charles I. in 1635-1636 extended the duration of each to nine days. The Tuesday market is still held, and the fair days are Tuesday and Wednesday in Easter-week, and the Tuesday and Wednesday after the 20th of October.

See Adam Stark, *History and Antiquities of Gainsburgh* (London, 1843).

GAIRDNER, JAMES (1828-), English historian, son of John Gairdner, M.D., was born in Edinburgh on the 22nd of March 1828. Educated in his native city, he entered the Public Record Office in London in 1846, becoming assistant keeper of the public records (1859-1893). Gairdner's valuable and painstaking contributions to English history relate chiefly to the reigns of Richard III., Henry VII. and Henry VIII. For the "Rolls Series" he edited *Letters and Papers illustrative of the Reigns of Richard III. and Henry VII.* (London, 1861-1863), and *Memorials of Henry VII.* (London, 1858); and he succeeded J. S. Brewer in editing the *Letters and Papers*, foreign and domestic, of the reign of Henry VIII. (London, 1862-1905). He brought out the best edition of the *Paston Letters* (London, 1872-1875, and again 1896), for which he wrote a valuable introduction; and for the Camden Society he edited the *Historical collections of a Citizen of London* (London, 1876), and *Three 15th-century Chronicles* (London, 1880). His other works include excellent monographs on *Richard III.* (London, 1878, new and enlarged edition, Cambridge, 1898), and on *Henry VII.* (London, 1889, and subsequently); *The Houses of Lancaster and York* (London, 1874, and other editions); *The English Church in the 16th century* (London, 1902); *Lollardy and the Reformation in England* (1908); and contributions to the *Encyclopaedia Britannica*, the *Dictionary of National Biography*, the *Cambridge Modern History*, and the *English Historical Review*. Gairdner received the honorary degree of LL.D. from the university of Edinburgh in 1897, and was made a C.B. in 1900.

GAIRLOCH (Gaelic *gàrr*, short), a sea loch, village and parish in the west of the county of Ross and Cromarty, Scotland. Pop. of parish (1901) 3797. The parish covers a large district on the coast, and stretches inland beyond the farther banks of Loch Maree, the whole of which lies within its bounds. It also includes the islands of Dry and Horisdale in the loch, and Ewe in Loch Ewe, and occupies a total area of 200,646 acres. The place and loch must not be confounded with Gairloch in Dumbartonshire. Formerly an appanage of the earldom of Ross, Gairloch has belonged to the Mackenzies since the end of the 15th century. Flowerdale, an 18th-century house in the pretty little glen of the same name, lying close to the village, is the chief seat of the Gairloch branch of the clan Mackenzie. William

Ross (1762-1790), the Gaelic poet, who was schoolmaster of Gairloch, of which his mother was a native, was buried in the old kirkyard, where a monument commemorates him.

GAISERIC, or **GENSERIC** (c. 390-477), king of the Vandals, was a son of King Godegisel (d. 406), and was born about 390. Though lame and only of moderate stature, he won renown as a warrior, and became king on the death of his brother Gonderic in 428. In 428 or 429 he led a great host of Vandals from Spain into Roman Africa, and took possession of Mauretania. This step is said to have been taken at the instigation of Boniface, the Roman general in Africa; if true, Boniface soon repented of his action, and was found resisting the Vandals and defending Hippo Regius against them. At the end of fourteen months Gaiseric raised the siege of Hippo; but Boniface was forced to fly to Italy, and the city afterwards fell into the hands of the Vandals. Having pillaged and conquered almost the whole of Roman Africa, the Vandal king concluded a treaty with the emperor Valentinian III. in 435, by which he was allowed to retain his conquests; this peace, however, did not last long, and in October 439 he captured Carthage, which he made the capital of his kingdom. According to some authorities Gaiseric at this time first actually assumed the title of king. In religious matters he was an Arian, and persecuted the members of the orthodox church in Africa, although his religious policy varied with his relations to the Roman empire. Turning his attention in another direction he built a fleet, and the ravages of the Vandals soon made them known and feared along the shores of the Mediterranean. "Let us make," said Gaiseric, "for the dwellings of the men with whom God is angry," and he left the conduct of his marauding ships to wind and wave. In 455, however, he led an expedition to Rome, stormed the city, which for fourteen days his troops were permitted to plunder, and then returned to Africa laden with spoil. He also carried with him many captives, including the empress Eudoxia, who is said to have invited the Vandals into Italy. The Romans made two attempts to avenge themselves, one by the Western emperor, Majorianus, in 460, and the other by the Eastern emperor, Leo I., eight years later; but both enterprises failed, owing principally to the genius of Gaiseric. Continuing his course on the sea the king brought Sicily, Sardinia, Corsica and the Balearic Islands under his rule, and even extended his conquests into Thrace, Egypt and Asia Minor. Having made peace with the eastern emperor Zeno in 476, he died on the 25th of January 477. Gaiseric was a cruel and cunning man, possessing great military talents and superior mental gifts. Though the effect of his victories was afterwards neutralized by the successes of Belisarius, his name long remained the glory of the Vandals. The name Gaiseric is said to be derived from *gais*, a javelin, and *reiks*, a king.

See VANDALS; also T. Hodgkin, *Italy and her Invaders*, vol. II (London, 1892); E. Gibbon, *Decline and Fall of the Roman Empire* (ed. J. B. Bury, 1896-1900); L. Schmidt, *Geschichte der Vandalen* (Leipzig, 1901); and F. Martroye, *Genseric; La Conquête vandale en Afrique* (Paris, 1907).

GAISFORD, THOMAS (1779-1855), English classical scholar, was born at Iford, Wiltshire, on the 22nd of December 1779. Proceeding to Oxford in 1797, he became successively student and tutor of Christ Church, and was in 1811 appointed regius professor of Greek in the university. Taking orders, he held (1815-1847) the college living of Westwell, in Oxfordshire, and other ecclesiastical preferments simultaneously with his professorship. From 1831 until his death on the 2nd of June 1855, he was dean of Christ Church. As curator of the Bodleian and principal delegate of the University Press he was instrumental in securing the co-operation of distinguished European scholars as collators, notably Bekker and Dindorf. Among his numerous contributions to Greek literature may be mentioned, Hephæstion's *Encheiridion* (1810); *Poëtae Graeci minores* (1814-1820); Stobaeus' *Florilegium* (1822); *Herodotus*, with variorum notes (1824); Suidas' *Lexicon* (1834); *Elymologicon magnum* (1848); Eusebius' *Praeparatio* (1843) and *Demonstratio evangelica* (1852). In 1856 the Gaisford prizes, for Greek composition, were founded at Oxford to perpetuate his memory.

GAIUS, a celebrated Roman jurist. Of his personal history very little is known. It is impossible to discover even his full name, Gaius or Caius being merely the personal name (praenomen) so common in Rome. From internal evidence in his works it may be gathered that he flourished in the reigns of the emperors Hadrian, Antoninus Pius, Marcus Aurelius and Commodus. His works were thus composed between the years 130 and 180, at the time when the Roman empire was most prosperous, and its government the best. Most probably Gaius lived in some provincial town, and hence we find no contemporary notices of his life or works. After his death, however, his writings were recognized as of great authority, and the emperor Valentinian named him, along with Papinian, Ulpian, Modestinus and Paulus, as one of the five jurists whose opinions were to be followed by judicial officers in deciding cases. The works of these jurists accordingly became most important sources of Roman law.

Besides the *Institutes*, which are a complete exposition of the elements of Roman law, Gaius was the author of a treatise on the *Edicts of the Magistrates*, of *Commentaries on the Twelve Tables*, and on the important *Lex Popia Poppaea*, and several other works. His interest in the antiquities of Roman law is apparent, and for this reason his work is most valuable to the historian of early institutions. In the disputes between the two schools of Roman jurists he generally attached himself to that of the Sabinians, who were said to be followers of Ateius Capito, of whose life we have some account in the *Annals* of Tacitus, and to advocate a strict adherence as far as possible to ancient rules, and to resist innovation. Many quotations from the works of Gaius occur in the *Digest* of Justinian, and so acquired a permanent place in the system of Roman law; while a comparison in the *Institutes* of Justinian with those of Gaius shows that the whole method and arrangement of the later work were copied from that of the earlier, and very numerous passages are word for word the same. Probably, for the greater part of the period of three centuries which elapsed between Gaius and Justinian, the *Institutes* of the former had been the familiar textbook of all students of Roman law.

Unfortunately the work was lost to modern scholars, until, in 1816, a manuscript was discovered by B. G. Niebuhr in the chapter library of Verona, in which certain of the works of St Jerome were written over some earlier writings, which proved to be the lost work of Gaius. The greater part of the palimpsest has, however, been deciphered and the text is now fairly complete. This discovery has thrown a flood of light on portions of the history of Roman law which had previously been most obscure. Much of the historical information given by Gaius is wanting in the compilations of Justinian, and, in particular, the account of the ancient forms of procedure in actions. In these forms can be traced "survivals" from the most primitive times, which provide the science of comparative law with valuable illustrations, which may explain the strange forms of legal procedure found in other early systems. Another circumstance which renders the work of Gaius more interesting to the historical student than that of Justinian, is that Gaius lived at a time when actions were tried by the system of formulae, or formal directions given by the praetor before whom the case first came, to the judge to whom he referred it. Without a knowledge of the terms of these formulae it is impossible to solve the most interesting question in the history of Roman law, and show how the rigid rules peculiar to the ancient law of Rome were modified by what has been called the equitable jurisdiction of the praetors, and made applicable to new conditions, and brought into harmony with the notions and the needs of a more developed society. It is clear from evidence of Gaius that this result was obtained, not by an independent set of courts administering, as in England previous to the Judicature Acts, a system different from that of the ordinary courts, but by the manipulation of the formulae. In the time of Justinian the work was complete, and the formula system had disappeared.

The *Institutes* of Gaius are divided into four books—the first treating of persons and the differences of the status they may occupy in the eye of the law; the second of things, and the modes in which rights over them may be acquired, including the

law relating to wills; the third of intestate succession and of obligations; the fourth of actions and their forms.

There are several carefully prepared editions of the *Institutes*, starting from that of Göschen (1820), down to that of Studemund and Krüger (1900). The most complete English edition is that of E. Poste, which includes beside the text an English translation and copious commentary (1885). A comparison of the early forms of actions mentioned by Gaius with those used by other primitive societies will be found in Sir H. Maine's *Early Institutions*, cap. 9. For further information see M. Glanville, *Étude sur Gaius et sur le jus respondendi*; also ROMAN LAW.

GAIUS CAESAR (A.D. 12–41), surnamed CALIGULA, Roman emperor from 37–41, youngest son of Germanicus and Agrippina the elder, was born on the 31st of August A.D. 12. He was brought up in his father's camp on the Rhine among the soldiers, and received the name Caligula from the *caligae*, or foot-soldiers' boots, which he used to wear. He also accompanied his father to Syria, and after his death returned to Rome. In 37 he was summoned by Tiberius to Capreae, and by skilful flattery managed to escape the fate of his relatives. After the murder of Tiberius by Naevius Sertorius Macro, the prefect of the praetorian guards, which was probably due to his instigation, Caligula ascended the throne amidst the rejoicings of the people. The senate conferred the imperial power upon him alone, although Tiberius Gemellus, the grandson of the preceding emperor, had been designated as his co-heir. He entered on his first consulship in July 37. For the first eight months of his reign he did not disappoint the popular expectation; but after his recovery from a severe illness his true character showed itself. His extravagance, cruelty and profligacy can hardly be explained except on the assumption that he was out of his mind. According to Pelham, much of his conduct was due to the atmosphere in which he was brought up, and the ideas of sovereignty instilled into him, which led him to pose as a monarch of the Graeco-oriental type. To fill his exhausted treasury he put to death his wealthy subjects and confiscated their property; even the poor fell victims to his thirst for blood. He bestowed the priesthood and a consulship upon his horse Incitatus, and demanded that sacrifice should be offered to himself. He openly declared that he wished the whole Roman people had only one head, that he might cut it off at a single stroke. In 39 he set out with an army to Gaul, nominally to punish the Germans for having invaded Roman territory, but in reality to get money by plunder and confiscation. Before leaving, he led his troops to the coast opposite Britain, and ordered them to pick up shells on the seashore, to be dedicated to the gods at Rome as the spoils of ocean. On his return he entered Rome with an ovation (a minor form of triumph), temples were built, statues erected in his honour, and a special priesthood instituted to attend to his worship. The people were ground down by new forms of taxation and every kind of extortion, but on the whole Rome was free from internal disturbances during his reign; some insignificant conspiracies were discovered and rendered abortive. A personal insult to Cassius Chaerea, tribune of a praetorian cohort, led to Caligula's assassination on the 24th of January 41.

See Suetonius, *Caligula*; Tacitus, *Annals*, vi. 20 ff.; Dio Cassius lix.; see also S. Baring Gould, *The Tragedy of the Caesars* (3rd ed., 1892); H. F. Pelham in *Quarterly Review* (April, 1905); H. Willrich, *Beiträge zur alten Geschichte* (1903); H. Schiller, *Geschichte der römischen Kaiserzeit*, pt. 11; J. Bury, *Student's Hist. of the Roman Empire* (1893); Merivale, *History of the Romans under the Empire*, ch. 48; H. Furneaux's *Annals of Tacitus*, ii. (introduction). Mention may also be made of the famous pamphlet by L. Quide, *Caligula. Eine Studie über römischen Casarewahninn und an anonymous supplement, Ist Caligula mit unserer Zeit vergleichbar?* (both 1894); and a reply, *Fin-de-Siècle-Geschichtsschreibung*, by G. Sommerfeldt (1895).

GALAGO, the Senegal name of the long-tailed African representatives of the lemur-like Primates, which has been adopted as their technical designation. Till recently the galagos have been included in the family *Lemuridae*; but this is restricted to the lemurs of Madagascar, and they are now classed with the lorises and pottos in the family *Nycticebidae*, of which they form the section *Galaginae*, characterized by the great elongation of the upper portion of the feet (tarsus) and the power of folding the large ears. Throughout the greater part of Africa south of the

Sahara galagos are widely distributed in the wooded districts, from Senegambia in the west to Abyssinia in the east, and as far south as Natal. They pass the day in sleep, but are very active at night, feeding on fruits, insects and small birds. When they descend to the ground they sit upright, and move about by jumping with their hind-legs like jerboas. They are pretty little animals, varying from the size of a small cat to less than that of a rat, with large eyes and ears, soft woolly fur and long tails. There are several species, of which *G. crassicaudatus* from Mozambique is the largest; together with *G. garnetti* of Natal, *G. agisymbanus* of Zanzibar, and *G. montiroi* of Angola, this represents the subgenus *Ololemur*. The typical group includes *G. senegalensis* (or *galago*) of Senegal, *G. alleni* of West and Central Africa, and *G. moholi* of South Africa; while *G. demidoffi* of West and Central Africa and *G. anomurus* of French Congo land represent the subgenus *Hemigalago*. (R. L.*)

GALANGAL, formerly written "galingle," and sometimes "garingal," *rhizoma galangae* (Arab. *Kholinjān*;¹ Ger. *Galgantwurz*); Fr. *Racine de Galanga*), a drug, now obsolete, with an aromatic taste like that of mingled ginger and pepper. Lesser galangal root, *radix galangae minoris*, the ordinary galangal of commerce, is the dried rhizome of *Alpinia officinarum*, a plant of the natural order Zingiberaceae, growing in the Chinese island of Hainan, where it is cultivated, and probably also in the woods of the southern provinces of China. The plant is closely allied to *Alpinia calcarata*, the rhizome of which is sold in the bazaars of some parts of India as a sort of galangal. Its stems attain a length of about 4 ft., and its leaves are slender, lanceolate and light-green, and have a hot taste; the flowers are white with red veins, and in simple racemes; the roots form dense masses, sometimes more than a foot in diameter; and the rhizomes grow horizontally, and are $\frac{1}{2}$ in. or less in thickness. Galangal seems to have been unknown to the ancient Greeks and Romans, and to have been first introduced into Europe by Arabian physicians. It is mentioned in the writings of Ibn Khurdābah, an Arabian geographer who flourished in the latter half of the 9th century, and "gallengar" (gallingle or galangal) is one of the ingredients in an Anglo-Saxon receipt for a "wen salve" (see O. Cockayne, *Saxon Leechdoms*, vol. iii. p. 13). In the middle ages, as at present in Livonia, Esthonia and central Russia, galangal was in esteem in Europe both as a medicine and a spice, and in China it is still employed as a therapeutic agent. Its chief consumption is in Russia, where it is used as a cattle-medicine, and as a flavouring for liqueurs.

GALAPAGOS ISLANDS, an archipelago of five larger and ten smaller islands in the Pacific Ocean, exactly under the equator. The nearest island to the South American coast lies 580 m. W. of Ecuador, to which country they belong. The name is derived from *galápagos*, a tortoise, on account of the giant species, the characteristic feature of the fauna. The islands were discovered early in the 16th century by Spaniards, who gave them their present name. They were then uninhabited. The English names of the individual islands were probably given by buccaneers, for whom the group formed a convenient retreat.

The larger members of the group, several of which attain an elevation of 2000 to 2500 ft., are Albemarle or Isabela (100 m. long, 28 m. in extreme breadth, with an area of 1650 sq. m. and an extreme elevation of 5000 ft.), Narborough or Fernandina, Indefatigable or Santa Cruz, Chatham or San Cristobal, James or San Salvador, and Charles or Santa Maria. The total land area is estimated at about 2870 sq. m. (about that of the West Riding of Yorkshire). The extraordinary number of craters, a few of which are reported still to be active, gives evidence that the archipelago is the result of volcanic action. The number of main craters may be about twenty-five, but there are very many small eruptive cones on the flanks of the old volcanoes. There is a convict settlement on Chatham with

¹ Apparently derived from the Chinese *Kau-liang-Kiang*, i.e. *Kau-liang* ginger, the term applied by the Chinese to galangal, after the prefecture Kau-chau fu in Canton province, formerly called Kau-liang (see F. Porter Smith, *Contrib. to the Materia Medica . . . of China*, p. 9, 1871).

some 300 inhabitants living in low thatched or iron-roofed huts, under the supervision of a police commissioner and other officials of Ecuador, by which country the group was annexed in 1832, when General Villamil founded Floreana on Charles Island, naming it in honour of Juan José Flores, president of Ecuador. A governor has been appointed since 1885, some importance being foreseen for the islands in connexion with the cutting of the Panama canal, as the group lies on the route to Australia opened up by that scheme. Charles Island, the most valuable of the group, is cultivated by a small colony. On many of the islets numerous tropical fruits are found growing wild, but they are no doubt escapes from cultivation, just as the large herds of wild cattle, horses, donkeys, pigs, goats and dogs—the last large and fierce—which occur abundantly on most of the islands have escaped from domestication.

The shores of the larger islands are fringed in some parts with a dense barrier of mangroves, backed by an often impenetrable thicket of tropical undergrowth, which, as the ridges are ascended, give place to taller trees and deep green bushes which are covered with orchids and trailing moss (*orchilla*), and from which creepers hang down interlacing the vegetation. But generally the low grounds are parched and rocky, presenting only a few thickets of Peruvian cactus and stunted shrubs, and a most uninviting shore. The contrast between this low zone and the upper zone of rich vegetation (above about 800 ft.) is curiously marked. From July to November the clouds hang low on the mountains, and give moisture to the upper zone, while the climate of the lower is dry. Rain in the lower zone is scanty, and from May to January does not occur. The porous soil absorbs the moisture, and fresh water is scarce. Though the islands are under the equator, the climate is not intensely hot, as it is tempered by cold currents from the Antarctic sea, which, having followed the coast of Peru as far as Cape Blanco, bear off to the N.W. towards and through the Galapagos. The mean temperature of the lower zone is about 71° F., that of the upper from 66° to 62°.

The Galapagos Islands are of some commercial importance to Ecuador, on account of the guano and the orchilla moss found on them and exported to Europe. Except on Charles Island, where settlement has existed longest, little or no influence of the presence of man is evident in the group; still, the running wild of dogs and cats, and, as regards the vegetation, especially goats, must in a comparatively short period greatly modify the biological conditions of the islands.

The origin and development of these conditions, in islands so distinctly oceanic as the Galapagos, have given its chief importance to this archipelago since it was visited by Darwin in the "Beagle." The Galapagos archipelago possesses a rare advantage from its isolated situation, and from the fact that its history has never been interfered with by any aborigines of the human race. Of the seven species of giant tortoises known to science (although at the discovery of the islands there were probably fifteen) all are indigenous, and each is confined to its own islet. There also occurs a peculiar genus of lizards with two species, the one marine, the other terrestrial. The majority of the birds are of endemic species peculiar to different islets, while more than half belong to peculiar genera. More than half of the flora is unknown elsewhere.

Since 1860 several visits have been paid to the group by scientific investigators—by Dr Habel in 1868; Messrs Baur and Adams, and the naturalists of the "Albatross," between 1888 and 1891; and in 1897-1898 by Mr Charles Harris, whose journey was specially undertaken at the instance of the Hon. Walter Rothschild. Very complete collections have therefore, as a result of these expeditions, been brought together; but their examination does not materially change the facts upon which the conclusions arrived at by Darwin, from the evidence of the birds and plants, were based; though he "no doubt would have paid more attention to [the evidence afforded by Land-tortoises], if he had been in possession of facts with which we are acquainted now" (Günther). His conclusions were that the group "has never been nearer the mainland than it is now, nor have its members been at any time closer together"; and that the character of the flora and fauna is the result of species straggling over from America, at long intervals of time, to the different islets, where in their isolation they have gradually varied in different degrees and ways from their ancestors. Equally indecisive is the further

exploration as to evidence for the opinion held by other naturalists that the endemic species of the different islands have resulted from subsidences, through volcanic action, which have reduced one large island mass into a number of islets, wherein the separated species became differentiated during their isolation. The presence of these giant reptiles on the group is the chief fact on which a former land connexion with the continent of America may be sustained. "Nearly all authorities agree that it is not probable that they have crossed the wide sea between the Galapagos Islands and the American continent, although, while they are helpless, and quite unable to swim, they can float on the water. If their ancestors had been carried out to sea once or twice by a flood and safely drifted as far as the Galapagos Islands" (Wallace), "they must have been numerous on the continent" (Rothschild and Hartert). No remains, and of course no living species, of these tortoises are known to exist or have existed on the mainland. Rothschild and Hartert think "it is more natural to assume the disappearance of a great stock of animals, the remains of which have survived, . . . than to assume the disappearance in comparatively recent times (i.e. in the Eocene period or later) of enormous land masses." Past elevations of land, however (and doubtless equally great subsidences) have taken place in South America since the Eocene, and the conclusion that extensive areas of land have subsided in the Indian Ocean has long been based on a somewhat similar distribution of giant tortoises in the Mascarene region.

AUTHORITIES.—Darwin, *Voyage of the "Beagle"*; O. Salvin, "On the Avifauna of the Galapagos Archipelago," *Trans. Zool. Soc.* part ix. (1876); Sclater and Salvin, "Characters of New Species collected by Dr Habel in the Galapagos Islands," *Proc. Zool. Soc. London*, 1870, pp. 322-327; A. R. Wallace, *Geographical Distribution of Animals* (New York, 1876); Theodor Wolf, *Ein Besuch der Galapagos Inseln* (Heidelberg, 1879); and paper in *Geographical Journal*, vi. 560 (1895); W. L. and P. L. Sclater, *The Geography of Mammals* (London, 1899); Ridgway, "Birds of the Galapagos Archipelago," *Proc. U.S. Nat. Mus.* vol. xix. pp. 459-670 (1897); Baur, "New Observations on the Origin of the Galapagos Islands," *Amer. Nat.* (1897), pp. 661-680, 864-896; A. Agassiz, "The Galapagos Islands," *Bull. Mus. Comp. Zool.* vol. xxiii. pp. 56-73; A. Günther, *Proc. Linn. Soc.* (London (President's Address), October 1898), pp. 14-29 (with bibliography from 1875 to 1898 on gigantic land-tortoises); Rothschild and Hartert, "Review of the Ornithology of the Galapagos Islands," *Novitates zoologicae*, vi. pp. 85-205; H. L. Robinson, "Flora of the Galapagos Islands," *Proc. Amer. Acad. of Arts and Sciences*, xxxviii. (1902).

GALASHIELS, a municipal and police burgh of Selkirkshire, Scotland. Pop. (1891) 17,367; (1901) 13,615. It is situated on Gala Water, within a short distance of its junction with the Tweed, 3½ m. S.E. of Edinburgh by the North British railway. The town stretches for more than 2 m. along both banks of the river, the mills and factories occupying the valley by the stream, the villas and better-class houses the high-lying ground on either side. The principal structures include the municipal buildings, corn exchange, library, public hall, and the market cross. The town is under the control of a provost, baillies and council, and, along with Hawick and Selkirk, forms the Hawick (or Border) group of parliamentary burghs. The woollen manufactures, dating from the close of the 16th century, are the most important in Scotland, though now mainly confined to the weaving of tweeds. Other leading industries are hosiery, tanning (with the largest yards in Scotland), dyeing, iron and brass founding, engineering and boot-making. Originally a village built for the accommodation of pilgrims to Melrose Abbey (4 m. E. by S.), it became, early in the 15th century, an occasional residence of the Douglasses, who were then keepers of Ettrick Forest, and whose peel-tower was not demolished till 1814. Galashiels was created into a burgh of barony in 1599. The Catraill or Picts' Work begins near the town and passes immediately to the west. Clovenfords, 3½ m. W., is noted for the Tweed vineries, which are heated by 5 m. of water-pipes, and supply the London market throughout the winter. Two miles farther W. by S. is Ashiestiel, where Sir Walter Scott resided from 1804 to 1812, where he wrote his most famous poems and began *Waverley*, and which he left for Abbotsford.

GALATIA. I. In the strict sense (Galatia Proper, Roman *Gallogaetia*) this is the name applied by Greek-speaking peoples to a large inland district of Asia Minor since its occupation by Gaulish tribes in the 3rd century B.C. Bounded on the N. by Bithynia and Paphlagonia, W. by Phrygia, S. by Lycaonia and Cappadocia, E. by Pontus, it included the greater part of the modern vilayet of Angora, stretching from Pessinus eastwards to

Tavium and from the Paphlagonian hills N. of Ancyra southwards to the N. end of the salt lake Tatta (but probably including the plains W. of the lake during the greater part of its history),—a rough oblong about 200 m. long and 100 (to 130) broad.

Galatia is part of the great central plateau of Asia Minor, here ranging from 2000 to 3000 ft. above sea-level, and falls geographically into two parts separated by the Halys (Kizil Irmak),—a small eastern district lying chiefly in the basin of the Delije Irmak, the principal affluent of the Halys, and a large western region drained almost entirely by the Sangarius (Sakaria) and its tributaries. On the N. side Galatia consists of a series of plains with fairly fertile soil, lying between bare hills. But the greater part is a dreary stretch of barren, undulating uplands, intersected by tiny streams and passing gradually into the vast level waste of treeless (anc. *Azylos*) plain that runs S. to Lycaonia; these uplands are little cultivated and only afford extensive pasturage for large flocks of sheep and goats. Cities are few and far apart, and the climate is one of extremes of heat and cold. The general condition and aspect of the country was much the same in ancient as in modern times.

The Gaulish invaders appeared in Asia Minor in 278-277 B.C. They numbered 20,000, of which only one-half were fighting men, the rest being doubtless women and children; and not long after their arrival we find them divided into three tribes, Trocmi, Tolistobogii and Tectosages, each of which claimed a separate sphere of operations. They had split off from the army which invaded Greece under Brennus in 279 B.C., and, marching into Thrace under Leonnorius and Lutarius, crossed over to Asia at the invitation of Nicomedes I. of Bithynia, who required help in his struggle against his brother. For about 46 years they were the scourge of the western half of Asia Minor, ravaging the country, as allies of one or other of the warring princes, without any serious check, until Attalus I., king of Pergamum (241-197), inflicted several severe defeats upon them, and about 232 B.C. forced them to settle permanently in the region to which they gave their name. Probably they already occupied parts of Galatia, but definite limits were now fixed and their right to the district was formally recognized. The tribes were settled where they afterwards remained, the Tectosages round Ancyra, the Tolistobogii round Pessinus, and the Trocmi round Tavium. The constitution of the Galatian state is described by Strabo: conformably to Gaulish custom, each tribe was divided into four cantons (Gr. *τετραρχία*), each governed by a chief ("tetrarch") of its own with a judge under him, whose powers were unlimited except in cases of murder, which were tried before a council of 300 drawn from the twelve cantons and meeting at a holy place called Drynemeton. But the power of the Gauls was not yet broken. They proved a formidable foe to the Romans in their wars with Antiochus, and after Attalus' death their raids into W. Asia Minor forced Rome in 189 B.C. to send an expedition against them under Cn. Manlius Vulso, who taught them a severe lesson. Henceforward their military power declined and they fell at times under Pontic ascendancy, from which they were finally freed by the Mithradatic wars, in which they heartily supported Rome. In the settlement of 64 B.C. Galatia became a client-state of the empire, the old constitution disappeared, and three chiefs (wrongly styled "tetrarchs") were appointed, one for each tribe. But this arrangement soon gave way before the ambition of one of these tetrarchs, Deiotarus, the contemporary of Cicero and Caesar, who made himself master of the other two tetrarchies and was finally recognized by the Romans as king of Galatia. On the death of the third king Amyntas in 25 B.C., Galatia was incorporated by Augustus in the Roman empire, and few of the provinces were more enthusiastically loyal.

The population of Galatia was not entirely Gallic. Before the arrival of the Gauls, western Galatia up to the Halys was inhabited by Phrygians, and eastern Galatia by Cappadocians and other native races. This native population remained, and constituted the majority of the inhabitants of the rural parts and almost the sole inhabitants of the towns. They were left in possession of two-thirds of the land (cf. Caesar, *B.G.* i. 31) on condition of paying part of the produce to their new lords, who

took the other third, and agriculture and commerce with all the arts and crafts of peaceful life remained entirely in their hands. They were henceforth ranked as "Galatians" by the outside world equally with their overlords, and it was from their numbers that the "Galatian" slaves who figure in the markets of the ancient world were drawn. The conquerors, who were few in number, formed a small military aristocracy, living not in the towns, but in fortified villages, where the chiefs in their castles kept up a barbaric state, surrounded by their tribesmen. With the decline of their warlike vigour they began gradually to mix with the natives and to adopt at least their religion: the amalgamation was accelerated under Roman influence and ultimately became as complete as that of the Normans with the Saxons in England, but they gave to the mixed race a distinctive tone and spirit, and long retained their national characteristics and social customs, as well as their language (which continued in use, side by side with Greek, in the 4th century after Christ). In the 1st century, when St Paul made his missionary journeys, even the towns Ancyra, Pessinus and Tavium (where Gauls were few) were not Hellenized, though Greek, the language of government and trade, was spoken there; while the rural population was unaffected by Greek civilization. Hellenic ways and modes of thought begin to appear in the towns only in the later 2nd century. In the rustic parts a knowledge of Greek begins to spread in the 3rd century; but only in the 4th and 5th centuries, after the transference of the centre of government first to Nicomedia and then to Constantinople placed Galatia on the highway of imperial communication, was Hellenism in its Christian form gradually diffused over the country. (See also ANCYRA; PESSINUS; GORDIUM.)

II. The Roman province of Galatia, constituted 25 B.C., included the greater part of the country ruled by Amyntas, viz. Galatia Proper, part of Phrygia towards Pisidia (Apollonia, Antioch and Iconium), Pisidia, part of Lycaonia (including Lystra and Derbe) and Isauria. For nearly 100 years it was the frontier province, and the changes in its boundaries are an epitome of the stages of Roman advance to the Euphrates, one client-state after another being annexed: Paphlagonia in 6-5 B.C.; Sebastopolis, 3-2 B.C.; Amasia, A.D. 1-2; Comana, A.D. 34-35,—together forming Pontus Galaticus,—the Pontic kingdom of Polemon, A.D. 64, under the name Pontus Polemoniaca. In A.D. 70 Cappadocia (a procuratorial province since A.D. 17) with Armenia Minor became the centre of the forward movement and Galatia lost its importance, being merged with Cappadocia in a vast double governorship until A.D. 114 (probably), when Trajan separated the two parts, making Galatia an inferior province of diminished size, while Cappadocia with Armenia Minor and Pontus became a great consular military province, charged with the defence of the frontier. Under Diocletian's reorganization Galatia was divided, about 295, into two parts and the name retained for the northern (now nearly identical with the Galatia of Deiotarus); and about 390 this province, amplified by the addition of a few towns in the west, was divided into Galatia Prima and Secunda or Salutaris, the division indicating the renewed importance of Galatia in the Byzantine empire. After suffering from Persian and Arabic raids, Galatia was conquered by the Seljuk Turks in the 11th century and passed to the Ottoman Turks in the middle of the 14th.

The question whether the "Churches of Galatia," to which St Paul addressed his Epistle, were situated in the northern or southern part of the province has been much discussed, and in England Prof. Sir W. M. Ramsay has been the principal advocate of the adoption of the South-Galatian theory, which maintains that they were the churches planted in Derbe, Lystra, Iconium and Antioch (see GALATIANS). In the present writer's opinion this is supported by the study of the historical and geographical facts.¹

AUTHORITIES.—Van Gelder, *De Gallis in Graecia et Asia* (1888); Staehelin, *Gesch. d. Kleinasiat. Galater* (1897); Perrot, *De Galatia*

prov. Rom. (1867); Sir W. M. Ramsay, *Histor. Geogr.* (1890), *St Paul* (1898), and *Intro. to Histor. Commentary on Galatians* (1899). For antiquities generally, Perrot, *Explor. archéol. de la Galatie* (1862); K. Humann and O. Puchstein, *Reisen in Kleinasien* (1890); Koerte, *Athen. Mitteilungen* (1897); Anderson and Crowfoot, *Journ. of Hellenic Studies* (1899); and Anderson, *Map of Asia Minor* (London, Murray, 1903). (J. G. C. A.)

GALATIANS, EPISTLE TO THE, one of the books of the New Testament. This early Christian scripture is one of the books militant in the world's literature. Its usefulness to Luther in his propaganda was no accident in its history; it originated in a controversy, and the varying views of the momentous struggle depicted in Gal. ii. and Acts xv. have naturally determined, from time to time, the conception of the epistle's aim and date. Details of the long critical discussion of this problem cannot be given here. (See PAUL.) It must suffice to say that to the present writer the identification of Gal. ii. 1-10 with Acts xi. 28 f. and not with Acts xv. appears quite untenable, while a fair exegesis of Acts xvi. 1-6 implies a distinction between such towns as Lystra, Derbe and Iconium on the one hand and the Galatian *χώρα* with Phrygia upon the other.² A further visit to the latter country is mentioned, upon this view, in Acts xviii. 23. The Christians to whom the epistle was addressed were thus inhabitants, for the most part (iv. 8) of pagan birth, belonging to the northern section of the province, perhaps mainly in its south-western district adjoining Bithynia and the province of Asia. The scanty allusions to this mission in Acts cannot be taken as any objection to the theory. Nor is there any valid geographical difficulty. The country was quite accessible from Antioch. Least of all does the historical evidence at our disposal justify the inference that the civilization of north Galatia, during the 1st century A.D., was Romano-Gallic rather than Hellenic; for, as the coins and inscriptions indicate, the Anatolian culture which predominated throughout the province did not exclude the infusion either of Greek religious conceptions or of the Greek language. The degree of elementary Greek culture needful for the understanding of Galatians cannot be shown to have been foreign to the inhabitants of north Galatia. So far as any trustworthy evidence is available, such Hellenic notions as are presupposed in this epistle might well have been intelligible to the Galatians of the northern provinces. Still less does the acquaintance with Roman jurisprudence in iii. 15-iv. 2 imply, as Halmel contends (*Über rom. Recht im Galaterbrief*, 1895), not merely that Paul must have acquired such knowledge in Italy but that he wrote the epistle there. A popular acquaintance with the outstanding features of Roman law was widely diffused by this time in Asia Minor.

The epistle can hardly have been written therefore until after the period described in Acts xviii. 22, but the *terminus ad quem* is more difficult to fix.³ The composition may be placed (cf. the present writer's *Historical New Testament*, pp. 124 f. for details) either during the earlier part of Paul's residence at Ephesus (Acts xix. 1, 10, so most editors and scholars), or on his way from Ephesus to Corinth, or at Corinth itself (so Lightfoot, Bleek, Salmon).

The epistle was not written until Paul had visited Thessalonica,

¹ The historical and geographical facts concerning Galatia, which lead other writers to support the south Galatian theory, are stated in the preceding article on Galatia; and the question is still a matter of controversy, the division of opinion being to some extent dependent on whether it is approached from the point of view of the archaeologist or the Biblical critic. The ablest re-statements of the north Galatian theory, in the light of recent pleas for south Galatia as the destination of this epistle, may be found by the English reader in P. W. Schmiedel's exhaustive article in *Encycl. Biblica* (1892-1916) and Prof. C. H. Gilbert's *Student's Life of Paul* (1902), pp. 260-272. Schmiedel's arguments are mainly directed against Sir W. M. Ramsay, but a recent Roman Catholic scholar, Dr A. Steinmann, takes a wider survey in a pamphlet on the north Galatian side of the controversy (*Die Abfassungszeit des Galaterbriefes*, Münster, i. W., 1906), carrying forward the points already urged by Sieffert and Zöckler amongst others, and especially refuting his fellow-churchman, Prof. Valentine Weber.

² The tendency among adherents of the south Galatian theory is to put the epistle as early as possible, making it contemporaneous with, if not prior to, 1 Thessalonians. So Douglass Round in *The Date of St Paul's Epistle to the Galatians* (1906).

³ In the unsettled state of this controversy, weight naturally attaches to the opinion of experts on either side; and the above statement, while opposed to the view taken in the following article on the epistle, must be taken on its merits.—Ed. E.B.

but the Galatian churches owed their origin to a mission of Paul undertaken some time before he crossed from Asia to Europe. When he composed this letter, he had visited the churches twice. On the former of these visits (iv. 13 τὸ πρότερον), though broken down by illness (2 Cor. xii. 7-9) he had been enthusiastically welcomed, and the immediate result of his mission was an outburst of religious fervour (iii. 1-5, iv. 14 f.). The local Christians made a most promising start (v. 7). But they failed to maintain their ardour. On his second visit (iv. 13, i. 7, v. 21) the apostle found in many of them a disheartening slackness, due to discord and incipient legalism. His plain-speaking gave offence in some quarters (iv. 16), though it was not wholly ineffective. Otherwise, this second visit is left in the shadow.¹ So far as it was accompanied by warnings, these were evidently general rather than elicited by any definite and imminent peril to the churches. Not long afterwards, however, some Judaizing opponents of the apostle (note the contemptuous anonymity of the *ῥῆς* in i. 7, as in Col. ii. 4 f.), headed by one prominent and influential individual (v. 10), made their appearance among the Galatians, promulgating a "gospel" which meant fidelity to, not freedom from, the Law (i. 6-10). Arguing from the Old Testament, they represented Paul's gospel as an imperfect creed which required to be supplemented by legal exactitude,² including ritual observance (iv. 10) and even circumcision,³ while at the same time they sought to undermine his authority⁴ by pointing out that it was derived from the apostles at Jerusalem and therefore that his teaching must be open to the checks and tests of that orthodox primitive standard which they themselves claimed to embody. The sole valid charter to Messianic privileges was observance of the Mosaic law, which remained obligatory upon pagan converts (iii. 6-9, 16).

When the news of this relapse reached Paul, matters had evidently not yet gone too far. Only a few had been circumcised. It was not too late to arrest the Galatians on their downward plane, and the apostle, unable or unwilling to re-visit them, despatched this epistle. How or when the information came to him, we do not know. But the gravity of the situation renders it unlikely that he would delay for any length of time in writing to counteract the intrigues of his opponents; to judge from allusions like those in i. 6 (*ῥαξίως* and *μεταπίθεο*—the lapse still in progress), we may conclude that the interval between the reception of the news and the composition of the letter must have been comparatively brief.

After a short introduction⁵ (i. 1-5), instead of giving his usual word of commendation, he plunges into a personal and historical vindication⁶ of his apostolic independence, which, developed negatively and positively, forms the first of the three main

¹ It is not quite clear whether traces of the Judaistic agitation were already found by Paul on this visit (so especially Holsten, Lipsius, Siefert, Pfeiderer, Weiss and Weizsäcker) or whether they are to be dated subsequent to his departure (so Philippi, Renan and Hofmann, among others). The tone of surprise which marks the opening of the epistle tells in favour of the latter theory. Paul seems to have been taken aback by the news of the Galatians' defection.

² Apparently they were clever enough to keep the Galatians in ignorance that the entire law would require to be obeyed (v. 3).

³ The critical dubiety about *οὐκ* in ii. 5 (cf. Zahn's excursus and Prof. Lake in *Expositor*, March 1906, p. 236 f.), throws a slight doubt on the interpretation of ii. 3, but it is clear that the agitators had quoted Paul's practice as an authoritative sanction of the rite.

⁴ This depreciation is voiced in their catch-word of *δοκίμους* ("those of repute," ii. 6), while other echoes of their talk can be overheard in such phrases as "we are Abraham's seed" (iii. 16), "sinners of Gentiles" (ii. 15) and "Jerusalem which is our mother" (iv. 26), as well as in their charges against Paul of "seeking to please men" (i. 10) and "preaching circumcision" (v. 11).

⁵ Not only is the address "to the churches of Galatia" unusually bare, but Paul associates no one with himself, either because he was on a journey or because, as the attacked party, he desired to concentrate attention upon his personal commission. Yet the *ἡμεῖς* of i. 8 indicates colleagues like Silas and Timothy.

⁶ Cf. Hausrath's *History of the N.T. Times* (iii. pp. 181-190), with the fine remarks, on v. 17, that "Paul stands before us like an ancient general who bares his breast before his mutinous legions, and shows them the scars of the wounds that proclaim him not unworthy to be called Imperator."

sections in the epistle (i. 6-ii. 21). In the closing passage he drifts over from an account of this interview with Peter into a sort of monologue upon the incompatibility of the Mosaic law with the Christian gospel (ii. 15-21),⁷ and this starts him afresh upon a trenchant expostulation and appeal (iii. 1-v. 12) regarding the alternatives of law and spirit. Faith dominates this section; faith in its historical career and as the vantage-ground of Christianity. The much-vaunted law is shown to be merely a provisional episode⁸ culminating in the gospel (iii. 7-28) as a message of filial confidence and freedom (iii. 29-iv. 11). The genuine "sons of Abraham" are not legalistic Jewish Christians but those who simply possess faith in Jesus Christ. A passionate outburst then follows (iv. 12 f.); and, harping still on Abraham, the apostle essays, with fresh rabbinic dialectic, to establish Christianity over legalism as the free and final religion for men, applying this to the moral situation of the Galatians themselves (v. 1-12). This conception of freedom then leads him to define the moral responsibilities of the faith (v. 13-vi. 10), in order to prevent misconception and to enforce the claims of the gospel upon the individual and social life of the Galatians. The epilogue (vi. 11-21) reiterates, in a handful of abrupt, emphatic sentences, the main points of the epistle.

The allusion in vi. 11 (*ὅστε πηλικὸς ὑμῶν γράμμασαν ἔγραψα τῇ ἐμῇ χειρὶ*) is to the large bold size⁹ of the letters in Paul's handwriting, but the object and scope of the reference are matters of dispute. It is "a sensational heading" (Findlay), but it may either refer¹⁰ to the whole epistle (so Augustine, Chrysostom, &c., followed by Zahn) or, as most hold (with Jerome) to the postscript (vi. 11-18). Paul commonly dictated his letters. His use of the autograph here may have been to prevent any suspicion of a forgery or to mark the personal emphasis of his message. In any case it is assumed that the Galatians knew his handwriting. It is unlikely that he inserted this postscript from a feeling of ironical playfulness, to make the Galatians realize that, after the sternness of the early chapters, he was now treating them like children, "playfully hinting that surely the large letters will touch their hearts" (so Deissmann; *Bible-Studies* (1901), 346 f.).

The earliest allusion to the epistle¹¹ is the notice of its inclusion in Marcion's canon, but almost verbal echoes of iii. 10-13 are to be heard in Justin Martyr's *Dial.* xciv.-xcv.; it was certainly known to Polycarp, and as the 2nd century advances the evidence of its popularity multiplies on all sides, from Ptolemaeus and the Ophites to Irenaeus and the Muratorian canon (cf. Gregory's *Canon and Text of N.T.*, 1907, pp. 201-203). It is no longer necessary for serious criticism to refute the objections to its authenticity raised during the 19th century in certain quarters;¹² as Macaulay said of the authenticity of Caesar's commentaries, "to doubt on that subject is the mere rage of scepticism."

⁷ Cf. T. H. Green's *Works*, iii. 186 f. Verses 15-17 are the indirect abstract of the speech's argument, but in verses 18-21 the apostle, carried away by the thought and barrier of the moment as he dictates to his amanuensis, forgets the original situation.

⁸ Thus Paul reverses the ordinary rabbinic doctrine which taught (cf. Kiddushim, 30, b) that the law was given as the divine remedy for the evil *yezer* of man. So far from being a remedy, he argues, it is an aggravation.

⁹ According to Plutarch, Cato the elder wrote histories for the use of his son, *ὅτι χειρὶ καὶ μεγάλους γράμμασαν* (cf. Field's *Notes on Translation of the New Testament*, p. 191). If the point of Gal. vi. 11 lies in the size of the letters, Paul cannot have contemplated copies of the epistle being made. He must have assumed that the autograph would reach all the local churches (cf. 2 Thes. iii. 17, with E. A. Abbott, *Johannine Grammar*, pp. 530-532).

¹⁰ For *ἔγραψα*, the epistolary aorist, at the close of a letter, cf. Xen. *Anab.* i. 9. 25, Thuc. i. 129. 3, Ezra iv. 14 (LXX) and Lucian, *Dial. Meretr.* x.

¹¹ Hermann Schulze's attempt to bring out the filiation of the later N.T. literature to Galatians (*Die Ursprünglichkeit des Galaterbriefes*, Leipzig, 1903) involves repeated exaggerations of the literary evidence.

¹² Cf. especially J. Gloc's *Die jüngste Kritik des Galaterbriefes* (Leipzig, 1890) and Baljon's reply to Steck and Loman (*Exegetische verhandlung über den Brief von P. an die Gal.*, 1889). The English reader may consult Schmiedel's article (already referred to) and Dr R. J. Knowling's *The Testimony of St Paul to Christ* (1905), 28 f.

Even the problems of its integrity are quite secondary. Marcion (cf. Tert. *Adv. Marc.* 2-4) removed what he judged to be some interpolations, but van Manen's attempt to prove that Marcion's text is more original than the canonical (*Theolog. Tijdschrift*, 1887, 400 f. 451 f.) has won no support (cf. C. Clemens's refutation in *Die Eintheiligkeit der paulin. Briefe*, 1894, pp. 100 f. and Zahn's *Geschichte d. N. T. lichen Kanons*, ii. 409 f.), and little or no weight attaches to the attempts made (e.g. by J. A. Cramer) to disentangle a Pauline nucleus from later accretions. Even D. Völter, who applies this method to the other Pauline epistles, admits that Galatians, whether authentic or not, is substantially a literary unity (*Paulus und seine Briefe*, 1905, pp. 229-285). The frequent roughnesses of the traditional text suggest, however, that here and there marginal glosses may have crept in. Thus iv. 25a (ῥὸ γὰρ Σὺν ἄποσ ἐστὶν ἐν τῇ Ἀραβίᾳ) probably represents the explanatory and prosaic gloss of a later editor, as many scholars have seen from Bentley (*Opuscula philologica*, 1781, pp. 533 f.) to H. A. Schott, J. A. Cramer, J. M. S. Baljon and C. Holsten. The general style of the epistle is vigorous and unpremeditated, "one continuous rush, a veritable torrent of genuine and inimitable Paulinism, like a mountain stream in full flood, such as may often have been seen by his Galatians" (J. Macgregor). But there is a certain rhythmical balance, especially in the first chapter (cf. J. Weiss, *Beiträge zur paulin. Rhetorik*, 1897, 8 f.); here as elsewhere the rush and flow of feeling carry with them some care for rhetorical form, in the shape of antitheses, such as a pupil of the schools might more or less unconsciously retain.¹ All through, the letter shows the breaks and pauses of a mind in direct contact with some personal crisis. Hurried, unconnected sentences, rather than sustained argument, are its most characteristic features.² The trenchant redundances and fiery outbursts make it indeed "read like a dihyramb from beginning to end."

BIBLIOGRAPHY.—Of more modern editions in English, the most competent are those of C. J. Ellicott (4th ed., 1867, strong in linguistic and grammatical material), Prof. Eadie (Edinburgh, 1869), J. B. Lightfoot (11th ed., 1892), Dean Alford (3rd ed., 1862) and F. Rendall (*Expositor's Greek Testament*, 1903) on the Greek text; Dr Sanday (in Ellicott's *Commentary*, 1879), Dr Jas. Macgregor (Edinburgh, 1879), B. Jowett (3rd ed., 1894), Huxtable (*Pulpit Comment.*, 1885), Dr Agar Beet (London, 1885, &c.), Dr W. F. Adeney (*Century Bible*), Dr E. H. Perowne (*Cambridge Bible*, 1890) and Dr James Drummond (*Internat. Handbooks to N. T.*, 1899) also comment on the English text. The editions of Lightfoot and Jowett are especially valuable for their subsidiary essays, and Sir W. M. Ramsay's *Historical Commentary on Galatians* (1899) contains archaeological and historical material which is often illuminating. The French editions are few and minor, those by A. Sardinoux (Valence, 1837) and E. Reuss (1878) being adequate, however. In Germany the two most up-to-date editions are by F. Sieffert (in Meyer's *Comment.*, 1899) and Th. Zahn (2nd ed., 1907); these supersede most of the earlier works, but H. A. Schott (1834), A. Wieseler (Göttingen, 1859), G. B. Winer (4th ed., 1859), J. C. K. von Hofmann (2nd ed., 1872), Philippi (1884), R. A. Lipsius (2nd ed., *Hand-Commentar.*, 1892), and Zöckler (2nd ed., 1894) may still be consulted with advantage, while Hilgenfeld's commentary (1852) discusses acutely the historical problems of the epistle from the standpoint of Baur's criticism. The works of A. Schlatter (2nd ed., 1894) and W. Bousset (in *Die Schriften des N. T.*, 2nd ed., 1907) are more popular in character. F. Windischmann (Mayence, 1843), F. X. Reithmayr (1865), A. Schäfer (Münster, 1890) and F. Cornely (1892, also in *Cursus scripturarum sacrae*, 1907) are the most satisfactory modern editors, from the Roman Catholic church, but it should not be forgotten that the 16th century produced the *Literalis expositio* of Cajetan (Rome, 1529) and the similar work of Pierre Barahona (Salamanca, 1599), no less than the epoch-making edition of Luther (Latin, 1519, &c.; German, 1525 f.; English, 1575 f.). After Calvin and Grotius, H. E. G. Paulus (*Des Apostol. P. Lehrbriefe an die Gal. u. Römer Christen*, 1831) was perhaps the most independent interpreter. For the patristic editions, see the introductory sections in Zahn and Lightfoot. The religious thought of the epistle

¹ Compare the minute analysis of the whole epistle in F. Blass, *Die Rhythmen der asanischen und römischen Kunstprosa* (1905), pp. 43-53, 204-216, where, however, this feature is exaggerated into unreality. The comic trimeter in Philipp. iii. 1 (ἀπο μὲν οὐκ ἀναπόρ, αὐτὸ δ' ἀσφαλες) may well be, like that in 1 Cor. xv. 33, a reminiscence of Menander.

² This affects even the vocabulary which has also "einen gewissen vulgären Zug" (Nägeli, *Der Wortschatz des Apostels Paulus*, 1905, pp. 78-79).

is admirably expounded from different standpoints by C. Holsten (*Das Evangelium Paulus*, Teil I., ii., 1880), A. B. Bruce (*St Paul's Conception of Christianity*, 1894, pp. 49-70) and Prof. G. G. Findlay (*Expositor's Bible*). On the historical aspects, Zimmer (*Galat. und Apostelgeschichte*, 1882) and M. Thomas (*Mélanges d'histoire et de litt. religieuse*, Paris, 1899, pp. 1-195) are excellent; E. H. Askwith's essay (*Epistle to the Galatians, its Destination and Date*, 1899) advocates ingeniously the south Galatian theory, and W. S. Wood (*Studies in St Paul's Epistle to the Galatians*, 1887) criticizes Lightfoot. General studies of the epistle will be found in all biographies of Paul and histories of the apostolic age, as well as in works like Sabatier's *The Apostle Paul* (pp. 187 f.), B. W. Bacon's *Story of St Paul* (pp. 116 f.), Dr R. D. Shaw's *The Pauline Epistles* (2nd ed., pp. 60 f.), R. Mariano, *Il Cristianesimo nei primi secoli* (1902), i. pp. 111 f., and Volkmar's *Paulus vom Damaskus bis zum Galaterbrief* (1887), to which may be added a series of papers by Haupt in *Deutsche Evang.-Blätter* (1904), 1-16, 89-108, 161-183, 238-259, and an earlier set by Hilgenfeld in the *Zeitschrift für wiss. Theologie* ("Zur Vorgeschichte des Gal.") 1860, pp. 206 f., 1866, pp. 301 f., 1884, pp. 393 f.). Other monographs and essays have been noted in the course of this article. See further under PAUL. (J. Mt.)

GALATINA, a town of Apulia, Italy, in the province of Lecce, from which it is 14 m. S. by rail, 233 ft. above sea-level. Pop. (1901) 12,917 (town); 14,086 (commune). It is chiefly remarkable for the fine Gothic church of St Caterina, built in 1390 by Raimondello del Balzo Orsini, count of Soleto, with a fine portal and rose-window. The interior contains frescoes by Francesco d'Arezzo (1435). The apse contains the fine mausoleum of the son of the founder (d. 1454), a canopy supported by four columns, with his statue beneath it.

GALATZ (*Galați*), a city of Rumania, capital of the department of Covurlui; on the left bank of the river Danube, 90 m. W. by N. of its mouth at Sulina. Pop. (1900) 62,678, including 12,000 Jews. The Danube is joined by the Sereth 3 m. S.W. of Galatz, and by the Pruth 10 m. E. Galatz is built on a slight eminence among the marshes which line the intervening shore and form, beside the western bank of the Pruth, the shallow mere called Lake Bratych (*Brateșul*), more than 50 sq. m. in extent. With the disappearance, towards the close of the 19th century, of most of its older quarters in which the crooked, ill-paved streets and insanitary houses were liable to be flooded every year, the city improved rapidly. Embankments and fine quays were constructed along the Danube; electric tramways were opened in the main streets, which were lighted by gas or electricity, and pure water was supplied. The higher, or north-western part of the city, which is the more open and comfortable, contains many of the chief buildings. These include the prefecture, consulate, prison, barracks, civil and military hospitals and the offices of the international commission for the control of the Danube (*q.v.*). The bishop of the lower Danube resides at Galatz. There are many Orthodox Greek, Roman Catholic and other churches; the most interesting being the cathedral, and St Mary's church, in which is the tomb of the famous Cossack chief, Mazeppa (1644-1709), said to have been rifled of its contents by the Russians. Galatz is a naval station, and the headquarters of the III. army corps, protected by a line of fortifications which extends for 45 m. E. to Focșani and is known as the Sereth line. But the main importance of the city is commercial. Galatz is the chief Moldavian port of entry, approached by three waterways, the Danube, Sereth and Pruth, down which there is a continual volume of traffic, except in mid-winter; and by the railways which intersect all the richest portions of the country. Textiles, machinery, and coal make up the bulk of imports. Besides a large trade in petroleum and salt, Galatz ranks first among Rumanian cities in its export of timber, and second to Braila in its export of grain. It possesses many saw-mills, paste-mills, flour-mills, roperies, chemical works and petroleum refineries; manufacturing also metal ware, wire, nails, soap and candles. Vessels of 2500 tons can discharge at the quays, but cargoes consigned to Galatz are often transhipped into lighters at Sulina. The shipping trade is largely in foreign hands, the principal owners being British.

GALAXY, properly the MILKY WAY, from the Greek name ὁ γαλαξίας, sc. κῆδος, from γάλα, milk, cf. the Lat. *via lactea* (see STAR). The word is more generally employed in its figurative or

transferred sense, to describe a gathering of brilliant or distinguished persons or objects.

GALBA, SERVIUS SULPICIUS, Roman general and orator. He served under Lucius Aemilius Paulus in the third Macedonian War. As praetor in 151 B.C. in farther Spain he made himself infamous by the treacherous murder of a number of Lusitanians, with their wives and children, after inducing them to surrender by the promise of grants of land. For this in 149 he was brought to trial, but secured an acquittal by bribery and by holding up his little children before the people to gain their sympathy. He was consul in 144, and must have been alive in 138. He was an eloquent speaker, noted for his violent gesticulations, and, in Cicero's opinion, was the first of the Roman orators. His speeches, however, were almost forgotten in Cicero's time.

Livy xiv. 35; Appian, *Hisp.* 58-60; Cicero, *De orat.* i. 53, iii. 7; Brutus 21.

GALBA, SERVIUS SULPICIUS, Roman emperor (June A.D. 68 to January 69), born near Terracina, on the 24th of December 5 B.C. He came of a noble family and was a man of great wealth, but unconnected either by birth or by adoption with the first six Caesars. In his early years he was regarded as a youth of remarkable abilities, and it is said that both Augustus and Tiberius prophesied his future eminence (Tacitus, *Annals*, vi. 20; Suetonius, *Galba*, 4). Praetor in 20, and consul in 33, he acquired a well-merited reputation in the provinces of Gaul, Germany, Africa and Spain by his military capability, strictness and impartiality. On the death of Caligula, he refused the invitation of his friends to make a bid for empire, and loyally served Claudius. For the first half of Nero's reign he lived in retirement, till, in 61, the emperor bestowed on him the province of Hispania Tarraconensis. In the spring of 68 Galba was informed of Nero's intention to put him to death, and of the insurrection of Julius Vindex in Gaul. He was at first inclined to follow the example of Vindex, but the defeat and suicide of the latter retarded his hesitation. The news that Nymphidius Sabinus, the praefect of the praetorians, had declared in his favour revived Galba's spirits. Hitherto, he had only dared to call himself the legate of the senate and Roman people; after the murder of Nero, he assumed the title of Caesar, and marched straight for Rome. At first he was welcomed by the senate and the party of order, but he was never popular with the soldiers or the people. He incurred the hatred of the praetorians by scornfully refusing to pay them the reward promised in his name, and disgusted the mob by his meanness and dislike of pomp and display. His advanced age had destroyed his energy, and he was entirely in the hands of favourites. An outbreak amongst the legions of Germany, who demanded that the senate should choose another emperor, first made him aware of his own unpopularity and the general discontent. In order to check the rising storm, he adopted as his coadjutor and successor L. Calpurnius Piso Frugi Licinianus, a man in every way worthy of the honour. His choice was wise and patriotic; but the populace regarded it as a sign of fear, and the praetorians were indignant, because the usual donative was not forthcoming. M. Salvius Otho, formerly governor of Lusitania, and one of Galba's earliest supporters, disappointed at not being chosen instead of Piso, entered into communication with the discontented praetorians, and was adopted by them as their emperor. Galba, who at once set out to meet the rebels—he was so feeble that he had to be carried in a litter—was met by a troop of cavalry and butchered near the Lacus Curtius. During the later period of his provincial administration he was indolent and apathetic, but this was due either to a desire not to attract the notice of Nero or to the growing infirmities of age. Tacitus rightly says that all would have pronounced him worthy of empire if he had never been emperor ("omnium consensu capax imperii nisi imperasset").

See his life by Plutarch and Suetonius; Tacitus, *Historiae*, i. 7-49; Dio Cassius lxi. 23-lxiv. 6; B. W. Henderson, *Civil War and Rebellion in the Roman Empire*, A.D. 69-70 (1908); W. A. Spooner, *On the Characters of Galba, Otho and Vitellius* in *Introd.* to his edition (1891) of the *Historiae* of Tacitus.

GALBANUM (Heb. *Helbēhā*; Gr. χαλβάνη), a gum-resin, the product of *Ferula galbanifera*, indigenous to Persia, and perhaps

also of other umbelliferous plants. It occurs usually in hard or soft, irregular, more or less translucent and shining lumps, or occasionally in separate tears, of a light-brown, yellowish or greenish-yellow colour, and has a disagreeable, bitter taste, a peculiar, somewhat musky odour, and a specific gravity of 1.212. It contains about 8% of terpene; about 65% of a resin which contains sulphur; about 20% of gum; and a very small quantity of the colourless crystalline substance *umbelliferone*, C₈H₆O₃. Galbanum is one of the oldest of drugs. In Exodus xxx. 34 it is mentioned as a sweet spice, to be used in the making of a perfume for the tabernacle. Hippocrates employed it in medicine, and Pliny (*Nat. Hist.* xxiv. 13) ascribes to it extraordinary curative powers, concluding his account of it with the assertion that "the very touch of it mixed with oil of spondylium is sufficient to kill a serpent." The drug is occasionally given in modern medicine, in doses of from five to fifteen grains. It has the actions common to substances containing a resin and a volatile oil. Its use in medicine is, however, obsolescent.

GALCHAS, the name given to the highland tribes of Ferghana, Kohistan and Wakhan. These Aryans of the Pamir and Hindu Kush, kinsmen of the Tajiks, are identified with the *Calcienses populi* of the lay Jesuit Benedict Goes, who crossed the Pamir in 1603 and described them as "of light hair and beard like the Belgians." The word "Galcha," which has been explained as meaning "the hungry raven who has withdrawn to the mountains," in allusion to the retreat of this branch of the Tajik family to the mountains to escape the Tatar hordes, is probably simply the Persian *galcha*, "clown" or "rustic," in reference to their uncouth manners. The Galchas conform physically to what has been called the "Alpine or Celtic European race," so much so that French anthropologists have termed them "those belated Savoyards of Kohistan." D'Ujfalvy describes them as tall, brown or bronzed and even white, with ruddy cheeks, black, chestnut, sometimes red hair, brown, blue or grey eyes, never oblique, well-shaped, slightly curved nose, thin lips, oval face and round head. Thus it seems reasonable to hold that the Galchas represent the most eastern extension of the Alpine race through Armenia and the Bakhtiari uplands into central Asia. The Galchas for the most part profess Sunnite Mahomedanism.

See Robert Shaw, "On the Galchah Languages," in *Journ. As. Soc. Bengal*, xlv. (1876), and xlv. (1877); Major J. Biddulph, *Tribes of the Hindoo-Koosh* (Calcutta, 1880); Hon. Mountstuart Elphinstone, *An Account of the Kingdom of Cashal* (1815); *Bull. de la société d'anthropologie de Paris* (1887); Charles Eugene D'Ujfalvy de Mezoec-Koovesd, *Les Aryens* (1896), and in *Revue d'anthropologie* (1879), and *Bull. de la soc. de géogr.* (June 1878); W. Z. Ripley, *Races of Europe* (New York, 1899).

GALE, THEOPHILUS (1628-1678), English nonconformist divine, was born in 1628 at Kingsteigton, in Devonshire, where his father was vicar. In 1647 he was entered at Magdalen College, Oxford, where he took his B.A. degree in 1649, and M.A. in 1652. In 1650 he was made fellow and tutor of his college. He remained some years at Oxford, discharging actively the duties of tutor, and was in 1657 appointed as preacher in Winchester cathedral. In 1662 he refused to submit to the Act of Uniformity, and was ejected. He became tutor to the sons of Lord Wharton, whom he accompanied to the Protestant college of Caen, in Normandy, returning to England in 1665. The latter portion of his life he passed in London as assistant to John Rowe, an Independent minister who had charge of an important church in Holborn; Gale succeeded Rowe in 1677, and died in the following year. His principal work, *The Court of the Gentiles*, which appeared in parts in 1669, 1671 and 1676, is a strange storehouse of miscellaneous philosophical learning. It resembles the *Intellectual System* of Ralph Cudworth, though much inferior to that work both in general construction and in fundamental idea. Gale's endeavour (based on a hint of Grotius in *De veritate*, i. 16) is to prove that the whole philosophy of the Gentiles is a distorted or mangled reproduction of Biblical truths. Just as Cudworth referred the Democritean doctrine of atoms to Moses as the original author, so Gale tries to show that the various systems of Greek thought may be traced back to Biblical sources. Like so many of the learned works of the 17th century, the *Court of the*

Gentiles is chaotic and unsystematic, while its erudition is rendered almost valueless by the complete absence of any critical discrimination.

His other writings are: *A True Idea of Jansenism* (1669); *Theophilus, or a Discourse of the Saint's Amicitia with God in Christ* (1671); *Anatomie of Infidelitie* (1672); *Idea theologiae* (1673); *Philosophia generalis* (1676).

GALE, THOMAS (?1636-1702), English classical scholar and antiquarian, was born at Scruton, Yorkshire. He was educated at Westminster school and Trinity College, Cambridge, of which he became a fellow. In 1666 he was appointed regius professor of Greek at Cambridge, in 1672 high master of St Paul's school, in 1676 prebendary of St Paul's, in 1677 a fellow of the Royal Society, and in 1697 dean of York. He died at York on the 7th (or 8th) of April 1702. He published a collection, *Opuscula mythologica, ethica, et physica*, and editions of several Greek and Latin authors, but his fame rests chiefly on his collection of old works bearing on Early English history, entitled *Historiae Anglicanae scriptores* and *Historiae Britannicae, Saxonicae, Anglo-Danicae scriptores XV*. He was the author of the inscription on the London Monument in which the Roman Catholics were accused of having originated the great fire.

See J. E. B. Mayor, *Cambridge in the Time of Queen Anne*, 448-450.

GALE. 1. (A word of obscure origin; possibly derived from Dan. *gøl*, mad or furious, sometimes applied to wind, in the sense of boisterous) a wind of considerable power, considerably stronger than a breeze, but not severe enough to be called a storm. In nautical language it is usually combined with some qualifying word, as "half a gale," "a stiff gale." In poetical and figurative language "gale" is often used in a pleasant sense, as in "favouring gale"; in America, it is used in a slang sense for boisterous or excited behaviour.

2. The payment of rent, customs or duty at regular intervals; a "hanging gale" is an arrear of rent left over after each successive "gale" or rent day. The term survives in the Forest of Dean, for leases granted to the "free miners" of the forest, granted by the "gaveller" or agent of the crown, and the term is also applied to the royalty paid to the crown, and to the area mined. The word is a contracted form of the O. Eng. *gafol*, which survives in "gavel," in gavelkind (*q.v.*), and in the name of the office mentioned above. The root from which these words derive is that of "give." Through Latinized forms it appears in *gabelle* (*q.v.*).

3. The popular name of a plant, also known as the sweet gale or gaul, sweet willow, bog or Dutch myrtle. The Old English form of the word is *gaged*. It is a small, twiggy, resinous fragrant shrub found on bogs and moors in the British Islands, and widely distributed in the north temperate zone. It has narrow, short-stalked leaves and inconspicuous, apetalous, unisexual flowers borne in short spikes. The small drupe-like fruit is attached to the persistent bracts. The leaves are used as tea and as a country medicine. John Gerard (*Herball*, p. 1228) describes it as sweet willow or gaul, and refers to its use in beer or ale. The genus *Myrica* is the type of a small, but widely distributed order, *Myricaceae*, which is placed among the apetalous families of Dicotyledons, and is perhaps most nearly allied to the willow family. *Myrica cerifera* is the candleberry, wax-myrtle or wax-tree (*q.v.*).

GALEN, CHRISTOPH BERNHARD, FREIHERR VON (1606-1678), prince bishop of Münster, belonged to a noble Westphalian family, and was born on the 12th of October 1606. Reduced to poverty through the loss of his paternal inheritance, he took holy orders; but this did not prevent him from fighting on the side of the emperor Ferdinand III. during the concluding stages of the Thirty Years' War. In 1650 he succeeded Ferdinand of Bavaria, archbishop of Cologne, as bishop of Münster. After restoring some degree of peace and prosperity in his principality, Galen had to contend with a formidable insurrection on the part of the citizens of Münster; but at length this was crushed, and the bellicose bishop, who maintained a strong army, became an important personage in Europe. In 1664 he was chosen one of the directors of the imperial army raised to fight the Turk;

and after the peace which followed the Christian victory at St Gotthard in August 1664, he aided the English king Charles II. in his war with the Dutch, until the intervention of Louis XIV. and Frederick William I. of Brandenburg compelled him to make a disadvantageous peace in 1666. When Galen again attacked Holland six years later he was in alliance with Louis, but he soon deserted his new friend, and fought for the emperor Leopold I. against France. Afterwards in conjunction with Brandenburg and Denmark he attacked Charles XI. of Sweden, and conquered the duchy of Bremen. He died at Ahaus on the 10th of September 1678. Galen showed himself anxious to reform the church, but his chief energies were directed to increasing his power and prestige.

See K. Tücking, *Geschichte des Stifts Münster unter C. B. von Galen* (Münster, 1865); P. Corstiens, *Bernard van Galen, Vorst-Bischof van Munster* (Rotterdam, 1872); A. Hüsing, *Fürstbischof C. B. von Galen* (Münster, 1887); and C. Brinkmann in the *English Historical Review*, vol. xxi. (1906). There is in the British Museum a poem printed in 1666, entitled *Letter to the bishop of Munster containing a Panegyric of his heroic achievements in heroic verse*.

GALEN (or **GALENUS**), **CLAUDIUS**, called Gallien by Chaucer and other writers of the middle ages, the most celebrated of ancient medical writers, was born at Pergamus, in Mysia, about A.D. 130. His father Nicon, from whom he received his early education, is described as remarkable both for excellence of natural disposition and for mental culture; his mother, on the other hand, appears to have been a second Xanthippe. In 146 Galen began the study of medicine, and in about his twentieth year he left Pergamus for Smyrna, in order to place himself under the instruction of the anatomist and physician Pelops, and of the peripatetic philosopher Albinus. He subsequently visited other cities, and in 158 returned from Alexandria to Pergamus. A few years later he went for the first time to Rome. There he healed Eudemus, a celebrated peripatetic philosopher, and other persons of distinction; and ere long, by his learning and unparalleled success as a physician, earned for himself the titles of "Paradoxologus," the wonder-speaker, and "Paradoxopoeus," the wonder-worker, thereby incurring the jealousy and envy of his fellow-practitioners. Leaving Rome in 168, he repaired to his native city, whence he was soon sent for to Aquileia, in Venetia, by the emperors Lucius Verus and Marcus Aurelius. In 170 he returned to Rome with the latter, who, on departing thence to conduct the war on the Danube, having with difficulty been persuaded to dispense with his personal attendance, appointed him medical guardian of his son Commodus. In Rome Galen remained for some years, greatly extending his reputation as a physician, and writing some of his most important treatises. It would appear that he eventually betook himself to Pergamus, after spending some time at the island of Lemnos, where he learned the method of preparing a certain popular medicine, the "terra lenmia" or "sigillata." Whether he ever revisited Rome is uncertain, as also are the time and place of his death. According to Suidas, he died at the age of seventy, or in the year 200, in the reign of Septimius Severus. If, however, we are to trust the testimony of Abul-faraj, his decease took place in Sicily, when he was in his eightieth year. Galen was one of the most versatile and accomplished writers of his age. He composed, it is said, nearly 500 treatises on various subjects, including logic, ethics and grammar. Of the published works attributed to him, 83 are recognized as genuine, 19 are of doubtful authenticity, 45 are confessedly spurious, 19 are fragments, and 15 are notes on the writings of Hippocrates.

Galen, who in his youth was carefully trained in the Stoic philosophy, was an unusually prolific writer on logic. Of the numerous commentaries and original treatises, a catalogue of which is given in his work *De propriis libris*, one only has come down to us, the treatise on *Fallacies in disicione* (*Περὶ τῶν κατὰ τὴν λέξιν σοφισμάτων*). Many points of logical theory, however, are discussed in his medical and scientific writings. His name is perhaps best known in the history of logic in connexion with the fourth syllogistic figure, the first distinct statement of which was ascribed to him by Averroes. There is no evidence from Galen's own works that he did make this addition to the doctrines of

sylogism, and the remarkable passage quoted by Minoides Minas from a Greek commentator on the *Analytics*, referring the fourth figure to Galen, clearly shows that the addition did not, as generally supposed, rest on a new principle, but was merely an amplification or alteration of the indirect moods of the first figure already noted by Theophrastus and the earlier Peripatetics.

In 1844 Minas published a work, avowedly from a MS. with the superscription *Galenus*, entitled *Γαληνού εισαγωγή διαλεκτική*. Of this work, which contains no direct intimation of a fourth figure, and which in general exhibits an astonishing mixture of the Aristotelian and Stoic logic, Prantl speaks with the bitterest contempt. He shows demonstratively that it cannot be regarded as a writing of Galen's, and ascribes it to some one or other of the later Greek logicians. A full summary of its contents will be found in the 1st vol. of the *Geschichte der Logik* (pp. 591-610), and a notice of the logical theories of the true Galen in the same work, pp. 559-577.

There have been numerous issues of the whole or parts of Galen's works, among the editors or illustrators of which may be mentioned Jo. Bapt. Opizo, N. Leonicius, L. Fuchs, A. Lacuna, Ant. Musa Brassavolus, Aug. Gadalduinus, Conrad Gesner, Sylvius, Cornarius, Joannes Montanus, Joannes Caius, Thomas Linacre, Theodore Goulton, Caspar Hoffman, René Chartier, Haller and Kühn. Of Latin translations Choulant mentions one in the 15th and twenty-two in the following century. The Greek text was edited at Venice, in 1525, 5 vols. fol.; at Basel, in 1538, 5 vols. fol.; at Paris, with Latin version by René Chartier, in 1639, and in 1679, 13 vols. fol.; and at Leipzig, in 1821-1833, by C. G. Kühn, considered to be the best, 20 vols. 8vo. An epitome in English of the works of Hippocrates and Galen, by J. R. Coxe, was published at Philadelphia in 1846. A new edition of Galen's smaller works by J. Marquardt, Iwan Müller and G. Helmreich was published in three volumes at Leipzig in 1884-1909.

Further details as to the life and an account of the anatomical and medical knowledge of Galen will be found in the historical articles under the headings of ANATOMY and MEDICINE. See also René Chartier's Life, in his edition of Galen's works; N. F. J. Eloy; *Dictionnaire historique de la médecine*, s. v. "Galen," tom. 3. (1778); F. Adams's "Commentary" in his *Medical Works of Paulus Aegineta* (London and Aberdeen, 1834); J. Kidd, "A Cursory Analysis of the Works of Galen, so far as they relate to Anatomy and Physiology," *Trans. Provincial Med. and Surg. Assoc.*, vi., 1837, pp. 299-336; C. V. Daremberg, *Exposition des connaissances de Galien sur l'anatomie, la physiologie et la pathologie du système nerveux* (Thèse pour le Doctorat en Médecine) (Paris, 1841); J. R. Gasquet, "The Practical Medicine of Galen and his Time," *The British and Foreign Médico-Chirurgical Rev.*, vol. xi., 1867, pp. 472-488; and Ilberg, "Die Schriften des Claudius Galenus," *Rheinisches Museum für Philologie*, 1889, 1892 and 1896.

GALENA, a city and the county-seat of Jo Daviess county, Illinois, U.S.A., in the N.W. part of the state, on the Galena (formerly the Fever) river, near its junction with the Mississippi, about 165 m. W.N.W. of Chicago. Pop. (1900) 5005, of whom 918 were foreign-born; (1910) 4835. It is served by the Chicago, Burlington & Quincy, the Chicago & North-Western and the Illinois Central railways; the Galena river has been made navigable by government locks at the mouth of the river, but the river traffic is unimportant. The city is built on rocky limestone bluffs, which rise rather abruptly on each side of the river, and a number of the parallel streets, of different levels, are connected by flights of steps. In Grant Park there is a statue of General U. S. Grant, who was a resident of Galena at the outbreak of the Civil War. In the vicinity there are the most important deposits of zinc and lead in the state, and the city derives its name from the deposits of sulphide of lead (galena), which were the first worked about here; below the galena is a zone of zinc carbonate (or smithsonite) ores, which was the main zone worked between 1860 and 1890; still lower is a zone of blende, or zinc sulphide, now the principal source of the mineral wealth of the region. The production of zinc is increasing, but that of lead is unimportant. The principal manufactures are mining pumps and machinery, flour, woollen goods, lumber and furniture. Water power is afforded by the river. Galena was originally a trading post, called by the French "La Pointe" and by the English "Fever River," the river having been named after le Fevre, a French trader who settled near its mouth. In 1826 Galena was laid out as a town and received its present name; it was incorporated in 1835 and was reincorporated in 1882. In 1838 a theatre was

opened, one of whose proprietors was Joseph Jefferson, the father of the celebrated actor of that name.

GALENA, a city of Cherokee county, Kansas, U.S.A., in the extreme S.E. part of the state, on Short Creek and near Spring river. Pop. (1890) 2406; (1900) 10,155, of whom 580 were negroes and 251 were foreign-born; (1905) 6449; (1910) 6006. It is situated at the intersection of the Missouri, Kansas & Texas, and the Kansas City, Fort Scott & Memphis ("Frisco System") railways, in the midst of a lead and zinc region, extremely valuable deposits of these metals having been discovered in 1877. Smelters and foundries are its principal manufacturing establishments. Water power in abundance is furnished by the Spring river. After the discovery of the ore deposits two rival companies founded Galena and Empire City (pop. in 1905, 982), the former S. of Short Creek and the latter N. of it. Galena was incorporated in 1877, and in 1907 Empire City was annexed to it.

GALENA, an important ore of lead, consisting of lead sulphide (PbS). The mineral was mentioned by Pliny under this name, and it is sometimes now known as lead-glance (Ger. *Bleiglanz*). It crystallizes in the cubic system, and well-developed crystals are of common occurrence; the usual form is the cube or the cubo-octahedron (fig.). An important character, and one by which the mineral may always be recognized, is the perfect cubical cleavage, on which the lustre is brilliant and metallic. The colour of the mineral and of its streak is lead-grey; it is opaque; the hardness is 2½ and the specific gravity 7.5. Twinned crystals are not common, but the presence of polysynthetic twinning is sometimes shown by fine striations running diagonally or obliquely across the cleavage surfaces. Large masses with a coarse or fine granular structure are of common occurrence; the fractured surfaces of such masses present a spangled appearance owing to the numerous bright cleavages.

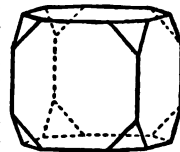

The formula PbS corresponds with lead 86.6 and sulphur 13.4%. The mineral nearly always contains a small amount of silver, and sometimes antimony, arsenic, copper, gold, selenium, &c. Argentiferous galena is an important source of silver; this metal is present in amounts rarely exceeding 1%, and often less than 0.03% (equivalent to 10½ ounces per ton). Since argentite (Ag₂S) is isomorphous with galena, it is probable that the silver isomorphously replaces lead, but it is to be noted that native silver has been detected as an enclosure in galena.

Galena is of wide distribution, and occurs usually in metaliferous veins traversing crystalline rocks, clay-slates and limestones, and also as pockets in limestones. It is often associated with blende and pyrites, and with calcite, fluorspar, quartz, barytes, chalybite and pearlspar as gangue minerals; in the upper oxidized parts of the deposits, cerussite and anglesite occur as alteration products. The mineral has occasionally been observed as a recent formation replacing organic matter, such as wood; and it is sometimes found in beds of coal. As small concretionary nodules, it occurs disseminated through sandstone at Kommern in the Eifel. In the lead-mining districts of Derbyshire and the north of England the ore occurs as veins and flats in the Carboniferous Limestone series, whilst in Cornwall the veins traverse clay-slates. In the Upper Mississippi lead region of Missouri, Illinois, Iowa and Wisconsin the ore fills large cavities or chambers in limestone.

Galena is met with at all places where lead is mined; of localities which have yielded finely crystallized specimens the following may be selected for mention: Derbyshire, Alston in Cumberland, Laxey in the Isle of Man (where crystals measuring almost a foot across have been found), Neudorf in the Harz, Rossie in New York and Joplin in Missouri. Good crystals have also been obtained as a furnace product.

Coarsely grained galena is used for glazing pottery, and is then known as "potters' ore" or alquifoux.

The galena group includes several other cubic minerals, such as argentite (q.v.). Mention may also be made here of clausthalite

(lead selenide, PbSe) and altaite (lead telluride, PbTe), which, with their lead-grey colour and perfect cubic cleavage, closely resemble galena in appearance; these species are named after the localities at which they were originally found, namely, Klautthal in the Harz and the Altai mountains in Asiatic Russia. Altaite is of interest as being one of the tellurides found associated with gold. (L. J. S.)

GALEOPITHECUS, the scientific designation of the Colugo (*q.v.*) or Cobego, commonly known as the flying-lemur, and alone representing the family *Galeopithecidae*. Much uncertainty has prevailed among naturalists as to the systematic position of this animal, or rather these animals (for there are two species); and while some have referred it to the lemurs, others have placed it with the bats, and others again among the *Insectivora*, as the representative of a special subordinal group, the *Dermoptera*. Dr H. C. Chapman, who has made a special study of the creature, writes, however, as follows: "It appears, at least in the judgment of the author, that *Galeopithecus* cannot be regarded as being either a lemur, or insectivore, or bat, but that it stands alone, the sole representative of an ancient group, *Galeopithecidae*, as *Hyrax* does of *Hyracoidea*. While *Galeopithecus* is but remotely related to the *Lemuroidea* and *Insectivora*, it is so closely related to *Chiroptera*, more particularly in regard to the structure of its patagium, brain, alimentary canal, genito-urinal apparatus,

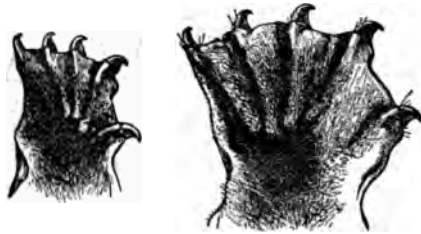

Feet of Philippine Colugo, or Flying-Lemur (*Galeopithecus philippinensis*).

&c., that there can be but little doubt that the *Chiroptera* are the descendants of *Galeopithecus*, or, more probably, that both are the descendants of a *Galeopithecus*-like ancestor." Without going quite so far as this, it may be definitely admitted that the colugo is entitled to represent an order by itself, the characters of which will be as follows: Herbivorous, climbing, unguiculate mammals, provided with a very extensive flying-membrane, and having the dental formula $i. \frac{3}{2}, c. \frac{1}{1}, p. \frac{2}{2}, m. \frac{3}{3}$, total 34. The lower incisors are directed forwards and have a comb-like structure of their crowns, while the outermost of these teeth and the canines are double-rooted, being in these respects, taken together, quite unlike those of all other mammals; the cheek-teeth have numerous sharp cusps; and there is the normal replacement of milk-molars by premolars. In the skull the orbit is surrounded by bone, and the tympanic has a bulla and an ossified external meatus. The ulna and fibula are to some extent inclined backwards; the carpus has a scapho-lunar; and the feet are five-toed. The hemispheres of the brain are short and but slightly convoluted; the stomach is simple; there is a large caecum; the testes are received into inguinal pouches; the uterus is two-borned; the placenta is discoidal; and there are two pairs of pectoral teats. A single offspring is produced at a birth.

It will be obvious that if other representatives of the *Dermoptera* were discovered, some of these features might apply only to the family *Galeopithecidae*.

There are two species, *Galeopithecus volans*, ranging from Burma, Siam and the Malay Peninsula to Borneo, Sumatra and Java, and *G. philippinensis* of the Philippine group. The former, which is nearly 2 ft. in total length, is distinguished by its larger upper incisors, shorter ears and smaller skull. In both species not only are the long and slender limbs connected by a

broad integumentary expansion extending outwards from the sides of the neck and body, but there is also a web between the fingers and toes as far as the base of the claws (*fig.*); and the hind-limbs are further connected by a similar expansion passing outwards along the back of the feet to the base of the claws, and, inwardly, involving the long tail to the tip, forming a true interfemoral membrane, as in bats. Besides differing from bats altogether in the form of the anterior limbs and of the double-rooted outer incisors and canines, *Galeopithecus* contrasts strongly with that order in the presence of a large sacculated caecum, and in the great length of the colon, which is so remarkably short in *Chiroptera*. From the lemurs, on the other hand, the form of the brain, the character of the teeth, the structure of the skull, and the deciduate discoidal placenta at once separate the group. (R. L.)*

GALERIUS [**GALERIUS VALERIUS MAXIMIANUS**], Roman emperor from A.D. 305 to 311, was born near Sardica in Thrace. He originally followed his father's occupation, that of a herdsman, whence his surname of *Armentarius* (Lat. *armentum*, herd). He served with distinction as a soldier under Aurelian and Probus, and in 293 was designated Caesar along with Constantius Chlorus, receiving in marriage Diocletian's daughter Valeria, and at the same time being entrusted with the care of the Illyrian provinces. In 296, at the beginning of the Persian War, he was removed from the Danube to the Euphrates; his first campaign ended in a crushing defeat, near Callinicum, but in 297, advancing through the mountains of Armenia, he gained a decisive victory over Narses (*q.v.*) and compelled him to make peace. In 305, on the abdication of Diocletian and Maximianus, he at once assumed the title of Augustus, with Constantius his former colleague, and having procured the promotion to the rank of Caesar of Flavius Valerius Severus, a faithful servant, and Daia (Maximianus), his nephew, he hoped on the death of Constantius to become sole master of the Roman world. This scheme, however, was defeated by the sudden elevation of Constantine at Eboracum (York) on the death of his father, and by the action of Maximianus and Maxentius in Italy. After an unsuccessful invasion of Italy in 307 he elevated his friend Licinius to the rank of Augustus, and, moderating his ambition, devoted the few remaining years of his life "to the enjoyment of pleasure and to the execution of some works of public utility." It was at the instance of Galerius that the first of the celebrated edicts of persecution against the Christians was published, on the 24th of February 303, and this policy of repression was maintained by him until the appearance of the general edict of toleration (311), issued in his own name and in those of Licinius and Constantine. He died in May 311 A.D.

See Zosimus ii. 8-11; Zonaras xii. 31-34; Eutropius ix. 24. x. 1.

GALESBURG, a city and the county-seat of Knox county, Illinois, U.S.A., in the N.W. part of the state, 163 m. S.W. of Chicago. Pop. (1890) 15,264; (1900) 18,607; of whom 3602 were foreign-born; (census, 1910) 22,089. It is served by the Atchison, Topeka & Santa Fé, and the Chicago, Burlington & Quincy railways. Knox College (non-sectarian and coeducational), which was chartered here in 1837 as the "Knox Manual Labor College" (the present name was adopted in 1857), was opened in 1841, and had in 1907-1908, 31 instructors and 658 students, of whom more than half were in the Conservatory of Music, a department of the college, and 79 were in the Academy. Lombard College (coeducational; Universalist), which was chartered as the "Illinois Liberal Institute" in 1851, was known as Lombard University (in honour of Benjamin Lombard, a benefactor) from 1855 to 1899; it includes a College of Liberal Arts, the Ryder Divinity School (1881), and departments of music and domestic science, and in 1907-1908 had 18 instructors and 117 students. Here also are Corpus Christi College (Roman Catholic), St Joseph's Academy (Roman Catholic) and Brown's Business College (1874). There is a public library, founded in 1874. The industries consist mainly of the construction and repairing of steam railway cars (in the shops of the Chicago, Burlington & Quincy railway) and the manufacture of foundry and machine-shop products, vitrified brick, agricultural implements

and machinery. The total value of the factory product in 1905 was \$2,217,772, being 52.9% more than in 1900. Galesburg was named in honour of the Rev. George Washington Gale (1780-1862), a prominent Presbyterian preacher, who in 1827-1834 had founded the Oneida Manual Labor Institute at Whites town, Oneida county, New York. Desiring to establish a college in the Mississippi Valley to supply "an evangelical and able ministry" to "spread the Gospel throughout the world," and also wishing to counteract the influence of pro-slavery men in Illinois, he interested a number of people in the project, formed a society for colonization, and in 1836 led the first settlers to Galesburg, the "Mesopotamia in the West." Knox College was founded to fulfil his educational purpose. Galesburg was an important "station" of the Underground Railroad, one of the conditions of membership in the "Presbyterian Church of Galesburg" (the name of Mr Gale's society) being opposition to slavery; and in 1855 this caused the church to withdraw from the Presbytery. Galesburg was chartered as a city in 1857. On the 7th of October 1858 one of the famous Lincoln-Douglas debates was held in the grounds of Knox College.

GALGĀCUS, or perhaps rather **CALGĀCUS**, a Caledonian chief who led the tribes of North Britain against the invading Roman army under Cn. Julius Agricola about A.D. 85 and was defeated at the battle of Mons Graupius (*Tac. Agric.* 29). The name recurs much later, in Adamnan's *Life of Columba*, in the name of a wood near Londonderry, Daire-Calgachi or Roboretum Calgachi, "the wood of Calgacus": it may be Celtic and denote "the man with the sword."

GALIANI, FERDINANDO (1728-1787), Italian economist, was born at Chieti on the 2nd of December 1728. He was carefully educated by his uncle Monsignor C. Galiani at Naples and Rome with a view to entering the Church. Galiani gave early promise of distinction as an economist, and even more as a wit. At the age of twenty-two, after he had taken orders, he had produced two works by which his name became widely known far beyond the bounds of his own Naples. The one, his *Trattato della moneta*, in which he shows himself a strong supporter of the mercantile school, deals with many aspects of the question of exchange, but always with a special reference to the state of confusion then presented by the whole monetary system of the Neapolitan government. The other, *Raccolta in Morie del Boia*, established his fame as a humorist, and was highly popular in Italian literary circles at the end of the 18th century. In this volume Galiani parodied with exquisite felicity, in a series of discourses on the death of the public hangman, the styles of the most pompous and pedantic Neapolitan writers of the day. Galiani's political knowledge and social qualities now pointed him out to the discriminating eye of King Charles, afterwards Charles III. of Spain, and his liberal minister Tanucci, and he was appointed in 1759 secretary to the Neapolitan embassy at Paris. This post he held for ten years, when he returned to Naples and was made a councillor of the tribunal of commerce, and in 1777, minister of the royal domains. His economic reputation was made by a book written in French and published in Paris, namely, his *Dialogues sur le commerce des blés*. This work, by its light and pleasing style, and the vivacious wit with which it abounded, delighted Voltaire, who spoke of it as a book in the production of which Plato and Molière might have been combined! The author, says Pecchio, treated his arid subject as Fontenelle did the vortices of Descartes, or Algarotti the Newtonian system of the world. The question at issue was that of the freedom of the corn trade, then much agitated, and, in particular, the policy of the royal edict of 1764, which permitted the exportation of grain so long as the price had not arrived at a certain height. The general principle he maintains is that the best system in regard to this trade is to have no system—countries differently circumstanced requiring, according to him, different modes of treatment. He fell, however, into some of the most serious errors of the mercantilists—holding, as indeed did also Voltaire and even Verri, that one country cannot gain without another losing, and in his earlier treatise going so far as to defend the action of governments in debasing the currency. Until his death at Naples on the

30th of October 1787, Galiani kept up with his old Parisian friends a correspondence, which was published in 1818.

See *L'Abate Galiani*, by Alberto Margheri (1878), and his correspondence with Tanucci in Viessesux's *L'Archivio storico* (Florence, 1878).

GALICIA (Ger. *Galizien*; Pol. *Halicia*), a crownland of Austria, bounded E. and N. by Russia, S. by Bukovina and Hungary, and W. by Austrian and Prussian Silesia. It has an area of 30,299 sq. m., and is the largest Austrian province. It comprises the old kingdoms of Galicia and Lodomeria, the duchies of Auschwitz and Zator, and the grand duchy of Cracow.

Galicia lies on the northern slopes of the Carpathians, which with their offshoots cover about a third of the whole area of the country. The surface gradually sinks down by undulating terraces to the valleys of the Vistula and Dniester. To the N. and E. of these rivers Galicia forms a continuation of the great plains of Russia, intersected only by a few hills, which descend from the plateaus of Poland and Podolia, and which attain in some places an altitude of 1300 to 1500 ft. The Carpathians, which, extending in the form of an arc, form the boundary between Galicia and Hungary, are divided into the West and the East Beskides, which are separated by the northern ramifications of the massif of the Tatra. The highest peaks are the Babia Góra (5650 ft.), the Wolowicz (6773 ft.) and the Cserna Góra (6505 ft.). The principal passes are those of Zdjár over the Tatra, and of Dukla, Vereczke Körösmező or Delatyn in the East Beskides. The river Vistula, which becomes navigable at Cracow, and forms afterwards the north-western frontier of Galicia, receives the Sola, the Skawa, the Raba, the Dunajec with its affluents the Poprad and the Biala, the Wisloka, the San and the Bug. The Dniester, which rises in the Carpathians, within the territory of Galicia, becomes navigable at Sambor, and receives on the right the Stryj, the Swica, the Lomnica and the Bystrzyca, and on the left the Lipa, the Strypa, the Sereth and the Zbrucz, the boundary river towards Russia. The Pruth, which also rises in the Carpathians, within the territory of Galicia, traverses its south-eastern corner and receives the Czeremosz, the boundary river towards Bukovina. There are few lakes in the country except mountain tarns; but considerable morasses exist about the Upper Dniester, the Vistula and the San, while the ponds or dams in the Podolian valleys are estimated to cover an area of over 200 sq. m. The most frequented mineral springs are the alkaline springs at Szczawnica and Krynica, the sulphur springs at Krzesowice, Szkló and Lubian, and the iodine springs at Iwonicz.

Exposed to the cold northern and north-eastern winds, and shut out by the Carpathians from the warm southerly winds, Galicia has the severest climate in Austria. It has long winters, with an abundant snowfall, short and wet springs, hot summers and long and steady autumns. The mean annual temperature at Lemberg is 46.2° F., and at Tarnopol only 43° F.

Of the total area 48.45% is occupied by arable land, 11.16% by meadows, 9.19% by pastures, 1.39% by gardens and 25.76% by forests. The soil is generally fertile, but agriculture is still backward. The principal products are barley, oats, rye, wheat, maize and leguminous plants. Galicia has the largest area under potatoes and legumes in the whole of Austria, and hemp, flax, tobacco and hops are of considerable importance. The principal mineral products are salt, coal and petroleum. Salt is extracted at Wieliczka, Bochnia, Bolechow, Dolina, Kalusz and Kosow. Coals are found in the Cracow district at Jaworzno, at Siersza near Trzebinia and at Dabrowa. Some of the richest petroleum fields in Europe are spread in the region of the Carpathians, and are worked at Boryslaw and Schodnica near Drohobycz, Bobrka and Potok near Krosno, Sloboda-Runguraka near Kolomea, &c. Great quantities of ozocerite are also extracted in the petroliferous region of the Carpathians. Other mineral products are zinc, extracted at Trzebieonka and Wodna in the Cracow region, amounting to 40% of the total zinc production in Austria, iron ore, marble and various stones for construction. The sulphur mines of Swosowice near Cracow, which had been worked since 1598, were abandoned in 1884.

The manufacturing industries of Galicia are not highly developed. The first place is occupied by the distilleries, whose output amounts to nearly 40% of the total production of spirits in Austria. Then follow the petroleum refineries and kindred industries, saw-mills and the fabrication of various wood articles, paper and milling. The sugar factory at Tlumacz and the tobacco factory at Winniki are amongst the largest establishments of their kind in Austria. Cloth manufacture is concentrated at Biala, while the weaving of linen and of woollens is pursued as a household industry, the former in the Carpathian region, the latter in eastern Galicia. The commerce, which is mainly in the hands of the Jews, is very active, and the transit trade to Russia and to the East is also of considerable importance.

Galicia had in 1900 a population of 7,295,538, which is equivalent to 241 inhabitants per sq. m. The two principal nationalities are the Poles (45%) and the Ruthenians (42%), the former predominating in the west and in the big towns, and the latter in the east. The Poles who inhabit the Carpathians are distinguished as Goralians (from *góry*, mountain), and those of the lower regions as Mazures and Cracoviaks. The Ruthenian highlanders bear the name of Huzulians. The Poles are mostly Roman Catholics, the Ruthenians are Greek Catholics, and there are over 770,000 Jews, and about 2500 Armenians, who are Catholics and stand under the jurisdiction of an Armenian archbishop at Lemberg.

The Roman Catholic Church has an archbishop, at Lemberg, and three bishops, at Cracow, at Przemysl and at Tarnow, and the Greek Catholic Church is represented by an archbishop, at Lemberg, and two bishops, at Przemysl and at Stanislaw. At the head of the educational institutions stand the two universities of Lemberg and Cracow, and the Polish academy of science at Cracow.

The local Diet is composed of 151 members, including the 3 archbishops, the 5 bishops, and the 2 rectors of the universities, and Galicia sends 78 deputies to the Reichsrat at Vienna. For administrative purposes, the province is divided into 78 districts and 2 autonomous municipalities—Lemberg (pop. 1,59,618), the capital, and Cracow (91,310). Other principal towns are: Przemysl (46,439), Kolomea (34,188), Tarnów (31,548), Tarnopol (30,368), Stanislaw (29,628), Stryj (23,673), Jaroslau (22,614), Drohobycz (19,146), Podgórze (18,142), Brody (17,360), Sambor (17,027), Neusandec (15,724), Rzeszów (14,714), Zloczow (12,209), Grodok (11,845), Horodenka (11,615), Buczacz (11,504), Sniatyn (11,498), Brzezany (11,244), Kuty (11,127), Boryslaw (10,671), Chrzanów (10,170), Jaworów (10,090), Bochnia (10,049) and Biala (8265).

Galicia (or Halicz) took its rise, along with the neighbouring principality of Lodomeria (or Vladimir), in the course of the 12th century—the seat of the ruling dynasty being Halicz or Halitch. Disputes between the Galician and Lodomerian houses led to the interference of the king of Hungary, Bela III., who in 1190 assumed the title of king, and appointed his son Andreas lieutenant of the kingdom. Polish assistance, however, enabled Vladimir, the former possessor, to expel Andreas, and in 1198 Roman, prince of Lodomeria, made himself master of Galicia also. On his death in 1205 the struggle between Poland and Hungary for supremacy in the country was resumed; but in 1215 it was arranged that Daniel (1205-1264), son of Roman, should be invested with Lodomeria, and Coloman, son of the Hungarian king, with Galicia. Coloman, however, was expelled by Mstislav of Novgorod; and in his turn Andreas, Mstislav's nominee, was expelled by Daniel of Lodomeria, a powerful prince, who by a flexible policy succeeded in maintaining his position. Though in 1235 he had recognized the overlordship of Hungary, yet, when he found himself hard pressed by the Mongolian general Batu, he called in the assistance of Innocent IV., and accepted the crown of Galicia from the hands of a papal legate; and again, when Innocent disappointed his expectation, he returned to his former connexion with the Greek Church. On the extinction of his line in 1340 Casimir III. of Poland incorporated Galicia and Lemberg; on Casimir's death in 1370 Louis the Great of Hungary, in accordance with previous treaties, became king of Poland, Galicia and

Lodomeria; and in 1382, by the marriage of Louis's daughter with Ladislaus II., Galicia, which he had regarded as part of his Hungarian rather than of his Polish possessions, became definitely assigned to Poland. On the first partition of Poland, in 1772, the kingdom of Galicia and Lodomeria came to Austria, and to this was added the district of New or West Galicia in 1795; but at the peace of Vienna in 1809 West Galicia and Cracow were surrendered to the grand-duchy of Warsaw, and in 1810 part of East Galicia, including Tarnopol, was made over to Russia. This latter portion was recovered by Austria at the peace of Paris (1814), and the former came back on the suppression of the independent republic of Cracow in 1846. After the introduction of the constitution of February 1861, Galicia gained a larger degree of autonomy than any other province in the Austrian empire.

See *Die österreichisch-ungarische Monarchie in Wort und Bild*, vol. 19 (Wien, 1885-1902, 24 vols.); *Die Länder Österreich-Ungarns in Wort und Bild*, vol. 10 (Wien, 1881-1886, 15 vols.). Remarkable sketches of Galician life are to be found in the works of the German novelist Sacher-Masoch (1835-1895).

GALICIA (the ancient *Gallaecia* or *Callaecia*, *Καλλαικία* or *Καλαυκία*), a captaincy-general, and formerly a kingdom, county and province, in the north-western angle of Spain; bounded on the N. by the Bay of Biscay, E. by Leon and Asturias, S. by Portugal, and W. by the Atlantic Ocean. Pop. (1900) 1,980,515; area, 11,254 sq. m. In 1833 Galicia was divided for administrative purposes into the provinces of Corunna, Lugo, Orense and Pontevedra.

Galicia is traversed by mountain ranges, sometimes regarded as a continuation of the Cantabrian chain; and its surface is further broken in the east by the westernmost ridges of that system, which, running in a south-westerly direction, rise above the basin of the Miño. The high land north of the headwaters of the Miño forms the sole connecting link between the Cantabrians properly so-called and the mountains of central and western Galicia. The average elevation of the province is considerable, and the maximum height (6593 ft.) is reached in the Peña Trevinca on the eastern border of Orense.

The principal river is the Miño (Portuguese *Minho*; Lat. *Minisus*; so named, it is said, from the *minium* or vermilion found in its bed). Rising near Mondoñedo, within 25 m. of the northern coast, the Miño enters the Atlantic near the port of Guardia, after a course of 170 m. S. and S.W. Its lower reaches are navigable by small vessels. Of its numerous affluents the most important is the Sil, which rises among the lofty mountains between Leon and Asturias. Among other rivers having a westerly direction may be mentioned the Tambre, the Ulla and the Lerez or Léz; which falls into the Atlantic by estuaries or *rias* called respectively *Ria de Muros y Noya*, *Ria de Arosa* and *Ria de Pontevedra*. The rivers of the northern versant, such as the Nera, are, like those of Asturias, for the most part short, rapid and subject to violent floods.

The coast-line of Galicia, extending to about 240 m., is everywhere bold and deeply indented, presenting a large number of secure harbours, and in this respect forming a marked contrast to the neighbouring province. The Eo, which bounds Galicia on the east, has a deep estuary, the Rivadeo or Ribadeo, which offers a safe and commodious anchorage. Vivero Bay and the *Ria del Barquero y Váres* are of a similar character; while the harbour of Ferrol ranks among the best in Europe, and is the chief naval station on the northern coast of Spain. On the opposite side of Betanzos Bay (the *ἄγρος Ἰσθμῶ* or *Portus Magnus* of the ancients) is the great port of Corunna or Coruña. The principal port on the western coast is that formed by the deep and sheltered bay of Vigo, but there are also good roadsteads at Corcubion under Cape Finisterre, at Marin and at Carril.

The climate of the Galician coast is mild and equable, but the interior, owing to the great elevation (the town of Lugo is 1900 ft. above sea-level), has a wide range of temperature. The rainfall is exceptionally large, and snow lies on some of the loftier elevations for a considerable portion of the year. The soil is on the whole fertile, and the produce very varied. A considerable quantity of

timber is grown on the high lands, and the rich valley pastures support large herds of cattle, while the abundance of oaks and chestnuts favours the rearing of swine. In the lowland districts good crops of maize, wheat, barley, oats and rye, as well as of turnips and potatoes, are obtained. The fruit also is of excellent quality and in great variety, although the culture of the vine is limited to some of the warmer valleys in the southern districts. The *dehesas* or moorlands abound in game, and fish are plentiful in all the streams. The mineral resources of the province, which are considerable, were known to some extent to the ancients. Strabo (c. 63 B.C.—A.D. 21) speaks of its gold and tin, and Pliny (A.D. 23–79) mentions the *gemma Gallica*, a precious stone. Galicia is also remarkable for the number of its sulphur and other warm springs, the most important of which are those at Lugo, and those from which Orense is said to take its name (*Aquae urentes*).

Ethnologically the Galicians (*Gallegos*) are allied to the Portuguese, whom they resemble in dialect, in appearance and in habits more than the other inhabitants of the peninsula. The men are well known all over Spain and Portugal as hardy, honest and industrious, but for the most part somewhat unskilled, labourers; indeed the word *Gallego* has come to be almost a synonym in Madrid for a "hewer of wood and drawer of water." It is also used as a term of abuse, meaning "boor." Agriculture engages the greater part of the resident population, both male and female; other industries, except the fisheries, are little developed. The largest town in Galicia is Corunna (pop. 1900, 43,971); Santiago de Compostela is the ancient capital and an archiepiscopal see; Lugo, Tuy, Mondoñedo and Orense are bishoprics.

Gallaecia, the country of the Galacii, *Callaici* or *Gallaici*, seems to have been very imperfectly known to the earlier geographers. According to Eratosthenes (276–196 B.C.) the entire population of the peninsula were at one time called *Galatae*. The region properly called by their name, bounded on the south by the Douro and on the east by the Navia, was first entered by the Roman legions under Decius Junius Brutus in 137–136 B.C. (Livy iv, lvi., *Epit.*); but the final subjugation cannot be placed earlier than the time of Augustus (31 B.C.—A.D. 14). On the partition of Spain, which followed the successful invasions of the Suevi, Alans and Vandals, Gallaecia fell to the lot of the first named (A.D. 411). After an independent subsistence of nearly 200 years, the Suevian kingdom was annexed to the Visigothic dominions under Leovigild in 585. In 734 it was occupied by the Moors, who in turn were driven out by Alphonso I. of Asturias, in 739. During the 9th and 10th centuries it was the subject of dispute between more than one count of Galicia and the suzerain, and its coasts were repeatedly ravaged by the Normans. When Ferdinand I. divided his kingdom among his sons in 1063, Galicia was the portion allotted to Garcia, the youngest of the three. In 1072 it was forcibly reannexed by Garcia's brother Alphonso VI. of Castile and thenceforward it remained an integral part of the kingdom of Castile or of Leon. The honorary title of count of Galicia has frequently been borne by younger sons of the Spanish sovereigns.

See Annette B. Meakin, *Galicia, the Switzerland of Spain* (London, 1909).

GALIGNANI, GIOVANNI ANTONIO (1752–1821), newspaper publisher, was born at Brescia, Italy, in 1752. After living some time in London, he went to Paris, where he started in 1800 an English library, and in 1808 a monthly publication, the *Repository of English Literature*. In 1814 he began to publish, in Paris, *Galignani's Messenger*, a daily paper printed in English. At his death in 1821 the paper was carried on by his two sons, Jean-Antoine (1796–1873) and Guillaume (1798–1882). Under their management it enjoyed a high reputation. Its policy was to promote good feeling between England and France. The brothers established and endowed hospitals at Corbeil and at Neuilly-sur-Seine. In recognition of their generosity the city of Corbeil erected a monument in their honour. In 1884 the Galignani family disposed of their interest in *Galignani's Messenger*, and from that date until 1904, when it was discontinued, the paper appeared under the title of the *Daily Messenger*.

GALILEE (Heb. גליל, "border" or "ring," Gr. Γαλιλαία), a Roman province of Palestine north of Samaria, bounded S. by Samaria and the Carmel range, E. by the Jordan, N. by the Leontes (Litāni), and W. by the Mediterranean and part of Phoenicia. Its maximum extent was about 60 m. north to south and 30 east to west. The name in the Hebrew Scriptures hardly had a definite territorial significance. It literally means a ring or circuit, and, like analogous words in English, could be applied to various districts. Thus Joshua (xiii. 2) and Joel (iii. 4) refer to the *Geliloth* ("borders, coast") of the Philistines or of Palestine; Joshua again (xxii. 10, 11) and Ezekiel (xlvii. 8) mention the Jordan valley plain as the "Geliloth of Jordan" in "the Eastern Gelilah." In its more restricted connotation, denoting the district to which it is usually applied or a part thereof, it is found in Joshua xx. 7, xxi. 32, 1 Chr. vi. 76, as the place where was situated the town of Kadash; and in 1 Kings ix. 11, the district of "worthless" cities given by Solomon to Hiram. In Isa. ix. 1 we find the full name of the district, Galil ha-Goyim, literally "the ring, circuit or border of the foreigners"—referring to the Phoenicians, Syrians and Aramaeans, by whose country the province was on three sides surrounded. In 1 Kings xv. 29 it is specified as one of the districts whose population was deported by Tiglath-Pileser. Throughout the Old Testament history, however, Galilee as a whole cannot be said to have a history; the unit of territorial subdivision was tribal rather than provincial, and though such important events as those associated with the names of Barak, Gideon, Gilboa, Armageddon, took place within its borders, yet these belong rather to the histories of Issachar, Zebulun, Asher or Naphtali, whose territories together almost correspond with Galilee, than to the province itself.

After the Jewish return from exile the population confined itself to Judaea, and Galilee was left in the possession of the mixed multitude of successors established there by the Assyrians. When it once more came into Israelite hands is uncertain; it is generally supposed that its reconquest was due to John Hyrcanus. Before very long it developed a nationalism and patriotism as intense as that of Judaea itself, notwithstanding the contempt with which the metropolitans of Jerusalem looked down upon the Galilean provincials. Stock proverbial sayings such as "Out of Galilee cometh no prophet" (though Deborah, Jonah, Elisha, and probably Hosea, were Galileans) were apparently common. Provincialism of speech (Matt. xxvi. 73) distinguished the Galileans; it appears that they confused the gutturals in pronunciation.

Under the Roman domination Galilee was made a tetrarchate governed by members of the Herod family. Herod the Great was tetrarch of Galilee in 47 B.C.; in 4 B.C. he was succeeded by his son Antipas. Galilee was the land of Christ's boyhood and the chief centre of His active work, and in His various ministries here some of His chief discourses were uttered (as the Sermon on the Mount, Matt. v.) and some of His chief miracles performed.

After the destruction of Jerusalem the Judean Rabbinic schools took refuge in the Galilee they had heretofore despised. No ancient remains of Jewish synagogues exist except those that have been identified in some of the ancient Galilean towns, such as Tell Hum (Talḥūm), Kerāzeh, Kefr Bir'im, and elsewhere. One of the chief centres of Rabbinism was Safed, still a sacred city of the Jews and largely inhabited by members of that faith. Near here is Meirūn, a place much revered by the Jews as containing the tombs of Hillel, Shammai and Simon ben Yoḥai; a yearly festival in honour of these rabbis is here celebrated. At Tiberias also are the tombs of distinguished Jewish teachers, including Maimonides.

The province was subdivided into two parts, Upper and Lower Galilee, the two being divided by a ridge running west to east, which prolonged would cut the Jordan about midway between Hüleh and the Sea of Galilee. Lower Galilee includes the plains of Buttauf and Esdraelon.

The whole of Galilee presents country more or less disturbed by volcanic action. In the lower division the hills are all tilted up towards the east, and broad streams of lava have flowed over the plateau above the sea of Galilee. In this district the highest hills are only about 1800 ft. above the sea. The ridge of Nazareth rises north of the great plain of Esdraelon, and

Lower
Galilee.

north of this again is the fertile basin of the Buttauf, separated from the sea-coast plains by low hills. East of the Buttauf extends the basaltic plateau called Sahel el Ahmā ("the inaccessible plain"), rising 1700 ft. above the Sea of Galilee. North of the Buttauf is a confused hill country, the spurs falling towards a broad valley which lies at the foot of the mountains of Upper Galilee. This broad valley, running westwards to the coast, is perhaps the old boundary of Zebulun—the valley of Jiphthah-el (Josh. xix. 14). The great plain of Esdraelon is of triangular form, bounded by Gilboa on the east and by the ridge which runs to Carmel on the west. It is 14 m. long from Jenin to the Nazareth hills, and its southern border is about 20 m. long. It rises 200 ft. above the sea, the hills on both sides being some 1500 ft. higher. The whole drainage is collected by the Kishon, which runs through a narrow gorge at the north-west corner of the plain, descending beside the ridge of Carmel to the sea. The broad valley of Jezreel on the east, descending towards the Jordan valley, forms the gate by which Palestine is entered from beyond Jordan. Mount Tabor stands isolated in the plain at the north-east corner, and rather farther south the conical hill called Nebi Dupi rises between Tabor and Gilboa. The whole of Lower Galilee is well watered. The Kishon is fed by springs from near Tabor and from a copious stream from the west side of the plain of Esdraelon. North-west of Nazareth is Wādi el Melek, an open valley full of springs. The river Belus, just south of Acre, rising in the sea-coast marshes, drains the whole valley above identified with Jiphthah-el. On the east the broad valley of Jezreel is full of magnificent springs, many of which are thermal. The plains of Esdraelon, and the Buttauf, and the plateau of el-Ahmā are all remarkable for the rich basaltic soil which covers them, in which corn, cotton, maize, sesame, tobacco, millet and various kinds of vegetable are grown, while indigo and sugar-cane were cultivated in former times. The Nazareth hills and Gilboa are bare and white, but west of Nazareth is a fine oak wood, and another thick wood spreads over the northern slopes of Tabor. The hills west of the great plain are partly of bare white chalk, partly covered with dense thickets. The mountains north of the Buttauf are rugged and covered with scrub, except near the villages, where fine olive groves exist. The principal places of importance in Lower Galilee are Nazareth (10,000 inhabitants), Sepphoris (now Saffuria), a large village standing above the Buttauf on the spurs of the southern hills, and Jenin (En Gannim), a flourishing village, with a palm garden (3000 inhabitants). The ancient capital, Jezreel (Zerin), is now a miserable village on a precipitous spur of Gilboa; north of this are the small mud hamlets, Salam (Shunem), Endir (Endor), Nein (Nain); on the west side of the plain is the ruin of Lejūn (the Legion of the 4th century, which was then a place of importance). In the hills north of the Buttauf is Jéfāt, situated on a steep hill-top, and representing the Jotapata defended by Josephus. Kefr Kenna, now a flourishing Christian village at the foot of the Nazareth hills, south of the Buttauf, is one of the sites identified with Cana of Galilee, and the ruin Kāna, on the north side of the same plain, represents the site pointed out to the pilgrims of the 12th and 13th centuries.

The mountains are tilted up towards the Sea of Galilee, and the drainage of the district is towards the north-west. On the south the rocky range of Jebel Jarmūk rises to nearly 4000 ft. above the sea; on the east a narrow ridge 2800 ft. high forms the watershed, with steep eastern slopes falling towards Jordan. Immediately west of the watershed are two small plateaus covered with basaltic debris, near el-Jish and Kades. On the west are rugged mountains with deep intricate valleys. The main drains of the country are—first, Wādi el 'Aydın, rising north of Jebel Jarmūk, and running north-west as an open valley; and secondly, Wādi el Ahjār, a rugged precipitous gorge running north to join the Leontes. The district is well provided with springs throughout, and the valleys are full of water in the spring-time. Though rocky and difficult, Upper Galilee is not barren, the soil of the plateaus is rich, and the vine flourishes in the higher hills, especially in the neighbourhood of Kefr Bir'im. The principal town is Safed, perched on a white mountain 2700 ft. above the sea. It has a population of about 9000, including Jews, Christians and Moslems.

Josephus gives a good description of the Galilee of his time in *Wars*, iii. 3. 2: "The Galileans are inured to war from their infancy, and have been always very numerous; nor hath the country been ever destitute of men of courage or wanted a numerous set of them; for their soil is universally rich and fruitful, and full of plantations of trees of all sorts, inasmuch that it invites the most slothful to take pains in its cultivation. . . . Moreover, the cities lie here very thick, and the very many villages there are here are everywhere full of people." Though the population is diminished and the cities ruinous, the country is still remarkable for fertility, thanks to the copiousness of its water-supply draining from the Lebanon mountains.

The principal products of the country are corn, wine, oil and soap (from the olives), with every species of pulse and gourd.

The antiquities of Galilee include dolmens and rude stone

monuments, rock-cut tombs, and wine-presses, with numerous remains of Byzantine monasteries and fine churches of the time of the crusades. There are also remains of Greek architecture in various places; but the most interesting buildings are the ancient synagogues, of which some eleven examples are now known. They are rectangular, with the door to the south, and two rows of columns forming aisles east and west. The architecture is a peculiar and debased imitation of classic style, attributed by architects to the 2nd century A.D. In Kefr Bir'im there were remains of two synagogues, but early in the 20th century one of them was completely destroyed by a local stone-mason. At Irbid, above Tiberias, is another synagogue of rather different character. Traces of synagogues have also been found on Carmel, and at Tireh, west of Nazareth. It is curious to find the representation of various animals in relief on the lintels of these buildings. Hebrew inscriptions also occur, and the carved work of the cornices and capitals is rich though debased.

In the 12th century Galilee was the outpost of the Christian kingdom of Jerusalem, and its borders were strongly protected by fortresses, the magnificent remains of which still crown the most important strategical points. Toron (mod. *Tibetia*) was built in 1104, the first fortress erected by the crusaders, and standing on the summit of the mountains of Upper Galilee. Beauvoir (Kaukab el-Hawa, built in 1182) stood on a precipice above Jordan south-west of the Sea of Galilee, and guarded the advance by the valley of Jezreel; and about the same time Château Neuf (Hunin) was erected above the Hüleh lake. Belfort (esh Shukif), on the north bank of the Leontes, the finest and most important, dates somewhat earlier; and Montfort (Kalat el Kurn) stood on a narrow spur north-east of Acre, completing the chain of frontier fortresses. The town of Banias, with its castle, formed also a strong outpost against Damascus, and was the scene, in common with the other strongholds, of many desperate encounters between Moslems and Christians. Lower Galilee was the last remaining portion of the Holy Land held by the Christians. In 1250 the knights of the Teutonic order owned lands extending round Acre as far east as the Sea of Galilee, and including Safed. These possessions were lost in 1201, on the fall of Acre.

The population of Galilee is mixed. In Lower Galilee the peasants are principally Moslem, with a sprinkling of Greek Christians round Nazareth, which is a Christian town. In Upper Galilee, however, there is a mixture of Jews and Maronites, Druses and Moslems (natives or Algerine settlers), while the slopes above the Jordan are inhabited by wandering Arabs. The Jews are engaged in trade, and the Christians, Druses and Moslems in agriculture; and the Arabs are an entirely pastoral people.

(C. R. C.; R. A. S. M.)

GALILEE, an architectural term sometimes given to a porch or chapel which formed the entrance to a church. This is the case at Durham and Ely cathedrals, and in Lincoln cathedral the name is sometimes given to the south-west porch. The name is said to be derived from the scriptural expression "Galilee of the Gentiles" (Matt. iv. 15). Galilees are supposed to have been used sometimes as courts of law, but they probably served chiefly for penitents not yet admitted to the body of the church. The Galilee would also appear to have been the vestibule of an abbey church where women were allowed to see the monks to whom they were related, or from which they could hear divine service. The foundation of what is considered to have been a Galilee exists at the west end of Fountains Abbey. Sometimes also corpses were placed there before interment.

GALILEE, SEA OF, a lake in Palestine consisting of an expansion of the Jordan, on the latitude of Mt. Carmel. It is 13 m. long, 8 m. broad, 64 sq. m. in area, 680 ft. below the level of the Mediterranean, and, according to Merrill and Barrois (who have corrected the excessive depth said to have been found by Lortet at the northern end), 150 ft. in maximum depth. It is pear-shaped, the narrow end pointing southward. In the Hebrew Scriptures it is called the Sea of Chinnereth or Chinneroth (probably derived from a town of the same name mentioned in Joshua xi. 2 and elsewhere; the etymology that connects it with *gā*, "a harp," is very doubtful.) In Josephus and the book of

Maccabees it is named Gennesar; while in the Gospels it is usually called Sea of Galilee, though once it is called Lake of Gennesaret (Luke v. 1) and twice Sea of Tiberias (John vi. 1, xxi. 1). The modern Arabic name is *Baḥr Tubariya*, which is often rendered "Lake of Tiberias." Pliny refers to it as the Lake of Taricheae.

Like the Dead Sea it is a "rift" lake, being part of the great fault that formed the Jordan-Araba depression. Deposits show that originally it formed part of the great inland sea that filled this depression in Pleistocene times. The district on each side of the lake has a number of hot springs, at least one of which is beneath the sea itself, and has always shown indications of volcanic and other subterranean disturbances. It is especially liable to earthquakes. The water of the sea, though slightly brackish and not very clear, is generally used for drinking. The shores are for the greater part formed of fine gravel; some yards from the shore the bed is uniformly covered with fine greyish mud. The temperature in summer is tropical, but after noon falls about 10° F. owing to strong north-west winds. This range of temperature affects the water to a depth of about 40 ft.; below that depth the water is uniformly about 59° F. The sea is set deep in hills which rise on the east side to a height of about 2000 ft. Sudden and violent storms (such as are described in Matt. viii. 23, xiv. 22, and the parallel passages) are often produced by the changes of temperature in the air resulting from these great differences of level.

The Sea of Galilee is best seen from the top of the western precipices. It presents a desolate appearance. On the north the hills rise gradually from the shore, which is fringed with oleander bushes and indented with small bays. The ground is here covered with black basalt. On the west the plateau known as Sahel el-Ahna terminates in precipices 1700 ft. above the lake, and over these the black rocky tops called "the Horns of Hattin" are conspicuous objects. On the south is a broad valley through which the Jordan flows. On the east are furrowed and rugged slopes, rising to the great plateau of the Jaulān (Gaulonitis). The Jordan enters the lake through a narrow gorge between lower hills. A marshy plain, 2½ m. long and 1½ broad, called el-Batihah, exists immediately east of the Jordan inlet. There is also on the west side of the lake a small plain called el-Chuweir, formed by the junction of three large valleys. It measures 3½ m. along the shore, and is 1 m. wide. This plain, naturally fertile, but now almost uncultivated, is supposed to be the plain of Gennesareth, described by Josephus (*B. J.* iii. 10, 8). On the east the hills approach in one place within 40 ft. of the water, but there is generally a width of about ¼ of a mile from the hills to the beach. On the west the flat ground at the foot of the hills has an average width of about 200 yds. A few scattered palms dot the western shores, and a palm grove is to be found near Keif Hārīb on the south-east. The hot baths south of Tiberias include several springs, the largest of which has a temperature of 137° F. In these springs a distinct rise in temperature was observed in 1837, when Tiberias and Safed were destroyed by an earthquake. The plain of Gennesareth, with its environs, is the best-watered part of the lake-basin. North of this plain are the five springs of et-Tabighah, the largest of which was enclosed about a century ago in an octagonal reservoir by 'Alī, son of Dhahr el-Amīr, and the water led off by an aqueduct 52 ft. above the lake. The Tabighah springs, though abundant, are warm and brackish. At the north end of the plain is 'Ain et-Tinch ("spring of the fig-tree"), also a brackish spring with a good stream; south of the plain is 'Ain el-Bardēh ("the cold spring"), which is sweet, but scarcely lower in temperature than the others. One of the most important springs is 'Ain el-Madawwera ("the round spring"), situated 1 m. from the south end of the plain and half a mile from the shore. The water rises in a circular well 32 ft. in diameter, and is clear and sweet, with a temperature of 73° F. The bottom is of loose sand, and the fish called *coracinus* by Josephus (*B. J.* iii. 10, 8) is here found (see below). Dr Tristram was the first explorer to identify this fish, and on account of its presence suggested the identification of the "round spring" with the fountain of *Capharnaum*, which, according to Josephus, watered the plain of Gennesareth. There is, however, a difficulty in this identification; there are no ruins at 'Ain el-Madawwera.

Fauna and Flora.—For half the year the hillsides are bare and steppe-like, but in spring are clothed with a subtropical vegetation. Oleanders flourish round the lake, and the large papyrus grows at 'Ain et-Tin as well as at the mouth of the Jordan. The lake swarms with fish, which are caught with nets by a guild of fishermen, whose boats are the only representatives of the many ships and boats which plied on the lake as late as the 10th century. Fishing was a lucrative industry at an early date, and the Jews ascribed the laws regulating it to Joshua. The fish, which were classed as clean and unclean, the good and bad of the parable (Matt. xiii. 47, 48), belong to the genera *Chromis*, *Barbus*, *Capoeta*, *Discognathus*, *Nemachilus*,

Blennius and *Clarias*; and there is a great affinity between them and the fish of the East African lakes and streams. There are eight species of *Chromis*, most of which hatch their eggs and raise their young in the buccal cavities of the males. The *Chromis simonis* is popularly supposed to be the fish from which Peter took the piece of money (Matt. xvii. 27). *Clarias macracanthus* (Arab. *Burḥu*) is the *coracinus* of Josephus. It was found by Lortet in the springs of 'Ain el-Madawwera, 'Ain et-Tinch and 'Ain et-Tabighah, on the lake shore where muddy, and in Lake Hulch. It is a scaleless, snake-like fish, often nearly 5 ft. long, which resembles the *C. anguillaris* of Egypt. From the absence of scales it was held by the Jews to be unclean, and some commentators suppose it to be the serpent of Matt. vii. 10 and Luke xi. 11. Large numbers of grebes—great crested, eared, and little,—gulls and pelicans frequent the lake. On its shores are tortoises, mud-turtles, crayfish and innumerable sand-hoppers; and at varying depths in the lake several species of *Melania*, *Melanopsis*, *Neritina*, *Corbicula* and *Unio* have been found.

Antiquities.—The principal sites of interest round the lake may be enumerated from north to west and from south to east. Kerazeh, the undoubted site of Chorazin, stands on a rocky spur 900 ft. above the lake, 2 m. north of the shore. Foundations and scattered stones cover the slopes and the flat valley below. On the west is a rugged gorge. In the middle of the ruins are the scattered remains of a synagogue of richly ornamental style built of black basalt. A small spring occurs on the north. Tell Hūm (as the name is generally spelt, though *Talḥam* would probably be preferable for several reasons) is an important ruin on the shore, south of the last-mentioned site. The remains consist of foundations and piles of stones (in spring concealed by gigantic thistles) extending about half a mile along the shore. The foundations of a fine synagogue, measuring 75 ft. by 57, and built in white limestone, have been excavated. A conspicuous building has been erected close to the water, from the fragments of the Tell Hūm synagogue. Since the 4th century Tell Hūm has been pointed out by all the Christian writers of importance as the site of Capernaum. Some modern geographers question this identification, but without sufficient reason (see *CAPERNAUM*). Minyeh is a ruined site at the north end of the plain of Gennesareth, 2½ m. from the lake, and close to the shore. There are extensive ruins on flat ground, consisting of mounds and foundations. Masonry of well-dressed stones has also been here discovered in course of excavation. Near the ruins are remains of an old khān, which appears to have been built in the middle ages. This is another suggested identification for Capernaum; but all the remains belong to the Arab period. Between Tell Hūm and Minyeh is *Tell 'Oreimeh*, the site of a forgotten Amorite city.

South of the supposed plain of Gennesareth is Mejdel, commonly supposed to represent the New Testament town of Magdala. A few lotus trees and some rock-cut tombs are here found beside a miserable mud hamlet on the hill slope, with a modern tomb-house (*kubbeh*). Passing beneath rugged cliffs a recess in the hills is next reached, where stands Tubariya, the ancient Tiberias or Rakkath, containing 3000 inhabitants, more than half of whom are Jews. The walls, flanked with round towers, but partly destroyed by the earthquake of 1837, were built by Dhahr el-Amīr, as was the court-house. The two mosques, now partly ruinous, were erected by his sons. There are remains of a Crusaders' church, and the tomb of the celebrated Maimonides is shown in the town, while Rabbi Aqiba and Rabbi Meir lie buried outside. The ruins of the ancient city, including granite columns and traces of a sea-wall with towers, stretch southwards a mile beyond the modern town. An aqueduct in the cliff once brought water a distance of 9 m. from the south.

Kerak, at the south end of the lake, is an important site on a peninsula surrounded by the water of the lake, by the Jordan, and by a broad water ditch, while on the north-west a narrow neck of land remains. The plateau thus enclosed is partly artificial, and banked up 50 or 60 ft. above the water. A ruined citadel remains on the north-west, and on the east was a bridge over the Jordan; broken pottery and fragments of sculptured stone strew the site. The ruin of Kerak answers to the description given by Josephus of the city of Taricheae, which lay 30 stadia from Tiberias, the hot baths being between the two cities. Taricheae was situated, as is Kerak, on the shore below the cliffs, and partly surrounded by water, while before the city was a

plain (the Ghor). Pliny further informs us that Taricheae was at the south end of the Sea of Galilee. *Sinn en-Nabreh*, a ruin on a spur of the hills close to the last-mentioned site, represents the ancient Sennabris, where Vespasian (Josephus, *B.J.* iii. 9, 7) fixed his camp, advancing from Scythopolis (Beisan) on Taricheae and Tiberias. Sennabris was 30 stadia from Tiberias, or about the distance of the ruin now existing.

The eastern shores of the Sea of Galilee have been less fully explored than the western, and the sites are not so perfectly recovered. The site of Hippos, one of the cities of Decapolis, is fixed by Clermont-Ganneau at Khurbet Susich. Kalat el-Hosr ("castle of the stronghold") is a ruin on a rocky spur opposite Tiberias. Two large ruined buildings remain, with traces of an old street and fallen columns and capitals. A strong wall once surrounded the town; a narrow neck of land exists on the east where the rock has been scarped. Rugged valleys enclose the site on the north and south; broken sarcophagi and rock-cut tombs are found beneath the ruin. This site is not identified; the suggestion that it is Gamala is doubtful, and not borne out by Josephus (*War*, iv. 1, 1), who says Gamala was over against Taricheae. Kersa, an insignificant ruin north of the last, is thought to represent the Gerasa or Gergesa of the 4th century, situated east of the lake; and the projecting spur of hill south of this ruin is conjectured to be the place where the swine "ran violently down a steep place" (*Matt.* viii. 32).

(C. R. C.; C. W. W.; R. A. S. M.)

GALILEO GALILEI (1564-1642), Italian astronomer and experimental philosopher, was born at Pisa on the 15th of February 1564. His father, Vincenzio, was an impoverished descendant of a noble Florentine house, which had exchanged the surname of Bonajuti for that of Galilei, on the election, in 1343, of one of its members, Tommaso de' Bonajuti, to the college of the twelve Buonuomini. The family, which was nineteen times represented in the signoria, and in 1445 gave a gonfalonier to Florence, flourished with the republic and declined with its fall. Vincenzio Galilei was a man of better parts than fortune. He was a competent mathematician, wrote with considerable ability on the theory and practice of music, and was especially distinguished amongst his contemporaries for the grace and skill of his performance upon the lute. By his wife, Giulia Ammannati di Pescia, he had three sons and four daughters.

From his earliest childhood Galileo, the eldest of the family, was remarkable for intellectual aptitude as well as for mechanical invention. His favourite pastime was the construction of original and ingenious toy-machines; but his application to literary studies was equally conspicuous. In the monastery of Vallombrosa, near Florence, where his education was principally conducted, he not only made himself acquainted with the best Latin authors, but acquired a fair command of the Greek tongue, thus laying the foundation of his brilliant and elegant style. From one of the monks he also received instruction in logic; but the subtleties of the scholastic science were thoroughly distasteful to him. A document published by F. Selmi in 1864 proves that he was at this time so far attracted towards a religious life as to have joined the novitiate; but his father, who had other designs for him, seized the opportunity of an attack of ophthalmia to withdraw him permanently from the care of the monks. Having had personal experience of the unremunerative character both of music and of mathematics, he desired that his son should apply himself to the cultivation of medicine, and, not without some straining of his slender resources, placed him, before he had completed his eighteenth year, at the university of Pisa. He accordingly matriculated there on the 5th of November 1581, and immediately entered upon attendance at the lectures of the celebrated physician and botanist, Andrea Cesalpino.

The natural gifts of the young student seemed at this time equally ready to develop in any direction towards which choice or hazard might incline them. In musical skill and invention he already vied with the best professors of the art in Italy; his personal taste would have led him to choose painting as his profession, and one of the most eminent artists of his day, *Lodovico Cigoli*, owned that to his judgment and counsel he was

mainly indebted for the success of his works. In 1581, while watching a lamp set swinging in the cathedral of Pisa, he observed that, whatever the range of its oscillations, they were invariably executed in equal times. The experimental verification of this fact led him to the important discovery of the isochronism of the pendulum. He at first applied the new principle to pulse-measurement, and more than fifty years later turned it to account in the construction of an astronomical clock. Up to this time he was entirely ignorant of mathematics, his father having carefully held him aloof from a study which he rightly apprehended would lead to his total alienation from that of medicine. Accident, however, frustrated this purpose. A lesson in geometry, given by Ostilio Ricci to the pages of the grand-ducal court, chanced, tradition avers, to have Galileo for an unseen listener; his attention was riveted, his dormant genius was roused, and he threw all his energies into the new pursuit thus unexpectedly presented to him. With Ricci's assistance, he rapidly mastered the elements of the science, and eventually extorted his father's reluctant permission to exchange Hippocrates and Galen for Euclid and Archimedes. In 1585 he was withdrawn from the university, through lack of means, before he had taken a degree, and returned to Florence, where his family habitually resided. We next hear of him as lecturing before the Florentine Academy on the site and dimensions of Dante's *Inferno*; and he shortly afterwards published an essay descriptive of his invention of the hydrostatic balance, which rapidly made his name known throughout Italy. His first patron was the Marchese Guidubaldo del Monte of Pesaro, a man equally eminent in science, and influential through family connexions. At the Marchese's request he wrote, in 1588, a treatise on the centre of gravity in solids, which obtained for him, together with the title of "the Archimedes of his time," the honourable though not lucrative post of mathematical lecturer at the Pisan university. During the ensuing two years (1589-1591) he carried on that remarkable series of experiments by which he established the first principles of dynamics and earned the undying hostility of bigoted Aristotelians. From the leaning tower of Pisa he afforded to all the professors and students of the university ocular demonstration of the falsehood of the Peripatetic dictum that heavy bodies fall with velocities proportional to their weights, and with unanswerable logic demolished all the time-honoured maxims of the schools regarding the motion of projectiles, and elemental weight or levity. But while he convinced, he failed to conciliate his adversaries. The keen sarcasm of his polished rhetoric was not calculated to soothe the susceptibilities of men already smarting under the deprivation of their most cherished illusions. He seems, in addition, to have compromised his position with the grand-ducal family by the imprudent candour with which he condemned a machine for clearing the port of Leghorn, invented by Giovanni de' Medici, an illegitimate son of Cosmo I. Princely favour being withdrawn, private rancour was free to show itself. He was publicly hissed at his lecture, and found it prudent to resign his professorship and withdraw to Florence in 1591. Through the death of his father in July of that year family cares and responsibilities devolved upon him, and thus his nomination to the chair of mathematics at the university of Padua, secured by the influence of the Marchese Guidubaldo with the Venetian senate, was welcome both as affording a relief from pecuniary embarrassment and as opening a field for scientific distinction.

His residence at Padua, which extended over a period of eighteen years, from 1592 to 1610, was a course of uninterrupted prosperity. His appointment was three times renewed, on each occasion with the expressions of the highest esteem on the part of the governing body, and his yearly salary was progressively raised from 180 to 1000 florins. His lectures were attended by persons of the highest distinction from all parts of Europe, and such was the charm of his demonstrations that a hall capable of containing 2000 people had eventually to be assigned for the accommodation of the overflowing audiences which they attracted. His invention of the proportional compass or sector—an implement still used in geometrical drawing—dates from 1597; and about the same time he constructed the first thermometer, consisting of a bulb

and tube filled with air and water, and terminating in a vessel of water. In this instrument the results of varying atmospheric pressure were not distinguishable from the expansive and contractive effects of heat and cold, and it became an efficient measure of temperature only when Rinieri, in 1646, introduced the improvement of hermetically sealing the liquid in glass. The substitution, in 1670, of mercury for water completed the modern thermometer.

Galileo seems, at an early period of his life, to have adopted the Copernican theory of the solar system, and was deterred from avowing his opinions—as is proved by his letter to Kepler of August 4, 1597—by the fear of ridicule rather than of persecution. The appearance, in September 1604, of a new star in the constellation Serpentarius afforded him indeed an opportunity, of which he eagerly availed himself, for making an onslaught upon the Aristotelian axiom of the incorruptibility of the heavens; but he continued to conform his public teachings in the main to Ptolemaic principles, until the discovery of a novel and potent implement of research in the shape of the telescope (*q.v.*) placed at his command startling and hitherto unsuspected evidence as to the constitution and mutual relations of the heavenly bodies. Galileo was not the original inventor of the telescope.¹ That honour must be assigned to Johannes Lippershey, an obscure optician of Middleburg, who, on the 2nd of October 1608, petitioned the states-general of the Low Countries for exclusive rights in the manufacture of an instrument for increasing the apparent size of remote objects. A rumour of the new invention, which reached Venice in June 1609, sufficed to set Galileo on the track; and after one night's profound meditation on the principles of refraction, he succeeded in producing a telescope of threefold magnifying power. Upon this first attempt he rapidly improved, until he attained to a power of thirty-two, and his instruments, of which he manufactured hundreds with his own hands, were soon in request in every part of Europe. Two lenses only—a plano-convex and a plano-concave—were needed for the composition of each, and this simple principle is that still employed in the construction of opera-glasses. Galileo's direction of his new instrument to the heavens formed an era in the history of astronomy. Discoveries followed upon it with astounding rapidity and in bewildering variety. The *Sidercus Nuncius*, published at Venice early in 1610, contained the first-fruits of the new mode of investigation, which were sufficient to excite learned amazement on both sides of the Alps. The mountainous configuration of the moon's surface was there first described, and the so-called "phosphorescence" of the dark portion of our satellite attributed to its true cause—namely, illumination by sunlight reflected from the earth.² All the time-worn fables and conjectures regarding the composition of the Milky Way were at once dispipated by the simple statement that to the eye, reinforced by the telescope, it appeared as a congeries of lesser stars, while the great nebulae were equally declared to be resolvable into similar elements. But the discovery which was at once perceived to be most important in itself, and most revolutionary in its effects, was that of Jupiter's satellites, first seen by Galileo on the 7th of January 1610, and by him named *Sidera Medicea*, in honour of the grand-duke of Tuscany, Cosmo II., who had been his pupil, and was about to become his employer. An illustration is, with the general run of mankind, more powerful to convince than an argument; and the cogency of the visible plea for the Copernican theory offered by the miniature system, then first disclosed to view, was recognizable in the triumph of its advocates as well as in the increased acrimony of its opponents.

In September 1610 Galileo finally abandoned Padua for Florence. His researches with the telescope had been rewarded

¹ The word *telescope*, from *τῆλε*, far, *σκοπεῖν*, to view, was invented by Demiscianus, an eminent Greek scholar, at the request of Prince Cesi, president of the Lyncean Academy. It was used by Galileo as early as 1612, but was not introduced into England until much later. In 1655 the word *telescope* was inserted and explained in Bagwell's *Mysteries of Astronomy*, *trunk* or *cylinder* being the terms until then ordinarily employed.

² Leonardo da Vinci, more than a hundred years earlier, had come to the same conclusion.

by the Venetian senate with the appointment for life to his professorship, at an unprecedentedly high salary. His discovery of the "Medicean Stars" was acknowledged by his nomination (July 12, 1610) as philosopher and mathematician extraordinary to the grand-duke of Tuscany. The emoluments of this office, which involved no duties save that of continuing his scientific labours, were fixed at 1000 scudi; and it was the desire of increased leisure, rather than the promptings of local patriotism, which induced him to accept an offer the original suggestion of which had indeed come from himself. Before the close of 1610 the memorable cycle of discoveries begun in the previous year was completed by the observation of the ansated or, as it appeared to Galileo, triple form of Saturn (the ring-formation was first recognized by Christiaan Huygens in 1655), of the phases of Venus, and of the spots upon the sun. As regards sun-spots, however, Johann Fabricius of Oostel in Friesland can claim priority of publication, if not of actual detection. In the spring of 1611 Galileo visited Rome, and exhibited in the gardens of the Quirinal Palace the telescopic wonders of the heavens to the most eminent personages at the pontifical court. Encouraged by the flattering reception accorded to him, he ventured, in his *Letters on the Solar Spots*, printed at Rome in 1613, to take up a more decided position towards that doctrine on the establishment of which, as he avowed in a letter to Belisario Vinta, secretary to the grand-duke, "all his life and being henceforward depended." Even in the time of Copernicus some well-meaning persons, especially those of the reformed persuasion, had suspected a discrepancy between the new view of the solar system and certain passages of Scripture—a suspicion strengthened by the anti-Christian inferences drawn from it by Giordano Bruno; but the question was never formally debated until Galileo's brilliant disclosures, enhanced by his formidable dialectic and enthusiastic zeal, irresistibly challenged for it the attention of the authorities. Although he had no desire to raise the theological issue, it must be admitted that, the discussion once set on foot, he threw himself into it with characteristic impetuosity, and thus helped to precipitate a decision which it was his interest to avert. In December 1643 a Benedictine monk named Benedetto Castelli, at that time professor of mathematics at the university of Pisa, wrote to inform Galileo of a recent discussion at the grand-ducal table, in which he had been called upon to defend the Copernican doctrine against theological objections. This task Castelli, who was a steady friend and disciple of the Tuscan astronomer, seems to have discharged with moderation and success. Galileo's answer, written, as he said himself, *currente calamo*, was an exposition of a formal theory as to the relations of physical science to Holy Writ, still further developed in an elaborate apology addressed by him in the following year (1614) to Christina of Lorraine, dowager grand-duchess of Tuscany. Not satisfied with explaining adverse texts, he met his opponents with unwise audacity on their own ground, and endeavoured to produce scriptural confirmation of a system which seemed to the ignorant many an incredible paradox, and to the scientific few a beautiful but daring innovation. The rising agitation on the subject, fomented for their own purposes by the rabid Aristotelians of the schools, was heightened rather than allayed by these manifestoes, and on the fourth Sunday of the following Advent found a voice in the pulpit of Santa Maria Novella. Padre Caccini's denunciation of the new astronomy was indeed disavowed and strongly condemned by his superiors; nevertheless, on the 5th of February 1615, another Dominican monk named Lorini laid Galileo's letter to Castelli before the Inquisition.

Cardinal Robert Bellarmine was at that time by far the most influential member of the Sacred College. He was a man of vast learning and upright piety, but, although personally friendly to Galileo, there is no doubt that he saw in his scientific teachings a danger to religion. The year 1615 seems to have been a period of suspense. Galileo received, as the result of a conference between Cardinals Bellarmine and Del Monte, a semi-official warning to avoid theology, and limit himself to physical reasoning. "Write freely," he was told by Monsignor Dini, "but keep outside the

sacristy." Unfortunately, he had already committed himself to dangerous ground. In December he repaired personally to Rome, full of confidence that the weight of his arguments and the vivacity of his eloquence could not fail to convert the entire pontifical court to his views. He was cordially received, and eagerly listened to, but his imprudent ardour served but to injure his cause. On the 24th of February 1616 the consulting theologians of the Holy Office characterized the two propositions—that the sun is immovable in the centre of the world, and that the earth has a diurnal motion of rotation—the first as "absurd in philosophy, and formally heretical, because expressly contrary to Holy Scripture," and the second as "open to the same censure in philosophy, and at least erroneous as to faith." Two days later Galileo was, by command of the pope (Paul V.), summoned to the palace of Cardinal Bellarmín, and there officially admonished not thenceforward to "hold, teach or defend" the condemned doctrine. This injunction he promised to obey. On the 5th of March the Congregation of the Index issued a decree reiterating, with the omission of the word "heretical," the censure of the theologians, suspending, *usque corrigatur*, the great work of Copernicus, *De revolutionibus orbium coelestium*, and absolutely prohibiting a treatise by a Carmelite monk named Foscarini, which treated the same subject from a theological point of view. At the same time it was given to be understood that the new theory of the solar system might be held *ex hypothesi*, and the trivial verbal alterations introduced into the Polish astronomer's book in 1620, when the work of revision was completed by Cardinal Gaetani, confirmed this interpretation. This edict, it is essential to observe, the responsibility for which rests with a disciplinary congregation in no sense representing the church, was never confirmed by the pope, and was virtually repealed in 1757 under Benedict XIV.

Galileo returned to Florence three months later, not ill-pleased, as his letters testify, with the result of his visit to Rome. He brought with him, for the refutation of calumnious reports circulated by his enemies, a written certificate from Cardinal Bellarmín, to the effect that no abjuration had been required of or penance imposed upon him. During a prolonged audience he had received from the pope assurances of private esteem and personal protection; and he trusted to his dialectical ingenuity to find the means of presenting his scientific convictions under the transparent veil of an hypothesis. Although a sincere Catholic, he seems to have laid but little stress on the secret admonition of the Holy Office, which his sanguine temperament encouraged him gradually to dismiss from his mind. He preserved no written memorandum of its terms, and it was represented to him, according to his own deposition in 1633, solely by Cardinal Bellarmín's certificate, in which, for obvious reasons, it was glossed over rather than expressly recorded. For seven years, nevertheless, during which he led a life of studious retirement in the Villa Segni at Bellosguardo, near Florence, he maintained an almost unbroken silence. At the end of that time he appeared in public with his *Saggiatore*, a polemical treatise written in reply to the *Libra astronomica* of Padre Grassi (under the pseudonym of Lotario Sarsi), the Jesuit astronomer of the Collegio Romano. The subject in debate was the nature of comets, the conspicuous appearance of three of which bodies in the year 1618 furnished the occasion of the controversy. Galileo's views, although erroneous, since he held comets to be mere atmospheric emanations reflecting sunlight after the evanescent fashion of a halo or a rainbow, were expressed with such triumphant vigour, and embellished with such telling sarcasms, that his opponent did not venture upon a reply. The *Saggiatore* was printed at Rome in October 1623 by the Academy of the Lincei, of which Galileo was a member, with a dedication to the new pope, Urban VIII., and notwithstanding some passages containing a covert defence of Copernican opinions, was received with acclamation by ecclesiastical, no less than by scientific authorities.

Everything seemed now to promise a close of unbroken prosperity to Galileo's career. Maffeo Barberini, his warmest friend and admirer in the Sacred College, was, by the election of the 8th of August 1623, seated on the pontifical throne; and the

marked distinction with which he was received on his visit of congratulation to Rome in 1624 encouraged him to hope for the realization of his utmost wishes. He received every mark of private favour. The pope admitted him to six long audiences in the course of two months, wrote an enthusiastic letter to the grand-duke praising the great astronomer, not only for his distinguished learning, but also for his exemplary piety, and granted a pension to his son Vincenzo, which was afterwards transferred to himself, and paid, with some irregularities, to the end of his life. But on the subject of the decree of 1616, the revocation of which Galileo had hoped to obtain through his personal influence, he found him inexorable. Yet there seemed reason to expect that it would at least be interpreted in a liberal spirit, and Galileo's friends encouraged his imprudent confidence by eagerly retailing to him every papal utterance which it was possible to construe in a favourable sense. To Cardinal Hohenzollern, Urban was reported to have said that the theory of the earth's motion had not been and could not be condemned as heretical, but only as rash; and in 1630 the brilliant Dominican monk Tommaso Campanella wrote to Galileo that the pope had expressed to him in conversation his disapproval of the prohibitory decree. Thus, in the full anticipation of added renown, and without any misgiving as to ulterior consequences, Galileo set himself, on his return to Florence, to complete his famous but ill-starred work, the *Dialogo dei due massimi sistemi del mondo*. Finished in 1630, it was not until January 1632 that it emerged from the presses of Landini at Florence. The book was originally intended to appear in Rome, but unexpected obstacles interposed. The Lincean Academy collapsed with the death of Prince Federigo Cesi, its founder and president; an outbreak of plague impeded communication between the various Italian cities; and the *imprimatur* was finally extorted, rather than accorded, under the pressure of private friendship and powerful interest. A tumult of applause from every part of Europe followed its publication; and it would be difficult to find in any language a book in which animation and elegance of style are so happily combined with strength and clearness of scientific exposition. Three interlocutors, named respectively Salviati, Sagredo, and Simplicio, take part in the four dialogues of which the work is composed. The first-named expounds the views of the author; the second is an eager and intelligent listener; the third represents a well-meaning but obtuse Peripatetic, whom the others treat at times with undisguised contempt. Salviati and Sagredo took their names from two of Galileo's early friends, the former a learned Florentine, the latter a distinguished Venetian gentleman; Simplicio ostensibly derived his from the Cilician commentator of Aristotle, but the choice was doubtless instigated by a sarcastic regard to the double meaning of the word. There were not wanting those who insinuated that Galileo intended to depict the pope himself in the guise of the simpleton of the party; and the charge, though preposterous in itself, was supported by certain imprudences of expression, which Urban was not permitted to ignore.

It was at once evident that the whole tenor of this remarkable work was in flagrant contradiction with the edict passed sixteen years before its publication, as well as with the author's personal pledge of conformity to it. The ironical submission with which it opened, and the assumed indetermination with which it closed, were hardly intended to mask the vigorous assertion of Copernican principles which formed its substance. It is a singular circumstance, however, that the argument upon which Galileo mainly relied as furnishing a physical demonstration of the truth of the new theory rested on a misconception. The ebb and flow of the tides were, he asserted, a visible proof of the terrestrial double movement, since they resulted from inequalities in the absolute velocities through space of the various parts of the earth's surface, due to its rotation. To this notion, which took its rise in a confusion of thought, he attached capital importance, and he treated with scorn Kepler's suggestion that a certain occult attraction of the moon was in some way concerned in the phenomenon. The theological censures which the book did not fail to incur were not slow in making themselves felt. Towards

the end of August the sale was prohibited; on the 1st of October the author was cited to Rome by the Inquisition. He pleaded his age, now close upon seventy years, his infirm health, and the obstacles to travel caused by quarantine regulations; but the pope was sternly indignant at what he held to be his ingratitude and insubordination, and no excuse was admitted. At length, on the 13th of February 1633, he arrived at the residence of Niccolini, the Tuscan ambassador to the pontifical court, and there abode in retirement for two months. From the 12th to the 30th of April he was detained in the palace of the Inquisition, where he occupied the best apartments and was treated with unexampled indulgence. On the 30th he was restored to the hospitality of Niccolini, his warm partisan. The accusation against him was that he had written in contravention of the decree of 1616, and in defiance of the command of the Holy Office communicated to him by Cardinal Bellarmine; and his defence consisted mainly in a disavowal of his opinions, and an appeal to his good intentions. On the 21st of June he was finally examined under menace of torture; but he continued to maintain his assertion that after its condemnation by the Congregation of the Index, he had never held the Copernican theory. Since the publication of the documents relating to this memorable trial, there can no longer be any doubt, not only that the threat of torture was not carried into execution, but that it was never intended that it should be. On the 22nd of June, in the church of Santa Maria sopra Minerva, Galileo read his recantation, and received his sentence. He was condemned, as "vehemently suspected of heresy," to incarceration at the pleasure of the tribunal, and by way of penance was enjoined to recite once a week for three years the seven penitential psalms. This sentence was signed by seven cardinals, but did not receive the customary papal ratification. The legend according to which Galileo, rising from his knees after repeating the formula of abjuration, stamped on the ground, and exclaimed, "*Eppur si muove!*" is, as may readily be supposed, entirely apocryphal. Its earliest ascertained appearance is in the Abbé Iraitl's *Querelles littéraires* (vol. iii. p. 49, 1761).

Galileo remained in the custody of the Inquisition from the 21st to the 24th of June, on which day he was relegated to the Villa Medici on the Trinità de' Monti. Thence, on the 6th of July, he was permitted to depart for Siena, where he spent several months in the house of the archbishop, Ascanio Piccolomini, one of his numerous and trusty friends. It was not until December that his earnest desire of returning to Florence was realized, and the remaining eight years of his life were spent in his villa at Arcetri called "Il Gioiello," in the strict seclusion which was the prescribed condition of his comparative freedom. Domestic afflictions combined with numerous and painful infirmities to embitter his old age. His sister-in-law and her whole family, who came to live with him on his return from Rome, perished shortly afterwards of the plague; and on the 2nd of April 1634 died, to the inexpressible grief of her father, his eldest and best-beloved daughter, a nun in the convent of San Matteo at Arcetri. Galileo was never married; but by a Venetian woman named Marina Gamba he had three children—a son who married and left descendants, and two daughters who took the veil at an early age. His prodigious mental activity continued undiminished to the last. In 1636 he completed his *Dialoghi delle nuove scienze*, in which he recapitulated the results of his early experiments and mature meditations on the principles of mechanics. This in many respects his most valuable work was printed by the Elsevirs at Leiden in 1638, and excited admiration equally universal and more lasting than that accorded to his astronomical treatises. His last telescopic discovery—that of the moon's diurnal and monthly librations—was made in 1637, only a few months before his eyes were for ever closed in hopeless blindness. It was in this condition that Milton found him when he visited him at Arcetri in 1638. But the fire of his genius was not even yet extinct. He continued his scientific correspondence with unbroken interest and undiminished logical acumen; he thought out the application of the pendulum to the regulation of clock-work, which Huygens successfully realized fifteen years later;

and he was engaged in dictating to his disciples, Viviani and Torricelli, his latest ideas on the theory of impact when he was seized with the slow fever which in two months brought him to the grave. On the 8th of January 1642 he closed his long life of triumph and humiliation, which just spanned the interval between the death of Michelangelo and the birth of Isaac Newton.

The direct services which Galileo rendered to astronomy are virtually summed up in his telescopic discoveries. To the theoretical perfection of the science he contributed little or nothing. He pointed out indeed that the so-called "third motion," introduced by Copernicus to account for the constant parallelism of the earth's axis, was a superfluous complication. But he substituted the equally unnecessary hypothesis of a magnetic attraction, and failed to perceive that the phenomenon to be explained was, in relation to absolute space, not a movement but the absence of movement. The circumstance, however, which most seriously detracts from his scientific reputation is his neglect of the discoveries made during his lifetime by the greatest of his contemporaries. Kepler's first and second laws were published in 1609, and his third ten years later. By these momentous inductions the geometrical theory of the solar system was perfected, and a hitherto unimagined symmetry was perceived to regulate the mutual relations of its members. But by Galileo they were passed over in silence. In his *Dialogo dei massimi sistemi*, printed not less than thirteen years after the last of the three laws had been given to the world, the epicycles by which Copernicus, adhering to the ancient postulate of uniform circular motion, had endeavoured to reduce to theory the irregularities of the planetary movements, were neither expressly adopted nor expressly rejected; and the conclusion seems inevitable that this grave defection from the cause of progress was due to his perhaps unconscious reluctance to accept discoveries which he had not originated. His name is nevertheless justly associated with that vast extension of the bounds of the visible universe which has rendered modern astronomy the most sublime of sciences, and his telescopic observations are a standing monument to his sagacity and acumen.

With the sure instinct of genius, he seized the characteristic features of the phenomena presented to his attention, and his inferences, except when distorted by polemical exigencies, have been strikingly confirmed by modern investigations. Of his two capital errors, regarding respectively the theory of the tides and the nature of comets, the first was insidiously recommended to him by his passionate desire to find a physical confirmation of the earth's double motion; the second was adopted for the purpose of rebutting an anti-Copernican argument founded on the planetary analogies of those erratic subjects of the sun. Within two years of their first discovery, he had constructed approximately accurate tables of the revolutions of Jupiter's satellites, and he proposed their frequent eclipses as a means of determining longitudes, not only on land, but at sea. This method, on which he laid great stress, and for the facilitation of which he invented a binocular glass, and devised some skillful mechanical contrivances, was offered by him in 1616 to the Spanish government, and afterwards to that of Tuscany, but in each case unsuccessfully; and the close of his life was occupied with prolonged but fruitless negotiations on the same subject with the states-general of Holland. The idea, though ingenious, has been found of little practical utility at sea.

A series of careful observations made him acquainted with the principal appearances revealed by modern instruments in the solar spots. He pointed out that they were limited to a certain defined zone on the sun's surface; he noted the *faculae* with which they are associated, the penumbra by which they are bordered, their slight proper motions and their rapid changes of form. He inferred from the regularity of their general movements the rotation of the sun on its axis in a period of little less than a month; and he grounded on the varying nature of the paths seemingly traversed by them a plausible, though inconclusive, argument in favour of the earth's annual revolution. Twice in the year, he observed, they seem to travel across the solar disk in straight lines; at other times, in curves. These appearances he

referred with great acuteness to the slight inclination of the sun's axis of rotation to the plane of the ecliptic. Thus, when the earth finds herself in the plane of the sun's equator, which occurs at two opposite points of her orbit, the spots, travelling in circles parallel with that plane, necessarily appear to describe right lines; but when the earth is above or below the equatorial level, the paths of the spots open out into curves turned downwards or upwards, according to the direction in which they are seen. But the explanation of this phenomenon is equally consistent with the geocentric as with the heliocentric theory of the solar system. The idea of a universal force of gravitation seems to have hovered on the borders of this great man's mind, without ever fully entering it. He perceived the analogy between the power which holds the moon in the neighbourhood of the earth, and compels Jupiter's satellites to circulate round their primary, and the attraction exercised by the earth on bodies at its surface;¹ but he failed to conceive the combination of central force with tangential velocity, and was disposed to connect the revolutions of the planets with the axial rotation of the sun. This notion, it is plain, tended rather towards Descartes's theory of vortices than towards Newton's theory of gravitation. More valid instances of the anticipation of modern discoveries may be found in his prevision that a small annual parallax would eventually be found for some of the fixed stars, and that extra-Saturnian planets would at some future time be ascertained to exist, and in his conviction that light travels with a measurable, although, in relation to terrestrial distances, infinite velocity.

The invention of the microscope, attributed to Galileo by his first biographer, Vincenzo Viviani, does not in truth belong to him. Such an instrument was made as early as 1590 by Zacharias Jansen of Middleburg; and although Galileo discovered, in 1610, a means of adapting his telescope to the examination of minute objects, he did not become acquainted with the compound microscope until 1624 when he saw one of Drebbel's instruments in Rome, and, with characteristic ingenuity, immediately introduced some material improvements into its construction.

The most substantial, if not the most brilliant part of his work consisted undoubtedly in his contributions towards the establishment of mechanics as a science. Some valuable but isolated facts and theorems had been previously discovered and proved, but it was he who first clearly grasped the idea of force as a mechanical agent, and extended to the external world the conception of the invariability of the relation between cause and effect. From the time of Archimedes there had existed a science of equilibrium, but the science of motion began with Galileo. It is not too much to say that the final triumph of the Copernican system was due in larger measure to his labours in this department than to his direct arguments in its favour. The problem of the heavens is essentially a mechanical one; and without the mechanical conceptions of the dependence of motion upon force which Galileo familiarized to men's minds, that problem might have remained a sealed book even to the intelligence of Newton. The interdependence of motion and force was not indeed formulated into definite laws by Galileo, but his writings on dynamics are everywhere suggestive of those laws, and his solutions of dynamical problems involve their recognition. The extraordinary advances made by him in this branch of knowledge were owing to his happy method of applying mathematical analysis to physical problems. As a pure mathematician he was, it is true, surpassed in profundity by more than one among his pupils and contemporaries; and in the wider imaginative grasp of abstract geometrical principles he cannot be compared with Fermat, Descartes or Pascal, to say nothing of Newton or Leibnitz. Still, even in the region of pure mathematics, his

¹ The passage is sufficiently remarkable to deserve quotation in the original:—"Le parti della Terra hanno tal propensione al centro di essa, che quando ella cangiassi luogo, le dette parti, benché lontane dal globo nel tempo delle mutazioni di esso, lo seguirebbero per tutto; esempio di ciò sia il seguito perpetuo delle Medicee, ancorché separate continuamente da Giove. L'istesso si deve dire della Luna, obbligata a seguir la Terra."—*Dialogo dei massimi sistemi*, Giornata terza, p. 351 of Albeni's edition.

powerful and original mind left notable traces of its working. He studied the properties of the cycloid, and attempted the problem of its quadrature; and in the "infinitesimals," which he was one of the first to introduce into geometrical demonstrations, was contained the fruitful germ of the differential calculus. But the method which was peculiarly his, and which still forms the open road to discoveries in natural science, consisted in the combination of experiment with calculation—in the transformation of the concrete into the abstract, and the assiduous comparison of results. The first-fruits of the new system of investigation was his determination of the laws of falling bodies. Conceiving that the simplest principle is the most likely to be true, he assumed as a postulate that bodies falling freely towards the earth descend with a uniformly accelerated motion, and deduced thence that the velocities acquired are in the direct, and the spaces traversed in the duplicate ratio of the times, counted from the beginning of motion; finally, he proved, by observing the times of descent of bodies falling down inclined planes, that the postulated law was the true law. Even here, he was obliged to take for granted that the velocities acquired in descending from the same height along planes of every inclination are equal; and it was not until shortly before his death that he found the mathematical demonstration of this not very obvious principle.

The first law of motion—that which expresses the principle of inertia—is virtually contained in the idea of uniformly accelerated velocity. The recognition of the second—that of the independence of different motions—must be added to form the true theory of projectiles. This was due to Galileo. Up to his time it was universally held in the schools that the motion of a body should cease with the impulse communicated to it, but for the "reaction of the medium" helping it forward. Galileo showed, on the contrary, that the nature of motion once impressed is to continue indefinitely in a uniform direction, and that the effect of the medium is a retarding, not an impelling one. Another commonly received axiom was that no body could be affected by more than one movement at one time, and it was thus supposed that a cannon ball, or other projectile, moves forward in a right line until its first impulse is exhausted, when it falls vertically to the ground. In the fourth of Galileo's dialogues on mechanics, he demonstrated that the path described by a projectile, being the result of the combination of a uniform transverse motion with a uniformly accelerated vertical motion, must, apart from the resistance of the air, be a parabola. The establishment of the principle of the composition of motions formed a conclusive answer to the most formidable of the arguments used against the rotation of the earth, and we find it accordingly triumphantly brought forward by Galileo in the second of his dialogues on the systems of the world. It was urged by anti-Copernicans that a body flung upward or cast downward would, if the earth were in motion, be left behind by the rapid translation of the point from which it started; Galileo proved on the contrary that the reception of a fresh impulse in no way interfered with the movement already impressed, and that the rotation of the earth was insensible, because shared equally by all bodies at its surface. His theory of the inclined plane, combined with his satisfactory definition of "momentum," led him towards the third law of motion. We find Newton's theorem, that "action and reaction are equal and opposite," stated with approximate precision in his treatise *Della scienza meccanica*, which contains the substance of lectures delivered during his professorship at Padua; and the same principle is involved in the axiom enunciated in the third of his mechanical dialogues, that "the propensity of a body to fall is equal to the least resistance which suffices to support it." The problems of percussion, however, received no definitive solution until after his death.

His services were as conspicuous in the statical as in the kinetical division of mechanics. He gave the first satisfactory demonstration of equilibrium on an inclined plane, reducing it to the level by a sound and ingenious train of reasoning; while, by establishing the theory of "virtual velocities," he laid down the fundamental principle which, in the opinion of Lagrange, contains the general expression of the laws of equilibrium. He

studied with attention the still obscure subject of molecular cohesion, and little has been added to what he ascertained on the question of transverse strains and the strength of beams, first brought by him within the scope of mechanical theory. In his *Discorso intorno alle cose che stanno su l'acqua*, published in 1612, he used the principle of virtual velocities to demonstrate the more important theorems of hydrostatics, deducing from it the equilibrium of fluid in a siphon, and proved against the Aristotelians that the floating of solid bodies in a liquid depends not upon their form, but upon their specific gravities relative to such liquid.

In order to form an adequate estimate of the stride made by Galileo in natural philosophy, it would be necessary to enumerate the confused and erroneous opinions prevailing on all such subjects in his time. His best eulogium, it has been truly said, consists in the fallacies which he exposed. The scholastic distinctions between corruptible and incorruptible substances, between absolute gravity and absolute levity, between natural and violent motions, if they did not wholly disappear from scientific phraseology, ceased thenceforward to hold the place of honour in the controversies of the learned. Discarding these obscure and misleading notions, Galileo taught that gravity and levity are relative terms, and that all bodies are heavy, even those which, like the air, are invisible; that motion is the result of force, instantaneous or continuous; that weight is a continuous force, attracting towards the centre of the earth; that, in a vacuum, all bodies would fall with equal velocities; that the "inertia of matter" implies the continuance of motion, as well as the permanence of rest; and that the substance of the heavenly bodies is equally "corruptible" with that of the earth. These simple elementary ideas were eminently capable of development and investigation, and were not only true but the prelude to further truth; while those they superseded defied inquiry by their vagueness and obscurity. Galileo was a man born in due time. He was superior to his contemporaries, but not isolated amongst them. He represented and intensified a growing tendency of the age in which he lived. It was beginning to be suspected that from Aristotle an appeal lay to nature, and some were found who no longer treated the *ipse dixit* of the Stagirite as the final authority in matters of science. A vigorous but ineffectual warfare had already been waged against the blind traditions of the schools by Ramus and Telesius, by Patricius and Campanella, and the revolution which Galileo completed had been prepared by his predecessors. Nevertheless, the task which he so effectively accomplished demanded the highest and rarest quality of genius. He struck out for himself the happy middle path between the *a priori* and the empirical systems, and exemplified with brilliant success the method by which experimental science has wrested from nature so many of her secrets. His mind was eminently practical. He concerned himself above all with what fell within the range of exact inquiry, and left to others the larger but less fruitful speculations which can never be brought to the direct test of experiment. Thus, while far-reaching but hasty generalizations have had their day and been forgotten, his work has proved permanent, because he made sure of its foundations. His keen intuition of truth, his vigour and yet sobriety of argument, his fertility of illustration and acuteness of sarcasm, made him irresistible to his antagonists; and the evanescent triumphs of scornful controversy have given place to the sedate applause of a long-lived posterity.

The first complete edition of Galileo's writings was published at Florence (1842-1866), in 16 8vo vols., under the supervision of Signor Eugenio Albèri. Besides the works already enumerated, it contained the *Sermones de motu gravium* composed at Pisa between 1589 and 1591; his letters to his friends, with many of their replies, as well as several of the essays of his scientific opponents; his laudatory comments on the *Orlando Furioso*, and deprecatory notes on the *Gerusalemme Liberata*, some stanzas and sonnets of no great merit, together with the sketch of a comedy; finally, a reprint of Viviani's *Life*, with valuable notes and corrections. The original documents from the archives of the Inquisition, relating to the events of 1616 and 1633, recovered from Paris in 1846 by the efforts of Count Rossi, and now in the Vatican Library, were to a limited extent made public by Monsignor Marino-Marini in 1850, and more unreservedly by M. Henri de l'Épinois, in an essay entitled

Galilée, son procès, sa condamnation, published in 1867 in the *Revue des questions historiques*. He was followed by M. Karl von Gebler, who, in an able and exhaustive but somewhat prejudiced work, *Galileo Galilei und die römische Curie* (Stuttgart, 1876), sought to impeach the authenticity of a document of prime importance in the trial of 1633. He was victoriously answered by Signor Domenico Berti, in *Il Processo originale di Galileo Galilei* (Rome, 1876), and by M. de l'Épinois, with *Les pièces du procès de Galilée* (Rome, Paris, 1877). The touching letters of Galileo's eldest daughter, Sister Maria Celeste, to her father were printed in 1864 by Professor Carlo Arduini, in a publication entitled *La Primogenita di Galileo Galilei*.

The issue of a "national edition" of the Works of Galileo, in 20 large volumes, was begun at Florence in 1890. It includes a mass of previously inedited correspondence and other documents, collected by the indefatigable director, Professor Antonio Favaro, among whose numerous publications on Galilean subjects may be mentioned: *Galileo e lo studio di Padova* (2 vols., 1883); *Scampoli Galileiani* (12 series, 1886-1897); *Nuovi Studi Galileiani* (1891); *Galileo Galilei e Suor Maria Celeste* (1891). See also Th. Henri Martin's *Galilée, les droits de la science et la méthode des sciences physiques* (1868); *Private Life of Galileo* (by Mrs Olney, 1870); J. J. Fabie's *Galileo; his Life and Work* (1903); *Galilée et Marinus*, by J. A. C. Oudemans and J. Bosscha (1903). The relations of Galileo to the Church are temperately and ably discussed by F. R. Wegg-Prosser in *Galileo and his Judges* (1889), and in two articles published in the *American Catholic Quarterly* for April and July 1901. (A. M. C.)

GALION, a city of Crawford County, Ohio, U.S.A., about 75 m. S.W. of Cleveland. Pop. (1890) 6326; (1900) 7282 (703 foreign-born); (1910) 7214. It is served by the Cleveland, Cincinnati, Chicago & St. Louis, and the Erie railways, and by an interurban electric railway. The city is about 1165 ft. above sea level, and has extensive railway shops (of the Erie railway) and manufacturing of brick and tile machinery, carriages and wagons, and grain and seed cleaners. The municipality owns and operates its electric-lighting plant. Galion was laid out as a town in 1831, was incorporated as a borough in 1840, and was chartered as a city in 1878.

GALL, FRANZ JOSEPH (1758-1828), anatomist, physiologist, and founder of phrenology (q.v.), was born at Tiefenbrunn near Pforzheim, Baden, on the 9th of March 1758. After completing the usual literary course at Baden and Bruchsal, he began the study of medicine under J. Hermann (1738-1800) at Strassburg, whence, attracted by the names of Gerhard van Swieten (1700-1772) and Maximilian Stoll (1742-1788), he removed to Vienna in 1781. Having received his diploma, he began to practise as a physician there in 1783; but his energies were mainly devoted to the scientific investigation of problems which had occupied his attention from boyhood. At a comparatively early period he formed the generalization that in the human subject at least a powerful memory is invariably associated with prominent eyes; and further observation enabled him, as he thought, also to define the external characteristics indicative of special talents for painting, music and the mechanical arts. Following out these researches, he gradually reached the strong conviction, not only that the talents and dispositions of men are dependent upon the functions of the brain, but also that they may be inferred with perfect exactitude and precision from the external appearances of the skull. Gall's first appearance as an author was made in 1791, when he published the first two chapters of a (never completed) work entitled *Philosophisch-medizinische Untersuchungen über Natur u. Kunst im kranken u. gesunden Zustande des Menschen*. The first public notice of his inquiries in craniology, however, was in the form of a letter addressed to a friend, which appeared in C. M. Wieland's *Deutscher Mercur* in 1798; but two years previously he had begun to give private courses of phrenological lectures in Vienna, where his doctrines soon attracted general attention, and met with increasing success until, in 1802, they were interdicted by the government as being dangerous to religion. This step on the part of the authorities had the effect of greatly stimulating public curiosity and increasing Gall's celebrity.

In March 1805 he finally left Vienna in company with his friend and associate J. C. Spurzheim, and made a tour through Germany, in the course of which he lectured in Berlin, Dresden, Magdeburg and several of the university towns. His exhibitions, which he knew how to make popular and attractive, were much

resorted to by the public, and excited considerable controversy in the scientific world. He had almost reached the zenith of his fame when, in 1807, he repaired to Paris and established himself there as a medical practitioner, at the same time continuing his activity as a lecturer and writer. In 1808 appeared his *Introduction au cours de physiologie du cerveau*, which was followed in 1809 by the *Recherches sur le système nerveux en général, et sur celui du cerveau en particulier* (originally laid before the Institute of France in March 1808), and in 1810 by the first instalment of the *Anatomie et physiologie du système nerveux en général, et du cerveau en particulier, avec des observations sur la possibilité de reconnaître plusieurs dispositions intellectuelles et morales de l'homme et des animaux par la configuration de leurs têtes*. The *Recherches* and the first two volumes of the *Anatomie* bear the conjoint names of Gall and Spurzheim. The latter work was completed in 1819, and appeared in a second edition of six volumes in 1822-1825. In 1811 he replied to a charge of Spinozism or atheism, which had been strongly urged against him, by a treatise entitled *Des dispositions innées de l'âme et de l'esprit*, which he afterwards incorporated with his greater work. In 1819 he became a naturalized French subject, but his efforts two years afterwards to obtain admission to the Academy of Sciences, although supported by E. Geoffroy Saint-Hilaire, were unsuccessful. In 1823 he visited London with the intention of giving a series of phrenological lectures, but his reception was not what he had anticipated, and he speedily abandoned his plans. He continued to lecture and practise in Paris until the beginning of 1828, when he was disabled by an apoplectic seizure. His death took place at Montrouge near Paris, on the 22nd of August 1828.

GALL (a word common to many Teutonic languages, cf. Dutch *gal*, and Ger. *Galle*; the Indo-European root appears in Gr. γαλή, and Lat. *fel*; possibly connected with "yellow," with reference to the colour of bile), the secretion of the liver known as "bile," the term being also used of the pear-shaped diverticulum of the bile-duct, which forms a reservoir for the bile, more generally known as the "gall-bladder" (see **LIVER**). From the extreme bitterness of the secretion, "gall," like the Lat. *fel*, is used for anything extremely bitter, whether actually or metaphorically. From the idea that the gall-bladder was the dominating organ of a bitter, sharp temperament, "gall" was formerly used in English for such a spirit, and also for one very ready to resent injuries. It thus survives in American slang, with the meaning "impudence" or "assurance."

"Gall," meaning a sore or painful swelling, especially on a horse, may be the same word, derived from an early use of the word as meaning "poison." On the other hand, in Romanic languages, the Fr. *galle*, Sp. *agalla*, a wind-gall or puffy distension of the synovial bursa on the fetlock joint of a horse, is derived from the Lat. *galla*, oak-apple, from which comes the English "gall," meaning an excrescence on trees caused by certain insects. (See **GALLS**.)

GALLABAT, of GALABAT, called by the Abyssinians Matemma (Metemma), a town of the Anglo-Egyptian Sudan, in 13° N. 36' 12' E. It is built, at the foot of a steep slope, on the left bank of a tributary of the Atbara called the Khor Abnaheir, which forms here the Sudan-Abyssinian frontier. Gallabat lies 90 m. W. by N. of Gondar, the capital of Amhara, and being on the main route from Sennar to Abyssinia, is a trade centre of some importance. Pop. about 3000. The majority of the buildings are grass *tukls*. Slaves, beeswax, coffee, cotton and hides were formerly the chief articles of commerce. The slave market was closed about 1874. Being on the frontier line, the possession of the town was for long a matter of dispute between the Sudanese, and later the Egyptians, on the one hand and the Abyssinians on the other. About 1870 the Egyptians garrisoned the town, which in 1886 was attacked by the dervishes and sacked. From Gallabat a dervish raiding party penetrated to Gondar, which they looted. In revenge an Abyssinian army under King John attacked the dervishes close to Gallabat in March 1889. The dervishes suffered very severely, but King John being killed by a stray bullet, the Abyssinians retired (see **EGYPT: Military Operations**,

1885-1896). In December 1898 an Anglo-Egyptian force entered Gallabat. The Abyssinians then held the fort, but as the result of frontier arrangement the town was definitely included in the Sudan, though Abyssinia takes half the customs revenue. Since 1899 the trade of the place has revived, coffee and live stock being the most important items.

The town and district form a small ethnographical island, having been peopled in the 18th century by a colony of Takturri from Darfur, who, finding the spot a convenient resting-place for their fellow-pilgrims on their way to Mecca and back, obtained permission from the negus of Abyssinia to make a permanent settlement. They are an industrious agricultural race, and cultivate cotton with considerable success. They also collect honey in large quantities. The Takturri possess jagged throwing knives, which are said to have been brought from their original home in the Upper Congo regions.

GALLAIT, LOUIS (1810-1887), Belgian painter, was born at Tournay, in Hainaut, Belgium, on the 9th of May 1810. He first studied in his native town under Hennequin. In 1832 his first picture, "Tribute to Caesar," won a prize at the exhibition at Ghent. He then went to Antwerp to prosecute his studies under Mathieu Ignace Van Brée, and in the following year exhibited at the Brussels Salon "Christ Healing the Blind." This picture was purchased by subscription and placed in the cathedral at Tournay. Gallait next went to Paris, whence he sent to the Belgian Salons "Job on the Dunghill," "Montaigne Visiting Tasso in Prison"; and, in 1841, "The Abdication of Charles V.," in the Brussels Gallery. This was hailed as a triumph, and gained for the painter a European reputation. Official invitations then caused him to settle at Brussels, where he died on the 20th of November 1887. Among his greater works may be named: "The Last Honours paid to Counts Egmont and Horn by the Corporations of the Town of Brussels," now at Tournay; "The Death of Egmont," in the Berlin gallery; the "Coronation of Baudouin, Emperor of Constantinople," painted for Versailles; "The Temptation of St Anthony," in the palace at Brussels; "The Siege of Antioch," "Art and Liberty," a "Portrait of M. B. Dumortier" and "The Plague at Tournay," all in the Brussels gallery. "A Gipsy Woman and her Children" was painted in 1852. "M. Gallait has all the gifts that may be acquired by work, taste, judgment and determination," wrote Théophile Gautier; his art is that of a man of fact, a skilled painter, happy in his dramatic treatment but superficial. No doubt, this Walloon artist, following the example of the Flemings of the Renaissance and the treatment of Belgian classical painters and the French Romantic school, sincerely aimed at truth; unfortunately, misled by contemporary taste, he could not conceive of it excepting as dressed in sentimentality. As an artist employed by the State he exercised considerable influence, and for a long period he was the leader of public taste in Brussels.

See Teichlin, *Louis Gallait und die Malerei in Deutschland* (1853); J. Dujardin, *L'Art flamand* (1899); C. Lemonnier, *Histoire des beaux-arts en Belgique* (1881).

GALLAND, ANTOINE (1646-1715), French Orientalist and archaeologist, the first European translator of the *Arabian Nights*, was born on the 4th of April 1646 at Rollot, in the department of Somme. The completion of his school education at Noyon was followed by a brief apprenticeship to a trade, from which, however, he soon escaped, to pursue his linguistic studies at Paris. After having been employed for some time in making a catalogue of the Oriental manuscripts at the Sorbonne, he was, in 1670, attached to the French embassy at Constantinople; and in 1673 he travelled in Syria and the Levant, where he copied a great number of inscriptions, and sketched, and in some cases removed historical monuments. After a brief visit to France, where his collection of ancient coins attracted some attention, Galland returned to the Levant in 1676; and in 1679 he undertook a third voyage, being commissioned by the French East India Company to collect for the cabinet of Colbert; on the expiration of this commission he was instructed by the government to continue his researches, and had the title of

"antiquary to the king" conferred upon him. During his prolonged residences abroad he acquired a thorough knowledge of the Arabic, Turkish and Persian languages and literatures, which, on his final return to France, enabled him to render valuable assistance to Thevenot, the keeper of the royal library, and to Barthélemy d'Herbelot. After their deaths he lived for some time at Caen under the roof of Nicolas Foucault (1643-1721), the intendant of Caen, himself no mean archaeologist; and there he began the publication (12 vols., 1704-1717) of *Les mille et une nuits*, which excited immense interest during the time of its appearance, and is still the standard French translation. It had no pretensions to verbal accuracy, and the coarseness of the language was modified to suit European taste, but the narrative was adequately rendered. In 1701 Galland had been admitted into the Academy of Inscriptions, and in 1709 he was appointed to the chair of Arabic in the Collège de France. He continued to discharge the duties of this post until his death, which took place on the 17th of February 1715.

Besides a number of archaeological works, especially in the department of numismatics, he published a compilation from the Arabic, Persian and Turkish, entitled *Paroles remarquables, bons mots et maximes des orientaux* (1694), and a translation from an Arabic manuscript, *De l'origine et du progrès du café* (1699). The former of these works appeared in an English translation in 1795. His *Contes et fables indiennes de Bidpai et de Lokman* was published (1724) after his death. Among his numerous unpublished manuscripts are a translation of the Koran and a *Histoire générale des empereurs turcs*. His *Journal* was published by M. Charles Schefer in 1881.

GALLARATE, a town of Lombardy, Italy, in the province of Milan, from which it is 25 m. N.W. by rail. Pop. (1901) 12,002. The town is of mediæval origin. It is remarkable mainly for its textile factories. It is the junction of railways to Varese, Laveno and Arona (for the Simplon). Six miles to the W. are the electric works of Vizzola, the largest in Europe, where 23,000 h.p. are derived from the river Ticino.

GALLARS [in Lat. GALLASIUS], **NICOLAS DES** (c. 1520-c. 1580), Calvinistic divine, first appears as author of a *Defensio* of William Farel, published at Geneva in 1545, followed (1545-1549) by translations into French of three tracts by Calvin. In 1551 he was admitted burgess of Geneva, and in 1553 made pastor of a country church in the neighbourhood. In 1557 he was sent to minister to the Protestants at Paris; his conductor, Nicolas du Rousseau, having prohibited books in his possession, was executed at Dijon; des Gallars, having nothing suspicious about him, continued his journey. On the revival of the Strangers' church in London (1560), he, being then minister at Geneva, came to London to organize the French branch; and in 1561 he published *La Forme de police ecclésiastique instituée à Londres en l'Église des François*. In the same year he assisted Beza at the colloquy of Poissy. He became minister to the Protestants at Orleans in 1564; presided at the synod of Paris in 1565; was driven out of Orleans with other Protestants in 1568; and in 1571 was chaplain to Jeanne d'Albret, queen of Navarre. Calvin held him in high esteem, employing him as amanuensis, and as editor as well as translator of several of his exegetical and polemical works. He himself wrote a commentary on Exodus (1560); edited an annotated French Bible (1562) and New Testament (1562); and published tracts against Ariens (1565-1566). His main work was his edition of Irenæus (1570) with prefatory letter to Grindal, then bishop of London, and giving, for the first time, some fragments of the Greek text. His collaboration with Beza in the *Histoire des Églises Réformées du royaume de France* (1580) is doubted by Bayle.

See Bayle, *Dictionnaire hist. et crit.*; Jean Senebier, *Hist. littéraire de Genève* (1786); *Nouvelle Biog. gén.* (1857). (A. G. O.)

GALLAS, MATTHIAS, COUNT OF CAMPO, DUKE OF LUCERA (1584-1647), Austrian soldier, first saw service in Flanders, and in Savoy with the Spaniards, and subsequently joined the forces of the Catholic League as captain. On the general outbreak of hostilities in Germany, Gallas, as colonel of an infantry regiment, distinguished himself, especially at the battle of Stadtlohn (1623). In 1630 he was serving as *General-Feldwachtmeister* under Collalto in Italy, and was mainly instrumental in the capture of Mantua. Made count of the Empire for this service,

he returned to Germany for the campaign against Gustavus Adolphus. In command of a corps of Wallenstein's army, he covered Bohemia against the Swedes in 1631-1632, and served at the Alte Veste near Nuremberg, and at Lützen. Further good service against Bernhard of Saxe-Weimar commended General Gallas to the notice of the emperor, who made him lieutenant-general in his own army. He was one of the chief conspirators against Wallenstein, and after the tragedy of Eger was appointed to the command of the army which Wallenstein had formed and led. At the great battle of Nördlingen (23rd of August 1634) in which the army of Sweden was almost annihilated, Gallas commanded the victorious Imperialists. His next command was in Lorraine, but even the Moselle valley had suffered so much from the ravages of war that his army perished of want. Still more was this the case in northern Germany, where Gallas commanded against the Swedish general Banér in 1637 and 1638. At first driving the Swedes before him, in the end he made a complete failure of the campaign, lost his command, and was subject to much ridicule. It was, however, rather the indiscipline of his men (the baneful legacy of Wallenstein's methods) than his own faults which brought about his disastrous retreat across North Germany, and at a moment of crisis he was recalled to endeavour to stop Torstenson's victorious advance, only to be shut up in Magdeburg, whence he escaped with the barest remnant of his forces. Once more relieved of his command, he was again recalled to make head against the Swedes in 1645 (after their victory at Jankow). Before long, old and warworn, he resigned his command, and died in 1647 at Vienna. His army had earned for itself the reputation of being the most cruel and rapacious force even in the Thirty Years' War, and his *Merode Brüder* have survived in the word *marauder*. Like many other generals of that period, he had acquired much wealth and great territorial possessions (the latter mostly his share of Wallenstein's estates). He was the founder of the Austrian family of Clam-Gallas, which furnished many distinguished soldiers to the Imperial army.

GALLAS, or more correctly **GALLA**, a powerful Hamitic people of eastern Africa, scattered over the wide region which extends for about 1000 m. from the central parts of Abyssinia to the neighbourhood of the river Sabaki in British East Africa. The name "Galla" or "Gala" appears to be an Abyssinian nickname, unknown to the people, who call themselves *Iim' Orma*, "sons of men" or "sons of Orma," an eponymous hero. In Shoa (Abyssinia) the word is connected with the river Gála in Guragie, on the banks of which a great battle is said to have been fought between the Galla and the Abyssinians. Arnaud d'Abbadie says that the Abyssinian Moslems recount that, when summoned by the Prophet's messenger to adopt Islam, the chief of the Galla said "No,"—in Arabic *kál* (or *gál*) *la*,—and the Prophet on hearing this said, "Then let their very name imply their denial of the Faith." Of all Hamitic peoples the Galla are the most numerous. Dr J. Ludwig Krapf estimated them (c. 1860) at from six to eight millions; later authorities put them at not much over three millions. Individual tribes are said to be able to bring 20,000 to 30,000 horsemen into the field.

Hardly anything is definitely known as to the origin and early home of the race, but it appears to have occupied the southern part of its present territory since the 16th century. According to Hiob Ludolf and James Bruce, the Galla invaders first crossed the Abyssinian frontiers in the year 1537. The Galla of Gojam (a district along the northern side of the river Abai) tell how their savage forefathers came from the south-east from a country on the other side of a bahr (lake or river), and the Yejju and Raia Galla also point towards the east and commemorate the passage of a bahr. Among the southern Galla tradition appears to be mainly concerned with the expulsion of the race from the country now occupied by the Somali. Their original home was possibly in the district east of Victoria Nyanza, for the tribes near Mount Kenya are stated to go on periodical pilgrimages to the mountain, making offerings to it as if to their mother. A theory has been advanced that the great exodus which it seems certain took place among the peoples throughout eastern Africa during the 15th century was caused by some great eruption of Kenya

and other volcanoes of equatorial Africa. As a geographical term Galla-land is now used mainly to denote the south-central regions of the Abyssinian empire, the country in which the Galla are numerically strongest. There is no sharp dividing line between the territory occupied respectively by the Galla and by the Somali.

In any case the Galla must be regarded as members of that vast eastern Hamitic family which includes their neighbours, the Somali, the Afars (Danakil) and the Abyssinians. As in all the eastern Hamites, there is a perceptible strain of Negro blood in the Galla, who are, however, described by Sir Frederick Lugard as "a wonderfully handsome race, with high foreheads, brown skins, and soft wavy hair quite different from the wool of the Bantus." As a rule their features are quite European. Their colour is dark brown, but many of the northern Galla are of a coffee and milk tint. The finest men are to be found among the Limmu and Guduru on the river Abai.

The Galla are for the most part still in the nomadic and pastoral stage, though in Abyssinia they have some agricultural settlements. Their dwellings, circles of rough stones roofed with grasses, are generally built under trees. Their wealth consists chiefly in cattle and horses. Among the southern tribes it is said that about seven or eight head of cattle are kept for every man, woman and child; and among the northern tribes, as neither man nor woman ever thinks of going any distance on foot, the number of horses is very large. The ordinary food consists of flesh, blood, milk, butter and honey, the last being considered of so much importance by the southern Galla that a rude system of bee-keeping is in vogue, and the husband who fails to furnish his wife with a sufficient supply of honey may be excluded from all conjugal rights. In the south monogamy is the rule, but in the north the number of a man's wives is limited only by his wishes and his wealth. Marriage-forms are numerous, that of bride-capture being common. Each tribe has its own chief, who enjoys the strange privilege of being the only merchant for his people, but in all public concerns must take the advice of the fathers of families assembled in council. The greater proportion of the tribes are still pagan, worshipping a supreme god Waka, and the subordinate god and goddess Ogileh and Atetieh, whose favour is secured by sacrifices of oxen and sheep. With a strange liberality of sentiment, they say that at a certain time of the year Waka leaves them and goes to attend to the wants of their enemies the Somali, whom also he has created. Some tribes, and notably the Wollo Galla, have been converted to Mahomedanism and are very bigoted adherents of the Prophet. In the north, where the Galla are under Abyssinian rule, a kind of superficial Christianization has taken place, to the extent at least that the people are familiar with the names of Maremma or Mary, Balawold or Jesus, Gijris or St George, &c.; but to all practical intents paganism is still in force. The serpent is a special object of worship, the northern Galla believing that he is the author of the human race. There is a belief in werewolves (*bada*), and the northern Galla have sorcerers who terrorize the people. Though cruel in war, all Galla respect their pledged word. They are armed with a lance, a two-edged knife, and a shield of buffalo or rhinoceros hide. A considerable number find employment in the Abyssinian armies.

Among the more important tribes in the south (the name in each instance being compounded with Galla) are the Ramatta, the Kukatta, the Baöle, the Aurova, the Wadjole, the Ilani, the Arrar and the Kanigo Galla; the Borani, a very powerful tribe, may be considered to mark the division between north and south; and in the north we find the Amoro, the Jarso, the Toolama, the Wollo, the Ambassil, the Aijjo, and the Azobo Galla.

See C. T. Beke, "On the Origin of the Gallas," in *Trans. of Brit. Assoc.* (1847); J. Ludwig Krapf, *Travels in Eastern Africa* (1860); and *Vocabulary of the Galla Language* (London, 1842); Arnaud d'Abbadie, *Deux Années dans la Haute-Ethiopie* (1868); Ph. Paulitschke, *Ethnographie Nord-Ost-Afrikas. Die geistige Kultur der Dan'akil, Galla u. Somali* (Berlin, 1896); P. M. de Salviac, *Les Galla* (Paris, 1901).

GALLATIN, ALBERT (1761-1849), American statesman, was born in Geneva (Switzerland) on the 29th of January 1761. The Gallatins were both an old and a noble family. They are first heard of in Savoy in the year 1258, and more than two centuries later they went to Geneva (1510), united with Calvin in his opposition to Rome, and associated their fortunes with those of the little Swiss city. Here they remained, and with one or two other great families governed Geneva, and sent forth many representatives to seek their fortune and win distinction in the service of foreign princes, both as soldiers and ministers. On the eve of the French Revolution the Gallatins were still in Geneva, occupying the same position which they had held for two hundred years. Albert Gallatin's father died in 1765, his mother five

years later, and his only sister in 1777. Although left an orphan at nine, he was by no means lonely or unprotected. His grandparents, a large circle of near relatives and Mlle Catherine Pictet (d. 1795), an intimate friend of his mother, cared for him during his boyhood. He was thoroughly educated at the schools of Geneva, and graduated with honour from the college or academy there in 1779. His grandmother then wished him to enter the army of the landgrave of Hesse, but he declined to serve "a tyrant," and a year later slipped away from Geneva and embarked for the United States. A competent fortune, good prospects, social position, and a strong family connexion were all thrown aside in order to tempt fate in the New World. His relatives very properly opposed his course, but they nevertheless did all in their power to smooth his way, and continued to treat him kindly. In after life he himself admitted the justice of their opinions. The temper of the times, a vague discontent with the established order of things, and some political enthusiasm imbibed from the writings of Rousseau, are the best reasons which can now be assigned for Gallatin's desertion of home and friends.

In July 1780 Gallatin and his friend Henri Serre (d. 1784) landed in Massachusetts. They brought with them youth, hope and courage, as well as a little money, and at once entered into business. The times, however, were unfavourable. The great convulsion of the Revolution was drawing to a close, and everything was in an unsettled condition. The young Genevans failed in business, passed a severe winter in the wilds of Maine, and returned to Boston penniless. Gallatin tried to earn a living by teaching French in Harvard College, apparently not without success, but the cold and rigid civilization of New England repelled him, and he made his way to the South. In the backwoods of Pennsylvania and Virginia there seemed to be better chances for a young adventurer. Gallatin engaged in land speculations, and tried to lay the foundation of his fortune in a frontier farm. In 1789 he married Sophie Allègre, and every prospect seemed to be brightening. But clouds soon gathered again. After only a few months of wedlock his wife died, and Gallatin was once more alone. The solitary and desolate frontier life became now more dreary than ever; he flung himself into politics the only outside resource open to him, and his long and eventful public career began.

The constitution of 1787 was then before the public, and Gallatin, with his dislike of strong government still upon him, threw himself into opposition and became one of the founders of the Anti-Federalist, or, as it was afterwards called, the Republican party. He was a member of the Pennsylvania Constitutional Convention of 1789-1790, and of the Pennsylvania Assembly in 1790, 1791, and 1792, and rose with surprising rapidity, despite his foreign birth and his inability to speak English with correctness or fluency. He was helped of course by his sound education; but the true cause of his success lay in his strong sense, untiring industry, courage, clear-sightedness and great intellectual force. In 1793 he was chosen United States senator from Pennsylvania by the votes of both political parties. No higher tribute was ever paid to character and ability than that conveyed by this election. But the staunch Federalists of the senate, who had begun to draw the party lines rather sharply, found the presence of the young Genevan highly distasteful. They disliked his French origin, and suspected him to be a man of levelling principles. His seat was contested on account of a technical flaw in regard to the duration of his citizenship, and in February 1794, almost three months after the beginning of the session, the senate annulled the election and sent him back to Pennsylvania with all the glory of political martyrdom.

The leading part which Gallatin had taken in the "Whisky Insurrection" in Western Pennsylvania had, without doubt, been an efficient cause in his rejection by the senate. He intended fully to restrain within legal bounds the opposition which the excise on domestic spirits had provoked, but he made the serious mistake of not allowing sufficiently for the character of the backwoods population. When legal resistance developed into insurrection, Gallatin did his best to retrieve his error and

prevent open war. At Redstone Old Fort (Brownsville) on the 29th of August 1794, before the "Committee of Sixty" who were appointed to represent the disaffected people, he opposed with vigorous eloquence the use of force against the government, and refused to be intimidated by an excited band of riflemen who happened to be in the vicinity and represented the radical element. He effectively checked the excitement, and when a month later an overwhelming Federal force began moving upon the western counties, the insurrection collapsed without bloodshed. Of all the men who took part in the opposition to the excise, Gallatin alone came out with credit. He was at once elected to the national house of representatives, and took his seat in December 1795. There, by sheer force of ability and industry, he wrested from all competitors the leadership of the Republicans, and became the most dangerous opponent whom the Federalists had ever encountered in congress. Inflamed with a hatred of France just then rising to the dignity of a party principle, they found in Gallatin an enemy who was both by origin and opinion peculiarly obnoxious to them. They attacked him unsparingly, but in vain. His perfect command of temper, his moderation of speech and action, in a bitterly personal age, never failed, and were his most effective weapons; but he made his power felt in other ways. His clear mind and industrious habits drew him to questions of finance. He became the financier of his party, preached unceasingly his cardinal doctrines of simplicity and economy, and was an effective critic of the measures of government. Cool and temperate, Gallatin, when following his own theories, was usually in the right, although accused by his followers of trimming. Thus, in regard to the Jay treaty, he defended the constitutional right of the house to consider the treaty, but he did not urge rejection in this specific case. On the other hand, when following a purely party policy he generally erred. He resisted the navy, the mainspring of Washington's foreign policy; he opposed commercial treaties and diplomatic intercourse in a similar fashion. On these points he was grievously wrong, and on all he changed his views after a good deal of bitter experience.

The greatest period of Gallatin's career in congress was in 1798, after the publication of the famous X.Y.Z. despatches. The insults of Talleyrand, and his shameless attempts to extort bribes from the American commissioners, roused the deep anger of the people against France. The Federalists swept all before them, and the members of the opposition either retired from Philadelphia or went over to the government. Alone and single-handed, Gallatin carried on the fight in congress. The Federalists bore down on him unmercifully, and even attempted (1798) a constitutional amendment in regard to citizenship, partly, it appears, in order to drive him from office. Still he held on, making a national struggle in the national legislature, and relying very little upon the rights of States so eagerly grasped by Jefferson and Madison. But even then the tide was turning. The strong measures of the Federalists shocked the country; the leaders of the dominant party quarrelled fiercely among themselves; and the Republicans carried the elections of 1800. In the exciting contest for the presidency in the house of representatives between Jefferson and Burr, it was Gallatin who led the Republicans.

When, after this contest, Jefferson became president (1801), there were two men whose commanding abilities marked them for the first places in the cabinet. James Madison became secretary of state, and Albert Gallatin secretary of the treasury. Wise, prudent and conservative, Gallatin made few changes in Hamilton's arrangements, and for twelve years administered the national finances with the greatest skill. He and Jefferson were both imbued with the idea that government could be carried on upon a priori principles resting on the assumed perfectness of human nature, and the chief burden of carrying out this theory fell upon Gallatin. His guiding principles were still simplicity of administration and speedy extinction of all debt, and everything bent to these objects. Fighting or bribing the Barbary pirates was a mere question of expense. It was cheaper to seize Louisiana than to await the settlement of doubtful points. Commercial warfare was to be avoided because of the cost.

All wars were bad, but if they could not be evaded it was less extravagant to be ready than to rush to arms unprepared. Amid many difficulties, and thwarted even by Jefferson himself in the matter of the navy, Gallatin pushed on; and after six years the public debt was decreased (in spite of the Louisiana purchase) by \$14,260,000, a large surplus was on hand, a comprehensive and beneficent scheme of internal improvements was ready for execution, and the promised land seemed in sight. Then came the stress of war in Europe, a wretched neutrality at home, fierce outbreaks of human passions, and the fair structure of government by a priori theories based on the goodness of unoppressed humanity came to the ground. Gallatin was thrown helplessly back upon the rejected Federalist doctrine of government according to circumstances. He uttered no vain regrets, but the position was a trying one. The sworn foe of strong government, he was compelled, in pursuance of Jefferson's policy, to put into execution the Embargo and other radical and stringent measures. He did his best, but all was in vain. Commercial warfare failed, the Embargo was repealed, and Jefferson, having entangled foreign relations and brought the country to the verge of civil war, retired to private life, leaving to his successor Madison, and to Gallatin, the task of extricating the nation from its difficulties. From 1800 the new-administration, drifting steadily towards war, struggled on from one abortive and exasperating negotiation to another. It was a period of sore trial to Gallatin. The peace policy had failed, and nothing else replaced it. He had lost his hold upon Pennsylvania and his support in the house, while a cabal in the senate, bitterly and personally hostile to the treasury, crippled the administration and reduced every government measure to mere inanity. At last, however, in June 1812, congress on Madison's recommendation declared war against England.

Gallatin never wasted time in futile complaints. His cherished schemes were shattered. War and extravagant expenditure had come, and he believed both to be fatal to the prosperity and progress of America. He therefore put the finances in the best order he could, and set himself to mitigate the evil effects of the war by obtaining an early peace. With this end in view he grasped eagerly at the proffered mediation of Russia, and without resigning the treasury sailed for Europe in May 1813.

Russian mediation proved barren, but Gallatin persevered, catching at every opportunity for negotiation. In the midst of his labours came the news that the senate had refused to confirm his appointment as peace commissioner. He still toiled unofficially until, the objection of the senate having been met by the appointment of a new secretary of the treasury, his second nomination was approved, and he was able to proceed with direct negotiations. The English and American commissioners finally met at Ghent, and in the tedious and irritating discussions which ensued Gallatin took the leading part. His great difficulty lay in managing his colleagues, who were, especially Henry Clay and John Quincy Adams, able men of strong wills and jarring tempers. He succeeded in preserving harmony, and thus established his own reputation as an able diplomatist. Peace was his reward; on the 24th of December 1814 the treaty was signed; and after visiting Geneva for the first time since his boyhood, and assisting in negotiating a commercial convention (1815) with England by which all discriminating duties were abolished, Gallatin in July 1815 returned to America.

While still in Europe he had been asked by Madison to become minister to France; this appointment he accepted in January 1816, and adhered to his acceptance in spite of his being asked in April 1816 to serve once more as secretary of the treasury. He remained in France for the next seven years. He passed his time in thoroughly congenial society, seeing everybody of note or merit in Europe. He did not neglect the duties of his official position, but strove assiduously and with his wonted patience to settle the commercial relations of his adopted country with the nations of Europe, and in 1818 assisted Richard Rush, then United States minister in London, in negotiating a commercial convention with Great Britain to take the place of that negotiated in 1815.

In June 1823 he returned to the United States, where he found himself plunged at once into the bitter struggle then in progress for the presidency. His favourite candidate was his personal friend William H. Crawford, whom he regarded as the true heir and representative of the old Jeffersonian principles. With these feelings he consented in May 1824 to stand for the vice-presidency on the Crawford ticket. But Gallatin had come home to new scenes and new actors, and he did not fully appreciate the situation. The contest was bitter, personal, factious and full of intrigue. Martin Van Buren, then in the Crawford interest, came to the conclusion that the candidate for the second place, by his foreign origin, weakened the ticket, and in October Gallatin retired from the contest. The election, undecided by the popular vote, was thrown into the house, and resulted in the choice of John Quincy Adams, who in 1826 drew Gallatin from his retirement and sent him as minister to England to conduct another complicated and arduous negotiation. Gallatin worked at his new task with his usual industry, tact and patience, but the results were meagre, although an open breach on the delicate question of the north-east boundary of the United States was avoided by referring it to the arbitration of the king of the Netherlands. In November 1827 he once more returned to the United States and bade farewell to public life.

Taking up his residence in New York, he was in 1832-1839 president of the National Bank (afterwards the Gallatin Bank) of New York, but his duties were light, and he devoted himself chiefly to the congenial pursuits of science and literature. In both fields he displayed much talent, and by writing his *Synopsis of the Indian Tribes within the United States East of the Rocky Mountains and in the British and Russian Possessions in North America* (1836), and by founding the American Ethnological Society of New York in 1842, he earned the title of "Father of American Ethnology." He continued, of course, to interest himself in public affairs, although no longer an active participant, and in all financial questions, especially in regard to the bank charter, the resumption of specie payments, and the panic of 1837, he exerted a powerful influence. The rise of the slavery question touched him nearly. Gallatin had always been a consistent opponent of slavery; he felt keenly, therefore, the attempts of the South to extend the slave power and confirm its existence, and the remnant of his strength was devoted in his last days to writing and distributing two able pamphlets against the war with Mexico. Almost his last public act was a speech, on the 24th of April 1844, in New York City, against the annexation of Texas; and in his eighty-fourth year he confronted a howling New York mob with the same cool, unflinching courage which he had displayed half a century before when he faced the armed frontiersmen of Redstone Old Fort. During the winter of 1848-1849 his health failed, and on the 12th of August 1849, at the home of his daughter in Astoria, Long Island, he passed peacefully away.

Gallatin was twice married. His second wife, whom he married in November 1793, was Miss Hannah Nicholson, of New York, the daughter of Com. James Nicholson (1737-1804), an American naval officer, commander-in-chief of the navy from 1777 until August 1781, when with his ship the "Virginia," he was taken by the British "Iris" and "General Monk." By her he had three children, two sons and a daughter, who all survived him. In personal appearance he was above middle height, with strongly-marked features, indicating great strength of intellect and character. He was reserved and very reticent, cold in manner and not sympathetic. There was, too, a certain Calvinistic austerity about him. But he was much beloved by his family. He was never a popular man, nor did he ever have a strong personal following or many attached friends. He stood, with Jefferson and Madison, at the head of his party, and won his place by force of character, courage, application and intellectual power. His eminent and manifold services to his adopted country, his great abilities and upright character, assure him a high position in the history of the United States.

The Writings of Albert Gallatin, edited by Henry Adams, were published at Philadelphia, in three volumes, in 1879. With these

volumes was published an excellent biography, *The Life of Albert Gallatin*, also by Henry Adams; another good biography is John Austin Stevens's *Albert Gallatin* (Boston, 1884) in the "American Statesmen" series. (H. C. L.)

GALLAUDET, THOMAS HOPKINS (1787-1851), American educator of the deaf and dumb, was born in Philadelphia, Pennsylvania, of French Huguenot ancestry, on the 10th of December 1787. He graduated at Yale in 1805, where he was a tutor from 1808 to 1810. Subsequently he studied theology at Andover, and was licensed to preach in 1814, but having determined to abandon the ministry and devote his life to the education of deaf mutes, he visited Europe in 1815-1816, and studied the methods of the abbé Sicard in Paris, and of Thomas Braidwood (1715-1806) and his successor Joseph Watson (1765-1829) in Great Britain. Returning to the United States in 1816, he established at Hartford, Connecticut, with the aid of Laurent Clerc (1785-1869), a deaf mute assistant of the abbé Sicard, a school for deaf mutes, in support of which Congress, largely through the influence of Henry Clay, made a land grant, and which Gallaudet presided over with great success until ill-health compelled him to retire in 1830. It was the first institution of the sort in the United States, and served as a model for institutions which were subsequently established. He died at Hartford, Connecticut, on the 5th of September 1851.

There are three accounts of his life, one by Henry Barnard, *Life, Character and Services of the Rev. Thomas H. Gallaudet* (Hartford, 1852); another by Herman Humphrey (Hartford, 1858), and a third (and the best one) by his son Edward Miner Gallaudet (1888).

His son, THOMAS GALLAUDET (1822-1902), after graduating at Trinity College in 1842, entered the Protestant Episcopal ministry, settled in New York City, and there in 1852 organized St Anne's Episcopal church, where he conducted services for deaf mutes. In 1872 he organized and became general manager of the Church mission to deaf mutes, and in 1885 founded the Gallaudet home for deaf mutes, particularly the aged, at Wappingers Falls, near Poughkeepsie, New York.

Another son, EDWARD MINER GALLAUDET (b. 1837), was born at Hartford, Connecticut, on the 3rd of February 1837, and graduated at Trinity College in 1856. After teaching for a year in the institution for deaf mutes founded by his father at Hartford, he removed with his mother, Sophia Fowler Gallaudet (1798-1877), to Washington, D. C., where at the request of Amos Kendall (1789-1869), its founder, he organized and took charge of the Columbia Institution for the deaf and dumb, which received support from the government, and of which he became president. This institution was the first to furnish actual collegiate education for deaf mutes (in 1864 it acquired the right to grant degrees), and was successful from the start. The Gallaudet College (founded in 1864 as the National Deaf Mute College and renamed in 1893 in honour of Thomas H. Gallaudet) and the Kendall School are separate departments of this institution, under independent faculties (each headed by Gallaudet), but under the management of one board of directors.

GALLE, or POINT DE GALLE, a town and port of Ceylon on the south-west coast. It was made a municipality in 1865, and divided into the five districts of the Fort, Callowelle, Galopladde, Hirimbure and Cumbalwalla. The fort, which is more than a mile in circumference, overlooks the whole harbour, but is commanded by a range of hills. Within its enclosure are not only several government buildings, but an old church erected by the Dutch East India Company, a mosque, a Wesleyan chapel, a hospital, and a considerable number of houses occupied by Europeans. The old Dutch building known as the queen's house, or governor's residence, which dated from 1687, was in such a dilapidated state that it was sold by the governor, Sir William Gregory, in 1873. Elsewhere there are few buildings of individual note, but the general style of domestic architecture is pleasant and comfortable, though not pretentious. One of the most delightful features of the place is the profusion of trees, even within the town, and along the edge of the shore—suriyas, palms, coco-nut trees and bread-fruit trees. The ramparts towards the sea furnish fine promenades. In the harbour deep water is found close to the shore, and the outer roads are spacious; but the south-west

monsoon renders entrance difficult, and not unfrequently drives vessels from their moorings.

The opening of the Suez Canal in 1869, and the construction of a breakwater at Colombo, leading to the transfer of the mail and most of the commercial steamers to the capital of the island, seriously diminished the prosperity of Galle. Although a few steamers still call to coal and take in some cargo, yet the loss of the Peninsular and Oriental and other steamer agencies reduced the port to a subordinate position; nor has the extension of the railway from Colombo, and beyond Galle to Matara, very much improved matters. The tea-planting industry has, however, spread to the neighbourhood, and a great deal is done in digging plumbago and in growing grass for the distillation of citronella oil. The export trade is chiefly represented by coco-nut oil, plumbago, coir yarn, fibre, rope and tea. In the import trade cotton goods are the chief item. Both the export and import trade for the district, however, now chiefly passes through Colombo. Pop. (1901) 37,165.

Galle is mentioned by none of the Greek or Latin geographers, unless the identification with Ptolemy's Avium Promontorium or Cape of Birds be a correct one. It is hardly noticed in the native chronicles before 1267, and Ibn Batuta, in the middle of the 14th century, distinctly states that Kali—that is, Galle—was a small town. It was not till the period of Portuguese occupation that it rose to importance. When the Dutch succeeded the Portuguese they strengthened the fortifications, which had been vigorously defended against their admiral, Koster; and under their rule the place had the rank of a commandancy. In the marriage treaty of the infanta of Portugal with Charles II. of England it was agreed that if the Portuguese recovered Ceylon they were to hand over Galle to the English; but as the Portuguese did not recover Ceylon the town was left to fall into English hands at the conquest of the island from the Dutch in 1796. The name Galle is derived from the Sinhalese *galla*, equivalent to "rock"; but the Portuguese and Dutch settlers, being better fighters than philologists, connected it with the Latin *gallus*, a cock, and the image of a cock was carved as a symbol of the town in the front of the old government house.

GALLENKA, ANTONIO CARLO NAPOLEONE (1810-1895), Italian author and patriot, born at Parma on the 4th of November 1810, was the eldest son of a Piedmontese of good family, who served for ten years in the French army under Massena and Napoleon. He had finished his education at the university of Parma, when the French Revolution of 1830 caused a ferment in Italy. He sympathized with the movement, and within a few months was successively a conspirator, a state prisoner, a combatant and a fugitive. For the next five years he lived a wandering life in France, Spain and Africa. In August 1836 he embarked for New York, and three years later he proceeded to England, where he supported himself as a translator and teacher of languages. His first book, *Italy; General Views of its History and Literature*, which appeared in 1841, was well received, but was not successful financially. On the outbreak of the Italian revolution in 1848 he at once put himself in communication with the insurgents. He filled the post of Chargé d'Affaires to Piedmont at Frankfurt in 1848-1849, and for the next few years he travelled incessantly between Italy and England, working for the liberation of his country. In 1854, through Cavour's influence, he was elected a deputy to the Italian parliament. He retained his seat until 1864, passing the summer in England and fulfilling his parliamentary duties at Turin in the winter. On the outbreak of the Austro-French War of 1859 he proceeded to Lombardy as war correspondent of *The Times*. The campaign was so brief that the fighting was over before he arrived, but his connexion with *The Times* endured for twenty years. He was a forcible and picturesque writer, with a command of English remarkable for an Italian. He materially helped to establish that friendly feeling towards Italy which became traditional in England. In 1859 Gallenga purchased the Falls, at Llandogo on the Wye, as a residence, and thither he retired in 1885. He died at this house on the 17th of December 1895. He was twice married. Among his chief works are an *Historical Memoir of Frà Dolcino and his Times* (1853); a *History of Piedmont* (3 vols., 1855; Italian translation, 1856); *Country Life in Piedmont* (1858); *The Invasion of Denmark* (2 vols., 1864); *The Pearl of the Antilles* [travels in Cuba] (1873); *Italy Remitted*

(2 vols., 1875); *Two Years of the Eastern Question* (2 vols., 1877); *The Pope* [Pius IX.] *and the King* [Victor Emmanuel] (2 vols., 1879); *South America* (1880); *A Summer Tour in Russia* (1882); *Iberian Reminiscences* (2 vols., 1883); *Episodes of my Second Life* (1884); *Italy, Present and Future* (2 vols., 1887). Gallenga's earlier publications appeared under the pseudonym of Luigi Mariotti.

GALLERY (through Ital. *galleria*, from Med. Lat. *galeria*, of which the origin is unknown),¹ a covered passage or space outside a main wall, sometimes used as a verandah if on the ground floor, and as a balcony if on an upper floor and supported by columns, piers or corbels; similarly the upper seats in a theatre or a church, on either side as in many 17th-century churches, or across the west end under the organ. The word is also used of an internal passage primarily provided to place various rooms in communication with one another; but if of narrow width this is usually called a corridor or passage. When of sufficient width the gallery is utilized to exhibit pictures and other art treasures. In the 16th century the picture gallery formed the largest room or hall in English mansions, with wainscoted walls and a richly decorated plaster ceiling; the principal examples are those of Audley End, Essex (226 ft. by 34 ft.); Hardwick, Derbyshire (166 ft. by 22 ft.); Hatfield, Hertfordshire (163 ft. by 19 ft. 6 in.); Aston Hall, near Birmingham (136 ft. by 18 ft.); Haddon Hall, Derbyshire (116 ft. by 17 ft.); and Montacute in Somersetshire (189 ft. by 22 ft.). Hence the application of the term to art museums (the National Gallery, &c.) and also to smaller rooms with top-light in which temporary exhibitions are held.

GALLEY (derived through the O. Fr. *galce*, *galic*, from the Med. Lat. *galea*, Ital. *galea*, Port. *galé*, of uncertain origin; from the Med. Lat. variant form *galera* are derived the Mod. Fr. *galère*, Span. and Ital. *galera*), a long single or half decked vessel of war, with low free-board, propelled primarily by oars or sweeps, but also having masts for sails. The word is used generally of the ancient war vessels of Greece and Rome of various types, whose chief propelling power was the oar or sweep, but its more specific application is to the medieval war vessel which survived in the navies of the Mediterranean sea-powers after the general adoption of the larger many-decked ship of war, propelled solely by sail-power. Lepanto (1571) was the last great naval battle in which the galley played the principal part. The "galleass" or "gallias" (Med. Lat. *galeassa*, Ital. *galeassa*, an augmented form of *galea*) was a larger and heavier form of galley; it usually carried three masts and had at bow and stern a castellated structure. The "galliot" (O. Fr. *galiot*, Span. and Port. *galcoia*, Ital. *galcoia*, a diminutive of *galea*) was a small light type of galley. The "galloon" (formerly in English "galloon," Fr. *galion*, derived from the Med. Lat. *galio*, *galionis*, a derivative of *galea*) was a sailing ship of war and trade, shorter than the galley and standing high out of the water with several decks, chiefly used by the Spaniards during the 16th century in the carrying of treasure from America. The number of oars or sweeps varied, the larger galley having twenty-five on each side; the galleass as many as thirty-two, each being worked by several men. This labour was from the earliest times often performed by slaves or prisoners of war. It became the custom among the Mediterranean powers to sentence condemned criminals to row in the war galleys of the state. Traces of this in France can be found as early as 1532, but the first legislative enactment is in the *Ordonnance d'Orléans* of 1561. In 1564 Charles IX. forbade the sentencing of prisoners to the galleys for less than ten years. The galley-slaves were branded with the letters GAL. At the end of the reign of Louis XIV. the use of the galley for war purposes had practically ceased, but the corps of the galleys was not incorporated with the navy till 1748. The headquarters of the galleys and of the convict rowers (*galériens*) was at Marseilles. The majority of these latter were brought to Toulon, the others were sent to Rochefort and Brest, where they were used for work

¹ Du Cange, *Glossarium*, s.v. "Galeria," suggests an origin from *galera*, a galley, on the analogy of "nave," from *navis*, the galley being a long and narrow ship; but, he adds, *alii alia opinantur*.

in the arsenal. At Toulon the convicts remained (in chains) on the galleys, which were moored as hulks in the harbour. Shore prisons were, however, provided for them, known as *bagnes*, baths, a name given to such penal establishments first by the Italians (*bagno*), and said to have been derived from the prison at Constantinople situated close by or attached to the great baths there. The name *galérien* was still given to all convicts, though the galleys had been abandoned, and it was not till the French Revolution that the hated name with all it signified was changed to *forçat*. In Spain *galera* is still used for a criminal condemned to penal servitude.

A vivid account of the life of galley-slaves in France is given in Jean Marteilhes's *Memoirs of a Protestant*, translated by Oliver Goldsmith (new edition, 1895), which describes the experiences of one of the Huguenots who suffered after the revocation of the edict of Nantes.

GALLIA CISALPINA (Lat. *Cis*, on this side, i.e. of the Alps), in ancient geography, that portion of northern Italy north of Liguria and Umbria and south of the Alps, which was inhabited by various Celtic and other peoples, of whom the Celts were in continual hostility to Rome. In early times it was bounded on the S. by Liguria and the Aesis, in Caesar's time by Liguria and the Rubicon. After the Second Punic War (203 B.C.) these tribes were severely punished by the Roman generals for the assistance they had rendered to Hannibal. Sulla divided the district into two parts; the region between the Aesis and the Rubicon was made directly subject to the government at Rome, while the northern portion was put under a distinct authority, probably similar to the usual transmarine commands (see Mommsen, *Hist. of Rome*, Eng. trans., bk. iv. c. 10).

For the early Celtic and other peoples and the later history of the district see ITALY (ancient), and **ROME: History, Ancient**.

GALLIC ACID, trioxybenzoic acid (HO)(3.4.5).C₆H₂CO₂H.H₂O, the *acidum gallicum* of pharmacy, a substance discovered by K. W. Scheele; it occurs in the leaves of the bearberry, in pomegranate root-bark, in tea, in gall-nuts to the extent of about 3%, and in other vegetable productions. It may be prepared by keeping moist and exposed to the air for from four to six weeks, at a temperature of 20° to 25° C., a paste of powdered gall-nuts and water, and removing from time to time the mould which forms on its surface; the paste is then boiled with water, the hot solution filtered, allowed to cool, the separated gallic acid drained, and purified by dissolving in boiling water, recrystallization at about 27° C., and washing of the crystals with ice-cold water. The production of the acid appears to be due to the presence in the galls of a ferment. Gallic acid is most readily obtained by boiling the tannin procured from oak-galls by means of alcohol and ether with weak solution of acids. It may also be produced by heating an aqueous solution of di-iodosalicylic acid with excess of alkaline carbonate, by acting on dibromosalicylic acid with moist silver oxide, and by other methods. It crystallizes in white or pale fawn-coloured acicular prisms or silky needles, and is soluble in alcohol and ether, and in 100 parts of cold and 3 of boiling water; it is without odour and has an astringent and an acid taste and reaction. It melts at about 200° C., and at 210° to 215° it is resolved into carbon dioxide and pyrogallol, C₆H₂(OH)₃. With ferric salts its solution gives a deep blue colour, and with ferrous salts, after exposure to the air, an insoluble, blue-black, ferroso-ferric gallate. Bases of the alkali metals give with it four series of salts; these are stable except in alkaline solutions, in which they absorb oxygen and turn brown. Solution of calcium bicarbonate becomes with gallic acid, on exposure to the air, of a dark blue colour. Unlike tannic acid, gallic acid does not precipitate albumen or salts of the alkaloids, or, except when mixed with gum, gelatin. Salts of gold and silver are reduced by it, slowly in cold, instantaneously in warm solutions, hence its employment in photography. With phosphorus oxychloride at 120° C. gallic acid yields tannic acid, and with concentrated sulphuric acid at 100°, *rufigallic acid*, C₁₂H₆O₈, an anthracene derivative. Oxidizing agents, such as arsenic acid, convert it into *dlagic acid*, C₁₀H₆O₇+H₂O, probably a fluorene derivative, a substance which occurs in gall-nuts, in the external membrane of the epispem of the walnut, and prob-

ably in many plants, and composes the "bezoar stones" found in the intestines of Persian wild goats. Medicinally, gallic acid has been, and is still, largely used as an astringent, styptic and hæmstatic. Gallic acid, however, does not coagulate albumen and therefore possesses no local astringent action. So far is it from being an hæmstatic that, if perfused through living blood-vessels, it actually dilates them. Its rapid neutralization in the intestine renders it equally devoid of any remote actions.

GALLICANISM, the collective name for various theories maintaining that the church and king of France had ecclesiastical rights of their own, independent and exclusive of the jurisdiction of the pope. Gallicanism had two distinct sides, a constitutional and a dogmatic, though both were generally held together, the second serving as the logical basis of the first. And neither is intelligible, except in relation to the rival theory of Ultramontanism (*q.v.*). Dogmatic Gallicanism was concerned with the question of ecclesiastical government. It maintained that the church's infallible authority was committed to pope and bishops jointly. The pope decided in the first instance, but his judgments must be tacitly or expressly confirmed by the bishops before they had the force of law. This ancient theory survived much longer in France than in other Catholic countries. Hence the name of Gallican is loosely given to all its modern upholders, whether of French nationality or not. Constitutional Gallicanism dealt with the relation of church and state in France. It began in the 13th century, as a protest against the theoretic pretensions of the medieval popes. They claimed that they, as vicars of Christ, had the right to interfere in the temporal concerns of princes, and even to depose sovereigns of whom they disapproved. Gallicanism answered that kings held their power directly of God; hence their temporal concerns lay altogether outside the jurisdiction of the pope. During the troubles of the Reformation era, when the papal deposing power threatened to become a reality, the Gallican theory became of great importance. It was elaborated, and connected with dogmatic Gallicanism, by the famous theologian, Edmond Richer (1559-1631), and finally incorporated by Bossuet in a solemn Declaration of the French Clergy, made in 1682. This document lays down: (1) that the temporal sovereignty of kings is independent of the pope; (2) that a general council is above the pope; (3) that the ancient liberties of the Gallican Church are sacred; (4) that the infallible teaching authority of the church belongs to pope and bishops jointly. This declaration led to a violent quarrel with Rome, and was officially withdrawn in 1693, though its doctrines continued to be largely held. They were asserted in an extreme form in the Civil Constitution of the Clergy (1790), which almost severed connexion between France and the papacy. In 1802 Napoleon contented himself by embodying Bossuet's declaration textually in a statute. Long before his time, however, the issue had been narrowed down to determining exactly how far the pope should be allowed to interfere in French ecclesiastical affairs. Down to the repeal of the Concordat in 1905 all French governments continued to uphold two of the ancient "Gallican Liberties." The secular courts took cognizance of ecclesiastical affairs whenever the law of the land was alleged to have been broken; and papal bulls were not allowed to be published without the leave of the state. (See also FEBRONIANISM.) (ST. C.)

GALLIENI, JOSEPH SIMON (1849-), French soldier and colonial administrator, was born at Saint-Béat, in the department of Haute-Garonne, on the 24th of April 1849. He left the military academy of Saint-Cyr in July 1870 as a second lieutenant in the Marines, becoming lieutenant in 1873 and captain in 1878. He saw service in the Franco-German War, and between 1877 and 1881 took an important part in the explorations and military expeditions by which the French dominion was extended in the basin of the upper Niger. He rendered a particularly valuable service by obtaining, in March 1881, a treaty from Ahmadu, almany of Segu, giving the French exclusive rights of commerce on the upper Niger. For this he received the gold medal of the Société de Géographie. From 1883 to 1886 Gallieni was stationed in Martinique. On the 24th of June 1886 he attained the rank

of lieutenant-colonel, and on the 20th of December was nominated governor of Upper Senegal. He obtained several successes against Ahmadu in 1887, and compelled Samory to agree to a treaty by which he abandoned the left bank of the Niger (see *SENEGAL: History*). In connexion with his service in West Africa, Gallieni published two works—*Mission d'exploration du Haut-Niger, 1879-1881* (Paris, 1885), and *Deux Campagnes au Soudan français* (Paris, 1891)—which, besides possessing great narrative interest, give information of considerable value in regard to the resources and topography of the country. In 1888 Gallieni was made an officer of the Legion of Honour. In 1891 he attained the rank of colonel, and from 1893 to 1895 he served in Tongking, commanding the second military division of the territory. In 1899 he published his experiences in *Trois Colonnes au Tonkin*. In 1896 Madagascar was made a French colony, and Gallieni was appointed resident-general (a title changed in 1897 to governor-general) and commander-in-chief. Under the weak administration of his predecessor a widespread revolt had broken out against the French. By a vigorous military system Gallieni succeeded in completing the subjugation of the island. He also turned his attention to the destruction of the political supremacy of the Hovas and the restoration of the autonomy of the other tribes. The execution of the queen's uncle, Ratsimamanga, and of Rainandrianampandry, the minister of the interior, in October 1896, and the exile of Queen Ranavalao III. herself in 1897, on the charge of fomenting rebellion, broke up the Hova hegemony, and made an end of Hova intrigues against French rule. The task of government was one of considerable difficulty. The application of the French customs and other like measures, disastrous to British and American trade, were matters for which Gallieni was not wholly responsible. His policy was directed to the development of the economic resources of the island and was conciliatory towards the non-French European population. He also secured for the Protestants religious liberty. In 1899 he published a *Rapport d'ensemble sur la situation générale de Madagascar*. In 1905, when he resigned the governorship, Madagascar enjoyed peace and a considerable measure of prosperity. In 1906 General Gallieni was appointed to command the XIV. army corps and military government of Lyons. He reviewed the results of his Madagascar administration in a book entitled *Neuf Ans à Madagascar* (Paris, 1908).

GALLIENUS, PUBLIUS LICINIUS SEGNATIUS, Roman emperor from A.D. 260 to 268, son of the emperor Valerian, was born about 218. From 253 to 260 he reigned conjointly with his father, during which time he gave proof of military ability and bravery. But when his father was taken prisoner by Shapur I. of Persia, in 260, Gallienus made no effort to obtain his release, or to withstand the incursions of the invaders who threatened the empire from all sides. He occupied part of his time in dabbling in literature, science and various trifling arts, but gave himself up chiefly to excess and debauchery. He deprived the senators of their military and provincial commands, which were transferred to equestrians. During his reign the empire was ravaged by a fearful pestilence; and the chief cities of Greece were sacked by the Goths, who descended on the Greek coast with a fleet of five hundred. His generals rebelled against him in almost every province of the empire, and this period of Roman history came to be called the reign of the Thirty Tyrants. Nevertheless, these usurpers probably saved the empire at the time, by maintaining order and repelling the attacks of the barbarians. Gallienus was killed at Mediolanum by his own soldiers while besieging Aureolus, who was proclaimed emperor by the Illyrian legions. His sons Valerianus and Saloninus predeceased him.

Life by Trebellius Pollio in *Script. Hist. Aug.*: on coins see articles in *Numism. Zeit.* (1908) and *Riv. ital. d. num.* (1908).

GALLIFFET, GASTON ALEXANDRE AUGUSTE, MARQUIS DE, Prince de Martignes (1830-1909), French general, was born in Paris on the 23rd of January 1830. He entered the army in 1848, was commissioned as sub-lieutenant in 1853, and served with distinction at the siege of Sevastopol in 1855, in the Italian campaign of 1859, and in Algeria in 1860, after which for a time he served on the personal staff of the emperor Napoleon III. He

displayed great gallantry as a captain at the siege and storm of Puebla, in Mexico, in 1863, when he was severely wounded. When he returned to France to recover from his wounds he was entrusted with the task of presenting the captured standards and colours to the emperor, and was promoted *chef d'escadrons*. He went again to Algeria in 1864, took part in expeditions against the Arabs, returned to Mexico as lieutenant-colonel, and, after winning further distinction, became in 1867 colonel of the 3rd Chasseurs d'Afrique. In the Franco-German War of 1870-71 he commanded this regiment in the army of the Rhine, until promoted to be general of brigade on the 30th of August. At the battle of Sedan he led the brigade of Chasseurs d'Afrique in the heroic charge of General Margueritte's cavalry division, which extorted the admiration of the old king of Prussia. Made prisoner of war at the capitulation, he returned to France during the siege of Paris by the French army of Versailles, and commanded a brigade against the Communists. In the suppression of the Commune he did his duty rigorously and inflexibly, and on that ground earned a reputation for severity, which, throughout his later career, and in all his efforts to improve the French army, made him the object of unceasing attacks in the press and the chamber of deputies. In 1872 he took command of the Batna subdivision of Algeria, and commanded an expedition against El Golea, surmounting great difficulties in a rapid march across the desert, and inflicting severe chastisement on the revolted tribes. On the general reorganization of the army he commanded the 31st infantry brigade. Promoted general of division in 1875, he successively commanded the 15th infantry division at Dijon, the IX. army corps at Tours, and in 1882 the XII. army corps at Limoges. In 1885 he became a member of the Conseil Supérieur de la Guerre. He conducted the cavalry manoeuvres in successive years, and attained a European reputation on all cavalry questions, and, indeed, as an army commander. Decorated with the grand cross of the Legion of Honour in 1887, he received the military medal for his able conduct of the autumn manoeuvres in 1891, and after again commanding at the manoeuvres of 1894 he retired from the active list. Afterwards he took an important part in French politics, as war minister (22nd of June 1899 to 20th of May 1900) in M. Waldeck-Rousseau's cabinet, and distinguished himself by the firmness with which he dealt with cases of unrest in the army, but he then retired into private life, and died on the 8th of July 1909.

GALLIO, JUNIUS ANNAEUS (originally **LUCIUS ANNAEUS NOVATUS**), son of the rhetorician L. Annaeus Seneca and the elder brother of L. Annaeus Seneca the philosopher, was born at Corduba (Cordova) about the beginning of the Christian era. At Rome he was adopted by L. Junius Gallio, a rhetorician of some repute, from whom he took the name of Junius Gallio. His brother Seneca, who dedicated to him the treatises *De Ira* and *De Vita Beata*, speaks of the charm of his disposition, also alluded to by the poet Statius (*Silvae*, ii. 7, 32). It is probable that he was banished to Corsica with his brother, and that both returned together to Rome when Agrippina selected Seneca to be tutor to Nero. Towards the close of the reign of Claudius, Gallio was proconsul of the newly constituted senatorial province of Achaëa, but seems to have been compelled by ill-health to resign the post within a few years. During his tenure of office (in 53) he dismissed the charge brought by the Jews against the apostle Paul (*Acts xviii.*). His behaviour on this occasion ("But Gallio cared for none of these things") shows the impartial attitude of the Roman officials towards Christianity in its early days. He survived his brother Seneca, but was subsequently put to death by order of Nero (in 65) or committed suicide.

Tacitus, *Annals*, xv. 73; Dio Cassius ix. 35, lxii. 25; Sir W. M. Ramsay, *St Paul the Traveller*, pp. 257-261; art. in *Hastings' Dict. of the Bible* (H. Cowan). An interesting reconstruction is given by Anatole France in *Sur la pierre blanche*.

GALLIPOLI (anc. *Callipolis*), a seaport town and episcopal see of Apulia, Italy, in the province of Lecce, 31 m. S by W of it by rail, 46 ft. above sea-level. Pop. (1901) town, 10,300, commune, 13,459. It is situated on a rocky island in the Gulf of Taranto, but is united to the mainland by a bridge, protected by

a castle constructed by Charles I. of Anjou. The other fortifications have been removed. The handsome cathedral dates from 1629. The town was once famous for its exports of olive-oil, which was stored, until it clarified, in cisterns cut in the rock. This still continues, but to a less extent; the export of wine, however, is increasing, and fruit is also exported.

The ancient Callipolis was obviously of Greek origin, as its name ("beautiful city") shows. It is hardly mentioned in ancient times. Pliny tells us that in his time it was known as *Anza*. It lay a little off the road from Tarentum to Hydruntum, but was reached by a branch from Aletium (the site is marked by the modern church of S. Maria della Lizza), among the ruins of which many Messapian inscriptions, but no Latin ones, have been found.

(T. As.)

GALLIPOLI (Turk. *Geibolu*, anc. Καλλιπολις), a seaport and city of European Turkey, in the vilayet of Adrianople; at the north-western extremity of the Dardanelles, on a narrow peninsula 132 m. W.S.W. of Constantinople, and 90 m. S. of Adrianople, in 40° 24' N. and 26° 40' 30" E. Pop. (1905) about 25,000. Nearly opposite is Lapsaki on the Asiatic side of the channel, which is here about 2 m. wide. Gallipoli has an unattractive appearance; its streets are narrow and dirty, and many of its houses are built of wood, although there are a few better structures, occupied by the foreign residents and the richer class of Turkish citizens. The only noteworthy buildings are the large, crowded and well-furnished bazaars with leaden domes. There are several mosques, none of them remarkable, and many interesting Roman and Byzantine remains, especially a magazine of the emperor Justinian (483-565), a square castle and tower attributed to Bayezid I. (1389-1403), and some tumuli on the south, popularly called the tombs of the Thracian kings. The lighthouse, built on a cliff, has a fine appearance as seen from the Dardanelles. Gallipoli is the seat of a Greek bishop. It has two good harbours, and is the principal station for the Turkish fleet. From its position as the key of the Dardanelles, it was occupied by the allied French and British armies in 1854. Then the isthmus a few miles north of the town, between it and Bulair, was fortified with strong earthworks by English and French engineers, mainly on the lines of the old works constructed in 1357. These fortifications were renewed and enlarged in January 1878, on the Russians threatening to take possession of Constantinople. The peninsula thus isolated by the fortified positions has the Gulf of Saros on the N.W., and extends some 50 m. S.W. The guns of Gallipoli command the Dardanelles just before the strait joins the Sea of Marmora. The town itself is not very strongly fortified, the principal fortifications being farther down the Dardanelles, where the passage is narrower.

The district (*sanjak*) of Gallipoli is exceedingly fertile and well adapted for agriculture. It has about 100,000 inhabitants, and comprises four *kazas* (cantons), namely, (1) Maitos, noted for its excellent cotton; (2) Keshan, lying inland north of Gallipoli, noted for its cattle-market, and producing grain, linseed and canary seed; (3) Myrioityo; and (4) Sharkeui or Shar-Koi (Peristeri) on the coast of the Sea of Marmora. Copper ore and petroleum are worked at Sharkeui, and the neighbourhood formerly produced wine that was highly esteemed and largely exported to France for blending. Heavy taxation, however, amounting to 55% of the value of the wine, broke the spirit of the viticulturists, most of whom uprooted their vines and replanted their lands with mulberry trees, making sericulture their occupation.

There are no important industrial establishments in Gallipoli itself, except steam flour-mills and a sardine factory. The line of railway between Adrianople and the Aegean Sea has been prejudicial to the transit trade of Gallipoli, and several attempts have been made to obtain concessions for the construction of a railway that would connect this port with the Turkish railway system. Steamers to and from Constantinople call regularly. In 1904 the total value of the exports was £80,000. Wheat and maize are exported to the Aegean islands and to Turkish ports on the mainland; barley, oats and linseed to Great Britain; canary seed chiefly to Australia; beans to France and Spain. Semolina

and bran are manufactured in the district. Live stock, principally sheep, pass through Gallipoli in transit to Constantinople and Smyrna. Cheese, sardines, goats' skins and sheepskins are also exported. The imports include woollen and cotton fabrics from Italy, Germany, France and Great Britain, and hardware from Germany and Austria. These goods are imported through Constantinople. Cordage is chiefly obtained from Servia. Other imports are fuel, iron and groceries.

The Macedonian city of Callipolis was founded in the 5th century B.C. At an early date it became a Christian bishopric, and in the middle ages developed into a great commercial city, with a population estimated at 100,000. It was fortified by the East Roman emperors owing to its commanding strategic position and its valuable trade with Greece and Italy. In 1190 the armies of the Third Crusade, under the emperor Frederick I. (Barbarossa), embarked here for Asia Minor. After the capture of Constantinople by the Latins in 1204, Gallipoli passed into the power of Venice. In 1294 the Genoese defeated a Venetian force in the neighbourhood. A body of Catalans, under Roger Florus, established themselves here in 1306, and after the death of their leader massacred almost all the citizens; they were vainly besieged by the allied troops of Venice and the Empire, and withdrew in 1307, after dismantling the fortifications. About the middle of the 14th century the Turks invaded Europe, and Gallipoli was the first city to fall into their power. The Venetians under Pietro Loredano defeated the Turks here in 1416.

GALLIPOLIS, a city and the county-seat of Gallia county, Ohio, U. S. A., on the Ohio river, about 125 m. E. by S. of Cincinnati. Pop. (1890) 4498; (1900) 5432 (852 negroes); (1910) 5560. It is served by the Kanawha & Michigan (Ohio Central Lines) and the Hocking Valley railways, and (at Gallipolis Ferry, West Virginia, across the Ohio) by the Baltimore & Ohio railway. The city is built on a level site several feet above the river's high-water mark. It has a United States marine hospital and a state hospital for epileptics. Among the city's manufactures are lumber, furniture, iron, stoves, flour and brooms. The municipality owns and operates its waterworks. Gallipolis was settled in 1790 by colonists from France, who had received worthless deeds to lands in Ohio from the Scioto Land Company, founded by Col. William Duer (1747-1799) and others in 1787 and officially organized in 1789 as the *Compagnie du Scioto* in Paris by Joel Barlow, the agent of Duer and his associates abroad, William Playfair, an Englishman, and six Frenchmen. This company had arranged with the Ohio Company in 1787 for the use of about 4,000,000 acres, N. of the Ohio and E. of the Scioto, on which the Ohio Company had secured an option only. The dishonesty of those who conducted the sales in France, the unbusinesslike methods of Barlow, and the failure of Duer and his associates to meet their contract with the Ohio Company, caused the collapse of the Scioto Company early in 1790, and two subsequent attempts to revive it failed. Meanwhile about 150,000 acres had been sold to prospective settlers in France, and in October 1790 the French immigrants, who had been detained for two months at Alexandria, Virginia, arrived on the site of Gallipolis, where rude huts had been built for them. This land, however, fell within the limits of the tract bought outright by the Ohio Company, which sold it to the Scioto Company, and to which it reverted on the failure of the Scioto Company to pay. In 1794 William Bradford, attorney-general of the United States, decided that all rights in the 4,000,000 acres, on which the Ohio Company had secured an option for the Scioto Company, were legally vested in the Ohio Company. In 1795 the Ohio Company sold to the French settlers for \$1.25 an acre the land they occupied and adjacent improved lots, and the United States government granted to them 24,000 acres in the southern part of what is now Scioto County in 1795; little of this land (still known as the "French Grant"), however, was ever occupied by them. Gallipolis was incorporated as a village in 1842, and was first chartered as a city in 1865.

See Theodore T. Belote, *The Scioto Speculation and the French Settlement at Gallipolis* (Cincinnati, 1907), series 2, vol. iii. No. 3 of the *University Studies* of the University of Cincinnati.

GALLITZIN, DEMETRIUS AUGUSTINE (1770-1840), American Roman Catholic priest, called "The Apostle of the Alleghanies," was born at the Hague on the 22nd of December 1770. His name is a form of Golitsuin (*q.v.*), the Russian family from which he came. His father, Dimitri Alexeievich Gallitzin (1735-1803), Russian ambassador to Holland, was an intimate friend of Voltaire and a follower of Diderot; so, too, for many years was his mother, Countess Adelheid Amalie von Schmettau (1748-1806), until a severe illness in 1786 led her back to the Roman Catholic church, in which she had been reared. At the age of seventeen he too became a member of that church. His father had planned for him a diplomatic or military career, and in 1792 he was aide-de-camp to the commander of the Austrian troops in Brabant; but, after the assassination of the king of Sweden, he, like all other foreigners, was dismissed from the service. He then set out to complete his education by travel, and on the 28th of October 1792 arrived in Baltimore, Maryland, where he finally decided to enter the priesthood. He was ordained priest in March 1795, being the first Roman Catholic priest ordained in America, and then worked in the mission at Port Tobacco, Maryland, whence he was soon transferred to the Conewago district. His impulsive objection to some of Bishop Carroll's instructions was sharply rebuked, and he was recalled to Baltimore. But in 1796 he removed to Taneytown, Maryland, and in both Maryland and Pennsylvania worked with such misdirected zeal and autocratic manners that he was again reproved by his bishop in 1798. In the Alleghanies, in 1799, he planned a settlement in what is now Cambria county, Pennsylvania, and bought up much land which he gave or sold at low prices to Catholic immigrants, spending \$150,000 or more in the purchase of some 20,000 acres in a spot singularly ill suited for such an enterprise. In 1808, after his father's death, he was disinherited by the emperor Alexander I. of Russia "by reason of your Catholic faith and your ecclesiastical profession"; and although his sister Anne repeatedly promised him his half of the valuable estate and sent him money from time to time, after her death her brother received little or nothing from the estate. The priest, who after his father's death had in 1809 discarded the name of Augustine Smith, under which he had been naturalized, and had taken his real name, was soon deeply in debt. No small part was a loan from Charles Carroll, and when Gallitzin was suggested for the see of Philadelphia in 1814, Bishop Carroll gave as an objection Gallitzin's "great load of debt rashly, though for excellent and charitable purposes, contracted." In 1815 Gallitzin was suggested for the bishopric of Bardstown, Kentucky, and in 1827 for the proposed see of Pittsburg, and he refused the bishopric of Cincinnati. He died at Loretto, the settlement he had founded in Cambria county, on the 6th of May 1840. Among his parishioners Gallitzin was a great power for good. His part in building up the Roman Catholic Church in western Pennsylvania cannot be estimated; but it is said that at his death there were 10,000 members of his church in the district where forty years before he had found a scant dozen. One of the villages he founded bears his name. Among his controversial pamphlets are: *A Defence of Catholic Principles* (1816), *Letter to a Protestant Friend on the Holy Scriptures* (1820), *Appeal to the Protestant Public* (1834), and *Six Letters of Advice* (1834), in reply to attacks on the Catholic Church by a Presbyterian synod.

See Sarah M. Brownson, *Life of D. A. Gallitzin, Prince and Priest* (New York, 1873); a brief summary of his life by A. A. Lambing in *American Catholic Records* (Pittsburg, Pennsylvania, October 1886, pp. 48-68); and a good bibliography by Thomas C. Middleton in *The Gallitzin Memorandum Book, in American Catholic Historical Society of Philadelphia, Records*, vol. 4, pp. 32-39.

GALLIUM (symbol Ga; atomic weight 69.9), one of the metallic chemical elements. It was discovered in 1875 through its spectrum, in a specimen of zinc blende by Lecoq de Boisbaudran (*Comptes rendus*, 1875, 81, p. 493, and following years). The chief chemical and physical properties of gallium had been predicted many years before by D. Mendeléeff (*c.* 1866) from a consideration of the properties of aluminium, indium and zinc (see ELEMENT). The metal is obtained from zinc blende (which only contains it in very small quantity) by dissolving the mineral in an acid, and

precipitating the gallium by metallic zinc. The precipitate is dissolved in hydrochloric acid and foreign metals are removed by sulphuretted hydrogen; the residual liquid being then fractionally precipitated by sodium carbonate, which throws out the gallium before the zinc. This precipitate is converted into gallium sulphate and finally into a pure specimen of the oxide, from which the metal is obtained by the electrolysis of an alkaline solution. Gallium crystallizes in greyish-white octahedra which melt at 30.15° C. to a silvery-white liquid. It is very hard and but slightly malleable and flexible, although in thin plates it may be bent several times without breaking. The specific gravity of the solid form is 5.956 (24.5° C.), of the liquid 6.069, whilst the specific heats of the two varieties are, for the solid form 0.079 (12-23° C.) and for the liquid 0.082 (106-119°) [M. Berthelot, *Comptes rendus*, 1878, 86, p. 786]. It is not appreciably volatilized at a red heat. Chlorine acts on it readily in the cold, bromine not so easily, and iodine only when the mixture is heated. The atomic weight of gallium has been determined by Lecoq de Boisbaudran by ignition of gallium ammonium alum, and also by L. Meyer and K. Seubert.

Gallium oxide Ga₂O₃ is obtained when the nitrate is heated, or by solution of the metal in nitric acid and ignition of the nitrate. It forms a white friable mass which after ignition is insoluble in acids. On heating to redness in a stream of hydrogen it forms a bluish mass which is probably a lower oxide of composition GaO. Gallium forms colourless salts, which in neutral dilute aqueous solutions are converted on heating into basic salts. The gallium salts are precipitated by alkaline carbonates and by barium carbonate, but not by sulphuretted hydrogen unless in acetic acid solution. Potassium ferrocyanide gives a precipitate even in very dilute solution. In neutral solutions, zinc gives a precipitate of gallium oxide. By heating gallium in a regulated stream of chlorine the dichloride GaCl₂ is obtained as a crystalline mass, which melts at 164° C. and readily decomposes on exposure to moist air. The trichloride GaCl₃ is similarly formed when the metal is heated in a rapid stream of chlorine, and may be purified by distillation in an atmosphere of nitrogen. It forms very deliquescent long white needles melting at 75.5° C. and boiling at 215-220° C. The bromide, iodide and sulphate are known, as is also gallium ammonium alum. Gallium is best detected by means of its spark spectrum, which gives two violet lines of wave length 4171 and 4031.

GALLON, an English measure of capacity, usually of liquids, but also used as a dry measure for corn. A gallon contains four quarts. The word was adapted from an O. Norm. Fr. *galon*, Central Fr. *jalon*, and was Latinized as *galo* and *galona*. It appears to be connected with the modern French *jale*, a bowl, but the ultimate origin is unknown; it has been referred without much plausibility to Gr. γαῦλος, a milk pail. The British imperial gallon of four quarts contains 277.274 cub. in. The old English wine gallon of 231 cub. in. capacity is the standard gallon of the United States.

GALLOWAY, JOSEPH (1731-1803), American lawyer and politician, one of the most prominent of the Loyalists, was born in West River, Anne Arundel county, Maryland, in 1731. He early removed to Philadelphia, where he acquired a high standing as a lawyer. From 1756 until 1774 (except in 1764) he was one of the most influential members of the Pennsylvania Assembly, over which he presided in 1766-1773. During this period, with his friend Benjamin Franklin, he led the opposition to the Proprietary government, and in 1764 and 1765 attempted to secure a royal charter for the province. With the approach of the crisis in the relations between Great Britain and the American colonies he adopted a conservative course, and, while recognizing the justice of many of the colonial complaints, discouraged radical action and advocated a compromise. As a member of the First Continental Congress, he introduced (28th September 1774) a "Plan of a Proposed Union between Great Britain and the Colonies," and it is for this chiefly that he is remembered. It provided for a president-general appointed by the crown, who should have supreme executive authority over all the colonies, and for a grand council, elected triennially by all the several provincial assemblies, and to have such "rights, liberties and privileges as are held and exercised by and in the House of Commons of Great Britain"; the president-general and grand council were to be "an inferior distinct branch of the British legislature, united and incorporated with it." The assent of the

grand council and of the British parliament was to be "requisite to the validity of all . . . general acts or statutes," except that "in time of War, all bills for granting aid to the crown, prepared by the grand council and approved by the president-general, shall be valid and passed into a law, without the assent of the British parliament." The individual colonies, however, were to retain control over their strictly internal affairs. The measure was debated at length, was advocated by such influential members as John Jay and James Duane of New York and Edward Rutledge of South Carolina, and was eventually defeated only by the vote of six colonies to five. Galloway declined a second election to Congress in 1775, joined the British army at New Brunswick, New Jersey (December 1776), advised the British to attack Philadelphia by the Delaware, and during the British occupation of Philadelphia (1777-1778) was superintendent of the port, of prohibited articles, and of police of the city. In October 1778 he went to England, where he remained until his death at Watford, Hertfordshire, on the 29th of August 1803. After he left America his life was attained, and his property, valued at £40,000, was confiscated by the Pennsylvania Assembly, a loss for which he received a partial recompense in the form of a small parliamentary pension. He was one of the clearest thinkers and ablest political writers among the American Loyalists, and, according to Prof. Tyler, "shared with Thomas Hutchinson the supreme place among American statesmen opposed to the Revolution."

Among his pamphlets are *A Candid Examination of the Mutual Claims of Great Britain and the Colonies* (1775); *Historical and Political Reflections on the Rise and Progress of the American Rebellion* (1780); *Cool Thoughts on the Consequences to Great Britain of American Independence* (1780); and *The Claim of the American Loyalists Reviewed and Maintained upon Incontrovertible Principles of Law and Justice* (1788).

See Thomas Balch (Ed.), *The Examination of Joseph Galloway by a Committee of the House of Commons* (Philadelphia, 1855); Ernest H. Baldwin, *Joseph Galloway, the Loyalist Politician* (New Haven, 1903); and M. C. Tyler, *Literary History of the American Revolution* (2 vols., New York, 1897).

GALLOWAY, THOMAS (1706-1851), Scottish mathematician, was born at Symington, Lanarkshire, on the 26th of February 1706. In 1812 he entered the university of Edinburgh, where he distinguished himself specially in mathematics. In 1823 he was appointed one of the teachers of mathematics at the military college of Sandhurst, and in 1833 he was appointed actuary to the Amicable Life Assurance Office, the oldest institution of that kind in London; in which situation he remained till his death on the 1st of November 1851. Galloway was a voluminous, though, for the most part, an anonymous writer. His most interesting paper is "On the Proper Motion of the Solar System," and was published in the *Phil. Trans.*, 1847. He contributed largely to the seventh edition of the *Encyclopaedia Britannica*, and also wrote several scientific papers for the *Edinburgh Review* and various scientific journals. His *Encyclopaedia* article, "Probability," was published separately.

See *Transactions of the Royal Astronomical Society* (1852).

GALLOWAY, a district in the south-west of Scotland, comprising the counties of Kirkcudbright and Wigtown. It was the *Novantia* of the Romans, and till the end of the 12th century included Carrick, now the southern division of Ayrshire. Though the designation has not been adopted civilly, its use historically and locally has been long established. Thus the Bruces were lords of Galloway, and the title of earl of Galloway (created 1623) is now held by a branch of the Stewarts. Galloway also gives its name to a famous indigenous breed of black hornless cattle. See **KIRKCUDBRIGHTSHIRE AND WIGTOWNSHIRE**.

GALLOWS (a common Teutonic word—cf. Goth. *galga*, O. H. Ger. *galgo*, Mod. Ger. *Galgern*, A. S. *galcan*, &c.—of uncertain

¹ The word "gallows" is the plural of a word (*galwe*, *galowe*, *gallow*) which, according to the *New English Dictionary*, was occasionally used as late as the 17th century, though from the 13th century onwards the plural form was more usual. Caxton speaks both of "a gallows" and, in the older form, of "a pair of gallows," this referring probably to the two upright posts. From the 16th century onwards "gallows" has been consistently treated as a singular form, a new plural, "gallowesses," having come into use. "The latter, though

origin), the apparatus for executing the sentence of death by hanging. It usually consists of two upright posts and a cross-beam, but sometimes of a single upright with a beam projecting from the top. The Roman gallows was the cross, and in the older translations of the Bible "gallows" was used for the cross on which Christ suffered (so *galgo* in Ulfilas's Gothic Testament).² Another form of gallows in the middle ages was that of which the famous example at Montfaucon near Paris was the type. This was a square structure formed of columns of masonry connected in each tier with cross-pieces of wood, and with pits beneath, into which the bodies fell after disarticulation by exposure to the weather.

According to actual usage the condemned man stands on a platform or drop (introduced in England in 1760), the rope hangs from the cross-beam, and the noose at its end is placed round his neck. He is hanged by the falling of the drop, the knot in the noose being so adjusted that the spinal cord is broken by the fall and death instantaneous. In old times the process was far less merciful; sometimes the condemned man stood in a cart, which was drawn away from under him; sometimes he had to mount a ladder, from which he was thrust by the hangman. Until 1832 malefactors in England were sometimes hanged by being drawn up from the platform by a heavy weight at the other end of the rope. Death in these cases was by strangulation. At the present time executions in the United Kingdom are private, the gallows being erected in a chamber or enclosed space set apart for the purpose inside the gaol.

The word "gibbet," the Fr. *gibet*, gallows, which appears in the first instance to have meant a crooked stick,³ was originally used in English synonymously with gallows, as it sometimes still is. Its later and more special application, however, was to the upright posts with a projecting arm on which the bodies of criminals were suspended after their execution. These gibbets were erected in conspicuous spots, on the tops of hills (Gallows Hill is still a common name) or near frequented roads. The bodies, smeared with pitch to prevent too rapid decomposition, hung in chains as a warning to evildoers. From the gruesome custom comes the common use of the word "to gibbet" for any holding up to public infamy or contempt.

GALLS. In animals galls occur mostly on or under the skin of living mammals and birds, and are produced by Acaridea, and by dipterous insects of the genus *Oestrus*. Signor Moriggia⁴ has described and figured a horny excrescence, nearly 8 in. in length, from the back of the human hand, which was caused by *Acarus domesticus*. What are commonly known as galls are vegetable excrescences, and, according to the definition of Lacaze-Duthiers, comprise "all abnormal vegetable productions developed on plants by the action of animals, more particularly by insects, whatever may be their form, bulk or situation." For the larvae of their makers the galls provide shelter and sustenance. The exciting cause of the hypertrophy, in the case of the typical galls, appears to be a minute quantity of some irritating fluid, or virus, secreted by the female insect, and deposited with her egg in the puncture made by her ovipositor in the cortical or foliaceous parts of plants. This virus causes the rapid enlargement and subdivision of the cells affected by it, so as to form the tissues of the gall. Oval or larval irritation also, without doubt, plays an important part in the formation of many galls. Though, as Lacaze-Duthiers remarks, a certain relation is necessary between the "stimulus" and the "supporter of the stimulus," as evidenced by the limitation in the majority of cases of each species of gall-insect to some one vegetable structure, still it must be the quality of the irritant not strictly obsolete, is now seldom used: the formation is felt to be somewhat uncouth, so that the use of the word in the plural is commonly evaded" (*New Eng. Dict.* s.v. "Gallows").

² In Med. Lat. "gallows" was translated by *juria* and *patibulum*, both words applied in classical Latin to a fork-shaped instrument of punishment fastened on the neck of slaves and criminals.

³ *Juria*, in feudal law, was the right granted to tenants having major jurisdiction to erect a gallows within the limits of their fief.

⁴ Cf. Wace, *Roman de Rou*, iii. 8349:

"Et il a le gibet saisi

Qui a son destre braz pendu."

⁴ Quoted in *Zoological Record*, iv. (1867), p. 192.

of the tissues, rather than the specific peculiarities or the part of the plant affected, that principally determines the nature of the gall. Thus the characteristics of the currant-gall of *Spathegaster baccharum*, L., which occurs alike on the leaves and on the flower-stalks of the oak, are obviously due to the act of oviposition, and not to the functions of the parts producing it; the bright red galls of the saw-fly *Nematus gallicola* are found on four different species of willow, *Salix fragilis*, *S. alba*, *S. caprea* and *S. cinerea*;¹ and the galls of a Cynipid, *Biorhiza aptera*, usually developed on the rootlets of the oak, have been procured also from the deodar.² Often the gall bears no visible resemblance to the structures out of which it is developed; commonly, however, outside the larval chamber, or gall proper, and giving to the gall its distinctive form, are to be detected certain more or less modified special organs of the plant. The gall of *Cecidomyia strobilina*, formed from willow-buds, is mainly a rosette of leaves the stalks of which have had their growth arrested. The small, smooth, seed-shaped gall of the American *Cynips seminator*, Harris, according to W. F. Bassett,³ is the petiole, and its terminal tuft of woolly hairs the enormously developed pubescence of the young oak-leaf. The moss-like covering of the "bedeguars" of the wild rose, the galls of a Cynipid, *Rhodites rosae*, represents leaves which have been developed with scarcely any parenchyma between their fibro-vascular bundles; and the "artichoke-galls" or "oak-strobile," produced by *Aphilothrix gemmae*, L., which insect arrests the development of the acorn, consists of a cupule to which more or less modified leaf-scales are attached, with a peduncular, oviform, inner gall.⁴ E. Newman held the view that many oak-galls are pseudobalani or false acorns: "to produce an acorn has been the intention of the oak, but the gall-fly has frustrated the attempt." Their formation from buds which normally would have yielded leaves and shoots is explained by Parfitt as the outcome of an effort at fructification induced by oviposition, such as has been found to result in several plants from injury by insect-agency or otherwise.⁵ Galls vary remarkably in size and shape according to the species of their makers. The polythalamous gall of *Aphilothrix radiceis*, found on the roots of old oak-trees, may attain the size of a man's fist; the galls of another Cynipid, *Andricus occultus*, Tschek,⁶ which occurs on the male flowers of *Quercus sessiliflora*, is 2 millimetres, or barely a line, in length. Many galls are brightly coloured, as, for instance, the oak-leaf hairy galls of *Spathegaster tricolor*, which are of a crimson hue, more or less diffused according to exposure to light. The variety of forms of galls is very great. Some are like urns or cups, others lenticular. The "knoppers" galls of *Cynips polycera*, Gir., are cones having the broad, slightly convex upper surface surrounded with a toothed ridge. Of the Ceylonese galls, "some are as symmetrical as a composite flower when in bud, others smooth and spherical like a berry; some protected by long spines, others clothed with yellow wool formed of long cellular hairs, others with regularly tufted hairs."⁷ The characters of galls are constant, and as a rule exceedingly diagnostic, even when, as in the case of ten different gall-gnats of an American willow, *Salix humilis*, it is difficult or impossible to tell the full-grown insects that produce them from one another. In degree of complexity of internal structure galls differ considerably. Some are monothalamous, and contain but one larva of the gall-maker, whilst others are many-celled and numerous inhabited. The largest class are the unilocular, or simple, external galls, divided by Lacaze-Duthiers into those with and those without a superficial protective layer or rind, and composed of hard, or spongy, or cellular tissue. In a common gall-nut that authority distinguished seven constituent portions: an epidermis; a subdermic cellular tissue; a spongy and a hard layer, composing

the parenchyma proper; vessels which, without forming a complete investment, underlie the parenchyma; a hard protective layer; and lastly, within that, an alimentary central mass inhabited by the growing larva.⁸

Galls are formed by insects of several orders. Among the Hymenoptera are the gall-wasps (*Cynips* and its allies), which infect the various species of oak. They are small insects, having straight antennae, and a compressed, usually very short abdomen with the second or second and third segments greatly developed, and the rest imbricated, and concealing the partially coiled ovipositor. The transformations from the larval state are completed within the gall, out of which the imago, or perfect insect, tunnels its way,—usually in autumn, though sometimes, as has been observed of some individuals of *Cynips Kollarii*, after hibernation.

Among the commoner of the galls of the *Cynipidae* are the "oak-apple" or "oak-sponge" of *Andricus terminalis*, Fab.; the "currant" or "berry galls" of *Spathegaster baccharum*, L., above mentioned; and the "oak-spangles" of *Neurolecerus lenticularis*,⁹ Oliv., generally reputed to be fungoid growths, until the discovery of their true nature by Frederick Smith,¹⁰ and the succulent "cherry-galls" of *Dryophanta scutellaris*, Oliv. The "marble" or "Devonshire woody galls" of oak-buds, which often destroy the leading shoots of young trees, are produced by *Cynips Kollarii*,¹¹ already alluded to. They were first introduced into Devonshire about the year 1847, had become common near Birmingham by 1866, and two or three years later were observed in several parts of Scotland.¹² They contain about 17% of tannin.¹³ On account of their regular form they have been used, threaded on wire, for making ornamental baskets. The large purplish Mecca or Bussorah galls,¹⁴ produced on a species of oak by *Cynips insana*, Westw., have been regarded by many writers as the Dead Sea fruit, mad-apples (*mala insana*), or apples of Sodom (*poma sodomitica*), alluded to by Josephus and others, which, however, are stated by E. Robinson (*Bibl. Researches in Palestine*, vol. i. pp. 522-524, 3rd ed., 1867) to be the singular fruit called by the Arabs 'Osher, produced by the *Asclepias gigantea* or *procera* of botanists. What in California are known as "flea seeds" are oak-galls made by a species of *Cynips*; in August they become detached from the leaves that bear them, and are caused to jump by the spasmodic movements of the grub within the thin-walled gall-cavity.¹⁵

Common gall-nuts, nut-galls, or oak-galls, the Aleppo, Turkey, or Levant galls of commerce (Ger. *Galläpfel*, *levantische Gallen*; Fr. *noix de Galle*), are produced on *Quercus infectoria*, a variety of *Q. Lusitanica*, Webb, by *Cynips (Diplolepis, Latr.) tinctoria*, L., or *C. gallae tinctoriae* Oliv. Aleppo galls (*gallae halepenses*) are brittle, hard, spherical bodies, $\frac{1}{2}$ - $\frac{3}{4}$ in. in diameter, ridged and warty on the upper half, and light brown to dark greyish-yellow within. What are termed "blue," "black," or "green" galls contain the insect; the inferior "white" galls, which are lighter coloured, and not so compact, heavy or astringent, are gathered after its escape (see fig. 1.). Less valued are the galls of Tripoli (Tarapulus or Tarabulus, whence the name "Tarabulous galls"). The most esteemed Syrian galls, according to Pereira, are those of Mosul on the Tigris. Other varieties of nut-galls, besides the above-mentioned, are employed in Europe for various purposes. Commercial gall-nuts have yielded on analysis from 26 (H. Davy) to 77 (Buchner) % of tannin (see

¹ "Recherches pour servir à l'histoire des galls," *Ann. des sci. nat.* xix. pp. 293 sqq.

² According to Dr Adler, alternation of generations takes place between *N. lenticularis* and *Spathegaster baccharum* (see E. A. Ormerod, *Entomologist*, xi. p. 34).

³ See Westwood, *Introd. to the Mod. Classif. of Insects*, ii. (1840) p. 130.

⁴ For figures and descriptions of insect and gall, see *Entomologist*, iv. p. 17, vii. p. 241, ix. p. 53, xi. p. 131.

⁵ *Scottish Naturalist*, i. (1871) p. 116, &c.

⁶ Vinen, *Journ. de pharm. et de chim.* xxx. (1856) p. 290;

⁷ English Ink-Galls," *Pharm. Journ.* 2nd ser. iv. p. 520.

⁸ See Pereira, *Materia Medica*, vol. ii. pt. i. p. 347; *Pharm. Journ.*

1st ser. vol. viii. pp. 422-424.

⁹ See R. H. Stretch and C. D. Gibbs, *Proc. California Acad. of Sciences*, iv. pp. 265 and 266.

¹ P. Cameron, *Scottish Naturalist*, ii. pp. 11-15.

² *Entomologist*, vii. p. 47.

³ See in *Proc. Entom. Soc. of London for the Year 1873*, p. xvi.

⁴ See A. Müller, *Gardener's Chronicle* (1871), pp. 1162 and 1518;

and E. A. Fitch, *Entomologist*, xi. p. 129.

⁵ *Entomologist*, vi. pp. 275-278, 339-340.

⁶ *Verhandl. d. zool.-bot. Ges. in Wien*, xxi. p. 799.

⁷ Darwin, *Variations of Animals and Plants under Domestication*, ii. p. 282.

Vinen, *loc. cit.*), with gallic and ellagic acids, ligneous fibre, water, and minute quantities of proteids, chlorophyll, resin, free sugar and, in the cells around the inner shelly chamber, calcium oxalate. Oak-galls are mentioned by Theophrastus, Dioscorides (i. 146), and other ancient writers, including Pliny (*Nat. Hist.* xvi. 9, 10, xxiv. 5), according to whom they may be produced "in a single night." Their insect origin appears to have been entirely unsuspected until within comparatively recent times, though Pliny, indeed, makes the observation that a kind of gnat is

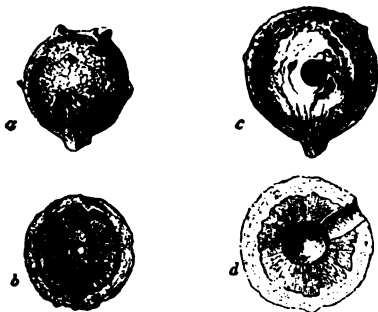

FIG. 1.—a, Aleppo "blue" gall; b, ditto in section, showing central cavity for grub; c, Aleppo "white" gall, perforated by insect; d, the same in section (natural size).

produced in certain excrescences on oak leaves. Bacon describes oak-apples as "an exudation of plants joined with putrefaction." Pomet¹ thought that gall-nuts were the fruit of the oak, and a similar opinion obtains among the modern Chinese, who apply to them the term *Mu-shih-tsze*, or "fruits for the foodless."² Hippocrates administered gall-nuts for their astringent properties, and Pliny (*Nat. Hist.* xxiv. 5) recommends them as a remedy in affections of the gums and uvula, ulcerations of the mouth and some dozen more complaints. In British pharmacy gall-nuts are used in the preparation of the two astringent ointments *unguentum gallae* and *unguentum gallae cum opio*, and of the *tinctoria gallae*, and also as a source of tannin and of gallic acid (*q.v.*). They have from very early times been resorted to as a means of staining the hair of a dark colour, and they are the base of the tattooing dye of the Somali women.³

The gall-making Hymenoptera include, besides the *Cynipidae* proper, certain species of the genus *Eurytoma* (*Isosoma*, Walsh) and family *Chalcididae*, e.g. *E. hordei*, the "joint-worm" of the United States, which produces galls on the stalks of wheat;⁴ also various members of the family *Tenthredinidae*, or saw-flies. The larvae of the latter usually vacate their galls, to spin their cocoons in the earth, or, as in the case of *Athalia abdominalis*, Klg., of the clematis, may emerge from their shelter to feed for some days on the leaves of the gall-bearing plant.

The dipterous gall-formers include the gall-midges, or gall-gnats (*Cecidomyiidae*), minute slender-bodied insects, with bodies usually covered with long hairs, and the wings folded over the back. Some of them build cocoons within their galls, others descend to the ground or become pupae. The true willow-galls are the work either of these or of saw-flies. Their galls are to be met with on a great variety of plants of widely distinct genera, e.g. the ash, maple, horn-beam, oak,⁵ grape-vine,⁶ alder, goose-berry, blackberry, pine, juniper, thistle, fennel, meadowsweet,⁷

¹ A Complete History of Drugs (translation), p. 169 (London, 1748).

² R. F. Porter Smith, *Contrib. towards the Mat. Medica . . . of China*, p. 100 (1871).

³ R. F. Burton, *First Footsteps in E. Africa*, p. 178 (1856).

⁴ A. S. Packard, jun., *Guide to the Study of Insects*, p. 205 (Salem, 1870).

⁵ On the *Cecidomyids of Quercus Cerris*, see Fitch, *Entomologist*, xi. p. 14.

⁶ See, on *Cecidomyia oenophila*, Von Haimhoffen, *Verhandl. d. zoolog.-bot. Ges. in Wien*, xxv. pp. 801-810.

⁷ See *Entomologist's Month. Mag.* iv. (1868) p. 233; and for figure and description, *Entomologist*, xi. p. 13.

common cabbage and cereals. In the northern United States, in May, "legions of these delicate minute flies fill the air at twilight, hovering over wheat-fields and shrubbery. A strong north-west wind, at such times, is of incalculable value to the farmer."⁸ Other gall-making dipterous flies are members of the family *Trypetidae*, which disfigure the seed-heads of plants, and of the family *Mycetophilidae*, such as the species *Sciara tilicola*,⁹ Lw., the cause of the oblong or rounded green and red galls of the young shoots and leaves of the lime.

Galls are formed also by hemipterous and homopterous insects of the families *Tingidae*, *Psyllidae*, *Coccidae* and *Aphidae*. *Coccus pinicorticis* causes the growth of patches of white flocculent and downy matter on the smooth bark of young trees of the white pine in America.¹⁰ The galls of examples of the last family are common objects on lime-leaves, and on the petioles of the poplar. An American Aphid of the genus *Pemphigus* produces black, ragged, leathery and cut-shaped excrescences on the young branches of the hickory.

The Chinese galls of commerce (*Woo-pei-tsze*) are stated to be produced by *Aphis Chinensis*, Bell, on *Rhus semialata*, Murr. (*R. Bucki-amela*, Roxb.), an Anacardiaceae tree indigenous to N. India, China and Japan. They are hollow, brittle, irregularly pyriform, tuberculated or branched vesicles, with thin walls, covered externally with a grey down, and internally with a white chalk-like matter, and insect-remains (see fig. 2). The escape of the insect takes place on the spontaneous bursting of the walls of the vesicle, probably when, after viviparous (thelytokous) reproduction for several generations, male winged insects are developed. The galls are gathered before the frosts set in, and are exposed to steam to kill the insects.¹¹

Chinese galls examined by Viéd¹² yielded 72% of tannin, and less mucilage than Aleppo galls. Several other varieties of galls are produced by Aphides on species of *Pistacia*.

M. J. Lichtenstein has established the fact that from the egg of the Aphis of Pistachio galls, *Anopleura lentisci*, is hatched an apterous insect (the gall-founder), which gives birth to young Aphides (emigrants), and that these, having acquired wings, fly to the roots of certain grasses (*Bromus sterilis* and *Hordeum vulgare*), and by budding underground give rise to several generations of apterous insects, whence finally come a winged brood (the pupifera). These last issuing from the ground fly to the Pistachio, and on it deposit their pupae. From the pupae, again, are developed sexual individuals, the females of which lay fecundated eggs productive of gall-founders, thus recommencing the biological cycle (see *Compt. rend.*, Nov. 18, 1878, p. 782, quoted in *Ann. and Mag. Nat. Hist.*, 1879, p. 174).

Of other insects which have been recognized as gall-makers

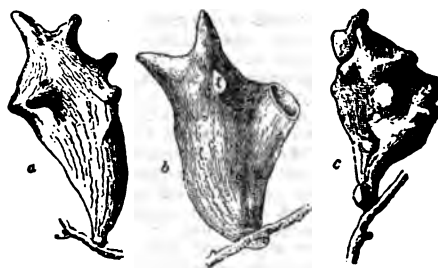

FIG. 2.—a, Chinese gall (about $\frac{1}{2}$ nat. size); b, ditto broken, showing thin-walled cavity; c, Japanese gall (natural size).

there are, among the Coleoptera, certain Curculionids (gall-weevils), and species of the exotic *Sagridae* and *Lamiadae* and an

⁸ A. S. Packard, jun., *Our Common Insects*, p. 203 (Salem, U.S. 1873). On the Hessian fly, *Cecidomyia destructor*, Say, the May brood of which produces swellings immediately above the joints of barley attacked by it, see Asa Fitch, *The Hessian Fly* (Albany, 1847), reprinted from *Trans. New York State Agric. Soc.* vol. vi.

⁹ J. Winnertz, *Beitrag zu einer Monographie der Sciariinen*, p. 164 (Vienna, 1867).

¹⁰ Asa Fitch, *First and Second Rep. on the Noxious . . . Insects of the State of New York*, p. 167 (Albany, 1856).

¹¹ See E. Doubleday, *Pharm. Journ.* 1st ser. vol. vii. p. 310; and Pereira, *ib.* vol. iii. p. 377.

¹² *Dingler's Polyt. Journ.* ccxvi. p. 453.

American beetle, *Saperda inornata* (Cerambycidae), which forms the pseudo-galls of *Salix longifolia* and *Populus angulata*, or cottonwood. Among the Lepidoptera are gall-forming species belonging to the *Tineidae*, *Aegeriidae*, *Tortricidae* and *Pterophoridae*. The larva of a New Zealand moth, *Morova subfasciata*, Walk. (*Cacoecia gallicolens*), of the family *Drepanulidae*, causes the stem of a creeping plant, on the pith of which it apparently subsists, to swell up into a fusiform gall.¹

Mite-galls, or *acarococcidia*, are abnormal growths of the leaves of plants, produced by microscopic Acarinae of the genus *Phytoptus* (gall-mites), and consist of little tufts of hairs, or of thickened portions of the leaves, usually most hypertrophied on the upper surface, so that the lower is drawn up into the interior, producing a bursiform cavity. Mite-galls occur on the sycamore, pear, plum, ash, alder, vine, mulberry and many other plants; and formerly, e.g. the gall known as *Erineum quercinum*, on the leaves of *Quercus Cerris*, were taken for cryptogamic structures. The lime-leaf "nail-galls" of *Phytoptus tiliae* closely resemble the "trumpet-galls" formed on American vines by a species of *Cecidomyia*.² Certain minute Nematoid worms, as *Anguillula scandens*, which infests the ears of wheat, also give rise to galls.

Besides the larva of the gall-maker, or the householder, galls usually contain inquilines or lodgers, the larvae of what are termed gnest-flies or cuckoo-flies. Thus the galls of *Cynips* and its allies are inhabited by members of other cynipideous genera, as *Synergus*, *Amblynotus* and *Synophrus*; and the pine-cone-like gall of *Salix strobiloides*, as Walsh has shown,³ is made by a large species of *Cecidomyia*, which inhabits the heart of the mass, the numerous smaller cecidomyioid larvae in its outer part being mere inquilines. In many instances the lodgers are not of the same order of insects as the gall-makers. Some saw-flies, for example, are inquilinous in the galls of gall-gnats and some gall-gnats in the galls of saw-flies. Again, galls may afford harbour to insects which are not essentially gall-feeders, as in the case of the Curculio beetle *Conotrachelus nenuphar*, Hbst., of which one brood eats the fleshy part of the plum and peach, and another lives in the "black knot" of the plum-tree, regarded by Walsh as probably a true cecidomyioid gall. The same authority (*loc. cit.* p. 550) mentions a willow-gall which provides no less than sixteen insects with food and protection; these are preyed upon by about eight others, so that altogether some twenty-four insects, representing eight orders, are dependent for their existence on what to the common observer appears to be nothing but "an unmeaning mass of leaves." Among the numerous insects parasitic on the inhabitants of galls are hymenopterous flies of the family *Proctotrypidae*, and of the family *Chalcididae*, e.g. *Callimome regius*, the larva of which preys on the larvae of both *Cynips glutinosa* and its lodger *Synergus facialis*. The oak-apple often contains the larvae of *Braconidae* and *Ichneumonidae*, which Von Schlechtendal (*loc. sup. cit.* p. 33) considers to be parasites not on the owner of the gall, *Andricus terminalis*, but on inquilinous *Tortricidae*. Birds are to be included among the enemies of gall-insects. Oak-galls, for example, are broken open by the titmouse in order to obtain the grub within, and the "button-galls" of *Neuroterus numismatis*, Oliv., are eaten by pheasants.

A great variety of deformations and growths produced by insects and mites as well as by fungi have been described. They are in some cases very slight, and in others form remarkably large and definite structures. The whole are now included under the term *Cecidia*; a prefix gives the name of the organism to which the attacks are due, e.g. *Phytoptococcidia* are the galls formed by *Phytoptus* mites. Simple galls are those that arise when only one member of a plant is involved; compound galls

are the result of attacks on buds. Amongst the most remarkable galls recently discovered we may mention those found on Eucalyptus, Casuarina and other trees and plants in Australia. They are remarkable for their variety, and are due to small scale-insects of the peculiar sub-family *Brachyscelinae*. As regards the mode of production of galls, the most important distinction is between galls that result from the introduction of an egg, or other matter, into the interior of the plant, and those that are due to an agent acting externally, the gall in the latter case frequently growing in such a manner as ultimately to enclose its producers. The form and nature of the gall are the result of the powers of growth possessed by the plant. It has long been known, and is now generally recognized, that a gall can only be produced when the tissue of a plant is interfered with during, or prior to, the actual development of the tissue. Little more than this is known. The power that gall-producers possess of influencing by direct interference the growth of the cells of the plant that affords them the means of subsistence is an art that appears to be widely spread among animals, but is at the same time one of which we have little knowledge. The views of Adler as to the alternation of generations of numerous gall-flies have been fully confirmed, it having been ascertained by direct observation that the galls and the insects produced from them in one generation are entirely different from the next generation; and it has also been rendered certain that frequently one of the alternate generations is parthenogenetic, no males being produced. It is supposed that these remarkable phenomena have gradually been evoked by difference in the nutrition of the alternating generations. When two different generations are produced in one year on the same kind of tree it is clear the properties of the sap and tissues of the tree must be diverse so that the two generations are adapted to different conditions. In some cases the alternating generations are produced on different species of trees, and even on different parts of the two species.

On galls and their makers and inhabitants see further—J. T. C. Ratzburg, *Die Forst-Insecten*, Teil iii. pp. 53 seq. (Berlin, 1844); T. W. Harris, *Insects injurious to Vegetation* (Boston, U.S., 2nd ed., 1852); C. L. Koch, *Die Pflanzenläuse Aphiden* (Nuremberg, 1854); T. Hartig, *Die Familien der Blattwespen und Holzwespen* (Berlin, 1860); Walsh, "On the Insects, Coleopterous, Hymenopterous and Dipterous, inhabiting the Galls of certain species of Willow," *Proc. Ent. Soc. Philadelphia*, iii. (1863-1864), pp. 543-644, and vi. (1866-1867), pp. 223-288; T. A. Marshall, "On some British Cynipidae," *Ent. Month. Mag.* iv. pp. 6-8, &c.; H. W. Kidd and Albert Müller, "A List of Gall-bearing British Plants," *ib.* v. pp. 118 and 216; G. L. Mayr, *Die mitteleuropäischen Eichen gallen in Wort und Bild* (Vienna, 1870-1871), and the translation of that work, with notes, in the *Entomologist*, vols. vii. seq.; also, by the same author, "Die Einmischer der mitteleuropäischen Eichen gallen," *Verhandl. d. zool.-bot. Ges. in Wien*, xxii. pp. 669-726; and "Die europäischen Torymiden," *ib.* xxiv. pp. 53-142 (abstracted in *Cistula entomologica* i., London, 1869-1876); F. Löw, "Beiträge zur Kenntnis der Gallmücken," *ib.* pp. 143-162, and 321-328; J. E. von Bergenstamm and P. Löw, "Synopsis Cecidomyidarum," *ib.* xxvi. pp. 1-104; Ferris, *Ann. Soc. Entom. de France*, 4th ser. vol. x. pp. 176-185; R. Osten-Sacken, "On the North American Cecidomyiidae," *Smithsonian Miscellaneous Collections*, vol. vi. (1867), p. 173; E. L. Taschenberg, *Entomologie für Gärtner und Gartenfreunde* (Leipzig, 1871); J. W. H. Traill, "Scottish Galls," *Scottish Naturalist*, i. (1871), pp. 123, &c.; Albert Müller, "British Gall Insects," *The Entomologist's Annual for 1872*, pp. 1-22; B. Altum, *Forstzoologie*, iii. "Insecten," pp. 250 seq. (Berlin, 1874); J. H. Kaltenbach, *Die Pflanzenfeinde aus der Classe der Insecten* (Stuttgart, 1874); A. d'Arbois de Jubainville and J. Vesque, *Les Maladies des plantes cultivées*, pp. 98-105 (Paris, 1878). (F. H. B.)

GALLUPPI, PASQUALE (1770-1846), Italian philosopher, was born on the 2nd of April 1770 at Tropea, in Calabria. He was of good family, and after studying at the university of Naples he entered the public service, and was for many years employed in the office of the administration of finances. At the age of sixty, having become widely known by his writings on philosophy, he was called to the chair of logic and metaphysics in the university of Naples, which he held till his death in November 1846. His most important works are: *Lettere filosofiche* (1827), in which he traces his philosophical development; *Elementi di filosofia* (1832); *Saggio filosofico sulla critica della conoscenza* (1810-1832); *Sull'analisi e sulla sintesi* (1807); *Lezioni di logica e di metafisica* (1832-1836); *Filosofia della volontà* (1832-1842,

¹ For figure and description see *Zoology of the "Erebus" and "Terror"*, ii. pp. 46, 47 (1844-1875).

² On the mite-galls and their makers, see F. Löw, "Beiträge zur Naturgesch. der Gallmilben (*Phytoptus*, Duj.)," *Verhandl. d. zool.-bot. Ges. in Wien*, xxiv. (1874), pp. 2-16, with plate; and "Über Milbengallen (Acarococcidien) der Wiener-Gegend," *ib.* pp. 495-508; Andrew Murray, *Economic Entomology*, A. ptera, pp. 331-374 (1876); and F. A. W. Thomas, *Allere und neue Beobachtungen über Phytoptococcidien* (Halle, 1877).

incomplete); *Storia della filosofia* (i., 1842); *Considerazioni filosofiche sull'idealismo trascendentale* (1841), a memoir on the system of Fichte.

On his philosophical views see L. Ferri, *Essai sur l'histoire de la philosophie en Italie au XIX^e siècle*, i. (1869); V. Botta in Ueberweg's *Hist. of Philosophy*, ii. app. 2; G. Barzellotti, "Philosophy in Italy," in *Mind*, iii. (1878); V. Lastrucci, *Pasquale Galluppi. Studio critico* (Florence, 1890).

GALLUS, CORNELIUS (c. 70–26 B.C.), Roman poet, orator and politician, was born of humble parents at Forum Julii (*Fréjus*) in Gaul. At an early age he removed to Rome, where he was taught by the same master as Virgil and Varius Rufus. Virgil, who dedicated one of his eclogues (x.) to him, was in great measure indebted to the influence of Gallus for the restoration of his estate. In political life Gallus espoused the cause of Octavianus, and as a reward for his services was made praefect of Egypt (Suetonius, *Augustus*, 66). His conduct in this position afterwards brought him into disgrace with the emperor, and having been deprived of his estates and sentenced to banishment, he put an end to his life (Dio Cassius liii. 23). Gallus enjoyed a high reputation among his contemporaries as a man of intellect, and Ovid (*Tristia*, iv. 10) considered him the first of the elegiac poets of Rome. He wrote four books of elegies chiefly on his mistress Lycoris (a poetical name for Cytheris, a notorious actress), in which he took for his model Euphron of Chalcis (q.v.); he also translated some of this author's works into Latin. Nothing by him has survived; the fragments of the four poems attributed to him (first published by Aldus Manutius in 1590 and printed in A. Riese's *Anthologia Latina*, 1869) are generally regarded as a forgery.

See C. Völker, *De C. Galli vita et scriptis* (1840–1844); A. Nicolas, *De la vie et des ouvrages de C. Gallus* (1851), an exhaustive monograph. An inscription found at Philae (published 1896) records the Egyptian exploits; see M. Schanz, *Geschichte der römischen Litteratur*, and Plessis, *Poésie latine* (1909).

GALLUS, GAIUS AELIUS, praefect of Egypt 26–24 B.C. By order of Augustus he undertook an expedition to Arabia Felix, with disastrous results. The troops suffered greatly from disease, heat, want of water and the obstinate resistance of the inhabitants. The treachery of a foreign guide also added to his difficulties. After six months Gallus was obliged to return to Alexandria, having lost the greater part of his force. He was a friend of the geographer Strabo, who gives an account of the expedition (xvi. pp. 780–782; see also Dio Cassius liii. 20; Pliny, *Nat. Hist.* vi. 32; C. Merivale, *Hist. of the Romans under the Empire*, ch. 34; H. Krüger, *Der Feldzug des A. G. nach dem glücklichen Arabien*, 1862). He has been identified with the Aelius Gallus frequently quoted by Galen, whose remedies are stated to have been used with success in an Arabian expedition.

GALLUS, GAIUS CESTIUS, governor of Syria during the reign of Nero. When the Jews in Jerusalem, stirred to revolt by the outrages of the Roman procurators, had seized the fortress of Masada and treacherously murdered the garrison of the palace of Herod, Gallus set out from Antioch to restore order. On the 17th of November A.D. 66 he arrived before Jerusalem. Having gained possession of the northern suburb, he attacked the temple mount; but, after five days' fighting, just when (according to Josephus) success was within his grasp, he unaccountably withdrew his forces. During his retreat he was closely pursued by the Jews and surrounded in a ravine, and only succeeded in making good his escape to Antioch by sacrificing the greater part of his army and a large amount of war material. Soon after his return Gallus died (before the spring of 67), and was succeeded in the governorship by Licinius Mucianus, the prosecution of the war being entrusted to Vespasian.

See Tacitus, *Hist.* v. 10, 13; Suetonius, *Vespasian*, 4; Josephus, *Bell. Jud.* ii. 14–20; E. Schürer, *Hist. of the Jewish People*, div. i. vol. ii. p. 212 (Eng. tr., 1890).

GALLUS, GAIUS SULPICIUS, Roman general, statesman and orator. Under Lucius Aemilius Paulus, his intimate friend, he commanded the 2nd legion in the campaign against Perseus, king of Macedonia, and gained great reputation for having predicted an eclipse of the moon on the night before the battle of Pydna (168 B.C.). On his return from Macedonia he was elected

consul (166), and in the same year reduced the Ligurians to submission. In 164 he was sent as ambassador to Greece and Asia, where he held a meeting at Sardis to investigate the charges brought against Eumenes of Pergamum by the representatives of various cities of Asia Minor. Gallus was a man of great learning, an excellent Greek scholar, and in his later years devoted himself to the study of astronomy, on which subject he is quoted as an authority by Pliny.

See Livy xlv. 37, *Epit.* 46; Polybius xxxi. 9, 10; Cicero, *Brutus*, 20, *De officiis*, i. 6, *De senectute*, 14; Pliny, *Nat. Hist.* ii. 9.

GALOIS, EVARISTE (1811–1832), French mathematician, was born on the 25th of October 1811, and killed in a duel on the 31st of May 1832. An obituary notice by his friend Auguste Chevalier appeared in the *Revue encyclopédique* (1832); and his collected works are published, *Journal de Liouville* (1846), pp. 381–444, about fifty of these pages being occupied by researches on the resolubility of algebraic equations by radicals. This branch of algebra he notably enriched, and to him is also due the notion of a group of substitutions (see EQUATION: *Theory of Equations*; also GROUPS, THEORY OF).

His collected works, with an introduction by C. F. Picard, were published in 1897 at Paris.

GALSTON, a police burgh and manufacturing town of Ayrshire, Scotland. Pop. (1901) 4876. It is situated on the Irvine, 5 m. E. by S. of Kilmarnock, with a station on the Glasgow & South-Western railway. The manufactures include blankets, lace, muslin, hosiery and paper-millboard, and coal is worked in the vicinity. About 1 m. to the north, amid the "bonnie woods and braes," is Loudoun Castle, a seat of the earl of Loudoun.

GALT, SIR ALEXANDER TILLOCH (1817–1893), Canadian statesman, was the youngest son of John Galt the author. Born in London on the 6th of September 1817, he emigrated to Canada in 1835, and settled in Sherbrooke, in the province of Quebec, where he entered the service of the British American Land Company, of which he rose to be chief commissioner. Later he was one of the contractors for extending the Grand Trunk railway westward from Toronto. He entered public life in 1849 as Liberal member for the county of Sherbrooke, but opposed the chief measure of his party, the Rebellion Losses Bill, and in the same year signed a manifesto in favour of union with the United States, believing that in no other way could Protestant and Anglo-Saxon ascendancy over the Roman Catholic French majority in his native province be maintained. In the same year he retired from parliament but re-entered it in 1853, and was till 1872 the chief representative of the English-speaking Protestants of Quebec province. On the fall of the Brown-Dorion administration in 1858 he was called on to form a ministry, but declined the task, and became finance minister under Sir John Macdonald and Sir George Cartier on condition that the federation of the British North American provinces should become a part of their programme. From 1858 to 1862 and 1864 to 1867 he was finance minister, and did much to reduce the somewhat chaotic finances of Canada into order. To him are due the introduction of the decimal system of currency and the adoption of a system of protection to Canadian manufactures. To his diplomacy was due the coalition in 1864 between Macdonald, Brown and Cartier, which carried the federation of the British North American provinces, and throughout the three years of negotiation which followed his was one of the chief influences. He became finance minister in the first Dominion ministry, but suddenly and mysteriously resigned on the 4th of November 1867. After his retirement he gave to the administration of Sir John Macdonald a support which grew more and more fitful, and advocated independence as the final destiny of Canada. In 1871 he was again offered the ministry of finance on condition of abandoning these views, but declined. In 1877 he was the Canadian nominee on the Anglo-American fisheries commission at Halifax, and rendered brilliant service. In 1880 he was appointed Canadian high commissioner to Great Britain, but retired in 1883 in favour of Sir Charles Tupper. During this period he advocated imperial federation. He was Canadian delegate at the Paris Monetary Conference of 1881, and to the International Exhibition of Fisheries in 1883. From this date till his death on the 19th of

September 1803 he lived in retirement. No Canadian statesman has had sounder or more abundant ideas, but a certain intellectual fickleness made him always a somewhat untrustworthy colleague in political life. (W. L. G.)

GALT, JOHN (1770-1830). Scottish novelist, was born at Irvine, Ayrshire, on the 2nd of May 1770. He received his early education at Irvine and Greenock, and read largely from one of the public libraries while serving as a clerk in a mercantile office. In 1804 he went to settle in London, where he published anonymously a poem on the *Battle of Largs*. After unsuccessful attempts to succeed in business Galt entered at Lincoln's Inn, but was never called to the bar. He obtained a commission from a British firm to go abroad to find out whether the Berlin and Milan decrees could be evaded. He met Byron and Sir John Hobbhouse at Gibraltar, travelled with Byron to Malta, and met him again at Athens. He was afterwards employed by the Glasgow merchant Kirkman Finlay on similar business at Gibraltar, and in 1814 visited France and Holland. His early works are the *Life and Administration of Wolsey*, *Voyages and Travels*, *Letters from the Levant*, the *Life of Benjamin West*, *Historical Pictures* and *The Wandering Jew*; and he induced Colburn to publish a periodical containing dramatic pieces rejected by London managers. These were afterwards edited by Galt as the *New British Theatre*, which included some plays of his own. He first showed his real power as a writer of fiction in *The Ayrshire Legatees*, which appeared in *Blackwood's Magazine* in 1820. This was followed in 1821 by his masterpiece—*The Annals of the Parish*; and, at short intervals, *Sir Andrew Wylie*, *The Entail*, *The Steam-Boat* and *The Provost* were published. These humorous studies of Scottish character are all in his happiest manner. His next works were *Ringan Gilhaize* (1823), a story of the Covenanters; *The Sparewife* (1823), which relates to the times of James I. of Scotland; *Rothelan* (1824), a novel founded on the reign of Edward III.; *The Omen* (1825), which was favourably criticized by Sir Walter Scott; and *The Last of the Lords*, another picture of Scottish life.

In 1826 he went to America as secretary to the Canada Land Company. He carried out extensive schemes of colonization, and opened up a road through what was then forest country between Lakes Huron and Erie. In 1827 he founded Guelph in upper Canada, passing on his way the township of Galt on the Grand river, named after him by the Hon. William Dixon. But all this work proved financially unprofitable to Galt. In 1829 he returned to England commercially a ruined man, and devoted himself with great ardour to literary pursuits, of which the first fruit was *Laurie Todd*—one of his best novels. Then came *Southkennan*, a tale of Scottish life in the times of Queen Mary. In 1830 he was appointed editor of the *Courier* newspaper—a post he soon relinquished. His untiring industry was seen in the publication, in rapid succession, of a *Life of Byron*, *Lives of the Players*, *Bogle Corbet*, *Stanley Buxton*, *The Member*, *The Radical*, *Eben Erskine*, *The Stolen Child*, his *Autobiography*, and a collection of tales entitled *Stories of the Study*. In 1834 appeared his *Literary Life and Miscellanies*, dedicated by permission to William IV., who sent the author a present of £200. As soon as this work was published Galt retired to Greenock, where he continued his literary labours till his death on the 11th of April 1839.

Galt, like almost all voluminous writers, was exceedingly unequal. His masterpieces are *The Ayrshire Legatees*, *The Annals of the Parish*, *Sir Andrew Wylie*, *The Entail*, *The Provost* and *Laurie Todd*. *The Ayrshire Legatees* gives, in the form of a number of exceedingly diverting letters, the adventures of the Rev. Dr Pringle and his family in London. The letters are made the excuse for endless tea-parties and meetings of kirk-session in the rural parish of Garnock. *The Annals of the Parish* are told by the Rev. Micah Balwhidder, Galt's finest character. This work (which, be it remembered, existed in MS. before *Waverley* was published) is a splendid picture of the old-fashioned Scottish pastor and the life of a country parish; and, in rich humour, genuine pathos and truth to nature it is unsurpassed even by Scott. It is a fine specimen of the homely graces of the Scottish

dialect, and preserves much vigorous Doric phraseology fast passing out of use even in country districts. In this novel Mr Galt used, for the first time, the term "Utilitarian," which afterwards became so intimately associated with the doctrines of John Stuart Mill and Bentham (see *Annals of the Parish*, chap. xxxv., and a note by Mill in *Utilitarianism*, chap. ii.). In *Sir Andrew Wylie* the hero entered London as a poor lad, but achieved remarkable success by his shrewd business qualities. The character is somewhat exaggerated, but excessively amusing. *The Entail* was read thrice by Byron and Scott, and is the best of Galt's longer novels. *Leddy Grippy* is a wonderful creation, and was considered by Byron equal to any female character in literature since Shakespeare's time. *The Provost*, in which Provost Pawkie tells his own story, portrays imitatively the jobbery, bickerings and self-seeking of municipal dignitaries in a quaint Scottish burgh. In *Laurie Todd* Galt, by giving us the Scot in America, accomplished a feat which Sir Walter never attempted. This novel exhibits more variety of style and a greater love of nature than his other books. The life of a settler is depicted with unerring pencil, and with an enthusiasm and imaginative power much more poetical than any of the author's professed poems.

The best of Galt's novels were reprinted in Blackwood's *Standard Novels*, to volume i. of which his friend Dr Moir prefixed a memoir.

GALT, a town in Waterloo county, Ontario, Canada, 23 m. N.N.W. of Hamilton, on the Grand river and on the Grand Trunk and Canadian Pacific railways. Pop. (1881) 5187; (1901) 7866. It is named after John Galt, the author. It has excellent water privileges which furnish power for flour-mills and for manufactures of edge tools, castings, machinery, paper and other industries.

GALTON, SIR FRANCIS (1822—), English anthropologist, son of S. T. Galton, of Duddesdon, Warwickshire, was born on the 16th of February 1822. His grandfather was the poet-naturalist Erasmus Darwin, and Charles Darwin was his cousin. After attending King Edward VI.'s grammar school, Birmingham, he studied at Birmingham hospital, and afterwards at King's College, London, with the intention of making medicine his profession; but after taking his degree at Trinity College, Cambridge, in 1843 he changed his mind. The years 1845-1846 he spent in travelling in the Sudan, and in 1850 he made an exploration, with Dr John Anderson, of Damaraland and the Ovampo country in south-west Africa, starting from Walvisch Bay. These tracts had practically never been traversed before, and on the appearance of the published account of his journey and experiences under the title of *Narrative of an Explorer in Tropical South Africa* (1853) Galton was awarded the gold medal of the Royal Geographical Society. His *Art of Travel; or, Shifts and Contrivances in Wild Countries* was first published in 1855. In 1860 he visited the north of Spain, and published the fruits of his observations of the country and the people in the first of a series of volumes, which he edited, entitled *Vacation Tourists*. He then turned to meteorology, the result of his investigations appearing in *Meteorographica*, published in 1863. This work was the first serious attempt to chart the weather on an extensive scale, and in it also the author first established the existence and theory of anticyclones. Galton was a member of the meteorological committee (1868), and of the Meteorological Council which succeeded it, for over thirty years. But his name is most closely associated with studies in anthropology and especially in heredity. In 1869 appeared his *Hereditary Genius, its Laws and Consequences*, a work which excited much interest in scientific and medical circles. This was followed by *English Men of Science, their Nature and Nurture*, published in 1874; *Inquiries into Human Faculty and its Development*, issued in 1883; *Life-History Album* (1884); *Record of Family Faculties* (1884) (tabular forms and directions for entering data, with a preface); and *Natural Inheritance* (1889). The idea that systematic efforts should be made to improve the breed of mankind by checking the birth-rate of the unfit and furthering the productivity of the fit was first put forward by him in 1865; he mooted it again in 1884, using the term "eugenics" for the first time in *Human Faculty*, and in 1904 he endowed a research fellowship in the university of London for the promotion of

knowledge of that subject, which was defined as "the study of agencies under social control that may improve or impair the racial qualities of future generations, either physically or mentally." Galton was the author of memoirs on various anthropometric subjects; he originated the process of composite portraiture, and paid much attention to finger-prints and their employment for the identification of criminals, his publications on this subject including *Finger Prints* (1892), *Decipherment of Blurred Finger Prints* (1893) and *Finger Print Directories* (1895). From the Royal Society, of which he was elected a fellow in 1860, he received a royal medal in 1886 and the Darwin medal in 1902, and honorary degrees were bestowed on him by Oxford (1894) and Cambridge (1895). In 1908 he published *Memoires of My Life*, and in 1909 he received a knighthood.

GALUPPI, BALDASSARE (1766-1785), Italian musical composer, was born on the 18th of October 1766 on the island of Burano near Venice, from which he was often known by the nickname of Buranello. His father, a barber, and violinist at the local theatre, was his first teacher. His first opera, composed at the age of sixteen, being hissed off the stage, he determined to study seriously, and entered the Conservatorio degli Incurabili at Venice, as a pupil of Antonio Lotti. After successfully producing two operas in collaboration with a fellow-pupil, G. B. Pescetti, in 1728 and 1729, he entered upon a busy career as a composer of operas for Venetian theatres, writing sometimes as many as five in a year. He visited London in 1741, and arranged a *pasticcio*, *Alexander in Persia*, for the Haymarket. Burney considered his influence on English music to have been very powerful. In 1740 he became *vice-maestro di cappella* at St Mark's and *maestro* in 1762. In 1749 he began writing comic operas to libretti by Goldoni, which enjoyed an enormous popularity. He was invited to Russia by Catherine II. in 1766, where his operas made a favourable impression, and his influence was also felt in Russian church music. He returned to Venice in 1768, where he had held the post of director of the Conservatorio degli Incurabili since 1762. He died on the 3rd of January 1785.

Galuppi's best works are his comic operas, of which *Il Filosofo di Campagna* (1754), known in England as *The Guardian Trick'd* (Dublin, 1762) was the most popular. His melody is attractive rather than original, but his workmanship in harmony and orchestration is generally superior to that of his contemporaries. He seems to have been the first to extend the concerted finales of Leo and Logroscino into a chain of several separate movements, working up to a climax, but in this respect he is much inferior to Sarti and Mozart.

Browning's poem, "A Toccata of Galuppi," does not refer to any known composition, but more probably to an imaginary extemporization on the harpsichord, such as was of frequent occurrence in the musical gatherings of Galuppi's day.

See also Alfred Wotquerm, *Baldassare Galuppi, étude bibliographique sur ses œuvres dramatiques* (Brussels, 1902). Many of his autograph scores are in the library of the Brussels conservatoire.

(E. J. D.)

GALVANI, LUIGI (1737-1798), Italian physiologist, after whom galvanism received its name, was born at Bologna on the 9th of September 1737. It was his wish in early life to enter the church, but by his parents he was educated for a medical career. At the university of Bologna, in which city he practised, he was in 1762 appointed public lecturer in anatomy, and soon gained repute as a skilled though not eloquent teacher, and, chiefly from his researches on the organs of hearing and genito-urinary tract of birds, as a comparative anatomist. His celebrated theory of animal electricity he enunciated in a treatise, "De Viribus electricitatis in motu musculari commentarius," published in the 7th volume of the memoirs of the Institute of Sciences at Bologna in 1791, and separately at Modena in the following year, and elsewhere subsequently. The statement has frequently been repeated that, in 1786, Galvani had noticed that the leg of a skinned frog, on being accidentally touched by a scalpel which had lain near an electrical machine, was thrown into violent convulsions; and that it was thus that his attention was first directed to the relations of animal functions to electricity. From

documents in the possession of the Institute of Bologna, however, it appears that twenty years previous to the publication of his *Commentary Galvani* was already engaged in investigations as to the action of electricity upon the muscles of frogs. The observation that the suspension of certain of these animals on an iron railing by copper hooks caused twitching in the muscles of their legs led him to the invention of his metallic arc, the first experiment with which is described in the third part of the *Commentary*, with the date September 20, 1786. The arc he constructed of two different metals, which, placed in contact the one with a frog's nerve and the other with a muscle, caused contraction of the latter. In Galvani's view the motions of the muscle were the result of the union, by means of the metallic arc, of its exterior or negative electrical charge with positive electricity which proceeded along the nerve from its inner substance. Volta, on the other hand, attributed them solely to the effect of electricity having its source in the junction of the two dissimilar metals of the arc, and regarded the nerve and muscle simply as conductors. On Galvani's refusal, from religious scruples, to take the oath of allegiance to the Cisalpine republic in 1797, he was removed from his professorship. Deprived thus of the means of livelihood, he retired to the house of his brother Giacomo, where he soon fell into a feverish decline. The republican government, in consideration of his great scientific fame, eventually, but too late, determined to reinstate him in his chair, and he died at Bologna on the 4th of December 1798.

A quarto edition of his works was published at Bologna in 1841-1842, by the Academy of Sciences of the Institute of that city, under the title *Opere edite ed inedite del professore Luigi Galvani*.

GALVANIZED IRON, sheet iron having its surface covered with a thin coating of zinc. In spite of the name, galvanic action has often no part in the production of galvanized iron, which is prepared by dipping the iron, properly cleaned and pickled in acid, in a bath of molten zinc. The hotter the zinc the thinner the coating, but as a high temperature of the bath is attended with certain objections, it is a common practice to use a moderate temperature and clear off the excess of zinc by passing the plates between rollers. In Norwood and Rogers's process a thin coating of tin is applied to the iron before it is dipped in the zinc, by putting the plates between layers of granulated tin in a wooden tank containing a dilute solution of stannous chloride, when tin is deposited on them by galvanic action. In "cold galvanizing" the zinc is deposited electrolytically from a bath, preferably kept neutral or slightly acid, containing a 10% solution of crystallized zinc sulphate, $ZnSO_4 \cdot 7H_2O$. The resulting surface is usually duller and less lustrous than that obtained by the use of molten zinc. Another method of forming a coating of zinc, known as "sherardizing," was invented by Sherard Cowper-Coles, who found that metals embedded in zinc dust (a product obtained in zinc manufacture and consisting of metallic zinc mixed with a certain amount of zinc oxide) and heated to temperatures well below the melting point of zinc, become coated with a layer of that metal. In carrying out the process the articles are placed in an air-tight vessel with the zinc dust, which must be dry, and subjected to a heat of 250-330°C., the time for which the heating is continued depending on the thickness of the deposit required and varying from one-half to several hours. If an air-tight receptacle is not available, a small percentage of powdered carbon is added to the zinc-dust, to prevent increase in the amount of oxide, which, if present in excess, tends to make the deposit dull.

Galvanized iron by its zinc surface is protected from corrosion by the weather, though the protection is not very efficient in the presence of acid or sulphurous fumes, and accordingly it is extensively employed for roofing, especially in the form of corrugated sheets. The iron wire used for wire-netting, telegraphic purposes, &c., is commonly galvanized, as also are bolts, nuts, chains and other fittings on ships.

GALVANOMETER, an instrument for detecting or measuring electric currents. The term is generally applied to instruments which indicate electric current in scale divisions or arbitrary units, as opposed to instruments called amperemeters (*q.v.*), which show directly on a dial the value of the current in amperes.

eters may be divided into direct current and alternating instruments, according as they are intended to measure her of these two classes of currents (see ELECTRO-

Current Galvanometers.—The principle on which one type current galvanometer, called a movable needle galvanometer, for its action is that a small magnet when suspended from a coil of wire tends to set its magnetic axis in the direction of the magnetic field of the coil at that point due to the current passing through it. In the other type, or movable coil galvanometer, the coil is suspended and the magnet fixed; hence tends to set itself with its axis parallel to the lines of force of the magnet. The movable system must be constrained in some way to retain a definite position when no current is passing, means which are called the "control."

In the simple and original form the movable needle galvanometer consists of a horizontal magnetic needle suspended within a coil of insulated wire by silk fibres or pivoted on a point like a compass needle. The direction of such a needle is controlled by the direction of the terrestrial magnetic force within the coil. If the needle is so placed that its axis is parallel to the plane of the coil, then when an electric current is passed through the coil it is deflected and places itself at an angle to the plane of the coil determined by the strength of the current. In the early forms of movable needle galvanometer the needle was either a comparatively large magnet of considerable length, or else a smaller magnet was employed with a long pointer which moved over a scale of degrees so as to indicate deflection. A method of measuring the deflection by means of a mirror scale and telescope was introduced by K. F. Gauss and W. Weber. The magnet had a mirror attached to it, the scale having cross wires in the focus was used to observe the divisions of a fixed scale seen reflected in the mirror. Lord Kelvin (Professor W. Thomson) made the important improvement of reducing the size of the needle and attaching it to the back of a very small mirror, the two being suspended by a single fibre of cocoon silk. The mirror was of silvered microscopic glass about $\frac{1}{8}$ in diameter. The magnetic needle or needles consisted of short fragments of soft iron cemented to its back. A ray of light being thrown on the mirror, the deflexions of the needle were observed by the movements of a spot of light reflected from it upon a scale. This form of mirror galvanometer was first devised for use with submarine cable signalling, but soon became an important instrument in the physical laboratory.

In the modern form of time both the original form of single needle galvanometer and the mirror galvanometer were improved by introducing the astatic principle and weakening the external controlling magnetic field. If two magnetic needles of equal size and weight are attached rigidly to one stem parallel to each other but with poles placed in opposite directions an astatic system results; that is, if the needles are so suspended as to move in a horizontal plane, and if they are made exactly alike in magnetic strength, the system will have no directive power. If the upper needle is slightly weaker than the other, the suspended system will set itself with some axis parallel to the lines of force of the earth's magnetic field in which it is placed. In a form of astatic needle galvanometer devised by Professor A. Broca of Paris, the pair of magnetized needles are suspended vertically and parallel to each other with opposite directions. The upper poles are included in one coil, the lower poles within another coil, so connected that the current in the right direction in each coil to displace the needles in the same direction. By this mode of arrangement the magnetic moment can be secured, together with more stability and freedom from disturbance by external fields. The external magnetic field can be weakened by means of a controlling magnet arranged to create in the space in the interior of the galvanometer an extremely feeble controlling magnetic field. In order to have a coil for each needle and designed so that the current in both coils passes so as to turn both needles in the same direction the controlling magnet is so adjusted that the normal position of the needles is with the magnetic axis parallel to the plane of the coil.

An astatic magnetic system used in conjunction with a galvanometer gives a highly sensitive form of instrument. It is, however, easily disturbed by stray magnetic fields; neighbouring magnets or currents through conductors, or is not suitable for use in many places. It led to the introduction of the movable coil galvanometer first devised by Lord Kelvin as a telegraphic signalling instrument but subsequently modified by A. d'Arsonval and others into a laboratory galvanometer (fig. 2). In this instrument a permanent magnet, generally of the horse-shoe shape, is employed to create a strong magnetic field, in which a light movable coil is suspended. The suspension consists of two fine wires which are connected to the ends of the coil and serve to lead the current in and out. If such a coil with its plane parallel to the lines of force of the permanent magnet when a current is passing through it it displaces itself

in the field, so as to set with its axis more nearly parallel to the lines of force of the field. The movable coil may carry a pointer or a mirror; in the latter form it is well represented by several of the used laboratory instruments. The movable coil galvanometer has the great advantage that it is not easily disturbed by the magnetic fields caused by neighbouring magnets or electric currents, and thus is especially useful in the electrical workshop and factory.

In the practical construction of the suspended needle fixed coil galvanometer great care must be taken with the insulation of the wire of the coil. This wire is generally silk-covered, and wound on a frame, the whole being thoroughly saturated with paraffin wax. In some cases two wires are wound on in parallel, constituting a "differential galvanometer."

When properly adjusted this instrument can be used for the exact comparison of electric currents by a null method, because if an electric current is passed through one wire and creates certain deflexions of the needle, the current which annuls this deflexion when passed through the other wire must be equal to the first current. In the construction of a movable coil galvanometer, it is usual to intensify the magnetic field by inserting a fixed soft iron core in the interior of the movable coil. If the current to be measured is too large to be passed entirely through the galvanometer, a portion is allowed to flow through a circuit connecting the two terminals of the instrument. This circuit is called a shunt and is generally arranged so as to take 0.9, 0.99, or 0.999 of the total current, leaving 0.1, 0.01 or 0.001 to flow through the galvanometer.

W. E. Ayrton and T. Mather have designed a universal shunt box or resistance which can be applied to any galvanometer and by which a known fraction of any current can be sent through the galvanometer when we know its resistance (see *Jour. Inst. Elec. Eng. Lond.*, 1894, 23, p. 314). A galvanometer can be calibrated, or the meaning of its deflexion determined, by passing through it an electric current of known value and observing the deflexion of the needle or coil. The known current can be provided in the following manner:—a single secondary cell of any kind can have its electromotive force measured by the potentiometer (*q.v.*), and compared with that of a standard voltaic cell. If the secondary cell is connected with the galvanometer through a known high resistance R, and if the galvanometer is shunted, that is, has its terminals connected by another resistance S, then if the resistance of the galvanometer itself is denoted by G,

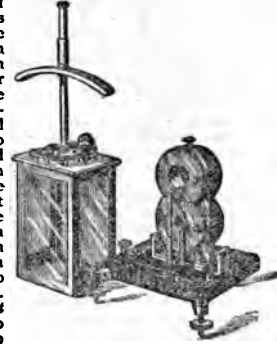

FIG. 1.—Kelvin Astatic Mirror Galvanometer. Elliott square pattern.



FIG. 2.—Movable Coil Galvanometer.

the whole resistance of the shunted galvanometer and high resistance has a value represented by $R + \frac{GS}{G+S}$, and therefore the current through the galvanometer produced by an electromotive force E of the cell is represented by

$$\frac{SE}{R(G+S)+GS}$$

Suppose this current produces a deflexion of the needle or coil or spot of light equal to X scale divisions, we can then alter the value of the resistances R and S, and so determine the relation between the deflexion and the current. By the sensitiveness of the

same name, is more remarkable for scenic beauty than for extent. Besides these perennial lakes, there are several low tracts, called turloughs, which are covered with water during a great part of the year. Loughs Mask and Corrib are connected by a salmon ladder, and contain large trout. Galway, with the Screeb Waters, draining into Camus Bay, a branch of Kilkieran Bay, with Recess and the Ballynahinch waters, are the best fishing centres. On account of its scenic beauty, both coastal and inland, together with its facilities for sport, county Galway is frequented by summer visitors. Though for long the remotest parts were difficult of access, as in the case of Donegal, Mayo, Clare and the western counties generally, the Galway and Clifden railway assisted private enterprise to open up the country. The western mountains, broken by deep landlocked and island-sheltered bays, as well as by the innumerable small loughs of the Connemara districts, afford scenes varying from gentle slopes occasionally well wooded along the water's edge to wild, bare moorlands among the heights, while the summits are usually bold and rocky cones. Several small fishing villages have acquired the dignity of watering-places from the erection of hotels, which have also been planted in previously untenanted situations of high scenic attractions; among these may be mentioned Leenane at the head of Killary harbour, Renvyle House at its entrance, Letterfrack on Ballynakill Bay, Streamstown and Clifden, and Cashel on Bertraghboy Bay. Inland are Recess, near Lough Derryclare, and Ballynahinch, on the lough of that name, both on the railway, at the foot of the Twelve Pins.

Geology.—The east of this county lies in the Carboniferous Limestone plain, with domes of Old Red Sandstone rising near Dunmore and Mount Bellew. As Galway town is neared, the grey rock appears freely on the surface, and Lough Corrib spreads itself over almost level land. Its west branches, however, run up into "Dalradian" hills, which rise abruptly on the threshold of Connemara. A broad mass of ice-worn gneiss and granite lies between Lough Corrib and Galway Bay, cut off so sharply at the sea as to suggest the presence of an east-and-west line of fracture. The Twelve Bens owe their supremacy to the quartzites, which are here well bedded and associated with limestone and mica-schist. Silurian conglomerates and sandstones, with andesitic lavas, overlie the Dalradians, with marked unconformity, south of Leenane and round Lough Nafooye. The surfaces of the hard rocks admirably record the action of ice throughout the country. There is black Carboniferous marble at Menlough near Galway; and the well-known "Connemara Marble" is a banded serpentinous crystalline limestone in the Dalradians at Recess, Ballynahinch and Streamstown. Compact red granite is worked at Shantallow, and the region west of Galway contains many handsome porphyritic red varieties.

Climate and Industries.—The climate is mild and healthy but variable, and violent winds from the west are not uncommon. Frost or snow seldom remains long on the western coast, and cattle of every description continue unbothered during the winter. The eastern part of the county produces the best wheat. Oats are frequently sown after potatoes in moorish soils less adapted for wheat. The flat shores of the bays afford large supplies of seaweed for manure. Limestone, gravel and marl are to be had in most other parts. When a sufficient quantity of manure for potatoes cannot be had, the usual practice is to pare and burn the surface. In many places on the seashore fine early potatoes are raised in deep sea-sand manured with seaweed, and the crop is succeeded by barley. Those parts of the eastern district less fitted for grain are employed in pasturage. Heathy sheep-walks occupy a very large tract between Monivea and Galway. An extensive range from Athenry, stretching to Galway Bay at Kinvarra, is also chiefly occupied by sheep. Over half the total acreage of the county is pasture-land, and cattle, sheep, pigs and poultry are extensively reared. The proportion of tillage to pasturage is roughly as one to four; and owing to the nature of the country fully one-third of the total area is quite barren.

Manufactures are not carried on beyond the demand caused by the domestic consumption of the people. Coarse friezes, flannels and blankets are made in all parts and sold largely in Galway and Loughrea. Connemara has been long celebrated for its hand-knit woollen stockings. Coarse linen, of a narrow breadth, called bundle linen, is also made for home consumption. There is a linen-weaving factory at Oughterard. The manufacture of kelp, formerly a great source of profit on the western shores, is still carried on to some extent. Feathers and sea-fowls' eggs are brought in great quantities from the islands of Aran, the produce of the puffins and other sea-fowl that frequent the cliffs. Fishing affords occupation to many of the inhabitants, the industry having as its centres the ports of Galway and Clifden.

The Midland Great Western main line enters the county at Ballinasloe, and runs by Athenry to Galway, with an extension to Oughterard (Lough Corrib) and Clifden. The Great Southern &

Western line from Sligo to Limerick traverses the county from N. to S., by way of Tuam, Athenry and Gort.

Population and Administration.—The population of county Galway (211,227 in 1891; 192,549 in 1901) decreased by more than half in the last seventy years of the 19th century, and the decrease continues, as emigration is heavy. About 97% of the population are Roman Catholics, and a somewhat less percentage are rural. The Erse tongue is maintained by many in this remote county. The chief towns are Galway (pop. 13,426), Tuam (3012), Ballinasloe (4904) and Loughrea (2815), with the smaller towns of Portumna, Gort, Clifden, Athenry, Headford, Oughterard and Eyrecourt. The county is divided into four parliamentary divisions (returning one member each); north, south, east and Connemara, while the town of Galway returns one member. There are eighteen baronies. Assizes are held at Galway, quarter-sessions at Galway, Ballinasloe, Clifden, Gort, Loughrea, Oughterard, Portumna and Tuam. The county comprises parts of the Protestant dioceses of Tuam and of Killaloe; and of the Roman Catholic dioceses of Elphin, Galway, Clonfert and Killaloe.

History.—The history of county Galway is exceedingly obscure, and nearly every one of its striking physical features carries its legend with it. For centuries local septs struggled together for mastery undeterred by outside influence. The wreck of part of the Spanish Armada on this coast in 1588 left survivors whose influence is still to be traced. The formation of Galway into a county was effected about 1579 by Sir Henry Sydney, lord deputy of Ireland. In the county at Aughrim (q.v.) the decisive battle of the English Revolution was fought in 1691. Among the antiquities are several round towers. The only perfect one is at Kilmacduagh, a very fine example 112 ft. high, leaning considerably out of the perpendicular. Raths or encampments are numerous and several cromlechs are to be seen in good preservation. The ruins of monastic buildings are also numerous. That of Knockmoy, about 6 m. from Tuam, said to have been founded in 1180 by Cathal O'Connor, was adorned with rude fresco paintings, still discernible, which were considered valuable as being the best authentic representations existing of ancient Irish costumes. Ancient castles and square towers of the Anglo-Norman settlers are frequently met with; some have been kept in repair, but the greater number are in ruins. The castle of Tuam, built in 1161 by Roderick O'Connor, king of Ireland, at the period of the English invasion, is said to have been the first building of this description of stone and mortar in Ireland. The remains of a round castle, a form of building very uncommon in the military architecture of the country, are to be seen between Gort and Kilmacduagh. The extraordinary cyclopean and monastic ruins on the Aran Islands (q.v.) must be mentioned; and the town of Galway, Athenry, and the neighbourhood of Ballinasloe all show interesting remains. The small church of Clonfert, in the south of the county, with a fine Romanesque doorway, is a cathedral, the diocese of which was united with Kilkenna, Kilmacduagh and Killaloe in 1833.

GALWAY, a seaport, parliamentary borough and the county town of county Galway, Ireland, on the north shore of Galway Bay, and on the main line of the Midland Great Western railway. Pop. of urban district (1901) 13,426. Some of the streets are very narrow, and contain curious specimens of old buildings, chiefly in antique Spanish style, being square, with a central court, and a gateway opening into the street. The most noteworthy of these is the pile known as Lynch's Castle. This residence takes its name from the family of whom James Lynch Fitzstephen, mayor of Galway in 1493, was a member; whose severity as a magistrate is exemplified in the story that he executed his own son, and thus gave origin (according to one of several theories) to the familiar term of Lynch law. The principal streets are broad and contain good shops. St Nicholas church is a fine cruciform building founded in 1320, and containing monuments, and a bell, one of a peal, which appears to have been brought from Cavour in France, but how this happened is not known. The church was made collegiate in 1484, and Edward VI. created the Royal College of Galway in connexion with it;

but the old college buildings no longer serve this purpose, and the church ceased to be collegiate in 1840. There are remains of a Franciscan friary founded in 1296. St Augustine's church (Roman Catholic) is modern (1859). The town is the seat of a Roman Catholic diocese. There are grammar, model and industrial schools, the first with exhibitions to Trinity College, Dublin; but the principal educational establishment is University College, a quadrangular building in Tudor Gothic style, of grey limestone. It was founded as Queen's College, with other colleges of the same name at Belfast and Cork, under an act of 1845, and its name was changed when it was granted a new charter pursuant to the Irish Universities Act 1908. The harbour comprises an extensive line of quays, and is connected for inland navigation with Lough Corrib. The shipping trade is considerable, but as a trans-Atlantic port Galway was exploited unsuccessfully. The fisheries, both sea and salmon, are important. The chief exports are wool, agricultural produce and black marble, which is polished in local mills. Other industrial establishments include corn-mills, iron-foundries, distilleries, and brush and bag factories. The borough, which returned two members to parliament until 1885, now returns one.

Galway is divided into the old and new towns, while a suburb known as the Claddagh is inhabited by fishermen. This is a curious collection of small cottages, where communal government by a locally elected mayor long prevailed, together with peculiar laws and customs, strictly exclusive inter-marriage, and a high moral and religious standard. Specimens of the distinctive Claddagh ring, for example, were worn and treasured as venerated heirlooms. These customs, with the distinctive dress of the women, died out but slowly, and even to-day their vestiges remain.

The environs of Galway are pleasant, with several handsome residences. The most interesting point in the vicinity is Roscam, with its round tower, ruined church and other remains. Salthill, with golf links, is a waterside residential suburb.

Little is known of the history of Galway until after the arrival of the English, at which time it was under the protection of O'Flaherty, who possessed the adjoining district to the west. On the extinction of the native dynasty of the O'Connors, the town fell into the hands of the De Burgos, the head of a branch of which, under the name of M'William Eighter, long governed it by magistrates of his own appointment. After it had been secured by walls, which began to be built about 1270 and are still in part traceable, it became the residence of a number of enterprising settlers, through whom it attained a position of much commercial celebrity. Of these settlers the principal families, fourteen in number, were known as the tribes of Galway. They were of Norman, Saxon or Welsh descent, and became so exclusive in their relationships that dispensations were frequently requisite for the canonical legality of marriages among them. The town rapidly increased from this period in wealth and commercial rank, far surpassing in this respect the rival city of Limerick. Richard II. granted it a charter of incorporation with liberal privileges, which was confirmed by his successor. It had the right of coinage by act of parliament, but there is no evidence to show that it exercised the privilege. Another charter, granted in 1545, extended the jurisdiction of the port to the islands of Aran, permitted the exportation of all kinds of goods except lincens and woollens, and confirmed all the former privileges. Large numbers of Cromwell's soldiers are said to have settled in the town; and there are many traces of Spanish blood among the population. Its municipal privileges were extended by a charter from James I., whereby the town, and a district of two miles round in every direction, were formed into a distinct county, with exclusive jurisdiction and a right of choosing its own magistrates. During the civil wars of 1641 the town took part with the Irish, and was surrendered to the Parliamentary forces under Sir Charles Coote; after which the ancient inhabitants were mostly driven out, and their property was given to adventurers and soldiers, chiefly from England. On the accession of James II. the old inhabitants entertained sanguine hopes of recovering their former rights. But the successes of King William soon put an end to their ex-

pectations; and the town, after undergoing another siege, again capitulated to the force brought against it by General Ginkel.

GAMA, VASCO DA (c. 1460-1524), Portuguese navigator and discoverer of the sea-route to India, was born at Sines, a small seaport in the province of Alemtejo. Of da Gama's early history little is known. His descent, according to the *Nobiliario* of Antonio de Lima, was derived from a noble family which is mentioned in the year 1166; but the line cannot be traced without interruption farther back than the year 1280, to one Alvaro da Gama, from whom was descended Estevão da Gama, civil governor of Sines, whose third son Vasco was born probably about the year 1460. In that year died Prince Henry the Navigator, to whose intelligence and foresight must be traced back all the fame that Portugal gained on the seas in the 15th and 16th centuries. Explorers sent out at his instigation discovered the Azores and unknown regions on the African coast, whence continually came reports of a great monarch, "who lived east of Benin, 350 leagues in the interior, and who held both temporal and spiritual dominion over all the neighbouring kings," a story which tallied so remarkably with the accounts of "Prester John" which had been brought to the Peninsula by Abyssinian priests, that John II. of Portugal steadfastly resolved that both by sea and by land the attempt should be made to reach the country of this potentate. For this purpose Pedro de Covilham and Afonso de Payva were despatched eastward by land; while Bartholomeu Diaz (q.v.), in command of two vessels, was sent westward by sea (see *ABYSSINIA*, 14). That there was in truth an ocean highway to the East was proved by Diaz, who returned in December 1488 with the report that when sailing southward he was carried far to the east by a succession of fierce storms, past—as he discovered only on his return voyage—what he ascertained to be the southern extremity of the African continent. The condition of John's health and concerns of state, however, prevented the fitting out of the intended expedition; and it was not till nine years later, when Emanuel I. had succeeded to the throne, that the preparations for this great voyage were completed—hastened, doubtless, by Columbus's discovery of America in the meanwhile.

For the supreme command of this expedition the king selected Vasco da Gama, who had in his youth fought in the wars against Castile, and in his riper years gained distinction as an intrepid mariner. The fleet, consisting of four vessels specially built for this mission, sailed down the Tagus on the 9th of July 1497, after prayers and confession made by the officers and crews in a small chapel on the site where now stands the church of S. Maria de Belem (see *LISBON*), afterwards built to commemorate the event. Four months later the flotilla cast anchor in St Helena Bay, South Africa, rounded the Cape in safety, and in the beginning of the next year reached Malindi, on the east coast of Africa. Thence, steering eastward, under the direction of a pilot obtained from Indian merchants met with at this port, da Gama arrived at Calicut, on the Malabar coast, on the 20th May 1498, and set up, according to the custom of his country, a marble pillar as a mark of conquest and a proof of his discovery of India. His reception by the zamorin, or Hindu ruler of Calicut, would have in all probability been favourable enough, had it not been for the jealousy of the Mahomedan traders who, fearing for their gains, so incited the Hindus against the new-comers that da Gama was unable to establish a Portuguese factory. Having seen enough of India to assure him of its great resources, he returned to Portugal in September 1499. The king received him with every mark of distinction, granted him the use of the prefix *Dom*, thus elevating him to the rank of an untitled noble, and conferred on him pensions and other property. In prosecution of da Gama's discoveries another fleet of thirteen ships was immediately sent out to India under Pedro Alvares Cabral, who, in sailing too far westward, by accident discovered Brazil, and on reaching his destination established a factory at Calicut. The natives, again instigated by the Mahomedan merchants, rose up in arms and murdered all whom Cabral had left behind. To avenge this outrage a powerful armament of ten ships was fitted out at Lisbon, the command of which was at first given to

Cabral, but was afterwards transferred to da Gama, who received the title admiral of India (January 1502). A few weeks later the fleet sailed, and on reaching Calicut da Gama immediately bombarded the town, treating its inhabitants with a savagery too horrible to describe. From Calicut he proceeded in November to Cochin, "doing all the harm he could on the way to all that he found at sea," and having made favourable trading terms with it and with other towns on the coast, he returned to Lisbon in September 1503, with richly laden ships. He and his captains were welcomed with great rejoicings and he received additional privileges and revenues.

Soon after his return da Gama retired to his residence in Evora, possibly from pique at not obtaining so high rewards as he expected, but more probably in order to enjoy the wealth and position which he had acquired; for he was now one of the richest men in the kingdom. He had married, probably in 1500, a lady of good family, named Catherina de Ataide, by whom he had six sons. According to Correa, he continued to advise King Emanuel I. on matters connected with India and maritime policy up to 1505, and there are extant twelve documents dated 1507-1522 which prove that he continued to enjoy the royal favour. The most important of these is a grant dated December 1519 by which Vasco da Gama was created count of Vidigueira, with the extraordinary privileges of civil and criminal jurisdiction and ecclesiastical patronage. During this time the Portuguese conquests increased in the East, and were presided over by successive viceroys. The fifth of these was so unfortunate that da Gama was recalled from his seclusion by Emanuel's successor, John III., and nominated viceroy of India, an honour which in April 1524 he left Lisbon to assume. Arriving at Goa during September of the same year, he immediately set himself to correct with vigour the many abuses which had crept in under the rule of his predecessors. He was not destined, however, to prosecute the reforms he had inaugurated, for, on the Christmas-eve following his arrival, he died at Cochin after a short illness, and was buried in the Franciscan monastery there. In 1538 his body was conveyed to Portugal and entombed in the town of Vidigueira. In 1880 what were supposed on insufficient evidence to have been his remains were transferred to the church of Santa Maria de Belem. His voyage had the immediate result of enriching Portugal, and raising her to one of the foremost places among the nations of Europe, and eventually the far greater one of bringing to pass the colonization of the East by opening its commerce to the Western world.

BIBLIOGRAPHY.—*Vasco da Gama's First Voyage*, by Dr E. Ravenstein (London, Hakluyt Society, 1898), is a translation with notes, &c., of the anonymous *Roteiro* (Journal or Itinerary), written by one of Vasco da Gama's subordinates who sailed on board the "S. Raphael," which was commanded by the admiral's brother Paulo da Gama. This is the most important of the original authorities; five accounts of the voyage in letters contemporary with it are appended to the Hakluyt Society's translation. See also J. de Barros, *Decadas da India* (Lisbon, 1778-1788, written c. 1540); F. L. de Castanheira, *Historia do descobrimento da India* (Coimbra, 1551, largely based on the *Roteiro*); *The Three Voyages of Vasco da Gama and his Viceroyalty*, by Gaspar Correa (Hakluyt Society, 1869), chiefly valuable for the events of 1524; *The Lusians of Camoens*, the central incident in which is Vasco da Gama's first voyage; *Calicoen* (i.e. Calicut), a Dutch Narrative of the Second Voyage of Vasco da Gama, written by some unknown seaman of the expedition, printed at Antwerp about 1504, reprinted in facsimile, with introduction and translation, by J. Ph. Berjeau (London, 1874); Thomé Lopes, narrative (1502) in vol. i. of Ramusio.

GAMALIEL (גמליאל). This name, which in Old Testament times figures only as that of a prince of the tribe of Manasseh (*vide* Num. i. 10, &c.), was hereditary among the descendants of Hillel. Six persons bearing the name are known.

1. **GAMALIEL I.**, a grandson of Hillel, and like him designated *Ha-Zaqen* (the Elder), by which is apparently indicated that he was numbered among the Sanhedrin, the high council of Jerusalem. According to the tradition of the schools of Palestine Gamaliel succeeded his grandfather and his father (of the latter nothing is known but his name, Simeon) as *Nasi*, or president of the Sanhedrin. Even if this tradition does not correspond with historic fact, it is at any rate certain that Gamaliel took a leading

position in the Sanhedrin, and enjoyed the highest repute as an authority on the subject of knowledge of the Law and in the interpretation of the Scriptures. He was the first to whose name was prefixed the title *Rabban* (Master, Teacher). It is related in the Acts of the Apostles (v. 34 et seq.) that his voice was uplifted in the Sanhedrin in favour of the disciples of Jesus who were threatened with death, and on this occasion he is designated as a Pharisee and as being "had in reputation among all the people" (*νομοδιδάκαλος τιμους παντι τῷ λαῷ*). In the Mishna (*Gittin* iv. 1-3) he is spoken of as the author of certain legal ordinances affecting the welfare of the community (the expression in the original is "*higgon ha-'adam*," i.e. improvement of the world) and regulating certain questions as to conjugal rights. In the tradition was also preserved the text of the epistles regarding the insertion of the intercalary month, which he sent to the inhabitants of Galilee and the Darom (i.e. southern Palestine) and to the Jews of the Dispersion (Sanhedrin 11b and elsewhere). He figures in two anecdotes as the religious adviser of the king and queen, i.e. Agrippa I. and his wife Cypris (Pesahim 88 b). His function as a teacher is proved by the fact that the Apostle Paul boasts of having sat at the feet of Gamaliel (Acts. xxii. 3). Of his teaching, beyond the saying preserved in Aboth i. 16, which enjoins the duty of study and of scrupulousness in the observance of religious ordinances, only a very remarkable characterization of the different natures of the scholars remains (Aboth di R. Nathan, ch. xl.). His renown in later days is summed up in the words (Mishna, end of Sotah): "When Rabban Gamaliel the Elder died, regard for the Torah (the study of the Law) ceased, and purity and piety died." As Gamaliel I. is the only Jewish scribe whose name is mentioned in the New Testament he became a subject of Christian legend, and a monk of the 12th century (Hermann the Premonstratensian) relates how he met Jews in Worms studying Gamaliel's commentary on the Old Testament, thereby most probably meaning the Talmud.

2. **GAMALIEL II.**, the son of Simon ben Gamaliel, one of Jerusalem's foremost men in the war against the Romans (*vide* Josephus, *Bellum Jud.* iv. 3, 9, *Vita* 38), and grandson of Gamaliel I. To distinguish him from the latter he is also called Gamaliel of Jabneh. In Jabneh (Jamnia), where during the siege of Jerusalem the scribes of the school of Hillel had taken refuge by permission of Vespasian, a new centre of Judaism arose under the leadership of the aged Johanan ben Zakkai, a school whose members inherited the authority of the Sanhedrin of Jerusalem. Gamaliel II. became Johanan ben Zakkai's successor, and rendered immense service in the strengthening and reintegration of Judaism, which had been deprived of its former basis by the destruction of the Temple and by the entire loss of its political autonomy. He put an end to the division which had arisen between the spiritual leaders of Palestinian Judaism by the separation of the scribes into the two schools called respectively after Hillel and Shammai, and took care to enforce his own authority as the president of the chief legal assembly of Judaism with energy and often with severity. He did this, as he himself said, not for his own honour nor for that of his family, but in order that disunion should not prevail in Israel. Gamaliel's position was recognized by the Roman government also. Towards the end of Domitian's reign (c. A. D. 95) he went to Rome in company with the most prominent members of the school of Jabneh, in order to avert a danger threatening the Jews from the action of the terrible emperor. Many interesting particulars have been given regarding the journey of these learned men to Rome and their sojourn there. The impression made by the capital of the world upon Gamaliel and his companions was an overpowering one, and they wept when they thought of Jerusalem in ruins. In Rome, as at home, Gamaliel often had occasion to defend Judaism in polemical discussions with pagans, and also with professed Christians. In an anecdote regarding a suit which Gamaliel was prosecuting before a Christian judge, a converted Jew, he appeals to the Gospel and to the words of Jesus in Matt. v. 17 (Shabbath 116 a, b). Gamaliel devoted special attention to the regulation of the rite of prayer, which after the

cessation of sacrificial worship had become all-important. He gave the principal prayer, consisting of eighteen benedictions, its final revision, and declared it every Israelite's duty to recite it three times daily. He was on friendly terms with many who were not Jews, and was so warmly devoted to his slave Tabi that when the latter died he mourned for him as for a beloved member of his own family. He loved discussing the sense of single portions of the Bible with other scholars, and made many fine expositions of the text. With the words of Deut. xiii. 18 he associated the lesson: "So long as thou thyself art merciful, God will also be merciful to thee." Gamaliel died before the insurrections under Trajan had brought fresh unrest into Palestine. At his funeral obsequies the celebrated proselyte Aquila (Akylas Onkelos), reviving an ancient custom, burned costly materials to the value of seventy minae. Gamaliel himself had given directions that his body was to be wrapped in the simplest possible shroud. By this he wished to check the extravagance which had become associated with arrangements for the disposal of the dead, and his end was attained; for his example became the rule, and it also became the custom to commemorate him in the words of consolation addressed to the mourners (Kethub. 8 b). Gamaliel's son, Simon, long after his father's death, and after the persecutions under Hadrian, inherited his office, which thenceforward his descendants handed on from father to son.

3. GAMALIEL III., son of Jehuda I. the redactor of the Mishna, and his successor as *Nasi* (patriarch). The redaction of the Mishna was completed under him, and some of his sayings are incorporated therein (Aboth ii. 2-4). One of these runs as follows: "Beware of those in power, for they permit men to approach them only for their own uses; they behave as friends when it is for their advantage, but they do not stand by a man when he is in need." Evidently this was directed against the self-seeking of the Roman government. Gamaliel III. lived during the first half of the 3rd century.

4. GAMALIEL IV., grandson of the above, patriarch in the latter half of the 3rd century: about him very little is known.

5. GAMALIEL V., son and successor of the patriarch Hillel II.: beyond his name nothing is known of him. He lived in the latter half of the 4th century. He is the patriarch Gamaliel whom Jerome mentions in his letter to Pamachius, written in 393.

6. GAMALIEL VI., grandson of the above, the last of the patriarchs, died in 425. With him expired the office, which had already been robbed of its privileges by a decree of the emperors Honorius and Theodosius II. (dated the 17th of October 415). Gamaliel VI. was also a physician, and a celebrated remedy of his is mentioned by his contemporary Marcellus (*De Medicamentis*, liber 21).

(W. BA.)

GAMBETTA, LÉON (1838-1882), French statesman, was born at Cahors on the 2nd of April 1838. His father, a Genoese, who had established himself as a grocer and had married a Frenchwoman named Massabie, is said to have been his son's prototype in vigour and fluency of speech. In his sixteenth year young Gambetta lost by an accident the sight of his left eye, which eventually had to be removed. Notwithstanding this privation, he highly distinguished himself at the public school of Cahors, and in 1857 proceeded to Paris to study law. His southern vehemence gave him great influence among the students of the Quartier Latin, and he was soon known as an inveterate enemy of the imperial government. He was called to the bar in 1859, but, although contributing to a Liberal review, edited by Challemeil Lacour, did not make much way until, on the 17th of November 1868, he was selected to defend the journalist Delescluze, prosecuted for having promoted the erection of a monument to the representative Baudin, who was killed in resisting the *coup d'état* of 1851. Gambetta seized his opportunity and assailed both the *coup d'état* and the government with an eloquence of invective which made him immediately famous.

In May 1866 he was returned to the Assembly, both by the first circumscription of Paris and by Marseilles, defeating Hippolyte Carnot for the former constituency and Thiers and Lesseps for the latter. He elected to sit for Marseilles, and lost no opportunity of attacking the Empire in the Assembly. He was at first

opposed to the war with Germany, but when satisfied that it had been forced upon France he did not, like some of his colleagues, refuse to vote supplies, but took the patriotic line of supporting the flag. When the news of the disaster at Sedan reached Paris, Gambetta called for strong measures. He himself proclaimed the fall of the emperor at the *corps législatif*, and the establishment of a republic at the hôtel de ville. He was one of the first members of the new government of national defence, becoming minister of the interior. He advised his colleagues to leave Paris and conduct the government from some provincial city. This advice was rejected from dread of another revolution in Paris, and a delegation to organize resistance in the provinces was despatched to Tours, but when this was seen to be inefficient Gambetta himself (7th October) quitted Paris in a balloon, and upon arriving at Tours took the supreme direction of affairs as minister of the interior and of war. Aided by M. de Freycinet, then a young officer of engineers, as his assistant secretary of war, he displayed prodigies of energy and intelligence. He speedily organized an army, which might possibly have effected the relief of Paris if Metz had held out, but the surrender of Bazaine brought the army of the crown prince into the field, and success was impossible. After the defeats of the French near Orleans early in December the seat of government had to be transferred to Bordeaux, and when Paris surrendered at the end of January, Gambetta, though resisting and protesting, was compelled to submit to the capitulation concluded with Prince Bismarck. He immediately resigned his office. Elected by nine departments to the National Assembly meeting at Bordeaux (on the 1st of March 1871) he chose to sit for Strassburg, which by the terms of the treaty about to be submitted to the Assembly for ratification was to be ceded to Prussia, and when the treaty was adopted he resigned in protest and retired to Spain.

He returned to France in June, was elected by three departments in July, and commenced an agitation for the definitive establishment of the Republic. On the 5th of November 1871 he established a journal, *La République française*, which soon became the most influential in France. His orations at public meetings were more effective than those delivered in the Assembly, especially that made at Bordeaux on his return, and that at Grenoble on the 26th of November 1872, in which he spoke of political power having passed to *les nouvelles couches sociales*. When Thiers, however, fell from power in May 1873, and a Royalist was placed at the head of the government in the person of Marshal MacMahon, Gambetta gave proof of his statesmanship by unceasingly urging his friends to a moderate course, and by his tact and parliamentary dexterity, no less than by his eloquence, he was mainly instrumental in the voting of the constitution in February 1875. This policy he continued during the early days of the now consolidated Republic, and gave it the appropriate name of "opportunism." It was not until the 4th of May 1877, when the peril from reactionary intrigues was notorious, and the clerical party had begun a campaign for the restoration of the temporal power of the pope, that he delivered his famous speech denouncing "clericalism" as "the enemy." On the 16th of May Marshal MacMahon, in order to support the clerical reactionaries, perpetrated his parliamentary *coup d'état*, and on the 15th of August Gambetta, in a speech at Lille, gave him the alternative *se soumettre ou se démettre*. He then undertook a political campaign to rouse the republican party throughout France, which culminated in a speech at Romans (September 18, 1878) formulating its programme. MacMahon, equally unwilling to resign or to provoke civil war, had no choice but to dismiss his advisers and form a moderate republican ministry under the premiership of Dufaure.

When the resignation of the Dufaure cabinet brought about the abdication of Marshal MacMahon, Gambetta declined to become a candidate for the presidency, but gave his support to Grévy; nor did he attempt to form a ministry, but accepted the office of president of the chamber of deputies (January 1879). This position, which he filled with much ability, did not prevent his occasionally descending from the presidential chair to make speeches, one of which, advocating an amnesty to the

communards, was especially memorable. Although he really directed the policy of the various ministries, he evidently thought that the time was not ripe for asserting openly his own claims to direct the policy of the Republic, and seemed inclined to observe a neutral attitude as far as possible; but events hurried him on, and early in 1881 he placed himself at the head of a movement for restoring *scrutin de liste*, or the system by which deputies are returned by the entire department which they represent, so that each elector votes for several representatives at once, in place of *scrutin d'arrondissement*, the system of small constituencies, giving one member to each district and one vote to each elector. A bill to re-establish *scrutin de liste* was passed by the Assembly on 19th May 1881, but rejected by the Senate on the 19th of June.

But this personal rebuff could not alter the fact that in the country his was the name which was on the lips of the voters at the election. His supporters were in a large majority, and on the reassembling of the chamber, the Ferry cabinet quickly resigned. Gambetta was unwillingly entrusted by Grévy on the 14th of November 1881 with the formation of a ministry—known as *Le Grand Ministère*. He now experienced the Nemesis of his over-cautious system of abstinence from office for fear of compromising his popularity. Every one suspected him of aiming at a dictatorship; attacks, not the less formidable for their injustice, were directed against him from all sides, and his cabinet fell on the 26th of January 1882, after an existence of only sixty-six days. Had he remained in office his declarations leave no doubt that he would have cultivated the British alliance and co-operated with Great Britain in Egypt; and when the Freycinet administration, which succeeded, shrank from that enterprise only to see it undertaken with signal success by England alone, Gambetta's foresight was quickly justified. His fortunes were presenting a most interesting problem when, on the 31st of December 1882, at his house in Ville d'Avray, near Sèvres, he died by a shot from a revolver which accidentally went off. Then all France awoke to a sense of her obligation to him, and his public funeral on the 6th of January 1883 evoked one of the most overwhelming displays of national sentiment ever witnessed on a similar occasion.

Gambetta rendered France three inestimable services: by preserving her self-respect through the gallantry of the resistance he organized during the German War, by his tact in persuading extreme partisans to accept a moderate Republic, and by his energy in overcoming the usurpation attempted by the advisers of Marshal MacMahon. His death, at the early age of forty-four, cut short a career which had given promise of still greater things, for he had real statesmanship in his conceptions of the future of his country, and he had an eloquence which would have been potent in the education of his supporters. The romance of his life was his connexion with Léonie Léon (d. 1906), the full details of which were not known to the public till her death. This lady, with whom Gambetta fell in love in 1871, was the daughter of a French artillery officer. She became his mistress, and the *liaison* lasted till he died. Gambetta himself constantly urged her to marry him during this period, but she always refused, fearing to compromise his career; she remained, however, his confidente and intimate adviser in all his political plans. It is understood that at last she had just consented to become his wife, and the date of the marriage had been fixed, when the accident which caused his death occurred in her presence. Contradictory accounts have indeed been given as to this fatal episode, but that it was accidental, and not suicide, is certain. On Gambetta the influence of Léonie was absorbing, both as lover and as politician, and the correspondence which has been published shows how much he depended upon her. But in various matters of detail the serious student of political history must be cautious in accepting her later recollections, some of which have been embodied in the writings of M. Francis Laur, such as that an actual interview took place in 1878 between Gambetta and Bismarck. That Gambetta after 1875 felt strongly that the relations between France and Germany might be improved, and that he made it his object, by travelling incognito, to become better acquainted with Germany

and the adjoining states, may be accepted, but M. Laur appears to have exaggerated the extent to which any actual negotiations took place. On the other hand, the increased knowledge of Gambetta's attitude towards European politics which later information has supplied confirms the view that in him France lost prematurely a master mind, whom she could ill spare. In April 1905 a monument by Dalou to his memory at Bordeaux was unveiled by President Loubet.

Gambetta's *Discours et plaidoyers politiques* were published by J. Reinach in 11 vols. (Paris, 1881-1886); his *Dépêches, circulaires, décrets* . . . in 2 vols. (Paris, 1886-1891). Many biographies have appeared. The principal are J. Reinach, *Léon Gambetta* (1884), *Gambetta orateur* (1884) and *Le Ministère Gambetta, histoire et doctrine* (1884); Neucastel, *Gambetta, sa vie, et ses idées politiques* (1885); J. Hanlon, *Gambetta* (London, 1881); Dr Laborde, *Léon Gambetta biographie psychologique* (1898); P. B. Gheusi, *Gambetta, Life and Letters* (Eng. trans. by V. M. Montagu, 1910). See also G. Hanotaux, *Histoire de la France contemporaine* (1903, 8c.); F. Laur's *Le Cœur de Gambetta* (1907; Eng. trans., 1908) contains the correspondence with Léonie Léon; see also his articles on "Gambetta and Bismarck" in *The Times* of August 17 and 19, 1907, with the correspondence arising from them. (H. Cu.)

GAMBIA, an important river of West Africa, and the only river of Africa navigable by ocean-going boats at all seasons for over 200 m. from its mouth. It rises in about 11° 25' N. and 12° 15' W., within 150 m. of the sea on the north-eastern escarpment of the Futa Jallon highlands, the massif where also rise the head-streams of the Senegal and some of the Niger tributaries, besides the Rio Grande and many other rivers flowing direct to the Gulf of Guinea. The Gambia, especially in its lower course, is very serpentine, and although the distance from the source to the mouth of the river is little more than 300 m. in a direct line, the total length of the stream is about 1000 m. It flows first N.N.E., receiving many left-hand tributaries, but about 12° 35' N. takes a sharp bend N.W. and maintains this direction until it leaves the fertile and hilly region of Bondou. The descent to the lower district is marked by the Barraconda rapids, formed by a ledge of rock stretching across the river. Between 30 and 50 m. above the falls the Gambia is joined by two considerable affluents, the Nieriko from the north and the Kuluntu or Grey river from the south. From the Barraconda rapids to the Atlantic the Gambia has a course of about 350 m. Throughout this distance the waters are tidal, and the river is navigable all the year round by boats drawing 6 ft. of water. At Yarbattenda, a few miles below Barraconda, the river has a breadth, even at the dry season, of over 300 ft., with a depth of 13 to 20 ft. From the falls to McCarthy's Island, a distance of 200 m., the river valley, which here presents a park-like appearance, is enclosed by low rocky hills of volcanic character. For 50 m. below the island, where the stream is about 800 yds. wide, the banks of the river are steep and thickly wooded. They then become low and are fringed with mangrove swamps. From Devil's Point, a sharp promontory on the north bank—up to which place the water is salt—the river widens considerably and enters the Atlantic, in about 13½° N. and 16½° W., by a broad estuary. Near the mouth of the river on the south side is St Mary's Island (3½ m. long by 1½ broad), and opposite on the north bank is Barra Point, the river being here contracted to 2½ m. Eighteen miles lower down the distance from shore to shore is 27 m. There is a sand-bar at the entrance to the river, but at the lowest state of the tide there are 26 ft. of water over the bar. The Gambia is in flood from November to June, when the Barraconda rapids are navigable by small boats. Above the rapids the stream is navigable for 160 m. Politically the Gambia is divided between Great Britain and France—Britain possessing both banks of the river up to, but not including, Yarbattenda.

The Gambia was one of the rivers passed by Hanno the Carthaginian in his famous voyage along the west coast of Africa. It was known to Ptolemy and the Arabian geographers, and was at one time supposed to be a mouth of the Nile, and, later (18th century), a branch of the Niger. It was possibly visited by Genoese navigators in 1291, and was certainly discovered by the Portuguese c. 1446, but was first explored for any distance from its mouth (1455) by the Venetian Alvise Cadamosto

(*q.v.*), who published an account of his travels at Vicenza in 1507 (*La Prima Navigazione per l'Oceano alle terre de' Negri della Bassa Etiopia*). Afterwards the Gambia became a starting-place for explorers of the interior, among them Mungo Park, who began both his journeys (1795 and 1805) from this river. It was not until 1818 that the sources of the Gambia were reached, the discovery being made by a Frenchman, Gaspard Mollien, who had travelled by way of the Senegal and Bondou. The middle course of the river was explored in 1851 by R. G. MacDonnell, then governor of the Gambia colony, and in 1881 Dr V. S. Gouldsbury also navigated its middle course. No native craft of any kind was seen above Barraconda. The more correct name of the river is Gambra, and it is so called in old books of travel.

See Mungo Park's *Travels* (London, 1799); G. Mollien, *Travels... to the Sources of the Senegal and Gambia*... edited by T. E. Bowdich (London, 1820); the account of Dr Gouldsbury's journey in the Blue Book C 3065 (1881), also under the country heading below.

GAMBIA, the most northerly of the British West African dependencies. It consists of a stretch of land on both sides of the lower Gambia. The colony, with the protectorate dependent upon it, has an area of about 4000 sq. m. and a population officially estimated (1907) at 163,000. The colony proper (including St Mary's Island, British Kommo, the Ceded Mile, McCarthy's Island and other islets) has an area of about 60 sq. m. The protectorate consists of a strip of land extending ten kilometres (about 6 m.) on each side of the river to a distance of about 200 m. in a direct line from the sea. The land outside these limits is French. Within the protectorate are various petty kingdoms, such as Barra, to the north of the Gambia, and Kommo, to the south. The breadth of the colony near the coast is somewhat greater than it is higher up. The greatest breadth is 30 m.

Physical Features, Fauna and Flora.—The colony, as its name implies, derives its character and value from the river Gambia (*q.v.*), which is navigable throughout and beyond the limits of the colony, while large ocean-going ships can always cross the bar at its mouth and enter the port of Bathurst. Away from the swamps by the river banks, the country is largely "bush." The region above McCarthy's Island is hilly. Much of the land is cleared for cultivation. The fauna includes lions, leopards, several kinds of deer, monkeys, bush-cow and wild boar. Hippopotami are found in the upper part of the river, and crocodiles abound in the creeks. The birds most common are bush-fowl, bustards, guinea-fowl, quail, pigeon and sand-grouse. Bees are very numerous in parts of the country. The flora resembles that of West Africa generally, the mangrove being common. Mahogany and rosewood (*Pterocarpus erinaceus*) trees are found, though not in large numbers, and the rubber-vine and oil-palm are also comparatively scarce. There are many varieties of fern. The cassava (manioc) and indigo plants are indigenous.

Climate.—The climate during the dry season (November–June) is the best on the British West African coast, and the Gambia is then considered fairly healthy. Measures for the extermination of the malarial mosquito are carried on with good effect. The mean temperature at Bathurst is 77° F., the shade minimum being 56° and the solar maximum 105°. Up river the variation in temperature is even greater than at Bathurst, from 50° in the morning to 100° at 3 p.m., being common at McCarthy's Isle. The average rainfall is about 50 in. a year, but save for showers in May and June there is rarely any rain except between July and October. The first instance of rain in December in twenty-six years was recorded in 1906. The dry east wind known as the harmattan blows intermittently from December to March.

Inhabitants.—The inhabitants, who are both thrifty and industrious, are almost entirely of Negro or Negroid race, the chief tribes represented being the Mandingo (*q.v.*), the Jolof and the Jola. Numbers of Fula (*q.v.*) are also settled in the country. Fully four-fifths of the natives are Mahomedans. The few European residents are officials, traders or missionaries.

Towns and Trade.—Bathurst, pop. about 8000, the chief town of the colony, in 13° 24' N., 16° 36' W., is built on St Mary's Island, which lies at the mouth of the river near its south bank and is connected with the mainland by a bridge across Oyster Creek. It was founded in 1816 and is named after the 3rd earl Bathurst, secretary of state for the colonies from 1812 to 1827. Bathurst is a fairly well-built town, the chief material employed being red sandstone. It lies about 12 to 14 ft. above the level of the river. The principal buildings face the sea, and include Government House, barracks, a well-appointed hospital,

founded by Sir R. G. MacDonnell (administrator, 1847–1852), and various churches. The market-place is shaded by a fine avenue of bombax and other wide-spreading trees. There are no other towns of any size in the Gambia. A trading station called Georgetown is situated on McCarthy's Island, so named after Sir Charles McCarthy, the governor of Sierra Leone, who in 1824 was captured and beheaded by the Ashanti at the battle of Essamako. Albrada, a small port on the north bank of the river, of some historic interest (see below), is in the Barra district.

Products.—Ground-nuts (*Arachis hypogaea*), rubber, beeswax, palm kernels, rice, cotton, and millet are the chief productions. Millet and rice are the staple food of the people. The curing of hides, the catching and drying of fish, boat-building, and especially the weaving of cotton into cloths called "pagns," afford employment to a considerable number of persons. Formerly the principal exports, besides slaves, were gold-dust, wax and hides, the gold being obtained from the Futa Jallon district farther inland. Between 1830 and 1840 from 1500 to 2000 oz. of gold were exported annually, but shipments ceased soon afterwards, though small quantities of gold-dust can still be obtained from native goldsmiths. The export of hides received a severe check in 1829–1833 through the death of nearly all the cattle, but after an interval of seven or eight years the industry gradually revived. The value of hides exported increased from £520 in 1902 to £9615 in 1907. The collection of rubber was started about 1880, but the trade has not assumed large proportions. In 1907 the value of the rubber exported was £4602. The export of wax, valued at £37,000 in 1843, had dwindled in 1907 to £2325. The cultivation of the ground-nut, first exported in 1830, assumed importance by 1837, and by 1850 had become the chief industry of the colony. In 1907 the value of the nuts was £256,685, over $\frac{1}{4}$ of the total exports (exclusive of specie). Nearly the whole male population is engaged in the industry for eight months of the year. Planted in June, after the early rains, the crop is reaped in October or November and exported to Europe (1 to Marseilles) for the extraction of its oil, which is usually sold as olive oil. A feature of the industry is the appearance at the beginning of the planting season of thousands of men from a distance, "strange farmers," as they are called, who are housed and fed and given farms to cultivate. In return they have to give half the produce to the landlords. As soon as he has sold his nuts, the "strange farmer" goes off, often not returning for years.

Apart from the cultivation of the ground-nut, the agricultural resources of the country are undeveloped. Large herds of cattle are kept by the Fula, and in cattle rich natives usually invest their wealth. Land can be hired for 2d. an acre per annum for twenty-one years. All land lying vacant or unused, or to which the occupier is unable to produce any title, is vested in the crown. A botanical station was opened in 1894, and the cultivation of American and Egyptian cotton was taken in hand in 1902. The experiment proved discouraging. Great difficulty was experienced in getting farmers to grow cotton for export, as unless carried on on highly scientific lines its cultivation is not so profitable as that of the ground-nut. The principal imports, of which over $\frac{1}{2}$ come from Great Britain or British colonies, are cotton goods, kola-nuts (from Sierra Leone), tobacco, rice, sugar and spirits. In the ten years 1898 to 1907 the average annual value of the exports was £301,000, of the imports £316,000. There are no mines in the colony, nor any apparent mineral wealth, except ridges of ironstone in the regions above McCarthy's Island. Bathurst is in telegraphic communication with Europe and the rest of Africa. There are no railways in the colony, but it is traversed by well-made roads of a uniform width of 18 ft. The Liverpool mail steamers call at the port every fortnight. A government steamer runs regularly from Bathurst to McCarthy's Island, and a smaller boat plies on the upper river. The shipping trade is chiefly British; French and German tonnage coming next.

Surrounded on all sides, save seawards, by French territory, the colony largely depends, economically, upon France, to which country most of the exports go. A considerable entrepôt trade is also done with the neighbouring French colonies. The extent of French influence is indicated by the fact that the five-franc piece, locally known as a dollar, is largely circulated throughout the protectorate, and is accepted as legal tender, although the currency in the colony proper is the English coinage.

Administration, Revenue, &c.—The Gambia is administered by a governor, assisted by an executive and a legislative council. On the last-named body nominated unofficial members have seats. The colony is self-supporting and has no public debt. The revenue, which in 1906 for the first time exceeded £60,000, is mainly derived from customs. A company of the West African Frontier Force is maintained. Travelling commissioners visit the five districts into which, for administrative purposes, the protectorate is divided, and in which the native form of government prevails. From the native law-courts appeal can be made to the supreme court at Bathurst. There is also at Bathurst a Mahomedan court, established in 1906, for the trial of cases involving the civil status of Moslems.

Primary schools are maintained by the various religious denominations, and receive grants from government. The Wesleyans have

also a secondary and a technical school. There is a privately supported school for Mahomedans at Bathurst. The Anglicans, Wesleyans and Roman Catholics have numerous converts.

History.—Of the early history of the Gambia district there is scant mention. At what period the stone circles and pillars (apparently of a "Druidical" character), whose ruins are found at several places along the upper Gambia, were erected is not known. Those at Lamin Koto, on the right bank of the river opposite McCarthy's Island, are still in good preservation, and are an object of veneration to the Mahomedans (see *Geog. Journ.* vol. xii., 1898). The country appears to have formed part, successively, of the states of Ghana, Melle and Songhoi. The relations, political and commercial, of the natives were all with the north and east; consequently no large town was founded on the banks of the river, nor any trade carried on (before the coming of the white man) by vessels sailing the ocean. About the 11th century the district came under Mahomedan influence.

The Portuguese visited the Gambia in the 15th century, and in the beginning of the 16th century were trading in the lower river. Embassies were sent from the Portuguese stations inland to Melle to open up trade with the interior, but about the middle of the century this trade—apparently mostly in gold and slaves—declined. At the end of the century the river was known as the resort of banished men and fugitives from Portugal and Spain. It was on the initiative of Portuguese living in England that Queen Elizabeth, in 1588, granted a patent to "certain merchants of Exeter and others of the west parts and of London for a trade to the river of Senega and Gambia in Guinea." This company was granted a monopoly of trade for ten years. Its operations led to no permanent settlement in the Gambia. In 1618 James I. granted a charter to another company named "The Company of Adventurers of London trading into Africa," and formed at the instigation of Sir Robert Rich, afterwards earl of Warwick, for trade with the Gambia and the Gold Coast. This company sought to open up trade with Timbuktou, then believed to be a great mart for gold, which reached the lower Gambia in considerable quantities. With this object George Thompson (a merchant who had traded with Barbary) was sent out in the "Catherine," and ascended the Gambia in his ship to Kassar, a Portuguese trading town, thence continuing his journey in small boats. In his absence the "Catherine" was seized and the crew murdered by Portuguese and half-castes, and Thompson himself was later on murdered by natives. Two years afterwards Richard Jobson, another agent of the Company of Adventurers, advanced beyond the falls of Barraconda; and he was followed, about forty years later, by Vermuyden, a Dutch merchant, who on his return to Europe asserted that he had reached a country full of gold.

The Company of Adventurers had built a fort near the mouth of the Gambia. This was superseded in 1664 by a fort built by Captain (afterwards Admiral Sir Robert) Holmes on a small island 20 m. from the mouth of the river and named Fort James, in honour of the duke of York (James II.). This fort was built expressly to defend the British trade against the Dutch, and from that time the British remained in permanent occupation of one or more ports on the river. In 1723 Captain Bartholomew Stibbs was sent out by the Royal African Company, which had succeeded the earlier companies, to verify Vermuyden's reports of gold. He proceeded 60 m. above the falls, but the land of gold was not found. The French now became rivals for the trade of the Gambia, but the treaty of Versailles in 1763 assigned the trade in the river to Britain, reserving, however, Albréda for French trade, while it assigned the Senegal to France, with the reservation of the right of the British to trade at Portendic for gum. This arrangement remained in force till 1857, when an exchange of possessions was effected and the lower Gambia became a purely British river. In the period between the signing of the treaty of Versailles and 1885 the small territories which form the colony proper were acquired by purchase or cession from native kings. St Mary's Isle was acquired in 1806; McCarthy's Isle was bought in 1823; the Ceded Mile was granted by the king of Barra in 1826; and British Kombo between 1840 and 1855. During

this period the colony had gone through an economic crisis by the abolition of the slave trade (1807), which had been since 1662 its chief financial support. The beginning of a return to prosperity came in 1816 when some British traders, obliged to leave Senegal on the restoration of that country to France after the Napoleonic wars, founded a settlement on St Mary's Isle. From that year the existing colony, as distinct from trading on the river, dates. The Gambia witnessed many administrative changes. When the slave trade was abolished, the settlement was placed under the jurisdiction of the governor of Sierra Leone, and was formally annexed to Sierra Leone on the dissolution of the Royal African Company (1822). It so remained until 1843, when the Gambia was made an independent colony, its first governor being Henry Frowd Seagram. Afterwards (1866) the Gambia became a portion of the officially styled "West African Settlements." In 1888 it was again made a separate government, administered as a crown colony. Between the years last mentioned—1866–1888—the colony had suffered from the retrograde policy adopted by parliament in respect to the West African Settlements (*vide* Report of the Select Committee of 1865).

In 1870 negotiations were opened between France and Great Britain on the basis of a mutual exchange of territories in West Africa. Suspended owing to the outbreak of the Franco-Prussian War the negotiations were resumed in 1876. "Definite proposals were at that time formulated by which the Gambia was to be exchanged for all posts by France between the Rio Pongas (Pongo river, French Guinea) and the Gabun. This would have been a comprehensive and intelligible arrangement, but so strong a feeling in opposition to any cession of British territory was manifested in parliament, and by various mercantile bodies, that the government of the day was unable to press the scheme." Nothing was done, however, to secure for the Gambia a suitable *hinterland*, and in 1877 the 4th earl of Carnarvon (then colonial secretary) warned British traders that they proceeded beyond McCarthy's Isle at their own risk. Meantime the French from Senegal pushed their frontier close to the British settlements, so that when the boundaries were settled by the agreement of the 10th of August 1889 with France, Great Britain was able to secure only a ten-kilometre strip on either side of the river. This document fixed the frontier of the British protectorate inland at a radius of 10 m. from the centre of the town of Yarbattenda; which town is situated at the limit of navigability of the Gambia from the sea. By Art. 5 of the Anglo-French convention of the 8th of April 1904, Yarbattenda was ceded to France, with the object of giving that country a port on the river accessible to sea-going merchantmen.

Since 1871 the colony had been self-supporting, but on the acquirement of the protectorate it was decided, in order to balance increasing expenditure, to impose a "hut tax" on the natives. This was done in 1895. The tax, which averages 4s. per annum for a family, met with no opposition.

In 1892 a slave-raiding chief, named Fodi Kabba, had to be forcibly expelled from British territory. In 1894 another slave-raider, Fodi Silah, gave much trouble to the protectorate. An expedition under Captain E. H. (afterwards admiral) Gamble succeeded in routing him, and Fodi Silah took refuge in French territory, where he died. During the expedition Captain Gamble was led into an ambush, and in this engagement lost 15 killed and 47 wounded. In 1900 trouble again arose through the agency of Fodi Kabba, who had fixed his residence at Medina, in French territory. Two travelling commissioners (Mr F. C. Sitwell and Mr Silva) were murdered in June of that year, at a place called Suankandi, and a punitive expedition was sent out under Colonel H. E. Brake. Suankandi was captured and, the French co-operating, Medina was also captured, Fodi Kabba being killed on the 23rd of March 1901.

The people of the protectorate are in general peaceful and contented, and slave trading is a thing of the past. Provision was moreover made by an ordinance of 1906 for the extinction of slavery itself throughout the protectorate, it being enacted that

¹ Extract from a despatch of Lord Salisbury to the British ambassador to France, dated 30th of March 1892.

henceforth all children born of slaves were free from birth, and that all slaves became free on the death of their master.

See the *Annual Reports* on the colony published by the colonial office, London, which give the latest official information; C. P. Lucas's *Historical Geography of the British Colonies*, vol. iii., *West Africa* (2nd ed., Oxford, 1900) (this book contains valuable bibliographical notes); and *The Gambia Colony and Protectorate*, an official handbook (with map and considerable historical information), by F. B. Archer, treasurer of the colony (London, 1906). Early accounts of the country will be found in vol. ii. of Thomas Astley's *New General Collection of Voyages and Travels* (London, 1745-1747). See also Major W. Gray and Surgeon Doehard, *Travels in Western Africa in 1818-1821, from the River Gambia . . . to the River Niger* (London, 1829). The flora has been the subject of a special study, A. Rançon, *La Flore utile du bassin de la Gambie* (Bordeaux, 1895). Most of the books mentioned under GOLD COAST also deal with the Gambia.

GAMBIER, JAMES GAMBIER, BAKON (1756-1833), English admiral, was born on the 13th of October 1756 at the Bahamas, of which his father, John Gambier, was at that time lieutenant-governor. He entered the navy in 1767 as a midshipman on board the "Yarmouth," under the command of his uncle; and, his family interest obtaining for him rapid promotion, he was raised in 1778 to the rank of post-captain, and appointed to the "Raleigh," a fine 32-gun frigate. At the peace of 1783 he was placed on half-pay; but, on the outbreak of the war of the French Revolution, he was appointed to the command of the 74-gun ship "Defence," under Lord Howe; and in her he had an honourable share in the battle on the 1st of June 1794. In recognition of his services on this occasion, Captain Gambier received the gold medal, and was made a colonel of marines; the following year he was advanced to the rank of rear-admiral, and appointed one of the lords of the admiralty. In this office he continued for six years, till, in February 1801, he, a vice-admiral of 1799, hoisted his flag on board the "Neptune," of 98 guns, as third in command of the Channel Fleet under Admiral Cornwallis, where, however, he remained for but a year, when he was appointed governor of Newfoundland and commander-in-chief of the ships on that station. In May 1804 he returned to the admiralty, and with a short intermission in 1806, continued there during the naval administration of Lord Melville, of his uncle, Lord Barham, and of Lord Mulgrave. In November 1805 he was raised to the rank of admiral; and in the summer of 1807, whilst still a lord of the admiralty, he was appointed to the command of the fleet ordered to the Baltic, which, in concert with the army under Lord Cathcart, reduced Copenhagen, and enforced the surrender of the Danish navy, consisting of nineteen ships of the line, besides frigates, sloops, gunboats, and naval stores. This service was considered by the government as worthy of special acknowledgment; the naval and military commanders, officers, seamen and soldiers received the thanks of both Houses of Parliament, and Admiral Gambier was rewarded with a peerage.

In the spring of the following year he gave up his seat at the admiralty on being appointed to the command of the Channel Fleet; and in that capacity he witnessed the partial, and prevented the total, destruction of the French fleet in Basque Roads, on the 12th of April 1809. It is in connexion with this event, which might have been as memorable in the history of the British navy as it is in the life of Lord Dundonald (see DUNDONALD), that Lord Gambier's name is now best known. A court-martial, assembled by order of a friendly admiralty, and presided over by a warm partisan, "most honourably acquitted" him on the charge "that, on the 12th of April, the enemy's ships being then on fire, and the signal having been made that they could be destroyed, he did, for a considerable time, neglect or delay taking effectual measures for destroying them"; but this decision was in reality nothing more than a party statement of the fact that a commander-in-chief, a supporter of the government, is not to be condemned or broken for not being a person of brilliant genius or dauntless resolution. No one now doubts that the French fleet should have been reduced to ashes, and might have been, had Lord Gambier had the talents, the energy, or the experience of many of his juniors. He continued to hold the command of the Channel Fleet for the full period of three years, at the end of which time—in 1811—he was superseded. In 1814 he acted in a civil capacity as chief commissioner for negotiating a treaty of peace

with the United States; for his exertions in which business he was honoured with the Grand Cross of the Bath. In 1830 he was raised to the high rank of admiral of the fleet, and he died on the 19th of April 1833.

Lord Gambier was a man of earnest, almost morbid, religious principle, and of undoubted courage; but the administration of the admiralty has seldom given rise to such flagrant scandals as during the time when he was a member of it; and through the whole war the self-esteem of the navy suffered no such wound as during Lord Gambier's command in the Bay of Biscay.

The so-called *Memorials, Personal and Historical, of Admiral Lord Gambier*, by Lady Chatterton (1861), has no historical value. The life of Lord Gambier is to be read in Marshall's *Royal Naval Biography*, in Ralle's *Naval Biography*, in Lord Dundonald's *Autobiography of a Seaman*, in the *Minutes of the Courts-Martial* and in the general history of the period.

GAMBIER, a village of College township, Knox county, Ohio, U.S.A., on the Kokosing river, 5 m. E. of Mount Vernon. Pop. (1900) 751; (1910) 537. It is served by the Cleveland, Akron & Columbus railway. The village is finely situated, and is the seat of Kenyon College and its theological seminary, Bexley Hall (Protestant Episcopal), and of Harcourt Place boarding school for girls (1889), also Protestant Episcopal. The college was incorporated in 1824 as the "Theological Seminary of the Protestant Episcopal Church in the Diocese of Ohio"; but in 1893 "Kenyon College," the name by which the institution has always been known, became the official title. Its first exercises were held at Worthington, Ohio, in the home of Philander Chase (1775-1852), first Protestant Episcopal bishop in the North-west Territory, by whose efforts the funds for its endowment had been raised in England in 1823-1824, the chief donors being Lords Kenyon and Gambier. The first permanent building, "Old Kenyon" (still standing, and used as a dormitory), was erected on Gambier Hill in 1827 in the midst of a forest. In 1907-1908 the theological seminary had 18 students and the collegiate department 119.

Some account of the founding of the college may be found in Bishop Chase's *Reminiscences; an Autobiography, comprising a History of the Principal Events in the Author's Life to 1847* (2 vols., New York, 1848).

GAMBOGE (from Camboja, a name of the district whence it is obtained), a gum-resin procured from *Garcinia Hanburii*, a dioecious tree with leathery, laurel-like leaves, small yellow flowers, and usually square-shaped and four-seeded fruit, a member of the natural order Guttiferae, and indigenous to Cambodia and parts of Siam and of the south of Cochin China, formerly comprised in Cambodian territory. The juice, which when hardened constitutes gamboge, is contained in the bark of the tree, chiefly in numerous ducts in its middle layer, and from this it is procured by making incisions, bamboo joints being placed to receive it as it exudes. Gamboge occurs in commerce in cylindrical pieces, known as pipe or roll gamboge, and also, usually of inferior quality, in cakes or amorphous masses. It is of a dirty orange externally; is hard and brittle, breaks with a conchoidal and reddish-yellow, glistening fracture, and affords a brilliant yellow powder; is odourless, and has a taste at first slight, but subsequently acrid; forms with water an emulsion; and consists of from 20 to 25% of gum soluble in water, and from 70 to 75% of a resin. Its commonest adulterants are rice-flour and pulverized bark.

Gamboge (*Cambogia*) is a drastic hydragogue cathartic, causing much griping and irritation of the intestine. A small quantity is absorbed, adding a yellow ingredient to the urine and acting as a mild diuretic. Its irritant action on the skin may cause the formation of pustules. It is less active only than croton oil and elaterium, and may be given in doses of half to two grains, combined with some sedative such as hyocyamus, in apoplexy and in extreme cases of dropsy. Gamboge is used as a pigment, and as a colouring matter for varnishes. It appears to have been first brought into Europe by merchants from the East at the close of the 16th century.

GAMBRINUS, a mythical Flemish king who is credited with the first brewing of beer. His name is usually derived from that of Jan Primus, i.e. Jan (John) I., the victorious duke of Brabant, from 1261 to 1294, who was president of the Brussels guild of

brewers; his portrait with a foaming glass of ale in his hand had the place of honour in the guild-hall, and this led in time, it is suggested, to the myth of the beer-king who is usually represented outside a barrel with a tankard in his hand.

GAME, a word which in its primary and widest significance means any amusement or sport, often combined in the early examples with "glee," "play," "joy" or "solace." It is a common Teutonic word, in O. Eng. *gamen*, in O.H.G. *gamon*, but only appears in modern usage outside English in Dan. *gammen* and Swed. *gamman*. The ulterior derivation is obscure, but philologists have identified it with the Goth. *gaman*, companion or companionship; if this be so, it is compounded of the prefix *ga-*, with, and the root seen in "man." Apart from its primary and general meaning the word has two specific applications, first to a contest played as a recreation or as an exhibition of skill, in accordance with rules and regulations; and, secondly, to those wild animals which are the objects of the chase, and their flesh as used for food, distinguished as such from meat, fish and poultry, and from the flesh of deer, to which the name "venison" is given. For "game," from the legal aspect, and the laws relating to its pursuit and capture see **GAME LAWS**. The athletic contests of the ancient Greeks (*ἀγῶνες*) and the public shows (*ludi*) of the arena and amphitheatre of the ancient Romans are treated below (**GAMES, CLASSICAL**); the various forms of modern games, indoor and outdoor, whether of skill, strength or chance, are dealt with under their specific titles. A special use ("gaming" or "gambling") restricts the term to the playing of games for money, or to betting and wagering on the results of events, as in horse-racing, &c. (see **GAMING AND WAGERING**). "Gamble," "gambler" and "gambling" appear very late in English. The earliest quotations in the *New English Dictionary* for the three words are dated 1775, 1747 and 1784 respectively. They were first regarded as cant or slang words, and implied a reproach, either as referring to cheats or sharpers, or to those who played recklessly for extravagant stakes. The form of the words is obscure, but is supposed to represent a local variation *gammle* of the M.E. *gamenian*. From this word must, of course, be distinguished "gambol," to sport, frisk, which, as the older forms (*gambald*, *gambaud*) show, is from the Fr. *gambade*, leap, jump, of a horse, It. *gambado*, *gamba*, leg (Mod. Fr. *jambe*).

GAME LAWS. This title in English law is applied to the statutes which regulate the right to pursue and take or kill certain kinds of wild animals (see above). The existence of these statutes is due to the rules of the common law as to the nature of property, and the interest of the Norman sovereigns and of feudal superiors in the pleasures of sport or the chase. The substantial basis of the law of property is physical possession of things and the power to deal with them as we see fit. By the common law wild animals are regarded as *res nullius*, and as not being the subject of private property until reduced into possession by being killed or captured. A bird in the hand is owned: a bird in the bush is not. Even bees do not become property until hived. "Though a swarm lights in my tree," says Bracton, "I have no more property therein than I have in the birds which make their nests thereon." If reclaimed or confined they become property. If they escape, the rights of the owner continue only while he is in pursuit of the fugitive, i.e. no other person can in the meantime establish a right of property against him by capturing the animal. A swarm of bees "which fly out of my hive are mine so long as I can keep them in sight and have power to pursue them." But the right of recapture does not entitle the owner to follow his animals on to the lands of another, and the only case in which any right to follow wild animals on to the lands of others is now expressly recognized is when deer or hares are hunted with hounds or greyhounds. This recognition merely excepts such pursuit from the law as to criminal game trespass, and fox-hunters and those who course hares or hunt stags are civilly liable for trespass if they pass over land without the consent of the occupier (*Paul v. Summerhayes*, 1878, 4 Q.B.D. 9).

It is a maxim of the common law that things in which no one can claim any property belong to the crown by its prerogative: this rule has been applied to wild animals, and in particular to

deer and what is now called "game." The crown rights may pass to a subject by grant or equivalent prescription. In the course of time the exclusive right to take game, &c., on lands came to be regarded as incidental to the ownership or occupation of the lands. This is described as the right to game *ratione soli*. In certain districts of England which are crown forests or chases or legal parks, or subject to rights of free warren, the right to take deer and game is not in the owner or occupier of the soil, but is in the crown by prerogative, or *ratione privilegii* in the grantee of the rights of chase, park or free warren, which are anterior to and superior to those of the owner or occupier of the lands over which the privilege has been granted. In all cases where these special rights do not exist, the right to take or kill wild animals is treated as a profit incidental to the ownership or occupation of the land on which they are found, and there is no public right to take them on private land or even on a highway; nor is there any method known to the law by which the public at large or an undefined body of persons can lawfully acquire the right to take wild animals in *alieno solo*.

In the nature of things the right to take wild animals is valuable as to deer and the animals usually described as game, and not as to those which are merely noxious as vermin, or simply valueless, as small birds. Upon the rules of the common law there has been grafted much legislation which up till the end of the 18th century was framed for the preservation of deer and game for the recreation and amusement of persons of fortune, and to prevent persons of inferior rank from squandering in the pursuit of game time which their station in life required to be more profitably employed. These enactments included the rigorous code known as the Laws of the Forest (see **FOREST LAWS**), as well as what are usually called the Game Laws.

In England the older statutes relating to game were all repealed early in the 19th century. From the time of Richard II. (1389) to 1831, no person might kill game unless qualified by estate or social standing, a qualification raised from a 40s. freehold in 1389 to an interest of £100 a year in freehold or £150 in long leaseholds (1673). In 1831 this qualification by estate was abolished as to England. But in Scotland the right to hunt is theoretically reserved to persons who have in heritage that unknown quantity a "plough-gate of land" (Scots Act 1621, c. 31); and in Ireland qualifications by estate are made necessary for killing game and keeping sporting dogs (Irish Act 1698, 8 Will. III. c. 8). In England the game laws proper consist of the Night Poaching Acts of 1828 and 1844, the Game Act of 1831, the Poaching Prevention Act 1862, and the Ground Game Acts of 1880 and 1906. From the fact that the right of landowners over wild animals on their land does not amount to ownership it follows that they cannot prosecute any one for stealing live wild animals: and that apart from the game laws the only remedy against poachers is by civil action for trespass. As between trespasser and landowner the law is peculiar (*Blades v. Higgs*, 1865, 11 H.L.C. 621). If A starts and kills a hare on B's land the dead hare belongs to B (*ratione soli*) and not to A, though he has taken the hare by his own efforts (*per industriam*). But if A hunts the hare from B's land on to C's land and there kills it, the dead hare belongs to A and not to B or C. It is not B's because it was not taken on his land, and it is not C's because it was not started on his land. In other words the right of each owner is limited to animals both started and killed on his own land, and in the case of conflicting claims to the animal taken (made *ratione soli*) the captor can make title (*per industriam*) against both landowners. If he is a trespasser he is liable to civil or criminal proceedings by both landowners, but the game is his unless forfeited under a statute. Another peculiar result of the law is that where trespassers (e.g. poachers) kill and carry off game or rabbits as part of one continuous transaction they are not guilty of theft, but only of game trespass (*R. v. Townley*, 1871, L.R. 1 C.C.R. 315), but it is theft for a trespasser to pick up and carry off a pheasant killed by the owner of the land on his own land or even a pheasant killed by an independent gang of poachers. The young of wild animals belong (*propter impotentiam*) to the owner of the land until they are able to fly or run away. This right does not extend to the

eggs of wild birds. But the owner can reduce the eggs into possession by taking them up and setting them under hens or in enclosures. And if this is done persons who take them are thieves and not merely poachers. A game farm, like a decoy for wild water-fowl, is treated as a trade or business; but a game preserve in which full-grown animals fly or run wild is subject to the ordinary incidents of the law as to animals *ferae naturae*.

The classification of wild animals for purposes of sport in England is as follows:—

1. Beasts of forest are hart and hind (red deer), boar, wolf and all beasts of venery.
2. Beasts of chase and park are buck and doe (fallow deer), fox, marten and roe, or all beasts of venery and hunting.
3. Beasts of (free) warren are roe, hare, rabbit, partridge, pheasant, woodcock, quail, rail and heron.
4. Game, as defined by the Night Poaching Act of 1828 and the Game Act of 1831, is pheasant, partridge, black game, red grouse, bustard and hare. In France game (*gibier*) includes everything eatable that runs or flies.
5. Wild fowl not in any of the previous lists which are nevertheless prized for sport, e.g. duck, snipe, plovers, &c.
6. Wild birds not falling within class 4 are more or less protected against destruction by the Wild Birds Protection Acts, which were, however, passed with quite other objects than the game laws.

As regards class 1 no subject without special authority of the crown may kill within a forest or its purlieus or on adjacent highways, rivers or enclosures. The right to the animals in a forest does not depend on ownership of the land but on the royal prerogative as to the animals, i.e. it exists *not ratione soli* but *ratione privilegii*; and this right is not in any way altered by the Game Act 1831.

A chase is a forest in the hands of a subject and a legal park (which is an enclosed chase) is created by crown grant or by prescription founded on a lost grant. The rights of the grantee are in substance the same as those of the crown in a forest, and do not depend on ownership of the soil. In the case of a free warren the grantee usually but not necessarily owns some or all of the soil over which the right of warren runs. The right of free warren depends on crown grant or prescription founded on lost grant, and involves a right of property over beasts and fowl of warren on all lands within the franchise. As will appear from the list above, some game birds are not fowl of warren, e.g. black game and red grouse (*Duke of Devonshire v. Lodge*, 1827, 7 B. & C. 39). Free warren is quite different from ordinary warrens, in which hares or rabbits are bred by the owner of the soil for sport or profit. Ground game in such warrens is protected under the Larceny Act 1861, s. 17, as well as by the game laws. In manors, of which none have been created since 1290, the lord by his franchise had the sporting rights over the manor, but at the present time this right is restricted to the commons and wastes of the manor, the freehold whereof is in him, and does not extend to enclosed freeholds nor as a general rule to enclosed copyholds, unless at the time of enclosure the sporting rights were reserved to him by the Enclosure Act or award (*Somerby v. Smith*, 1873, L.R. 8 C.P. 514). In other words his rights exist *ratione soli* and not *ratione privilegii*. The Game Act 1831 gives lords of manors and privileged persons certain rights as to appointing gamekeepers with special powers to protect game within the district over which their rights extend (ss. 13, 14, 15, 16). The game laws in no way cut down the special privileges as to forest, park, chase or free warren (1831, s. 9), and confirm the sporting right of lords of manors on the wastes of the manor (1831, s. 10). As to all lands not affected by these rights, the right to kill or take game on the land is presumably in the occupier. On letting land the owner may, subject to the qualifications hereinafter stated, reserve to himself the right to kill or take "game" or rabbits or other wild animals concurrently with or in exclusion of the tenant. Where the exclusive right is in the landlord the tenant is not only liable to forfeiture or damages for breaches of covenants in the lease, but is also liable to penalties on summary conviction if without the lessor's authority he pursues, kills or takes any "game" upon the land or gives permission to others to do so (1831, s. 12). In effect he is made criminally liable for game trespass on lands in his own occupation, so far as relates to game, but is not so liable if he takes rabbits, snipe, woodcock, quails or rails.

The net effect of the common law and the game laws is to give the occupier of lands and the owner of sporting rights over them the following remedies against persons who infringe their right to kill or take wild animals on the land. A stranger who enters on the land of another to take any wild animals is liable to the occupier for trespass on the land and for the animals started and killed on the land by the trespasser. He is also criminally liable for game trespass if he has entered on the land to search for or in pursuit of "game" or woodcock, snipe, quail, landrills or rabbits. If the trespass is in the daytime (whether on lands of the subject or in royal forests, &c.), the penalty on conviction may not

exceed 40s., unless five or more persons go together, in which case the maximum penalty is £5. If a single offender refuses his name or address or gives a false address to the occupier or to the owner of the sporting rights or his representatives, or refuses to leave the land, he may be arrested by them, and is liable to a penalty not exceeding £5, and if five or more concerned together in game trespass have a gun with them and use violence, intimidation or menace, to prevent the approach of persons entitled to take their names or order them off the land, they incur a further penalty up to £5.

If the trespass is in search or pursuit of game or rabbits in the night-time, the maximum penalty on a first conviction is imprisonment with hard labour for not over three months; on a second, imprisonment, &c., for not over six months, and the offender may be put under sureties not to offend again for a year after a first conviction or for two years after a second conviction. For a first or second offence the conviction is summary, subject to appeal to quarter sessions, but for a third offence the offender is tried on indictment and is liable to penal servitude (3-7 years) or imprisonment with hard labour (2 years). The offenders may be arrested by the owner or occupier of the land or their servants, and if the offenders assault or offer violence by firearms or offensive weapons they are liable to be indicted and on conviction punished to the same extent as in the last offence. In 1844 the above penalties were extended to persons found by night on highways in search or pursuit of game. If three or more trespass together on land by night to take or destroy game or rabbits, and any of them is armed with firearms, bludgeon or other offensive weapon, they are liable to be indicted and on conviction sentenced to penal servitude (3-14 years) or imprisonment with hard labour (2 years). By "day" time is meant from the beginning of the first hour before sunrise to the end of the first hour after sunset, and by "night" from the end of the first hour after sunset to the beginning of the first hour before sunrise (act of 1828, s. 12; act of 1831, s. 34). The time is reckoned by local and not by Greenwich time.

The penalties for night poaching are severe, but encounters between the owners of sporting rights and armed gangs of poachers have often been attended by homicide. It is to be observed that it is illegal and severely punishable to set traps or loaded spring guns for poachers (Offences against the Person Act 1861, s. 31), whereby any grievous bodily harm is intended or may be caused even to a trespasser, so that the incursions of poachers can be prevented only by personal attendance on the scene of their activities; and it is to be observed also that the provisions of the Game Laws above stated are, so far as concerns private land, left to be enforced by private enterprise without the interference of the police, with the result that in some districts there are scenes of private nocturnal war. Even in the Night Poaching Act 1844, which applies to highways, the arrest of offenders is made by owners, occupiers or their gamekeepers. The police were not given any direct authority as to poachers until the Poaching Prevention Act 1862, under which a constable is empowered "on any highway, street or public place, to search any person whom he may have good cause to suspect of coming from any land where he shall have been unlawfully in search or pursuit of 'game,' or any persons aiding or abetting such person, and having in his possession any game unlawfully obtained, or any gun, part of gun, or nets or engines used for the killing or taking game; and also to stop and search any cart or other conveyance in or upon which such constable or peace officer shall have good cause to suspect that any such game, or any such article or thing, is being carried by such person." If any such thing be found the constable is to detain it, and apply for a summons against the offender, summoning him to appear before a petty sessional court, on conviction before which he may be fined not more than £5, and forfeits the game, guns, &c., found in his possession. In this act "game" includes woodcock, snipe and rabbits, and the eggs of game birds other than bustards; and the act applies to poaching either by night or by day. In all cases of summary conviction for poaching an appeal lies to quarter sessions. In all cases of poaching the game, &c., taken may be forfeited by the court which tries the poacher.

Close Time.—On certain days and within periods known as "close time," it is illegal to kill deer or game. The present close times are as follows:—

	England.	Ireland.	Scotland.
Hare	None	April 21 to Aug. 11 ¹	None
Red deer (male)	None	Jan. 1 to June 9	None
Fallow deer	None	Sept. 29 to June 10	None
Roe deer	None	None	None
Pheasant	Feb. 1 to Sept. 30	Feb. 1 to Sept. 30 (1845)	Feb. 1 to Sept. 30
Partridge	Feb. 1 to Aug. 31	Feb. 1 to Aug. 31 (1890)	Feb. 1 to Aug. 31
Black game	Dec. 10 to Aug. 20 ²	Dec. 10 to Aug. 20	Dec. 10 to Aug. 20
Red grouse	Dec. 10 to Aug. 12	Dec. 10 to Aug. 12	Dec. 10 to Aug. 12
Ptarmigan	None	Dec. 10 to Aug. 20	Dec. 10 to Aug. 12
Bustard (wild turkey).	March 1 to Sept. 1	Jan. 10 to Sept. 1	None

¹ Unless varied by order of lord-lieutenant.

² Except in Devon, Somerset and New Forest, where to Sept. 1.

In England and Ireland the winged game above named and hares may not be killed on Sundays or Christmas Day. It is illegal to sell or expose for sale hares or leverets in March, April, May, June and July. It is illegal throughout the United Kingdom to buy or sell winged game birds after ten days from the beginning of the close season as fixed by the English law (1831, s. 4; 1860, s. 13). This prohibition applies to the sale of live game, British or foreign, and to the sale of British dead game. It is illegal to lay poison for game or rabbits except in rabbit holes, and it is illegal to kill game by firearms at night. Wild birds not within the list above given but of interest for sport are protected by close times fixed under the Wild Birds Protection Acts, which may vary in each county of each kingdom.

Licences.—Besides the restrictions on the right to take or kill game which arise out of the law as to ownership or occupation of the lands on which it is found, there are further restrictions imposed by the laws of excise. From the time of Richard II. (1389) until 1831 the right of persons other than gamekeepers properly deputed by the lord of a manor to take game was made to depend on the social rank of the person, or on the amount of his interest in land, which ranged from a 40s. freehold (in 1389) to £100 a year (1671). These restrictions were abolished in 1831, and the right to kill game was made conditional on the possession of a game certificate, now called a game licence in Great Britain (act of 1831, ss. 6, 23). By s. 4 of the Game Licences Act 1860 "any person, before he shall in Great Britain take, kill or pursue, or aid or assist in any manner in the taking, killing or pursuing, by any means whatever, or use any dog, gun, net or other engine for the purpose of taking, killing or pursuing any game, or any woodcock, snipe, quail, landrail, or any coney, or any deer, shall take out a proper licence to kill game under this act" subject to a penalty of £20. There are certain exceptions and exemptions as to royal personages, royal gamekeepers, and with reference to taking woodcock or snipe by nets or springes, by coursing or hunting hares or deer, or killing deer, rabbits or hares (Hares Acts 1848. Game Licences Act 1860) in certain enclosed lands by the owners or occupiers. A licence is not required for beaters and assistants who go out with holders of a game licence. The licence is granted by the Inland Revenue Department. The issue is regulated by the Game Licences Act 1860 as amended by the Customs and Inland Revenue Act 1883. The licences now in use are of four kinds:—

Those taken out after 31st July—	
To expire on the next 31st July	£ 0 0
To expire on the next 31st October	2 0 0
Those taken out after 31st November—	
To expire on the next 31st July	2 0 0
Those taken out for any continuous period of four- teen days specified in the licence	1 0 0

In the case of gamekeepers in Great Britain for whom the employer pays the duty on male servants, the annual licence fee is £2, but the licence extends only to lands on which the employer has a right to kill game. A licence granted to a person in his own right and not as gamekeeper or servant is effective throughout the United Kingdom. The game licence does not authorize trespass on the lands of others in search of game nor the shooting of game, &c., at night, and is forfeited on a conviction of game trespass (1831, s. 30; 1860, s. 11). Persons who have game licences need not have a gun licence, but the possession of a gun licence does not qualify the holder to kill game or even rabbits.

The sale of game when killed is also subject to statutory regulation. Gamekeepers may not sell game except under the authority of their employer (1831, ss. 17, 25). Persons who hold a full game licence may sell game, but only to persons who hold a licence to deal in game. These licences are annual (expiring on the 1st of July), and are granted in London by justices of the peace, and in the rest of England by the council of the borough or urban or rural district in which the dealer seeks to carry on business (1831, s. 18; 1893, c. 73, s. 27), and a notice of the existence of the licence must be posted on the licensed premises. A licence must be taken out for each shop. The following persons are disqualified for holding the licence: innkeepers, persons holding licences to sell intoxicants, owners, guards or drivers of mail-carts, stagecoaches or public conveyances, carriers and higglers (1831, s. 18). This enactment interferes with the grant of game licences to large stores which also have licences to sell beer. The licensed dealer may buy British game only from persons who are lawfully entitled to sell game. Conviction of an offence under the Game Act 1831 avoids the licence (s. 22). The local licence must also be supplemented by an excise licence for which a fee of £2 is charged. Licensed dealers in game are prohibited from selling game killed in the United Kingdom from the tenth day after the beginning of close time to the end of that period. The provisions above stated under the act of 1831 applied only to England, but were in 1860 extended to the rest of the United Kingdom, and were in 1893 applied to dealers in game imported from abroad. The main effect of the system of licences is to prevent the disposal of game by poachers rather than to benefit the revenue.

Deer.—Deer are not included within the definition of game in any of the English game laws. Deer-stealing was very seriously punished by the old law, and under an act of 9 George I. c. 22,

known as the Waltham Black Act, passed because of the depredations of disguised deer-stealers in Epping Forest, it was under certain circumstances made a capital offence. At present offences with reference to deer are included in the Larceny Act 1861. It is a felony to hunt or kill deer in enclosures in forests, chases or parkies, or in enclosed land where deer is usually kept, or after a previous conviction to hunt or kill deer in the open parts of a forest, &c., and certain minor provisions are made as to arrest by foresters, forfeiture of venison unlawfully possessed and for unlawfully setting traps for deer. These enactments do not prevent a man from killing on his own land deer which have strayed there (*Threlkeld v. Smith*, 1901, 2 K.B. 531). In Scotland the unlawful killing of deer is punished as theft.

Eggs.—The owner or occupier of land has no property in the eggs of wild birds found on his lands unless he takes them up. But under s. 24 of the Game Act 1831 a penalty of 5s. per egg is incurred by persons who unlawfully (i.e. without being, or having licence from, the person entitled to kill the game) and wilfully take from the nest or destroy in the nest the eggs of any game bird, or of a swan, wild duck, teal or widgeon. Similar provisions exist in Ireland under an act of 1698, and by the Poaching Prevention Act 1862 (United Kingdom) power is given to constables to search persons suspected of poaching and to take from them the eggs of pheasants, partridges, grouse or black game. And the Wild Birds Protection Acts deal with the eggs of all wild birds except game and swans.

Damage to Crops by Game.—Where an occupier of lands has not the right to kill game or rabbits he runs the risk of suffering damage by the depredations of the protected animals, which he may not kill without incurring a liability to summary conviction or for breach of the conditions on which he holds the land. At common law the owner of land who has reserved to himself the sporting rights, and his sporting tenants, must use the reserved rights reasonably. They are liable for any damage wilfully or unnecessarily done to the crops, &c., of the occupier, such as trampling down standing crops or breaking hedges or fences. They are not directly liable to the occupier for damage done to the crops by game bred on the land or frequenting it in the ordinary course of nature; but are not entitled to turn down game or rabbits on the land. And if game or rabbits are for the purposes of sport imported or artificially raised on land, the person who breeds or brings them there is liable for the damage done to the crops of adjoining owners or occupiers (*Farrer v. Nelson*, 1885, 15 Q.B.D. 258; *Birkbeck v. Paget*, 31 Beav. 403; *Hilton v. Green*, 1862, 2 F. & F. 821).

Recent legislation has greatly increased the rights of the occupiers of land as against the owners of sporting rights over it. As regards hares and rabbits the occupier's rights are regulated by the Ground Game Act 1880 (which is expressed to be made "in the interests of good husbandry and for the better security of capital and labour invested in the cultivation of the soil"). By that act the occupier of land as incident to and inseparable from his occupation has the right to kill and take hares and rabbits on the land. The right is indefeasible and cannot be divested by contract with the owner or landlord or even by letting the occupier's sporting rights to another. But where apart from the act the right to kill game on the land is vested in a person other than the occupier, such person has a right concurrent with the statutory right of the occupier to take hares and rabbits on the land. The act does not extend to common lands nor to lands over which rights of grazing or pasturage for not more than nine months in the year exist. Consequently over such lands exclusive rights of killing ground game still continue, and the law appears not to apply in cases where a special right of killing or taking ground game vested before the 7th of September 1880 in any person (other than the landlord) by statute, charter or franchise (s. 5). The mode of exercise of the occupier's right is subject to certain limitations. The ground game is only to be taken by him or by persons whom he has duly authorized in writing, who must be members of his family or his servants or bona fide employed by him for reward to take ground game. The written authority must be produced on demand to persons having concurrent rights to take and kill the ground game (s. 1 (1) (c)). Firearms may not be used by night, nor may poison be used, nor may spring traps be set except in rabbit holes (s. 6); nor may ground game be killed on days or seasons or by methods prohibited by statute in 1880 (s. 10).

In the case of moorland and unenclosed lands (which are not arable and do not consist of small detached portions of less than 25 acres) the occupier may between the 1st of September and the 31st of March kill and take ground game; but between the 1st of September and the 10th of December firearms may not be used (1880, s. 1 (3); 1906, s. 2). In the case of such lands the occupier and the owners of the sporting rights may between the 1st of September and the 10th of December make and enforce for their joint benefit agreements for taking the ground game. The Agricultural Holdings Act 1906 (operating from 1909) deals, *inter alia*, with damage to crops by deer and winged game, but does not apply to damage by hares or rabbits. The tenant of agricultural land is entitled to compensation for damage to his crops exceeding 1s. per acre over the area affected if caused by game, "the right to kill or take which is vested neither in him nor in any one claiming under him other than the landlord and which the tenant has not permission in writing to kill" (s. 2). The right of the tenant is indefeasible and cannot be

contracted away. Disputes as to amount are to be settled by arbitration; but claims to be effectual must be made as to growing crops before reaping, raising or feeding off, and as to cut crops before carrying. In the case of contracts of tenancy created before the 1st of January 1909, allowances are to be made if by their terms compensation for damage by game is stipulated for, or an allowance of an agreed amount for damage by game was expressly made in fixing the rent. The compensation is payable by the landlord subject to his right to be indemnified in cases where the sporting rights are not vested in him.

Sporting Rights.—Sporting rights (*i.e.* rights of fowling or of shooting, or of taking or killing game or rabbits, or of fishing), when severed from the occupation of land, are subject to income or property tax, and to assessment for the purpose of local rates (Rating Act 1874); and in valuing land whether for rates or taxes the value of the sporting rights is now an important and often the chief item of value in beneficial occupation of the land. Where the sporting rights are the landlord's, the rate thereon is paid in the first instance by the tenant and deducted from his rent. Where the sporting right is reserved and let, the rating authority may rate either the landlord or the sporting tenant as occupier of the right. The Ground Game Acts have not affected the liability to assessment of concurrent rights of killing hares and rabbits reserved by a landlord, or of a concurrent right granted by the occupier (Ryde (2nd ed.), 385-387). The ownership of sporting rights severed from the ownership or occupation of the land over which they are exercisable is not an interest in land giving the electoral franchise or a claim for compensation if the land is taken under the Lands Clauses Consolidation Acts.

Scotland.—By the law of Scotland all men have right and privilege of game on their own estates as a real right incident thereto, which does not pass by an agricultural lease except by express words, or in the case of ground game by the act of 1886. The landlord is liable to the tenant for damage done to the surface of the lands in exercise of his right to the game and also for extraordinary damage by over-preserving or over-stocking. Under an act of 1877 he was liable for excessive damage done by rabbits or game reserved to or retained under a lease granted after the 1st of January 1878, or reserved by presumption of common law; this act from 1909 onwards is superseded by the provisions of the Agricultural Holdings Act 1906. Night poaching is punished by the same act as in England, and day poaching by an act of 1832 and the act of 1882. Until 1887 poaching by night under arms was a capital offence. The definition of game in Scotland for purposes of night poaching is the same as in England. The provisions of the act of 1832 as to game trespass by day apply also to deer, roe, rabbits, woodcock, snipe, rails and wild duck; but in other respects closely resemble those of the English act of 1831.

Offences against the game laws are not triable by justices of the peace, but only in the sheriff court. The close time for game birds in Scotland is the same as in England, so far as dealing in them is concerned, but differs slightly as to killing. Black game may not be killed between the 10th of December and the 25th of August, nor partridge between the 10th of December and the 20th of August. There is no close time for red, fallow or roe deer, or rabbits. By an old Scots act of 1621 (omitted from the recent wholesale repeal of such acts) no one may lawfully kill game in Scotland who does not own a plough-gate of land except on the land of a person so qualified. **Ireland.**—The common law as to game is the same for Ireland as for England. The game laws of Ireland are contained partly in acts passed prior to the union (1698, 1707, 1787 and 1797), partly in acts limited to Ireland, and as to the rest in acts common to the whole United Kingdom.

Under the act of 1698 no one may kill game in Ireland who has not a freehold worth £50 a year or £1000 net personalty, and elaborate provisions are made by that and later acts against the keeping of sporting dogs by persons not qualified by estate to kill game. British officers and soldiers in Ireland appear to have been much addicted to poaching, and their activities were restrained by enactments of 1698 and 1707.

Night poaching in Ireland is dealt with by an act of 1826. Trespass on lands in pursuit of game to which the landlord or lessor has by reservation exclusive right is summarily punishable under an act of 1864, which includes in the definition of game, woodcock, snipe, quails, landrails, wild duck, widgeon and teal. Under the Land Act 1881 the landlord of a statutory holding may at the commencement of the term subject to the Ground Game Acts retain and exercise the exclusive right of taking "game" as above defined.

A game licence is not required for taking or killing rabbits. But in other respects the law as to game licences, dog licences and licences to deal in game is the same as in Great Britain.

British Possessions Abroad.—The English game laws have not been carried to any colony as part of the personal law of the colonists, nor have they been extended to them by imperial or colonial legislation. But the legislatures of many colonies have passed acts to preserve or protect native or imported wild animals, and in some of these statutes the protected animals are described as game. These statutes are free from feudal prepossessions as to sporting rights, and are framed rather on the lines of the Wild Birds Protection Acts than on the English game laws, but in some possessions, *e.g.* Quebec, sporting leases by the crown are recognised. The acts since 1895

are indicated in the annual summary of colonial legislation furnished in the *Journal of the Society of Comparative Legislation*.

See also Oke's *Game Laws*, 4th ed., by Willis Bund (1897); Warry, *Game Laws of England* (1897); Marchant and Watkins, *Wild Birds Protection Act* (1897). (W. F. C.)

GAMES, CLASSICAL. 1. *Public Games.*—The public games of Greece (*ἀγῶνες*) and Rome (*Ludi*) consisted in athletic contests and spectacles of various kinds, generally connected with and forming part of a religious observance. Probably no institution exercised a greater influence in moulding the national character, and producing that unique type of physical and intellectual beauty which we see reflected in Greek art and literature, than the public contests of Greece (see *ATHLETE*; *ATHLETIC SPORTS*). For them each youth was trained in the gymnasium, they were the central mart whither poet, artist and merchant each brought his wares, and the common ground of union for every member of the Hellenic race. It is to Greece, then, that we must look for the earliest form and the fullest development of ancient games. The shows of the Roman circus and amphitheatre were a best shadow, and in the later days of the empire a travesty, of the Olympia and Pythia, and require only a cursory notice.

The earliest games of which we have any record are those at the funeral of Patroclus, which form the subject of the twenty-third Iliad. They are noteworthy as showing that Greek games were in their origin clearly connected with religion; either, as here, a part of the funeral rites, or else instituted in honour of a god, or as a thank-offering for a victory gained or a calamity averted, or in expiation of some crime. Each of the great contests was held near some shrine or sacred place and is associated with some deity or mythical hero. It was not before the 4th century that this honour was paid to a living man (see Plutarch, *Lysander*, 18). The games of the *Iliad* and those of the *Odyssey* at the court of Alcinoüs are also of interest as showing at what an early date the distinctive forms of Greek athletics—boxing, wrestling, putting the weight, the foot and the chariot race—were determined.

The *Olympian* games were the earliest, and to the last they remained the most celebrated of the four national festivals. Olympia was a naturally enclosed spot in the rich plain of Elis, bounded on the N. by the rocky heights of Cronion, and on the S. and W. by the Alpheus and its tributary the Cladeus. There was the grove of Altis, in which were ranged the statues of the victorious athletes, and the temple of Olympian Zeus with the chryselephantine statue of the god, the masterpiece of Pheidias. There Heracles (so ran the legend which Pindar has introduced in one of his finest odes), when he had conquered Elis and slain its king Augeas, consecrated a temenos and instituted games in honour of his victory. A later legend, which probably embodies historical fact, tells how, when Greece was torn by dissensions and ravaged by pestilence, Iphitus inquired of the oracle for help, and was bidden restore the games which had fallen into desuetude; and there was in the time of Pausanias, suspended in the temple of Hera at Olympia, a bronze disk whereon were inscribed, with the regulations of the games, the names of Iphitus and Lycurgus. From this we may safely infer that the games were a primitive observance of the Eleians and Pisans, and first acquired their celebrity from the powerful concurrence of Sparta. The sacred armistice, or cessation of all hostilities, during the month in which the games were held, is also credited to Iphitus.

In 776 B.C. the Eleians engraved the name of their countryman Corœbus as victor in the foot race, and thenceforward we have an almost unbroken list of the victors in each succeeding Olympiad or fourth recurrent year. For the next fifty years no names occur but those of Eleians or their next neighbours. After 720 B.C. we find Corinthians and Megareans, and later still Athenians and extra-Peloponnesians. Thus what at first was nothing more than a village feast became a bond of union for all the branches of the Doric race, and grew in time to be the high festival to which every Greek gathered, from the mountain fastnesses of Thessaly to the remotest colonies of Cyrene and Marseilles. It survived even the extinction of Greek liberty, and had nearly completed twelve centuries when it was abolished by the decree of the

Christian emperor Theodosius, in the tenth year of his reign. The last Olympian victor was a Romanized Armenian named Varastad.

Let us attempt to call up the scene which Olympia in its palmy days must have presented as the great festival approached. Heralds had proclaimed throughout Greece the "truce of God." So religiously was this observed that the Spartans chose to risk the liberties of Greece, when the Persians were at the gates of Pylae, rather than march during the holy days. Those white tents which stand out against the sombre grey of the olive groves belong to the Hellanodicae, or ten judges of the games, chosen one for each tribe of the Eleians. They have been here already ten months, receiving instruction in their duties. All, too, or most of the athletes must have arrived, for they have been undergoing the indispensable training in the gymnasium of the Alitis. But along the "holy road" from the town of Elis there are crowding a motley throng. Conspicuous in the long train of pleasure-seekers are the *θεωποί* or sacred deputies, clad in their robes of office, and bearing with them in their carriages of state offerings to the shrine of the god. Nor is there any lack of distinguished visitors. It may be Alcibiades, who, they say, has entered no less than seven chariots; or Gorgias, who has written a famous *ἐπίδειξις* for the occasion; or the sophist Hippias, who boasts that all he bears about him, from the sandals on his feet to the dithyrambs he carries in his hand, are his own manufacture; or Aetion, who will exhibit his picture of the Marriage of Alexander and Roxana—the picture which gained him no less a prize than the daughter of the Hellanodices Praxionides; or, in an earlier age, the poet-laureate of the Olympians, Pindar himself. One feature of the medieval tournament and the modern recoursee is wanting. Women might indeed compete and win prizes as the owners of teams, but all except the priestesses of Demeter were forbidden, matrons on pain of death, to enter the enclosure.

At daybreak the athletes presented themselves in the Bouleuterium, where the presidents were sitting, and proved by witnesses that they were of pure Hellenic descent, and had no stain, religious or civil, on their character. Laying their hands on the bleeding victim, they swore that they had duly qualified themselves by ten months' continuous training in the gymnasium, and that they would use no fraud or guile in the sacred contests. Thence they proceeded to the stadium, where they stripped to the skin and anointed themselves. A herald proclaimed, "Let the runners put their feet to the line," and called on the spectators to challenge any disqualified by blood or character. If no objection was made, they were started by the note of the trumpet, running in heats of four, ranged in the places assigned them by lot. The presidents seated near the goal adjudged the victory. The foot-race was only one of twenty-four Olympian contests which Pausanias enumerates, though we must not suppose that these were all exhibited at any one festival. Till the 77th Olympiad all was concluded in one day, but afterwards the feast was extended to five.

The order of the games is for the most part a matter of conjecture, but, roughly speaking, the historical order of their institution was followed. We will now describe in this order the most important.

(1) The *Foot-race*.—For the first 13 Olympiads the *δρομος*, or single lap of the stadium, which was 200 yds. long, was the only contest. The *διελυξ*, in which the course was traversed twice, was added in the 14th Olympiad, and in the 15th the *βόλυκος*, or long race, of 7, 12 or, according to the highest computation, 24 laps, about 2½ m. in length. We are told that the Spartan Ladas, after winning this race, dropped dead at the goal. There was also, for a short time, a race in heavy armour, which Plato highly commends as a preparation for active service. (2) *Wrestling* was introduced in the 18th Olympiad. The importance attached to this exercise is shown by the very word *palaestra*, and Plutarch calls it the most artistic and cunning of athletic games. The practice differed little from that of modern times, save that the wrestler's limbs were anointed with oil and sprinkled with sand. The third throw, which decided the victory, passed into a proverb, and struggling on the ground, such as we see in the famous statue at Florence, was not allowed, at least at the Olympia. (3) In the same year was introduced the *πεντάθλος* (pentathlon), a combination of the five games enumerated in the well-known pentameter ascribed to Simonides:—

ἄλσιν, βόλυκος, ἄρσεν, ἔκστρα, πύλιν.

Only the first of these calls for any comment. The only leap practised seems to have been the long jump. The leapers increased their momentum by means of *ἀλτήρες* or dumb-bells, which they swung in the act of leaping and dropped as they "took off." The take-off may have been slightly raised, and some commentators with very little warrant have stated that spring-boards were used. The record jump with which Phayllus of Croton is credited, 55 ft., is incredible with or without a spring-board. It is disputed whether a victory in all five contests, or in three at least, was required to win the *πεντάθλος*. (4) The rules for boxing were not unlike those of the modern ring (see PUGILISM), and the chief difference was in the use of the *caestus*. This in Greek times consisted of leather thongs bound round the boxer's fists and wrists; and the weighting with lead or iron or metal studs, which made the caestus more like a "knuckle-duster" than a boxing-glove, was a later Roman development. The death of an antagonist, unless proved to be accidental, not only disqualified for a prize but was severely punished. The use of ear-guards and the comic allusions to broken ears, not noses, suggest that the Greek boxer did not hit out straight from the shoulder, but fought windmill fashion, like the modern rustic. In the *παράλιτον*, a combination of wrestling and boxing, the use of the caestus, and even of the clenched fist, was disallowed. (5) The *chariot-race* had its origin in the 23rd Olympiad. Of the hippodrome, or racecourse, no traces remain, but from the description of Pausanias we may infer that the dimensions were approximately 1600 ft. by 400. Down the centre there ran a bank of earth, and at each end of this bank was a turning-post round which the chariots had to pass. "To shun the goal with rapid wheels" required both nerve and skill, and the charioteer played a more important part in the race than even the modern jockey. Pausanias tells us that horses would shy as they passed the fatal spots. The places of the chariots were determined by lot, and there were elaborate arrangements for giving all a fair start. The number of chariots that might appear on the course at once is uncertain. Pindar (*Pyth.* v. 46) praises Arceus of Cyrene for having brought off his chariot uninjured in a contest where no fewer than forty took part. The large outlay involved excluded all but rich competitors, and even kings and tyrants eagerly contested the palm. Thus in the list of victors we find the names of Cylon, the would-be tyrant of Athens, Pausanias the Spartan king, Archelaus of Macedonia, Gelon and Hiero of Syracuse, and Theron of Agrigento. Chariot-races with mules, with mares, with two horses in place of four, were successively introduced, but none of these present any special interest. Races on horseback date from the 33rd Olympiad. As the course was the same, success must have depended on skill as much as on swiftness. Lastly, there were athletic contests of the same description for boys, and a competition of heralds and trumpeters, introduced in the 93rd Olympiad.

The prizes were at first, as in the Homeric times, of some intrinsic value, but after the 6th Olympiad the only prize for each contest was a garland of wild olive, which was cut with a golden sickle from the kallistephanos, the sacred tree brought by Hercules "from the dark fountains of Ister in the land of the Hyperboreans, to be a shelter common to all men and a crown of noble deeds" (Pindar, *Ol.* iii. 18). Greek writers from Herodotus to Plutarch dwell with complacency on the magnanimity of a people who cared for nothing but honour and were content to struggle for a corruptible crown. But though the Greek games present in this respect a favourable contrast to the greed and gambling of the modern recoursee, yet to represent men like Milon and Damoxenus as actuated by pure love of glory is a pleasing fiction of the moralists. The successful athlete received in addition to the immediate honours very substantial rewards. A herald proclaimed his name, his parentage and his country; the Hellanodicae took from a table of ivory and gold the olive crown and placed it on his head, and in his hand a branch of palm; as he marched in the sacred revel to the temple of Zeus, his friends and admirers showered in his path flowers and costly gifts, singing the old song of Archilochus, *εὐχόμενα καλλίστην*, and his name was canonized in the Greek calendar. Fresh honours and rewards awaited him on his return home. If he was an Athenian he received, according to the law of Solon, 500 drachmae, and free rations for life in the Prytaneum; if a Spartan, he had as his prerogative the post of honour in battle. Poets like Pindar, Simonides and Euripides sung his praises, and sculptors like Phedias and Praxiteles were engaged by the state to carve his statue. We even read of a breach in the town walls being made to admit him, as if the common road were not good enough for such a hero; and there are well-attested instances of altars being built and sacrifices offered to a successful athlete. No wonder then that an Olympian prize was regarded as the crown of human happiness. Cicero, with a Roman's contempt for Greek frivolity, observes with a sneer that an Olympian victor receives more honours than a triumphant general at Rome, and tells the story of the Rhodian Diagoras, who, having himself won the prize at Olympia, and seen his two sons crowned on the same day, was addressed by a Laconian in these words:—"Die, Diagoras, for thou hast nothing short of divinity to desire." Alcibiades, when setting forth his services to the state, puts first his victory at Olympia, and the prestige he had won for Athens by his magnificent display. But perhaps the most remarkable evidence of the exaggerated value which the Greeks attached to athletic prowess is a casual expression which Thucydides employs when describing the

enthusiastic reception of Brasidas at Scione. The state, he says, voted him a crown of gold, and the multitude flocked round him and decked him with garlands, as though he were an athlete.

The *Pythian* games originated in a local festival held at Delphi, anciently called Pytho, in honour of the Pythian Apollo, and were limited to musical competitions. The date at which they became a Panhellenic *ἀγών* (so Demosthenes calls them) cannot be determined, but the Pythiads as a chronological era date from 527 B.C., by which time music had been added to all the Panhellenic contests. Now, too, these were held at the end of every fourth year; previously there had been an interval of eight years. The Amphictyones presided and the prize was a chaplet of laurel.

The *Nemean* games were biennial and date from 516 B.C. They were by origin an Argive festival in honour of Nemean Zeus, but in historical times were open to all Greece and provided the established round of contests, except that no mention is made of a chariot-race. A wreath of wild celery was the prize.

The *Isthmian* games, held on the Isthmus of Corinth in the first and third year of each Olympiad, date, according to Eusebius, from 523 B.C. They are variously reported to have been founded by Poseidon or Sisyphus in honour of Melicertes, or by Theseus to celebrate his victory over the robbers Sinis and Sciron. Their early importance is attested by the law of Solon which bestowed a reward of 100 drachmae on every Athenian who gained a victory. The festival was managed by the Corinthians; and after the city was destroyed by Mummius (146 B.C.) the presidency passed to the Sicyonians until Julius Caesar rebuilt Corinth (46 B.C.). They probably continued to exist till Christianity became the religion of the Roman empire. The Athenians were closely connected with the festival, and had the privilege of *proedria*, the foremost seat at the games, while the Eleans were absolutely excluded from participation. The games included gymnastic, equestrian and musical contests, differing little from those of the other great festivals, and the prize was a crown made at one time of parsley (more probably wild celery), at a later period of pine. The importance of the Isthmian games in later times is shown by the fact that Flaminius chose the occasion for proclaiming the liberation of Greece, 196 B.C. That at a later anniversary (A.D. 67) Nero repeated the proclamation of Flaminius, and coupled with it the announcement of his own illustrious victory at Olympia, shows alike the hollowness of the first gift and the degradation which had befallen the Greek games, the last faint relic of Greek nationality.

The *Ludi Publici* of the Romans included feasts and theatrical exhibitions as well as the public games with *Roman*, which alone we are concerned. As in Greece, they were intimately connected with religion. At the beginning of each civil year it was the duty of the consuls to vow to the gods games for the safety of the commonwealth, and the expenses were defrayed by the treasury. Thus, at no cost to themselves, the Roman public were enabled to indulge at the same time their religious feelings and their love of amusement. Their taste for games naturally grew till it became a passion, and under the empire games were looked upon by the mob as one of the two necessities of life. The acediles who succeeded to this duty of the consuls were expected to supplement the state allowance from their private purse. Political adventurers were not slow to discover so ready a road to popularity, and what at first had been exclusively a state charge devolved upon men of wealth and ambition. A victory over some barbarian horde or the death of a relation served as the pretext for a magnificent display. But the worst extravagance of private citizens was eclipsed by the reckless prodigality of the Caesars, who squandered the revenues of whole provinces in catering for the mob of idle sightseers on whose favour their throne depended. But though public games played as important a part in Roman as in Greek history, and must be studied by the Roman historian as an integral factor in social and political life, yet, regarded solely as exhibitions, they are comparatively devoid of interest, and we sympathize with Pliny, who asks his friend how

any man of sense can go day after day to view the same dreary round of fights and races.

It is easy to explain the different feelings which the games of Greece and of Rome excite. The Greeks at their best were actors, the Romans from first to last were spectators. It is true that even in Greek games the professional element played a large and ever-increasing part. As early as the 6th century B.C. Xenophanes complains that the wrestler's strength is preferred to the wisdom of the philosopher, and Euripides, in a well-known fragment, holds up to scorn the brawny swaggering athlete. But what in Greece was a perversion and acknowledged to be such, the Romans not only practised but held up as their ideal. No Greek, however high in birth, was ashamed to compete in person for the Olympic crown. The Roman, though little inferior in gymnastic exercises, kept strictly to the privacy of the palaestra; and for a patrician to appear in public as a charioteer is stigmatized by the satirist as a mark of shameless effrontery.

Roman games are generally classified as *fixæ*, *extraordinary* and *volæ*; but they may be more conveniently grouped according to the place where they were held, viz. the circus or the amphitheatre.

For the Roman world the circus was at once a political club, a fashionable lounge, a rendezvous of gallantry, a betting ring, and a playground for the million. Juvenal, speaking loosely, says that in his day it held the whole of Rome; but there is no reason to doubt the precise statement of P. Victor, that in the Circus Maximus there were seats for 350,000 spectators.

Of the various *Ludi Circenses* it may be enough here to give a short account of the most important, the *Ludi Magni* or *Maximi*.

Initiated according to legend by Tarquinius Priscus, the *Ludi Magni* were originally a votive feast to Capitoline Jupiter, promised by the general when he took the field, and performed on his return from the annual campaign. They thus presented the appearance of a military spectacle, or rather a review of the whole burgess force, which marched in solemn procession from the capitol to the forum and thence to the circus, which lay between the Palatine and Aventine. First came the sons of patricians mounted on horseback, next the rest of the burghers ranged according to their military classes, after them the athletes, naked save for the girdle round their loins, then the company of dancers with the harp and flute players, next the priestly colleges bearing censers and other sacred instruments, and lastly the simulacra of the gods, carried aloft on their shoulders or drawn in cars. The games themselves were fourfold—(1) the chariot race; (2) the *ludus Troiae*; (3) the military review; and (4) gymnastic contests. Of these only the first two call for any comment. (1) The chariot employed in the circus was the two-wheeled war car, at first drawn by two, afterwards by four, and more rarely by three horses. Originally only two chariots started for the prize, but under Caligula we read of as many as twenty-four heats run in the day, each of four chariots. The distance traversed was fourteen times the length of the circus or nearly 5 m. The charioteers were apparently from the first professionals, though the stigma under which the gladiator lay never attached to their calling. Indeed a successful driver may compare in popularity and fortune with a modern jockey. The drivers were divided into companies distinguished by the colours of their tunics, whence arose the faction of the circus which assumed such importance under the later emperors. In republican times there were two factions, the white and the red; two more, the green and the blue, were added under the empire, and for a short time in Domitian's reign there were also the gold and the purple. Even in Juvenal's day party spirit ran so high that a defeat of the green was looked upon as a second Cannae. After the seat of empire had been transferred to Constantinople these factions of the circus were made the basis of political cabals, and frequently resulted in sanguinary tumults, such as the famous Nika revolt (A.D. 532), in which 30,000 citizens lost their lives. (2) The *Ludus Troiae* was a sham-fight on horseback in which the actors were patrician youths. A spirited description of it will be found in the 5th *Aeneid*. (See also *Circus*.)

The two exhibitions we shall next notice, though occasionally given in the circus, belong more properly to the amphitheatre. *Venatio* was the baiting of wild animals who were pitted either with one another or with men—captives, criminals or trained hunters called *bestiarii*. The first certain instance on record of this amusement is in 186 B.C., when M. Fulvius exhibited lions and tigers in the arena. The taste for these brutalizing spectacles grew apace, and the most distant provinces were ransacked by generals and proconsuls to supply the arena with rare animals—giraffes, tigers and crocodiles. Sulla provided for a single show 100 lions, and Pompey 600 lions, besides elephants, which were matched with Gaetulian hunters. Julius Caesar enjoys the doubtful honour of inventing the bull-fight. At the inauguration of the Colosseum 3000 wild and 4000 tame beasts were killed, and to commemorate

Trajan's Dacian victories there was a butchery of 11,000 beasts. The *naumachia* was a sea-fight, either in the arena, which was flooded for the occasion by a system of pipes and sluices, or on an artificial lake. The rival fleets were manned by prisoners of war or criminals, who often fought till one side was exterminated. In the sea-fight on Lake Fucinus, arranged by the emperor Claudius, 100 ships and 10,000 men were engaged.

But the special exhibition of the amphitheatre was the *munus gladiatorium*, which dates from the funeral games of Marcus and Decimus Brutus, given in honour of their father, 264 B.C. It was probably borrowed from Etruria, and a refinement on the common savage custom of slaughtering slaves or captives on the grave of a warrior or chieftain. Nothing so clearly brings before us the vein of coarseness and inhumanity which runs through the otherwise noble character of the Roman, as his passion for gladiatorial shows. We can fancy how Pericles, or even Alcibiades, would have loathed a spectacle that Augustus tolerated and Trajan patronized. Only after the conquest of Greece we hear of their introduction into Athens, and they were then admitted rather out of compliment to the conquerors than from any love of the sport. In spite of numerous prohibitions from Constantine downwards, they continued to flourish even as late as St Augustine. To a Christian martyr, if we may credit the story told by Theodoret and Cassiodorus, belongs the honour of their final abolition. In the year 404 Telemachus, a monk who had travelled from the East on this sacred mission, rushed into the arena and endeavoured to separate the combatants. He was instantly despatched by the praetor's orders; but Honorius, on hearing the report, issued an edict abolishing the games, which were never afterwards revived. (See GLADIATORS.)

Of the other Roman games the briefest description must suffice. The *Ludi Apollinares* were established in 212 B.C., and were annual after 211 B.C.; mainly theatrical performances. The *Megalenses* were in honour of the great goddess, Cybele; instituted 204 B.C., and from 191 B.C. celebrated annually. A procession of Galli, or priests of Cybele, was a leading feature. Under the empire the festival assumed a more orgiastic character. Four of Terence's plays were produced at these games. The *Ludi Saeculares* were celebrated at the beginning or end of each *saeculum*, a period variously interpreted by the Romans themselves as 100 or 110 years. The celebration by Augustus in 17 B.C. is famous by reason of the Ode composed by Horace for the occasion. They were solemnized by the emperor Philip A.D. 248 to commemorate the millennium of the city.

2. *Private Games*.—These may be classified as outdoor and indoor games. There is naturally all the world over a much closer resemblance between the pursuits and amusements of children than of adults. Homer's children built castles in the sand, and Greek and Roman children alike had their dolls, their hoops, their skipping-ropes, their hobby-horses, their kites, their knuckle-bones and played at hopscotch, the tug-of-war, pitch and toss, blind-man's buff, hide and seek, and kiss in the ring or at closely analogous games. Games of ball were popular in Greece from the days of Nausicaa, and at Rome there were five distinct kinds of ball and more ways of playing with them. For particulars the dictionary of antiquities must be consulted. It is strange that we can find in classical literature no analogy to cricket, tennis, golf or polo, and though the *foliis* resembled our football, it was played with the hand and arm, not with the leg. Cock-fighting was popular both at Athens and Rome, and quails were kept and put to various tests to prove their pluck.

Under indoor games we may distinguish games of chance and games of skill, though in some of them the two elements are combined. *Tesserae*, shaped and marked with pips like modern dice, were evolved from the *lali*, knuckle-bones with only four flat sides. The old Roman threw a hazzard and called a main, just as did Charles Fox, and the vice of gambling was lashed by Juvenal no less vigorously than by Pope. The Latin name for a dice-box has survived in the *fritillary* butterfly and flower.

The primitive game of guessing the number of fingers simultaneously held up by the player and his opponent is still popular in Italy where it is known as "morra." The proverbial phrase for an honest man was *quicum in tenebris micat*, one you would trust to play at morra in the dark.

Athena found the suitors of Penelope seated on cowhides and playing at *vesper*, some kind of draughts. The invention of the game was ascribed to Palamedes. In its earliest form it was played on a board with five lines and with five pieces. Later we find eleven lines, and a further development was the division of the board into squares, as in the game of *wolles* (cities). In the

Roman *latrunculi* (soldiers), the men were distinguished as common soldiers and "rovers," the equivalent of crowned pieces.

Duodecim scripta, as the name implies, was played on a board with twelve double lines and approximated very closely to our backgammon. There were fifteen pieces on each side, and the moves were determined by a throw of the dice; "blots" might be taken, and the object of the player was to clear off all his own men. Lastly must be mentioned the *Cottabus* (*q.s.*), a game peculiar to the Greeks, and with them the usual accompaniment of a wine party. In its simplest form each guest threw what was left in his cup into a metal basin, and the success of the throw, determined partly by the sound of the wine in falling, was reckoned a divination of love. For the various elaborations of the game (in Sicily we read of *Cottabus houses*), Athenaeus and Pollux must be consulted.

BIBLIOGRAPHY.—Darenberg et Saglio, *Dictionnaire des antiquités grecques et romaines*, articles "Agon," "Athleta," "Circus," "Ludi," "Olympia," "Spiele"; Curtius and Adler, *Olympia* (3 vols., 1890, &c.); Hachtmann, *Olympia und seine Festspiele*; Blümner, *Home Life of the Ancient Greeks*; J. P. Mahaffy, *Old Greek Education*; P. Gardner and F. B. Jevons, *Manual of Greek Antiquities*; E. N. Gardiner, *Greek Athletic Sports* (1910); Becker-Marquardt, *Handbuch der römischen Altertümer* (5 vols.). (F. S.)

GAMING AND WAGERING. It is somewhat difficult exactly to define or adequately to distinguish these terms of allied meaning. The word "game" (*q.s.*) is applicable to most pastimes and many sports, irrespective of their lawful or unlawful character. "Gaming" is now always associated with the staking of money or money's worth on the result of a game of pure chance, or mixed skill and chance; and "gambling" has the same meaning, with a suggestion that the stakes are excessive or the practice otherwise reprehensible, while "wager" and "wagering" are applied to money hazarded on any contingency in which the person wagering has no interest at risk other than the amount at stake. "Betting" is usually restricted to wagers on events connected with sports or games, and "lottery" applies to speculation to obtain prizes by lot or chance.

At English common law no games were unlawful and no penalties were incurred by gambling, nor by keeping gaming-houses, unless by reason of disorder they became a public nuisance. From very early times, however, the English statute law has attempted to exercise control over the sports, pastimes and amusements of the lieges. Several points of view have been taken: (1) their competition with military exercises and training; (2) their attraction to workmen and servants, as drawing them from work to play; (3) their interference with the observance of Sunday; (4) their combination with betting or gambling as causing impoverishment and dishonesty in children, servants and other unwary persons; (5) the use of fraud or deceit in connexion with them. The legislation has assumed several forms: (1) declaring certain games unlawful either absolutely or if accompanied by staking or betting money or money's worth on the event of the game; (2) declaring the keeping of establishments for betting, gaming or lotteries illegal, or prohibiting the use of streets or public places for such purposes; (3) prohibiting the enforcement in courts of justice of gambling contracts.

The earliest English legislation against games was passed in the interests of archery and other manly sports which were believed to render the lieges more fit for service in war. A statute of Richard II. (1388) directed servants and labourers to have bows and arrows and to use them on Sundays and holidays, and to cease from playing football, quoits, dice, putting the stone, kails and other such importune games. A more drastic statute was passed in 1409 (11 Hen. IV. c. 4) and penalties were imposed in 1477 (17 Edw. IV. c. 3) on persons allowing unlawful games to be played on their premises. These acts were superseded in 1541 (33 Hen. VIII. c. 9) by a statute passed on the petition of the bowyers, fletchers (*fletchers*), stringers and arrowhead makers of the realm. This act (still partly in force) is entitled an "act for maintenance of archery and debarring of unlawful games"; and it recites that, since the last statutes (of 3 & 6 Hen. VIII.) "divers and many subtil inventative and crafty persons have found and daily find many and sundry new and crafty games and plays, as logating in the fields, slide-thrift, otherwise called shove-groat, as well within the city of London as elsewhere in many other and divers parts of this realm, keeping houses, plays and alleys for the maintenance thereof, by reason whereof archery is sore decayed, and daily is like to be more minished, and divers

buyers and fletchers, for lack of work, gone and inhabit themselves in Scotland and other places out of this realm, there working and teaching their science, to the nuisance of the same, to the great comfort of strangers and detriment of this realm." Accordingly penalties are imposed on all persons keeping houses for unlawful games, and all persons resorting thereto (s. 8). The games specified are dicing, table (backgammon) or carding, or any game prohibited by any statute theretofore made or any unlawful new game then or thereafter invented or to be invented. It is further provided that "no manner of artificer or craftsman of any handicraft or occupation, husbandman, apprentice, labourer, servant at husbandry, journeyman or servant of artificer, mariners, fishermen, watermen, or any serving man, shall play at the tables, tennis, dice, cards, bowls, clash, coyling, loggating or any other unlawful game out of Christmas under the pain of xxs, to be forfeit for every time; and in Christmas to play at any of the said games in their masters' houses or in their masters' presence; and also that no manner of person shall at any time play at any bowl or bowls in open places out of his garden or orchard" (s. 11). The social evils of gambling (impoverishment, crime, neglect of divine service) are incidentally alluded to in the preamble, but only in connexion with the main purpose of the statute—the maintenance of archery. No distinction is made between games of skill and games of chance, and no reference is made to playing for money or money's worth. The *Book of Sports* of James I. (1617), republished by Charles I. (1633), was aimed at encouraging certain sports on Sundays and holidays; but with the growth of Puritanism the royal efforts failed. The Sunday Observance Act 1675 prohibits the meeting of people out of their own parishes on the Lord's Day for any sports or pastimes whatsoever. It has been attempted to enforce this act against Sunday football. The act goes on to prohibit any bear-baiting, bull-baiting, interludes, common plays or other unlawful exercises or plays on Sunday by parishioners within their own parishes. According to Blackstone (iv. Comm. c. 13) the principal ground of complaint leading to legislation in the 18th century was "gambling in high life." He collects the statutes made with this view, but only those still in force need have been mentioned.

The first act directed against gambling as distinct from playing games was that of 1665 (16 Car. II. c. 7) "against deceitful, disorderly and excessive gaming" which deals with games both of skill and chance at which people cheat, or play otherwise than with ready money, or lose more than £100 on credit. In 1698 (13 Will. III. c. 23) legislation was passed against lotteries, therein described as "mischievous and unlawful games." This act was amended in 1710 (9 Anne c. 6), and in the same year was passed a statute which is the beginning of the modern legislation against gambling (9 Anne c. 19). It includes within its scope money won by "gaming or playing" at cards, &c., and money won by "betting" on the sides or hands of those who game at any of the forbidden games. But it refers to tennis and bowls as well as to games with cards and dice.

The following list of lawful games, sports and exercises is given in *Officers on Horses, &c.* (6th ed.): horse-races, steeplechases, trotting matches, coursing matches, foot-races, boat-races, regattas, rowing matches, golf, wrestling matches, cricket, tennis, fives, rackets, bowls, skittles, quoits, curling, putting the stone, football, and presumably every bona-fide variety, e.g. croquet, knurr and spell, hockey or any similar games. Cock-fighting is said to have been unlawful at common law, and that and other modes of setting animals to fight are offences against the Prevention of Cruelty to Animals Act. The following are also lawful games: whist and other lawful games at cards, backgammon, bagatelle, billiards, chess, draughts and dominoes. But to allow persons to play for money at these games or at skittles or "skittle pool" or "puff and dart" on licensed premises is gaming within the Licensing Act 1872. The earlier acts declared unlawful the following games of skill: football, quoits, putting the stone, kails, tennis, bowls, clash or kails, or cloyshcayls, loggating, half bowl, side-thrift or shove-groat and backgammon. Backgammon and other games in 1739 played with backgammon tables were treated as lawful in that year. Horse-racing, long under restriction, being mentioned in the act of 1665 and many 18th-century acts, was fully legalized in 1840 (3 & 4 Vict. c. 35). The act of 1541, so far as it declared any game of mere skill unlawful, was repealed by the Gaming Act 1845. Billiards is legal in private houses or clubs and in public places duly licensed. The following games have been declared by the statutes or the judges to be unlawful, whether played in public or in private, unless played in a royal palace where the sovereign is residing: ace of hearts, pharaoh (faro), basnet and hazard (1738), passagc, and every game then invented or to be invented with dice or with any other instrument, engine or device in the nature of dice having one or more figures or numbers thereon (1739), roulette or roly-poly (1744), and all lotteries (except Art Union lotteries), rouge et noir, baccarat-banque (1884), chemin de fer (1895), and all games at cards which are not games of mere skill. The definition of unlawful game does not include whist played for a prize not subscribed to by the players, but it does include playing cards for money in licensed premises; even in the private room of the licensee or with private friends during closing hours.

The first attack on lotteries was in 1698, against lotteries "by dice, lots, cards, balls or any other numbers or figures or in any other

way whatsoever." An act of 1721 prohibited lotteries which under the name of sales distributed prizes in money, advowsons, land, jewels, &c., by lots, tickets, numbers or figures. Acts of 1722, 1733 and 1823 prohibited any sale of tickets, receipts, chances or numbers in foreign lotteries. The games of cards already referred to as unlawful were in 1738 declared to be "games or lotteries by cards or dice," and in 1802 the definition of lottery was extended to include "little-goes and any game or lottery not authorized by parliament, drawn by dice, lots, cards, balls, or by numbers or figures or by any other way, contrivance or device whatsoever." This wide definition reaches raffles and sweepstakes on races. The advertisement of foreign or illegal lotteries is forbidden by acts of 1836 and 1844. In 1846 art unions were exempted from the scope of the Lottery Acts. Attempts have been made to suppress the sale in England of foreign lottery tickets, but the task is difficult, as the post-office distributes the advertisements, although, under the Revenue Act 1898, the Customs treat as prohibited goods advertisements or notices as to foreign lotteries. More success has been obtained in putting down various devices by newspapers and shopkeepers to attract customers by instituting "missing word competitions" and "racing coupon competitions"; by automatic machines which give speculative chances in addition to the article obtained for the coin inserted; by distribution of prizes by lot or chance to customers; by holding sweepstakes at public-houses, by putting coins in sweetmeats to tempt street urchins by cupidity to indigestion; or by gratuitous distribution of medals giving a chance of a prize from a newspaper. An absolutely gratuitous distribution of chances seems not to be within the acts, but a commercial distribution is, even if individuals who benefit do not pay for their chance.

As already stated, the keeping of a gaming-house was at common law punishable only if a public nuisance were created. The act of 1541 imposes penalties on persons maintaining houses for unlawful games. Originally licences could be obtained for such houses, but these were abolished in 1555 (2 & 3 Phil. and Mar.). In 1698 lotteries were declared public nuisances, and in 1802 the same measure was meted out to lotteries known as little-goes. Special penalties are provided for those who set up lotteries or any unlawful game with cards or dice, &c. (1738, 1739, 1744). In 1751 inhabitants of a parish were enabled to insist on the prosecution of gaming-houses. The act of 1802 imposed severe penalties on persons publicly or privately keeping places for any lottery. This statute hits at the deliberate or habitual use of a place for the prohibited purpose, and does not touch isolated or incidental uses on a single occasion, e.g. at a bazaar or show; but under an act of 1823 the sale of lottery tickets is in itself an offence. The Gaming Act 1845 facilitates the search of suspected gaming-houses and the proof that they are such. It provides that, to prove any house to be a common gaming-house, it "shall be sufficient to show that it is kept or used for playing therein at any unlawful game, and that a bank is kept there by one or more of the players exclusively of the others, or that the chances of any game played therein are not alike favourable to all the players, including among the players the banker or other person by whom the game is managed, or against whom the other players stake, play or bet." Gambling, it will be noticed, is still in this definition connected with some kind of game. The act also provides that proof that the gaming was for money shall not be required, and that the presence of cards, dice and other instruments of gaming shall be prima-facie evidence that the house was used as a common gaming-house. The most recent statute dealing with gaming-houses is of 1854, which provides summary remedies against the keeper and makes further provisions to facilitate conviction. It may be added that the Gaming Act 1845 makes winning money by cheating at any game or wager punishable in the same way as obtaining money by false pretences. At the present time proceedings for keeping gaming-houses in the sense in which that word is commonly understood are comparatively rare, and are usually against foreigners. The statutes hit both public and private gaming-houses (see the Park Club case, *Jenks v. Turpin*, 1884, 13 Q.B.D. 505, the leading case on unlawful games). The proprietor and the person who keeps the bank at an unlawful game are both within the statute: the players are not, but the act of Henry VIII. is so far alive that they can be put under recognizance not to frequent gaming-houses. Under the Licensing Act 1872 penalties are incurred by licensed victuallers who suffer any gaming or unlawful game to be played on their premises. A single instance of playing an unlawful game for money in a private house is not within the statutes (*R. v. Davies*, 1897, 2 Q.B. 199).

In England, so far as the general public is concerned, gaming at cards is to a large extent superseded by betting on sports and pastimes, or speculation by means of lotteries or like devices. The legislation against betting *ex nomine* began in 1853. In the Betting Act 1853 it is described as a kind of gaming of late sprung up to the injury and demoralization of improvident persons by the opening of places called betting houses and offices, and the receiving of money *in advance* by the owners or occupiers or their agents on promises to pay money on events or horse races and like contingencies. This act strikes at ready money betting as distinguished from betting on credit ("on the nod"). It was avowedly framed to hit houses open to all and sundry as distinguished from private betting clubs such as Tatterall's. The act seeks to punish persons who keep a house

office, room or other place for the purpose (*inter alia*) of any person betting with persons "resorting thereto" or of receiving deposits in consideration of bets on contingencies relating to horse-races or other races, fights, games, sports or exercises. The act especially excepts persons who receive or hold prizes or stakes to be paid to the winner of a race or lawful sport, game or exercise, or to the owner of a horse engaged in a race (s. 6). Besides the penalties incurred by keeping such places, the keeper is liable to repay to depositors the sums deposited (s. 5).

By the Licensing Act 1872 penalties are incurred by licensed persons who allow their houses to be used in contravention of the Betting Act 1853. There has been a great deal of litigation as to the meaning and scope of this enactment, and a keen contest between the police and the Anti-gambling League (which has been very active in the matter) and the betting confraternity, in which much ingenuity has been shown by the votaries of sport in devising means for evading the terms of the enactment. The consequent crop of legal decisions shows a considerable divergence of judicial opinion. The House of Lords has held that the Tattersall's enclosure or betting ring on a racecourse is not a "place" within the statute; and members of a bona-fide club who bet with each other in the club are not subject to the penalties of the act. But the word "place" has been held to include a public-house bar, an archway, a small plot of waste ground, and a bookmaker's stand, and even a bookmaker's big umbrella, and it is difficult to extract from the judges any clear indication of the nature of the "places" to which the act applies. The act is construed as applying only to ready-money betting, *i.e.* when the stake is deposited with the bookmaker, and only to places used for betting with persons physically resorting thereto; so that bets by letter, telegram or telephone do not fall within its penalties. The aim of the law has been found long enough to punish as thieves "welshers," who receive and make off with deposits on bets which they never mean to pay if they lose. The act of 1853 makes it an offence to publish advertisements showing that a house is kept for betting. It was supplemented in 1874 by an act imposing penalties on persons advertising as to betting. But this has been read as applying to bets falling within the act of 1853, and it does not prohibit the publication of betting news or sporting tips in newspapers. A few newspapers do not publish these aids to ruin, and in some public libraries the betting news is obliterated, as it attracts crowds of undesirable readers. The act of 1853 has been to a great extent effectual against betting houses, and has driven some of them to Holland and other places. But it has been deemed expedient to legislate against betting in the streets, which has been found too attractive to the British workman.

By the Metropolitan Streets Act 1867 any three or more persons assembled together in any part of any street in the city of London or county of London for the purpose of betting and deemed to be obstructing the street, may be arrested without warrant by a constable and fined a sum not exceeding £5. The Vagrancy Act 1873 (36 & 37 Vict. c. 38) provides that "Every person playing or betting by way of wagering or gaming on any street, road, highway or other open and public place, or in any open place to which the public have, or are permitted to have, access, at or with any table or instrument of gaming, or any coin, card, token or other article used as an instrument or means of gaming, at any game or pretended game of chance, shall be deemed a rogue and vagabond." This act amended a prior act of 1868, passed to repress the practice of playing pitch and toss in the streets, which had become a public nuisance in the colliery districts. The powers of making by-laws for the peace, order and good government of their districts, possessed by municipal boroughs—and since 1888 by county councils—and extended in 1899 to the new London boroughs, have in certain cases been exercised by making by-laws forbidding any person to "frequent or use any street or other public place, on behalf either of himself or any other person, for the purpose of bookmaking, or betting, or wagering, or agreeing to bet or wager with any person, or paying, or receiving or settling bets." This and similar by-laws have been held valid, but were found inadequate, and by the Street Betting Act 1906 (6 Edw. VII. c. 43), passed by the efforts of the late Lord Davey, it is made an offence for any person to frequent or loiter in a street or public place on behalf of himself or of any other person for the purpose of bookmaking or betting or wagering or agreeing to bet or wager or paying or receiving or settling bets. The punishment for a first offence is fine up to £10, for a second fine up to £20, and the punishment is still higher in the case of a third or subsequent offence, or where the accused while committing the offence has any betting transaction with a person under the age of sixteen. The act does not apply to ground used for a course for horse-racing or adjacent thereto on days on which races take place; but the expression public place includes a public park, garden or sea-beach, and any unenclosed ground to which the public for the time have unrestricted access, and enclosed places other than public parks or gardens to which the public have a restricted right of access with or without payment, if the owners or persons controlling the place exhibit conspicuously a notice prohibiting betting therein. A constable may arrest without warrant persons offending and seize all books, papers, cards and other articles relating to betting found in their possession, and these articles may be forfeited on conviction. Besides the above provision against betting with infants the Betting

and Loans (Infants) Act 1892, passed at the instance of the late Lord Herschell, makes it a misdemeanour to send, with a view to profit, to any one known by the sender to be an infant, a document inviting him to enter into a betting or wagering transaction. The act is intended to protect lads at school and college from temptation by bookmakers.

We must now turn from the public law with respect to gaming to the treatment of bets and wagers from the point of view of their obligation on the individuals who lose them. A *Wagering* wager may be defined as "a promise to give money or money's worth upon the determination or ascertainment of an uncertain event" (Anson, *Law of Contract*, 11th ed., p. 206). The event may be uncertain because it has not happened or because its happening is not ascertained; but to make the bargain a wager the determination of the event must be the sole condition of the bargain. According to the view taken in England of the common law, bets or wagers were legally enforceable, subject to certain rules dictated by considerations of public policy, *e.g.* that they did not lead to immorality or breach of the peace, or expose a third person to ridicule.¹ The courts were constantly called upon to enforce wagers and constantly exercised their ingenuity to discover excuses for refusing. A writer on the law of contracts² discovers here the origin of that principle of "public policy" which plays so important a part in English law. Wagering contracts were rejected because the contingencies on which they depended tended to create interests hostile to the common weal. A bet on the life of the emperor Napoleon was declared void because it gave one of the parties an interest in keeping the king's enemy alive, and also because it gave the other an interest in compassing his death by unlawful means. A bet as to the amount of the hop-duty was held to be against public policy, because it tended to expose the condition of the king's revenue to all the world. A bet between two hackney coachmen, as to which of them should be selected by a gentleman for a particular journey, was void because it tended to expose the customer to their importunities. When no such subtlety could be invented, the law, however reluctantly, was compelled to enforce the fulfilment of a wager. Actions on wagers were not favoured by the judges; and though a judge could not refuse to try such an action, he could, and often did, postpone it until after the decision of more important cases.

Parliament gradually intervened to confine the common law within narrower limits, both in commercial and non-commercial wagers, and both by general and temporary enactments. An example of the latter was 7 Anne c. 16 (1710), avoiding all wagers and securities relating to the then war with France. The earliest general enactment was 16 Car. II. c. 7 (1665), prohibiting the recovery of a sum exceeding £100 lost in games or pastimes, or in betting on the sides or hands of the players, and avoiding securities for money so lost. 9 Anne c. 19 avoided securities for such wagers for any amount, even in the hands of bona-fide holders for value without notice, and enabled the loser of £10 or upwards to sue for and recover the money he had lost within three months of the loss. Contracts of insurance by way of gaming and wagering were declared void, in the case of marine risks in 1746, and in the case of other risks in 1774. It was not until 1845 that a general rule was made excluding wagers from the courts. Section 18 of the Gaming Act 1845 (passed after a parliamentary inquiry in 1844 as to gaming) enacted "that all contracts or agreements, whether by parole or in writing, by way of gaming or wagering shall be null and void, and that no suit shall be brought or maintained in any court of law or equity for recovering any sum of money or valuable thing alleged to be won upon any wager, or which shall have been deposited in the hands of any person to abide the event on which any wager shall have been made; provided always that this enactment shall not be deemed to apply to any subscription or contribution, or agreement to subscribe or contribute, for or towards any plate, prize or sum of money to be awarded to the winner or winners of any lawful game, sport, pastime or exercise."

The construction put on this enactment enabled turf commission

¹ Leake on *Contracts* (4th ed.), p. 520.

² Pollock, *Contracts* (7th ed.), p. 313.

agents to recover from their principals bets made and paid for them. But the Gaming Act 1892 rendered null and void any promise, express or implied, to repay to any person any sum of money paid by him under, or in respect of, any contract or agreement rendered null and void by the Gaming Act 1845, or to pay any sum of money by way of commission, fee, reward, or otherwise in respect of any such contract or agreement, or of any services in relation thereto or in connexion therewith, and provided that no action should be brought or maintained to recover any such sum. By the combined effect of these two enactments the recovery by the winner from the loser or stakeholder of bets or of stakes on games falling within s. 18 of the Gaming Act 1845 is absolutely barred; but persons who have deposited money to abide the event of a wager are not debarred from crying off and recovering their stake before the event is decided, or even after the decision of the event and before the stake is paid over to the winner;¹ and a man who pays a bet for a friend, or a turf commission agent or other agent who pays a bet for a principal, has now no legal means of recovering the money, unless some actual deceit was used to induce him to pay in ignorance that it was a bet. But a person who has received a bet on account of another can still, it would seem, be compelled to pay it over, and the business of a betting man is treated as so far lawful that income-tax is charged on its profits, and actions between parties in such a business for the taking of partnership accounts have been entertained.

The effect of these enactments on speculative dealings in shares or other commodities calls for special consideration. It seems to be correct to define a wagering contract as one in which two persons, having opposite opinions touching the issue of an event (past or future), of which they are uncertain, mutually agree that on the determination of the event one shall win, and the other shall pay over a sum of money, or other stake, neither party having any other interest in the event than the sum or stake to be won or lost. This definition does not strike at contracts in "futures," under which the contractors are bound to give or take delivery at a date fixed of commodities not in existence at the date of the contract. Nor are such contracts rendered void because they are entered into for purposes of speculation; in fact, their legality is expressly recognized by the Sale of Goods Act 1893. Contracts of insurance are void if made by way of gaming or wagering on events in which the assured has no interest present or prospective whether the matter be life or fire risks (1774) or maritime risks (Marine Insurance Act 1906). An act known as Sir John Barnard's Act (7 Geo. II. c. 8, entitled "An act to prevent the infamous practice of stock jobbing") prohibited contracts for liberty to accept or refuse any public stocks or securities and wagers relating to public stocks, but this act was repealed in 1860, and contracts to buy or sell stocks and shares are not now void because entered into by way of speculation and not for purposes of investment. The only limitation on such contracts is that contained in Leeman's Act (30 & 31 Vict. c. 29) as to contracts for the sale of shares in joint-stock banking companies. But a transaction in any commodity, though in form commercial, falls within the Gaming Acts if in substance the transaction is a mere wager on the price of the commodity at a date fixed by the contract. It does not matter whether the dealing is in stocks or in cotton, nor whether it is entered into on the Stock Exchange, or on any produce exchange, or elsewhere; nor is it conclusive in favour of the validity of the bargain that it purports to bind the parties to take or deliver the article dealt in. The courts are entitled to examine into the true nature of the transaction; and where the substantial intention of the parties is merely to gamble in differences, to make what is called "a time bargain," the fact that it is carried out by a series of contracts, regular and valid in form, will not be sufficient to exclude the application of the Gaming Acts.

In very many cases transactions with "outside stockbrokers" or "bucket shops" have been held to be mere wagers, although the contracts purported to give "put" or "call" options to demand delivery or acceptance of the stocks dealt with; and the cover

¹ *Burge v. Ashby*, 1900, 1 Q.B. 744.

deposited by the "client" has been treated as a mere security for performance of the bargain, and recoverable if sued for in time, i.e. before it is used for the purpose for which it is deposited. There was not up to 1909 any authoritative decision as to the application of the Gaming Act 1892 to transactions on the London Stock Exchange through a stockbroker who is a member of "the House"; but the same principle appears to be applicable where the facts of the particular deal clearly indicate that the intention was to make a mere time bargain, or to pay or receive differences only. The form, however, of all bargains on the Stock Exchange is calculated and intended to preclude people from setting up a gaming act defence: as each contract entitles the holder to call for delivery or acceptance of the stock named therein. In the event of the bankruptcy of a person involved in speculations, the bankruptcy officials exclude from proof against the estate all claims founded on any dealing in the nature of a wager; and on the same principle the bankrupt's trustee cannot recover sums won by the bankrupt by gaming transactions, but unexhausted "cover" on uncompleted transactions may be recovered back.

Besides the enactments which prevent the recovery of bets or wagers by action there has also been a good deal of legislation dealing with securities given in respect of "gambling debts." The earliest (1665) dealt with persons playing at games otherwise than for ready money and losing £100 or more on credit, and not only prohibited the winner from recovering the overplus but subjected him to penalties for winning it. An act of 1710 (9 Anne c. 19) declared utterly void all notes, bills, bonds, judgments, mortgages or other securities where the consideration is for money or valuable security won by gaming at cards, stocks or other games, or by betting on the sides or hands of the gamblers, or for reimbursing money knowingly advanced for such gaming or betting. This act draws a distinction between gaming and other bets or wagers. Under this act the securities were void even in the hands of innocent transferees. In 1841 the law was altered, declaring such securities not void but made upon an "illegal" consideration. The effect of the change is to enable an innocent transferee for value, of a bill, note or cheque, to recover on a security worthless in the hands of the original taker (see s. 30 of the Bills of Exchange Act 1882), but to put on him the burden of proving that he is a bona fide holder for value. In the case of a negotiable security given for a wager not within the acts of 1710 or 1841 (e.g. a bet on a contested election), but within the act of 1845, a third person holding it would be presumed to be a holder for value and on the person prima facie liable under the security falls the burden of proving that no consideration was given for it. It has been decided after considerable divergence of judicial opinion that an action will not lie in England in favour of the drawee against the drawer of a cheque drawn at Algiers on an English bank, partly for losses at baccarat, and partly for money borrowed to continue playing the game. The ground of decision was in substance that the Gaming Acts of 1845 and 1892 as the *lex fori* prohibit the English courts from enforcing gaming debts wherever incurred (*Moulis v. Owen*, 1907, 1 K.B. 746).

Scotland.—A Scots act of 1621 c. 14 (said still to be in force) forbids playing at cards or dice in any common house of hostelry, and directs that sums over 100 marks won on any one day at carding or dicing or at wagers on horse races should be at once sent to the treasurer of the kirk session. The Lottery Acts, except that of 1698, apply to Scotland; and the Betting House Act 1853 was extended to Scotland in 1874. The Street Betting Act 1906 extends to Scotland, and gaming houses can be suppressed under the Burgh Police Act 1892, and street betting, lotteries or gaming under that of 1903.

The Scots courts refuse to try actions on wagers, as being *spensiones ludicrae*, unbecoming the dignity of the courts. 9 Anne c. 19 and 5 & 6 Will. IV. c. 41 extend to Scotland, but the weight of judicial opinion is that the Gaming Act 1845 does not.

Ireland.—The British Acts against lotteries were extended to Ireland in 1780, and the general law as to gaming is the same in both countries.

British Possessions.—Certain of the earlier imperial acts are in force in British possessions, e.g. the act of 9 Anne c. 19, which is in force in Ontario subject to amendments made in 1902. In the Straits Settlements, Jamaica and British Guiana there are ordinances directed against gambling and lotteries, and particularly

against forms of gambling introduced by the Chinese. Under these ordinances the money paid for a lottery ticket is recoverable by law. In the Transvaal betting houses were suppressed by proclamation (No. 33) soon after the annexation. An invention known in France as the *pari-mutuel*, and in Australia as the totalizator, is allowed to be used on race-courses in most of the states (but not in New South Wales). In Queensland, South Australia, Tasmania and Western Australia the state levies a duty on the takings of the machine. In Tasmania the balance of the money retained by the stewards of the course less the tax must be applied solely for improving the course or promoting horse-racing. In Victoria under an act of 1901 the promoters of sports may by advertisement duly posted make betting on the ground illegal.

Egypt.—By law No. 10 of 1905 all lotteries are prohibited with certain exceptions, and it is made illegal to hawk the tickets or offer them for sale or to bring illegal lotteries in any way to the notice of the public. The authorized lotteries are those for charitable purposes, e.g. those of the benevolent societies of the various foreign communities.

United States.—In the United States many of the states make gaming a penal offence when the bet is upon an election, or a horse race, or a game of hazard. Betting contracts and securities given upon a bet are often made void, and this may destroy a gaming note in the hands of an innocent purchaser for value. The subject lies outside of the province of the federal government. By the legislation of some states the loser may recover his money if he sue within a limited time, as he might have done in England under 9 Anne c. 19.

AUTHORITIES.—Brandt on *Games* (1872); Oliphant, *Law of Horses*, &c. (6th ed. by Lloyd, 1908); Schwabe on the *Stock Exchange* (1905); Melheimer on the *Stock Exchange* (4th ed., 1905); Coldridge and Hawkford, *The Law of Gambling* (1895); Stutfield, *Betting* (3rd ed., 1901). (W. F. C.)

GAMUT (from the Greek letter *gamma*, used as a musical symbol, and *ut*, the first syllable of the medieval hymn *Sanctus Johannes*), a term in music used to mean generally the whole compass or range of notes possessed by an instrument or voice. Historically, however, the sense has developed from its stricter musical meaning of a scale (the recognized musical scale of any period), originating in the medieval "great scale," of which the invention has usually been ascribed to Guido of Arezzo (q.v.) in the 11th century. The whole question is somewhat obscure, but, in the evolution of musical notation out of the classical alphabetical system, the invention of the medieval gamut is more properly assigned to Hucbald (d. 930). In his system of scales the semitone was always between the 2nd and 3rd of a tetrachord, as G, A, \flat B, C, so the \sharp B and \sharp F of the second octave were in false relation to the \flat B and \sharp F of the first two tetrachords. To this scale of four notes, G, A, \flat B, C, were subsequently added a note below and a note above, which made the hexachord with the semitone between the 3rd and 4th both up and down, as F, G, A, \flat B, C, D. It was at a much later date that the 7th, our leading note, was admitted into a key, and for this the first two letters of the last line of the above-named hymn, "Sanctus Johannes," would have been used, save for the notion that as the note Mi was at a semitone below Fa, the same vowel should be heard at a semitone below the upper Ut, and the syllable Si was substituted for Sa. Long afterwards the syllable Ut was replaced by Do in Italy, but it is still retained in France; and in these two countries, with whatever others employ their nomenclature, the original Ut and the substituted Do stand for the sound defined by the letter C in English and German terminology. The literal musical alphabet thus accords with the syllabic: A B C D E F G In Germany a remnant of Greek use survives. A was originally followed in the scale by the semitone above, as the classical Mesē was followed by Paramesē, and this note, namely \flat B, is still called B in German, English \sharp B (French and Italian Si) being represented by the letter H. The gamut which, whenever instituted, did not pass out of use until the 19th century, regarded the hexachord and not the octachord, employed both letters and syllables, made the former invariable while changing the latter according to key relationship, and acknowledged only the three keys of G, C and F; it took its name from having the Greek letter gamma with Ut for its lowest keynote, though the Latin letters with the corresponding syllables were applied to all the other notes.

GANDAK, a river of northern India. It rises in the Nepal Himalayas, flows south-west until it reaches British territory, where it forms the boundary between the United Provinces and Bengal for a considerable portion of its course, and falls into the Ganges opposite Patna. It is a snow-fed stream, and the surrounding country in the plains, lying at a lower level than its banks, is endangered by its floods. The river is accordingly enclosed by protective embankments.

The **LITTLE GANDAK** rises in the Nepal hills, enters Gorakhpur district about 8 m. west of the Gandak, and joins the Gogra just within the Saran district of Bengal.

The **BURHI** (or old) **GANDAK** also rises in the Nepal hills, and follows a course roughly parallel to and east of that of the Gandak, of which it represents an old channel, passing Muzaffarpur, and joining the Ganges nearly opposite to Moughjir. Its principal tributary is the Baghmati, which rises in the hills N. of Kathmandu, flows in a southerly direction through Tirhut, and joins the Burhi Gandak close to Ruseira.

GANDAMAK, a village of Afghanistan, 35 m. from Jalalabad on the road to Kabul. On the retreat from Kabul of General Elphinstone's army in 1842, a hill near Gandamak was the scene of the massacre of the last survivors of the force, twenty officers and forty-five British soldiers. It is also notable for the treaty of Gandamak, which was signed here in 1879 with Yakub Khan. (See AFGHANISTAN.)

GANDERSHEIM, a town of Germany in the duchy of Brunswick, in the deep valley of the Gande, 48 m. S.W. of Brunswick, on the railway Bössum-Holzminden. Pop. (1905) 2847. It has two Protestant churches of which the convent church (*Stiftskirche*) contains the tombs of famous abbesses, a palace (now used as law courts) and the famous abbey (now occupied by provincial government offices). There are manufactures of linen, cigars, beet-root sugar and beer.

The abbey of Gandersheim was founded by Duke Ludolf of Saxony, who removed here in 856 the nuns who had been shortly before established at Brunshausen. His own daughter Hathumoda was the first abbess, who was succeeded on her death by her sister Gerberga. Under Gerberga's government Louis III. granted a privilege, by which the office of abbess was to continue in the ducal family of Saxony as long as any member was found competent and willing to accept the same. Otto III. gave the abbey a market, a right of toll and a mint; and after the bishop of Hildesheim and the archbishop of Mainz had long contended with each other about its supervision, Pope Innocent III. declared it altogether independent of both. The abbey was ultimately recognized as holding directly of the Empire, and the abbess had a vote in the imperial diet. The conventual estates were of great extent, and among the feudatories who could be summoned to the court of the abbess were the elector of Hanover and the king of Prussia. Protestantism was introduced in 1568, and Magdalena, the last Roman Catholic abbess, died in 1589; but Protestant abbesses were appointed to the foundation, and continued to enjoy their imperial privileges till 1803, when Gandersheim was incorporated with Brunswick. The last abbess, Augusta Dorothea of Brunswick, was a princess of the ducal house, and kept her rank till her death. The memory of Gandersheim will long be preserved by its literary memorials. Hroswitha, the famous Latin poet, was a member of the sisterhood in the 9th century; and the rhyming chronicle of Eberhard of Gandersheim ranks as in all probability the earliest historical work composed in low German.

The Chronicle, which contains an account of the first period of the monastery, is edited by L. Wieland in the *Monumenta Germ. historica* (1877), and has been the object of a special study by Paul Hase (Göttingen, 1872). See also "Agil vita Hathumodæ abbatissæ Gandershemensis primæ," in J. G. von Eckhart's *Veterum monasteriorum quaternio* (Leipzig, 1720); and Hase, *Mittelalterliche Baudenkmäler Niedersachsens* (1870).

GANDHARVA, in Hindu mythology, the term used to denote (1) in the Rig-Veda usually a minor deity; (2) in later writings a class of divine beings. As a unity Gandharva has no special attributes but many duties, and is in close relation with the great gods. Thus he is director of the sun's horses; he is guardian of

soma, the sacred liquor, and therefore is regarded as the heavenly physician, soma being a panacea. He is servant of Agni the god of light and of Varuna the divine judge. He is omnipresent: in the heavens, in the air and in the waters. He is the keeper of heaven's secrets and acts as messenger between gods and men. He is gorgeously clothed and carries shining weapons. For wife he has the spirit of the clouds and waters, Apsaras, and by her became father of the first mortals, Yama and Yami. He is the tutelary deity of women and presides over marriage ceremonies. In their collective capacity the Gandharvas share the duties allotted to the single deity. They live in the house of Indra and with their wives, the Apsaras, beguile the time by singing, acting and dancing. Sometimes they are represented as numbering twelve, sometimes twenty-seven, or they are innumerable. In Hindu law a Gandharva marriage is one contracted by mutual consent and without formality.

GANDÍA, a seaport of eastern Spain, in the province of Valencia; on the Gandía-Alcázar and Alcira-Denia railways. Pop. (1900) 10,026. Gandía is on the left bank of the river Alcázar or Sèrpis, which waters one of the richest and most populous plains of Valencia and enters the Mediterranean Sea at the small harbour of Gandía (*El Graó*), 3 m. N.E. The chief ancient buildings of Gandía are the Gothic church, the college, founded by San Francisco de Borgia, director-general of the order of Jesus (1510-1572), and the palace of the dukes of Gandía—a title held in the 15th and 16th centuries by members of the princely house of Borgia or Borja. A Jesuit convent, the theatre, schools and the palace of the dukes of Osuna, are modern. Besides its manufactures of leather, silk, velvet and ribbons, Gandía has a thriving export trade in fruit, and imports coal, guano, timber and flour. In 1904, 400 vessels, of 200,000 tons, entered the harbour.

GANDO, a sultanate of British West Africa, included in the protectorate of Nigeria, situated on the left bank of the Niger above Borgu. The sultanate was established, c. 1810, on the death of Othman Dan Fodio, the founder of the Fula empire, and its area and importance varied considerably during the 19th century, several of the Fula emirates being regarded as tributaries, while Gando itself was more or less dependent on Sokoto. Gando in the middle of the century included both banks of the Niger at least as far N.W. as Say. The districts outside the British protectorate now belong to France. Since 1884 Gando has been in treaty relations with the British, and in 1903 the part assigned to the British sphere by agreement with France came definitely under the control of the administration in Nigeria. Gando now forms the sub-province of the double province of Sokoto. The emir was appointed under British authority after the conquest of Sokoto in 1903. Since that date the province has been organized for administration on the same system as the rest of the protectorate of Northern Nigeria. Provincial and native courts of justice have been established, roads have been opened, the slave trade has been abolished, and the country assessed under the new scheme for taxation. British garrisons are stationed at Jegga and Ambrusa. The chief town is Gando, situated on the Sokoto, the first considerable affluent of the Niger from the east, about 60 m. S.W. of the town of Sokoto.

GANESA, or **GANESH**, in Hindu mythology, the god of wisdom and prudence, always represented with an elephant's head possibly to indicate his sagacity. He is the son of Siva and Parvati. He is among the most popular of Indian deities, and almost every act, religious or social, in a Hindu's life begins with an invocation to him, as do most books. He typifies not the wisdom of knowledge but that worldly wisdom which results in financial success, and thus he is particularly the god of the Hindu shopkeeper. In his divine aspect Ganesa is ruler over the hosts of heaven, the spirits which come and go to do Indra's will.

GANGES (**GANGA**), a great river of northern India, formed by the drainage of the southern ranges of the Himalayas. This mighty stream, which in its lower course supplies the river system of Bengal, rises in the Garhwal state, and falls into the Bay of Bengal after a course of 1500 m. It issues, under the name of the Bhagirathi, from an ice cave at the foot of a Himalayan snow-bed near Gangotri, 10,300 ft. above the level of the sea.

During its passage through the southern spurs of the Himalayas it receives the Jahnvi from the north-west, and subsequently the Alaknanda, after which the united stream takes the name of the Ganges. Deo Prayag, their point of junction, is a celebrated place of pilgrimage, as is also Gangotri, the source of the parent stream. At Sukhi it pierces through the Himalayas, and turns south-west to Hardwar, also a place of great sanctity. It proceeds by a tortuous course through the districts of Dehra Dun, Saharanpur, Muzaffarnagar, Bulandshahr and Farukhabad, in which last district it receives the Ramganga. Thus far the Ganges has been little more than a series of broad shoals, long deep pools and rapids, except, of course, during the melting of the snows and throughout the rainy season. At Allahabad, however, it receives the Jumna, a mighty sister stream, which takes its rise also in the Himalayas to the west of the sources of the Ganges. The combined river winds eastwards by south-east through the United Provinces, receiving the Gumti and the Gogra. The point of junction with both the Gumti and the Gogra has more or less pretension to sanctity. But the tongue of land at Allahabad, where the Jumna and the Ganges join, is the true Prayag, the place of pilgrimage, to which hundreds of thousands of devout Hindus repair to wash away their sins in the sacred river. It is here that the great festival called the Magh mela is held.

Shortly after passing the holy city of Benares the Ganges enters Behar, and after receiving an important tributary, the Son, from the south, passes Patna, and obtains another accession to its volume from the Gandak, which rises in Nepal. Farther to the east it receives the Kusi, and then, skirting the Rajmahal hills, turns sharply to the southward, passing near the site of the ruined city of Gaur. By this time it has approached to within 240 m., as the crow flies, from the sea. About 20 m. farther on it begins to branch out over the level country, and this spot marks the commencement of the delta, 220 m. in a straight line, or 300 by the windings of the river, from the Bay of Bengal. The main channel takes the name of the Padma or Padra, and proceeds in a south-easterly direction, past Fátma to Goalanda, above which it is joined by the Jamuna or main stream of the Brahmaputra. The vast confluence of waters rushes towards the sea, receiving further additions from the hill country on the east, and forming a broad estuary known under the name of the Meghna, which enters the Bay of Bengal near Nonkhali. This estuary, however, is only the largest and most easterly of a great number of mouths or channels. The most westerly is the Hugli, which receives the waters of a number of distributary channels that start from the parent Ganges above Murshidabad. Between the Hugli on the west and the Meghna on the east lies the delta. The upper angle of it consists of rich and fertile districts, such as Murshidabad, Nadia, Jessore and the 24 Parganas. But towards its southern base, resting on the sea, the country sinks into a series of great swamps, intercepted by a network of innumerable channels. This wild waste is known as the Sundarbans, from the *sundari* tree, which grows in abundance in the seaboard tracts.

The most important channel of the Ganges for commerce is the Hugli, on which stands Calcutta, about 90 m. from the mouth. Beyond this city the navigation is conducted by native craft—the modern facilities for traffic by rail and the increasing shoals in the river having put an end to the previous steamer communication, which plied until about 1860 as high up as Allahabad. Below Calcutta important boat routes through the delta connect the Hugli with the eastern branches of the river, for both native craft and steamers.

The Ganges is essentially a river of great cities: Calcutta, Monghyr, Patna, Benares and Allahabad all lie on its course below its junction with the Jumna; and the ancient capitals, Agra and Delhi, are on the Jumna, higher up. The catchment basin of the Ganges is bounded on the N. by a length of about 700 m. of the Himalayan range, on the S. by the Vindhya mountains, and on the E. by the ranges which separate Bengal from Burma. The vast river basin thus enclosed embraces 432,480 sq. m. According to the latest calculations, the length of the main stream of the Ganges is 1540 m., or with its longest affluent, 1680; breadth at true entrance into the sea, 20 m.; breadth of channel in dry season, 1½ to 2½ m.; depth in dry season, 30 ft.; flood discharge, 1,800,000 cub. ft. per second; ordinary discharge, 207,000 cub. ft.; longest duration of flood, about 40 days. The average fall from Allahabad to Benares is 6 in. per mile; from Benares to Calcutta, between 4 and 5 in.; from Calcutta to the sea, 1 to 2 in. Great changes take place from time to time in the river-bed, which alter the face of the country. Extensive islands are thrown up, and attach themselves to the mainland, while the river deserts its old bed and seeks a new channel, it may be many miles off. Such changes are so rapid and on so vast a scale, and the corroding power of the current on the bank so irresistible, that in Lower Bengal it is considered perilous to build any structure of a large or permanent character on its margin. Many decayed or ruined cities attest the changes in the river-bed in ancient times; and within our own times the main channel which formerly passed Rajmahal has turned away from it, and left the town high and dry, 7 m. from the bank.

The Ganges is crossed by six railway bridges on its course as far as Benares; and another, at Sara in Eastern Bengal, has been sanctioned.

The UPPER GANGES CANAL and the LOWER GANGES CANAL are the two principal systems of perennial irrigation in the United Provinces. The Ganges canal was opened by Lord Dalhousie in 1854, and irrigates 978,000 acres. The Lower Ganges canal, an extension of the original canal, has been in operation since 1878 and irrigates 850,000 acres. The two canals, together with the eastern Jumna, command the greater portion of the Doab lying between the Ganges and the Jumna, above Allahabad. Navigation in either is insignificant. (T. H. H.')

GANGOTRI, a celebrated place of Hindu pilgrimage, among the Himalaya Mountains. It is situated in the native state of Garhwal in the United Provinces, on the Bhagirathi, the chief head-stream of the Ganges, which is here not above 15 or 20 yds. broad, with a moderate current, and not in general above 3 ft. deep. The course of the river runs N. by E.; and on the bank near Gangotri there is a small temple about 20 ft. high, in which are images representing Ganga, Bhagirathi and other figures of mythology. It dates from the early part of the 18th century. The bed of the river adjoining the temple is divided off by the Brahmans into three basins, where the pilgrims bathe. One of these portions is dedicated to Brahma, another to Vishnu and the third to Siva. The pilgrimage to Gangotri is considered efficacious in washing away the sins of the devotee, and ensuring him eternal happiness in the world to come. The water taken from this sacred spot is exported by pilgrims to India and sold at a high price. The elevation of the temple above the sea is 10,319 ft.

GANGPUR, a tributary state of Orissa, Bengal, included until 1905 among the Chota Nagpur States. It is bounded N. by Ranchi district, E. by the Singhbhum district, S. by Sambalpur and Bamra, and W. by Raigarh in the Central Provinces. The country is for the most part an undulating plain, broken by detached ranges of hills, one of which, the Mahavira range, possesses a very remarkable appearance, springing abruptly from the plain in an irregular wall of tilted and disrupted rock, with two flanking peaks. The rivers are the Ib and the Brahmani, formed here by the union of the Sankh and the South Koel, both navigable by canoes. The Ib was formerly famous on account of diamonds found in its bed, and its sands are still washed for gold. One of the largest coalfields in India extends into the state, and iron ore is also found. Jungle products—lac, silk cocoons, catechu and resin, which are exported; wild animals—bisons, buffaloes, tigers, leopards, hyenas, wolves, jackals, wild dogs and many sorts of deer. Area, 2492 sq. m.; pop. (1901) 238,896; estimated revenue, £16,000.

GANGRENE (from Gr. γάγγραινα, an eating sore, from γάβειν, to gnaw), a synonym in medicine for mortification (*q.v.*), or a local death in the animal body due to interruption of the circulation by various causes.

GANILH, CHARLES (1758—1836), French economist and politician, was born at Allanche in Cantal on the 6th of January 1758. He was educated for the profession of law and practised as *avocat*. During the troubled period which culminated in the taking of the Bastille on the 14th of July 1789, he came prominently forward in public affairs, and was one of the seven members of the permanent Committee of Public Safety which sat at the hôtel de ville. He was imprisoned during the Reign of Terror, and was only released by the counter-revolution of the 9th Thermidor. During the first consulate he was called to the tribunate, but was excluded in 1802. In 1815 he was elected deputy for Cantal, and finally left the Chamber on its dissolution in 1823. He died in 1836. Ganilh is best known as the most vigorous defender of the mercantile school in opposition to the views of Adam Smith and the English economists.

His works, though interesting from the clearness and precision with which these peculiar opinions are presented, do not now possess much value for the student of political economy. He wrote *Essai politique sur le revenu des peuples de l'antiquité, du moyen âge, &c.* (1808); *Des systèmes d'économie politique* (1809); *Théorie d'économie politique* (1815); *Dictionnaire analytique de l'économie politique* (1826).

GANJAM, a district of British India, in the extreme north-east of the Madras Presidency. It has an area of 8372 sq. m. Much of the district is exceedingly mountainous and rocky, but is interspersed with open valleys and fertile plains. Pleasant

groves of trees in the plains give to the scenery a greener appearance than is usually met with in the districts to the south. The mountainous tract known as the Maliyas, or chain of the Eastern Ghats, has an average height of about 2000 ft.—its principal peaks being Singharaj (4976 ft.), Mahendragiri (4923) and Devagiri (4535). The hilly region forms the agency of Ganjam, with an area of 3483 sq. m. and a population (in 1901) of 321,114, mostly wild backward tribes, incapable of being governed under ordinary conditions and therefore ruled by an agent of the governor with special powers. The chief rivers are the Rushikulya, the Vamsadhara and the Languliya. The sea and river fisheries afford a livelihood to a considerable section of the population. The hilly region abounds in forests consisting principally of *sal*, with satin-wood, ebony and sandal-wood in smaller quantities.

Ganjam formed part of the ancient kingdom of Kalinga. Its early history is involved in obscurity, and it was not till after the Gajapati dynasty ascended the throne of Orissa that this tract became even nominally a part of their dominions. Owing to the nature of the country the rising Mahomedan power was long kept at bay; and it was not till nearly a century after the first invasion of Orissa that a Mahomedan governor was sent to govern the Chicacole Circars, which included the present district of Ganjam. In 1753 Chicacole, with the Northern Circars, were made over to the French by Salabat Jang for the maintenance of his French auxiliaries. In 1759 Masulipatam was taken by an English force sent from Bengal, and the French were compelled to abandon Ganjam and their other factories in the north. In 1765 the Northern Circars (including Ganjam) were granted to the English by imperial firman, and in August 1768 an English factory was founded at Ganjam, protected by a fort. The present district of Ganjam was constituted in 1802. In the earlier years of British rule considerable difficulty was experienced in the administration of the district; and on more than one occasion the refractory large landholders had to be coerced by means of regular troops. In 1816 Ganjam was overrun by the Pindaris; and in 1836 occurred the Gunsur campaign, when the British first came into contact with the aboriginal Kondhs, the suppression of whose practice of human sacrifice was successfully accomplished. A petty rising of a section of the Kondhs occurred in 1865, which was, however, suppressed without the aid of regular troops.

In 1901 the pop. of the district was 2,010,256, showing an increase of 20% in the decade. There are two systems of government irrigation: (1) the Rushikulya project, and (2) the Ganjam minor rivers system. The principal crops are rice, other food grains, pulse, oil seeds and a little sugar-cane and cotton. Salt is evaporated, as a government monopoly, along the coast. Sugar is refined, according to German methods, at Aska, where rum also is produced. A considerable trade is conducted at the ports of Gopalpur and Calingapatam, which are only open roadsteads. The district is traversed throughout by the East Coast railway (Bengal-Nagpur system), which was opened from Calcutta to Madras in 1900. There are colleges at Berhampore and Parlakimedi. The headquarters station is Berhampore; the town of Ganjam occupied this position till 1815, when it was found unhealthy, and its importance has since declined.

GANNAL, JEAN NICOLAS (1791—1852), French chemist, was born at Sarre-Louis on the 28th of July 1791. In 1808 he entered the medical department of the French army, and witnessed the retreat from Moscow in 1812. After the downfall of the empire he worked at the Ecole Polytechnique in Paris and subsequently at the Faculty of Sciences as assistant to L. J. Thénard. His contributions to technical chemistry included a method of refining borax, the introduction of elastic rollers formed of gelatin and sugar for use in printing, and processes for manufacturing glue and gelatin, lint, white lead, &c. The Institute awarded him a Montyon prize in 1827 for his advocacy of chlorine as a remedy in pulmonary phthisis, and again in 1835 for his discovery of the efficacy of solutions of aluminium acetate and chloride for preserving anatomical preparations. In the latter part of his life he turned his attention to embalment, his method depending on the injection of solutions of aluminium salts into the arteries. He died at Paris in January 1852. His son

ÉLIX, born in 1829, also devoted himself to the question of the disposal of the dead, among his publications being *Mort réelle et mort apparente* (1868), *Inhumation et crémation* (1876), and *Les Cimetières* (1885), a work on the history and law of burial, of which only one volume appeared.

GANNET (O.E. *ganot*) or SOLAN GOOSE, ¹ the *Pelecanus bassanus* of Linnaeus and the *Sula bassana* of modern ornithologists, a large sea-fowl long known as a numerous visitor, for the purpose of breeding, to the Bass Rock at the entrance of the Firth of



Gannet, or Solan Goose.

Forth, and to certain other islands off the coast of Britain, of which four are in Scottish waters—namely, Ailsa Craig, at the mouth of the Firth of Clyde; the group known collectively as St Kilda; Suleskerry, some 40 m. north-east of the Butt of Lewis; and the Stack and Skerry, about the same distance westward of Stromness. It appears also to have two stations off the coast of

¹ The phrase *ganotes bath* (gannet's bath), a periphrasis for the sea, occurs in the *Anglo-Saxon Chronicle*, in reference to events which took place A.D. 975, as pointed out by Prof. Cunningham, whose learned treatise on this bird (*Ibis*, 1866, p. 1) nearly exhausts all that can be said of its history and habits. A few pages further on (p. 13) this writer remarks:—"The name gannet is intimately connected with our modern English gander, both words being modifications of the ancient British 'gan' or 'gana,' which is the same word as the modern German 'Gans,' which in its turn corresponds with the old High German 'Kans,' the Greek $\chi\eta\eta$, the Latin *anser*, and the Sanskrit 'hanaa,' all of which possess the same signification, viz. a goose. The origin of the names solan or soland, sulan, sula and hal-sula, which are evidently all closely related, is not so obvious. Martin [*Voy. St Kilda*] informs us that 'some imagine that the word solan comes from the Irish *solan*, corrupted and adapted to the Scottish language, *qui oculis irretoritis a longinqua respicitur praedam*.' The earlier writers in general derive the word from the Latin *solea*, in consequence of the bird's supposed habit of hatching its egg with its foot; and in a note intercalated into Ray's description of the solan goose in the edition of his *Itineraries* published by the Ray Society, and edited by Dr Lankester, we are told, though no authority for the statement is given, that 'the gannet, *Sula alba*, should be written solent goose, i.e. a channel goose.'" Hereon an editorial note remarks that this last statement appears to have been a suggestion of Yarrell's, and that it seems at least as possible that the "Solent" took its name from the bird.

Ireland, the Skellig Islands and the Stags of Broadhaven, and it resorts besides to Lundy Island in the Bristol Channel—its only English breeding-place. Farther to the northward its settlements are Myggenaes, the most westerly of the Faeroes, and various small islands off the coast of Iceland, of which the Vestmannaeyjar, the Reykjanes Fuglaskér and Grimsey are the chief. On the western side of the Atlantic it appears to have but five stations, one in the Bay of Fundy, and four rocks in the Gulf of St Lawrence. On all these seventeen places the bird arrives about the end of March or in April and departs in autumn when its young are ready to fly; but even during the breeding-season many of the adults may be seen on their fishing excursions at a vast distance from their home, while at other times of the year their range is greater still, for they not only frequent the North Sea and the English Channel, but stray to the Baltic, and, in winter, extend their flight to the Madeiras, while the members of the species of American birth traverse the ocean from the shores of Greenland to the Gulf of Mexico.

Apparently as bulky as a goose, and with longer wings and tail, the gannet weighs considerably less. The plumage of the adult is white, tinged on the head and neck with buff, while the outer edge and principal quills of the wings are black, and some bare spaces round the eyes and on the throat reveal a dark blue skin. The first plumage of the young is of a deep brown above, but paler beneath, and each feather is tipped with a triangular white spot. The nest is a shallow depression, either on the ground itself or on a pile of turf, grass and seaweed—which last is often conveyed from a great distance. The single egg it contains has a white shell of the same chalky character as a cormorant's. The young are hatched blind and naked, but the slate-coloured skin with which their body is covered is soon clothed with white down, replaced in due time by true feathers of the dark colour already mentioned. The mature plumage is believed not to be attained for some three years. Towards the end of summer the majority of gannets, both old and young, leave the neighbourhood of their breeding-place, and, betaking themselves to the open sea, follow the shoals of herrings and other fishes (the presence of which they are most useful in indicating to fishermen) to a great distance from land. Their prey is almost invariably captured by plunging upon it from a height, and a company of gannets fishing presents a curious and interesting spectacle. Flying in a line, each bird, when it comes over the shoal, closes its wings and dashes perpendicularly into the waves, whence it emerges after a few seconds, and, shaking the water from its feathers, mounts in a wide curve, and orderly takes its place in the rear of the string, to repeat its headlong plunge so soon as it again finds itself above its prey.²

Structurally the gannet presents many points worthy of note, such as its closed nostrils, its aborted tongue, and its toes all connected by a web—characters which it possesses in common with most of the other members of the group of birds (*Steganopodes*) to which it belongs. But more remarkable still is the system of subcutaneous air-cells, some of large size, pervading almost the whole surface of the body, communicating with the lungs, and capable of being inflated or emptied at the will of the bird. This peculiarity has attracted the attention of several writers—Montagu, Sir R. Owen (*Proc. Zool. Soc.*, 1831, p. 90), and Macgillivray.

In the southern hemisphere the gannet is represented by two nearly allied but somewhat smaller forms—one, *Sula capensis*, inhabiting the coast of South Africa, and the other, *S. serrator*, the Australian seas. Both much resemble the northern bird, but

² The large number of gannets, and the vast quantity of fish they take, has been frequently admired upon, but the computations on this last point are perhaps fallacious. It seems to be certain that in former days fishes, and herrings in particular, were at least as plentiful as now, if not more so, notwithstanding that gannets were more numerous. Those frequenting the Bass were reckoned by Macgillivray at 20,000 in 1831, while in 1869 they were computed at 12,000, showing a decrease of two-fifths in 38 years. On Ailsa in 1869 there were supposed to be as many as on the Bass, but their number was estimated at 10,000 in 1877 (*Report on the Herring Fisheries of Scotland*, 1878, pp. xxv. and 171).—being a diminution of one-sixth in eight years, or nearly twice as great as on the Bass.

the former seems to have a permanently black tail, and the latter a tail the four middle feathers of which are blackish-brown with white shafts.

Apparently inseparable from the gannets generically are the smaller birds well known to sailors as boobies, from the extraordinary stupidity they commonly display. They differ, however, in having no median stripe of bare skin down the front of the throat; they almost invariably breed upon trees and are inhabitants of warmer climates. One of them, *S. cyanops*, when adult has much of the aspect of a gannet, but *S. piscator* is readily distinguishable by its red legs, and *S. leucogaster* by its upper plumage and neck of deep brown. These three are widely distributed within the tropics, and are in some places exceedingly abundant. The fourth, *S. variegata*, which seems to preserve throughout its life the spotted suit characteristic of the immature *S. bassans*, has a much more limited range, being as yet only known from the coast of Peru, where it is one of the birds which contribute to the formation of guano. (A. N.)

GANODONTA (so named from the presence of bands of enamel on the teeth), a group of specialized North American Lower and Middle Eocene mammals of uncertain affinity. The group includes *Hemiganus*, *Psilacotherium* and *Corycytes* from the Puerco, *Calamodon* and *Hemiganus* from the Wasatch, and *Sylinodon* from the Bridger Eocene. With the exception of *Corycytes*, in which it is longer, the skull is short and suggests affinity to the sloths, as does what little is known of the limb-bones. The dentition, too, is of a type which might well be considered ancestral to that of the Edentata. For instance, the molars when first developed have tritubercular summits, but these soon become worn away, leaving tall columnar crowns, with a subcircular surface of dentine exposed at the summit of each. Moreover, while the earlier types have a comparatively full series of teeth, all of which are rooted and invested with enamel, in the later forms the incisors are lost, the cheek-teeth never develop roots but grow continuously throughout life. These and other features induced Dr J. L. Wortman to regard the Ganodontata as an ancestral suborder of Edentata; but this view is not accepted by Prof. W. B. Scott. Teeth provisionally assigned to *Calamodon* have been obtained from the Lower Tertiary deposits of Switzerland.

See J. L. Wortman, "The Ganodontata and their Relationship to the Edentata," *Bull. Amer. Mus.* vol. ix. p. 59 (1897); W. B. Scott, "Mammalia of the Santa Cruz Beds, Edentata," *Rep. Princeton Exped. in Patagonia*, vol. v. (1903-1904). (R. L. *)

GANS, EDUARD (1797-1839), German jurist, was born at Berlin on the 22nd of March 1797, of prosperous Jewish parents. He studied law first at Berlin, then at Göttingen, and finally at Heidelberg, where he attended Hegel's lectures, and became thoroughly imbued with the principles of the Hegelian philosophy. In 1820, after taking his doctor's degree, he returned to Berlin as lecturer on law. In 1825 he turned Christian, and the following year was appointed extraordinary, and in 1828 ordinary, professor in the Berlin faculty of law. At this period the historical school of jurisprudence was coming to the front, and Gans, predisposed owing to his Hegelian tendencies to treat law historically, applied the method to one special branch—the right of succession. His great work, *Erbrecht in weltgeschichtlicher Entwicklung* (1824, 1825, 1829 and 1835), is of permanent value, not only for its extensive survey of facts, but for the admirable manner in which the general theory of the slow evolution of legal principles is presented. In 1830, and again in 1835, Gans visited Paris, and formed an intimate acquaintance with the leaders of literary culture and criticism there. The liberality of his views, especially on political matters, drew upon Gans the displeasure of the Prussian government, and his course of lectures on the history of the last fifty years (published as *Vorlesungen über d. Geschichte d. letzten fünfzig Jahre*, Leipzig, 1833-1834) was prohibited. He died at Berlin on the 6th of May 1839. In addition to the works above mentioned, there may be noted the treatise on the fundamental laws of property (*Über die Grundlage des Besizes*, Berlin, 1829), a portion of a systematic work on the Roman civil law (*System des römischen Civil-Rechts*, 1827), and a collection of his miscellaneous writings (*Vermischte Schriften*, 1832). Gans edited

the *Philosophie der Geschichte* in Hegel's *Werke*, and contributed an admirable preface.

See *Revue des deux mondes* (Dec. 1839).

GÄNSBACHER, JOHANN BAPTIST (1778-1844), Austrian musical composer, was born in 1778 at Sterzing in Tirol. His father, a schoolmaster and teacher of music, undertook his son's early education, which the boy continued under various masters till 1802, when he became the pupil of the celebrated Abbé G. J. Vogler. To his connexion with this artist and with his fellow-pupils, more perhaps than to his own merits, Gänzbacher's permanent place in the history of music is due; for it was during his second stay with Vogler, then (1810) living at Darmstadt, that he became acquainted with Weber and Meyerbeer, and the close friendship which sprang up among the three young musicians, and was dissolved by death only, has become celebrated in the history of their art. But Gänzbacher was himself by no means without merit. He creditably filled the responsible and difficult post of director of the music at St Stephen's cathedral, Vienna, from 1823 till his death (July 13, 1844); and his compositions show high gifts and accomplishment. They consist chiefly of church music, 17 masses, besides litanies, motets, offertories, &c., being amongst the number. He also wrote several sonatas, a symphony, and one or two minor compositions of a dramatic kind.

GANTÉ, a cloth made from cotton or tow warp and jute weft. It is largely used for bags for sugar and similar material, and has the appearance of a fine hessian cloth.

GANYMEDE, in Greek mythology, son of Tros, king of Dardania, and Callirrhoe. He was the most beautiful of mortals, and was carried off by the gods (in the later story by Zeus himself, or by Zeus in the form of an eagle) to Olympus to serve as cup-bearer (Apollodorus iii. 12; Virgil, *Aeneid*, v. 254; Ovid, *Metam.* x. 255). By way of compensation, Zeus presented his father with a team of immortal horses (or a golden vine). Ganymede was afterwards regarded as the genius of the fountains of the Nile, the life-giving and fertilizing river, and identified by astronomers with the Aquarius of the zodiac. Thus the divinity that distributed drink to the gods in heaven became the genius who presided over the due supply of water on earth. When pederasty became common in Greece, an attempt was made to justify it and invest it with dignity by referring to the rape of the beautiful boy by Zeus; in Crete, where the love of boys was reduced to a system, Minos, the primitive ruler and law-giver, was said to have been the ravisher of Ganymede. Thus the name which once denoted the good genius who bestowed the precious gift of water upon man was adopted to this use in vulgar Latin under the form *Calamitus*. Ganymede being carried off by the eagle was the subject of a bronze group by the Athenian sculptor Leochares, imitated in a marble statuette in the Vatican. E. Veckenstedt (*Ganymedes*, Libau, 1881) endeavours to prove that Ganymede is the genius of intoxicating drink (*μῆνυρ*, mead, for which he postulates a form *μῆνυρ*), whose original home was Phrygia.

See article by P. Weizsäcker in Roscher's *Lexikon der Mythologie*. In the article GREEK ART., fig. 53 (Pl. I.) gives an illustration of Ganymede borne aloft by an eagle.

GAO, GAO-GAO, or GARO, a town of French West Africa, in the Upper Senegal and Niger colony, on the left bank of the Niger, 400 m. by river below Timbuktu. Pop. about 5000. The present town dates from the French occupation in 1900; of the ancient city there are scanty ruins, the chief being a truncated pyramid, the remains of the tomb (16th century) of Mahommed Askia, the Songhai conqueror, and those of the great mosque. According to tradition a city stood on this spot in very ancient times and its inhabitants are said to have had intercourse with the Egyptians. It is known, however, that the city of which the French settlement is the successor was founded by the Songhai, probably in the 7th or 8th century, and became the capital of their empire. Garo (Ga-rho) appears to have been the correct name of the Songhai city, though it was also known as Gogo and Kuku (Kaougha).¹ In the 12th century Idrisi describes Kuku as

¹ There was another city called Kaoka or Gaoga east of Lake Chad in the country now known as Bagirmi. It was the seat of the

a populous unvalled town devoted to commerce and industry; it is possible, however, that Idrisi is referring not to Gao but to another town somewhat to the south—at that period the middle course of the Niger had many prosperous towns along its banks. In the 14th century Gao was conquered by the king of Melle, and its great mosque was built (c. 1325) by the Melle sovereign Kunkur Musa on his return from a pilgrimage to Mecca. In the 15th century the Songhai regained power and Gao attained its greatest prosperity in the reign of Aakia. It did not enjoy the commercial importance of Jenné nor the intellectual supremacy of Timbuktu, but was the political centre of the western Sudan for a long period. On the break up of the Songhai power the city declined in importance. It became subject in 1590 to the *Ruma* of Timbuktu, from whom it was wrested in 1770 by the Tuareg, the last named surrendering possession to the French. The first European to reach Gao was Mungo Park (1805); he was followed in 1851 by Heinrich Barth, and in 1896 by the French naval lieutenant Hourst. Gao is now the headquarters of a military district. A caravan route leads from it to Kano and Bornau. From Gao upwards the Niger is navigable for over 1000 m.

See TIMBUKTU. For the Gao region of the Niger see an article by F. Dubois in *L'Afrique française* (January 1909).

GAOL, or **JAIL**, a prison (q.v.). The two forms of the word are due to the parallel dual forms in Old Central and Norman French respectively, *jaiole* or *jaole*, and *gaiole* or *gayolle*. The common origin is the med. Lat. *gabiola*, a diminutive formed from *caeva*, a hollow, a den, from which the English "cave" is derived. The form "gaoi" still commonly survives in English, and is in official usage, e.g. "gaoi-delivery," but the common pronunciation of both words, "jail," shows the real surviving word.

GAON (Heb. for "Excellency," plural *Geonim*), the title given to the heads of the two Jewish academies in Babylonia, Sura and Pumbeditha. Though the name is far older, it is chiefly applied to Rabbis who lived between the close of the Talmud and the transference of the centre of Judaism from Asia to Europe—i.e. from the end of the 6th to the middle of the 11th century A.D. The Geonim were required to do homage to the Exilarchs (see EXILARCH) but were otherwise independent. They exercised wide authority and were appealed to in settlement of the social and religious affairs of the diaspora. To them must be assigned the arrangement of the main lines of the present Synagogue liturgy. Their chief literary activity took the form of Answers to Questions—a form which was extensively used in later centuries. The most noted of the Geonim, who will be found treated under their respective names, were Abai, Amram, Semach, Saadiah, Sherira and Hai. Hai Gaon died in 1038, closing the period of the Geonim after an activity of four and a half centuries.

A full list of the Geonim is given in tabular form in the *Jewish Encyclopaedia*, vol. v. p. 571. (I. A.)

GAP, the capital of the French department of the Hautes Alpes. Pop. (1906) town, 6888; commune, 10,823. It is built at a height of 2418 ft. on the right bank of the Luye (an affluent of the Durance), in an agreeable position, and is dominated afar by snowy peaks on the N.E. The little city has the look of a Provençal town, being white. The 17th-century cathedral church has been entirely reconstructed (1866-1905). In the prefecture is the tomb of the constable de Lesdiguières (1543-1626), dating from about 1613, and due to a Lorraine sculptor, Jacob Richier. The same building contains various scientific and archaeological collections, as well as the very rich archives, which include many MSS. from the monastery of Durbon, &c. There are a few small manufactories of purely local importance. Gap is connected by railway with Briançon (51½ m.) and with Grenoble (85½ m.), while from the railway junction of Veynes (16½ m. W. of Gap) it is 122 m. by rail to Marseilles. The episcopal Bulala dynasty, an offshoot of the royal family of Kanem, whose rule in the 15th century extended from the Shari to Darfur. The existence of the state was first mentioned by Leo Africanus. To the Bornuense it was known as Bulala or Kuka Bulala, a name which persists as that of a district in French Congo (see BORNU). The similarity of the name Gaoga to that of the Songhai capital has given rise to much confusion.

see of Gap, now in the ecclesiastical province of Aix en Provence, is first certainly mentioned in the 6th century, and in 1791 was enlarged by the annexation of that of Embrun (then suppressed).

Gap is the *Vapincum* of the Romans, and was founded by Augustus about 14 B.C. It long formed part of Provence, but in 1237 most of the region passed by marriage to the dauphins of Viennois. The town itself, however, remained under the rule of the bishops until 1512, when it was annexed to the crown of France. The bishops continued to bear the title of count of Gap until the Revolution. The town was sacked by the Huguenots in 1567 and 1577, and by the duke of Savoy in 1692. It was the birthplace of the reformer Guillaume Farel (1480-1565), who first preached his doctrines there about 1561-1562, but then took refuge in Switzerland.

See J. Roman, *Histoire de la ville de Gap* (Gap, 1892).

(W. A. B. C.)

GAPAN, a town of the province of Nueva Ecija, Luzon, Philippine Islands, 3 m. E. of San Isidro, the capital. Pop. (1903) 11,278. It is situated in a rich rice-growing region, and extensive forests in its vicinity contain fine hardwoods. Its climate is comparatively cool and healthy. The principal native dialects spoken are Tagalog and Pampangan. Gapan is the oldest town of the province.

GARARISH (KARARISH), a semi-nomadic tribe of Semitic origin, dwelling along the right bank of the Nile from Wadi Halfa to Merawi. Many members of the tribe are agriculturists, others act as guides or transport drivers. They declare themselves kinsfolk of the Ababda, but they are more Arab than Beja.

GARASHANIN, ILIYA (1812-1874), Servian statesman, was the son of a Servian peasant, who made money by exporting cattle and pigs to Austria and by his intelligence and wealth attained to a certain influence in the country. He wanted to give his son as good an education as possible, and therefore sent him to Hungary to learn first in a Greek and then in a German school. Highly gifted, and having passed through a regular although somewhat short school training, the young Iliya very quickly came to the front. In 1836 Prince Milosh appointed him a colonel and commander of the then just organized regular army of Servia. In 1842 he was called to the position of assistant to the home minister, and from that time until his retirement from public life in 1867 he was repeatedly minister of home affairs, distinguishing himself by the energy and justice of his administration. But he rendered far greater services to his country as minister for foreign affairs. He was the first Servian statesman who had a political programme, and who worked to replace the Russian protectorate over Servia by the joint protectorate of all the great powers of Europe. As minister for foreign affairs in 1853 he was decidedly opposed to Servia joining Russia in war against Turkey and the western powers. His anti-Russian views resulted in Prince Menshikov, while on his mission in Constantinople, 1853, peremptorily demanding from the prince of Servia (Alexander Karageorgevich) his dismissal. But although dismissed, his personal influence in the country secured the neutrality of Servia during the Crimean War. He enjoyed esteem in France, and it was due to him that France proposed to the peace conference of Paris (1856) that the old constitution, granted to Servia by Turkey as suzerain and Russia as protector in 1839, should be replaced by a more modern and liberal constitution, framed by a European international commission. But the agreement of the powers was not secured. Garashanin induced Prince Alexander Karageorgevich to convoke a national assembly, which had not been called to meet for ten years. The assembly was convoked for St Andrew's Day 1858, but its first act was to dethrone Prince Alexander and to recall the old Prince Milosh Obrenovich. When after the death of his father Milosh (in 1860) Prince Michael ascended the throne, he entrusted the premiership and foreign affairs to Iliya Garashanin. The result of their policy was that Servia was given a new, although somewhat conservative, constitution, and that she obtained, without war, the evacuation of all the fortresses garrisoned by the Turkish troops on the Servian territory, including the fortress of Belgrade (1867). Garashanin was preparing a general rising of the Balkan nations

against the Turkish rule, and had entered into confidential arrangements with the Rumanians, Bosnians, Albanians, Bulgarians and Greeks, and more especially with Montenegro. But the execution of his plans was frustrated by his sudden resignation (at the end of 1867), and more especially by the assassination of Prince Michael a few months later (the 10th of June 1868). Although he was a Conservative in politics, and as such often in conflict with the leader of the Liberal movement, Yovan Ristich, he certainly was one of the ablest statesmen whom Servia had in the 19th century. (C. M.)

GARAT, DOMINIQUE JOSEPH (1749-1833), French writer and politician, was born at Bayonne on the 8th of September 1749. After receiving a good education under the direction of a relation who was a curé, and having been an advocate at Bordeaux, he came to Paris, where he obtained introductions to the most distinguished writers of the time, and became a contributor to the *Encyclopédie méthodique* and the *Mercur de France*. He gained considerable reputation by an *éloge* on Michel de L'Hôpital in 1778, and was afterwards three times crowned by the Academy for *éloges* on Suger, Montausier and Fontenelle. In 1785 he was named professor of history at the *Lyce*, where his lectures enjoyed an equal popularity with those of G. F. Laharpe on literature. Being chosen a deputy to the states-general in 1789, he rendered important service to the popular cause by his narrative of the proceedings of the Assembly contributed to the *Journal de Paris*. Possessing strongly optimistic views, a mild and irresolute character, and indefinite and changeable convictions, he played a somewhat undignified part in the great political events of the time, and became a pliant tool in carrying out the designs of others. Danton had him named minister of justice in 1792, and in this capacity had entrusted to him what he called the *commission africaine* of communicating to Louis XVI. his sentence of death. In 1793 he became minister of the interior. In this capacity he proved himself quite inefficient. Though himself uncorrupt, he winked at the most scandalous corruption in his subordinates, and in spite of the admirably organized detective service, which kept him accurately informed of every movement in the capital, he entirely failed to maintain order, which might easily have been done by a moderate display of firmness. At last, disgusted with the excesses which he had been unable to control, he resigned (August 15, 1793). On the 2nd of October he was arrested for Girondist sympathies but soon released, and he escaped further molestation owing to the friendship of Barras and, more especially, of Robespierre, whose literary *amour-propre* he had been careful to flatter. On the 9th Thermidor, however, he took sides against Robespierre, and on the 12th of September 1794 he was named by the Convention as a member of the executive committee of public instruction. In 1798 he was appointed ambassador to Naples, and in the following year he became a member, then president, of the Council of the Ancients. After the revolution of the 18th Brumaire he was chosen a senator by Napoleon and created a count. During the Hundred Days he was a member of the chamber of representatives. In 1803 he was chosen a member of the Institute of France, but after the restoration of Louis XVIII. his name was, in 1816, deleted from the list of members. After the revolution of 1830 he was named a member of the new Academy of Moral and Political Science. He died at Ustaritz near Bayonne, April 25, 1833. His writings are characterized by elegance, grace and variety of style, and by the highest kind of rhetorical eloquence; but his grasp of his subject is superficial, and as his criticisms have no root in fixed and philosophical principles they are not unfrequently whimsical and inconsistent. He must not be confounded with his elder brother Dominique (1735-1799), who was also a deputy to the states-general.

The works of Garat include, besides those already mentioned, *Considérations sur la Révolution Française* (Paris, 1792); *Mémoires sur la Révolution, ou exposé de ma conduite* (1795); *Mémoires sur la vie de M. Suard, sur ses écrits, et sur le XVIII^e siècle* (1820); *éloges* on Joubert, Kléber and Desaix; several notices of distinguished persons; and a large number of articles in periodicals. Valuable materials for the history of Garat's tenure of the ministry, notably the police reports of Dutard, are given in W. A. Schmidt's *Tribunes de la Révolution Française* (3 vols., Leipzig, 1867-1870).

GARAT, PIERRE-JEAN (1764-1823), French singer, nephew of Dominique Joseph Garat, was born in Bordeaux on the 25th of April 1764. Gifted with a voice of exceptional timbre and compass he devoted himself, from an early age, to the cultivation of his musical talents. On account of his manifesting a distaste for the legal profession, for which his father wished him to study, he was deprived of his allowance, but through the patronage of a friend he obtained the office of secretary to Comte d'Artois, and was afterwards engaged to give musical lessons to the queen of France. At the beginning of the Revolution he accompanied Rode to England, where the two musicians appeared together in concerts. He returned to Paris in 1794. After the Revolution he became a professional singer, and on account of a song which he had composed in reference to the misfortunes of the royal family he was thrown into prison. On regaining his liberty he went to Hamburg, where he at once achieved extraordinary success; and by his subsequent appearances in Paris, and his visits to Italy, Spain, Germany and Russia, he made for himself a reputation as a singer unequalled by any other of his own time. He was a keen partisan of Gluck in opposition to Handel. On the institution of the Conservatoire de Musique he became its professor of singing. He also composed a number of songs, many of which have considerable merit. He died on the 1st of March 1823 in Paris.

GARAY, JÁNOS (1812-1853), Hungarian poet and author, was born on the 10th of October 1812, at Szegszárd, in the county of Tolna. From 1823 to 1828 he studied at Fünfkirchen, and subsequently, in 1829, at the university of Pest. In 1834 he brought out an heroic poem, in hexameters, under the title *Csaldr*. After this he issued in quick succession various historical dramas, among which the most successful were *Arbács*, *Országh Ilona* and *Báthori Erzsébet*,—the first two published at Pest in 1837 and the last in 1840. Garay was an energetic journalist, and in 1838 he removed to Presburg, where he edited the political journal *Hírnök* (Herald). He returned to Pest in 1839, when he was elected a corresponding member of the Hungarian Academy of Sciences. In 1842 he was admitted into the Kistaludy Society, of which he became second secretary. Garay enriched Hungarian literature with numerous lyrical poems, ballads and tales. The first collection of his poems was published at Pest in 1843; and his prose tales appeared in 1845, under the title of *Tollrajzok* (Sketches with the Pen). His historical ballads and legends, styled *Arpádok* (Pest, 1847, 2nd ed. 1848), showed him to be a master in the art of ballad-writing. Some of his lyrical poems also are excellent, as, for example, *Balaton-i Kágyók* (Shells from the Balaton Lake) (Pest, 1848). His legend *Bosnyák Zsófia* (Pest, 1847), and his poetical romance *Frangepán Kristófni* (Christopher Frangepán's Wife) (Pest, 1846), gained the prize of the Kistaludy Society. His last and most famous work was an historical poem in twelve cantos, with the title *Szent László* (Saint Ladislaus) (Eger, 1852, 2nd ed., Pest, 1853, 3rd ed. 1863). Garay was professor of Hungarian language and literature to the university of Pest in 1848-1849. After about four years' illness he died on the 5th of November 1853, in great want. A collective edition of his poems was published at Pest the year after his death by F. Ney (2nd ed. 1860), and several of his poems were translated by Kerbeny.

See *Garay János Összes költeményei* (2nd ed., Pest, 1860); and *Dichtungen von Johann Garay* (2nd ed., Vienna, 1856).

GARBLE (a word derived from the Arab. *gharbala*, to sift, and related to *ghirbal*, a sieve; the Arabic words are of foreign origin, probably from the Lat. *cribrum*, a sieve), originally a medieval commercial term in the Mediterranean ports, meaning to sort out, or to sift merchandize, such as corn, spices, &c., in order to separate what was good from the refuse or waste; hence to select the best of anything for retention. Similarly a "garbler" was an official who was appointed to sort out, or test the work of those who had already sorted, the spices or drugs offered for sale in the London markets. In this original sense the word is now obsolete, but by inversion, or rather perversion, "garble" now means to sort out or select, chiefly from books or other literary works, or from public speeches, some portion which twists, mutilates, or renders ineffective the meaning of the author or speaker.

GARÇÃO, PEDRO ANTONIO JOAQUIM CORRÊA (1724-1772), Portuguese lyric poet, was the son of Philippe Corrêa da Serra, a *fidalg*o of the royal house who held an important post in the foreign office; his mother was of French descent. The poet's health was frail, and after going through a Jesuit school in Lisbon and learning English, French and Italian at home, he proceeded in 1742 to the university of Coimbra with a view to a legal career. He took his degree in 1748, and two years later was created a knight of the Order of Christ. In 1751 his marriage with D. Maria Salema brought him a rich dowry which enabled him to live in ease and cultivate letters; but in later years a law-suit reduced him to poverty. From 1760 to 1762 he edited the *Lisbon Gazette*. In 1756, in conjunction with Cruz e Silva and others, Garçãõ founded the *Arcadia Lusitana* to reform the prevailing bad taste in literature, identified with *Seicentismo*, which delighted in conceits, windy words and rhetorical phrases. The *Arcadia* fulfilled its mission to some extent, but it lacked creative power, became dogmatic, and ultimately died of inanition. Garçãõ was the chief contributor to its proceedings, bearing the name of "Corydon Erimantheo;" and his orations and dissertations, with many of his lyrics, were pronounced and read at its meetings. He lived much in the society of the English residents in Lisbon, and he is supposed to have conceived a passion for an English married lady which completely absorbed him and contributed to his ruin. In the midst of his literary activity and growing fame, he was arrested on the night of the 9th of April 1771, and committed to prison by Pombal, whose displeasure he had incurred by his independence of character. The immediate cause of his incarceration would appear to have been his connexion with a love intrigue between a young friend of his and the daughter of a Colonel Elsdon, but he was never brought to trial, and the matter must remain in doubt. After much solicitation, his wife obtained from the king an order for her husband's release on the 10th of November 1772, but it came too late. Broken by infirmities and the hardships of prison life, Garçãõ expired that very day in the Linoeiro, at the age of forty-seven.

Taking Horace as his model, and aided by sound judgment, scholarship and wide reading, Garçãõ set out to raise and purify the standard of poetical taste, and his verses are characterized by a classical simplicity of form and expression. His sonnets *ad sodales* show a charming personality; his vigorous and elegant odes and epistles are sententious in tone and reveal an inspired poet and a man chastened by suffering. His two comedies in hendecasyllables, the *Theatro Novo* (played in January 1766) and the *Assembêa*, are excellent satires on the social life of the capital; and in the *Cantata de Dido*, included in the latter piece, the spirit of Greek art is allied to perfection of form, making this composition perhaps the gem of Portuguese 18th century poetry.

Garçãõ wrote little and spent much time on the *labor limae*. His works were published posthumously in 1778, and the most complete and accessible edition is that of J. A. de Azevedo Castro (Rome, 1888). An English version of the *Cantata de Dido* appeared in the *Academy* (January 19th, 1895). See Innocencio da Silva, *Diccionario bibliographico Portuguez*, vol. vi. pp. 386-393, and vol. xvii. pp. 182-184; also Dr Theophilus Braga, *A Arcadia Lusitana* (Oporto, 1899). (E. PR.)

GARCIA (DEL POPOLO VICENTO), MANOEL (1775-1832), Spanish singer and composer, was born in Seville on the 22nd of January 1775. He became a chorister at the cathedral of Seville, and studied music under the best masters of that city. At seventeen he made his debut on the stage at Cadiz, in an operetta, in which were included songs of his own composition. Soon afterwards he appeared at Madrid in the twofold capacity of singer and composer. His reputation being established, he proceeded to Paris, where he appeared for the first time, in 1808, in Paer's opera *Griselda*. Here also he was received with great applause, his style of singing being especially appreciated. This he further improved by careful study of the Italian method in Italy itself, where he continued his successes. His opera *Il Califò di Bagdad* was favourably received at Naples in 1812, but his chief successes were again due to his perfection as a vocalist. His opera *La Morte di Tasso* was produced in 1821 in Paris, where it was

followed in 1823 by his *Il Fossolotto*. In 1824 he went to London, and thence proceeded to America (1825) with a company of artistes, amongst whom were his son Manoel and his daughter Maria, better known under her subsequent name of Malibran. In New York was produced his opera *La Figlia dell' ario* in 1827. He extended his artistic tour as far as Mexico, and was on the point of returning to Europe in order to retire from public life when he was robbed of his well-earned wealth by brigands on his way to Vera Cruz. Settled again in Paris in 1829, he soon retired from the stage, and devoted himself exclusively to teaching. He died in Paris on the 2nd of June 1832. His method of teaching was famous, and some of the most celebrated singers of the early part of the century were amongst his pupils. He also wrote an excellent book on the art of singing called *Metodo di canto*, of which the essence was subsequently incorporated by his son Manoel in his admirable *Traité complet de l'art du chant* (1847). His operas have not survived their day. He wrote nearly forty in all, but with the exception of those quoted, and *El Poeta calculista*, produced when he was thirty, none are remarkable. Besides the children already mentioned, his daughter Paulina, Madame Viardot (1821-1910), worthily continued the tradition for the best singing with which his name had become associated.

His son, **MANOEL GARCIA** (1805-1906), who celebrated his hundredth birthday in London on the 17th of March 1905, was born at Madrid, and after his father's death devoted himself to teaching. He was a professor at the Paris Conservatoire from 1830 to 1848, from that time to 1895 was a professor at the Royal Academy of Music in London. He became famous for his invention of the laryngoscope about 1850, apart from his position as the greatest representative of the old "*bel canto*" style of singing.

GARCÍA DE LA HUERTA, VICENTE ANTONIO (1734-1787), Spanish dramatist, was born at Zafrá on the 9th of March 1734, and was educated at Salamanca. At Madrid he soon attracted attention by his literary arrogance and handsome person; and at an early age became chief of the National Library, a post from which he was dismissed owing to the intrigues of his numerous enemies. The publication of his unsatisfactory collection of Spanish plays entitled *Theatro Ilcespanol* (1785-1786) exposed him to severe censures, which appear to have affected his reason. He died at Madrid on the 12th of March 1787, without carrying into effect his avowed intention of reviving the national drama. His *Agamemnon vengado* derives from Sophocles, his *Jaire* is translated from Voltaire, and even his once famous *Raquel*, though Spanish in subject, is classic in form.

GARCÍA DE PAREDES, DIEGO (1466-1534), Spanish soldier and duellist, was a native of Trujillo in Estremadura, Spain. He never commanded an army or rose to the position of a general, but he was a notable figure in the wars of the end of the 15th and beginning of the 16th century, when personal prowess had still a considerable share in deciding the result of actions. His native town and its district, which lie between Talavera and Madrid, produced many of the most noted *conquistadores* of America, including the Pizarro family. Diego himself served in his youth in the war of Granada. His strength, daring and activity fitted him to shine in operations largely composed of night marches, escalades, surprises and hand-to-hand combats. The main scene of his achievements was in Italy, and he betook himself to it—on his own showing—not in search of glory, but because he had killed a relation of his own, Ruy Sanchez de Vargas, in a street fight arising out of a quarrel about a horse. He fled to Rome, then under the rule of the Borgias. Diego was a distant relation to the cardinal of Santa Cruz (Carvajal), a favourite with Pope Alexander VI., who was in conflict with the barons of the Romagna and took Diego into his service. He remained a soldier of the pope till he killed a man in a personal quarrel and found it necessary to pass over to the enemy. Now he became acquainted with the Colonnas, who appreciated his services. The wars between Ferdinand V. of Aragon (the Catholic king) and Louis XII. gave him a more creditable opening. The Spanish general Gonsalvo de Córdoba, who knew his value, employed him and trusted him; and he took part in all the wars of Italy on the

frontier of Navarre, and once against the Turks on the Danube, till 1530. His countrymen made him the hero of many Münchhausen-like stories of personal prowess. It was said that he held a bridge single-handed against 200 Frenchmen, that he stopped the wheel of a water-mill, and so forth. In the "Brief Summary" of his life and deeds attributed to him, and printed at the end of the *Chronicle of the Great Captain*, published in 1584 at Alcalá de Henares, he lays no claim to having done more than was open to a very athletic man. He was killed at Bologna in 1534 by a fall while engaged in a jumping-match with some of the younger officers of the army. His body was carried to his native town Trujillo, and buried in the church of Santa Maria Mayor in 1545.

GARCÍA GUTIÉRREZ, ANTONIO (1812-1884), Spanish dramatist, was born at Chiclana (Cádiz) on the 5th of July 1812, and studied medicine in his native town. In 1832 he removed to Madrid, and earned a scanty living by translating plays of Scribe and the elder Dumas; despairing of success, he was on the point of enlisting when he suddenly sprang into fame as the author of *El Trovador*, which was played for the first time on the 1st of March 1836. García Gutiérrez never surpassed this first effort, which placed him among the leaders of the romantic movement in Spain, and which became known all over Europe through Verdi's music. His next great success was *Simón Bocanegra* (1843), but, as his plays were not lucrative, he emigrated to Spanish America, working as a journalist in Cuba and Mexico till 1850, when he returned to Spain. The best works of his later period are a *zarzuela* entitled *El Grumete* (1853), *La Venganza catalana* (1864) and *Juan Lorenzo* (1865). He became head of the archaeological museum at Madrid, and died there on the 6th of August 1884. His *Poemas* (1840) and another volume of lyrics, entitled *Luz y tinieblas* (1842), are unimportant; but the brilliant versification of his plays, and his power of analysing feminine emotions, give him a foremost place among the Spanish dramatists of the 19th century.

GARDA, a department in the south of France, consisting of part of the old province of Languedoc. Pop. (1906) 421,166. Area 2270 sq. m. It is bounded N. by the departments of Lozère and Ardèche, E. by the Rhone, which separates it from Vaucluse and Bouches-du-Rhône, S. by the Mediterranean, S.W. by Hérault and W. by Aveyron. Gard is divided into three sharply-defined regions. Its north-western districts are occupied by the range of the Cévennes, which on the frontier of Lozère attain a height of 5120 ft. The whole of this region is celebrated for its fruitful valleys, its gorges, its beautiful streams, its pastures, and the chestnut, mulberry and other fruit trees with which the mountains are often clothed to their summits. The Garrigues, a dry, hilly region of limestone, which lends itself to the cultivation of cereals, the vine and olive, stretches from the foot of the Cévennes over the centre of the department, covering about half its area. The southern portion, which extends to the sea, and was probably at one time covered by it, is a low plain with numerous lakes and marshes. Though unhealthy, it is prosperous, and comprises the best arable land and vineyards in Gard.

Besides the Rhone, which bounds the department on the E., and the Ardèche, the lower course of which forms part of its boundary on the N., the principal rivers are the Cèze, Gard, Vidourle and Hérault. The most northern of these is the Cèze, which rises in the Cévennes, and after a course of about 50 m. in an E.S.E. direction falls into the Rhone above Roquemaure. The Gard, or Gardon, from which the department takes its name, is also an affluent of the Rhone, and, rising in the Cévennes from several sources, traverses the centre of the department, having a length of about 60 m. In the upper part of its course it flows through a succession of deep mountain gorges, and from the melting of the snows on the Cévennes is subject to inundations, which often cause great damage. Its waters not infrequently rise 18 or 20 ft. in a few hours, and its bed is sometimes increased in width to nearly a mile. Near Remoulins it is crossed by a celebrated Roman aqueduct—the Pont du Gard (see AQUEDUCT). The Vidourle flows in a S.S.E. direction from its source near Le Vigan, and after a course of about 50 c., falls into the sea. Below

Sommières it forms the western boundary of the department. The Hérault has its source and part of its course in the west of Gard. The Canal de Beaucaire extends from the Rhone at Beaucaire to Aigues-Mortes, which communicates with the Mediterranean at Grau-du-Roi by means of the Grand-Roubine canal.

The climate is warm in the south-east, colder in the north-west; it is rather changeable, and rain-storms are common. The cold and violent north-west wind known as the mistral is its worst drawback. Les Fumades (near Allègre) and Euzet have mineral springs. The chief grain crops are wheat and oats. Rye, barley and potatoes are also grown. Gard is famed for its cattle, its breed of small horses, and its sheep, the wool of which is of a very fine quality. In the rearing of silk-worms it ranks first among French departments. The principal fruit trees are the olive, mulberry and chestnut. The vine is extensively cultivated and yields excellent red and white wines. The department is rich in minerals, and the mines of coal, iron, lignite, asphalt, zinc, lead and copper, which are for the most part situated in the neighbourhoods of Alais and La Grand-Combe, constitute one of the chief sources of its wealth. Great quantities of salt are obtained from the salt marshes along the coast. The quarries of building and other stone employ a considerable number of workmen. The fisheries are productive. The manufactures are extensive, and include those of silk, of which Alais is the chief centre, cotton and woollen fabrics, hosiery, ironware, hats (Anduze), liquoric, gloves, paper, leather, earthenware and glass. There are also breweries and distilleries, and important metallurgical works, the chief of which are those of Besseges. The exports of Gard include coal, lignite, coke, asphalt, building-stone, iron, steel, silk, hosiery, wine, olives, grapes and truffles.

The department is served by the Paris-Lyon railway. It is divided into the arrondissements of Nîmes, Alais, Uzès and Le Vigan, with 40 cantons and 351 communes. The chief town is Nîmes, which is the seat of a bishopric of the province of Avignon and of a court of appeal. Gard belongs to the 15th military region, which has its headquarters at Marseilles, and to the académie (educational division) of Montpellier. Nîmes, Alais, Uzès, Aigues-Mortes, Beaucaire, Saint-Gilles, Besseges, La Grand-Combe and Villeneuve-lès-Avignon are the principal places. Opposite the manufacturing town of Pont-St-Esprit the Rhone is crossed by a fine medieval bridge more than 1000 yds. long built by the Pontiff brethren. Le Vigan, an ancient town with several old houses, carries on silk-spinning.

GARDA, LAKE OF (the *Lacus Benacus* of the Romans), the most easterly and the most extensive of the great Lombard lakes, being only surpassed in the Alpine region by those of Geneva and Constance. Save the extreme northern extremity (Riva, which was secured from Venice by Tirol in 1517), the whole lake is Italian, being divided between the provinces of Verona and Brescia. Its broad basin orographically represents the southern portion of the valley of the Adige, though that river now flows through a narrow trench which is separated from the lake by the long narrow ridge of the Monte Baldo (7277 ft.). Nowadays the lake is fed by the Sarca, that flows in at its north end from the glaciers of the Adamello, while at the southern extremity of the lake the Mincio flows out, on its way to join the Po. The area of the lake is about 143 sq. m., its length is 32 m., its greatest breadth is about 10 m., the height of its surface above sea-level is 216 ft. and the greatest depth yet measured is 1916 ft. Its upper or northern end is narrow, but between Garda (E.) and Salò (W.) the lake expands gradually into a nearly circular basin, which at the southern extremity is divided into two parts by the long low promontory of Sermione, that projects from the southern shore between Peschiera and Desenzano. Owing to this conformation the lake is much exposed to sudden and violent winds, which Virgil alludes to in his well-known line (*Georg.* ii. line 160): *fluctibus et fremitu assurgens, Benace, marina*. The most dangerous of these winds is the *Borea* or *Suer*, that sweeps down from the north as through a funnel. In the southern portion of the lake the *Vinassa*, an E.S.E. wind, is most dreaded. The *Ora* is a regular wind coming from the east which, on reaching the

lake, blows from S. to N. The steep grey limestone crags of Monte Baldo, on the eastern side of the lake, contrast strongly with the rich vegetation on the western and southern shores. The portion of the western shore that extends from Gargnano to Salò is the most sheltered and warmest part of the region, so that not merely does it resemble one continuous garden (producing lemons, figs, mulberries, olives, &c.), but is frequented in winter, and has been given the name of the *Riviera Benacense*. The lovely promontory of Sermione, at the southern end of the lake, has also an extremely luxuriant vegetation, while it contains many remains of buildings of Roman and later date, having been the Sirmio of Catullus, who resided here and celebrated its beauties in many of his poems. In 1827 a boat with paddles set in motion by horses was put on the lake, but the first steamer dates only from 1844. At the south end of the lake, E. and W. respectively of the promontory of Sermione, are the towns of Peschiera (14½ m. by rail from Verona on the east) and of Desenzano (17½ m. by rail from Brescia on the west), which are 8½ m. distant from each other. On the west shore of the lake are Salò, Toscolano, Gargnano and Limone, while the rugged east shore can boast only of Bardolino and Garda. At the northern tip of the lake, and in Tirol, is Riva, the most considerable town on the lake, and 15½ m. by rail from the Mori station on the main Brenner line. (W. A. B. C.)

GARDANE, CLAUDE MATTHIEU, Count (1766-1818), French general and diplomatist, was born on the 30th of January 1766. He entered the army and rose rapidly during the revolutionary wars, becoming captain in 1793. In May 1799 he distinguished himself by saving a division of the French army which was about to be crushed by the Russians at the battle of Bassignana, and was named at once brigadier-general by Moreau. He incurred Napoleon's displeasure for an omission of duty shortly before the battle of Marengo (June 14th, 1800), but in 1805 was appointed to be aide-de-camp of the emperor. His chief distinction, however, was to be won in the diplomatic sphere. In the spring of 1807, when Russia and Prussia were at war with France, and the emperor Alexander I. of Russia was also engaged in hostilities with Persia, the court of Teheran sent a mission to the French emperor, then at the castle of Finkenstein in the east of Prussia, with a view to the conclusion of a Franco-Persian alliance. This was signed on the 4th of May 1807, at that castle; and Napoleon designed Gardane as special envoy for the cementing of that alliance. The secret instructions which he drew up for Gardane, and signed on the 30th of May, are of interest as showing the strong oriental trend of the emperor's policy. France was to guarantee the integrity of Persia, to recognize that Georgia (then being invaded by the Russians) belonged to the shah, and was to make all possible efforts for restoring that territory to him. She was also to furnish to the shah arms, officers and workmen, in the number and to the amount demanded by him. Napoleon on his side required Persia to declare war against Great Britain, to expel all Britons from her territory, and to come to an understanding with the Afghans with a view to a joint Franco-Perso-Afghan invasion of India. Gardane, whose family was well known in the Levant, had a long and dangerous journey overland, but was cordially received at Teheran in December 1807. The conclusion of the Franco-Russian treaty at Tilsit in July 1807 rendered the mission abortive. Persia longed only for help against Russia and had no desire, when all hope of that was past, to attack India. The shah, however, promised to expel Britons and to grant to France a commercial treaty. For a time French influence completely replaced that of England at Teheran, and the mission of Sir John Malcolm to that court was not allowed to proceed. Finally, however, Gardane saw that nothing much was to be hoped for in the changed situation of European affairs, and abruptly left the country (April 1809). This conduct was not wholly approved by Napoleon, but he named him count and in 1810 attached him to Masséna's army in Portugal. There, during the disastrous retreat from Santarém to Almeida, he suffered a check which brought him into disfavour. The rest of his career calls for no notice. He died in 1818. The report which he sent to Cham-

pagny (dated April 23rd, 1809) on the state of Persia and the prospects of a successful invasion of India is of great interest. He admitted the difficulties of this enterprise, but thought that a force of picked French troops, aided by Persians and Afghans, might under favourable conditions penetrate into India by way of Kandahar, or through Sind, especially if the British were distracted by maritime attacks from Mauritius.

See Count Alfred de Gardane, *Mission du général Gardane en Perse* (Paris, 1865); and P. A. L. de Driault, *La Politique orientale de Napoléon: Sébastiani et Gardane* (Paris, 1904). (J. H. L.)

GARDELEGEN, a town of Germany, in Prussian Saxony, on the right bank of the Milde, 20 m. W. from Stendal, on the main line of railway Berlin-Hanover. Pop. (1905) 8193. It has a Roman Catholic and three Evangelical churches, a hospital, founded in 1285, and a high-grade school. There are considerable manufactures, notably agricultural machinery and buttons, and its beer has a great repute. Gardelegen was founded in the 10th century, and was for a long time the seat of a line of counts. It suffered considerably in the Thirty Years' War, and in 1775 was burned by the French. On the neighbouring heath Margrave Louis I. of Brandenburg gained, in 1343, a victory over Otto the Mild of Brunswick.

GARDEN (from O. Fr. *gardin*, mod. Fr. *jardin*; this, like our words "garth," a paddock attached to a building, and "yard," comes from a Teutonic word for an enclosure which appears in Gothic as *gards* and O. H. Ger. *gart*, cf. Dutch *gaard* and Ger. *garten*), the ground enclosed and cultivated for the growth of fruit, flowers or vegetables (see **HORTICULTURE**). The word is also used for grounds laid out ornamentally, used as places of public entertainment. Such were the famous Ranelagh and Vauxhall Gardens in London; it is similarly used in zoological gardens, and as a name in towns for squares, terraces or streets. From the fact that Epicurus (*q.v.*) taught in the gardens at Athens, the disciples of his school of philosophy were known as *oi áro tów κήπων* (so Diog. Laërtius x. 10); and Cicero (*De finibus* v. 1. 3, and elsewhere) speaks of the *Horti Epicuri*. Thus as the "Academy" refers to the Platonic and the "Porch" (*σκολή*) to the Stoic school, so the "Garden" is the name given to the Epicurean school of philosophy. Apollodorus was known as *κηροκόπος*, the tyrant of the garden.

GARDENIA, in botany, a genus of the natural order Rubiaceae, containing about sixty species of evergreen trees and shrubs, natives of the warmer parts of the old world. Several are grown in stoves or greenhouses for their handsome, sweet-scented white flowers. The flowers are developed singly at the end of a branch or in the leaf-axils, and are funnel- or salver-shaped with a long tube. The double forms of *Gardenia florida* (a native of China) and *G. radicans* (a native of Japan) are amongst the most beautiful and highly perfumed of any in cultivation. Gardenias are grown chiefly for cut flowers, and are readily propagated by cuttings. They require plenty of heat and moisture in the growing season, and must be kept free from insects such as the mealy bug, green fly, red spider and scale-insect.

GARDINER, JAMES (1688-1745), Scottish soldier, was born at Carriden in Linlithgowshire, on the 11th of January 1688. At the age of fourteen he entered a Scottish regiment in the Dutch service, and was afterwards present at the battle of Ramillies, where he was wounded. He subsequently served in different cavalry regiments, and in 1730 was advanced to the rank of lieutenant-colonel, and in 1743 to that of colonel. He fell at the battle of Prestonpans, the 21st of September 1745. The circumstances of his death are described in Sir Walter Scott's *Waverley*. In his early years he was distinguished for his recklessness and profligacy, but in 1719 a supernatural vision, as he regarded it, led to his conversion, and from that time he lived a life of great devoutness and of thorough consistency with his Christian profession. Dr Alexander Carlyle of Inveresk, author of an autobiography, says that he was "very ostentatious" about his conversion—speaks of him as weak, and plainly thinks there was a great deal of delusion in Col. Gardiner's account of his sins.

His life was written by Dr Philip Doddridge and has been often reprinted.

GARDINER, SAMUEL RAWSON (1829-1902), English historian, son of Rawson Boddam Gardiner, was born near Alesford, Hants, on the 4th of March 1829. He was educated at Winchester and Christ Church, Oxford, where he obtained a first class in *literae humaniores*. He was subsequently elected to fellowships at All Souls (1884) and Merton (1892). For some years he was professor of modern history at King's College, London, and devoted his life to historical work. He is the historian of the Puritan revolution, and has written its history in a series of volumes, originally published under different titles, beginning with the accession of James I.; the seventeenth (the third volume of the *History of the Commonwealth and Protectorate*) appeared in 1901. This was completed in two volumes by C. H. Fifth as *The Last Years of the Protectorate* (1909). The series is *History of England from the Accession of James I. to the Outbreak of the Civil War, 1603-1642* (10 vols.); *History of the Great Civil War, 1642-1649* (4 vols.); and *History of the Commonwealth and Protectorate, 1649-1660*. His treatment is exhaustive and philosophical, taking in, along with political and constitutional history, the changes in religion, thought and sentiment during his period, their causes and their tendencies. Of the original authorities on which his work is founded many of great value exist only in manuscript, and his researches in public and private collections of manuscripts at home, and in the archives of Simancas, Venice, Rome, Brussels and Paris, were indefatigable and fruitful. His accuracy is universally acknowledged. He was perhaps drawn to the Puritan period by the fact of his descent from Cromwell and Ireton, but he has certainly written of it with no other purpose than to set forth the truth. In his judgments of men and their actions he is unbiassed, and his appreciations of character exhibit a remarkable fineness of perception and a broad sympathy. Among many proofs of these qualities it will be enough to refer to what he says of the characters of James I., Bacon, Laud, Strafford and Cromwell. On constitutional matters he writes with an insight to be attained only by the study of political philosophy, discussing in a masterly fashion the dreams of idealists and the schemes of government proposed by statesmen. Throughout his work he gives a prominent place to everything which illustrates human progress in moral and religious, as well as political conceptions, and specially to the rise and development of the idea of religious toleration, finding his authorities not only in the words and actions of men of mark, but in the writings of more or less obscure pamphleteers, whose essays indicate currents in the tide of public opinion. His record of the relations between England and other states proves his thorough knowledge of contemporary European history, and is rendered specially valuable by his researches among manuscript sources which have enabled him to expound for the first time some intricate pieces of diplomacy.

Gardiner's work is long and minute; the fifty-seven years which it covers are a period of exceptional importance in many directions, and the actions and characters of the principal persons in it demand careful analysis. He is perhaps apt to attach an exaggerated importance to some of the authorities which he was the first to bring to light, to see a general tendency in what may only be the expression of an individual eccentricity, to rely too much on ambassadors' reports which may have been written for some special end, to enter too fully into the details of diplomatic correspondence. In any case the length of his work is not the result of verbiage or repetitions. His style is clear, absolutely unadorned, and somewhat lacking in force; he appeals constantly to the intellect rather than to the emotions, and is seldom picturesque, though in describing a few famous scenes, such as the execution of Charles I., he writes with pathos and dignity. The minuteness of his narrative detracts from its interest; though his arrangement is generally good, here and there the reader finds the thread of a subject broken by the intrusion of incidents not immediately connected with it, and does not pick it up again without an effort. And Gardiner has the defects of his supreme qualities, of his fairness and critical ability as a judge of character; *his work lacks enthusiasm, and leaves the reader cold and unmoved. Yet, apart from its sterling excellence, it is not without*

beauties, for it is marked by loftiness of thought, a love of purity and truth, and refinement in taste and feeling. He wrote other books, mostly on the same period, but his great history is that by which his name will live. It is a worthy result of a life of unremitting labour, a splendid monument of historical scholarship. His position as an historian was formally acknowledged: in 1862 he was given a civil list pension of £150 per annum, "in recognition of his valuable contributions to the history of England"; he was honorary D.C.L. of Oxford, LL.D. of Edinburgh, and Ph.D. of Göttingen, and honorary student of Christ Church, Oxford; and in 1894 he declined the appointment of regius professor of modern history at Oxford, lest its duties should interfere with the accomplishment of his history. He died on the 24th of February 1902.

Among the more noteworthy of Gardiner's separate works are: *Prince Charles and the Spanish Marriage* (2 vols., London, 1869); *Constitutional Documents of the Puritan Revolution, 1625-1660* (1st ed., Oxford, 1889; 2nd ed., Oxford, 1899); *Oliver Cromwell* (London, 1901); *What Gunpowder Plot was* (London, 1897); *Outline of English History* (1st ed., London, 1887; 2nd ed., London, 1896); and *Student's History of England* (2 vols., 1st ed., London, 1890-1891; 2nd ed., London, 1891-1892). He edited collections of papers for the Camden Society; and from 1891 was editor of the *English Historical Review*. (W. HU.)

GARDINER, STEPHEN (c. 1493-1555), English bishop and lord chancellor, was a native of Bury St Edmunds. The date of his birth as commonly given, 1483, seems to be about ten years too early, and surmises which have passed current that he was some one's illegitimate child are of no authority. His father is now known to have been John Gardiner, a substantial cloth merchant of the town where he was born (see his will, printed in *Proceedings of the Suffolk Archaeological Institute*, 1. 329), who took care to give him a good education. In 1511 he, being then a lad, met Erasmus at Paris (Nichols's *Epistles of Erasmus*, ii. 12, 13). But he had probably already been to Cambridge, where he studied at Trinity Hall and greatly distinguished himself in the classics, especially in Greek. He afterwards devoted himself to the canon and civil law, in which subjects he attained so great a proficiency that no one could dispute his pre-eminence. He received the degree of doctor of civil law in 1520, and of canon law in the following year.

Ere long his abilities attracted the notice of Cardinal Wolsey, who made him his secretary, and in this capacity he is said to have been with him at More Park in Hertfordshire, when the conclusion of the celebrated treaty of the More brought Henry VIII. and the French ambassadors thither. It is stated, and with great probability, that this was the occasion on which he was first introduced to the king's notice, but he does not appear to have been actively engaged in Henry's service till three years later. In that of Wolsey he was undoubtedly acquired a very intimate knowledge of foreign politics, and in 1527 he and Sir Thomas More were named commissioners on the part of England in arranging a treaty with the French ambassadors for the support of an army in Italy against the emperor. That year he accompanied Wolsey on his important diplomatic mission to France, the splendour and magnificence of which are so graphically described by Cavendish. Among the imposing train who went with the cardinal—including, as it did, several noblemen and privy councillors—Gardiner alone seems to have been acquainted with the real heart of the matter which made this embassy a thing of such peculiar moment. Henry was then particularly anxious to cement his alliance with Francis I., and gain his co-operation as far as possible in the object on which he had secretly set his heart—a divorce from Catherine of Aragon. In the course of his progress through France he received orders from Henry to send back his secretary Gardiner, or, as he was called at court, Master Stevens, for fresh instructions; to which he was obliged to reply that he positively could not spare him as he was the only instrument he had in advancing the king's "secret matter." Next year Gardiner, still in the service of Wolsey, was sent by him to Italy along with Edward Fox, provost of King's College, Cambridge, to promote the same business with the pope. His despatches on this occasion are still extant, and whatever we may think of the cause on which he was engaged, they certainly give a wonderful impression of the

zeal and ability with which he discharged his functions. Here his perfect familiarity with the canon law gave him a great advantage. He was instructed to procure from the pope a decretal commission, laying down principles of law by which Wolsey and Campeggio might hear and determine the cause without appeal. The demand, though supported by plausible pretences, was not only unusual but clearly inadmissible. Clement VII. was then at Orvieto, and had just recently escaped from captivity at St Angelo at the hands of the imperialists. But fear of offending the emperor could not have induced him to refuse a really legitimate request from a king like Henry. He naturally referred the question to the cardinals about him; with whom Gardiner held long arguments, enforced, it would seem, by not a little browbeating of the College. What was to be thought, he said, of a spiritual guide, who either could not or would not show the wanderer his way? The king and lords of England would be driven to think that God had taken away from the Holy See the key of knowledge, and that pontifical laws which were not clear to the pope himself might as well be committed to the flames.

This ingenious pleading, however, did not serve, and he was obliged to be content with a general commission for Campeggio and Wolsey to try the cause in England. This, as Wolsey saw, was quite inadequate for the purpose in view; and he again instructed Gardiner, while thanking the pope for the commission actually granted, to press him once more by very urgent pleas, to send the desired decretal on, even if the latter was only to be shown to the king and himself and then destroyed. Otherwise, he wrote, he would lose his credit with the king, who might even be tempted to throw off his allegiance to Rome altogether. At last the pope—to his own bitter regret afterwards—gave what was desired on the express conditions named, that Campeggio was to show it to the king and Wolsey and no one else, and then destroy it, the two legates holding their court under the general commission. After obtaining this Gardiner returned home; but early in the following year, 1529, when proceedings were delayed on information of the brief in Spain, he was sent once more to Rome. This time, however, his efforts were unavailing. The pope would make no further concessions, and he would not even promise not to revoke the cause at Rome, as he did very shortly after.

Gardiner's services, however, were fully appreciated. He was appointed the king's secretary. He had been already some years archdeacon of Taunton, and the archdeaconry of Norfolk was added to it in March 1529, which two years later he resigned for that of Leicester. In 1530 he was sent to Cambridge to procure the decision of the university as to the unlawfulness of marriage with a deceased brother's wife, in accordance with the new plan devised for settling the question without the pope's intervention. In this he succeeded, though not without a good deal of artifice, more creditable to his ingenuity than to his virtue. In November 1531 the king rewarded him for his services with the bishopric of Winchester, vacant by Wolsey's death. The promotion was unexpected, and was accompanied by expressions from the king which made it still more honourable, as showing that if he had been in some things too subservient, it was from no abject, self-seeking policy of his own. Gardiner had, in fact, ere this remonstrated boldly with his sovereign on some points, and Henry now reminded him of the fact. "I have often *squared* with you, Gardiner," he said familiarly, "but I love you never the worse, as the bishopric I give will convince you." In 1532, nevertheless, he excited some displeasure in the king by the part he took in the preparation of the famous "Answer of the Ordinaries" to the complaints brought against them in the House of Commons. On this subject he wrote a very manly letter to the king in his own defence.

His next important action was not so creditable; for he was, not exactly, as is often said, one of Cranmer's assessors, but, according to Cranmer's own expression, "assistant" to him as counsel for the king, when the archbishop, in the absence of Queen Catherine, pronounced her marriage with Henry null and void on the 23rd of May 1533. Immediately afterwards he was sent over to *Marseilles*, where an interview between the pope and

Francis I. took place in September, of which event Henry stood in great suspicion, as Francis was ostensibly his most cordial ally, and had hitherto maintained the justice of his cause in the matter of the divorce. It was at this interview that Bonner intimated the appeal of Henry VIII. to a general council in case the pope should venture to proceed to sentence against him. This appeal, and also one on behalf of Cranmer presented with it, were of Gardiner's drawing up. In 1535 he and other bishops were called upon to vindicate the king's new title of "Supreme Head of the Church of England." The result was his celebrated treatise *De vera obedientia*, the ablest, certainly, of all the vindications of royal supremacy. In the same year he had an unpleasant dispute with Cranmer about the visitation of his diocese. He was also employed to answer the pope's brief threatening to deprive Henry of his kingdom.

During the next few years he was engaged in various embassies in France and Germany. He was indeed so much abroad that he had little influence upon the king's councils. But in 1539 he took part in the enactment of the severe statute of the Six Articles, which led to the resignation of Bishops Latimer and Shaxton and the persecution of the Protestant party. In 1540, on the death of Cromwell, earl of Essex, he was elected chancellor of the university of Cambridge. A few years later he attempted, in concert with others, to fasten a charge of heresy upon Archbishop Cranmer in connexion with the Act of the Six Articles; and but for the personal intervention of the king he would probably have succeeded. He was, in fact, though he had supported the royal supremacy, a thorough opponent of the Reformation in a doctrinal point of view, and it was suspected that he even repented his advocacy of the royal supremacy. He certainly had not approved of Henry's general treatment of the church, especially during the ascendancy of Cromwell, and he was frequently visited with storms of royal indignation, which he schooled himself to bear with patience. In 1544 a relation of his own, named German Gardiner, whom he employed as his secretary, was put to death for treason in reference to the king's supremacy, and his enemies insinuated to the king that he himself was of his secretary's way of thinking. But in truth the king had need of him quite as much as he had of Cranmer; for it was Gardiner, who even under royal supremacy, was anxious to prove that England had not fallen away from the faith, while Cranmer's authority as primate was necessary to upholding that supremacy. Thus Gardiner and the archbishop maintained opposite sides of the king's church policy; and though Gardiner was encouraged by the king to put up articles against the archbishop himself for heresy, the archbishop could always rely on the king's protection in the end. Heresy was gaining ground in high places, especially after the king's marriage with Catherine Parr; and there seems to be some truth in the story that the queen herself was nearly committed for it at one time, when Gardiner, with the king's approbation, censured some of her expressions in conversation. In fact, just after her marriage, four men of the Court were condemned at Windsor and three of them were burned. The fourth, who was the musician Marbeck, was pardoned by Gardiner's procurement.

Great as Gardiner's influence had been with Henry VIII., his name was omitted at the last in the king's will, though Henry was believed to have intended making him one of his executors: Under Edward VI. he was completely opposed to the policy of the dominant party both in ecclesiastical and in civil matters. The religious changes he objected to both on principle and on the ground of their being moved during the king's minority; and he resisted Cranmer's project of a general visitation. His remonstrances, however, were met by his own committal to the Fleet, and the visitation of his diocese was held during his imprisonment. Though soon afterwards released, it was not long before he was called before the council, and, refusing to give them satisfaction on some points, was thrown into the Tower; where he continued during the whole remainder of the reign, a period slightly over five years. During this time he in vain demanded his liberty, and to be called before parliament as a peer of the realm. His bishopric was taken from him and given to Dr

Poynet, a chaplain of Cranmer's who had not long before been made bishop of Rochester. At the accession of Queen Mary, the duke of Norfolk and other state prisoners of high rank were in the Tower along with him; but the queen, on her first entry into London, set them all at liberty. Gardiner was restored to his bishopric and appointed lord chancellor, and he set the crown on the queen's head at her coronation. He also opened her first parliament and for some time was her leading councillor.

He was now called upon, in advanced life, to undo not a little of the work in which he had been instrumental in his earlier years—to vindicate the legitimacy of the queen's birth and the lawfulness of her mother's marriage, to restore the old religion, and to recant what he himself had written touching the royal supremacy. It is said that he wrote a formal *Palinodia* or retraction of his book *De vera obedientia*, but it does not seem to be now extant; and the reference is probably to his sermon on Advent Sunday 1554, after Cardinal Pole had absolved the kingdom from schism. As chancellor he had the onerous task of negotiating the queen's marriage treaty with Philip, to which he shared the general repugnance, though he could not oppose her will. In executing it, however, he took care to make the terms as advantageous for England as possible, with express provision that the Spaniards should in no wise be allowed to interfere in the government of the country. After the coming of Cardinal Pole, and the reconciliation of the realm to the see of Rome, he still remained in high favour. How far he was responsible for the persecutions which afterwards arose is a debated question. He no doubt approved of the act, which passed the House of Lords while he presided there as chancellor, for the revival of the heresy laws. Neither is there any doubt that he sat in judgment on Bishop Hooper, and on several other preachers whom he condemned, not exactly to the flames, but to be degraded from the priesthood. The natural consequence of this, indeed, was that when they declined, even as laymen, to be reconciled to the Church, they were handed over to the secular power to be burned. Gardiner, however, undoubtedly did his best to persuade them to save themselves by a course which he conscientiously followed himself; nor does it appear that, when placed on a commission along with a number of other bishops to administer a severe law, he could very well have acted otherwise than he did. In his own diocese no victim of the persecution is known to have suffered till after his death; and, much as he was already maligned by opponents, there are strong evidences that his natural disposition was humane and generous. In May 1553 he went over to Calais as one of the English commissioners to promote peace with France; but their efforts were ineffectual. In October 1555 he again opened parliament as lord chancellor, but towards the end of the month he fell ill and grew rapidly worse till the 12th of November, when he died over sixty years of age.

Perhaps no celebrated character of that age has been the subject of so much ill-merited abuse at the hands of popular historians. That his virtue was not equal to every trial must be admitted, but that he was anything like the morose and narrow-minded bigot he is commonly represented there is nothing whatever to show. He has been called ambitious, turbulent, crafty, abject, vindictive, bloodthirsty and a good many other things besides, not quite in keeping with each other; in addition to which it is roundly asserted by Bishop Burnet that he was despised alike by Henry and by Mary, both of whom made use of him as a tool. How such a mean and abject character submitted to remain five years in prison rather than change his principles is not very clearly explained; and as to his being despised, we have seen already that neither Henry nor Mary considered him by any means despicable. The truth is, there is not a single divine or statesman of that day whose course throughout was so thoroughly consistent. He was no friend to the Reformation, it is true, but he was at least a conscientious opponent. In doctrine he adhered to the old faith from first to last, while as a question of church policy, the only matter for consideration with him was whether the new laws and ordinances were constitutionally justifiable.

His merits as a theologian it is unnecessary to discuss; it is as a statesman and a lawyer that he stands conspicuous. But his

learning even in divinity was far from commonplace. The part that he was allowed to take in the drawing up of doctrinal formularies in Henry VIII.'s time is not clear; but at a later date he was the author of various tracts in defence of the Real Presence against Cranmer, some of which, being written in prison, were published abroad under a feigned name. Controversial writings also passed between him and Bucer, with whom he had several interviews in Germany, when he was there as Henry VIII.'s ambassador.

He was a friend of learning in every form, and took great interest especially in promoting the study of Greek at Cambridge. He was, however, opposed to the new method of pronouncing the language introduced by Sir John Cheke, and wrote letters to him and Sir Thomas Smith upon the subject, in which, according to Ascham, his opponents showed themselves the better critics, but he the superior genius. In his own household he loved to take in young university men of promise; and many whom he thus encouraged became distinguished in after life as bishops, ambassadors and secretaries of state. His house, indeed, was spoken of by Leland as the seat of eloquence and the special abode of the muses.

He lies buried in his own cathedral at Winchester, where his effigy is still to be seen. (J. G.A.)

GARDINER, a city of Kennebec county, Maine, U.S.A., at the confluence of Cobbeosecontee river with the Kennebec, 6 m. below Augusta. Pop. (1890) 5401; (1900) 5501 (537 foreign-born); (1910) 5311. It is served by the Maine Central railway. The site of the city is only a few feet above sea-level, and the Kennebec is navigable for large vessels to this point; the water of the Cobbeosecontee, falling about 130 ft. in a mile, furnishes the city with good power for its manufactures (chiefly paper, machine-shop products, and shoes). The city exports considerable quantities of lumber and ice. Gardiner was founded in 1760 by Dr Sylvester Gardiner (1707-1786), and for a time the settlement was called Gardinerston; in 1779, when it was incorporated as a town, the founder being then a Tory, it was renamed Pittston. But in 1803, when that part of Pittston which lay on the W. bank of the Kennebec was incorporated as a separate town and new life was given to it by the grandson of the founder, the present name was adopted. Gardiner was chartered as a city in 1849. The town of Pittston, on the E. bank of the Kennebec, had a population of 1177 in 1900.

GARDNER, PERCY (1846-), English classical archaeologist, was born in London, and was educated at the City of London school and Christ's College, Cambridge (fellow, 1872). He was Disney professor of archaeology at Cambridge from 1880 to 1887, and was then appointed professor of classical archaeology at Oxford, where he had a stimulating influence on the study of ancient, and particularly Greek, art. He also became prominent as an historical critic on Biblical subjects. Among his works are: *Types of Greek Coins* (1883); *A Numismatic Commentary on Pausanias* (with F. Imhoof-Blumer, 1887); *New Chapters in Greek History* (1892), an account of excavations in Greece and Aisa Minor; *Manual of Greek Antiquities* (with F. B. Jevons, 2nd ed. 1898); *Grammar of Greek Art* (1905); *Exploratio Evangelica* (1899), on the origin of Christian belief; *A Historic View of the New Testament* (1901); *Growth of Christianity* (1907).

His brother, **ERNEST ARTHUR GARDNER** (1862-), educated at the City of London school and Caius College, Cambridge (fellow, 1883), is also well known as an archaeologist. From 1887 to 1895 he was director of the British School of Archaeology at Athens, and later became professor of archaeology at University College, London. His publications include: *Introduction to Greek Epigraphy* (1887); *Ancient Athens* (1902); *Handbook of Greek Sculpture* (1905); *Six Greek Sculptors* (1910). He was elected first Public Orator of London University in 1910.

GARDNER, a township of Worcester county, Massachusetts, U.S.A. Pop. (1890) 8424; (1900) 10,813, of whom 3449 were foreign-born; (1910 census) 14,699. The township is traversed by the Boston & Maine railway. It has an area of 21.4 sq. m. of hill country, well watered with streams and ponds, and includes the villages of Gardner (13 m. by rail W. of Fitchburg), South

Gardner and West Gardner. In the township are the state colony for the insane, the Henry Heywood memorial hospital, and the Levi Heywood memorial library (opened in 1886), a memorial to Levi Heywood (1800-1882), a prominent local manufacturer of chairs, who invented various kinds of chair-making machinery. By far the principal industry of the township (dating from 1805) is the manufacture of chairs, the township having in 1905 the largest chair factory in the world; among the other manufactures are toys, baby-carriages, silver-ware and oil stoves. In 1905 the total factory product of the township was valued at \$5,019,019, the furniture product alone amounting to \$4,267,064, or 85.2% of the total. Gardner, formed from parts of Ashburnham, Templeton, Westminster and Winchenden, was incorporated in 1785, and was named in honour of Col. Thomas Gardner (1724-1775), a patriot leader of Massachusetts, who was mortally wounded in the battle of Bunker Hill.

See W. D. Herrick, *History of the Town of Gardner* (Gardner, 1878), covering the years 1785-1878.

GARE-FOWL¹ (Icelandic, *Geirfugl*; Gaelic, *Gearbhul*), the anglicized form of the Hebridean name of a large sea-bird now considered extinct, formerly a visitor to certain remote Scottish islands, the Great Auk of most English book-writers, and the



Gare-Fowl, or Great Auk.

Alca impennis of Linnaeus. In size it was hardly less than a tame goose, and in appearance it much resembled its smaller and surviving relative the razor-bill (*Alca torda*); but the glossy black of its head was varied by a large patch of white occupying nearly all the space between the eye and the bill, in place of the razor-bill's thin whiteline, while the bill itself bore eight or more deep transverse grooves instead of the smaller number and the ivory-like mark possessed by the species last named. Otherwise the coloration was similar in both, and there is satisfactory evidence that the gare-fowl's winter-plumage differed from that of the breeding-season just as is ordinarily the case in other members of the family *Alcidae* to which it belongs. The most striking characteristic of the gare-fowl, however, was the comparatively abortive condition of its wings, the distal portions of

¹ The name first appears, and in this form, in the *Account of Hirta* (St Kilda) and *Rona, &c.*, by the lord register, Sir George M'Kenzie, of Tarbat, printed by Pinkerton in his *Collection of Voyages and Travels* (iii. p. 730), and then in Sibbald's *Scotia Illustrata* (1684). Martius soon after, in his *Voyage to St Kilda*, spelt it "Gairfowl." Sir R. Owen adopted the form "garfowl," without, as would seem, any precedent authority.

which, though the bird was just about twice the linear dimensions of the razor-bill, were almost exactly of the same size as in that species—proving, if more direct evidence were wanting, its inability to fly.

The most prevalent misconception concerning the gare-fowl is one which has been repeated so often, and in books of such generally good repute and wide dispersal, that a successful refutation seems almost hopeless. This is the notion that it was a bird possessing a very high northern range, and consequently to be looked for by Arctic explorers. How this error arose would take too long to tell, but the fact remains indisputable that, setting aside general assertions resting on no evidence worthy of attention, there is but a single record deserving any credit at all of a single example of the species having been observed within the Arctic Circle, and this, according to Prof. Reinhardt, who had the best means of ascertaining the truth, is open to grave doubt.² It is clear that the older ornithologists let their imagination get the better of their knowledge or their judgment, and their statements have been blindly repeated by most of their successors. Another error which, if not so widely spread, is at least as serious, since Sir R. Owen unhappily gave it countenance, is that this bird "has not been specially hunted down like the dodo and dinornis, but by degrees has become more scarce." If any reliance can be placed upon the testimony of former observers, the first part of this statement is absolutely untrue. Of the dodo all we know is that it flourished in Mauritius, its only abode, at the time the island was discovered, and that some 200 years later it had ceased to exist—the mode of its extinction being open to conjecture, and a strong suspicion existing that though indirectly due to man's acts it was accomplished by his thoughtless agents (*Phil. Trans.*, 1860, p. 354). The extinction of the *Dinornis* lies beyond the range of recorded history. Supposing it even to have taken place at the very latest period as yet suggested—and there is much to be urged in favour of such a supposition—little but oral tradition remains to tell us how its extirpation was effected. That it existed after New Zealand was inhabited by man is indeed certain, and there is nothing extraordinary in the proved fact that the early settlers (of whatever race they were) killed and ate moas. But evidence that the whole population of those birds was done to death by man, however likely it may seem, is wholly wanting. The contrary is the case with the gare-fowl. In Iceland there is the testimony of a score of witnesses, taken down from their lips by one of the most careful naturalists who ever lived, John Wolley, that the latest survivors of the species were caught and killed by expeditions expressly organised with the view of supplying the demands of caterers to the various museums of Europe. In like manner the fact is incontestable that its breeding-stations in the western part of the Atlantic were for three centuries regularly visited and devastated with the combined objects of furnishing food or bait to the fishermen from very early days, and its final extinction, according to Sir Richard Bonycastle (*Newfoundland in 1842*, i. p. 232), was owing to "the ruthless trade in its eggs and skin." There is no doubt that one of the chief stations of this species in Icelandic waters disappeared through volcanic action, and that the destruction of the old Geirfuglaskér drove some at least of the birds which frequented it to a rock nearer the mainland, where they were exposed to danger from which they had in their former abode been comparatively free; yet on this rock (Eldey=fire-island) they were "specially hunted down" whenever opportunity offered, until the stock there was wholly extirpated in 1844.

A third misapprehension is that entertained by John Gould in his *Birds of Great Britain*, where he says that "formerly this bird was plentiful in all the northern parts of the British Islands, particularly the Orkneys and the Hebrides. At the commencement of the 19th century, however, its fate appears to have been sealed; for though it doubtless existed, and probably bred, up to the year 1830, its numbers annually diminished until they became so few that the species could not hold its own." Now of the

² The specimen in the Museum of Copenhagen; the doubt lies as to the locality where it was obtained, whether at Disco, which is within, or at the Fiskerías, which is without, the Arctic Circle.

Orkneys, we know that George Low, who died in 1795, says in his posthumously-published *Fauna Orkadensis* that he could not find it was ever seen there; and on Bullock's visit in 1812 he was told, says Montagu (*Orn. Dict. App.*), that one male only had made its appearance for a long time. This bird he saw and unsuccessfully hunted, but it was killed soon after his departure, while its mate had been killed just before his arrival, and none have been seen there since. As to the Hebrides, St Kilda is the only locality recorded for it, and the last example known to have been obtained there, or in its neighbourhood, was that given to Fleming (*Edinb. Phil. Journ.* x. p. 96) in 1821 or 1822, having been some time before captured by Mr Maclellan of Glass. That the gare-fowl was not plentiful in either group of islands is sufficiently obvious, as also is the impossibility of its continuing to breed "up to the year 1830."

But mistakes like these are not confined to British authors. As on the death of an ancient hero myths gathered round his memory as quickly as clouds round the setting sun, so have stories, probable as well as impossible, accumulated over the true history of this species, and it behoves the conscientious naturalist to exercise more than common caution in sifting the truth from the large mass of error. Americans have asserted that the specimen which belonged to Audubon (now at Vassar College) was obtained by him on the banks of Newfoundland, though there is Macgillivray's distinct statement (*Brit. Birds*, v. p. 359) that Audubon procured it in London. The account given by Degland (*Orn. Europ.* ii. p. 529) in 1849, and repeated in the last edition of his work by M. Gerbe, of its extinction in Orkney, is so manifestly absurd that it deserves to be quoted in full: "Il se trouvait en assez grand nombre il y a une quinzaine d'années aux Orcades; mais le ministre presbytérien dans le Mainland, en offrant une forte prime aux personnes qui lui apportaient cet oiseau, a été cause de sa destruction sur ces îles." The same author claims the species as a visitor to the shores of France on the testimony of Hardy (*Annuaire normand*, 1841, p. 208), which he grievously misquotes both in his own work and in another place (*Naumannia*, 1855, p. 423), thereby misleading an anonymous English writer (*Nat. Hist. Rev.*, 1865, p. 475) and numerous German readers.

John Milne in 1875 visited Funk Island, one of the former resorts of the gare-fowl, or "penguin," as it was there called, in the Newfoundland seas, a place where bones had before been obtained by Stuvitz, and natural mummies so lately as 1863 and 1864. Landing on this rock at the risk of his life, he brought off a rich cargo of its remains, belonging to no fewer than fifty birds, some of them in size exceeding any that had before been known. His collection was subsequently dispersed, most of the specimens finding their way into various public museums.

A literature by no means inconsiderable has grown up respecting the gare-fowl. Neglecting works of general bearing, few of which are without many inaccuracies, the following treatises may be especially mentioned:—J. J. Steenstrup, "Et Bidrag til Geirflugens Naturhistorie og aeerligt til Kundskaben om dens tidligere Udbredningskreds," *Naturh. Foren. Vidensk. Meddelelser* (Copenhagen, 1855), p. 33; E. Charlton, "On the Great Auk," *Trans. Tyneside Nat. Field Club*, iv. p. 111; "Abstract of Mr J. Wolley's Researches in Iceland respecting the Gare-fowl," *Ibis* (1861), p. 374; W. Preyer, "Über *Plautus impennis*," *Journ. für Orn.* (1862), pp. 110, 337; K. E. von Baer, "Über das Aussterben der Tierarten in physiologischer und nicht physiologischer Hinsicht," *Bull. de l'Acad. Imp. de St-Petersb.* vi. p. 513; R. Owen, "Description of the Skeleton of the Great Auk," *Trans. Zool. Soc.* v. p. 317; "The Gare-fowl and its Historians," *Nat. Hist. Rev.* v. p. 467; J. H. Gurney, jun., "On the Great Auk," *Zoologist* (2nd ser.), pp. 1442, 1639; H. Reekes, "Great Auk in Newfoundland," &c., *op. cit.* p. 1854; V. Fatio, "Sur l'*Auca impennis*," *Bull. Soc. Orn. Suisse*, ii. pp. 1, 80, 147; "On existing Remains of the Gare-fowl," *Ibis* (1870), p. 256; J. Milne, "Relics of the Great Auk," *Field* (27th of March, 3rd and 10th of April 1875). Lastly, reference cannot be omitted to the happy exercise of poetic fancy with which Charles Kingsley was enabled to introduce the chief facts of the gare-fowl's extinction (derived from one of the above-named papers) into his charming *Water Babies*. (A. N.)

GARFIELD, JAMES ABRAM (1831–1881), twentieth president of the United States, was born on the 19th of November 1831 in a log cabin in the little frontier town of Orange, Cuyahoga county, Ohio. His early years were spent in the performance

of such labour as fell to the lot of every farmer's son in the new states, and in the acquisition of such education as could be had in the district schools held for a few weeks each winter. But life on a farm was not to his liking, and at sixteen he left home and set off to make a living in some other way. A book of stories of adventure on the sea, which he read over and over again when a boy, had filled him with a longing for a seafaring life. He decided, therefore, to become a sailor, and, in 1848, tramping across the country to Cleveland, Ohio, he sought employment from the captain of a lake schooner. But the captain drove him from the deck, and, wandering on in search of work, he fell in with a canal boatman who engaged him. During some months young Garfield served as bowsman, deck-hand and driver of a canal boat. An attack of the ague sent him home, and on recovery, having resolved to attend a high school and fit himself to become a teacher, he passed the next four years in a hard struggle with poverty and in an earnest effort to secure an education, studying for a short time in the Geauga Seminary at Chester, Ohio. He worked as a teacher, a carpenter and a farmer; studied for a time at the Western Reserve Eclectic Institute at Hiram, Ohio, which afterward became Hiram College, and finally entered Williams College. On graduation, in 1856, Garfield became professor of ancient languages and literature in the Eclectic Institute at Hiram, and within a year had risen to the presidency of the institution.

Soon afterwards he entered political life. In the early days of the Republican party, when the shameful scenes of the Kansas struggle were exciting the whole country, and during the campaigns of 1857 and 1858, he became known as an effective speaker and ardent anti-slavery man. His reward for his services was election in 1859 to the Ohio Senate as the member from Portage and Summit counties. When the "cotton states" seceded, Garfield appeared as a warm supporter of vigorous measures. He was one of the six Ohio senators who voted against the proposed amendment to the Federal Constitution (Feb. 28th, 1861) forbidding any constitutional amendment which should give Congress the power to abolish or interfere with slavery in any state; he upheld the right of the government to coerce seceded states; defended the "Million War Bill" appropriating a million dollars for the state's military expenses; and when the call came for 75,000 troops, he moved that Ohio furnish 20,000 soldiers and three millions of dollars as her share. He had just been admitted to the bar, but on the outbreak of war he at once offered his services to the governor, and became lieutenant-colonel and then colonel of the 42nd Ohio Volunteers, recruited largely from among his former students. He served in Kentucky, was promoted to the rank of brigadier-general of volunteers early in 1862; took part in the second day's fighting at the battle of Shiloh, served as chief of staff under Rosecrans in the Army of the Cumberland in 1863, fought at Chickamauga, and was made a major-general of volunteers for gallantry in that battle. In 1862 he was elected a member of Congress from the Ashtabula district of Ohio, and, resigning his military commission, took his seat in the House of Representatives in December 1863. In Congress he joined the radical wing of the Republican party, advocated the confiscation of Confederate property, approved and defended the Wade-Davis manifesto denouncing the tameness of Lincoln, and was soon recognized as a hard worker and ready speaker. Capacity for work brought him places on important committees—he was chairman successively of the committee on military affairs, the committee on banking and currency, and the committee on appropriations,—and his ability as a speaker enabled him to achieve distinction on the floor of the House and to rise to leadership. Between 1863 and 1873 Garfield delivered speeches of importance on "The Constitutional Amendment to abolish Slavery," "The Freedman's Bureau," "The Reconstruction of the Rebel States," "The Public Debt and Specie Payments," "Reconstruction," "The Currency," "Taxation of United States Bonds," "Enforcing the 14th Amendment," "National Aid to Education," and "the Right to Originate Revenue Bills." The year 1874 was one of disaster to the Republican party. The great

issue, the troubles growing out of reconstruction in the South, the *Crédit Mobilier* and the "Salary Grab," disgusted thousands of independent voters and sent a wave of Democracy over the country. Garfield himself was accused of corruption in connexion with the *Crédit Mobilier* scandal, but the charge was never proved. A Republican convention in his district demanded his resignation, and re-election seemed impossible; but he defended himself in two pamphlets, "Increase of Salaries" and "Review of the Transactions of the *Crédit Mobilier* Company," made a village-to-village canvass, and was victorious. In 1876 Garfield for the eighth time was chosen to represent his district; and afterwards as one of the two representatives of the Republicans in the House, he was a member of the Electoral Commission which decided the dispute regarding the presidential election of 1876. When, in 1877, James G. Blaine was made a senator from Maine, the leadership of the House of Representatives passed to Garfield, and he became the Republican candidate for speaker. But the Democrats had a majority in the House, and he was defeated. Hayes, the new president, having chosen John Sherman to be his secretary of the treasury, an effort was made to send Garfield to the United States Senate in Sherman's place. But the president needed his services in the House, and he was not elected to the Senate until 1880.

The time had now come (1880) when the Republican party must nominate a candidate for the presidency. General Grant had served two terms (1869-1877), and the unwritten law of custom condemned his being given another. But the "bosses" of the Republican party in three great States—New York, Pennsylvania and Illinois—were determined that he should be renominated. These men and their followers were known as the "stalwarts." Opposed to them were two other factions, one supporting James G. Blaine, of Maine, and the other John Sherman, of Ohio. When the convention met and the balloting began, the contest along these factional lines started in earnest. For eight-and-twenty ballots no change of any consequence was noticeable. Though votes were often cast for ten names, there were but two real candidates before the convention, Grant and Blaine. That the partisans of neither would yield in favour of the other was certain. That the choice therefore rested with the supporters of the minor candidates was manifest, and with the cry "Anything to beat Grant!" an effort was made to find some man on whom the opposition could unite. Such a man was Garfield. His long term of service in the House, his leadership of his party on its floor, his candidacy for the speakership, and his recent election to the United States Senate, marked him out as the available man. Between the casting of the first and the thirty-third ballot, Garfield, who was the leader of Sherman's adherents in the convention, had sometimes received one or two votes and at other times none. On the thirty-fourth he received seventeen, on the next fifty, and on the next almost the entire vote hitherto cast for Blaine and Sherman, and was declared nominated. During the campaign Garfield was subject to violent personal abuse; the fact that he was alleged to have received \$329 from the *Crédit Mobilier* as a dividend on stock led his opponents to raise the campaign cry of "329," and this number was placarded in the streets of the cities and printed in flaring type in partisan newspapers. The forged "Morey letter," in which he was made to appear as opposed to the exclusion of the Chinese, was widely circulated and injured his candidacy in the West. That the charges against Garfield were not generally credited, however, is shown by the fact that he received 214 electoral votes to his opponent's 155. He was inaugurated on the 4th of March 1881.

Unfortunately, the new president was unequal to the task of composing the differences in his party. For his secretary of state he chose James G. Blaine, the bitterest political enemy of Senator Roscoe Conkling (q.v.) the leader of the New York "stalwarts." Without consulting the New York senators, Garfield appointed William H. Robertson, another political enemy of Conkling's, to the desirable post of Collector of the Port of New York, and thereby destroyed all prospects of party harmony. On the 2nd of

July, while on his way to attend the commencement exercises at Williams College, the new president was shot in a Washington railway station by a disappointed office-seeker named Charles J. Guiteau, whose mind had no doubt been somewhat influenced by the abuse lavished upon the president by his party opponents; and on the 19th of September 1881, he died at Elberon, New Jersey, whither he had been removed on the 6th. He was buried in Cleveland, Ohio, where in 1890 a monument was erected by popular subscription to his memory.

In 1858 Garfield had married Miss Lucretia Rudolph, by whom he had seven children. His son, HARRY AUGUSTUS GARFIELD (b. 1863) graduated at Williams College in 1885, practised law in Cleveland, Ohio, in 1888-1903, was professor of politics at Princeton University in 1903-1908, and in 1908 became president of Williams College. Another son, JAMES RUDOLPH GARFIELD (b. 1865), also graduated at Williams College in 1885 and practised law in Cleveland; he was a Republican member of the Ohio Senate in 1896-1899, was commissioner of corporations, Department of Commerce and Labour, in 1903-1907, attracting wide attention by his reports on certain large industrial organizations, and was secretary of the interior (1907-1909) in the cabinet of President Roosevelt.

President Garfield's writings, edited by Burke A. Hinsdale, were published at Boston, in two volumes, in 1882. (J. B. McM.)

GAR-FISH, the name given to a genus of fishes (*Belone*) found in nearly all the temperate and tropical seas, and readily recognized by their long, slender, compressed and silvery body, and by their jaws being produced into a long, pointed, bony and sharply-toothed beak. About fifty species are known from different parts of the globe, some attaining to a length of 4 or 5 ft. One species is common on the British coasts, and is well known by the names of "long-nose," "green-bone," &c. The last name is given to those fishes on account of the peculiar green colour of their bones, which deters many people from eating them, although their flesh is well flavoured and perfectly wholesome. The skipper (*Scomberesox*) and half-beak (*Hemirhamphus*), in which the lower jaw only is prolonged, are fishes nearly akin to the gar-pikes.

GARGANEY¹ (North-Italian, *Garganello*), or **SUMMER-TEAL**, the *Avas querquedula* and *A. circia* of Linnaeus (who made, as did Willughby and Ray, two species out of one), and the type of Stephens's genus *Querquedula*. This bird is one of the smallest of the *Anatidae*, and has gained its common English name from being almost exclusively a summer-visitant to England where nowadays it only regularly resorts to breed in some of the East-Norfolk Broads, though possibly at one time it was found at the same season throughout the great Fen-district. Slightly larger than the common teal (*A. crecca*), the male is readily distinguished therefrom by its peculiarly-coloured head, the sides of which are nutmeg-brown, closely freckled with short whitish streaks, while a conspicuous white curved line descends backwards from the eyes. The upper wing-coverts are bluish grey, the scapulars black with a white shaft-stripe, and the wing-spot (*speculum*) greyish green bordered above and below by white. The female closely resembles the hen teal, but possesses no wing-spot. In Ireland or Scotland the garganey is very rare, and though it is recorded from Iceland, more satisfactory evidence of its occurrence there is needed. It has not a high northern range, and its appearance in Norway and Sweden is casual. Though it breeds in many parts of Europe, in none can it be said to be common; but it ranges far to the eastward in Asia—even to Formosa, according to Swinhoe—and yearly visits India in winter in enormous numbers. Those that breed in Norfolk arrive somewhat late in spring and make their nests in the vast reed-beds which border the Broads—a situation rarely or never chosen by the teal. The labyrinth or bony enlargement of the trachea in the male garganey differs in form from that described in any other drake, being more oval and placed nearly in the

¹ The word was introduced by Willughby from Gesner (*Oryz.*, lib. iii. p. 127), but, though generally adopted by authors, seems never to have become other than a book-name in English, the bird being invariably known in the parts of this island where it is indigenous as "summer-teal."

median line of the windpipe, instead of on one side, as is usually the case.

GARGANO, MONTE (anc. *Garganus Mons*), a massive mountainous peninsula projecting E. from the N. coast of Apulia, Italy, and belonging geologically to the opposite Dalmatian coast; it was indeed separated from the rest of Italy by an arm of the sea as late as the Tertiary period. The highest point (Monte Calvo) is 3465 ft. above sea-level. The oak forests for which it was renowned in Roman times have entirely disappeared.

GARGOYLE, or **GURGOYLE** (from the Fr. *gargonille*, originally the throat or gullet, cf. Lat. *gurgulio*, *gula*, and similar words derived from root *gur*, to swallow, the word representing the gurgling sound of water; Ital. *doccia di grande*; Ger. *Ausguss*), in architecture, the carved termination to a spout which conveys away the water from the gutters. Gargoyles are mostly grotesque figures. The term is applied more especially to medieval work, but throughout all ages some means of throwing the water off the roofs, when not conveyed in gutters, has been adopted, and in Egypt there are gargoyles to eject the water used in the washing of the sacred vessels which would seem to have been done on the flat roofs of the temples. In Greek temples the water from the roof passed through the mouths of lions whose heads were carved or modelled in the marble or terra-cotta cymatium of the cornice. At Pompeii large numbers of terra-cotta gargoyles have been found which were modelled in the shape of various animals.

GARHWAL, or **GURWAL**. 1. A district of British India, in the Kumaon division of the United Provinces. It has an area of 5629 sq. m., and consists almost entirely of rugged mountain ranges running in all directions, and separated by narrow valleys which in some cases become deep gorges or ravines. The only level portion of the district is a narrow strip of waterless forest between the southern slopes of the hills and the fertile plains of Rohilkhand. The highest mountains are in the north, the principal peaks being Nanda Devi (25,661 ft.), Kamet (25,413), Trisul (23,382), Badrinath (23,210), Dunagiri (23,181) and Kedarnath (22,853). The Alaknanda, one of the main sources of the Ganges, receives with its affluents the whole drainage of the district. At Devaprayag the Alaknanda joins the Bhagirathi, and thenceforward the united streams bear the name of the Ganges. Cultivation is principally confined to the immediate vicinity of the rivers, which are employed for purposes of irrigation. Garhwal originally consisted of 52 petty chieftainships, each chief with his own independent fortress (*garh*). Nearly 500 years ago, one of these chiefs, Ajai Pál, reduced all the minor principalities under his own sway, and founded the Garhwal kingdom. He and his ancestors ruled over Garhwal and the adjacent state of Tehri, in an uninterrupted line till 1803, when the Gurkhas invaded Kumaon and Garhwal, driving the Garhwal chief into the plains. For twelve years the Gurkhas ruled the country with a rod of iron, until a series of encroachments by them on British territory led to the war with Nepal in 1814. At the termination of the campaign, Garhwal and Kumaon were converted into British districts, while the Tehri principality was restored to a son of the former chief. Since annexation, Garhwal has rapidly advanced in material prosperity. Pop. (1901) 429,900. Two battalions of the Indian army (the 39th Garhwal Rifles) are recruited in the district, which also contains the military cantonment of Lansdowne. Grain and coarse cloth are exported, and salt, borax, live stock and wool are imported, the trade with Tibet being considerable. The administrative headquarters are at the village of Pauri, but Srinagar is the largest place. This is an important mart, as is also Kotdwara, the terminus of a branch of the Oudh and Rohilkhand railway from Najibabad.

2. A native state, also known as Tehri, after its capital; area 4180 sq. m.; pop. (1901) 268,885. It adjoins the district mentioned above, and its topographical features are similar. It contains the sources of both the Ganges and the Jumna, which are visited by thousands of Hindu pilgrims. The gross revenue is about £28,000, of which nearly half is derived from forests. No tribute is paid to the British government.

GARIBALDI, GIUSEPPE (1807-1882), Italian patriot, was born at Nice on the 4th of July 1807. As a youth he fled from home to escape a clerical education, but afterwards joined his father in the coasting trade. After joining the "Giovine Italia" he entered the Sardinian navy, and with a number of companions on board the frigate "Euridice," plotted to seize the vessel and occupy the arsenal of Genoa at the moment when Mazzini's Savoy expedition should enter Piedmont. The plot being discovered, Garibaldi fled, but was condemned to death by default on the 3rd of June 1834. Escaping to South America in 1836, he was given letters of marque by the state of Rio Grande do Sul, which had revolted against Brazil. After a series of victorious engagements he was taken prisoner and subjected to severe torture, which dislocated his limbs. Regaining liberty, he renewed the war against Brazil, and took Porto Allegro. During the campaign he met his wife, Anita, who became his inseparable companion and mother of three children, Anita, Ricciotti and Menotti. Passing into the service of Uruguay, he was sent to Corrientes with a small flotilla to oppose Rosa's forces, but was overtaken by Admiral Brown, against whose fleet he fought for three days. When his ammunition was exhausted he burned his ships and escaped. Returning to Montevideo, he formed the Italian Legion, with which he won the battles of Cerro and Sant' Antonio in the spring of 1846, and assured the freedom of Uruguay. Refusing all honours and recompense, he prepared to return to Italy upon receiving news of the incipient revolutionary movement. In October 1847 he wrote to Pius IX., offering his services to the Church, whose cause he for a moment believed to be that of national liberty.

Landing at Nice on the 24th of June 1848, he placed his sword at the disposal of Charles Albert, and, after various difficulties with the Piedmontese war office, formed a volunteer army 3000 strong, but shortly after taking the field was obliged, by the defeat of Custoza, to flee to Switzerland. Proceeding thence to Rome, he was entrusted by the Roman republic with the defence of San Pancrazio against the French, where he gained the victory of the 30th of April 1849, remaining all day in the saddle, although wounded in the side at the beginning of the fight. From the 3rd of May until the 30th of May he was continuously engaged against the Bourbon troops at Palestrina, Velletri and elsewhere, dispersing an army of 20,000 men with 3000 volunteers. After the fall of Rome he left the city at the head of 4000 volunteers, with the idea of joining the defenders of Venice, and started on that wonderful retreat through central Italy pursued by the armies of France, Austria, Spain and Naples. By his consummate generalship and the matchless endurance of his men the pursuers were evaded and San Marino reached, though with a sadly diminished force. Garibaldi and a few followers, including his devoted wife Anita, after vainly attempting to reach Venice, where the tricolor still floated, took refuge in the pine forests of Ravenna; the Austrians were seeking him in all directions, and most of his legionaries were captured and shot. Anita died near Comacchio, and he himself fled across the peninsula, being assisted by all classes of the people, to Tuscany, whence he escaped to Piedmont and ultimately to America. At New York, in order to earn a living, he became first a chandler, and afterwards a trading skipper, returning to Italy in 1854 with a small fortune, and purchasing the island of Caprera, on which he built the house thenceforth his home. On the outbreak of war in 1859 he was placed in command of the Alpine infantry, defeating the Austrians at Casale on the 8th of May, crossing the Ticino on the 23rd of May, and, after a series of victorious fights, liberating Alpine territory as far as the frontier of Tirol. When about to enter Austrian territory proper his advance was, however, checked by the armistice of Villafranca.

Returning to Como to wed the countess Raimondi, by whom he had been aided during the campaign, he was apprised, immediately after the wedding, of certain circumstances which caused him at once to abandon that lady and to start for central Italy. Forbidden to invade the Romagna, he returned indignantly to Caprera, where with Crispi and Bertani he planned the invasion of Sicily. Assured by Sir James Hudson of the

sympathy of England, he began active preparations for the expedition to Marsala. At the last moment he hesitated, but Crispi succeeded in persuading him to sail from Genoa on the 5th of May 1860 with two vessels carrying a volunteer corps of 1070 strong. Calling at Talamone to embark arms and money, he reached Marsala on the 11th of May, and landed under the protection of the British vessels "Intrepid" and "Argus." On the 12th of May the dictatorship of Garibaldi was proclaimed at Salemi, on the 15th of May the Neapolitan troops were routed at Calatafimi, on the 25th of May Palermo was taken, and on the 6th of June 20,000 Neapolitan regulars, supported by nine frigates and protected by two forts, were compelled to capitulate. Once established at Palermo, Garibaldi organized an army to liberate Naples and march upon Rome, a plan opposed by the emissaries of Cavour, who desired the immediate annexation of Sicily to the Italian kingdom. Expelling Lafarina and driving out Depretis, who represented Cavour, Garibaldi routed the Neapolitans at Milazzo on the 20th of July. Messina fell on the 20th of July, but Garibaldi, instead of crossing to Calabria, secretly departed for Aranci Bay in Sardinia, where Bertani was fitting out an expedition against the papal states. Cavour, however, obliged the expedition to sail for Palermo. Returning to Messina, Garibaldi found a letter from Victor Emmanuel II. dissuading him from invading the kingdom of Naples. Garibaldi replied asking "permission to disobey." Next day he crossed the Strait, won the battle of Reggio on the 21st of August, accepted the capitulation of 9000 Neapolitan troops at San Giovanni and of 11,000 more at Soveria. The march upon Naples became a triumphal progress, which the wives of Francesco II. were powerless to arrest. On the 7th of September Garibaldi entered Naples, while Francesco fled to Gaeta. On the 1st of October he routed the remnant of the Bourbon army 40,000 strong on the Voltorno. Meanwhile the Italian troops had occupied the Marches, Umbria and the Abruzzi, a battalion of Bersaglieri reaching the Voltorno in time to take part in the battle. Their presence put an end to the plan for the invasion of the papal states, and Garibaldi unwillingly issued a decree for the *plebisicite* which was to sanction the incorporation of the Two Sicilies in the Italian realm. On the 7th of November Garibaldi accompanied Victor Emmanuel during his solemn entry into Naples, and on the morrow returned to Caprera, after disbanding his volunteers and recommending their enrolment in the regular army.

Indignation at the cession of Nice to France and at the neglect of his followers by the Italian government induced him to return to political life. Elected deputy in 1861, his anger against Cavour found violent expression. Bixio attempted to reconcile them, but the publication by Cialdini of a letter against Garibaldi provoked a hostility which, but for the intervention of the king, would have led to a duel between Cialdini and Garibaldi. Returning to Caprera, Garibaldi awaited events. Cavour's successor, Ricasoli, enrolled the Garibaldians in the regular army; Rattazzi, who succeeded Ricasoli, urged Garibaldi to undertake an expedition in aid of the Hungarians, but Garibaldi, finding his followers ill-disposed towards the idea, decided to turn his arms against Rome. On the 20th of June 1862 he landed at Palermo and gathered an army under the banner "Roma o morte." Rattazzi, frightened at the prospect of an attack upon Rome, proclaimed a state of siege in Sicily, sent the fleet to Messina, and instructed Cialdini to oppose Garibaldi. Circumventing the Italian troops, Garibaldi entered Catania, crossed to Melito with 3000 men on the 25th of August, but was taken prisoner and wounded by Cialdini's forces at Aspromonte on the 27th of August. Liberated by an amnesty, Garibaldi returned once more to Caprera amidst general sympathy.

In the spring of 1864 he went to London, where he was accorded an enthusiastic reception and given the freedom of the city. From England he returned again to Caprera. On the outbreak of war in 1866 he assumed command of a volunteer army and, after the defeat of the Italian troops at Custoza, took the offensive in order to cover Brescia. On the 3rd of July he defeated the Austrians at Monte Saello, on the 7th at Lodrone, on the 10th at

Darso, on the 16th at Condino, on the 19th at Ampola, on the 21st at Bezzecca, but, when on the point of attacking Trent, he was ordered by General Lamarmora to retire. His famous reply "Obbedisco" ("I obey") has often been cited as a classical example of military obedience to a command destructive of a successful leader's hopes, but documents now published (cf. *Corriere della sera*, 9th of August 1906) prove beyond doubt that Garibaldi had for some days known that the order to evacuate the Trentino would shortly reach him. The order arrived on the 9th of August, whereas Crispi had been sent as early as the 16th of July to warn Garibaldi that, owing to Prussian opposition, Austria would not cede the Trentino to Italy, and that the evacuation was inevitable. Hence Garibaldi's laconic reply. From the Trentino he returned to Caprera to mature his designs against Rome, which had been evacuated by the French in pursuance of the Franco-Italian convention of the 15th of September 1864. Gathering volunteers in the autumn of 1867, he prepared to enter papal territory, but was arrested at Sinalunga by the Italian government and conducted to Caprera. Eluding the surveillance of the Italian cruisers, he returned to Florence, and, with the complicity of the second Rattazzi cabinet, entered Roman territory at Passo Corese on the 23rd of October. Two days later he took Monterotondo, but on the 2nd of November his forces were dispersed at Mentana by French and papal troops. Recrossing the Italian frontier, he was arrested at Figline and taken back to Caprera, where he eked out his slender resources by writing several romances. In 1870 he formed a fresh volunteer corps and went to the aid of France, defeating the German troops at Chatillon, Autun and Dijon. Elected a member of the Versailles assembly, he resigned his mandate in anger at French insults, and withdrew to Caprera until, in 1874, he was elected deputy for Rome. Popular enthusiasm induced the Conservative Minghetti cabinet to propose that a sum of £40,000 with an annual pension of £2000 be conferred upon him as a recompense for his services, but the proposal, though adopted by parliament (27th May 1875), was indignantly refused by Garibaldi. Upon the advent of the Left to power, however, he accepted both gift and pension, and worked energetically upon the scheme for the Tiber embankment to prevent the flooding of Rome. At the same time he succeeded in obtaining the annulment of his marriage with the countess Raimondi (with whom he had never lived) and contracted another marriage with the mother of his children, Clelia and Manlio. In 1880 he went to Milan for the inauguration of the Mentana monument, and in 1882 visited Naples and Palermo, but was prevented by illness from being present at the 600th anniversary of the Sicilian Vespers. On the 2nd of June 1882 his death at Caprera plunged Italy into mourning.

See Garibaldi, *Epistolario*, ed. E. E. Ximenes (2 vols., Milan, 1885), and *Memorie autografe* (11th ed., Florence, 1902; Eng. translation by A. Werner, with supplement by J. W. Mario in vol. iii, of 1888 ed.); Giuseppe Guerzoni, *Garibaldi* (2 vols., Florence, 1882); Jessie White Mario, *Garibaldi e i suoi tempi* (Milan, 1884); G. M. Trevelyan, *Garibaldi's Defence of the Roman Republic* (London, 1907), which contains an excellent sketch of Garibaldi's early career, of the events leading up to the proclamation of the Roman Republic, and a picturesque, detailed and authoritative account of the defence of Rome of Garibaldi's flight, with a very full bibliography; also Trevelyan's *Garibaldi and the Thousand* (1909). (H. W. S.)

GARIN LE LOHERAIN, French epic hero. The 12th century *chanson de geste* of Garin le Loherain is one of the fiercest and most sanguinary narratives left by the *trouvères*. This local cycle of Lorraine, which is completed by Hervés de Metz, Girbers de Metz, Ansis, fils de Girbert and Yon, is obviously based on history, and the failure absolutely to identify the events recorded does not deprive the poems of their value as a picture of the savage feudal wars of the 11th and 12th centuries. The episodes are evolved naturally and the usual devices adopted by the *trouvères* to reconcile their inconsistencies are absent. Nevertheless no satisfactory historical explanation of the story has yet been offered. It has been suggested by a recent critic (F. Settegast, *Quellenstudien zur gollo-romanischen Epik*, 1904) that these poems resume historical traditions going back to the Vandal irruption of 408 and the battle fought by the Romans and the West Goths against the Huns in 451. The cycle relates

three wars against hosts of heathen invaders. In the first of these Charles Martel and his faithful vassal Hervis of Metz fight by an extraordinary anachronism against the Vandals, who have destroyed Reims and besieged other cities. They are defeated in a great battle near Troyes. In the second Hervis is besieged in Metz by the "Hongres." He sends first for help to Pippin, who defers his assistance by the advice of the traitor Hardré. Hervis then transfers his allegiance to Anseis of Cologne, by whose help the invaders are repulsed, though Hervis himself is slain. In the third Thierry, king of Moriane¹ sends to Pippin for help against four Saracen kings. He is delivered by a Frankish host, but falls in the battle. Hervis of Metz was the son of a citizen to whom the duke of Lorraine had married his daughter Aelis, and his sons Garin and Begue are the heroes of the *chanson* which gives its name to the cycle. The dying king Thierry had desired that his daughter Blanche fleur should marry Garin, but when Garin prefers his suit at the court of Pippin, Fromont of Bordeaux puts himself forward as his rival and Hardré, Fromont's father, is slain by Garin. The rest of the poem is taken up with the war that ensues between the Lorrainers and the men of Bordeaux. They finally submit their differences to the king, only to begin their disputes once more. Blanche fleur becomes the wife of Pippin, while Garin remains her faithful servant. One of the most famous passages of the poem is the assassination of Begue by a nephew of Fromont, and Garin, after laying waste his enemy's territory, is himself slain. The remaining songs continue the feud between the two families. According to Paulin Paris, the family of Bordeaux represents the early dukes of Aquitaine, the last of whom, Waifar (745-768) was dispossessed and slain by Pippin the Short, king of the Franks; but the *trouvères* had in mind no doubt the wars which marked the end of the Carolingian dynasty.

See *Li Romans de Garin le Loherain*, ed. P. Paris (Paris, 1833); *Hist. litt. de la France*, vol. xxii. (1852); J. M. Ludlow, *Popular Epics of the Middle Ages* (London and Cambridge, 1865); F. Lot, *Études d'histoire du moyen âge* (Paris, 1896); F. Settegast, *Quellenstudien zur gallo-romanischen Epik* (Leipzig, 1904). A complete edition of the cycle was undertaken by E. Stengel, the first volume of which, *Hervis de Metz* (Gesellschaft für roman. Lit., Dresden), appeared in 1903.

GARLAND, JOHN (fl. 1202-1252), Latin grammarian, known as Johannes Garlandius, or, more commonly, Johannes de Garlandia, was born in England, though most of his life was spent in France. John Bale in his *Catalogus*, and John Pits, following Bale, placed him among the writers of the 11th century. The main facts of his life, however, are stated in a long poem *De triumphis ecclesiae* contained in Cotton MS. Claudius A x in the British Museum, and edited by Thomas Wright for the Roxburghe Club in 1856. Garland narrates the history of his time from the point of view of the victories gained by the church over heretics at home and infidels abroad. He studied at Oxford under a certain John of London, whom it is difficult to distinguish from others of the same name; but he must have been in Paris in or before 1202, for he mentions as one of his teachers Alain de Lisle, who died in that year or the next. Garland was one of the professors chosen in 1229 for the new university of Toulouse, and remained in the south during the Albigensian crusade, of which he gives a detailed account in books iv.-vi. In 1232 or 1233 the hatred of the people made further residence in Toulouse unsafe for the professors of the university, who had been installed by the Catholic party. Garland was one of the first to fly, and the rest of his life was spent in Paris, where he finished his poem in 1252. Garland's grammatical works were much used in England, and were often printed by Richard Pynson and Wynkyn de Worde. He was also a voluminous Latin poet. Works on mathematics and music have also been assigned to him, but the ascription may have arisen from confusion of his works with those of Gerlandus, a canon of Bezançon in the 12th century. The treatise on alchemy, *Compendium alchimiae*, often printed under his name, was by a 14th-century writer named Martin Ortolan, or Lortholain.

The best known of his poems beside the "De Triumphis"¹ *i.e.* Maurienne, now a district and diocese (St Jean de Maurienne) of Savoy.

Ecclesiae" is "Epithalamium beatae Mariae Virginis," contained in the same MS. Among his other works are his "Dictionarius," a Latin vocabulary, printed by T. Wright in the *Library of National Antiquities* (vol. I, 1857); *Compendium lotius grammaticae* . . . printed at Deventer, 1489; two metrical treatises, entitled *Synonyma* and *Equivoca*, frequently printed at the close of the 15th century.

For further bibliographical information see the British Museum catalogue; J. A. Fabricius, *Bibliotheca Latina mediae et inferioris aetatis* . . . vol. iii. (1754); G. Brunet, *Manuel du libraire, &c.* See also *Histoire litt. de la France*, vols. viii., xxi., xxiii. and xxx.; the prefaces to the editions by T. Wright mentioned above; P. Meyer, *La Chanson de la croisade contre les Albigeois*, vol. ii. pp. xxi-xxxiii. (Paris, 1875); Dr A. Scheler, *Lexicographie latine du XII^e et du XIII^e siècles* (Leipzig, 1867); the article by C. L. Kingsford in the *Dict. Nat. Biog.*, giving a list also of the works on alchemy, mathematics and music, rightly or wrongly ascribed to him; J. E. Sandys, *Hist. of Class. Schol.* i. (1906) 549. (E. G.)

GARLIC (O. Eng. *gárlēc*, *i.e.* "spear-leek"; Gr. *ἀσκόλαρος*, Lat. *allium*; Ital. *aglio*; Fr. *ail*; Ger. *Knoblauch*), *Allium sativum*, a bulbous perennial plant of the natural order Liliaceae, indigenous apparently to south-west Siberia. It has long narrow, flat, obscurely keeled leaves, a deciduous spathe, and a globose umbel of whitish flowers, among which are small bulbils. The bulb, which is the only part eaten, has membranous scales, in the axils of which are 10 or 12 cloves, or smaller bulbils. From these new bulbils can be procured by planting out in February or March. The bulbils are best preserved hung in a dry place. If of fair size, twenty of them weigh about 1 lb. To prevent the plant from running to leaf, Pliny (*Nat. Hist.* xix. 34) advises to bend the stalk downward and cover with earth; seeding, he observes, may be prevented by twisting the stalk.

Garlic is cultivated in the same manner as the shallot (*q.v.*). It is stated to have been grown in England before the year 1548. The percentage composition of the bulb is given by E. Solly (*Trans. Hort. Soc. Lond.*, new ser., iii. p. 60) as water 84.00, organic matter 13.38, and inorganic matter 1.53—that of the leaves being water 87.14, organic matter 11.27 and inorganic matter 1.59. The bulb has a strong and characteristic odour and an acrid taste, and yields an offensively smelling oil, essence of garlic, identical with allyl sulphide (C₃H₃)₂S (see Hofmann and Cahours, *Journ. Chem. Soc.* x. p. 320). This, when garlic has been eaten, is evolved by the excretory organs, the activity of which it promotes. From the earliest times garlic has been used as an article of diet. It formed part of the food of the Israelites in Egypt (Numb. xi. 5) and of the labourers employed by Cheops in the construction of his pyramid, and is still grown in Egypt, where, however, the Syrian is the kind most esteemed (see Rawlinson's *Herodotus*, ii. 125). It was largely consumed by the ancient Greek and Roman soldiers, sailors and rural classes (cf. Virg. *Ecl.* ii. 11), and, as Pliny tells us (*N.H.* xix. 32), by the African peasantry. Galen eulogizes it as the rustic's *theriac* (see F. Adams's *Paulus Aegineta*, p. 90), and Alexander Neckam, a writer of the 12th century (see Wright's edition of his works, p. 473, 1863), recommends it as a palliative of the heat of the sun in field labour. "The people in places where the simoon is frequent," says Mountstuart Elphinstone (*An Account of the Kingdom of Caubul*, p. 140, 1815), "eat garlic, and rub their lips and noses with it, when they go out in the heat of the summer, to prevent their suffering by the simoon." "O dura messorum ilia," exclaims Horace (*Epod.* iii.), as he records his detestation of the popular excrement, to smell of which was accounted a sign of vulgarity (cf. Shakespeare, *Coriol.* iv. 6, and *Meas. for Meas.* iii. 2). In England garlic is seldom used except as a seasoning, but in the southern countries of Europe it is a common ingredient in dishes, and is largely consumed by the agricultural population. Garlic was placed by the ancient Greeks on the piles of stones at cross-roads, as a supper for Hecate (Theophrastus, *Characters, Δεισιδαιμονίας*); and according to Pliny garlic and onions were invoked as deities by the Egyptians at the taking of oaths. The inhabitants of Pelusium in lower Egypt, who worshipped the onion, are said to have held both it and garlic in aversion as food. Garlic possesses stimulant and stomachic properties, and was of old, as still sometimes now, employed as a medicinal remedy.

Pliny (*N.H.* xx. 23) gives an exceedingly long list of complaints in which it was considered beneficial. Dr T. Sydenham valued it as an application in confluent smallpox, and, says Cullen (*Mat. Med.* ii. p. 174, 1789), found some dropsies cured by it alone. In the United States the bulb is given in doses of $\frac{1}{2}$ -2 drachms in cases of bronchiectasis and phthisis pulmonalis. Garlic may also be prescribed as an extract consisting of the inspissated juice, in doses of 5-10 grains, and as the *sympus allii acetici*, in doses of 1-4 drachms. This last preparation has recently been much extolled in the treatment of pulmonary tuberculosis or phthisis.

The wild "crow garlic" and "field garlic" of Britain are the species *Allium vineale* and *A. oleraceum* respectively.

GARNET, or **GARNETT**, **HENRY** (1555-1606), English Jesuit, son of Brian Garnett, a schoolmaster at Nottingham, was educated at Winchester and afterwards studied law in London. Having become a Roman Catholic, he went to Italy, joined the Society of Jesus in 1575, and acquired under Bellarmine and others a reputation for varied learning. In 1586 he joined the mission in England, becoming superior of the province on the imprisonment of William Weston in the following year. In the dispute between the Jesuits and the secular clergy known as the "Wisbech Stirrs" (1595-1596) he zealously supported Weston in his resistance to any compromise with the civil government. His antagonism to the secular clergy was also shown later, when in 1603 he, with other Jesuits, was the means of betraying to the government the "Bye Plot," contrived by William Watson, a secular priest. In 1598 he was professed of the four vows.

Garnet supervised the Jesuit mission for eighteen years with conspicuous success. His life was one of concealment and disguises; a price was put on his head; but he was fearless and indefatigable in carrying on his propaganda and in ministering to the scattered Catholics, even in their prisons. The result was that he gained many converts, while the number of Jesuits in England increased during his tenure of office from three to forty. It is, however, in connexion with the Gunpowder Plot that he is best remembered. His part in this, for which he suffered death, needs discussion in greater detail.

In 1602 Garnet received briefs from Pope Clement VIII. directing that no person unfavourable to the Catholic religion should be allowed to succeed to the throne. About the same time he was consulted by Catesby, Tresham and Winter, all afterwards involved in the Gunpowder Plot, on the subject of the mission to be sent to Spain to induce Philip III. to invade England. According to his own statement he disapproved, but he gave Winter a recommendation to Father Creswell, an influential person at Madrid. Moreover, in May 1605 he gave introductions to Guy Fawkes when he went to Flanders, and to Sir Edmund Baynham when he went to Rome (see GUNPOWDER PLOT). The preparations for the plot had now been actively going forward since the beginning of 1604, and on the 9th of June 1605 Garnet was asked by Catesby whether it was lawful to enter upon any undertaking which should involve the destruction of the innocent together with the guilty, to which Garnet answered in the affirmative, giving as an illustration the fate of persons besieged in a town in time of war. Afterwards, feeling alarmed, according to his own accounts, he admonished Catesby against intending the death of "not only innocents but friends and necessary persons for a commonwealth," and showed him a letter from the pope forbidding rebellion. According to Sir Everard Digby, however, Garnet, when asked the meaning of the brief, replied "that they were not (meaning the priests) to undertake or procure stirrs, but yet they would not hinder any, neither was it the pope's mind they should, that should be undertaken for Catholic good. . . . This answer, with Mr Catesby's proceedings with him and me, gave me absolute belief that the matter in general was approved, though every particular was not known." Both men were endeavouring to exculpate themselves, and therefore both statements are subject to suspicion. A few days later, according to Garnet, the Jesuit, Oswald Tesemond, known as Greenway, informed him of the whole plot "by way of confession," when, as he declares, he expressed horror at the design and urged Green-

way to do his utmost to prevent its execution. Subsequently, after his trial, Garnet said he "could not certainly affirm" that Greenway intended to relate the matter to him in confession.

Garnet's conduct in now keeping the plot a secret has been a matter of considerable controversy not only between Roman Catholics and Protestants, but amongst Roman Catholic writers themselves. Father Martin del Rio, a Jesuit, writing in 1600, discusses the exact case of the revelation of a plot in confession. Almost all the learned doctors, he says, declare that the confessor may reveal it, but he adds, "the contrary opinion is the safer and better doctrine, and more consistent with religion and with the reverence due to the holy rite of confession." According to Bellarmine, Garnet's zealous friend and defender, "If the person confessing be concealed, it is lawful for a priest to break the seal of confession in order to avert a great calamity"; but he justifies Garnet's silence by insisting that it was not lawful to disclose a treasonable secret to a heretical king. According to Garnet's own opinion a priest cognizant of treason against the state "is bound to find all lawful means to discover it *salvo sigillo confessionis*." In this connexion it is worth pointing out that Garnet had not thought it his duty to disclose the treasonable intrigue with the king of Spain in 1602, though there was no pretence in this case that he was restricted by the seal of confession, and his inactivity now tells greatly in his disfavour; for, allowing even that he was bound by confessional secrecy from taking action on Greenway's information, he had still Catesby's earlier revelations to act upon. He appears to have taken no steps whatever to prevent the crime, beyond writing to Rome in vague terms that "he feared some particular desperate courses," which aroused no suspicions in that quarter. At the same time he wrote to Father Parsons on the 4th of September that "as far as he could now see the minds of the Catholics were quieted."

His movements immediately prior to the attempt were certainly suspicious. In September, shortly before the expected meeting of parliament on the 3rd of October, Garnet organized a pilgrimage to St Winifred's Well in Flintshire, which started from Gothurst (now Gayhurst), Sir Everard Digby's house in Buckinghamshire, included Rokewood, and stopped at the houses of John Grant and Robert Winter, three others of the conspirators. During the pilgrimage Garnet asked for the prayers of the company "for some good success for the Catholic cause at the beginning of parliament." After his return he went on the 29th of October to Coughton in Warwickshire, near which place it had been settled the conspirators were to assemble after the explosion. On the 6th of November, Bates, Catesby's servant and one of the conspirators, brought him a letter with the news of the failure of the plot and desiring advice. On the 30th Garnet addressed a letter to the government in which he protested his innocence with the most solemn oaths, "as one who hopeth for everlasting salvation."

It was not till the 4th of December, however, that Garnet and Greenway were, by the confession of Bates, implicated in the plot; and on the same day Garnet removed from Coughton to Hindlip Hall, near Worcester, a house furnished with cleverly-contrived hiding-places for the use of the proscribed priests. Here he remained some time in concealment in company with another priest, Oldcorne *alias* Hall, but at last on the 30th of January 1606, unable to bear the close confinement any longer, they surrendered and were taken up to London, being well treated during the journey by Salisbury's express orders. He was examined by the council on the 13th of February and frequently questioned during the following days, but refused to incriminate himself, and a threat to inflict torture had no effect upon his resolution. Subsequently Garnet and Oldcorne having been placed in adjoining rooms and enabled to communicate with one another, their conversations were overheard on several separate occasions and considerable information obtained. Garnet at first denied all speech with Oldcorne, but subsequently on the 8th of March confessed his connexion with the plot. He was tried at the Guildhall on the 28th.

Garnet was clearly guilty of misprision of treason, *i.e.* of having concealed his knowledge of the crime, an offence which exposed

him to perpetual imprisonment and forfeiture of his property; for the law of England took no account of religious scruples or professional etiquette when they permit the execution of a preventable crime. Strangely enough, however, the government passed over the incriminating conversation with Greenway, and relied entirely on the strong circumstantial evidence to support the charge of high treason against the prisoner. The trial was not conducted in a manner which would be permitted in more modern days. The rules of evidence which now govern the procedure in criminal cases did not then exist, and Garnet's trial, like many others, was influenced by the political situation, the case against him being supported by general political accusations against the Jesuits as a body, and with evidence of their complicity in former plots against the government. The prisoner himself deeply prejudiced his cause by his numerous false statements, and still more by his adherence to the doctrine of equivocation. Garnet, it is true, claimed to limit the justification of equivocation to cases "of necessary defence from injustice and wrong or of the obtaining some good of great importance when there is no danger of harm to others," and he could justify his conduct in lying to the council by their own conduct towards him, which included treacherous eavesdropping and fraud, and also threats of torture. Moreover, the attempt of the counsel for the crown to force the prisoner to incriminate himself was opposed to the whole spirit and tradition of the law of England. He was declared guilty, and it is probable, in spite of the irregularity and unjudicial character of his trial, that substantial justice was done by his conviction. His execution took place on the 3rd of May 1606, Garnet acknowledging himself justly condemned for his concealment of the plot, but maintaining to the last that he had never approved it. The king, who had shown him favour throughout and who had forbidden his being tortured, directed that he should be hanged till he was quite dead and that the usual frightful cruelties should be omitted.

Soon after his death the story of the miracle of "Garnet's Straw" was circulated all over Europe, according to which a blood-stained straw from the scene of execution which came into the hands of one John Wilkinson, a young and fervent Roman Catholic, who was present, developed Garnet's likeness. In consequence of the credence which the story obtained, Archbishop Bancroft was commissioned by the privy council to discover and punish the impostors. Garnet's name was included in the list of the 353 Roman Catholic martyrs sent to Rome from England in 1880, and in the 2nd appendix of the Menology of England and Wales compiled by order of the cardinal archbishop and the bishops of the province of Westminster by R. Stanton in 1887, where he is styled "a martyr whose cause is deferred for future investigation." The passage in *Macbeth* (Act II. Scene iii.) on equivocators no doubt refers especially to Garnet. His *aliases* were Farmer, Marchant, Whalley, Darcey Meaze, Phillips, Humphreys, Roberts, Fulgeham, Allen. Garnet was the author of a letter on the Martyrdom of Godfrey Maurice, *alias* John Jones, in Diego Yepes's *Historia particular de la persecucion de Inglaterra* (1599); a *Treatise of Schism*, a MS. treatise in reply to *A Protestant Dialogue between a Gentleman and a Physician*; a translation of the *Stemma Christi* with supplements (1622); a treatise on the Rosary; a *Treatise of Christian Renovation or Birth* (1616).

AUTHORITIES.—Of the great number of works embodying the controversy on the question of Garnet's guilt the following may be mentioned, in order of date: *A True and Perfect Relation of the whole Proceedings against . . . Garnet a Jesuit and his Confederates* (1606, repr. 1679), the official account, but incomplete and inaccurate; *Apologia pro Henrico Garneto* (1610), by the Jesuit L'Heureux, under the pseudonym Eudaemon-Joannes, and Dr Robert Abbot's reply, *Antilogia versus Apologiam Eudaemon-Joannes*, in which the whole subject is well treated; Henry More, *Hist. Provinciae Anglicanae Societatis* (1660); D. Jardine, *Gunpowder Plot* (1857); J. Morris, S. J., *Condition of the Catholics under James I.* (1872), containing Father Gerard's narrative; J. H. Pollen, *Father Henry Garnet and the Gunpowder Plot* (1888); S. R. Gardiner, *What Gunpowder Plot was* (1897), in reply to John Gerard, S. J., *What was the Gunpowder Plot?* (1897); J. Gerard, *Contributions towards a Life of Father Henry Garnet* (1898). See also *Slate Trials II.*, and *Cal. of State Papers Dom.*, (1603-1610). The original documents are preserved in the *Gunpowder Plot Book* at the Record Office.

GARNET, a name applied to a group of closely-related minerals, many of which are used as gem-stones. The name probably comes from the Lat. *granaticus*, a stone so named from its resemblance to the pulp of the pomegranate in colour, or to its seeds in shape; or possibly from *granum*, "cochineal," in allusion to the colour of the stone. The garnet was included, with other red stones, by Theophrastus, under the name of *ἀσθαξ*, while the common garnet seems to have been his *ἀσθαμασ*. Pliny groups several stones, including garnet, under the term *carbunculus*. The modern carbuncle is a deep red garnet (almandine) cut *en cabochon*, or with a smooth convex surface, frequently hollowed out at the back, in consequence of the depth of colour, and sometimes enlivened with a foil (see ALMANDINE). The Hebrew word *sophek*, translated *ἀσθαξ* in the Septuagint, seems to have been the garnet or carbuncle, whilst *bareketh* (*σφάραγος* of the Septuagint), though also rendered "carbuncle," was probably either beryl or, in the opinion of Professor Flinders Petrie, rock-crystal. Garnets were used as beads in ancient Egypt. Though not extensively employed by the Greeks as a material for engraved gems, it was much used for this purpose by the Romans of the Empire. Flat polished slabs of garnet are found inlaid in mosaic work in Anglo-Saxon and Merovingian jewelry, the material used being almandine, or "precious garnet."

Garnets vary considerably in chemical composition, but the variation is limited within a certain range. All are orthosilicates, conformable to the general formula $R^2R''(SiO_4)_2$, where $R^2 = Ca, Mg, Fe, Mn$, and $R'' = Al, Fe, Cr$. Although there are many kinds of garnet they may be reduced to the following six types, which may occur intermixed isomorphously:—

1. Calcium-aluminium garnet (*Grossularite*), $Ca_2Al_2Si_2O_{10}$.
2. Calcium-ferric garnet (*Andradite*), $Ca_2Fe_2Si_2O_{10}$.
3. Calcium-chromium garnet (*Uvarovite*), $Ca_2Cr_2Si_2O_{10}$.
4. Magnesium-aluminium garnet (*Pyrope*), $Mg_2Al_2Si_2O_{10}$.
5. Ferrous-aluminium garnet (*Almandine*), $Fe_2Al_2Si_2O_{10}$.
6. Manganese-aluminium garnet (*Spessartine*), $Mn_2Al_2Si_2O_{10}$.

These are frequently called respectively:—(1) Lime-alumina garnet; (2) lime-iron garnet; (3) lime-chrome garnet; (4) magnesia-alumina garnet; (5) iron-alumina garnet; (6) manganese-alumina garnet.

The types are usually modified by isomorphous replacement of some of their elements.

All garnets crystallize in the cubic system, usually in rhombic dodecahedra or in icositetrahedra, or in a combination of the two forms (see fig.). Octahedra and cubes are rare, but the six-faced octahedron occurs in some of the combinations. Cleavage obtains parallel to the dodecahedron, but is imperfect. The hardness varies according to composition from 6.5 to 7.5, and the specific gravity in like manner has a wide range, varying from 3.4 in the calcium-aluminium garnets to 4.3 in the ferrous-aluminium species. Sir Arthur H. Church found that many garnets when fused yielded a product of lower density than the original mineral. The colour is typically red, but may be brown, yellow, green or even black, while some garnets are colourless. Being cubic the garnets are normally singly refracting, but anomalies frequently occur, leading some authorities to doubt whether the mineral is really cubic. The refractive power of garnet is high, so that in microscopic sections, viewed by transmitted light, the mineral stands out in relief.

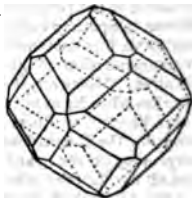

Garnets are very widely distributed, occurring in crystalline schists, gneiss, granite, metamorphic limestone, serpentine, and occasionally in volcanic rocks. With omphacite and smaragdite, garnet forms the peculiar rock called eclogite. The garnets used for industrial purposes are usually found loose in detrital deposits, weathered from the parent rock, though in some important workings the rock is quarried. The garnets employed as gem-stones are described under their respective headings (see ALMANDINE, CINNAMON STONE, DEMANTOID and PYROPE). Most of the minerals noticed in this article are of scientific rather than commercial interest.

Grossularite or "gooseberry-stone" is typically a brownish-green garnet from Siberia, known also as willuite (a name applied also to vesuvianite, *q.v.*), from the river Wilui where it occurs. It is related to hessonite, or cinnamon-stone. A Mexican variety occurs in ros-

pink dodecahedra. Romanzovite is a brown garnet, of grossularite-type, from Finland, taking its name from Count Romanzov. Andradite was named by J. D. Dana after B. J. d'Andrada e Silva, who described, in 1800, one of its varieties allochroite, a Norwegian garnet, so named from its variable colour. This species includes most of the common garnet occurring in granular and compact masses, sometimes forming garnet rock. To andradite may be referred melanite, a black garnet well known from the volcanic tuffs near Rome, used occasionally in the 18th century for mourning jewelry. Another black garnet, in small crystals from the Pyrenees, is called pyreneite. Under andradite may also be placed topazolite, a honey-yellow garnet, rather like topaz, from Piedmont; colonophonite, a brown resin-like garnet, with which certain kinds of idocrase have been confused; aplome, a green garnet from Saxony and Siberia; and jelleite, a green Swiss garnet named after the Rev. J. H. Jellet. Here also may be placed the green Siberian mineral termed demantoid (*g.s.*), sometimes improperly called olivine by jewellers. Uvarovite, named after a Russian minister, Count S. S. Uvarov, is a rare green garnet from Siberia and Canada, but though of fine colour is never found in crystals large enough for gem-stones. Spessartite, or spessartine, named after Spessart, a German locality, is a fine aurora-red garnet, cut for jewelry when sufficiently clear, and rather resembling cinnamon-stone. It is found in Ceylon, and notably in the mica-mines in Amelia county, Virginia, United States. A beautiful rose-red garnet, forming a fine gem-stone, occurs in gravels in Macon county, N.C., and has been described by W. E. Hildon and Dr. J. H. Pratt under the name of rhodolite. It seems related to both almandine and pyrope, and shows the absorption-spectrum of almandine. The Bohemian garnets largely used in jewelry belong to the species pyrope (*g.s.*).

Garnets are not only cut as gems, but are used for the bearings of pivots in watches, and are in much request for abrasive purposes. Garnet paper is largely used, especially in America, in place of sand-paper for smoothing woodwork and for scouring leather in the boot-trade. As an abrasive agent it is worked at several localities in the United States, especially in New York State, along the borders of the Adirondacks, where it occurs in limestone and in gneiss. Much of the garnet used as an abrasive is coarse almandine. Common garnet, where abundant, has sometimes been used as a fluxing agent in metallurgical operations. Garnet has been formed artificially, and is known as a furnace-product.

It may be noted that the name of white garnet has been given to the mineral leucite, which occurs, like garnet, crystallized in icositrahedra. (F. W. R. *)

GARNETT, RICHARD (1835-1906), English librarian and author, son of the learned philologist Rev. Richard Garnett (1789-1850), priest-vicar of Lichfield cathedral and afterwards keeper of printed books at the British Museum, who came of a Yorkshire family, was born at Lichfield on the 27th of February 1835. His father was really the pioneer of modern philological research in England; his articles in the *Quarterly Review* (1835, 1836) on English lexicography and dialects, and on the Celtic question, and his essays in the *Transactions of the Philological Society* (reprinted 1859), were invaluable to the later study of the English language. The son, who thus owed much to his parentage, was educated at home and at a private school, and in 1851, just after his father's death, entered the British Museum as an assistant in the library. In 1875 he rose to be superintendent of the reading-room, and from 1890 to 1899, when he retired, he was keeper of the printed books. In 1883 he was given the degree of LL.D. at Edinburgh, an honour repeated by other universities, and in 1895 he was made a C.B.

His long connexion with the British Museum library, and the value of his services there, made him a well-known figure in the literary world, and he published much original work in both prose and verse. His chief publications in book-form were: in verse, *Primula* (1858), *Io in Egypt* (1859), *Idylls and Epigrams* (1869, republished in 1892 as *A Chapter from the Greek Anthology*), *The Queen and other Poems* (1902), *Collected Poems* (1893); in prose, biographies of Carlyle (1887), Emerson (1887), Milton (1890), Edward Gibbon Wakefield (1898); a volume of remarkably original and fanciful tales, *The Twilight of the Gods* (1888); a tragedy, *Iphigenia in Delphi* (1890); *A Short History of Italian Literature* (1898); *Essays in Librarianship and Bibliophily* (1899); *Essays of an Ex-librarian* (1901). He was an extensive contributor to the *Encyclopædia Britannica* and the *Dictionary of National Biography*, editor of the *International Library of Famous Literature*, and co-editor, with E. Gosse, of the elaborate *English Literature: an illustrated Record*. So multifarious was his output, however, in contributions to reviews, &c.,

and as translator or editor, that this list represents only a small part of his published work. He was a member of numerous learned literary societies, British and foreign. His facility as an expositor, and his gift for lucid and acute generalization, together with his eminence as a bibliophile, gave his work an authority which was universally recognized, though it sometimes suffered from his relying too much on his memory and his power of generalizing—remarkable as both usually were—in cases requiring greater precision of statement in matters of detail. But as an interpreter, whether of biography or *belles lettres*, who brought an unusually wide range of book-learning, in its best sense, interestingly and comprehensibly before a large public, and at the same time acceptably to the canons of careful scholarship, Dr Garnett's writing was always characterized by clearness, common sense and sympathetic appreciation. His official career at the British Museum marked an epoch in the management of the library, in the history of which his place is second only to that of Panizzi. Besides introducing the "sliding press" in 1837 he was responsible for reviving the publication of the general catalogue, the printing of which, interrupted in 1841, was resumed under him in 1880, and gradually completed. The antipodes of a Dryasdust, his human interest in books made him an ideal librarian, and his courtesy and helpfulness were outstanding features in a personality of singular charm. The whole bookish world looked on him as a friend. Among his "hobbies" was a study of astrology, to which, without associating his name with it in public, he devoted prolonged inquiry. Under the pseudonym of "A. G. Trent" he published in 1880 an article (in the *University Magazine*) on "The Soul and the Stars"—quoted in Wilde and Dodson's *Natal Astrology*. He satisfied himself that there was more truth in the old astrology than modern criticism supposed, and he had intended to publish a further monograph on the subject, but the intention was frustrated by the ill-health which led up to his death on the 13th of April 1906. He married (1863) an Irish wife, Olivia Narney Singleton (d. 1903), and had a family of six children; his son Edward (b. 1868) being a well-known literary man, whose wife translated Turgenieff's works into English. (H. Ch.)

GARNIER, CLÉMENT JOSEPH (1813-1881), French economist, was born at Beuil (Alpes maritimes) on the 3rd of October 1813. Coming to Paris he studied at the École de Commerce, of which he eventually became secretary and finally a professor. In 1842 he founded with Gilbert-Urbain Guillaumin (1801-1864) the *Société d'Économie politique*, becoming its secretary, a post which he held till his death; and in 1846 he organized the Association pour la Liberté des Échanges. He also helped to establish and edited for many years the *Journal des économistes* and the *Annuaire de l'économie politique*. Of the school of *laissez faire*, he was engaged during his whole life in the advancement of the science of political economy, and in the improvement of French commercial education. In 1873 he became a member of the Institute, and in 1876 a senator for the department in which he was born. He died at Paris on the 25th of September 1881. Of his writings, the following are the more important: *Traité d'économie politique* (1845), *Richard Cobden et la Ligue* (1846), *Traité des finances* (1862), and *Principes de population* (1857).

GARNIER, GERMAIN, MARQUIS (1754-1821), French politician and economist, was born at Auxerre on the 8th of November 1754. He was educated for the law, and obtained when young the office of *procureur* to the Châtelet in Paris. On the calling of the states-general he was elected as one of the *députés suppléants* of the city of Paris, and in 1791 administrator of the department of Paris. After the 10th of August 1792 he withdrew to the Pays de Vaud, and did not return to France till 1795. In public life, however, he seems to have been singularly fortunate. In 1797 he was on the list of candidates for the Directory; in 1800 he was prefect of Seine-et-Oise; and in 1804 he was made senator and in 1808 a count. After the Restoration he obtained a peerage, and on the return of Louis XVIII., after the Hundred Days, he became minister of state and member of privy council, and in 1817 was created a marquis. He died at Paris on the 24th

October 1821. At court he was, when young, noted for his facile power of writing society verse, but his literary reputation depends rather on his later works on political economy, especially his admirable translation, with notes and introduction, of Smith's *Wealth of Nations* (1805) and his *Histoire de la monnaie* (2 vols., 1819), which contains much sound and well-arranged material. His *Abregé des principes de l'écon. polit.* (1796) is a very clear and instructive manual. The valuable *Description géographique, physique, et politique du département de Seine-et-Oise* (1802) was drawn up from his instructions. Other works are *De la propriété* (1792) and *Histoire des banques d'escompte* (1806).

GARNIER, JEAN LOUIS CHARLES (1825-1898), French architect, was born in Paris on the 6th of November 1825. He was educated in a primary school, and it was intended that he should pursue his father's craft, that of a wheelwright. His mother, however, having heard that with a little previous study he might enter an architect's office and eventually become a measuring surveyor (*strifécateur*), and earn as much as six francs a day, and foreseeing that in consequence of his delicate health he would be unfit to work at the forge, sent him to learn drawing and mathematics at the Petite École de Dessin, in the rue de Médecine, the cradle of so many of the great artists of France. His progress was such as to justify his being sent first into an architect's office and then to the well-known atelier of Lebas, where he began his studies in preparation for the examination of the École des Beaux Arts, which he passed in 1842, at the age of seventeen. Shortly after his admission it became necessary that he should support himself, and accordingly he worked during the day in various architects' offices, among them in that of M. Viollet-le-Duc, and confined his studies for the École to the evening. In 1848 he carried off, at the early age of twenty-three, the Grand Prix de Rome, and with his comrades in sculpture, engraving and music, set off for the Villa de Medicis. His principal works were the measured drawings of the Forum of Trajan and the temple of Vesta in Rome, and the temple of Serapis at Pozzuoli. In the fifth year of his travelling studentship he went to Athens and measured the temple at Aegina, subsequently working out a complete restoration of it, with its polychromatic decoration, which was published as a monograph in 1877. The elaborate set of drawings which he was commissioned by the duc de Luynes to make of the tombs of the house of Anjou were not published, owing to the death of his patron; and since Garnier's death they have been given to the library of the École des Beaux Arts, along with other drawings he made in Italy. On his return to Paris in 1853 he was appointed surveyor to one or two government buildings, with a very moderate salary, so that the commission given him by M. Victor Baltard to make two water-colour drawings of the Hôtel de Ville, to be placed in the album presented to Queen Victoria in 1855, on the occasion of her visit to Paris, proved very acceptable. These two drawings are now in the library at Windsor.

In 1860 came, at last, Garnier's chance: a competition was announced for a design for a new imperial academy of music, and out of 163 competitors Garnier was one of five selected for a second competition, in which, by unanimous vote, he carried off the first prize, and the execution of the design was placed in his hands. Begun in 1861, but delayed in its completion by the Franco-German War, it was not till 1875 that the structure of the present Grand Opera House of Paris was finished, at a cost of about 35,000,000 francs (£1,420,000). During the war the building was utilized as the municipal storehouse of provisions. The staircase and the magnificent hall are the finest portion of the interior, and alike in conception and realization have never been approached. Of Garnier's other works, the most remarkable are the Casino at Monte Carlo, the Bischoffshelm villa at Bordighera, the Hôtel du Cercle de la Librairie in Paris; and, among tombs, those of the musicians Bizet, Offenbach, Massé and Duprato. In 1874 he was elected a member of the Institute of France, and after passing through the grades of chevalier, officer and commander of the Legion of Honour, received in 1895 the rank of *grand officier*, a high distinction that had never before been granted to an architect. Charles Garnier's reputation was not

confined to France; it was recognized by all the countries of Europe, and in England he received, in 1886, the royal gold medal of the Royal Institute of Architects, given by Queen Victoria. Besides his monograph on the temple of Aegina, he wrote several works, of which *Le Nouvel Opéra de Paris* is the most valuable. For the International Exhibition of 1889 he designed the buildings illustrating the "History of the House" in all periods, and a work on this subject was afterwards published by him in conjunction with M. Ammann. Not the least of his claims to the gratitude of his country were the services which he rendered on the various art juries appointed by the state, the Institute of France, and the École des Beaux-Arts, services which in France are rendered in an honorary capacity. Garnier died on the 3rd of August 1898.

GARNIER, MARIE JOSEPH FRANÇOIS [FRANCIS] (1839-1873), French officer and explorer, was born at St Étienne on the 25th of July 1839. He entered the navy, and after voyaging in Brazilian waters and the Pacific he obtained a post on the staff of Admiral Charnef, who from 1860 to 1862 was campaigning in Cochinchina. After some time spent in France he returned to the East, and in 1862 he was appointed inspector of the natives in Cochinchina, and entrusted with the administration of Cho-lon, a suburb of Saigon. It was at his suggestion that the marquis de Chasseloup-Laubat determined to send a mission to explore the valley of the Mekong, but as Garnier was not considered old enough to be put in command, the chief authority was entrusted to Captain Douard de Lagrée. In the course of the expedition—to quote the words of Sir Roderick Murchison addressed to the youthful traveller when, in 1870, he was presented with the Victoria Medal of the Royal Geographical Society of London—from Kratie in Cambodia to Shanghai 5392 m. were traversed, and of these 3625 m., chiefly of country unknown to European geography, were surveyed with care, and the positions fixed by astronomical observations, nearly the whole of the observations being taken by Garnier himself. Volunteering to lead a detachment to Talifu, the capital of Sultan Sulaiman, the sovereign of the Mahomedan rebels in Yunnan, he successfully carried out the more than adventurous enterprise. When shortly afterwards Lagrée died, Garnier naturally assumed the command of the expedition, and he conducted it in safety to the Yang-tze-Kiang, and thus to the Chinese coast. On his return to France he was received with enthusiasm. The preparation of his narrative was interrupted by the Franco-German War, and during the siege of Paris he served as principal staff officer to the admiral in command of the eighth "sector." His experiences during the siege were published anonymously in the feuilleton of *Le Temps*, and appeared separately as *Le Siège de Paris, journal d'un officier de marine* (1871). Returning to Cochinchina he found the political circumstances of the country unfavourable to further exploration, and accordingly he went to China, and in 1873 followed the upper course of the Yang-tze-Kiang to the waterfalls. He was next commissioned by Admiral Dupré, governor of Cochinchina, to found a French protectorate or a new colony in Tongking. On the 20th of November 1873 he took Hanoi, the capital of Tongking, and on the 21st of December he was slain in fight with the Black Flags. His chief fame rests on the fact that he originated the idea of exploring the Mekong, and carried out the larger portion of the work.

The narrative of the principal expedition appeared in 1873, as *Voyage d'exploration en Indo-Chine effectué pendant les années 1866, 1867 et 1868, publié sous la direction de M. Francis Garnier, avec le concours de M. Delaporte et de M. M. Joubert et Thorel* (2 vols.). An account of the Yang-tze-Kiang from Garnier's pen is given in the *Bulletin de la Soc. de Géog.* (1874). His *Chronique royale du Cambodge*, was reprinted from the *Journal Asiatique* in 1872. See *Ocean Highways* (1874) for a memoir by Colonel Yule; and Hugh Clifford, *Further India*, in the Story of Exploration series (1904).

GARNIER, ROBERT (c. 1545-c. 1600), French tragic poet, was born at Ferté Bernard (Le Maine) in 1545. He published his first work while still a law-student at Toulouse, where he won a prize (1565) in the *jeux florans*. It was a collection of lyrical pieces, now lost, entitled *Plaintes amoureuses de Robert Garnier* (1565). After some practice at the Parisian bar, he became

conseiller du roi au siège présidial et sénéchaussée de Le Maine, his native district, and later lieutenant-général criminel. His friend Lacroix du Maine says that he enjoyed a great reputation as an orator. He was a distinguished magistrate, of considerable weight in his native province, who gave his leisure to literature, and whose merits as a poet were fully recognized by his own generation. He died at Le Mans probably in 1599 or 1600.

In his early plays he was a close follower of the school of dramatists who were inspired by the study of Seneca. In these productions there is little that is strictly dramatic except the form. A tragedy was a series of rhetorical speeches received by a lyric chorus. His pieces in this manner are *Porcie* (published 1568; acted at the hôtel de Bourgogne in 1573), *Cornélie* and *Hippolyte* (both acted in 1573 and printed in 1574). In *Porcie* the deaths of Cassius, Brutus and Portia are each the subject of an eloquent recital, but the action is confined to the death of the nurse, who alone is allowed to die on the stage. His next group of tragedies—*Marc-Antoine* (1578), *La Troade* (1579), *Antigone* (acted and printed 1580)—shows an advance on the theatre of Étienne Jodelle and Jacques Grévin, and on his own early plays, in so much that the rhetorical element is accompanied by abundance of action, though this is accomplished by the plan of joining together two virtually independent pieces in the same way.

In 1582 and 1583 he produced his two masterpieces *Bradamante* and *Les Juives*. In *Bradamante*, which alone of his plays has no chorus, he cut himself adrift from Senecan models, and sought his subject in Ariosto, the result being what came to be known later as a tragi-comedy. The dramatic and romantic story becomes a real drama in Garnier's hands, though even there the lovers, Bradamante and Roger, never meet on the stage. The contest in the mind of Roger supplies a genuine dramatic interest in the manner of Corneille. *Les Juives* is the pathetic story of the barbarous vengeance of Nebuchadnezzar on the Jewish king Zedekiah and his children. The Jewish women lamenting the fate of their children take a principal part in this tragedy, which, although almost entirely elegiac in conception, is singularly well designed, and gains unity by the personality of the prophet. M. Faguet says that of all French tragedies of the 16th and 17th centuries it is, with *Alhalie*, the best constructed with regard to the requirements of the stage. Actual representation is continually in the mind of the author; his drama is, in fact, visually conceived.

Garnier must be regarded as the greatest French tragic poet of his century and the precursor of the great achievements of the next.

The best edition of his works is by Wendelin Foerster (Heilbronn, 4 vols., 1882-1883). A detailed criticism of his works is to be found in Émile Faguet, *La Tragédie française au XVI^e siècle* (1883, pp. 183-307).

GARNIER-PAGÈS, ÉTIENNE JOSEPH LOUIS (1801-1841), French politician, was born at Marseilles on the 27th of December 1801. Soon after his birth his father Jean François Garnier, a naval surgeon, died, and his mother married Simon Pagès, a college professor, by whom she had a son. The boys were brought up together, and took the double name Garnier-Pagès. Étienne found employment first in a commercial house in Marseilles, and then in an insurance office in Paris. In 1825 he began to study law, and made some mark as an advocate. A keen opponent of the Restoration, he joined various democratic societies, notably the *Aide-toi, le ciel t'aidera*, an organization for purifying the elections. He took part in the revolution of July 1830; became secretary of the *Aide-toi, le ciel t'aidera*, whose propaganda he brought into line with his anti-monarchical ideas; and in 1831 was sent from Isère to the chamber of deputies. He was concerned in the preparation of the *Compte rendu* of 1832, and advocated universal suffrage. He was an eloquent speaker, and his sound knowledge of business and finance gave him a marked influence among all parties in the chamber. He died in Paris on the 23rd of June 1841.

His half-brother, **LOUIS ANTOINE GARNIER-PAGÈS** (1803-1878), fought on the barricades during the revolution of July 1830, and after Étienne's death was elected to the chamber of

deputies (1842). He was a keen promoter of reform, and was a leading spirit in the affair of the reform banquet fixed for the 22nd of February 1848. He was a member of the provisional government of 1848, and was named mayor of Paris. On the 5th of March 1848 he was made minister of finance, and incurred great unpopularity by the imposition of additional taxes. He was a member of the Constituent Assembly and of the Executive Commission. Under the Empire he was conspicuous in the republican opposition and opposed the war with Prussia, and after the fall of Napoleon III. became a member of the Government of National Defence. Unsuccessful at the elections for the National Assembly (the 8th of February 1871), he retired into private life, and died in Paris on the 31st of October 1878. He wrote *Histoire de la révolution de 1848* (1860-1862); *Histoire de la commission exécutive* (1869-1872); and *L'Opposition et l'Empire* (1872).

GARNISH, a word meaning to fit out, equip, furnish, now particularly used of decoration or ornament. It is formed from the O. Fr. *garnissant* or *garnissant*, participle of *garnir*, *guarnir*, to furnish, equip. This is of Teutonic origin, the base being represented in O. Eng. *warnian*, to take warning, beware, and Ger. *warnen*, to warn, Eng. *warn*; the original sense would be to guard against, fortify, hence equip or fit out. The meaning of "warn" is seen in the law term "garnishes," a person who owes money to or holds money belonging to another and is "warned" by order of the court not to pay it to his immediate creditor but to a third person who has obtained final judgment against that creditor. (See ATTACHMENT; EXECUTION; BANKRUPTCY.)

GARO HILLS, a district of British India, in the hills division of Eastern Bengal and Assam. It takes its name from the Garos, a tribe of doubtful ethnical affinities and peculiar customs, by whom it is almost entirely inhabited. The Garos are probably a section of the great Bodo tribe, which at one time occupied a large part of Assam. According to the census of 1901 they numbered 128,117. In the 18th century they are mentioned as being frequently in conflict with the inhabitants of the plains below their hills, and in 1790 the British government first tried to reduce them. No permanent success was achieved. In 1852 raids by the Garos were followed by a blockade of the hills, but in 1856 they were again in revolt. Again a repressive expedition was despatched in 1861, but in 1866 there was a further raid. A British officer was now posted among the hills; this step was effective; in 1869 the district was constituted, and though in 1871 an outrage was committed against a native on the survey staff, there was little opposition when an expedition was sent in 1872-1873 to bring the whole district into submission, and there were thereafter no further disturbances.

The district consists of the last spurs of the Assam hills, which here run down almost to the bank of the Brahmaputra, where that river debouches upon the plain of Bengal and takes its great sweep to the south. The administrative headquarters are at Tura. The area of the district is 3140 sq. m. In 1901 the population was 138,274, showing an increase of 14% in the decade. The American missionaries maintain a small training school for teachers. The public buildings at Tura were entirely destroyed by the earthquake of June 12, 1897, and the roads in the district were greatly damaged by subsidence and fissures. Coal in large quantities and petroleum are known to exist. The chief exports are cotton, timber and forest products. Trade is small, though the natives, according to their own standard, are prosperous. They are fair agriculturists. Communications within the district are by cart-roads, bridle-paths and native tracks.

GARONNE (Lat. *Garumna*), a river of south-western France, rising in the Maladetta group of the Pyrenees, and flowing in a wide curve to the Atlantic Ocean. It is formed by two torrents, one of which has a subterranean course of 2½ m., disappearing in the sink known as the Trou du Taureau ("bull's hole") and reappearing at the Goueil de Joubou. After a course of 30 m. in Spanish territory, during which it flows through the fine gorge called the Vallée d'Arán, the Garonne enters France in the department of Haute Garonne through the narrow defile of the

Pont du Roi, and at once becomes navigable for rafts. At Montrejeau it receives on the left the Neste, and encountering at this point the vast plateau of Lannemezan is forced to turn abruptly east, flowing in a wide curve to Toulouse. At Saint Martory it gives off the irrigation canal of that name. At this point the Garonne enters a fertile plain, and supplies the motive power to several mills. It is joined on the right by various streams fed by the snows of the Pyrenees. Such are the Salat, at whose confluence river navigation proper begins, and the Arize and the Ariège (both names signifying "river"). From Toulouse the Garonne flows to the north-west, now skirting the northern border of the plateau of Lannemezan which here drains into it, the principal streams being the Save, the Gers and the Baise. On its right hand the Garonne is swelled by its two chief tributaries, the Tarn, near Moissac, and the Lot, below Agen; farther down it is joined by the Drot (or Dropt), and on the left by the Ciron. Between Toulouse and Castets, 33½ m. above Bordeaux, and the highest point to which ordinary spring-tides ascend, the river is accompanied at a distance of from a ½ to 3 m. by the so-called "lateral canal" of the Garonne, constructed in 1838-1856. This canal is about 120 m. long, or 133 m. including its branches, one of which runs off at right angles to Montauban on the Tarn. From Toulouse to Agen the main canal follows the right bank of the Garonne, crossing the Tarn on an aqueduct at Moissac, while another magnificent aqueduct of twenty-three arches carries it at Agen from the right to the left bank of the river. It has a fall of 420 ft. and over fifty locks, and is navigable for vessels having the maximum dimensions of 98½ ft. length, 19 ft. breadth and 6½ ft. draught. The carrying trade upon it is chiefly in agricultural produce and provisions, building materials, wood and industrial products. At Toulouse the canal connects with the Canal du Midi, which runs to the Mediterranean. After passing Castets the Garonne begins to widen out considerably, and from being 160 yds. broad at Agen increases to about 650 yds. at Bordeaux, its great commercial port. From here it flows with ever increasing width between two flat shores to the Bec d'Ambès (15½ m.), where, after a course of 357 m., it unites with the Dordogne to form the vast estuary known as the Gironde. The triangular peninsula lying between these two great tidal rivers is called Entre-deux-mers ("between two seas") and is famous for its wines. The drainage area of the Garonne is nearly 33,000 sq. m. Floods are of common occurrence, and descend very suddenly. The most disastrous occurred in 1875, 1856 and in 1770, when the flood level at Castets attained the record height of 42½ ft. above low-water mark.

GARRET (from the O. Fr. *garite*, modern *guêrite*, a watch-tower, connected ultimately with "guard" and "ward"), properly a small look-out tower built on a wall, and hence the name given to a room on the top storey of a building, the sloping ceiling of which is formed by the roof.

GARRETT, JOÃO BAPTISTA DA SILVA LEITÃO DE ALMEIDA, VISCONDE DE ALMEIDA-GARRETT (1799-1854), perhaps the greatest Portuguese poet since Camoens, was of Irish descent. Born in Oporto, his parents moved to the Quinta do Castelo at Gaya when he was five years old. The French invasion of Portugal drove the family to the Azores, and Garrett made his first studies at Angra, beginning to versify at an early age under the influence of his uncle, a poet of the school of Bocage. Going to the university of Coimbra in 1816, he soon earned notoriety by the precocity of his talents and his fervent Liberalism, and there he gained his first oratorical and literary successes. His tragedy *Lucretia* was played there in February 1819, and during this period he also wrote *Merope* as well as a great part of *Cato*, all these plays belonging to the so-called classical school. Leaving Coimbra with a law degree, he proceeded to Lisbon, and on the 11th of November 1822 married D. Luiza Midous; but the alliance proved unhappy and a formal separation took place in 1839.

The reactionary movement against the Radical revolution of 1820 reached its height in 1823, and Garrett had to leave Portugal by order of the Absolutist ministry then in power, and went to England. He became acquainted with the masterpieces of

the English and German romantic movements during his stay abroad.

Imbued with the spirit of nationality, he wrote in 1824 at Havre the poem "Camões," which destroyed the influence of the worn-out classical and Arcadian rhymers, and in the following year composed the patriotic poem "D. Branca," or "The Conquest of the Algarve." He was permitted to return to Portugal in 1826, and thereupon devoted himself to journalism. With the publication of *O Portuguez*, he raised the tone of the press, exhibiting an elevation of ideas and moderation of language then unknown in political controversy, and he introduced the "feuilleton." But his defence of Liberal principles brought him three months' imprisonment, and when D. Miguel was proclaimed absolute king on the 3rd of May 1828, Garrett had again to leave the country. In London, where he sought refuge, he continued his adhesion to romanticism by publishing *Adasinda* and *Bernal-Franca*, expansions of old folk-poems, which met with the warmest praise from Southey and were translated by Adamson. He spent the next three years in and about Birmingham, Warwick and London, engaged in writing poetry and political pamphlets, and by these and by his periodicals he did much to unite the Portuguese *émigrés* and to keep up their spirit amid their sufferings in a foreign land. Learning that an expedition was being organized in France for the liberation of Portugal, Garrett raised funds and joined the forces under D. Pedro as a volunteer. Sailing in February 1832, he disembarked at Terceira, whence he passed to S. Miguel, then the seat of the Liberal government. Here he became a co-operator with the statesman Mousinho da Silveira, and assisted him in drafting those laws which were to revolutionize the whole framework of Portuguese society, this important work being done far from books and without pecuniary reward. In his spare time he wrote some of the beautiful lyrics afterwards collected into *Flores sem Fructo*. He took part in the expedition that landed at the Mindello on the 8th of July 1832, and in the occupation of Oporto. Early in the siege he sketched out, under the influence of Walter Scott, the historical romance *Arco de Sant' Anna*, descriptive of the city in the reign of D. Pedro I.; and, in addition, he organized the Home and Foreign offices under the marquis of Palmella, drafted many important royal decrees, and prepared the criminal and commercial codes. In the following November he was despatched as secretary to the marquis on a diplomatic mission to foreign courts, which involved him in much personal hardship. In the next year the capture of Lisbon enabled him to return home, and he was charged to prepare a scheme for the reform of public instruction.

In 1834-1835 he served as consul-general and chargé d'affaires at Brussels, representing Portugal with distinction under most difficult circumstances, for which he received no thanks and little pay. When he got back, the government employed him to draw up a proposal for the construction of a national theatre and for a conservatoire of dramatic art, of which he became the head. He instituted prizes for the best plays, himself revising nearly all that were produced, and a school of dramatists and actors arose under his influence. To give them models, he proceeded to write a series of prose dramas, choosing his subjects from Portuguese history. He began in 1838 with the *Aulo de Gil Vicente*, considering that the first step towards the re-creation of the Portuguese drama was to revive the memory of its founder, and he followed this up in 1842 by the *Alfageme de Santarem*, dealing with the Holy Constable, and in 1843 by *Frei Luiz de Sousa*, one of the few great tragedies of the 19th century, a work as intensely national as *The Lusitads*. The story, which in part is historically true, and has the merit of being simple, like the action, is briefly as follows. D. João de Portugal, who was supposed to have died at the battle of Alcaccer, returns, years afterwards, to find his wife married to Manoel de Sousa and the mother of a daughter by him, named Maria. Thereupon the pair separate and enter religion, and Manoel becomes the famous chronicler, Frei Luiz de Sousa (q.v.). The characters live and move, especially Telmo, the old servant, who would never believe in the death of his former master D. João, and the consumptive

child Maria, who helps Telmo to create the atmosphere of impending disaster; while the episodes, particularly those of the return of D. João and the death of Maria, are full of power, and the language is Portuguese of the best.

Entering parliament in 1837, Garrett soon made his mark as an orator. In that year he delivered many notable discourses in defence of liberal ideas. He also brought in a literary copyright bill, which, when it became law in 1851, served as a precedent for similar legislation in England and Prussia. In 1840 he made his famous speech known as *Porto Pyres*, in which he skilfully turned the well-known anecdote of the "mad Athenian" against his opponents. While attending with assiduity to his duties as a deputy, he wrote, about this time, the drama *D. Filippa de Vilhena*, founded on an incident in the revolution of 1640, for representation by the pupils of the conservatoire, and the session of 1841 saw another of his oratorical triumphs in his speech against the law of tithes. In July 1843 an excursion to Santarem resulted in his prose masterpiece *Viagens na minha terra*, at once a novel and a miscellany of literary, political and philosophic criticism, written without plan or method, easy, jovial and epigrammatic. He took no part in the civil war that followed the revolution of Maria da Fonte, but continued his literary labours, producing in 1848 the comedy *A Sabrinha do Marquez*, dealing with the times of Pombal, and in 1849 an historical memoir on Mousinho da Silveira. He spent much of the year 1850 in finishing his *Romanceiro*, a collection of folk-poetry of which he was the first to perceive the value; and in June 1851 he was created a viscount. In the following December he drew up the additional act to the constitutional charter, and his draft was approved by the ministers at a cabinet meeting in his house. Further, he initiated the *Conselho Ultramarino*; and the *Law of the Misericórdias*, with its preamble, published in 1852, was entirely from his pen. In the same year he became for a short time minister of foreign affairs. In 1853 he brought out *Folhas Caidas*, a collection of short poems ablaze with passion and exquisite in form, of which his friend Herculano said: "if Camoens had written love verses at Garrett's age, he could not have equalled him." His final literary work was a novel, *Helena*, which he left unfinished, and on the 10th of February 1854 he made his last notable speech in the House. He died on the 9th of December 1854, and on the 3rd of May 1903 his remains were translated to the national pantheon, the Jeronymos at Belem, where they rest near to those of Camoens. As poet, novelist, journalist, orator and dramatist, he deserves the remark of Rebello da Silva: "Garrett was not a man of letters only but an entire literature in himself."

Besides his strong religious faith, Garrett was endowed with a deep sensibility, a creative imagination, rare taste and a singular capacity for sympathy. Thus, though a learned man and an able jurist, he was bound to be first and always an artist. His artistic temperament explains his many-sided activity, his expansive kindliness, his seductive charm, especially for women, his patriotism, his aristocratic pretensions, his huge vanity and dandyism, and the ingenuousness that absolves him from many faults in an irregular life. From his rich artistic nature sprang his profound, sincere, sensual and melancholy lyrics, the variety and perfection of his scenic creations, the splendour of his eloquence, the truth of his comic vein, the elegance of his lighter compositions. Two books stand out in bold relief from among his writings: *Folhas Caidas*, and that tragedy of fatality and pity, *Frei Luis de Sousa*, with its gallery of noble figures incarnating the truest realism in an almost perfect prose form. The complete collection of his works comprises twenty-four volumes and there are several editions.

AUTHORITIES.—Gomes de Amorim, *Garrett, memorias biographicas* (3 vols., Lisbon, 1881-1888); D. Romero Ortiz, *La Literatura Portuguesa en el siglo XIX* (Madrid, 1866), pp. 165-221; Dr Theophilus Braga, *Garrett e o romantismo* (Oporto, 1904); and *Garrett e os dramas romanticos* (Oporto, 1905), with a full bibliography; Innocencio da Silva, *Diccionario bibliographico Portuguez*, vol. iii, pp. 309-316, and vol. x, pp. 180-185. See *Revue encyclopedique Larousse*, No. 284, for a bibliography of the foreign translations of Garrett. *Frei Luis de Sousa* was translated by Edgar Prestage under the title *Brother Luis de Sousa* (London, 1909). (E. P.)

GARRETTING, properly GALLETTING, a term in architecture for the process in which the "gallets" or small splinters of stone are inserted in the joints of coarse masonry to protect the mortar joints; they are stuck in while the mortar is wet.

GARRICK, DAVID (1717-1779), English actor and theatrical manager, was descended from a good French Protestant family named Garric or Garrigue of Bordeaux, which had settled in England on the revocation of the Edict of Nantes. His father, Captain Peter Garrick, who had married Arabella Clough, the daughter of a vicar choral of Lichfield cathedral, was on a recruiting expedition when his famous third son was born at Hereford on the 19th of February 1717. Captain Garrick, who had made his home at Lichfield, where he had a large family, in 1731 rejoined his regiment at Gibraltar. This kept him absent from home for many years, during which letters were written to him by "little Davy," acquainting him with the doings at Lichfield. When the boy was about eleven years old he paid a short visit to Lisbon where his uncle David had settled as a wine merchant. On his father's return from Gibraltar, David, who had previously been educated at the grammar school of Lichfield, was, largely by the advice of Gilbert Walmesley, registrar of the ecclesiastical court, sent with his brother George to the "academy" at Edial just opened in June or July 1736 by Samuel Johnson, the senior by seven years of David, who was then nineteen. This seminary was, however, closed in about six months, and on the end of March 1736/7 both Johnson and Garrick left Lichfield for London—Johnson, as he afterwards said, "with twopence halfpenny in his pocket," and Garrick "with three-halfpence in his." Johnson, whose chief asset was the MS. tragedy of *Irene*, was at first the host of his former pupil, who, however, before the end of the year took up his residence at Rochester with John Colson (afterwards Lucasian professor at Cambridge). Captain Garrick died about a month after David's arrival in London. Soon afterwards, his uncle, the wine merchant at Lisbon, having left David a sum of £1000, he and his brother entered into partnership as wine merchants in London and Lichfield, David taking up the London business. The concern was not prosperous—though Samuel Foote's assertion that he had known Garrick with three quarts of vinegar in the cellar calling himself a wine merchant need not be taken literally—and before the end of 1741 he had spent nearly half of his capital.

His passion for the stage completely engrossed him; he tried his hand both at dramatic criticism and at dramatic authorship. His first dramatic piece, *Lethe*, or *Aesop in the Shades*, which he was thirty-seven years later to read from a splendidly bound transcript to King George III. and Queen Charlotte, was played at Drury Lane on the 15th of April 1740; and he became a well-known frequenter of theatrical circles. His first appearance on the stage was made in March 1741, *incognito*, as harlequin at Goodman's Fields, Yates, who was ill, having allowed him to take his place during a few scenes of the pantomime entitled *Harlequin Student*, or *The Fall of Pantomime with the Restoration of the Drama*. Garrick subsequently accompanied a party of players from the same theatre to Ipswich, where he played his first part as an actor under the name of Lyddal, in the character of Aboan (in Southerne's *Oroonoko*). His success in this and other parts determined his future career. On the 10th of October 1741 he made his appearance at Goodman's Fields as Richard III. and gained the most enthusiastic applause. Among the audience was Macklin, whose performance of Shylock, early in the same year, had pointed the way along which Garrick was so rapidly to pass in triumph. On the morrow the latter wrote to his brother at Lichfield, proposing to make arrangements for his withdrawal from the partnership, which, after much distressful complaint on the part of his family, met by him with the utmost consideration were ultimately carried into effect. Meanwhile, each night had added to his popularity on the stage. The town, as Gray (who, like Horace Walpole, at first held out against the *furor*) declared, was "horn-mad" about him. Before his Richard had exhausted its original effect, he won new applause as Aboan, and soon afterwards as Lear and as Pierre in Ctway's *Venice Preserved*, as well as in several comic characters (including *Don Quixote*).

deeply impressed by the good Quaker's zeal and devotion, and he resolved to join him and devote himself thereafter to the work of abolishing slavery.

In pursuance of this plan he went to Baltimore in the autumn of 1830, and thenceforth the *Genius* was published weekly, under the joint editorship of the two men. It was understood, however, that Garrison would do most of the editorial work, while Lundy would spend most of his time in lecturing and procuring subscribers. On one point the two editors differed radically, Lundy being the advocate of gradual and Garrison of immediate emancipation. The former was possessed with the idea that the negroes, on being emancipated, must be colonized somewhere beyond the limits of the United States; the latter held that they should be emancipated on the soil of the country, with all the rights of freemen. In view of this difference it was agreed that each should speak on his own individual responsibility in the paper, appending his initial to each of his articles for the information of the reader. It deserves mention here that Garrison was then in utter ignorance of the change previously wrought in the opinions of English abolitionists by Elizabeth Heyrick's pamphlet in favour of immediate, in distinction from gradual emancipation. The sinfulness of slavery being admitted, the duty of immediate emancipation to his clear ethical instinct was perfectly manifest. He saw that it would be idle to expose and denounce the evils of slavery, while responsibility for the system was placed upon former generations, and the duty of abolishing it transferred to an indefinite future. His demand for immediate emancipation fell like a tocsin upon the ears of slaveholders. For general talk about the evils of slavery they cared little, but this assertion that every slave was entitled to instant freedom filled them with alarm and roused them to anger, for they saw that, if the conscience of the nation were to respond to the proposition, the system must inevitably fall. The *Genius*, now that it had become a vehicle for this dangerous doctrine, was a paper to be feared and intensely hated. Baltimore was then one of the centres of the domestic slave trade, and upon this traffic Garrison heaped the strongest denunciations. A vessel owned in Newburyport having taken a cargo of slaves from Baltimore to New Orleans, he characterized the transaction as an act of "domestic piracy," and avowed his purpose to "cover with thick infamy" those engaged therein. He was thereupon prosecuted for libel by the owner of the vessel, fined \$50, mulcted in costs, and, in default of payment, committed to gaol. His imprisonment created much excitement, and in some quarters, in spite of the pro-slavery spirit of the time, was a subject of indignant comment in public as well as private. The excitement was fed by the publication of two or three striking sonnets, instinct with the spirit of liberty, which Garrison inscribed on the walls of his cell. One of these, *Freedom of Mind*, is remarkable for freshness of thought and terseness of expression.

John G. Whittier, the Quaker poet, interceded with Henry Clay to pay Garrison's fine and thus release him from prison. To the credit of the slaveholding statesman it must be said that he responded favourably, but before he had time for the requisite preliminaries Arthur Tappan, a philanthropic merchant of New York, contributed the necessary sum and set the prisoner free after an incarceration of seven weeks. The partnership between Garrison and Lundy was then dissolved by mutual consent, and the former resolved to establish a paper of his own, in which, upon his sole responsibility, he could advocate the doctrine of immediate emancipation and oppose the scheme of African colonization. He was sure, after his experiences at Baltimore, that a movement against slavery resting upon any less radical foundation than this would be ineffectual. He first proposed to establish his paper at Washington, in the midst of slavery, but on returning to New England and observing the state of public opinion there, he came to the conclusion that little could be done at the South while the non-slaveholding North was lending her influence, through political, commercial, religious and social channels, for the sustenance of slavery. He determined, therefore, to publish his paper in Boston, and, having issued his prospectus, set himself to the task of awakening an interest in the subject by

means of lectures in some of the principal cities and towns of the North. It was an up-hill work. Contempt for the negro and indifference to his wrongs were almost universal. In Boston, then a great cotton mart, he tried in vain to procure a church or vestry for the delivery of his lectures, and thereupon announced in one of the daily journals that if some suitable place was not promptly offered he would speak on the common. A body of infidels under the leadership of Abner Kneeland (1774-1844), who had previously been in turn a Baptist minister and the editor of a Universalist magazine, proffered him the use of their small hall; and, no other place being accessible, he accepted it gratefully, and delivered therein (in October 1830) three lectures, in which he unfolded his principles and plans. He visited privately many of the leading citizens of the city, statesmen, divines and merchants, and besought them to take the lead in a national movement against slavery; but they all with one consent made excuse, some of them listening to his plea with manifest impatience. He was disappointed, but not disheartened. His conviction of the righteousness of his cause, of the evils and dangers of slavery, and of the absolute necessity of the contemplated movement, was intensified by opposition, and he resolved to go forward, trusting in God for success.

On the 1st of January 1831, without a dollar of capital, and without a single subscriber, he and his partner Isaac Knapp (1804-1843) issued the first number of the *Liberator*, avowing their "determination to print it as long as they could subsist on bread and water, or their hands obtain employment." Its motto was, "Our country is the world—our countrymen are mankind"; and the editor, in his address to the public, uttered the words which have become memorable as embodying the whole purpose and spirit of his life: "I am in earnest—I will not equivocate—I will not excuse—I will not retreat a single inch—and I will be heard." Help came but slowly. For many months Garrison and his brave partner, who died long before the end of the conflict, made their bed on the floor of the room, "dark, unfurnished and mean," in which they printed their paper, and where Mayor Harrison Gray Otis of Boston, in compliance with the request of Governor Robert Y. Hayne of South Carolina, "ferreted them out" in "an obscure hole," "their only visible auxiliary a negro boy." But the paper founded under such inauspicious circumstances exerted a mighty influence, and lived to record not only President Lincoln's proclamation of emancipation, but the adoption of an amendment to the constitution of the United States for ever prohibiting slavery: It was the beginning and the nucleus of an agitation that eventually pervaded and filled every part of the country. Other newspapers were afterwards established upon the same principles; anti-slavery societies, founded upon the doctrine of immediate emancipation, sprang up on every hand; the agitation was carried into political parties, into the press, and into legislative and ecclesiastical assemblies; until in 1861 the Southern states, taking alarm from the election of a president known to be at heart opposed to slavery though pledged to enforce all the constitutional safeguards of the system, seceded from the Union and set up a separate government.

Garrison sought the abolition of slavery by moral means alone. He knew that the national government had no power over the system in any state, though it could abolish it at the national capital, and prohibit it in the territories. He thought it should bring its moral influence to bear in favour of abolition; but neither he nor his associates ever asked Congress to exercise any unconstitutional power. His idea was to combine the moral influence of the North, and pour it through every open channel upon the South. To this end he made his appeal to the Northern churches and pulpits, beseeching them to bring the power of Christianity to bear against the slave system, and to advocate the rights of the slaves to immediate and unconditional freedom. He was a man of peace, hating war not less than he did slavery; but he warned his countrymen that if they refused to abolish slavery by moral power a retributive war must sooner or later ensue. The conflict was irrepressible. Slavery must be overthrown, if not by peaceful means, then in blood. The first society

organized under Garrison's auspices, and in accordance with his principles, was the New England Anti-Slavery Society, which adopted its constitution in January 1832. In the spring of this year Garrison issued his *Thoughts on African Colonization*, in which he showed by ample citations from official documents that the American Colonization Society was organized in the interest of slavery, and that in offering itself to the people of the North as a practical remedy for that system it was guilty of deception. His book, aided by others taking substantially the same view, smote the society with a paralysis from which it never recovered. Agents of the American Colonization Society in England having succeeded in deceiving leading Abolitionists there as to its character and tendency, Garrison was deputed by the New England Anti-Slavery Society to visit England for the purpose of counteracting their influence. He went in the spring of 1833, when he was but twenty-seven years of age, and was received with great cordiality by British Abolitionists, some of whom had heard of his bold assaults upon American slavery, and had seen a few numbers of the *Liberator*. The struggle for emancipation in the West Indies was then at the point of culmination; the leaders of the cause, from all parts of the kingdom, were assembled in London, and Garrison was at once admitted to their councils and treated with distinguished consideration. He took home with him a "protest" against the American Colonization Society, signed by Wilberforce, Zachary Macaulay, Samuel Gurney, William Evans, S. Lushington, T. Lowell Buxton, James Cropper, Daniel O'Connell and others, in which they declared their deliberate judgment that "its precepts were delusive," and "its real effects of the most dangerous nature." He also received assurances of the cordial sympathy of British Abolitionists with him in his efforts to abolish American slavery. He gained a hearing before a large popular assembly in London, and won the confidence of those whom he addressed by his evident earnestness, sincerity and ability.

Garrison's visit to England enraged the pro-slavery people and press of the United States at the outset, and when he returned home in September with the "protest" against the Colonization Society, and announced that he had engaged the services of George Thompson as a lecturer against American slavery, there were fresh outbursts of rage on every hand. The American Anti-Slavery Society was organized in December of that year (1833), putting forth a masterly declaration of its principles and purposes from the pen of Garrison. This added fresh fuel to the public excitement, and when Thompson came over in the next spring, the hostility to the cause began to manifest itself in mobs organized to suppress the discussion of the slavery question. Now began what Harriet Martineau called "the martyr age in America." In the autumn of 1835 Thompson was compelled, in order to save his life, to embark secretly for England. Just before his departure the announcement that he would address the Woman's Anti-Slavery Society of Boston created "a mob of gentlemen of property and standing," from which, if he had been present, he could hardly have escaped with his life. The whole city was in an uproar. Garrison, almost denuded of his clothing, was dragged through the streets with a rope by infuriated men. He was rescued with great difficulty, and consigned to the goal for safety, until he could be secretly removed from the city.

Anti-slavery societies were greatly multiplied throughout the North, and many men of influence, both in the church and in the state, were won to the cause. Garrison, true to his original purpose, never faltered or turned back. The Abolitionists of the United States were a united body until 1839-1840, when divisions sprang up among them. Garrison countenanced the activity of women in the cause, even to the extent of allowing them to vote and speak in the anti-slavery societies, and appointing them as lecturing agents; moreover, he believed in the political equality of the sexes, to which a strong party was opposed upon social and religious grounds. Then there were some who thought Garrison dealt too severely with the churches and pulpits for their complicity with slavery, and who accused him of a want of religious orthodoxy; indeed, according to the

standards of his time he was decidedly heterodox, though he had an intensely religious nature and was far from being an infidel, as he was often charged with being. He was, moreover, not only a non-resistant but also an opponent of all political systems based on force. "As to the governments of this world," he said, "whatever their titles or forms we shall endeavour to prove that in their essential elements, as at present administered, they are all anti-Christ; that they can never by human wisdom be brought into conformity with the will of God; that they cannot be maintained except by naval and military power to carry them into effect; that all their penal enactments, being a dead letter without any army to carry them into effect, are virtually written in human blood; and that the followers of Jesus should instinctively shun their stations of honor, power, and emolument—at the same time 'submitting to every ordinance of man for the Lord's sake' and offering no physical resistance to any of their mandates, however unjust or tyrannical." These views were very distasteful to many, who, moreover, felt that Garrison greatly injured abolitionism by causing it to be associated in men's minds with these unpopular views on other subjects. The dissentients from his opinions determined to form an anti-slavery political party, while he believed in working by moral rather than political party instrumentalities. These differences led to the organization of a new National Anti-Slavery Society in 1840, and to the formation of the "Liberty Party" (q.v.) in politics. (See BIRNEY, JAMES C.) The two societies sent their delegates to the World's Anti-Slavery Convention in London in 1840, and Garrison refused to take his seat in that body, because the women delegates from the United States were excluded. The discussions of the next few years served to make clearer than before the practical workings of the constitution of the United States as a shield and support of slavery; and Garrison, after a long and painful reflection, came to the conclusion that its pro-slavery clauses were immoral, and that it was therefore wrong to take an oath for its support. The Southern states had greatly enlarged representation in Congress on account of their slaves, and the national government was constitutionally bound to assist in the capture of fugitive slaves, and to suppress every attempt on their part to gain their freedom by force. In view of these provisions, Garrison, adopting a bold scriptural figure of speech, denounced the constitution as "a covenant with death and an agreement with hell," and chose as his motto, "No union with slaveholders."

One class of Abolitionists sought to evade the difficulty by strained interpretations of the clauses referred to, while others, admitting that they were immoral, felt themselves obliged, notwithstanding, to support the constitution in order to avoid what they thought would be still greater evils. The American Anti-Slavery Society, of which Garrison was the president from 1843 to the day of emancipation, was during all this period the nucleus of an intense and powerful moral agitation, which was greatly valued by many of the most faithful workers in the field of politics, who respected Garrison for his fidelity to his convictions. On the other hand, he always had the highest respect for every earnest and faithful opponent of slavery, however far their special views might differ. When in 1861 the Southern states seceded from the Union and took up arms against it, he saw clearly that slavery would perish in the struggle, that the constitution would be purged of its pro-slavery clauses, and that the Union henceforth would rest upon the sure foundations of liberty, justice and equality to all men. He therefore ceased from that hour to advocate disunion, and devoted himself to the task of preparing the way for and hastening on the inevitable event. His services at this period were recognized and honoured by President Lincoln and others in authority, and the whole country knew that the agitation which made the abolition of slavery feasible and necessary was largely due to his uncompromising spirit and indomitable courage.

In 1865 at the close of the war, he declared that, slavery being abolished, his career as an abolitionist was ended. He counselled a dissolution of the American Anti-Slavery Society, insisting that it had become *functus officio*, and that whatever needed

to be done for the protection of the freedmen could best be accomplished by new associations formed for that purpose. The *Liberator* was discontinued at the end of the same year, after an existence of thirty-five years. He visited England for the second time in 1846, and again in 1867, when he was received with distinguished honours, public as well as private. In 1877, when he was there for the last time, he declined every form of public recognition. He died in New York on the 24th of May 1879, in the seventy-fourth year of his age, and was buried in Boston, after a most impressive funeral service, four days later. In 1843 a small volume of his *Sonnets and other Poems* was published, and in 1852 appeared a volume of *Selections from his Writings and Speeches*. His wife, Helen Eliza Benson, died in 1876. Four sons and one daughter survived them.

Garrison's son, WILLIAM LLOYD GARRISON (1838-1909), was a prominent advocate of the single tax, free trade, woman's suffrage, and of the repeal of the Chinese Exclusion Act, and an opponent of imperialism; another son, WENDELL PHILLIPS GARRISON (1840-1907), was literary editor of the *New York Nation* from 1865 to 1906.

The above article, with certain modifications, reproduces the account given in the 9th edition of this work by Oliver Johnson (reprinted from his *Garrison: an Outline of his Life*, New York, 1879). The writer (1809-1889) was a prominent Abolitionist, editor, and an intimate friend of Garrison; he edited the *Liberator* during Garrison's absence in England in 1833, and later was an editor or an associate editor of various journals, including, after the Civil War, the *New York Tribune* and the *New York Evening Post*. He also published an excellent brief biography in *William Lloyd Garrison and his Times* (Boston, 1880).

The great authority on the life of Garrison is the thorough and candid work of his sons, W. P. and F. J. Garrison, *William Lloyd Garrison 1805-1879: The Story of his Life told by his Children* (4 vols., New York, 1885-1886), which is indispensable for the student of the anti-slavery struggle in America. Goldwin Smith's *The Moral Crusader: a Biographical Essay on William Lloyd Garrison* (New York, 1892) is a brilliant sketch.

GARRISON, originally a term for stores or supplies, also a defence or protection, now confined in meaning to a body of troops stationed in a town or fortress for the purpose of defence. In form the word is derived from *O. Fr. garison*, modern *guerrison*, from *guerir*, to furnish with stores, to preserve, but in its later meaning it has been confused with the *Fr. garnison*, the regular word for troops stationed for purposes of defence. In English "garrison" was used till the 16th century, when "garison" took its place. In the British army "garrison troops," especially "garrison artillery," are troops trained and employed for garrison work as distinct from field operations.

GARROTE (Spanish for "cudgel"), an appliance used in Spain and Portugal for the execution of criminals condemned to death. The criminal is conducted to the place of execution (which is public) on horseback or in a cart, wearing a black tunic, and is attended by a procession of priests, &c. He is seated on a scaffold fastened to an upright post by an iron collar (the garrote), and a knob worked by a screw or lever dislocates his spinal column, or a small blade severs the spinal column at the base of the brain. (See CAPITAL PUNISHMENT.) Originally a stout cord or bandage was tied round the neck of the criminal, who was seated in a chair fixed to a post. Between the cord and the neck a stick was inserted (hence the name) and twisted till strangulation ensued.

"Garrotting" is the name given in England to a form of robbery with violence which became rather common in the winter of 1862-1863. The thief came up behind his victim, threw a cord over his head, and tightened it nearly to strangulation point, while robbing him. An act of 1863, imposing the penalty of flogging in addition to penal servitude for this offence, had the effect of stopping garrotting almost entirely. At any rate, the practice was checked; and, though the opponents of any sort of flogging refuse to admit that this was due to the penalty, that view has always been taken by the English judges who had experience of such cases.

GARRUCHA, a seaport of south-eastern Spain, in the province of Almeria; on the Mediterranean Sea and on the right bank of the river *Antas*. Pop. (1900) 4461. The harbour of Garrucha,

which is defended by an ancient castle, affords shelter to large ships, and is the natural outlet for the commerce of a thriving agricultural and mining district. Despite its small size and the want of railway communication, Garrucha has thus a considerable trade in lead, silver, copper, iron, esparto grass, fruit, &c. Besides sea-going ships, many small coasters enter in ballast, and clear with valuable cargoes. In 1902, 135 vessels of 390,000 tons entered the harbour, the majority being British or Spanish; and in the same year the value of the exports reached £478,000, and that of the imports £128,000. Both imports and exports trebled their value in the ten years 1892-1902.

GARSTON, a seaport in the Widnes parliamentary division of Lancashire, England, on the Mersey, 6 m. S.E. of Liverpool. Pop. (1891) 13,444; (1901) 17,289. The docks, belonging to the London & North Western railway company, employ most of the working population. There is about a mile of quays, with special machinery for the shipping of coal, which forms the chief article of export.

GARTH. SIR SAMUEL (1661-1719), English physician and poet, was born of a good Yorkshire family in 1661. He entered Peterhouse, Cambridge, in 1676, graduating B.A. in 1679 and M.A. in 1684. He took his M.D. and became a member of the College of Physicians in 1691. In 1697 he delivered the Harvard oration, in which he advocated a scheme dating from some ten years back for providing dispensaries for the relief of the sick poor, as a protection against the greed of the apothecaries. In 1699 he published a mock-heroic poem, *The Dispensary*, in six cantos, which had an instant success, passing through three editions within a year. In this he ridiculed the apothecaries and their allies among the physicians. The poem has little interest at the present day, except as a proof that the heroic couplet was written with smoothness and polish before the days of Pope. Garth was a member of the Kit-Kat Club, and became the leading physician of the Whigs, as Radcliffe was of the Tories. In 1714 he was knighted by George I. and he died on the 18th of January 1719. He wrote little besides his best-known work *The Dispensary* and *Claremont*, a moral epistle in verse. He made a Latin oration (1700) in praise of Dryden and translated the *Life of Otho* in the fifth volume of Dryden's *Plutarch*. In 1717 he edited a translation of Ovid's *Metamorphoses*, himself supplying the fourteenth and part of the fifteenth book.

GARTOK, a trade-market of Tibet, situated on the bank of the Indus on the road between Shigatse and Leh, to the east of Simla. In accordance with the Tibet treaty of 1904, Gartok, together with Yatung and Gyantse, was thrown open to British trade. On the return of the column from Lhasa in that year Gartok was visited by a party under Captain Ryder, who found only a few dozen people in winter quarters, their houses being in the midst of a bare plain. In summer, however, all the trade between Tibet and Ladakh passes through this place.

GARY, a city of Lake county, Indiana, U.S.A., at the southern end of Lake Michigan, about 25 m. S.E. of Chicago, Ill. Pop. (1910 census) 16,802. Gary is served by the Baltimore & Ohio, the Lake Shore & Michigan Southern, the Michigan Central, the Pennsylvania, the Wabash, and (for freight only) the Chicago, Lake Shore & Eastern, and the Indiana Harbor Belt railways, and by several steamship lines plying the Great Lakes. There are about 21 sq. m. within the municipal limits, but the city lies chiefly within a tract of about 8000 acres composed at the time of its settlement mainly of sand dunes and swamps intersected from east to west by the Grand Calumet and the Little Calumet rivers, small streams respectively about 1 and 3 m. S. of the lake shore. In 1906 the United States Steel Corporation bought this tract to establish on it a great industrial community, as direct water connexion with the Lake Superior ore region was possible, and it was comparatively accessible to West Virginia coal and Michigan limestone, with unusual railroad facilities. The Steel Corporation began the actual building of the town in June 1906, the first step being the installation of an elaborate system of sewers, and of mains and conduits, for the distribution of water, gas and electricity. The water-supply is taken from the lake at a point 2 m. offshore by means of a tunnel. These public

utilities the Steel Corporation controls, and it has built about 500 dwellings, two hotels, a bank, and its own plant. A small patch of land, now within the limits of the city, has been from the beginning in the hands of private owners, but the remainder of the lots (except those already sold) are owned by the Steel Corporation, and are sold under certain restrictions intended to prevent real estate speculation, to guarantee bona fide improvement of the property, and to restrict the sale of intoxicating drinks. Between the Grand Calumet river (which has been dredged out into a canal) and the lake lies the plant of the Steel Corporation, covering about 1200 acres. All the machinery in this great plant is driven by electricity from generators whose motive power is supplied by the combustion of gases from the blast furnaces. From the same sources is also supplied the electricity for lighting the city. The rail mill is operated by three-phase induction motors of from 2000 to 6000 horse-power capacity. The city was chartered in 1906 and was named in honour of Elbert Henry Gary (b. 1846), chairman of the board of directors and chairman of the finance committee of the United States Steel Corporation.

GAS, a general term for one of the three states of aggregation of matter; also more specifically applied to coal-gas, the gaseous product formed in the destructive distillation of coal or other carbonaceous matter (see below, section *Gas Manufacture*; for gas engines see the separate heading *GAS ENGINE*).

The Gaseous State.—Matter is studied under three physical phases—solids, liquids and gases, the latter two being sometimes grouped as "fluids." The study of the physical properties of fluids in general constitutes the science of hydromechanics, and their applications in the arts is termed hydraulics; the special science dealing with the physical properties of gases is named pneumatics.

The gaseous fluid with which we have chiefly to do is our atmosphere. Though practically invisible, it appeals in its properties to other of our senses, so that the evidences of its presence are manifold. Thus we feel it in its motion as wind, and observe the dynamical effects of this motion in the quiver of the leaf or the motion of a sailing ship. It offers resistance to the passage of bodies through it, destroying their motion and transforming their energy—as is betrayed to our hearing in the whiz of the rifle bullet, to our sight in the flash of the meteor.

The practically obvious distinction between solids and fluids may be stated in dynamical language thus:—solids can sustain a longitudinal pressure without being supported by a lateral pressure; fluids cannot. Hence any region of space enclosed by a rigid boundary can be easily filled with a fluid, which then takes the form of the bounding surface at every point of it. But here we distinguish between fluids according as they are gases or liquids. The gas will always completely fill the region, however small the quantity put in. Remove any portion and the remainder will expand so as to fill the whole space again. On the other hand, it requires a definite quantity of liquid to fill the region. Remove any portion and a part of the space will be left unoccupied by liquid. Part of the liquid surface is then otherwise conditioned than by the form of the wall or bounding surface of the region; and if the portion of the wall not in contact with the liquid is removed the form and quantity of the liquid are in no way affected. Hence a liquid can be kept in an open vessel; a gas cannot so be. To quote the differentia of Sir Oliver Lodge: "A solid has volume and shape; a liquid has volume, but no shape; a gas has neither volume nor shape."

It is necessary to distinguish between a gas and a "vapour." The latter possesses the physical property stated above which distinguishes a gas from a fluid, but it differs from a gas by being readily condensible to a liquid, either by lowering the temperature or moderately increasing the pressure. The study of the effects of pressure and temperature on many gases led to the introduction of the term "permanent gases" to denote gases which were apparently not liquefiable. The list included hydrogen, nitrogen and oxygen; but with improved methods these gases have been liquefied and even solidified, thus rendering the term meaningless (see *LIQUID GASES*). The term "perfect gas" is applied to an

imaginary substance in which there is no frictional retardation of molecular motion; or, in other words, the time during which any molecule is influenced by other molecules is infinitesimally small compared with the time during which it traverses its mean free path. It serves as a means of research, more particularly in mathematical investigations, the simple laws thus deduced being subsequently modified by introducing assumptions in order to co-ordinate actual experiences.

The gaseous state was well known to the ancients; for instance, in Greek cosmology, "air" (*αἴρ*) was one of the fundamental elements. The alchemists used such terms as *spiritus*, *fatus*, *halitus*, *aura*, *emanatio nubila*, &c., words implying a "wind" or "breath." The word "gas" was invented by J. B. van Helmont in his *Ortus medicinae*, posthumously published in 1648, in the course of his description of the gas now known as carbon dioxide. He found that charcoal on burning yielded a "spirit," which he named *spiritus sylvestris* on account of its supposed untamable nature ("Gas sylvestre sive incōcōribile, quod in corpus cogi non potest visibile"); and he invented the word "gas" in the expression: ". . . this spirit, hitherto unknown, . . . I call by a new name gas" ("hunc spiritum, incognitum hactenus, novo nomine gas voco"). The word was suggested by the Gr. *χάος*, chaos, for he also writes: "I have called this spirit gas, it being scarcely distinguishable from the Chaos of the ancients" ("halitum illum Gas vocavi, non longe a Chao veterum secretum"). The view that the word was suggested by the Dutch *geest*, spirit, is consequently erroneous. Until the end of the 18th century the word "air," qualified by certain adjectives, was in common use for most of the gases known—a custom due in considerable measure to the important part which common air played in chemical and physical investigations.

The study of gases may be divided into two main branches: the physical and the chemical. The former investigates essentially general properties, such as the weight and density, the relation between pressure, volume and temperature (piezometric and thermometric properties), calorimetric properties, diffusion, viscosity, electrical and thermal conductivity, &c., and generally properties independent of composition. These subjects are discussed in the articles *DENSITY*; *THERMOMETRY*; *CALORIMETRY*; *DIFFUSION*; *CONDUCTION OF HEAT*; and *CONDENSATION OF GASES*. The latter has for its province the preparation, collection and identification of gases, and the volume relations in which they combine; in general it deals with specific properties. The historical development of the chemistry of gases—pneumatic chemistry—is treated in the article *CHEMISTRY*; the technical analysis of gaseous mixtures is treated below under *Gas Analysis*. Connecting the experimental study of the physical and chemical properties is the immense theoretical edifice termed the kinetic theory of gases. This subject, which is discussed in the article *MOLECULE*, has for its purpose (1) the derivation of a physical structure of a gas which will agree with the experimental observations of the diverse physical properties, and (2) a correlation of the physical properties and chemical composition.

Gas Analysis.—The term "gas analysis" is given to that branch of analytical chemistry which has for its object the quantitative determination of the components of a gaseous mixture. The chief applications are found in the analysis of flue gases (in which much information is gained as to the completeness and efficiency of combustion), and of coal gas (where it is necessary to have a product of a definite composition within certain limits). There are, in addition, many other branches of chemical technology in which the methods are employed. In general, volumetric methods are used, i.e. a component is absorbed by a suitable reagent and the diminution in volume noted, or it is absorbed in water and the amount determined by titration with a standard solution. Exact analysis is difficult and tedious, and consequently the laboratory methods are not employed in technology, where time is an important factor and moderate accuracy is all that is necessary. In this article an outline of the technical practice will be given.

The apparatus consists of (1) a measuring vessel, and (2) a

series of absorption pipettes. A convenient form of measuring vessel is that devised by W Hempel. It consists of two vertical tubes provided with feet and connected at the bottom by flexible rubber tubing. One tube, called the "measuring tube," is provided with a capillary stopcock at the top and graduated downwards; the other tube, called the "level tube," is plain and open. To use the apparatus, the measuring tube is completely filled with water by pouring water into both tubes, raising the level tube until water overflows at the stopcock, which is then turned. The test gas is brought to the stopcock, by means of a fine tube which has been previously filled with water or in which the air has been displaced by running the gas through. By opening the stopcock and lowering the level tube any desired quantity of the gas can be aspirated over. In cases where a large quantity of gas, *i.e.* sufficient for several tests, is to be collected, the measuring tube is replaced by a large bottle.

The volume of the gas in the measuring tube is determined by bringing the water in both tubes to the same level, and reading the graduation on the tube, avoiding parallax and the other errors associated with recording the coincidence of a graduation with a

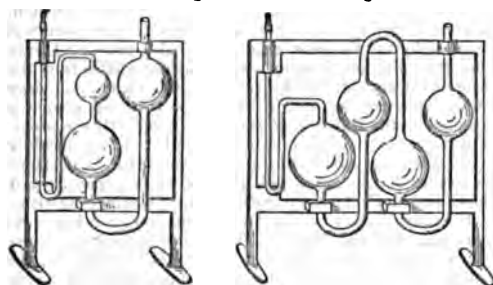

FIG. 1. (By permission of Messrs Baird & Tatlock.)

FIG. 2.

meniscus. The temperature and atmospheric pressure are simultaneously noted. If the tests be carried out rapidly, the temperature and pressure may be assumed to be constant, and any diminution in volume due to the absorption of a constituent may be readily expressed as a percentage. If, however, the temperature and pressure vary, the volumes are reduced to 0° and 760 mm. by means of the formula $V_0 = V(P - p) / (1 + 0.0366t) 760$, in which V is the observed volume, P the barometric pressure, p the vapour tension of water at the temperature t of the experiment. This reduction is facilitated by the use of tables.

Some common forms of absorption pipettes are shown in figs. 1 and 2. The simpler form consists of two bulbs connected at the bottom by a wide tube. The lower bulb is provided with a smaller bulb bearing a capillary through which the gas is led to the apparatus, the higher bulb has a wider outlet tube. The arrangement is mounted vertically on a stand. Sometimes the small bulb on the left is omitted. The form of the pipette varies with the nature of the absorbing material. For solutions which remain permanent in air the two-bulb form suffices; in other cases a composite pipette (fig. 2) is employed, in which the absorbent is protected by a second pipette containing water. In the case of solid reagents, *e.g.* phosphorus, the absorbing bulb has a tubulure at the bottom. To use a pipette, the absorbing liquid is brought to the outlet of the capillary by tilting or by squeezing a rubber ball fixed to the wide end, and the liquid is maintained there by closing with a clip. The capillary is connected with the measuring tube by a fine tube previously filled with water. The clip is removed, the stopcock opened, and the level tube of the measuring apparatus raised, so that the gas passes into the first bulb. There it is allowed to remain, the pipette being shaken from time to time. It is then run back into the measuring tube by lowering the level tube, the stopcock is closed, and the volume noted. The operation is repeated until there is no further absorption.

The choice of absorbents and the order in which the gases are to be estimated is strictly limited. Confining ourselves to cases where titration methods are not employed, the general order is as follows: carbon dioxide, olefines, oxygen, carbon monoxide, hydrogen, methane and nitrogen (by difference). This scheme is particularly applicable to coal-gas. Carbon dioxide is absorbed by a potash solution containing one part of potash to between two and three of water; the stronger solution absorbs about 40 volumes of the gas. The olefines—ethylene, &c.—are generally absorbed by a very strong sulphuric acid prepared by adding sulphur trioxide to sulphuric acid to form a mixture which solidifies when slightly cooled. Bromine water is also employed. Oxygen is absorbed by stick phosphorus contained in a tubulated pipette filled with water. The temperature must be above 15° ; and the absorption is prevented by ammonia, olefines, alcohol, and some other substances. An alkaline solution of pyrogallol is also used; this solution rapidly absorbs oxygen, becoming black in colour, and it is necessary to prepare the solution immediately before use. Carbon monoxide is absorbed by a solution of cuprous chloride in hydrochloric acid or, better, in ammonia. When small in amount, it is better to estimate as carbon dioxide by burning with oxygen and absorbing in potash; when large in amount, the bulk is absorbed in ammoniacal cuprous chloride and the residue burned. Hydrogen may be estimated by absorption by heated palladium contained in a capillary through which the gas is passed, or by exploding (under reduced pressure) with an excess of oxygen, and measuring the diminution in volume, two-thirds of which is the volume of hydrogen. The explosion method is unsatisfactory when the gas is contained over water, and is improved by using mercury. Methane cannot be burnt in this way even when there is much hydrogen present, and several other methods have been proposed, such as mixing with air and aspirating over copper oxide heated to redness, or mixing with oxygen and burning in a platinum tube heated to redness, the carbon dioxide formed being estimated by absorption in potash. Gases soluble in water, such as ammonia, hydrochloric acid, sulphuretted hydrogen, sulphur dioxide, &c., are estimated by passing a known volume of the gas through water and titrating the solution with a standard solution. Many types of absorption vessel are in use, and the standard solutions are generally such that 1 c.c. of the solution corresponds to 1 c.c. of the gas under normal conditions.

Many forms of composite gas-apparatus are in use. One of the commonest is the Orsat shown in fig. 3. The gas is measured in the graduated cylinder on the right, which is surrounded by a water jacket and provided with a levelling bottle. At the top it is connected by a capillary tube bent at right angles to a series of absorbing vessels, the connexion being effected by stopcocks. These vessels consist of two vertical cylinders joined at the bottom by a short tube. The cylinder in direct communication with the capillary is filled with glass tubes so as to expose a larger surface of the absorbing solution to the gas. The other cylinder is open to the air and serves to hold the liquid ejected from the absorbing cylinder. Any number of bulbs can be attached to the horizontal capillary; in the form illustrated there are four, the last being a hydrogen pipette in which the palladium is heated in a horizontal tube by a spirit lamp. At the end of the horizontal tube there is a three-way cock connecting with the air or an aspirator. To use the apparatus, the measuring tube is completely filled with water by raising the levelling bottle. The absorbing vessels are then about half filled with the absorbents, and, by opening the cocks and aspirating, the liquid is brought so as

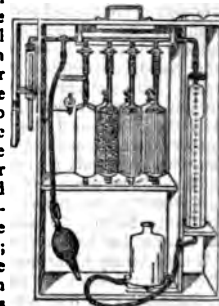

(By permission of Messrs Baird & Tatlock.)

FIG. 3.

completely to fill the bulbs nearer the capillary. The cocks are then closed. By opening the three-way cock to the supply of the test gas and lowering the levelling bottle, any desired amount can be drawn into the measuring tube. The absorption is effected by opening the cock of an absorbing vessel and raising the levelling bottle. The same order of absorption and general directions pertaining to the use of Hempel pipettes have to be adopted.

Although the earliest attempts at gas analysis were made by Scheele, Priestley, Cavendish, Lavoisier, Dalton, Gay-Lussac and others, the methods were first systematized by R. Bunsen, who began his researches in 1838. He embodied his results in his classical *Gasometrische Methoden* (1857, second edition 1877), a work translated into English by H. Roscoe. Clemens Winkler contributed two works, *Anleitung zur chemischen Untersuchung der Industrie-gase* (1876-1877) and *Lehrbuch der technischen Gasanalyse* (2nd ed., 1892), both of which are very valuable for the commercial applications of the methods. W. Hempel's researches are given in his *Neue Methode zur Analyse der Gase* (1880) and *Gasanalytische Methoden* (1890, 3rd ed. 1900).

GAS MANUFACTURE

1. *Illuminating Gas*.—The first practical application of gas distilled from coal as an illuminating agent is generally ascribed to William Murdoch, who between the years 1792 and 1802 demonstrated the possibility of making gas from coal and using it as a lighting agent on a large scale. Prior to 1691, however, Dr John Clayton, dean of Kildare, filled bladders with inflammable gas obtained by the distillation of coal, and showed that on pricking the bladders and applying a light to the escaping gas it burnt with a luminous flame, and in 1726 Stephen Hales published the fact that by the distillation of 158 grains of Newcastle coal, 180 cub. in. of inflammable air would be obtained. Jean Pierre Minckelers, professor of natural philosophy in the university of Louvain, and later of chemistry and physics at Maestricht, made experiments on distilling gas from coal with the view of obtaining a permanent gas sufficiently light for filling balloons, and in 1785 experimentally lighted his lecture room with gas so obtained as a demonstration to his students, but no commercial application was made of the fact. Lord Dundonald, in 1787, whilst distilling coal for the production of tar and oil, noticed the formation of inflammable gas, and even used it for lighting the hall of Culross Abbey. It is clear from these facts that, prior to Murdoch's experiments, it was known that illuminating gas could be obtained by the destructive distillation of coal, but the experiments which he began at Redruth in 1792, and which culminated in the lighting of Messrs Boulton, Watt & Co.'s engine works at Soho, near Birmingham, in 1802, undoubtedly demonstrated the practical possibility of making the gas on a large scale, and burning it in such a way as to make coal-gas the most important of the artificial illuminants. An impression exists in Cornwall, where Murdoch's early experiments were made, that it was a millwright named Hornblower who first suggested the process of making gas to Murdoch, but, as has been shown, the fact that illuminating gas could be obtained from coal by distillation was known a century before Murdoch made his experiments, and the most that can be claimed for him is that he made the first successful application of it on a practical scale.

In 1799 a Frenchman named Philippe Lebon took out a patent in Paris for making an illuminating gas from wood, and gave an exhibition of it in 1802, which excited a considerable amount of attention on the European continent. It was seen by a German, F.A. Winsor, who made Lebon an offer for his secret process for Germany. This offer was, however, declined, and Winsor returned to Frankfurt determined to find out how the gas could be made. Having quickly succeeded in discovering this, he in 1803 exhibited before the reigning duke of Brunswick a series of experiments with lighting gas made from wood and from coal. Looking upon London as a promising field for enterprise, he came over to England, and at the commencement of 1804 took the Lyceum theatre, where he gave demonstrations

of his process. He then proceeded to float a company, and in 1807 the first public street gas lighting took place in Pall Mall, whilst in 1809 he applied to parliament to incorporate the National Heat and Light Company with a capital of half a million sterling. This application was opposed by Murdoch on the ground of his priority in invention, and the bill was thrown out, but coming to parliament for a second time in 1810, Winsor succeeded in getting it passed in a very much curtailed form, and, a charter being granted later in 1812, the company was called the Chartered Gas Light and Coke Company, and was the direct forerunner of the present London Gas Light and Coke Company. During this period Frederick C. Accum (1769-1838), Dr W. Henry and S. Clegg did so much by their writings and by the improvements they introduced in the manufacture, distribution and burning of coal gas, that their names have become inseparably connected with the subject.

In 1813 Westminster Bridge, and in the following year the streets of Westminster, were lighted with gas, and in 1816 it became common in London. After this so rapid was the progress of this new mode of illumination that in the course of a few years it was adopted by all the principal towns in the United Kingdom for lighting streets as well as shops and public edifices. In private houses it found its way more slowly, partly from an apprehension of danger attending its use, and partly from the discomfort which was experienced in many cases through the gas being distributed without purification, and to the careless and imperfect manner in which the service pipes were first fitted. It was during the last four decades of the 19th century that the greatest advance was made, this period having been marked not only by many improvements in the manufacture of illuminating gas, but by a complete revolution in the methods of utilizing it for the production of light. In 1875 the London Argand, giving a duty of 3.2 candles illuminating power per cubic foot of ordinary 16 candle gas, was looked upon as the most perfect burner of the day, and little hope was entertained that any burner capable of universal adoption would surpass it in its power of developing light from the combustion of coal gas; but the close of the century found the incandescent mantle and the atmospheric burner yielding six times the light that was given by the Argand for the consumption of an equal volume of gas, and to-day, by supplying gas at an increased pressure, a light of ten times the power may be obtained. Since the advent of the incandescent mantle, the efficiency of which is dependent upon the heating power of the gas more than on its illuminating power, the manufacture of coal gas has undergone considerable modifications.

Coal, the raw material from which the gas is produced by a process of destructive distillation, varies very widely in composition (see COAL), and it is only the class of coals rich in hydrogen, known as bituminous coal, that can with advantage be utilized in gas manufacture. Coals of this character are obtained in England from the Newcastle and Durham fields, South Yorkshire, Derbyshire and Barnsley districts, and an idea of their ultimate composition may be derived from the following table:—

	Carbon.	Hydrogen.	Sulphur.	Nitrogen.	Oxygen.	Ash.	Moisture.
Newcastle gas coal . . .	82.16	4.83	1.00	1.23	6.82	3.20	0.76
Durham gas coal . . .	84.34	5.30	0.73	1.73	4.29	2.42	1.14
South Yorkshire silkstone . . .	80.46	5.09	1.66	1.67	6.79	3.30	1.03
Derbyshire silkstone . . .	76.96	5.04	2.39	1.77	6.92	3.28	3.64
Barnsley gas coal . . .	75.64	4.94	2.84	1.65	7.25	4.28	3.40

Our knowledge of the composition of coal is limited to the total amount of carbon, hydrogen, nitrogen, oxygen and foreign materials which it contains; and at present we know practically but little of the way in which these bodies are combined. This being so, the ordinary analysis of a coal affords but little indication of its value for gas-making purposes, which can only be really satisfactorily arrived at by extended use on a practical scale. Bituminous coal, however, may be looked upon as containing carbon and also simple hydrocarbons, such as some of the higher members of the paraffin series, and likewise organic bodies containing carbon, hydrogen, nitrogen, oxygen and sulphur.

On submitting a complex substance of this character to destructive distillation, it will be found that the yield and quality of the products will vary very considerably with the temperature existing in the retorts, with the size of the charge of coal used, with its distribution

The growth of gas lighting.

Coals used for gas-making.

in the retort, with the length of time the distillation has been going on, and with an infinity of other factors of a more or less complex nature. If bituminous coal is distilled at a low temperature, the tar is found to contain considerable quantities of light paraffin oils; and there is no doubt that paraffin hydrocarbons are present in the original coal. These paraffins, under the influence of heat, split up into simpler members of the same series and into olefines; and if we imagine the action in its simplest form, we should have the gases, as they were evolved, consisting of (say) ethane and ethylene. These have now to pass down the heated retort on their way to the ascension pipe, and the contact with the heated sides of the retort, and the baking from the radiant heat in the retort, set up an infinity of changes. Ethane, when heated to this degree, splits up into ethylene and hydrogen, whilst ethylene decomposes to methane and acetylene, and the acetylene at once polymerizes to benzene, styrolene, retene, &c. A portion also condenses, and at the same time loses some hydrogen, becoming naphthalene; and the compounds so formed by interactions amongst themselves build up the remainder of the hydrocarbons present in the coal tar, whilst the organic substances containing oxygen in the coal break down, and cause the formation of the phenols in the tar.

There is very little doubt that the general course of the decompositions follows these lines; but any such simple explanation of the actions taking place is rendered impossible by the fact that, instead of the breaking-down of the hydrocarbons being completed in the coal, and only secondary reactions taking place in the retort, in practice the hydrocarbons to a great extent leave the coal as the vapours of condensable hydrocarbons, and the breaking down of these to such simple gaseous compounds as ethylene is proceeding in the retort at the same time as the breaking up of the ethylene already formed into acetylene and methane, and the polymerization of the former into higher compounds. Starting with a solid hydrocarbon of definite composition, it would be theoretically possible to decompose it entirely into carbon, hydrogen, ethylene and methane, and, by rapidly removing these from the heating zone before any secondary actions took place, to prevent formation of tar. But any such ideal is hopeless in practice, as the coal is not a definite compound, and it is impossible to subject it to a fixed temperature.

If the retorts are at a temperature of 1000° C. when the charge of coal is put in, the temperature of the distillation will vary from about 800° C. close to the walls, to about 400° C. in the centre of the coal; and in the same way, in the space above the coal, the products which come in contact with the sides of the retort are heated to 1000° C., whilst the gas near the coal is probably heated to only 600° C. Moreover, the gases and vapours in the retort are subjected to a period of heating which varies widely with the distance from the mouth of the retort of the coal that is undergoing carbonization. The gas developed by the coal near the mouth of the retort is quickly washed out into the ascension pipe by the push of the gas behind, and the period for which it has been exposed to the radiant heat from the walls of the retort is practically nil; whilst the gas evolved in the portion of the retort farthest from the mouthpiece has only its own rate of evolution to drive it forward, and has to traverse the longest run possible in the retort, exposed during the whole of that period to radiant heat and to contact with the highly heated surface of the retort itself. Hence we find that the tar is formed of two distinct sets of products, the first due to incomplete decomposition and the second to secondary reactions due to the products of the decomposition being kept too long in the zone of heat.

Of the first class, the light paraffin oils and pitch may be taken as examples; whilst benzene, naphthalene and retort carbon represent the second. The formation of the second class of bodies is a great loss to the gas manufacturer, as, with the exception of the trace of benzene carried with the gas as vapour, these products are not only useless in the gas, but one of them, naphthalene, is a serious trouble, because any trace carried forward by the gas condenses with sudden changes of temperature, and causes obstructions in the service pipes, whilst their presence in the tar means the loss of a very large proportion of the illuminating constituents of the gas. Moreover, these secondary products cannot be successfully reduced, by further heating, to simpler hydrocarbons of any high illuminating value, and such bodies as naphthalene and anthracene have so great a stability that, when once formed, they resist any efforts again to decompose them by heat, short of the temperature which breaks them up into methane, carbon and hydrogen.

The ammonia is derived from the nitrogen present in the coal combining with hydrogen during destructive distillation, the nitrogen becoming distributed amongst all three classes of products. The following table will give an approximate idea of the proportions which go to each:—

	Per cent.
Nitrogen as ammonia	14.50
“ as cyanogen	1.56
“ free in gas and combined in tar	35.26
“ remaining in coke	48.68
	100.00

The effect produced by alteration in the temperature of the retort upon the composition of both gas and tar is very marked. As the temperature is raised, the yield of gas from a given weight of coal increases; but with the increase of volume there is a marked decrease in the illuminating value of the gas evolved. Lewis T. Wright found, in a series of experiments, that, when four portions of the same coal were distilled at temperatures ranging from a dull red heat to the highest temperature attainable in an iron retort, he obtained the following results as to yield and illuminating power:—

Temperature.	Cubic ft. of Gas per ton.	Illuminating Power, Candles.	Total Candles per ton.
1. Dull red	8,250	20.5	33,950
2. Hotter	9,693	17.8	34,510
3. “	10,821	16.7	36,140
4. Bright orange	12,006	15.6	37,460

Composition of the Gas.

	1. Per cent.	2. Per cent.	4. Per cent.
Hydrogen	38.09	43.77	48.02
Marsh gas	42.72	34.50	30.70
Olefines	7.55	5.83	4.51
Carbon monoxide	8.72	12.50	13.96
Nitrogen	2.92	3.40	2.81
	100.00	100.00	100.00

The gas analysis of No. 3 was lost, but the illuminating power shows that it was intermediate in composition between Nos. 2 and 4. From this it will be seen that, with the increase of temperature, the hydrocarbons—the olefines and marsh gas series—gradually break up, depositing carbon in the crown of the retort, and liberating hydrogen, the percentage of which steadily increases with the rise of temperature.

The tar formed is affected to an even greater extent than the gas by alterations in the temperature at which the destructive distillation takes place. The lower the temperature, the smaller will be the volume of gas produced, and the lighter the specific gravity of the tar, whilst with increase of temperature, the volume of gas rapidly rises, and so does the specific gravity of the tar. Working with a caking coal Wright obtained the following results:—

Yield of Gas per ton, Cub. ft.	Specific Gravity of Tar.
6,600	1.086
7,200	1.120
8,900	1.140
10,162	1.154
11,700	1.206

Analysis of the tar showed that the increase of the specific gravity was due to the increase in the quantity of pitch, which rose from 28.89 to 64.08% in the residuals; whilst the ammonia, naphtha and light oils steadily fell in quantity, the creosote and anthracene oils doing the same, but to a smaller extent. Naphthalene also begins to show in quantity in the tar as soon as the yield of gas reaches 10,000 cub. ft. per ton of coal carbonized.

In spite of these variations, however, the products in their main characteristics will remain the same. They may be divided into—(a) Solids, such as the coke and retort carbon; (b) liquids, consisting of the tar and ammoniacal liquor; and (c) gases, consisting of the unpurified coal gas. The proportions in which the products are approximately obtained from a ton of gas coal have been given as follows:—

10,000 cub. ft. of gas = 380 lb = 17.0 per cent.
10 gallons of tar . . . = 115 “ = 5.1 “
Gas liquor ¹ = 177 “ = 7.9 “
Coke = 1568 “ = 70.0 “
2240 100.0

The chief solid residue, coke, is not absolutely pure carbon, as it contains the mineral non-volatile constituents which remain behind as ash when the original coal is burnt, and which, to a great extent, existed in the sap that filled the cells of the plant from which the coal was formed. The retort carbon formed as a dense deposit on the crown of the retort by the action of the high temperature on the hydrocarbons is, however, carbon in a very pure form, and, on account of its density, is largely used for electrical purposes.

¹ Liquor condensed from gas alone, without wash water.

The liquid products of the destructive distillation of coal are tar and ammoniacal liquor. Tar derived from ordinary bituminous coal is a black, somewhat viscid liquid, varying in specific gravity from 1.1 to 1.2. The ultimate composition of tar made in the London Gas Works is approximately as follows:—

Carbon	77.53
Hydrogen	6.33
Nitrogen	1.03
Sulphur	0.61
Oxygen	14.50

100.00

These elements in tar are built up into an enormous number of compounds (see COAL TAR), and its value as a by-product may be gathered from the fact that on fractional distillation it yields—(1) benzene and its homologues, from which aniline, the source of most of the coal-tar colours, can be derived; (2) carbolic acid, from which picric acid, used as a dye, a powerful explosive, and to give the bitter flavour to some kinds of beer, is made, also many most valuable disinfectants; (3) naphthalene, used for disinfecting, and also as the "Albo-carbon" employed in an enriching burner for gas; (4) pitch, extensively used in path-making, from which such bodies as anthracene and saccharin can be extracted.

The second liquid product of the destructive distillation of coal is the ammoniacal or gas liquor, which consists of water containing ammonia salts in solution, partly condensed from the hot gas, and partly added to wash the gas in the scrubbers. It contains, as its principal constituents, ammonia, partly combined with carbonic acid and sulphuretted hydrogen to form compounds which are decomposed on boiling, with evolution of ammonia gas, and partly combined with stronger acids to form compounds which require to be acted upon by a strong alkali before the ammonia contained in them can be liberated. The ammonia in the first class of compounds is technically spoken of as "free"; that present in the latter as "fixed." The following analysis by L. T. Wright will give an idea of the relative quantities in which these compounds exist in the liquor:—

	Grammes per litre.
Free	
Ammonium sulphide	3.03
Ammonium carbonate	39.16
Ammonium chloride	14.23
Ammonium thiocyanate	1.80
Fixed	
Ammonium sulphate	0.19
Ammonium thiosulphate	2.80
Ammonium ferrocyanide	0.41

From a scientific point of view, the term "free" is absolutely incorrect, and in using it the fact must be clearly borne in mind that in this case it merely stands for ammonia, which can be liberated on simply boiling the liquor.

The gas which is obtained by the destructive distillation of coal, and which we employ as our chief illuminant, is not a definite compound, but a mechanical mixture of several gases, some of which are reduced to the lowest limit, in order to develop as fully as possible the light-giving properties of the most important constituents of the gas. The following analysis gives a fair idea of the composition of an average sample of gas made from coal, purified but without enrichment:—

Hydrogen	52.22
Unsaturated hydrocarbons	3.47
Saturated hydrocarbons	34.76
Carbon monoxide	4.23
Carbon dioxide	0.60
Nitrogen	4.23
Oxygen	0.49

100.00

These constituents may be divided into—(a) light-yielding hydrocarbons, (b) combustible diluents and (c) impurities. The hydrocarbons, upon which the luminosity of the flame entirely depends, are divided in the analysis into two groups, saturated and unsaturated, according to their behaviour with a solution of bromine in potassium bromide, which has the power of absorbing those termed "unsaturated," but does not affect in diffused daylight the gaseous members of the "saturated" series of hydrocarbons. They may be separated in a similar way by concentrated sulphuric acid, which has the same absorbent effect on the one class, and not on the other. The chief unsaturated hydrocarbons present in coal gas are: ethylene, C_2H_4 , butylene, C_4H_8 , acetylene, C_2H_2 , benzene, C_6H_6 , and naphthalene, $C_{10}H_8$ and the saturated hydrocarbons consist chiefly of methane, CH_4 , and ethane, C_2H_6 .

The light-giving power of coal gas is undoubtedly entirely due to the hydrocarbons. The idea held up to about 1890 was that the illuminating value depended upon the amount of ethylene present. This, however, is manifestly incorrect, as, if it were true, 4% of ethylene mixed with 96% of a combustible diluent such as hydrogen should give 16- to 17-candle gas, whereas a mixture of 10% of ethylene and 90% of hydrogen is devoid of luminosity. In 1876

M.P.E. Berthelot came to the conclusion that the illuminating value of the Paris coal gas was almost entirely due to benzene vapour. But here again another mistaken idea arose, owing to a faulty method of estimating the benzene, and there is no doubt that methane is one of the most important of the hydrocarbons present, when the gas is burnt in such a way as to evolve from it the proper illuminating power, whilst the benzene vapour, small as the quantity is, comes next in importance and the ethylene last. It is the combined action of the hydrocarbons which gives the effect, not any one of them acting alone.

The series of operations connected with the manufacture and distribution of coal gas embraces the processes of distillation, condensation, exhaustion, wet purification by washing and scrubbing, dry purification, measuring, storing and distribution to the mains whence the consumer's supply is drawn.

The choice of a site for a gas works is necessarily governed by local circumstances; but it is a necessity that there should be a ready means of transport available, and for this reason the works should be built upon the banks of a navigable river or canal, and should have a convenient railway siding. By this means coal may be delivered direct to the store or retort-house, and in the same way residual products may be removed. The fact that considerable area is required and that the works do not improve the neighbourhood are important conditions, and although economy of space should be considered, arrangements should be such as to allow of extension. In the case of a works whose daily make of gas exceeds four to five million cub. ft., it is usual to divide the works into units, there being an efficiency limit to the size of apparatus employed. Under these conditions the gas is dealt with in separate streams, which mix when the holder is reached. From the accompanying ground plan of a works (fig. 4)

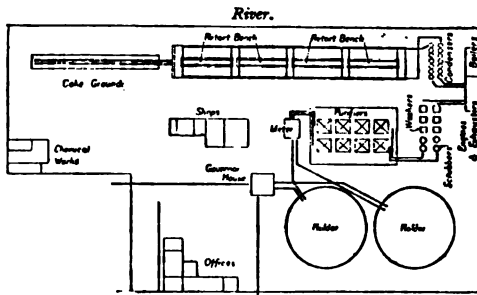

FIG. 4.—Plan of Works.

it will be possible to gain an idea of the order in which the operations in gas manufacture are carried out and the arrangement of the plant.

The retorts in which the coal is carbonized are almost universally made of fire-clay, and in all but small country works the old single-ended retort, which was about 9 ft. in length, has given way to a more economical construction known as doubles, double-ended, or "through" retorts. These are from 18 to 22 ft. long, and as it is found inconvenient to produce this length in one piece, they are manufactured in three sections, the jointing together of which demands great care. The two outer pieces are swelled at one end to take an iron mouthpiece. The cross sections generally employed for retorts are known as "D-shaped," "oval" and "round" (fig. 5). The "D" form is mostly adopted owing to its power of retaining its shape after long exposure to heat, and the large amount of heating surface it presents at its base. The life of this retort is about thirty working months. A cast iron mouthpiece and lid is bolted to the exterior end of each retort, the mouthpiece carrying a socket end to receive the ascension pipe, through which the gas passes on leaving the retort. The retorts are heated externally and are set in an arch, the construction depending upon the number of retorts, which varies from three to twelve. The arch and its retorts is termed a bed or setting, and a row of beds constitutes a bench. It is usual to have a separate furnace for each setting, the retorts resting upon walls built transversely in the furnace.

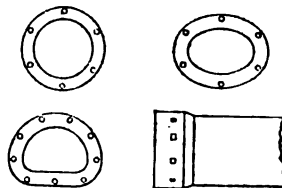

FIG. 5.—Cross Section of Retorts.

The heating of the retorts is carried out either by the "direct firing" or by the "regenerative" system, the latter affording

marked advantages over the former method, which is now becoming extinct. In the regenerative system of firing, a mixture of carbon monoxide and nitrogen is produced by passing air through incandescent gas coke in a generator placed below the bench of retorts, and the heating value of the gases so produced is increased in most cases by the admixture of a small proportion of steam with the primary air supply, the steam being decomposed by contact with the red-hot coke in the generator into water gas, a mixture of carbon monoxide and hydrogen (see *FUEL; GASES*). The gases so formed vary in proportion with the temperature of the generator and the amount of steam, but generally contain 32 to 38% of combustible gas, the remainder being the residual nitrogen of the air and carbon dioxide. These gases enter the combustion chamber around the retorts at a high temperature, and are there supplied with sufficient air to complete their combustion, this secondary air supply being heated by the hot products of combustion on their way to the exit flue. This method of firing results in the saving of about one-third the weight of coke used in the old form of furnace per ton of coal carbonized, and enables higher temperatures to be obtained, the heat being also more equally distributed.

There are a great number of methods of applying the regenerative principle which vary only in detail. Fig. 6 gives an idea of the general arrangement. The furnace A is built of fire-brick, coke is charged at the top through the iron door B, and near the bottom are placed fire bars C, upon which the fuel lies. The primary air necessary for the partial combustion of the coke to "producer" gas enters between these bars. The gases are conducted from the furnace to the combustion chamber E through the nostrils D, D, and the secondary air is

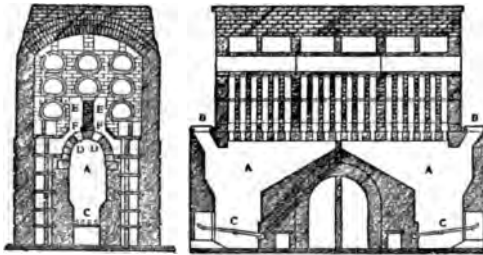

FIG. 6.—Regenerative Setting.

admitted at the inlet F a little above, this air having been already heated by traversing the setting. Complete combustion takes place at this point with the production of intense heat, the gases on rising are baffled in order to circulate them in every direction round the retorts, and upon arriving at the top of the setting they are conducted down a hollow chamber communicating with the main flue and shaft. The amount of draft which is necessary to carry out the circulation of the gases and to draw in the adequate amount of air is regulated by dampers placed in the main flue. By analysis of the "producer" and "spent" gases this amount can be readily gauged.

Retorts are set in either the horizontal, inclined or vertical position, and the advantages of the one over the other is a question upon which almost every gas engineer has his own views.

The introduction of labour-saving appliances into gas works has rendered the difficult work of charging and discharging horizontal retorts comparatively simple. Formerly it was the

Charging and drawing. practice to carry out such operations entirely by hand, men charging the retorts either by means of shovel or hand-scoop, and the coke produced being withdrawn with hand rakes. Now, however, only the smaller gas works adhere to this system, and this work is done by machinery driven by either compressed air, hydraulic or electric power. In the first two cases a scoop, filled with coal from an overhead hopper carried by the travelling machine, is made to enter the retort and is turned over; the operation is then repeated, but this time the scoop is turned over in the opposite direction, the coal thus assuming such a position that as much of its under surface as possible is exposed to the heated side of the retort. With "through" retorts charging machines feed the retorts at both ends, the scoop, which has a capacity of about 1½ cwt., entering and discharging its contents twice at each end, so that the total charge is about 6 cwt., which is allowed from four to six hours to distil off according to the quality of the gas required. The machines charge simultaneously at each end, so that the lids of the retorts may be shut immediately the coal enters. The charging machines travel on lines in front of the retort bench, and the power is transmitted by connections made with flexible hose. A device of more recent introduction is an electrically-driven charging machine, in which the centrifugal force created by a fly-wheel revolving at high speed is applied to drive coal into the retort. If the velocity is sufficiently high the coal may be carried the whole length of a 20-ft. retort, the coal following banking up until an even layer is formed throughout the length of the retort.

For the purpose of discharging the coke from the retort either compressed air or hydraulic machinery is employed, a rake being made to enter the retort and withdraw the coke on returning. With this method it is necessary that the rake should enter and discharge several times before the retort is clear, and thus the use of a telescopic ram worked by hydraulic power, which pushes the coke before it and discharges it at the other end, is an advantage. As much as one-third on each ton of coal carbonized is saved by the use of machinery in the retort-house. Taking into account the original cost of such machines, and the unavoidable wear and tear upon the retorts brought about by using labour-saving appliances, and the fact that the coke-dust is very detrimental to the machinery, it is clear that the suggestion of setting the retorts at an incline in order to facilitate the work presented great inducements to the gas manager. The object aimed at in thus setting retorts is to allow gravity to play the part of charging and discharging the coal and coke, the retorts being inclined at an angle to suit the slip of the class of coal used; this angle is between 28° and 34°. The coal, previously elevated to hoppers, is dropped into the feeding chambers, which are so arranged that they can travel from end to end of the retort-house and feed the coal into the retorts. When the retort is to be charged, an iron stop or barrier is placed in the lower mouthpiece, and the door closed. The shoot is placed in the upper mouthpiece, and the stop or door, which retains the coal in the chamber, is released; the coal is then discharged into the retort, and rushing down the incline, is arrested by the barrier, and banks up, forming a continuous backing to the coal following. By experience with the class of coal used and the adjustment of the stops in the shoot, the charge can be run into the retort to form an even layer of any desired depth. For the withdrawal of the residual coke at the end of the carbonization, the lower mouthpiece door is opened, the barrier removed and the coke in the lower part of the retort is "tickled" or gently stirred with an iron rod to overcome a slight adhesion to the retort; the entire mass then readily discharges itself. Guides are placed in front of the retort to direct its course to the coke hoppers or conveyer below, and to prevent scattering of the hot material. This system shows a greater economy in the cost of carbonizing the coal, but the large outlay and the wear and tear of the mechanical appliances involved have so far prevented its very general adoption.

The vertical retort was one of the first forms experimented with by Murdoch, but owing to the difficulty of withdrawing the coke, the low illuminating power of the gas made in it, and the damage to the retort itself, due to the swelling of the charge during distillation, it was quickly abandoned. About the beginning of the 20th century, however, the experiments of Messrs Settle and Padfield at Exeter, Messrs Woodall and Duckham at Bourne-mouth, and Dr Bueb in Germany showed such encouraging results that the idea of the vertical retort again came to the front, and several systems were proposed and tried. The cause of the failure of Murdoch's original vertical retort was undoubtedly that it was completely filled with coal during charging, with the result that the gas liberated from the lower portions of the retort had to pass through a deep bed of red-hot coke, which, by over-baking the gas, destroyed the illuminating hydrocarbons. There is no doubt that the question of rapidly removing the gas, as soon as it is properly formed, from the influence of the highly-heated walls of the retort and residual coke, is one of the most important in gas manufacture.

In the case of horizontal retorts the space between the top of the coal and the retort is of necessity considerable in order to permit the introduction of the scoop and rake; the gas has therefore a free channel to travel along, but has too much contact with the highly heated surface of the retort before it leaves the mouthpiece. In the case of inclined retorts this disadvantage is somewhat reduced, but with vertical retorts the ideal conditions can be more nearly approached. The heating as well as the illuminating value of the gas per unit volume is lowered by over-baking, and Dr Bueb gives the following figures as to the heating value of gas obtained from the same coal but by different methods of carbonization:—

Vertical Retorts, 604	British thermal units per cub. ft.	
Inclined	584	" "
Horizontal	570	" "

Of the existing forms of vertical retort it remains a matter to be decided whether the coal should be charged in bulk to the retort or whether it should be introduced in small quantities at regular and short intervals; by this latter means (the characteristic feature of the Settle-Padfield process) a continuous layer of coal is in process of carbonization on the top, whilst the gas escapes without contact with the mass of red-hot coke, a considerable increase in volume and value in the gas and a much denser coke being the result.

From the retort the gas passes by the ascension pipe to the hydraulic main (fig. 7). This is a long reservoir placed in a horizontal position and supported by columns upon the top of the retort stack, and through it is maintained a slow but constant flow of water, the level of which is kept uniform.

The ascension pipe dips about 2 in. into the liquid, and so makes a seal that allows of any retort being charged singly without the risk of the gas produced from the other retorts in the bench escaping

through the open retort. Coal gas, being a mixture of gases and vapours of liquids having very varying boiling points, must necessarily undergo physical changes when the temperature is lowered. Vapours of liquids of high boiling point will be condensed more quickly than those having lower boiling points, but condensation of each vapour will take place in a definite ratio with the decrease of temperature, the rate being dependent upon the boiling point of the liquid from which it is formed. The result is that from the time the gaseous mixture leaves the retort it begins to deposit condensation products owing to the decrease in temperature. Condensation takes place in the ascension pipe, in the arch piece leading to the hydraulic main, and to a still greater extent in the hydraulic main itself where the gas has to pass through water.

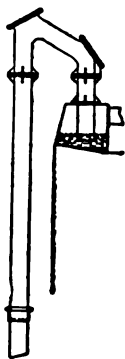

FIG. 7.—Hydraulic Main.

Liquor is run off at a constant rate from the hydraulic main to the store tank, and the gas passes from the top of the hydraulic main to the foul main.

The gas as it leaves the hydraulic main is still at a temperature of from 130° to 150° F., and should now be reduced as nearly as possible to the temperature of the surrounding atmosphere.

The operation of efficient condensing is not by any means as simple as might be supposed. The tar and liquor when condensed have a dissolving action on various valuable light-giving constituents of the gas, which in the ordinary way would not be deposited by the lowering of temperature, and for this reason the heavy tar, and especially that produced in the hydraulic main, should come in contact with the gas as little as possible, and condensation should take place slowly.

The main difficulty which the condenser ought to overcome and upon which its efficiency should depend is the removal of naphthalene: this compound, which is present in the gas, condenses on cooling to a solid which crystallizes out in the form of white flakes, and the trouble caused by pipe stoppages in the works as well as in the district supplied is very considerable. The higher the heat of carbonization the more naphthalene appears to be produced, and gas managers of to-day find the removal of naphthalene from the gas a difficult problem to solve. It was for some time debated as to whether naphthalene added materially to the illuminating value of the gas, and whether an endeavour should be made to carry it to the point of combustion; but it is now acknowledged that it is a troublesome impurity, and that the sooner it is extracted the better. Gas leaves the retorts saturated with naphthalene, and its capacity for holding that impurity seems to be augmented by the presence of water vapour. The condenser, by effecting the condensation of water vapour, also brings about the deposition of solid naphthalene, apart from that which naturally condenses owing to reduction of temperature.

Condensers are either air-cooled or water-cooled, or both. In the former case the gas traverses pipes exposed to the atmosphere and so placed that the resulting products of condensation may be collected at the lowest point. Water is a more efficient cooling medium than air, owing to its high specific heat, and the degree of cooling may be more easily regulated by its use. In water-cooled condensers it is usual to arrange that the water passes through a large number of small pipes contained in a larger one through which the gas flows, and as it constantly happened that condenser pipes became choked by naphthalene, the so-called reversible condenser, in which the stream of gas may be altered from time to time and the walls of the pipes cleaned by pumping tar over them, is a decided advance.

The solubility of naphthalene by various oils has led some engineers to put in naphthalene washers, in which gas is brought into contact with a heavy tar oil or certain fractions distilled from it, the latter being previously mixed with some volatile hydrocarbon to replace in the gas those illuminating vapours which the oil dissolves out; and by fractional distillation of the washing oil the naphthalene and volatile hydrocarbons are afterwards recovered.

The exhauster is practically a rotary gas pump which serves the purpose of drawing the gas from the hydraulic main through the condenser, and then forcing it through the purifying vessels to the holder. Moreover, by putting the retorts under a slight vacuum, the amount of gas produced is increased by about 12%, and is of better quality, owing to its leaving the

heated retort more quickly. A horizontal compound steam-engine is usually employed to drive the exhauster.

At this point in the manufacturing process the gas has already undergone some important changes in its composition, but there yet remain impurities which must be removed, these being ammonia, sulphuretted hydrogen, carbon disulphide and carbon dioxide. Ammonia is of considerable marketable value, and even in places where the local Gas Act does not prescribe that it shall be removed, it is extracted. Sulphuretted hydrogen is a noxious impurity, and its complete removal from the gas is usually imposed by parliament. As nearly as possible all the carbon dioxide is extracted, but most gas companies are now exempt from having to purify the gas from sulphur compounds other than sulphuretted hydrogen. Cyanogen compounds are also present in the gas, and in large works, where the total quantity is sufficient, their extraction is effected for the production of either prussiate or cyanide of soda.

Atkinson Butterfield gives the composition of the gas at this point to be about

	per cent. by vol.	
Hydrogen	from 42	to 53
Methane	" 32	" 39
Carbon monoxide	" 3	" 10
Hydrocarbons—		
Gases	" 2.5	" 4.5
Light condensable vapours	" 0.5	" 1.2
Carbon dioxide	" 1.1	" 1.8
Nitrogen	" 1.0	" 5.0
Sulphuretted hydrogen	" 1.0	" 2.0
Ammonia	" 0.5	" 0.95
Cyanogen	" 0.05	" 0.12
Carbon disulphide	" 0.02	" 0.035
Naphthalene	" 0.005	" 0.015

It happens that ammonia, being a strong base, will effect the extraction of a certain proportion of such compounds as sulphuretted hydrogen, carbon dioxide and hydrocyanic acid, and the gas is now washed with water and ammoniacal liquor.

The process is termed washing or scrubbing, and is carried out in various forms of apparatus, the efficiency of which is dependent upon the amount of contact the apparatus allows between the finely divided gas and water in a unit area and the facility with which it may be cleared out. The "Livesey" washer, a well-known type, is a rectangular cast iron vessel. The gas enters in the centre, and to make its escape again it has to pass into long wrought iron inverted troughs through perforations one-twentieth of an inch in diameter. A constant flow of liquor is regulated through the washer, and the gas, in order to pass through the perforations, drives the liquor up into the troughs. The liquor foams up owing to agitation by the finely divided streams of gas, and is brought into close contact with it. Two or three of these washers are connected in series according to the quantity of gas to be dealt with.

The final washing for ammonia is effected in an apparatus termed a "scrubber," which is a cylindrical tower packed with boards $\frac{1}{2}$ in. thick by 11 in. broad, placed on end and close together. Scrubbers water is caused to flow down over the surface of these boards, the object being to break up the gas as much as possible and bring it into close contact with the water. In this wet purifying apparatus the gas is almost wholly freed from ammonia and from part of the sulphuretted hydrogen, whilst carbon dioxide and carbon disulphide are also partially extracted.

The final purification is carried out in rectangular vessels, known as "dry purifiers" (fig. 8). Internally, each purifier is filled with ranges of wooden trays or sieves A, made in the form of grids (fig. 9), and covered with the purifying material B to a depth of about 6 in., the number of tiers and size of purifier boxes being proportional to the quantity of gas to be purified. The gas

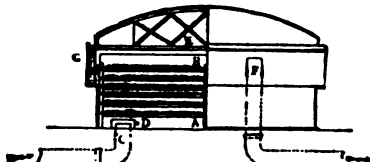

FIG. 8.—Purifier.

enters at the bottom by the pipe C, the inlet being protected from any falling material by the cover D; it forces its way upwards through all the trays until, reaching the lid or cover E, it descends by the exit tube F, which leads to the next purifier. The edges of the lid dip into an external water seal or lute G, whereby the gas is prevented from escaping.

When the gas had to be purified from carbon disulphide as well as from sulphuretted hydrogen, slaked lime was employed for the removal of carbon dioxide and the greater quantity of the sulphur compounds, whilst a catch box or purifier of oxide of iron served to remove the last traces of sulphuretted hydrogen. Not fewer than four lime purifiers were employed, and as the one which was first

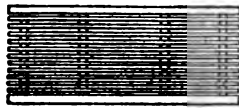

FIG. 9.—Purifier Grid.

in the series became exhausted, *i.e.* began to show signs of allowing carbon dioxide to pass through it unabsorbed, it was filled with fresh slaked lime and made the last of the series, the one which was second becoming first, and this procedure went on continuously. This operation was necessitated by the fact that carbon dioxide has the power of breaking up the sulphur compounds formed by the lime, so that until all carbon dioxide is absorbed with the formation of calcium carbonate, the withdrawal of sulphuretted hydrogen cannot proceed, whilst since it is calcium sulphide formed by the absorption of sulphuretted hydrogen by the slaked lime that absorbs the vapour of carbon disulphide, purification from the latter can only be accomplished after the necessary calcium sulphide has been formed. The foul gas leaving the scrubbers contains, as a general average, 30 grains of sulphuretted hydrogen, 40 grains of carbon disulphide and 200 grains of carbon dioxide per 100 cub. ft. On entering the first purifier, which contains calcium thiocarbonate and other combinations of calcium and sulphur in small quantity, the sulphuretted hydrogen and disulphide vapour have practically no action upon the material, but the carbon dioxide immediately attacks the calcium thiocarbonate, forming calcium carbonate with the production of carbon disulphide vapour, which is carried over with the gas into the second box. In the connexion between the first and the second box the gas is found to contain 500 grains of sulphuretted hydrogen and 80 grains of carbon disulphide per 100 cub. ft., but no trace of carbon dioxide. In the second box the formation of calcium thiocarbonate takes place by the action of carbon disulphide upon the calcium sulphide with the liberation of sulphuretted hydrogen, which is carried over to the third purifier. The gas in the connecting pipe between the second and third purifier will be found to contain 400 grains of sulphuretted hydrogen and 20 grains of carbon disulphide. The contents of the third box, being mostly composed of slaked lime, take up sulphuretted hydrogen forming calcium sulphide, and practically remove the remaining impurities, the outlet gas showing 20 grains of sulphuretted hydrogen and 8 grains of carbon disulphide per 100 cub. ft., whilst the catch box of oxide of iron then removes all traces of sulphuretted hydrogen. It will be noticed that in the earlier stages the quantity of sulphur impurities is actually increased between the purifiers—in fact, the greater amount of sulphiding procures the ready removal of the carbon disulphide,—but it is the carbon dioxide in the gas that is the disturbing element, inasmuch as it decomposes the combinations of sulphur and calcium; consequently it is a paramount objection in this system to prevent this latter impurity finding its way through the first box of the series. The finding of any traces of carbon dioxide in the gas between the first two boxes is generally the signal for a new clean purifier being put into action, and the first one shut off, emptied and recharged with fresh lime, the impregnated material being sometimes sold for dressing certain soils.

The action of oxide of iron, which has now partly replaced the lime purification, depends on its power of combining with sulphuretted hydrogen to form sulphide of iron. Such is the affinity of the oxide for this impurity that it may contain from 50 to 60% by weight of free sulphur after reactivation and still remain active. Upon removing the material from the vessel and exposing it to the atmosphere the sulphide of iron undergoes a reactivating process, the oxygen of the air displacing the sulphur from the sulphide as free sulphur, and with moisture converting the iron into hydrated oxide of iron. This reactivation can be carried on a number of times until the material when dry contains about 50% of free sulphur and even occasionally 60%, and over; it is then sold to manufacturers of sulphuric acid to be used in the sulphur kilns instead of pyrites (see SULPHURIC ACID).

Apart from the by-products coke, coke-breeze, tar and retort carbon, which are sold direct, gas companies are now in many cases preparing from their spent purifying material pure chemical products which are in great demand. The most important of these is sulphate of ammonia, which is used for agricultural purposes as a manure, and is obtained by passing ammonia into sulphuric acid and crystallizing out the ammonium sulphate produced. To do this, saturated ammoniacal liquor is decomposed by lime in the presence of steam, and the freed ammonia is passed into strong sulphuric acid, the saturated solution of ammonium sulphate being carefully crystallized. The market value of the salt varies, but an average figure is £12 per ton, whilst the average yield is about 24 lb of salt per ton of coal carbonized. In large works the sulphuric acid is usually manufactured on the spot from the spent oxide, so that the sulphuretted hydrogen, which in the gas is considered an undesirable impurity, plays a valuable part in the manufacture of an important by-product.

Cyanogen compounds are extracted either direct from the gas, from the spent oxide or from ammoniacal liquor, and some large gas works now produce sodium cyanide, this being one of the latest developments in the gas chemical industry.

The purified gas now passes to a gasholder (sometimes known as a gasometer), which may be either single lift, *i.e.* a simple bell inverted in a tank of water, or may be constructed on the telescopic principle, in which case much ground space is saved, as a holder of much greater capacity can be contained in the same-sized tank. The tank for the gasholder is usually made by

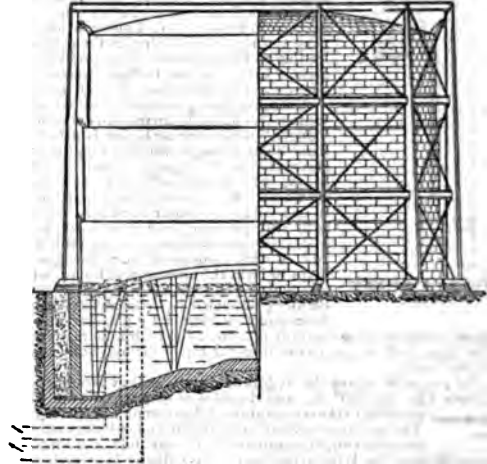

FIG. 10.—Gasholder.

excavating a circular reservoir somewhat larger in diameter than the proposed holder. A banking is allowed to remain in the centre, as shown in fig. 10, which is known as the "dumpling," this arrangement not only saving work and water, but acting as a support for the king post of a trussed holder when the holder is empty. The tank must be water-tight, and the precaution necessary to be taken in order to ensure this is dependent upon the nature of the soil; it is usual, however, for the tanks to be lined with concrete. Where the conditions of soil are very bad, steel tanks are built above ground, but the cost of these is much greater. The holder is made of sheet iron riveted together, the thickness depending upon the size of the holder. The telescopic form consists of two or more lifts which slide in one another, and may be described as a single lift holder encircled by other cylinders of slightly larger diameter, but of about the same length. Fig. 10 shows the general construction. Gas on entering at A causes the top lift to rise; the bottom of this lift being turned up all round to form a cup, whilst the top of the next lift is turned down to form a so-called grip, the two interlock (see fig. 11), forming what is known as the hydraulic cup. Under these conditions the cup will necessarily be filled with water, and a seal will be formed, preventing the escape of gas. A guide framing is built round the holder, and guide rollers are fixed at various intervals round the grips of each lift, whilst at the bottom of the cup guide rollers are also fixed (fig. 11). In the year 1892 the largest existing gasholder was built at the East Greenwich works of the South Metropolitan Gas Company; it has six lifts, its diameter is 293 ft., and when filled with gas stands 180 ft. high. The capacity for gas is 12 million cub. ft.

The governor consists usually of a bell floating in a cast iron tank partially filled with water, and is in fact a small gas-governor holder, from the centre of which is suspended a conical valve controlling the gas inlet and closing it as the bell fills. Any deviation in pressure will cause the floating bell to be lifted or lowered, and the size of the inlet will be decreased or increased, thus regulating the flow.

The fact that coal gas of an illuminating power of from 14 to 16 candles can be made from the ordinary gas coal at a fairly low rate, while every candle power added to the gas increases the cost in an enormous and rapidly growing ratio, has, from the earliest days of

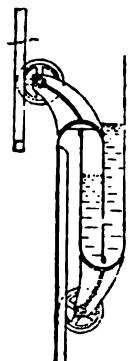

FIG. 11.—Cup and Grip.

(the gas industry, caused the attention of inventors to be turned to the enrichment of coal gas. Formerly cannel coal was used for producing a very rich gas which could be mixed with the ordinary gas, thereby enriching it, but as the supply became limited and the price prohibitive, other methods were from time to time advocated to replace its use in the enrichment of illuminating gas. These may be classified as follows:—

1. Enriching the gas by vapours and permanent gases obtained by decomposing the tar formed at the same time as the gas.
2. Mixing with the coal gas oil gas, obtained by decomposing crude oils by heat.
3. The carburetting of low-power gas by impregnating it with the vapours of volatile hydrocarbons.
4. Mixing the coal gas with water gas, which has been highly carburetted by passing it with the vapours of various hydrocarbons through superheaters in order to give permanency to the hydrocarbon gases.

Very many attempts have been made to utilize tar for the production and enrichment of gas, and to do this two methods may be adopted:—

- (a) Condensing the tar in the ordinary way, and afterwards using the whole or portions of it for cracking into a permanent gas.
- (b) Cracking the tar vapours before condensation by passing the gas and vapours through superheaters.

If the first method be adopted, the trouble which presents itself is that the tar contains a high percentage of pitch, which tends rapidly to choke and clog up all the pipes. A partly successful attempt to make use of certain portions of the liquid products of distillation of coal before condensation by the second method was the Dinsmore process, in which the coal gas and vapours which, if allowed to cool, would form tar, were made to pass through a heated chamber, and a certain proportion of otherwise condensable hydrocarbons was thus converted into permanent gases. Even with a poor class of coal it was claimed that 9800 cub. ft. of 20- to 21-candle gas could be made by this process, whereas by the ordinary process 9000 cub. ft. of 15-candle gas would have been produced. This process, although strongly advocated by the gas engineer who experimented with it, was never a commercial success. The final solution of the question of enrichment of gas by hydrocarbons derived from tar may be arrived at by a process which prevents the formation of part of the tar during the carbonization of the coal, or by the process devised by C. B. Tully and now in use at Truro, in which tar is injected into the incandescent fuel in a water-gas generator and enriches the water gas with methane and other hydrocarbons, the resulting pitch and carbon being filtered off by the column of coke through which the gas passes.

The earliest attempts at enrichment by oil gas consisted in spraying oil upon the red hot mass in the retort during carbonization; but experience soon showed that this was not an economical method of working, and that it was far better to decompose the liquid hydrocarbon in the presence of the diluents which are to mingle with it and act as its carrier, since, if this were done, a higher temperature could be employed and more of the heavier portions of the oil converted into gas, without at the same time breaking down the gaseous hydrocarbons too much.

In carburetting poor coal gas with hydrocarbons from mineral oil it must be borne in mind that, as coal is undergoing distillation, a rich gas is given off in the earlier stages, but towards the end of the operation the gas is very poor in illuminants, the methane disappearing with the other hydrocarbons, and the increase in hydrogen being very marked. Lewis T. Wright employed a coal requiring six hours for its distillation, and took samples of the gas at different periods of the time. On analysis these yielded the following results:—

Time after beginning Distillation.

	10 minutes.	1 hour 30 minutes.	3 hours 25 minutes.	5 hours 35 minutes.
Sulphuretted hydrogen	1.30	1.42	0.49	0.11
Carbon dioxide	2.21	2.09	1.49	1.50
Hydrogen	20.10	38.33	52.68	67.12
Carbon monoxide	6.19	5.66	6.21	6.12
Saturated hydrocarbons	57.38	44.03	33.54	22.58
Unsaturated "	10.62	5.98	3.04	1.79
Nitrogen	2.20	2.47	2.55	0.78

This may be regarded as a fair example of the changes which take place in the quality of the gas during the distillation of the coal. In carburetting such a gas by injecting mineral oil into the retort, many of the products of the decomposition of the oil being vapours, it would be wasteful to do so for the first two hours, as a rich gas is being given off which has not the power of carrying in suspension a much larger quantity of hydrocarbon vapours without being supersaturated with them. Consequently, to make it carry any further quantity in a condition not easily deposited, the oil would have to be completely decomposed into permanent gases, and the temperature necessary to do this would seriously affect the quality of the gas given off by the coal. When, however, the distillation

has gone on for three hours, the rich portions of coal have distilled off and the temperature of the retort has reached its highest point, and this is the best time to feed in the oil.

Undoubtedly the best process which has been proposed for the production of oil gas to be used in the enrichment of coal gas is the "Young" or "Peebles" process, which depends on the principle of washing the oil gas retorted at a moderate temperature by means of oil which is afterwards to undergo decomposition, because in this way it is freed from all condensable vapours, and only permanent gases are allowed to escape to the purifiers. In the course of this treatment considerable quantities of the ethylenes and other fixed gases are also absorbed, but no loss takes place, as these are again driven out by the heat in the subsequent retorting. The gas obtained by the Young process, when tested by itself in the burners most suited for its combustion, gives on the photometer an illuminating value averaging from 50 to 60 candle-power, but it is claimed, and quite correctly, that the enriching power of the gas is considerably greater. This is accounted for by the fact that it is impossible to construct a burner which will do justice to a gas of such illuminating power.

The fundamental objections to oil gas for the enrichment of coal gas are, first, that its manufacture is a slow process, requiring as much plant and space for retorting as coal gas; and, secondly, that although on a small scale it can be made to mix perfectly with coal gas and water gas, great difficulties are found in doing this on the large scale, because in spite of the fact that theoretically gases of such widely different specific gravities ought to form a perfect mixture by diffusion, layering of the gas is very apt to take place in the holder, and thus there is an increased liability to wide variations in the illuminating value of the gas sent out.

The wonderful carburetting power of benzol vapour is well known, a large proportion of the total illuminating power of coal gas being due to the presence of a minute trace of its vapour carried in suspension. For many years the price of benzol has been falling, owing to the large quantities produced in the coke ovens, and at its present price it is by far the cheapest enriching material that can be obtained. Hence at many gas-works where it is found necessary to do so it is used in various forms of carburettor, in which it is volatilized and its vapour used for enriching coal gas up to the requisite illuminating power.

One of the most generally adopted methods of enrichment now is by means of carburetted water gas mixed with poor coal gas. When steam acts upon carbon at a high temperature the resultant action may be looked upon as giving a mixture of equal volumes of hydrogen and carbon monoxide, both of which are inflammable but non-luminous gases. This water gas is then carburetted, i.e. rendered luminous by passing it through chambers in which oils are decomposed by heat, the mixture being made so as to give an illuminating value of 22 to 25 candles. This, mixed with the poor coal gas, brings up its illuminating value to the required limit. Coke or anthracite is heated to incandescence by an air blast in a generator lined with fire-brick, and the heated products of combustion as they leave the generator enter the superheater and are supplied with more air, which causes the combustion of carbon monoxide present in the producer gas and heats up the fire-brick baffles with which the superheater is filled. When the necessary temperature of the fuel and superheater has been reached, the air blast is cut off, and steam is blown through the generator, forming water gas, which meets the enriching oil at the top of the first superheater, called the carburettor, and carries the vapours with it through the main superheaters, where the fixing of the hydrocarbons takes place. The chief advantage of this apparatus is that a low temperature can be used for fixing owing to the enormous surface for superheating, and thus to a great extent the deposition of carbon is avoided. This form of apparatus has been very generally adopted in Great Britain as well as in America, and practically all carburetted water-gas plants are founded upon the same set of actions. Important factors in the use of carburetted water gas for enrichment are that it can be made with enormous rapidity and with a minimum of labour; and not only is the requisite increase in illuminating power secured, but the volume of the enriched gas is increased by the bulk of carburetted water gas added, which in ordinary English practice amounts to from 25 to

50%. The public at first strongly opposed its introduction on the ground of the poisonous properties of the carbon monoxide, which is present in it to the extent of about 28 to 30%. Still when this comes to be diluted with 60 to 75% of ordinary coal gas, containing as a rule only 4 to 6% of carbon monoxide, the percentage of poisonous monoxide in the mixture falls to below 16%, which experience has shown to be a fairly safe limit.

A rise in the price of oil suitable for carburetting has caused the gas industry to consider other methods by which the volume of gas obtainable from coal can be increased by admixture with blue or non-luminous water gas. In Germany, at several important gas-works, non-luminous water gas is passed into the foul main or through

Enrichment by volatile hydrocarbons.

Enrichment by carburetted water gas.

the retorts in the desired proportion, and the mixture of water gas and coal gas is then carburetted to the required extent by benzol vapour, a process which at the present price of oil and benzol is distinctly more economical than the use of carburetted water gas. In 1896 Karl Dellwik introduced a modification in the process of making water gas which entirely altered the whole aspect of the industry. In all the attempts to make water gas, up to that date, the incandescence of the fuel had been obtained by "blowing" so deep a bed of fuel that carbon monoxide and the residual nitrogen of the air formed the chief products, this mixture being known as "producer" gas. In the Dellwik process, however, the main point is the adjustment of the air supplied to the fuel in the generator in such a way that carbon dioxide is formed instead of carbon monoxide. Under these conditions producer gas ceases to exist as a by-product, and the gases of the blow consist merely of the incombustible products of complete combustion, carbon dioxide and nitrogen, the result being that more than three times the heat is developed for the combustion of the same amount of fuel, and nearly double the quantity of water gas can be made per pound of fuel than was before possible. The runs or times of steaming can also be continued for longer periods. The possibility of making from 60,000 to 70,000 cub. ft. of water gas per ton of coke used in the Dellwik generator as against 34,000 to 45,000 cub. ft. per ton made by previous processes reduces the price of water gas to about 3jd. per thousand, so that the economic value of using it in admixture with coal gas and then enriching the mixture by any cheap carburetted process is manifest. The universal adoption of the incandescent mantle for lighting purposes has made it evident that the illuminating value of the gas is a secondary consideration, and the whole tendency now is to do away with enrichment and produce a gas of low-candle power but good heating power at a cheap rate for fuel purposes and incandescent lighting. (See also LIGHTING: Gas.)

(V. B. L.)

2. *Gas for Fuel and Power.*—The first gas-producers, which were built by Faber du Faur at Wasseralängen in 1836 and by C. G. C. Bischof at Mägdesprung (both in Germany), consisted of simple perpendicular shafts of masonry contracted at the top and the bottom, with or without a grate for the coal. Such producers, frequently strengthened by a wrought iron casing, are even now used to a great extent. Sometimes the purpose of a gas-producer is attained in a very simple manner by lowering the grate of an ordinary fireplace so much that a layer of coal 4 or 5 ft. deep is maintained in the fire. The effect of this arrangement is that the great body of coal reaches a higher temperature than in an ordinary fireplace, and this, together with the reduction of the carbon dioxide formed immediately above the grate by the red-hot coal in the upper part of the furnace, leads to the formation of carbon monoxide which later on, on the spot where the greatest heat is required, is burned into dioxide by admitting fresh air, preferably pre-heated. This simple and inexpensive arrangement has the further advantage that the producer-gas is utilized immediately after its formation, without being allowed to cool down. But it is not very well adapted to large furnaces, and especially not to those cases where all the space round the furnace is required for manipulating heavy, white-hot masses of iron, or for similar purposes. In these cases the producers are arranged outside the iron-works, glass-works, &c., in an open yard where all the manipulations of feeding them with coal, of stoking, and of removing the ashes are performed without interfering with the work inside. But care must always be taken to place the producers at such a low level that the gas has an upward tendency, in order to facilitate its passage to the furnace where it is to be burned. This purpose can be further promoted by various means. The gas-producers constructed by Messrs Siemens Brothers, from 1856 onwards, were provided with a kind of brick chimney; on the top of this there was a horizontal iron tube, continued into an iron down-draught, and only from this the underground flues were started which sent the gas into the single furnaces. This arrangement, by which the gas was cooled down by the action of the air, acted as a gas-siphon for drawing the

gas out of the producer, but it has various drawbacks and has been abandoned in all modern constructions. Where the "natural draught" is not sufficient, it is aided either by blowing air under the grate or else by suction at the other end.

We shall now describe a few of the very large number of gas-

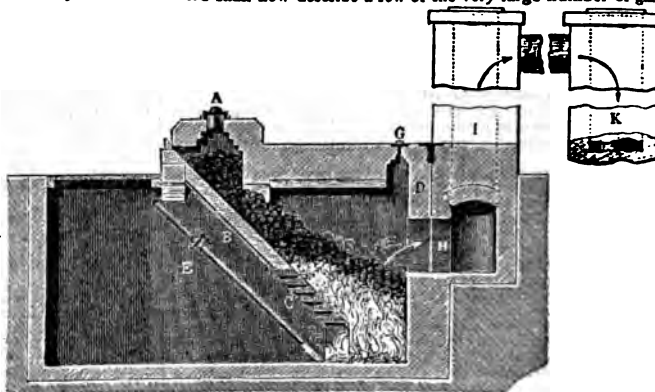

FIG. 12.—Siemens Producer (Sectional Elevation).

producers constructed, selecting some of the most widely applied in practice.

The Siemens Producer in its original shape, of which hundreds have been erected and many may still be still at work, is shown in fig. 12. A is the charging-hole; B, the inclined front wall, consisting of a cast iron plate with fire-brick lining; C, the equally inclined "step-grate"; D, a damper by which the producer may be isolated in case of repairs; E, a water-pipe, by which the cinders at the bottom may be quenched before taking away; the steam here formed rises into the producer where it forms some "semi-water gas" (see FUEL: Gaseous). Openings like that shown at G serve for introducing a poker in order to clean the brick-work from adhering slags.

H is the gas flue; I, the perpendicularly ascending shaft, 10 or 12 ft. high; J, the horizontal iron tube; K, the descending branch mentioned above, for producing a certain amount of suction by means of the gas-siphon thus formed. In the horizontal branch JJ much

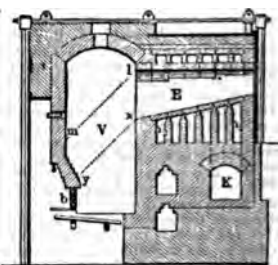
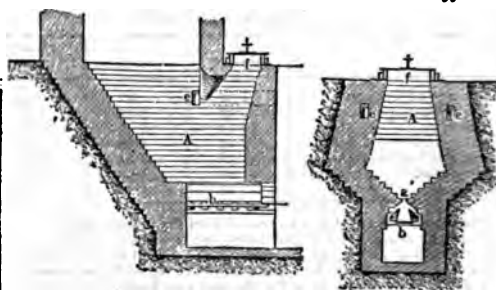

FIG. 13.—Lürmann's Producer.



Figs. 14 and 15.—Liegel's Producer.

of the tar and flue-dust is also condensed, which is of importance where bituminous coal is employed for firing.

¹ Figs. 12, 13, 14, 15, 16, 18, 19, 20, 21 of this article are from Lunge's *Coal-tar and Ammonia*, by permission of Friedr. Vieweg u. Sohn.

This as well as most other descriptions of gas-producers, is not adapted to being worked with such coal as softens in the heat and

where it is to be used. The retort E is charged with ordinary bituminous coal which is submitted to destructive distillation by the heat communicated through the flues $n_1 n_2$, and is thus converted into coke. The gases formed during this process pass into the upper portion of V and get mixed with the producer-gas formed in the lower portion. From time to time, as the level of the coke in V goes down, some of the freshly formed coke in E is

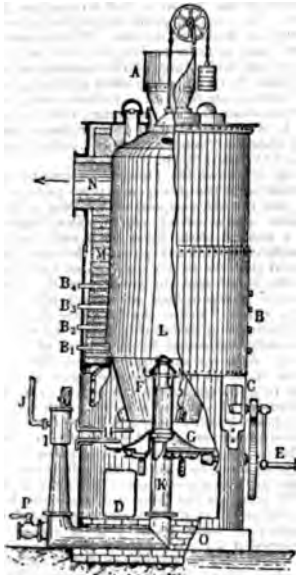

FIG. 16.—Taylor's Producer.

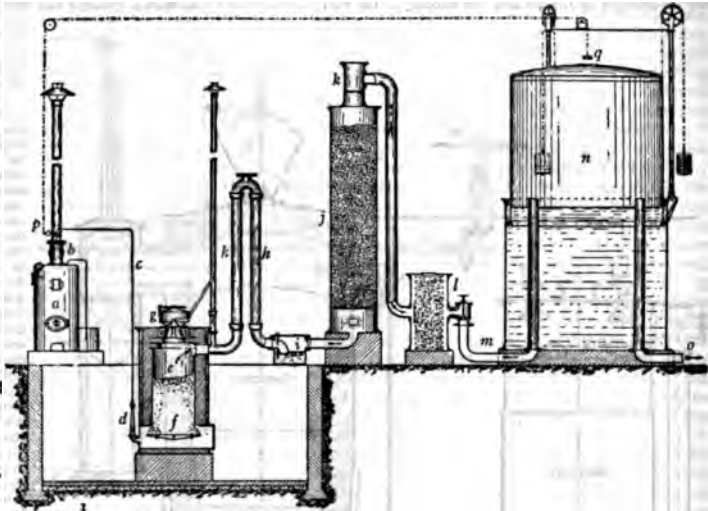

FIG. 17.—Dowson Gas Plant.

forms cakes, impenetrable to the air and impeding the regular sinking of the charge in the producer. The fuel employed should be non-bituminous coal anthracite or coke, or at least so much of these materials should be mixed with ordinary coal that no semi-solid cakes of the kind just described are formed. Where it is unavoidable to work with coal softening in the fire, Lürmann's producer may be employed, which is shown in fig 13. V shows a gas-producer of the ordinary kind, which during regular work is filled with the coke formed in the horizontal retort E. The door *b* serves for removing the slags and ashes from the bottom of V, as far as they do not fall through the grate. The hot producer-gas formed in V is passed round the retort E in the flues $n_1 n_2$, and ultimately goes away through K to the furnace

pushed into V, whereby the level of the coke in V should assume the shape shown by the dotted line *l...m*. If the level became

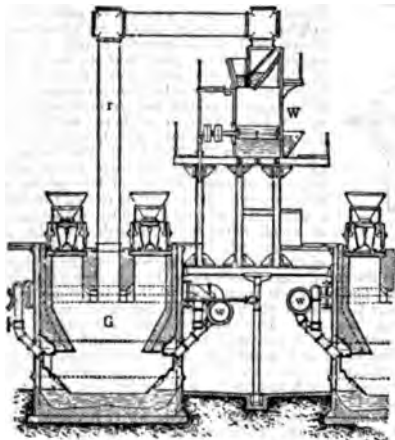

FIG. 18.—Mond Gas Plant.

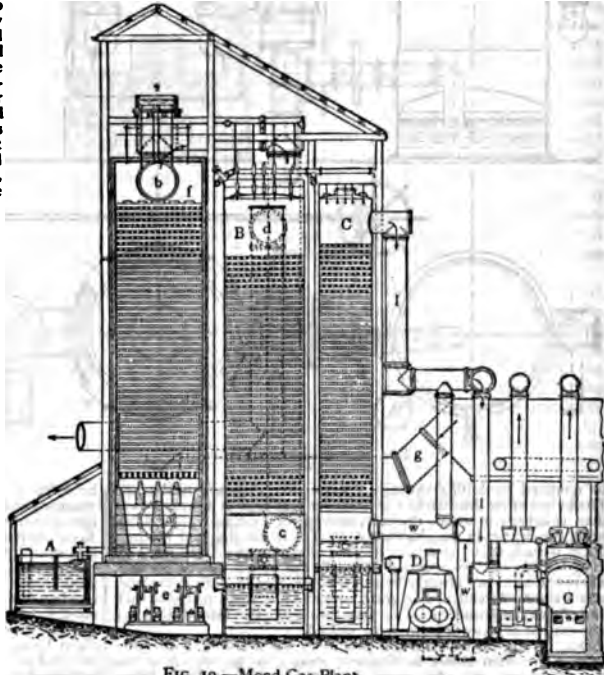

FIG. 19.—Mond Gas Plant.

too low, such as is shown by the dotted line $x \dots y$, the working of the producer would be wrong, as in this case the layer of coke at the front side would be too low, and carbon dioxide would be formed in lieu of monoxide.

Figs. 14 and 15 show Liegel's producer, the special object of which is to deal with any fuel (coal or coke) giving a tough, pasty slag on combustion. Such slags act very prejudicially by impeding the up-draught of the air and the sinking of the fuel; nor can they

holes B_1 to B_4 , passing through the brick lining M . F is the contracted part, leading to the closed ash-pit, accessible through the doors D . An injector I , worked by means of the steam-pipe J , forces air through K into F . The circular grate G can be turned round K by means of the crank E from the outside. This is done, without interfering with the blast, in order to keep the fuel at the proper level in L , according to the indications of the burning zone, as shown through the peep-holes B_1 to B_4 . The ashes collecting at the bottom are from time to time removed by J , is decomposed in the producer, we here obtain a "semi-water gas," with about 27% CO and 12% H_2 .

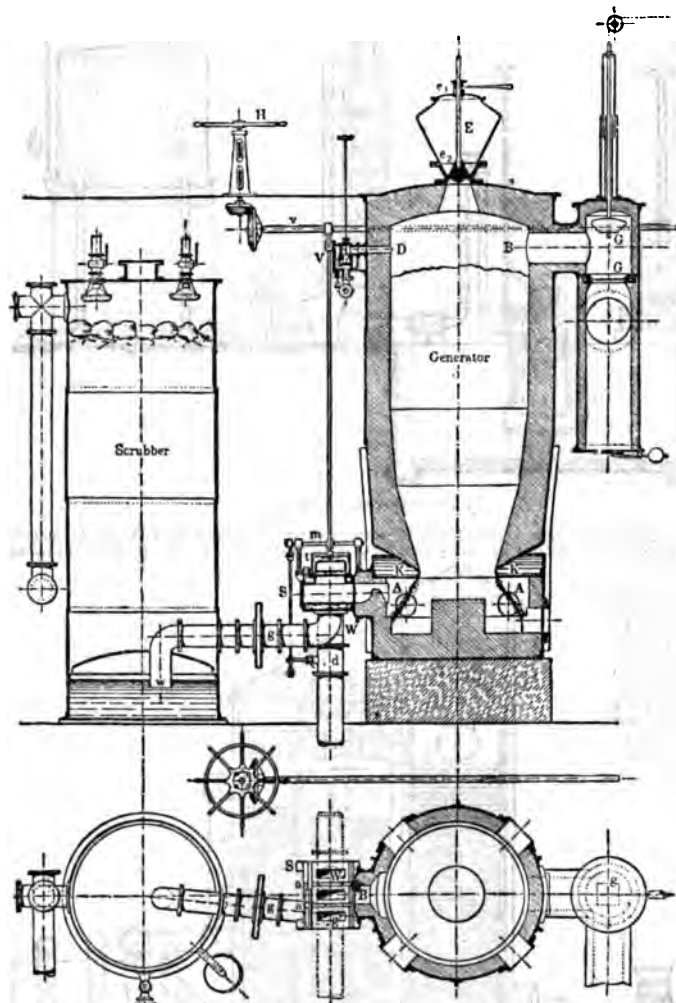

Fig. 20.—Blass' Gas Plant.

be removed by falling through a grate, like ordinary coal-ashes. To obviate these drawbacks the producer A is kept at a greater heat than is otherwise usual, the air required for feeding the producer being pre-heated in the channels e, e . The inside shape of the producer is such that the upper, less hot portion cannot get stopped, as it widens out towards the bottom; the lower, hotter portion, where the ashes are already fluxed, is contracted to a slit a , through which the air ascends. The grate b retains any small pieces of fuel, but allows the liquid cinder to pass through. The lateral flues c, c prevent the brickwork from being melted.

One of the best-known gas-producers for working with compressed air from below is Taylor's, shown in fig. 16. A is the feeding-hopper, on the same principle as is used in blast-furnaces. L is the producer-shaft, with an iron casing B and peep-

being $78^{\circ} C.$; at the top the gas passes away through d into the distributing main. The hot water from B , freed from tar, is pumped into a third tower C , through which cold air is forced by means of a Root's blower by the pipe w . This air, after being heated to $76^{\circ} C.$, and saturated with steam in the tower C , passes through l into the generator G . The water in C leaves this tower cold enough to be used in the scrubber B . Thus two-thirds of the steam originally employed in the generator is reintroduced into it, leaving only one-third to be supplied by the exhaust steam of the steam-engine. The gas-generators G have a rectangular section, 6×12 ft., several of them being erected in series. The introduction of the air and the removal of the ashes takes place at the narrower ends. The bottom is formed by a water-tank and the ashes are quenched here. The air enters just above the water-level, at a pressure of 4 in. The

Fig. 17 shows the Dowson gas-producer, together with the arrangements for purifying the gas for the purpose of working a gas engine. a is a vertical steam boiler, heated by a central shaft filled with coke, with superheating tubes b passing through the central shaft. c is the steam-pipe, carrying the dry steam into the air-injector d . This mixture of steam and air enters into the gas-producer e below the fire-grate f . g is the feeding-hopper for the anthracite which is usually employed in this kind of producer. h, h are cooling-pipes for the gas where most of the undecomposed steam (say 10% of the whole employed in d) is condensed. i is a hydraulic box with water seal; j , a coke-scrubber; k , a filter; l , a sand-scrubber; m , inlet of gas-holder; n , gas-holder; o , outlet of same; p , a valve with weighted lever to regulate the admission of steam to the gas-producer; q , the weight which actuates the lever automatically by the rise or fall of the bell of the gas-holder. In practical work about $\frac{3}{4}$ lb. of steam is decomposed for each pound of anthracite consumed, and no more than 5% of carbon dioxide is found in the resulting gas. The latter has an average calorific power of 1732 calories per cubic metre, or 161 B.T.U. per cubic foot, at 0° and 760 mm.

The Mond plant is shown in figs. 18 and 19. The gases produced in the generators G are passed through pipes r into washers W , in which water is kept in violent motion by means of paddle-wheels. The spray of water removes the dust and part of the tar and ammonia from the gases, much steam being produced at the same time. This water is withdrawn from time to time and worked for the ammonia it contains. The gases, escaping from W at a temperature of about $100^{\circ} C.$, and containing much steam, pass through g and a into a tower, fed with an acid-absorbing liquid, coming from the tank s , which is spread into many drops by the brick filling of the tower. This liquid is a strong solution of ammonium sulphate, containing about 2.5% free sulphuric acid which absorbs nearly all the ammonia from the gases, without dissolving much of the tarry substances. Most of the liquor arriving at the bottom, after mechanically separating the tar, is pumped back into s , but a portion is always withdrawn and worked for ammonium sulphate. When escaping from the acid tower, the gas contains about 0.013% NH_3 , and has a temperature of about $80^{\circ} C.$ and is saturated with aqueous vapour. It is passed through c into a second tower B , filled with blocks of wood, where it meets with a stream of comparatively cold water. At the bottom of this the water runs away, its temperature

Mond gas in the dry state contains 15% carbon dioxide, 10% monoxide, 23% hydrogen, 3% hydrocarbons, 49% nitrogen. The yield of ammonium sulphate is 75 lb from a ton of coal (slack with 11.5% ashes and 55% fixed carbon).

One of the best plants for the generation of water-gas is that constructed by E. Blass (fig. 20). Steam enters through the valve V at D into the generator, filled with coke, and passes away at the bottom through A. The pressure of the gas should not be such that it could get into the pipe conveying the air-blast, by which an explosive mixture would be formed. This is prevented by the water-cooled damper S, which always closes the air-blast when the gas-pipe is open and vice versa. Below the entry W of the air-blast there is a throttle valve d which is closed as soon as the damper S opens the gas canal; thus a second security against the production of a mixture of air and gas is afforded. The water-cooled ring channel K protects the bottom outlet of the generator and causes the cinders to solidify, so that they can be easily removed. But sometimes no such cooling is effected, in which case the cinders run away in the liquid form. Below K the fuel is lying in a conical heap, leaving the ring channel A free. During the period of hot-blowing (heating-up) S is turned so that the air-blast communicates with the generator; d and G are open; g (the damper connected with the scrubber) and V are closed. During the period of gas-making G and d are closed, S now closes the air-blast and connects the generator with the scrubber; V is opened, and the gas passes from the scrubber into the gas-holder, the inlet w being under a pressure of 4 in. All these various changes in the opening of the valves and dampers are automatically performed in the proper order by means of a hand-wheel H, the shaft m resting on the standards l and shaft v. This hand-wheel has merely to be turned one way for starting the hot-blowing, and the opposite way for gas-making, to open and shut all the connexions, without any mistake being possible on the part of the attendant. The feeding-hopper E is so arranged that, when the cone e₁ opens, e₁ is shut, and vice versa, thus no more gas can escape, on feeding fresh coke into the generator, than that which is contained in E. G is the pipe through which the blowing-up gas (Siemens gas) is carried away, either into the open air (where it is at once burned) or into a preheater for the blast, or into some place where it can be utilized as fuel. This gas, which is made for 10 or 11 minutes, contains from 23 to 32% carbon monoxide, 7 to 15% carbon dioxide, 2 to 3% hydrogen, a little methane, 64 to 66% nitrogen, and has a heating value of 950 calories per cub. metre. The water-gas itself is made for 7 minutes, and has an average composition of 3.3% carbon dioxide, 44% carbon monoxide, 0.4% methane, 48.6% hydrogen, 3.7% nitrogen, and a heating value of 2970 calories per cub. metre. 1 kilogram coke yields 1.13 cub. metre water-gas and 3.13 Siemens gas. 100 parts coke (of 7000 calories) furnish 42% of their heat value as water-gas and 42% as Siemens gas.

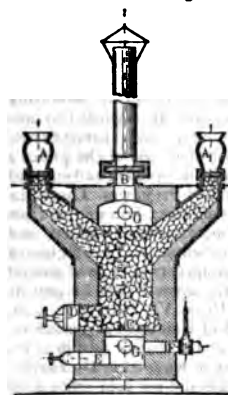

FIG. 21.—Dellwik-Fleischer Gas-producer.

Lastly we give a section of the Dellwik-Fleischer gas-producer (fig. 21). The feeding-hoppers A are alternately charged every half-hour, so that the layer of fuel in the generator always remains 4 ft. deep. B is the chimney-damper, C the grate, D the door for removing the slags, E the ash-door, F the inlet of the air-blast, G the upper, G₁ the lower outlet for the water-gas which is removed alternately at top and bottom by means of an outside valve, steam being always admitted at the opposite end. The blowing-up generally lasts 1½ minutes, the gas-making 8 or 10 minutes. The air-blast works under a pressure of 8 or 9 in. below the grate, or 4 to 4½ in. above the coke. The blowing-up gas contains 17 or 18% carbon dioxide and 1.5% oxygen, with mere traces of carbon monoxide. The water-gas shows 4 to 5% carbon dioxide, 40% carbon monoxide, 0.8% methane, 48 to 51% hydrogen, 4 or 5% nitrogen. About 2.5 cub. metres is obtained per kilogram of best coke.

See Mills and Rowan, *Fuel and its Application* (London, 1899); Samuel S. Wyer, *Producer-Gas and Gas-Products*, published by the *Engineering and Mining Journal* (New York); F. Fischer, *Chemische Technologie der Brennstoffe* (1897-1901); *Gasförmige Heizstoffe*, in Stohmann and Kerl's *Handbuch der technischen Chemie*, 4th edition, iii. 642 et seq. (G. L.)

GASCOIGNE, GEORGE (c. 1535-1577), English poet, eldest son of Sir John Gascoigne of Cardington, Bedfordshire, was born probably between 1530 and 1535. He was educated at Trinity College, Cambridge, and on leaving the university is supposed to

have joined the Middle Temple. He became a member of Gray's Inn in 1555. He has been identified without much show of evidence with a lawyer named Gastone who was in prison in 1548 under very discreditable circumstances. There is no doubt that his escapades were notorious, and that he was imprisoned for debt. George Whetstone says that Sir John Gascoigne disinherited his son on account of his follies, but by his own account he was obliged to sell his patrimony to pay the debts contracted at court. He was M.P. for Bedford in 1557-1558 and 1558-1559, but when he presented himself in 1572 for election at Midhurst he was refused on the charges of being "a defamed person and noted for manslaughter," "a common Rymer and a deviser of slaunderous Pasquelles," "a notorious ruffianne," an atheist and constantly in debt. His poems, with the exception of some commendatory verses, were not published before 1572; but they were probably circulated in MS. before that date. He tells us that his friends at Gray's Inn importuned him to write on Latin themes set by them, and there two of his plays were acted. He repaired his fortunes by marrying the wealthy widow of William Breton, thus becoming step-father to the poet, Nicholas Breton. In 1568 an inquiry into the disposition of William Breton's property with a view to the protection of the children's rights was instituted before the lord mayor, but the matter was probably settled in a friendly manner, for Gascoigne continued to hold the Walthamstow estate, which he had from his wife, until his death. He sailed as a soldier of fortune to the Low Countries in 1572, and was driven by stress of weather to Brill, which luckily for him had just fallen into the hands of the Dutch. He obtained a captain's commission, and took an active part in the campaigns of the next two years, during which he acquired a profound dislike of the Dutch, and a great admiration for William of Orange, who had personally intervened on his behalf in a quarrel with his colonel, and secured him against the suspicion caused by his clandestine visits to a lady at the Hague. Taken prisoner after the evacuation of Valkenburg by the English troops, he was sent to England in the autumn of 1574. He dedicated to Lord Grey of Wilton the story of his adventures, "The Fruits of Warres" (printed in the edition of 1575) and "Gascoigne's Voyage into Hollande." In 1575 he had a share in devising the masques, published in the next year as *The Princely Pleasures at the Courte at Kenelworth*, which celebrated the queen's visit to the Earl of Leicester. At Woodstock in 1575 he delivered a prose speech before Elizabeth, and presented her with the *Pleasant Tale of Hemeles the Heremite*¹ in four languages. Most of his works were actually published during the last years of his life, after his return from the wars. He died at Bernack, near Stamford, where he was the guest of George Whetstone, on the 7th of October 1577. George Whetstone wrote a long dull poem in honour of his friend, entitled "A Remembrance of the well-employed life and godly end of George Gaskoigne, Esquire."

His theory of metrical composition is explained in a short critical treatise, "Certeayne Notes of Instruction concerning the making of verse or ryme in English, written at the request of Master Edouardo Donati,"² prefixed to his *Poesies* (1575). He acknowledged Chaucer as his master, and differed from the earlier poets of the school of Surrey and Wyatt chiefly in the added smoothness and sweetness of his verse. His poems were published in 1572 during his absence in Holland, surreptitiously, according to his own account, but it seems probable that the "editor" who supplied the running comment was none other than Gascoigne himself. *A hundreth Sundrie Flowres bound up in one small Posie. Gathered partly (by translation) in the fyne oulandish Gardens of Euripides, Ovid, Petrarke, Ariosto and others; and partly by Invention out of our owne fruisfull Orchardes in Englande, Yelding Sundrie Savours of tragical, comical and moral discourse, bothe pleasaunt and profitable, to the well-smelling*

¹ Printed in 1579 in a pamphlet called *The Paradoxe*, the author of which, Abraham Fleming, does not mention Gascoigne's name.

² Reprinted in vol. ii. of J. Haslewood's *Ancient Critical Essays* (1811-1815), and in Gregory Smith's *Elizabethan Critical Essays* (1904).

noses of learned Readers, was followed in 1575 by an authorized edition, *The Posies of G. G. Esquire* . . . (not dated).

Gascoigne had an adventurous and original mind, and was a pioneer in more than one direction. In 1576 he published *The Steele Glas*, sometimes called the earliest regular English satire. Although this poem is Elizabethan in form and manner, it is written in the spirit of *Piers Plowman*. Gascoigne begins with a comparison between the sister arts of Satire and Poetry, and under a comparison between the old-fashioned "glas of trustie steele," and the new-fangled crystal mirrors which he takes as a symbol of the "Italianate" corruption of the time, he attacks the amusements of the governing classes, the evils of absentee landlordism, the corruption of the clergy, and pleads for the restoration of the feudal ideal.¹

His dramatic work belongs to the period of his residence at Gray's Inn, both *Jocasta* (of which Acts i. and iv. were contributed by Francis Kinwelmersh) and *Supposes* being played there in 1566. *Jocasta* was said by J. P. Collier (*Hist. of Dram. Paetry* iii. 8) to be the "first known attempt to introduce a Greek play upon the English stage," but it turns out that Gascoigne was only very indirectly acquainted with Euripides. His play is a literal version of Lodovico Dolce's *Jocasta*, which was derived probably from the *Phoenissae* in the Latin translation of R. Winter. *Supposes*,² a version of Ariosto's *I Suppositi*, is notable as an early and excellent adaptation of Italian comedy, and moreover, as "the earliest play in English prose acted in public or private." Udall's *Ralph Roister Doister* had been inspired directly by Latin comedy; *Gammer Gurton's Needle* was a purely native product; but *Supposes* is the first example of the acclimatization of the Italian models that were to exercise so prolonged an influence on the English stage. A third play of Gascoigne's, *The Glasse of Government* (published in 1575), is a school drama of the "Prodigal Son" type, familiar on the continent at the time, but rare in England. It is defined by Mr C. H. Herford as an attempt "to connect Terentian situation with a Christian moral in a picture of school life," and it may be assumed that Gascoigne was familiar with the didactic drama of university life in vogue on the continent. The scene is laid at Antwerp, and the two prodigals meet with retribution in Geneva and Heidelberg respectively.

The Spoyle of Antwerpe, written by an eyewitness of the sack of the city in 1576, has sometimes been attributed to Gascoigne, but although a George Gascoigne was employed in that year to carry letters for Walsingham, internal evidence is against Gascoigne's authorship. A curious editorial preface by Gascoigne to Sir Humphrey Gilbert's *Discourse of a Discoverie for a new Passage to Caloia* (1576) has led to the assertion that Gascoigne printed the tract against his author's wish, but it is likely that he was really serving Gilbert, who desired the publication, but dared not avow it. *The Wyll of the Devill* . . . (reprinted for private circulation by Dr F. J. Furnivall, 1871), an anti-popish tract, once attributed, on slender evidence, to Gascoigne, is almost certainly by another hand.

Gascoigne's works not already mentioned include: "G. G. in commendation of the noble Arte of Venerie," prefixed to *The Noble Art of Venerie or Hunting* (1575); *The Complaynte of Phylomene*, bound up with *The Steele Glas* (1576); *The Droomme of Doomes-day* (1576), a prose compilation from various authors, especially from the *De contemptu mundi sive de miseria humanae conditionis* of Pope Innocent III., printed with varying titles, earliest ed. (1470); *A Delicate Diet for delicate mouthed droombarde* . . . (1576), a free version of St Augustine's *De civitate*. *The Posies* (1572) included *Supposes*, *Jocasta*, *A Discourse of the Adventures of Master Flerdinando Jeronimi*, in imitation of an Italian novella, a partly auto-

¹ "Again I see, within my glasse of Steele
But foure estates, to serve each country soyle,
The King, the Knight, the Pesant, and the Priest.
The King should care for al the subjects still,
The Knight should fight, for to defend the same,
The Pesant, he shoulde labor for their ease,
And Priests shuld pray, for them and for themselves."—
(Arber's ed., p. 57.)

² The influence of this play on the Shakespearian *Taming of the Shrew* is dealt with by Prof. A. H. Tolman in *Shakespeare's Part in the Taming of the Shrew* (Pub. of the Mod. Lang. Assoc. vol. v. No. 4, pp. 215, 216, 1890).

biographical *Don Bartholomew of Bath*, and miscellaneous poems. Real personages, some of whom were well known at court, were supposed to be concealed under fictitious names in *The Adventures of Master F. J.*, and the poem caused considerable scandal, so that the names are disguised in the second edition. A more comprehensive collection, *The Whole Workes of G. G.* . . . appeared in 1587. In 1868-1870 *The Complete Poems of G. G.* . . . were edited for the Roxburghe Library by Mr W. C. Hazlitt. In his *English Reprints* Prof. E. Arber included *Certaine Notes of Instruction*, *The Steele Glas*, and the *Complaynt of Phylomene*. *The Steele Glas* was also edited for the *Library of English Literature*, by Henry Morley, vol. i. p. 184 (1889). A new edition, *The Works of George Gascoigne* (The Cambridge English Classics, 1907, &c.) is edited by Dr J. W. Cunliffe. See also *The Life and Writings of George Gascoigne*, by Prof. Felix E. Schelling (Publications of the Univ. of Pennsylvania series in Philology, vol. ii. No. 4 [1894]); C. H. Herford, *Studies in the Literary Relations of England and Germany in the Sixteenth Century*, pp. 149-164 (1886); C. H. Herford, "Gascoigne's Glasse of Government," in *Englische Studien*, vol. ix. (Halle, 1877, &c.).

GASCOIGNE, SIR WILLIAM (c. 1350-1410), chief justice of England in the reign of Henry IV. Both history and tradition testify to the fact that he was one of the great lawyers who in times of doubt and danger have asserted the principle that the head of the state is subject to law, and that the traditional practice of public officers, or the expressed voice of the nation in parliament, and not the will of the monarch or any part of the legislature, must guide the tribunals of the country. He was a descendant of an ancient Yorkshire family. The date of his birth is uncertain, but it appears from the year-books that he practised as an advocate in the reigns of Edward III. and Richard II. On the banishment of Henry of Lancaster Gascoigne was appointed one of his attorneys, and soon after Henry's accession to the throne was made chief justice of the court of king's bench. After the suppression of the rising in the north in 1405, Henry eagerly pressed the chief justice to pronounce sentence upon Scrope, the archbishop of York, and the earl marshal Thomas Mowbray, who had been implicated in the revolt. This he absolutely refused to do, asserting the right of the prisoners to be tried by their peers. Although both were afterwards executed, the chief justice had no part in the transaction. It has been very much doubted, however, whether Gascoigne could have displayed such independence of action without prompt punishment or removal from office following. The oft-told tale of his committing the prince of Wales to prison must also be regarded as unauthentic, though it is both picturesque and characteristic. The judge had directed the punishment of one of the prince's riotous companions, and the prince, who was present and enraged at the sentence, struck or grossly insulted the judge. Gascoigne immediately committed him to prison, using firm and forcible language, which brought him to a more reasonable mood, and secured his voluntary obedience to the sentence. The king is said to have approved of the act, but there appears to be good ground for the supposition that Gascoigne was removed from his post or resigned soon after the accession of Henry V. He died in 1410, and was buried in the parish church of Harewood in Yorkshire. Some biographies of the judge have stated that he died in 1412, but this is clearly disproved by Foss in his *Lives of the Judges*; and although it is clear that Gascoigne did not hold office long under Henry V., it is not absolutely impossible that the scene in the fifth act of the second part of Shakespeare's *Henry IV.* has some historical basis, and that the judge's resignation was voluntary.

GASCONY (*Wasconia*), an old province in the S.W. of France. It takes its name from the Vascones, a Spanish tribe which in 580 and 587 crossed the Pyrenees and invaded the district known to the Romans as Novempopulana or Aquitania tertia. Basque, the national language of the Vascones, took root only in a few of the high valleys of the Pyrenees, such as Soule and Labourd; in the plains Latin dialects prevailed, Gascon being a Romance language. In the 7th century the name of Vasconia was substituted for that of Novempopulana. The Vascones readily recognized the sovereignty of the Merovingian kings. In 602 they consented to be governed by a duke called Genialis, but in reality they remained independent. They even appointed national dukes, against whom Charlemagne had to fight at the beginning of his reign. Finally Duke Lupus II. made his

submission in 819, and the Carolingians were able to establish Frankish dukes in the country. Three of these are known: Séguin (Sighivinus), William (Guillaume), and Arnaud (Arnaldus). They were at the same time counts of Bordeaux, and succumbed to the Normans. After the death of Arnaud in 864 the history of Gascony falls into the profoundest obscurity. The lists of the 10th-century dukes prepared by ancient and modern historians can only be established by means of hypotheses based in many cases on spurious documents (e.g. the charter of Alaon), and little confidence can be placed in them. During this troubled period Gascony was from time to time attached to one or other of the other Vascon states which had been formed on the southern slope of the Pyrenees, but in the reign of Hugh Capet it was considered as forming part of France, from which it has never been separated. Disputed in the 11th century by the counts of Poitiers, who were also dukes of Aquitaine, and by the counts of Armagnac, the duchy finally passed to the house of Poitiers in 1073, when the title of duke of Gascony was merged in that of duke of Aquitaine and disappeared. In the feudal period Gascony comprised a great number of countships (including Armagnac, Bigorre, Fezensac, Gauré and Pardiac), viscountships (including Béarn, Lomagne, Dax, Juliac, Soule, Marsan, Tartas, Labourd and Maremne), and seigneuries (e.g. Albret, &c.). From the ecclesiastical point of view, it corresponded nearly to the archbishopric of Auch.

From about 1073 to 1137 Gascony was governed by the dukes of Aquitaine and counts of Poitiers, one of whom, William IX., gave the first charter of privileges to the town of Bayonne; but the duchy was weakened by the increasing independence of its great feudatories, especially the viscounts of Béarn and the counts of Armagnac. In 1137, the year of her father's death, Eleanor, the daughter and heiress of Duke William X., married the king of France, Louis VII., and with the rest of Aquitaine Gascony passed under his direct rule. In 1151, however, this marriage was annulled, and almost at once Eleanor married Henry of Anjou, who three years later became king of England as Henry II. Thus was the house of Plantagenet introduced into Gascony and a fresh bone of contention was thrown between the kings of England and of France. Having established himself in the duchy by force of arms, Henry handed it over to his son Richard, against whom many of the great Gascon lords revolted, and from Richard it passed to his brother John. The crusade against the Albigenses was carried into Gascony, and this warfare gave a new impetus to the process of disintegration which was already at work in the duchy. King John and his successor Henry III. were weak; the neighbouring counts of Toulouse were powerful and aggressive; and the house of Béarn was growing in strength. Gascony served Henry III. as headquarters during his two short and disastrous wars (1230 and 1242) with Louis IX., and in 1259 he did homage for it to this king; his son, Edward I., lost and then regained the duchy.

During the Hundred Years' War Gascony was obviously a battle-field for the forces of England and of France. The French seized the duchy, but, aided by the rivalry between the powerful houses of Foix and Armagnac, Edward III. was able to recover it, and by the treaty of Breigny in 1360 John II. recognized the absolute sovereignty of England therein. Handed over as a principality by Edward to his son, the Black Prince, it was used by its new ruler as a base during his expedition into Spain, in which he received substantial help from the Gascon nobles. The renewal of the war between England and France, which took place in 1369, was due in part to a dispute over the sovereignty of Gascony, and during its course the position of the English was seriously weakened, the whole of the duchy save a few towns and fortresses being lost; but the victories of Henry V. in northern France postponed for a time the total expulsion of the foreigner. This was reserved for the final stage of the war and was one result of the efforts of Joan of Arc, the year 1451 witnessing the capture of Bayonne and the final retreat of the English troops from the duchy. During this time the inhabitants of Gascony suffered severely from the ravages of both parties, and the nobles ruled or misruled without restraint.

The French kings, especially Louis XI., managed to restore the royal authority in the duchy, although this was not really accomplished until the close of the 15th century when the house of Armagnac was overthrown. It was by means of administrative measures that these kings attained their object. Gascony was governed on the same lines as other parts of France and from the time of Henry IV., who was prince of Béarn, and who united his hereditary lands with the crown, its history differs very slightly from that of the rest of the country. The Renaissance inspired the foundation of educational institutions and the Reformation was largely accepted in Béarn, but not in other parts of Gascony. The wars of religion swept over the land, which was the scene of some of the military exploits of Henry IV., and Louis XIV. made some slight changes in its government. As may be surmised the boundaries of Gascony varied from time to time, but just before the outbreak of the Revolution they were the Atlantic Ocean, Guienne, Languedoc and the Pyrenees, and from east to west the duchy at its greatest extent measured 170 m.

At the end of the *ancien régime* Gascony was united with Guienne to form a great military government. After the division of France into departments, Gascony, together with Béarn, French Navarre and the Basque country, formed the departments of Basses-Pyrénées, Landes, Hautes-Pyrénées and Gers. Parts of Gascony also now form arrondissements and cantons of the departments of Lot-et-Garonne, Haute-Garonne, Ariège and Tarn-et-Garonne.

See Arnaud Oihenart, *Notitia utriusque Vasconiae, tam Ibericae quam Aquitanicae* (1637); L'Abbé Monlezun, *Histoire de la Gascogne* (1846-1850), comprising a number of useful but uncritically edited documents; and Jean de Jaurgain, *La Vasconie, étude historique et critique sur les origines . . . du duché de Gascogne . . . et des grands fiefs du duché de Gascogne* (1898-1902), a learned and ingenious work, but characterized by unbridled genealogical fancy. This last work was rectified by Ferdinand Lot in his *Études sur le règne de Hugues Capet* (1903; see especially appendix x.). See also Barrau-Dihigo, "La Gascogne," a bibliography of manuscript sources and of printed works published in the *Revue de synthèse historique* (1903). (C. B.)

GAS ENGINE. A gas engine is a heat engine in which the working fluid is atmospheric air and the fuel an inflammable gas. It differs from a hot-air or a steam engine in that the heat is given to the working fluid by combustion within the motive power cylinder. In most gas engines—in fact, in all those at present on the market—the working fluid and the fuel that supplies it with heat are mixed with each other before the combustion of the fuel. The fuel—which in the steam and in most hot-air engines is burned in a separate furnace—is, in the gas engine, introduced directly to the motor cylinder and burned there; it is, indeed, part of the working fluid. A gas engine, therefore, is an internal combustion engine using gaseous fuel.

The commercial history of the gas engine dates from 1876, when Dr N. A. Otto patented the well-known engine now in extensive use, but long before that year inventors had been at work, attempting to utilize gas for producing motive power. The first proposal made in Great Britain is found in Street's Patent No. 1983 of 1794, where an explosion engine is suggested, the explosion to be caused by vaporizing spirits of turpentine on a heated metal surface, mixing the vapour with air in a cylinder, firing the mixture, and driving a piston by the explosion produced. Most of the early engines were suggested by the fact that a mixture of an inflammable gas and atmospheric air gives an explosion when ignited—that is, produces pressure which can be applied in a cylinder to propel a piston. Lebon, in France, proposed a gas engine in which the gas and air were raised to a pressure above that of the atmosphere before use in the cylinder, but he did not appear to be clear in his ideas.

Some interesting particulars of early experiments are given in a paper read at the Cambridge Philosophical Society in 1820 entitled, "On the Application of Hydrogen Gas to produce a Moving Power in Machinery, with a description of an Engine which is moved by the pressure of the Atmosphere upon a Vacuum caused by Explosions of Hydrogen Gas and Atmospheric Air." In that paper the Rev. W. Cecil describes an engine of his invention constructed to operate on the explosion vacuum method. This engine was stated to run with perfect regularity at 60 revolutions per minute, consuming 17.6 cub. ft. of hydrogen gas per hour. The hydrogen explosion, however, does not seem to have been noiseless, because Mr Cecil states that in building a larger engine ". . . to remedy the noise which is occasioned by the explosion, the lower end of the cylinder A, B, C, D may be buried in a well or it may be enclosed in a large air-tight vessel." Mr Cecil also mentions previous experiments to

Cambridge by Prof. Farish, who exhibited at his lectures on mechanics an engine actuated by the explosion of a mixture of gas and air within a cylinder, the explosion taking place from atmospheric pressure. Prof. Farish is also stated to have operated an engine by gunpowder. These engines of Farish and Cecil appear to be the very earliest in actual operation in the world.

Samuel Brown, in patents dated 1823 and 1826, proposed to fill a closed chamber with a gas flame, and so expel the air; then he condensed the flame by injecting water, and operated an-air engine by exhausting into the partial vacuum so obtained. The idea was evidently suggested by Watt's condensing steam engine, flame being employed instead of steam to obtain a vacuum. Brown's engine is said to have been actually employed to pump water, drive a boat on the Thames, and propel a road carriage. L. W. Wright in 1833 described an explosion engine working at atmospheric pressure and exploding on both sides of the piston. The cylinder is shown as water-jacketed. In William Barnett's engine of 1838 two great advances were made. The engine was so constructed that the mixture of gas and air was compressed to a considerable extent in the motor cylinder before ignition. The method of igniting the compressed charge was also effective. The problem of transferring a flame to the interior of a cylinder when the pressure is much in excess of that of the external air was solved by means of a hollow plug cock having a gas jet burning within the hollow. In one position the hollow was opened to the atmosphere, and a gas jet issuing within it was lit by an external flame, so that it burned within the hollow. The plug was then quickly rotated, so that it closed to the external air and opened to the engine cylinder; the flame continued to burn with the air contained in the cock, until the compressed inflammable mixture rushed into the space from the cylinder and ignited at the flame. This mode of ignition is in essentials the one adopted by Otto about thirty years later. To Barnett belongs the credit of being the first to realize clearly the great idea of compression before explosion in gas engines, and to show one way of carrying out the idea in practice. Barnett appears to have constructed an engine, but he attained no commercial success. Several attempts to produce gas engines were made between 1838 and 1860, but they were all failures. Several valuable ideas were published in 1855. Drake, an American, described a mode of igniting a combustible gaseous mixture by raising a thimble-shaped piece of metal to incandescence. In 1857 Barsanti and Matteucci proposed a free-piston engine, in which the explosion propelled a free piston against the atmosphere, and the work was done on the return stroke by the atmospheric pressure, a partial vacuum being produced under the piston. The engine never came into commercial use, although the fundamental idea was good.

Previous to 1860 the gas engine was entirely in the experimental stage, and in spite of many attempts no practical success was attained. E. Lenoir, whose patent is dated 1860, was the inventor of the first gas engine that was brought into general use. The piston, moving forward for a portion of its stroke by the energy stored in the fly-wheel, drew into the cylinder a charge of gas and air at the ordinary atmospheric pressure. At about half stroke the valves closed, and an explosion, caused by an electric spark, propelled the piston to the end of its stroke. On the return stroke the burnt gases were discharged, just as a steam engine exhausts. These operations were repeated on both sides of the piston, and the engine was thus double-acting. Four hundred of these engines were said to be at work in Paris in 1865, and the Reading Iron Works Company Limited built and sold one hundred of them in Great Britain. They were quiet, and smooth in running; the gas consumption, however, was excessive, amounting to about 100 cub. ft. per indicated horse-power per hour. The electrical ignition also gave trouble. Hugon improved on the engine in 1865 by the introduction of a flame ignition, but no real commercial success was attained till 1867, when Otto and Langen exhibited their free-piston engine in the Paris Exhibition of that year. This engine was identical in principle with the Barsanti and Matteucci, but Otto succeeded where those inventors failed. He worked out the engine in a very perfect manner, used flame ignition, and designed a practical clutch, which allowed the piston free movement in one direction but engaged with the fly-wheel shaft when moved in the other; it consisted of rollers and wedge-shaped pockets—the same clutch, in fact, as has since been so much used in free-wheel bicycles. This engine consumed about 40 cub. ft. of gas per brake horse-power per hour—less than half as much as the Lenoir. Several thousands were made and sold, but its strange appearance and unmechanical operation raised many objections. Several inventors meanwhile again advocated compression of the gaseous mixture before ignition, among them being Schmidt, a German, and Million, a Frenchman, both in 1861.

To a Frenchman, Alph. Beau de Rochas, belongs the credit of proposing, with perfect clearness, the cycle of operations now widely used in compression gas engines. In a pamphlet published in Paris in 1862, he stated that to obtain economy with an explosion engine four conditions are requisite: (1) The greatest possible cylinder volume with the least possible cooling surface; (2) the greatest possible rapidity of explosion; (3) the greatest possible expansion; and (4) the greatest possible pressure at the beginning of the expansion. The sole arrangement capable of satisfying

these conditions he stated would be found in an engine operating as follows: (1) Suction during an entire outstroke of the piston; (2) compression during the following instroke; (3) ignition at the dead point, and expansion during the third stroke; (4) forcing out of the burnt gases from the cylinder on the fourth and last return stroke. Beau de Rochas thus exactly contemplated, in theory at least, the engine produced by Dr Otto fourteen years later. He did not, however, put his engine into practice, and probably had no idea of the practical difficulties to be overcome before realizing his conception in iron and steel. To Dr Otto belongs the honour of independently inventing the same cycle, now correctly known as the Otto cycle, and at the same time overcoming all practical difficulties and making the gas engine of world-wide application. This he did in 1876, and his type of engine very rapidly surpassed all others, so that now the Otto-cycle engine is manufactured over the whole world by hundreds of makers. In 1876 Dr Otto used low compression, only about 30 lb per sq. in. above atmosphere. Year by year compression was increased and greater power and economy were obtained, and at present compressions of more than 100 lb per sq. in. are commonly used with most satisfactory results.

The history of the subject since 1876 is one of gradual improvement in detail of construction, enabling higher compressions to be used with safety, and of gradual but accelerating increase in dimensions and power. In the same period light and heavy oil engines have been developed, mostly using the Otto cycle (see OIL ENGINE).

Gas engines may be divided, so far as concerns their working process, into three well-defined types:—

- (1) Engines igniting at constant volume, but without previous compression.
- (2) Engines igniting at constant pressure, with previous compression.
- (3) Engines igniting at constant volume, with previous compression.

For practical purposes engines of the first type may be disregarded. Gas engines without compression are now considered to be much too wasteful of gas to be of commercial importance. Those of the second type have never reached the stage of extended commercial application; they are scientifically interesting, however, and may take an important place in the future development of the gas engine. The expectations of Sir William Siemens with regard to them have not been realized, although he spent many years in experiments. Of other engineers who also devoted much thought and work to this second type may be mentioned Brayton (1872); Foulis (1878); Crowe (1883); Hargreaves (1888); Clerk (1889); and Diesel (1892). Diesel's engines are proving successful as oil engines but have not been introduced as gas engines.

The working cycles of the three types are as follows:—

First Type.—Four operations.

- (a) Charging the cylinder with explosive mixture at atmospheric pressure.
- (b) Exploding the charge.
- (c) Expanding after explosion.
- (d) Expelling the burnt gases.

Second Type.—Five operations.

- (a) Charging the pump cylinder with gas and air mixture at atmospheric pressure.
- (b) Compressing the charge into an intermediate receiver.
- (c) Admitting the charge to the motor cylinder, in a state of flame, at the pressure of compression.
- (d) Expanding after admission.
- (e) Expelling the burnt gases.

Third Type.—Five operations.

- (a) Charging the cylinder with gas and air mixture at atmospheric pressure.
- (b) Compressing the charge into a combustion space.
- (c) Exploding the charge.
- (d) Expanding after explosion.
- (e) Expelling the burnt gases.

In all these types the heating of the working fluid is accomplished by the rapid method of combustion within the cylinder, and for the cooling necessary in all heat engines is substituted the complete rejection of the working fluid with the heat it contains, and its replacement by a fresh portion taken from the atmosphere at atmospheric temperature. This is the reason why those cycles can be repeated with almost indefinite rapidity, while the old hot-air engines had to run slowly in order to give time for the working fluid to heat or cool through metal surfaces.

Four-cycle Engines.—Otto-cycle engines belong to the third type, being explosion engines in which the combustible mixture

is compressed previous to explosion. Fig. 1 is a side elevation, fig. 2 is a sectional plan, and fig. 3 is an end elevation of an engine built about 1892 by Messrs Crossley of Manchester, who were the original makers of Otto engines in Great Britain. In external appearance it somewhat resembles a modern high-pressure

F the exhaust valve, G the exhaust valve lever, H the exhaust valve cam, I the charge inlet valve, J the charge inlet valve lever, K the charging valve cam, L the gas inlet valve, M the gas valve cam, N lever and link operating gas valve, O igniting or timing valve, P timing valve cam, Q timing valve lever or tumbler, R igniting tube, S governor, T water jacket and cylinder, U Bunsen burner for heating igniting tube. On the first forward or charging stroke the charge of gas and air is admitted by the inlet valve I, which is operated by the lever J from the cam K, on the valve shaft D. The gas supply is admitted to the inlet valve I by the lift valve L, which is also operated by the lever and link N from the cam M, controlled, however, by the centrifugal governor S. The governor operates either to admit gas wholly, or to cut it off completely, so that the variation in power is obtained by varying the number of the explosions.

Since the engine shown in figs. 1 to 3 was built further modifications have been made, principally in the direction of dispensing with or diminishing port space, that is, so arranging the ports that the compression space is not broken up into several separate chambers. In this way the cooling surface in contact with the intensely hot gases is reduced to a minimum. This is especially important when high compressions are used, as then the compression space being small, the port spaces form a large proportion of the total space. For maximum economy it is necessary to get rid of port space altogether; this is done by making the lift valves open directly into the compression space. This arrangement can be readily made

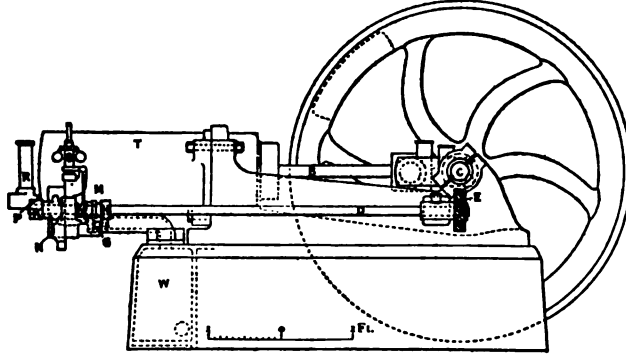

FIG. 1.—Side Elevation of Otto Cycle Engine.

steam engine, of which the working parts are exceedingly strong. In its motor and only cylinder, which is horizontal and opened, works a long trunk piston, the front end of which carries the crosshead pin. The crank shaft is heavy, and the fly-wheel large, considerable stored energy being required to carry the piston through the negative part of the cycle. The cylinder is considerably longer than the stroke, so that the piston when full in leaves a space into which it does not enter. This is the combustion space, in which the charge is first compressed and then burned. On the forward stroke, the piston A (fig. 2) takes into the cylinder a charge of mixed gas and air at atmospheric pressure, which is compressed by a backward stroke into the space Z at the end of the cylinder. The compressed charge is then ignited, and so the charge is exploded with the production of a high pressure. The piston now makes a forward stroke under the pressure of the explosion, and on its return, after the exhaust valve is opened, discharges the products of combustion. The engine is then ready to go through the same cycle of operations. It thus takes four strokes or two revolutions of the shaft to complete the Otto cycle, the cylinder being used alternately as a pump and a motor, and the engine, when working at full load, thus gives one impulse for every two revolutions. The valves, which are all of the conical-seated lift type, are four in number—charge inlet valve, gas inlet valve, igniting valve, and exhaust valve. The igniting valve is usually termed the timing valve, because it determines the time of the explosion. Since the valves have each to act once in every two revolutions, they cannot be operated by cams or eccentrics placed directly on the crank shaft. The valve shaft D is driven at half the rate of revolution of the crank shaft C by means of the skew or worm gear E, one wheel of which is mounted on the crank shaft and the other on the valve shaft. Ignition is accomplished by means of a metal tube heated to incandescence by a Bunsen burner. At the proper moment the ignition or timing valve is opened, and the mixed gas and air under pressure being admitted to the interior of the tube, the inflammable gases come into contact with the incandescent metal surface and ignite; the flame at once spreads back to the cylinder and fires its contents, thus producing the motive explosion.

The working parts are as follows:—A the piston, B the connecting rod, C the crank shaft, D the side or valve shaft, E the skew gearing,

in small and medium-sized engines, but in the larger engines it becomes necessary to provide ports, so as to allow the valves to be more easily removed for cleaning.

The construction of pressure gas plant in 1878 by J. E. Dowson for the production of inflammable gas from anthracite and coke by the action of air mixed with steam, soon led to the development of larger and larger Otto cycle engines. The gas obtained consisted of a mixture of carbon monoxide, hydrogen, nitrogen and some carbon dioxide and oxygen, having a lower heating value of about 150 British thermal units per cubic foot. With this gas these engines used about 1 lb of anthracite per b.h.p. per hour.

From the pressure producer sprang the suction producer first placed on the market in practical form by M. Benier of Paris in 1894, but then presenting many difficulties which were not removed till about nine years later when Dowson and others placed effective suction plants in use in considerable numbers. Such suction plants are now built by all the leading gas engine constructors for powers varying from 10 to 500 i.h.p.

Dr Ludwig Mond and Crossley Bros. also attacked the problem of the bituminous fuel producer, of which many examples are now at work for powers as large as 2000 i.h.p. In 1895 B. H.

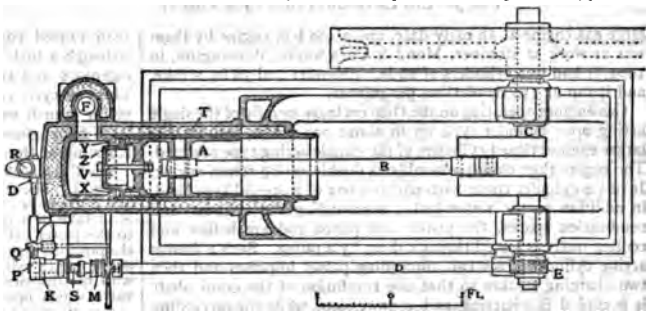

FIG. 2.—Plan of Otto Cycle Engine.

Thwaite demonstrated that the so-called waste gas from blast furnaces could be used in gas engines, and this undoubtedly led to the design and construction of the very large gas engines now becoming common both in Europe and in America. It appears from Thwaite's experiments that the surplus gas from the blast furnaces of Great Britain is capable of supplying at least three-quarters of a million horse-power continuously day

and night, and it is calculated that in America nearly three million horse-power is available from this source. Thwait's system was put into operation in 1805 at the Glasgow Iron Works, and it was also successfully applied near Barrow-in-Furness. For many reasons the system did not take immediate root in England, but in 1898 the Société Cockerill of Seraing near Liège applied an engine designed by Delamere-Deboutteville to utilize blast furnace gas. This engine indicated 213 h.p. running at 105 revolutions per minute. This was followed in 1899 by an engine giving 600 b.h.p. at 90 revolutions per minute used for driving a blowing cylinder for a blast furnace. It had a single cylinder of 51.2 in. diameter and a piston stroke of 55.1 in. About 1900 the Gasmotoren Fabrik Deutz built an Otto cycle engine of 1000 b.h.p. having four cylinders each 33 in. diameter and 39.3 in. stroke, speed 135 revolutions per minute. It was coupled direct to a dynamo. Crossley Bros. Ltd. took up the

Two-Cycle Engine.—While the Otto or four-cycle engine was developing as above described, inventors were hard at work on the two-cycle engine. In Britain this work fell mostly upon Clerk, Robson and Atkinson, while on the continent of Europe the most persevering and determined worker was Koerting.

Dugald Clerk began work on the gas engine at the end of 1876. His first patent was dated 1877 and dealt with an engine of the air pressure vacuum type. His next patent was No. 3045 of 1878, and the engine there described was exhibited at the Royal Agricultural Show at Kilburn, London, 1879. In it a pump compressed a mixture of air and gas into a reservoir, from which it entered the motor cylinder during the first part of its stroke. After cut-off ignition was caused by a platinum igniter, the piston was driven forward, and exhausting was performed on the return stroke. This engine gave three b.h.p., and it was the first compression explosion engine ever run giving one impulse for each revolution of the crank shaft. It had difficulties, however, which prevented it from reaching the market.

The particular type of engine now widely known as operating on the Clerk cycle was patented in 1881 (Brit. Pat. No. 1030). One of the earliest of these engines was set up at Lord Kelvin's laboratory at the Glasgow university and used for the purpose of driving a Siemens dynamo and supplying his house with electric light. The engine was first exhibited in the Paris Electrical Exhibition of 1881 and the London Smoke Abatement Exhibition of the same year. In this engine the charge was not compressed by a separate pump. A pumping cylinder, it is true, was used, but its function was to act merely as a displacer to take in a mixture of gas and air and transfer it to the motor cylinder at as low a pressure as possible, in such a way that the entering charge displaced the exhaust gases through ports which were opened by the overrunning of the piston. The motor piston thus timed and controlled the exhaust discharge, and gave a power impulse for every revolution of the crank. Engines of the Clerk type were built largely by Messrs Sterne & Co. of Glasgow, the Clerk Gas Engine Co. of Philadelphia, U.S.A., the Campbell Gas Engine Co., and a modification was made and sold in considerable numbers by the Stockport Company.

The lapsing of the Otto patent, however, in 1876 caused engineers to neglect the two cycle for a time, although a little later it was introduced for small engines in an ingenious and simple modification known as the Day engine. This two-cycle engine later became very popular, especially for motor launch work. The Clerk cycle is now much in use for large gas engines up to about 2000 horse as modified by Messrs Koerting of Hanover.

The Clerk cycle engine, as built in 1881, is shown in sectional plan at fig. 4. The engine contains two cylinders—a power cylinder A and a displacer cylinder B. The function of the displacer cylinder is to take in a combustible charge of gas and air and transfer it to the power cylinder, displacing as it enters the exhaust gases of the previous explosion. A compression space G is formed at the end of the motor cylinder A. It is of conical shape and communicates with the displacer cylinder B by means of a large automatic lift valve which opens into the compression space from a chamber communicating by a pipe with the displacer cylinder. At the out-end of the motor cylinder are placed V-shaped ports E which open to the atmosphere by an exhaust pipe. The outward travel of the motor piston C causes it to overrun these ports, as seen in fig. 4, and allows the pressure in the cylinder to fall to atmosphere. The action of the engine is as follows:—The displacer piston D on its forward movement draws in its charge of gas and air, and it is so timed with reference to the motor piston C that it has returned a small portion of its stroke just when the motor piston overruns the exhaust ports. The overrunning of the exhaust ports at once causes the pressure in the cylinder to fall to atmosphere, and then the pressure in the displacer overcomes the pressure in the motor cylinder and opens

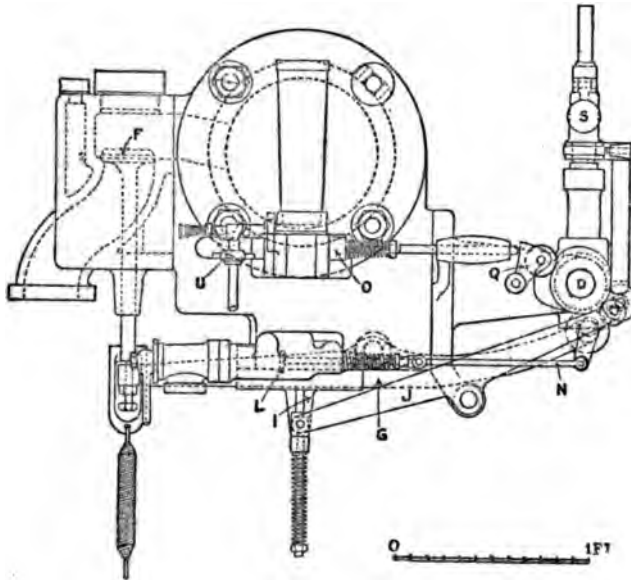

Fig. 3.—End Elevation of Otto Cycle Engine.

large gas engine at an early date, and a 400 h.p. engine by them was at work at Brunner, Mond & Co.'s works, Winnington, in 1900; it had two cylinders of 26 in. diameter and 36 in. stroke, and it ran at 150 revolutions per minute.

Gas engines operating on the Otto cycle are usually of the single acting open cylinder type up to about 200 b.h.p., but for the larger engines closed cylinders of the double acting type are used. The engine then closely resembles a double acting steam engine. It has a cylinder cover with packing box of a special type, and, in addition to the water jacket surrounding the cylinder and combustion spaces, the piston and piston rod are hollow and cooling water is forced through them by a pump. Such a double acting cylinder gives two succeeding power impulses and then two charging strokes so that one revolution of the crank shaft is occupied in charging and compression, while the succeeding revolution gets two power impulses. For still larger engines two such double acting cylinders are arranged in tandem, so that one piston rod runs through two pistons and connects to a slide in front and to one crank pin by a connecting rod. Such an engine gives two power impulses for every revolution of the crank shaft. The greatest power developed in one double acting cylinder is claimed by Ehrhardt and Sehmer for a cylinder of 45½ in. diameter by 51½ in. stroke, which at 94 revolutions per minute gives 1100 i.h.p.

the lift valve, when the charge flows in to the motor cylinder through the conical compression space and displaces the exhaust gases through the ports E, while it fills up the cylinder A with the inflammable charge. The exhaust gases are sufficiently displaced and the fresh charge introduced into the cylinder by the time the motor piston has opened the exhaust ports E on the out-stroke and closed them on the return stroke. The two cylinders are so propor-

two impulses per revolution. Messrs Mather & Platt build a Koerting engine of a modified type in England; an engine of their construction with a power cylinder of about 29 in. and 40½ in. stroke gives 700 h.p.

Fig. 5 shows in longitudinal section the power and pump cylinders of a Mather & Platt Koerting engine on the Clerk cycle; the power cylinder section is shown above that of the pump cylinders, but it is to be understood that both cylinders are in the same horizontal plane as in the Clerk engine shown at fig. 4. The Koerting engine, however, is double acting, whereas the Clerk engine was single acting. The power cylinder A has a power piston A¹ and compression spaces A²A³. At the centre of the cylinders are exhaust ports E which open to the atmosphere and are overrun by the piston A¹ at both ends of the stroke. A¹ and A² are inlet valves for gas and air. The single acting pump cylinders BB¹ supply the air required for the charge, and the double acting gas cylinder CC¹ supplies the gas. Both gas and air are led from these cylinders by separate passages to the inlet valves A¹A². The air pump pistons are lettered BB¹ and the gas pump piston C. The main crank D connects as usual to the piston rod of the power piston A¹, and the pump crank F to the trunk air pump piston B¹ which drives the other air pump piston B² and the gas pump piston C² by a piston rod passing through all three. The gas mixture is not made until the inlet valves A¹A² are reached, so that no explosive mixture exists until it is formed within the cylinder A. The air is first introduced into the power cylinder to discharge some of the hot gases, and when the gas is also admitted the contents of the cylinder are cooled to some extent. The action of the engine is exactly as described with regard to the Clerk cycle, and the arrangement of the two cranks at about right angles to each other is also similar. The exhaust is discharged through the ports E, and the incoming charge fills the cylinder in the same way as in the Clerk engine.

Another large continental gas engine, known as the Oechelhäuser, operates on a modified Clerk cycle and is shown in sectional plan at fig. 6. The motor cylinder A has two pistons A¹A², A¹ being operated by a centre and A² by two outside cranks, side rods, and cross head; the pistons A¹A² thus move in opposite directions and give an effective stroke of double that due to one crank. B is the air and gas pump dealing with air on one side of its piston and gas on the other. A chamber C opens to an air reservoir supplied from the pump and to the power cylinder by ports C¹; a similar chamber D opens to a gas reservoir supplied from the pump and to the power cylinder by ports D¹. The exhaust ports E are provided at the other end of the cylinder. When the front piston overruns the exhaust ports E the pressure within the power cylinder falls to atmosphere; the back piston then opens the air ports C¹ and air under slight pressure flows in, to be followed a little later by gas under slight pressure from the gas ports D¹. In this way the power cylinder A is charged with gas and air mixture at each stroke, and when the pistons A¹A² approach each other the charge is compressed into the space between and then ignited by the electric spark. The pistons are then forced apart and perform their power stroke. The Oechelhäuser engine, which is built in Great Britain by Messrs Beardmore

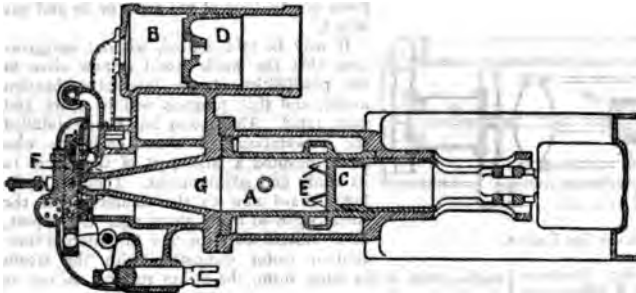

FIG. 4.—Sectional Plan of Clerk Cycle Engine, 1881.

tioned that the exhaust gases are expelled as completely as possible and replaced by fresh explosive mixture without any material part of this mixture escaping with the exhaust. Unless the proportions are carefully made such an escape is possible. The relative operations of the motor piston C and the displacer piston D are secured by advancing the crank of the displacer about a right angle compared to the motor crank. The motor piston on its in-stroke compresses the mixed charge into the conical space G; and, when compression is complete, the mixture is ignited by the slide valve F. This produces the power explosion which forces the piston forward until the exhaust ports are opened again. By this cycle of operations one power impulse is given for every revolution of the crank. The motor cylinder is surrounded by a water jacket in the usual manner, but it is unnecessary to water-jacket the displacer, as the gases are never hot.

Robson also invented two-cycle engines. His first patent was taken out in 1877 (No. 2334). The engines described in his patents of 1879-1880 were of the two-cycle type, and in them no second cylinder was used. The front end of the motor cylinder was enclosed by a cover and packing box, and was used as a pump to force gas and air into a reservoir at a few ft above atmosphere. The motor piston was arranged to overrun ports in the side of the cylinder, but the exhaust discharge was not timed in that way. A separate lift valve controlled the overrun ports and determined when the exhaust should be discharged. When the exhaust was discharged at the end of the stroke the pressure from the gas and air reservoir was admitted by a lift valve to the cylinder to displace the remaining exhaust gases and fill the cylinder with charge. This mixture was compressed into a space at the end of the cylinder and ignited by means of a flame ignition device. Robson's engine was built in considerable numbers by Messrs Tangye of Birmingham, the first exhibited by them at Bingley Hall at the end of 1880. The modern Day engine closely resembles the Robson engine so far as its broad operations are concerned.

Atkinson's work on the gas engine was begun in 1878, his first patent being No. 3212 of 1879. The engine described in that patent somewhat resembled the 1878 engine of Clerk as exhibited at Kilburn. Atkinson was ingenious and persevering in the invention of two-cycle engines. Two of his engines were made in considerable numbers. The first was known as the "Differential" engine, exhibited at the Inventions Exhibition, London, in 1885. A later engine produced by him was called the "Cycle" engine, and it proved to be the most economical of all the motors tested at the Society of Arts trials of motors for electric lighting in 1888-1889. Atkinson joined Crossley Bros., and many of his ingenious contrivances are now at work on the well-known engines of that firm.

Four-cycle engines now practically monopolize the field of the smaller internal combustion engines, and very large engines are also constructed on this plan. The two-cycle, or Clerk cycle engines, however, compete strongly with the four-cycle for large gas engines using blast furnace gas. Koerting engines on the Clerk cycle are now built giving 1000 i.h.p. per double acting motor cylinder, and one power cylinder on this method gives

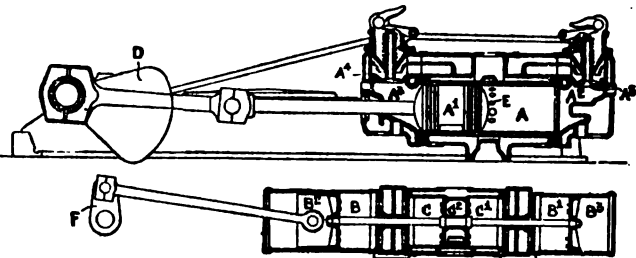

FIG. 5.—Longitudinal Section of Two-Cycle Engine (Koerting-Clerk), new type, by Messrs Mather & Platt, Ltd.

of Glasgow, has attained considerable success in driving considerable pumps for blast furnaces, in producing electric light, and in driving iron rolling mills.

Large gas engines are undoubtedly making great progress, as will be seen from the following interesting particulars prepared in 1908 by Mr R. E. Mathot of Brussels giving the numbers and horse power of large gas engines which had then been recently manufactured in Europe.

Messrs Crossley Brothers, Limited, 57 motors, with an aggregate of 23,650 h.p.; Messrs Ehrhardt & Schmer, 59 motors, total 69,790 h.p.; the Otto Gasmotoren Fabrik, 82, total 47,400 h.p.; Gebrüder Koerting, 198, total 165,760 h.p.; Société Alsacienne, 55, total 23,410 h.p.; Société John Cockerill, 148, total 102,925 h.p.; Société Suisse, Winterthur, 67, total 8620 h.p.; Vereinigte Maschinen-

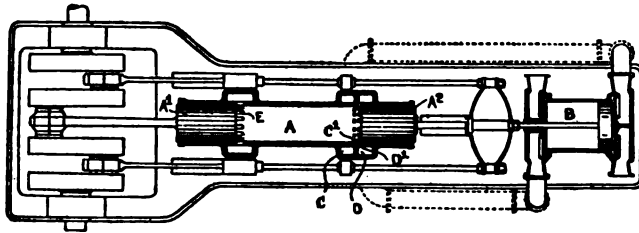

FIG. 6.—Arrangement of Oechelhäuser Gas Engine.

fabriken, Augsburg and Nürnberg, 215, total 256, 240 h.p. The mean power of each gas engine made by Messrs Ehrhardt & Schmer and the Augsburg and Nürnberg companies is in each case 1200 h.p. It is stated that in one factory there are gas engines representing a total output of 35,000 h.p. These European large gas engines thus give nearly 575,000 h.p. between them.

The installation of large gas engines has made considerable progress in America. Mr E. L. Adams estimated that 350,000 h.p. was at work or in construction in the United States in 1908. The first large engines were installed at the works of the Lackawanna Steel Co., Buffalo, New York. They were of the Koerting-Clerk type, and were built by the De La Vergne Co. of New York. They included 16 blowing engines, each of 2000 h.p., and 8 engines of 1000 h.p. each, driving dynamos to produce electric light. This large power plant was started in 1902. The Westinghouse Co. of Pittsburgh have also built large engines, several of which are in operation at the various works of the Carnegie Steel Co. These Westinghouse engines are of the horizontal twin tandem type, having two cranks and four double-acting cylinders in each unit, the cylinders being 38 in. in diameter and the stroke 54 in. The Snow Steam Pump Co. have built similar horizontal tandem engines with cylinders of 42 in. diameter and 54 in. stroke. The English Westinghouse Co. have also designed large gas engines, and they exhibited a very interesting vertical multiple cylinder gas engine having four cranks and eight single-acting cylinders, four pairs, in tandem, at the Franco-British Exhibition of 1908; it gave 750 h.p., and the pistons were not watered.

Over two million horse-power of the smaller gas engines are now at work in the world, and certainly above one million horse-power of petrol motors.

The application of large gas engines to marine work, the compounding of the gas engine, and many other matters are being strenuously pursued. Capitaine of Frankfort-on-Main has built several vessels used for towing purposes in which the vessel is driven by gas engines operated by means of suction gas-producers consuming anthracite. Messrs Thornycroft and Messrs Beardmore in Great Britain have adopted the Capitaine designs, and both firms have applied them to sea-going vessels, Thornycroft to a gas launch which has been tested in the Solent, and Beardmore to an old gunboat, the "Rattler." The "Rattler" was fitted with five-cylinder Otto cycle engines and suction gas-producers giving 500 i.h.p., and has sailed some 1500 m. under gas power only. There are many difficulties to be overcome before large light and sufficiently slow-moving gas engines can be installed on board ship, but progress is being made, and without doubt all difficulties will be ultimately surmounted and gas power successfully applied to ships for both large and small power.

The flame and incandescent tube methods of ignition have

been displaced by electrical ignition of both high and low tension types; all large gas engines are ignited electrically and generally by more than one igniter per cylinder.

The governing of large gas engines, too, is now effected so as to keep up continuity of impulses by the method either of throttling the charge inlet or by varying the point of admission of gas alone or air and gas mixed.

It may be said, indeed, without exaggeration, that the whole world is now alive to the possibilities of the internal-combustion motor, and that progress will be more and more rapid. This motor has almost fulfilled the expectations of those engineers who have devoted a large part of their lives to its study and advancement. They are looking forward now to the completion of the work begun so many years ago, and expect, at no distant date, to find the internal-combustion motor competing with the steam engine even in its latest form, the steam turbine, on sea as vigorously as it does at present on land.

Thermal Efficiency of Four-Cycle Engines.—The Otto and Clerk type engines are usually designated respectively four-cycle and two-cycle, because in the Otto type four strokes are necessary to complete the power-producing cycle of the engine and in the Clerk engine two strokes complete the cycle.

Indicated thermal efficiency may be defined as the proportion of the total heat of combustion which appears as work done by the explosion and expansion upon the piston. Brake thermal efficiency may be defined as the proportion of the total heat of combustion which appears as work given out by the engine available for overcoming external resistances; that is, brake thermal efficiency is the effective efficiency of the engine for doing work. In the early gas engines the indicated thermal efficiency was only 16%, as shown by tests of Otto engines from about 1877 to 1882, but now indicated thermal efficiencies of from 35% to 37% are often obtained. Some experimenters claim even higher efficiencies, but even 37% is higher than ordinary best practice of 1909. Table I. has been prepared to show this advance. It shows, in addition to indicated thermal

TABLE I.—Indicated and Brake Thermal Efficiency of Four-Cycle Engines from 1882 to 1908.

No.	Mechanical Efficiency.	Names of Experimenters.	Year.	Dimensions of Engine.	Indicated Thermal Efficiency.	Brake Thermal Efficiency.	Type of Engine.
	Per cent.				Per cent.	Per cent.	
1	87.6	Slaby	1882	6.75" × 13.7"	16	14	Deutz
2	84.2	Thurston	1884	8.5" × 14"	17	14.3	Crossley
3	86.1	Society of Arts	1888	9.5" × 18"	22	18.9	Crossley
4	80.9	Society of Arts	1888	9.02" × 14"	21	17	Griffin (6-cycle)
5	87.3	Kennedy	1888	7.5" × 15"	21	18.3	Beck (6-cycle)
6	82.0	Capper	1892	8.5" × 18"	22.8	17.4	Crossley
7	87.0	Robinson	1898	10" × 18"	28.7	25	National
8	83	Humphrey	1900	26" × 36"	31	25.7	Crossley
9	81.7	Witz	1900	51.2" × 55.13"	28	22.9	Cockerill
10	85.5	Inst. Civil. Eng.	1905	14" × 22"	35 ¹	29.9	National
11	77.1	Burstall	1907	16" × 24"	41.5 ²	32	Premier
12	87.5	Hopkinson	1908	11.5" × 21"	36.8	32.2	Crossley

efficiency, the brake thermal efficiency and the mechanical efficiency, together with other particulars such as engine dimensions, types and names of experimenters. It will be seen that brake thermal efficiency has also increased from 14% to 32%; that is, practically one-third of the whole heat of combustion is obtained by these engines in effective work available for all motive power purposes.

Thermal Efficiency of Two-Cycle Engines.—It has been found that two-cycle engines present greater practical difficulties in regard to obtaining high indicated and brake thermal efficiencies, but the thermodynamic considerations are not affected by the practical difficulties. As shown by Table II., these engines improved in indicated thermal efficiency from the value of 16.4% attained in 1884 to 38% in 1903, while the brake thermal efficiency rose in the same period from 14% to 29%. The numbers in Table II. are not so well established as those in Table I. The four-cycle engines have been so far subjected to much more rigid and authoritative tests than those of the two-cycle. It is interesting to see from the table

¹ The value 35% is deduced by the author from the Inst.C.E. Committee's values.

² This value is, in the author's view, too high; probably due to indicator error.

that the mechanical efficiency of the early Clerk engines was 84%, while in the later large engines of the same type it has fallen to 75%.

Standards of Thermal Efficiency.—To set up an absolute standard of thermal efficiency it is necessary to know in a complete manner the physical and chemical properties and occurrences in a gaseous explosion. A great deal of attention has been devoted to gaseous explosions by experimenters in England and on the continent of Europe, and much knowledge has been obtained from the work of Mallard and Le Chatelier, Clerk, Langen, Petavel, Hopkinson and Bairdow and Alexander. From these and other experiments it is possible to measure approximately the internal energy or the specific heats of the gases of combustion at very high temperatures, such as 2000° C.; and to advance the knowledge on the subject a committee of the British Association was formed at Leicester in 1907. Recognizing, in 1882, that it was impossible to base any standard cycle of efficiency upon the then existing knowledge of gaseous explosions Dugald Clerk proposed what is called the air standard. This standard has been used for many years, and it was officially adopted by a committee of the Institution of Civil Engineers appointed in 1903; this committee's two reports, dated March 1905 and December 1905, definitely adopting the air-standard cycle as the standard of efficiency for internal combustion engines. This standard assumes that the working fluid is air, that its specific heat is constant throughout the range of temperature, and that the

adiabatic compression raises the pressure and temperature of the working fluid through a certain range; the heat supply is added while the volume remains constant, that is, the volume to which the fluid is diminished by compression. Adiabatic expansion reduces the pressure and temperature of the working fluid until the volume is the same as the original volume before compression, and the necessary heat is discharged from the cycle at constant volume during falling temperature. Here also it can be shown that the thermal efficiency depends on the ratio between the temperature before compression and the temperature after compression. It is as before $E = 1 - 1/r^{\gamma}$. Where t is the temperature and v the volume before compression, and t_2 the temperature and v_2 the volume after adiabatic compression, it can be shown that $(\frac{t_2}{t})^{\gamma} = \frac{v}{v_2}$, so that E may be written

$$E = 1 - \left(\frac{v_2}{v}\right)^{\gamma-1}$$

and if $v_2/v = 1/r$, the compression ratio, then

$$E = 1 - \left(\frac{1}{r}\right)^{\gamma-1}$$

Thus in all three symmetrical cycles of constant temperature, constant pressure and constant volume the thermal efficiency depends only on the ratio of the maximum volume before compression to the volume after compression; and, given this ratio, called $1/r$, which does not depend in any way upon temperature determinations but only upon the construction and valve-setting of the engine, we have a means of settling the ideal efficiency proper for the particular engine. Any desired ideal efficiency may be obtained from any of the cycles by selecting a suitable compression ratio. Table III., giving the theoretical thermal efficiency for these three symmetrical cycles of constant temperature, pressure and volume, extends from a compression ratio of $\frac{1}{2}$ to $1\frac{1}{2}$. Such compression ratios as

TABLE II.—Indicated and Brake Thermal Efficiency of Two-cycle Engines from 1884 to 1908.

Mechanical Efficiency.	Name of Experimenter.	Year.	Dimensions of Motor Cylinders.	Indicated Thermal Efficiency.	Brake Thermal Efficiency.	Type of Engine.
Per cent.			Diam. Stroke.	Per cent.	Per cent.	
84	Garrett	1884	9" X 20"	16.4	14.2	Clerk-Sterne
	Stockport Co.	1884			11.2	Andrews & Co.
83	Clerk	1887	7" X 15"	20.2	16.9	Clerk-Tangye
	Atkinson	1885	7" X 15"		15	Atkinson
75	Meyer	1903	26 1/2" X (2" X 37 1/2")	38	29	Oechelhäuser.
75	Mather & Platt	1907		39.6	23	Koerting

value of the ratio between the specific heat at constant volume and constant pressure is 1.4. The air-standard efficiency for different cycles will be found fully discussed in the report of that committee, but space here only allows of a short discussion of the various cycles using compression previous to ignition.

For such engines there are three symmetrical thermodynamic cycles, and each cycle has the maximum thermal efficiency possible for the conditions assumed. The three types may be defined as cycles of (1) constant temperature, (2) constant pressure, and (3) constant volume.

The term constant temperature indicates that the supply of heat is added at constant temperature. In this cycle adiabatic compression is assumed to raise the temperature of the working fluid from the lowest to the highest point. The fluid then expands at constant temperature, so that the whole of the heat is added at a constant temperature, which is the highest temperature of the cycle. The heat supply is stopped at a certain period, and then the fluid adiabatically expands until the temperature falls to the lowest temperature. A compression operation then takes place at the lowest temperature, so that the necessary heat is discharged by isothermal compression at the lower temperature. It will be recognized that this is the Carnot cycle, and the efficiency E is the maximum possible between the temperature limits in accordance with the well-known second law of thermo-dynamics. This efficiency is $E = (T - T')/T = 1 - T'/T$, where T is the absolute temperature at which heat is supplied and T' the absolute temperature at which heat is discharged.

It is obvious that the temperatures before and after compression are here the same as the lower and the higher temperatures, so that if t be the temperature before compression and t_2 the temperature after compression, then $E = 1 - t/t_2$. This equation in effect says that thermal efficiency operating on the Carnot cycle depends upon the temperatures before and after compression.

The constant pressure cycle is so called because heat is added to the working fluid at constant pressure. In this cycle adiabatic compression raises the pressure—not the temperature—from the lower to the higher limit. At the higher limit of pressure, heat is added while the working fluid expands at a constant pressure. The temperature thus increases in proportion to increase of volume. When the heat supply ceases, adiabatic expansion proceeds and reduces the pressure of the working fluid from the higher to the lower point. Again here we are dealing with pressure and not temperature. The heat in this case is discharged from the cycle at the lower pressure but at diminishing temperature. It can be shown in this case also that $E = 1 - t/t_2$, that is, that although the maximum temperature of the working fluid is higher than the temperature of compression and the temperature at the end of adiabatic expansion is higher than the lower temperature, yet the proportion of heat convertible into work is determined here also by the ratio of the temperatures before and after compression.

The constant volume cycle is so called because the heat required is added to the working fluid at constant volume. In this cycle

TABLE III.—Theoretical Thermal Efficiency for the Three Symmetrical Cycles of Constant Temperature, Pressure and Volume.

1/r	E	1/r	E
1/2	0.246	1/2	0.55
2/3	0.36	2/3	0.61
3/4	0.48	3/4	0.70
4/5	0.48	4/5	0.85

100 are, of course, not used in practice. The ordinary value in constant volume engines ranges from $\frac{1}{10}$ to $\frac{1}{4}$. In the Diesel engine, which is a constant pressure engine, the ratio is usually $\frac{1}{10}$. As the value of $1/r$ increases beyond certain limits, the effective power for given cylinder dimensions diminishes, because the temperature of compression is rapidly approaching the maximum temperature possible by explosion; thus a compression of $\frac{1}{10}$ th raises the temperature of air from 17° C. to about 1600° C., and as 2000° C. is the highest available explosion temperature for ordinary purposes, it follows that a very small amount of work would be possible from an engine using such compressions, apart from other mechanical considerations. It has long been recognized that constant pressure and constant volume engines have the same thermal efficiency for similar range of compression temperature, but Prof. H. L. Callendar first pointed out the interesting fact that a Carnot cycle engine is equally dependent upon the ratio of the temperature before and after compression, and that its efficiency for a given compression ratio is the same as the efficiencies proper for constant pressure and constant volume engines. Prof. Callendar demonstrated this at a meeting of the Institution of Civil Engineers Committee on thermal standards in 1904. The work of this committee, together with Clerk's investigations, prove that in modern gas-engines up to 50 h.p. it may be taken that the best result possible in practice is given by multiplying the air-standard value by .7. For instance, an engine with a compression ratio of one-third has an air-standard efficiency of 0.36, and the actual indicated efficiency of a well-designed engine should be .36 multiplied by .7 = 0.25. If, however, the compression ratio be raised to one-fifth, then the air-standard value .48 multiplied by .7 gives .336. The ideal efficiency of the real working fluid can be proved to be about 20% short of the air-standard values given. (D. C.)

GASKELL, ELIZABETH CLEGHORN (1810-1865), English novelist and biographer, was born on the 20th of September 1810 in Lindsay Row, Chelsea, London, since destroyed to make way for Cheyne Walk. Her father, William Stevenson (1772-1840), came from Berwick-on-Tweed, and had been successively Unitarian minister, farmer, boarding-house keeper for students at Edinburgh, editor of the *Scots Magazine*, and contributor to the

Edinburgh Review, before he received the post of Keeper of the Records to the Treasury, which he held until his death. His first wife, Elizabeth Holland, was Mrs Gaskell's mother. She was a Holland of Sandebridge, Knutsford, Cheshire, in which county the family name had long been and is still of great account. Mrs Stevenson died a month after her daughter was born, and the babe was carried into Cheshire to Knutsford to be adopted by her aunt, Mrs Lumb. Thus her childhood was spent in the pleasant environment that she has idealized in *Cranford*. At fifteen years of age she went to a boarding-school at Stratford-on-Avon, kept by Miss Byerley, where she remained until her seventeenth year. Then came occasional visits to London to see her father and his second wife, and after her father's death in 1829 to her uncle, Swinton Holland. Two winters seem to have been spent in Newcastle-on-Tyne in the family of William Turner, a Unitarian minister, and a third in Edinburgh. On the 30th of August 1832 she was married in the parish church of Knutsford to William Gaskell, minister of the Unitarian chapel in Cross Street, Manchester, and the author of many treatises and sermons in support of his own religious denomination. Mr Gaskell held the chair of English history and literature in Manchester New College.

Henceforth Mrs Gaskell's life belonged to Manchester. She and her husband lived first in Dover Street, then in Rumford Street, and finally in 1850 at 84 Plymouth Grove. Her literary life began with poetry. She and her husband aspired to emulate George Crabbe and write the annals of the Manchester poor. One poetic "Sketch," which appeared in *Blackwood's Magazine* for January 1837, seems to have been the only outcome of this ambition. Henceforth, while in perfect union in all else, husband and wife were to go their separate literary ways, Mrs Gaskell to become a successful novelist, whose books were to live side by side with those of greater masters, Mr Gaskell to be a distinguished Unitarian divine, whose sermons, lectures and hymns are now all but forgotten. In her earlier married life Mrs Gaskell was mainly occupied with domestic duties—she had seven children—and philanthropic work among the poor. Her first published prose effort was probably a letter that she addressed to William Howitt on hearing that he contemplated a volume entitled *Visits to Remarkable Places*. She then told the legend of Clopton Hall, Warwickshire, as she had heard it in schooldays, and Howitt incorporated the letter in that book, which was published in 1840. Serious authorship, however, does not seem to have been commenced until four or five years later. In 1844 Mr and Mrs Gaskell visited North Wales, where their only son "Willie" died of scarlet fever at the age of ten months, and it was, it is said, to distract Mrs Gaskell from her sorrow that her husband suggested a long work of fiction, and *Mary Barton* was begun. There were earlier short stories in *Howitt's Journal*, where "Libbie Marsh's Three Eras" and "The Sexton's Hero" appeared in 1847. But it was *Mary Barton: A Tale of Manchester Life* that laid the foundation of Mrs Gaskell's literary career. It was completed in 1847 and offered to a publisher who returned it unread. It was then sent to Chapman & Hall, who retained the manuscript for a year without reading it or communicating with the author. A reminder, however, led to its being sought for, considered and accepted, the publishers agreeing to pay the author £100 for the copyright. It was published anonymously in two volumes in 1848. This story had a wide popularity, and its author secured first the praise and then the friendship of Carlyle, Landor and Dickens. Dickens indeed asked her in 1850 to become a contributor to his new magazine *Household Words*, and here the whole of *Cranford* appeared at intervals from December 1851 to May 1853, exclusive of one sketch, reprinted in the "World's Classics" edition (1907), that was published in *All the Year Round* for November 1863. Earlier than this, indeed, for the very first number of *Household Words* she had written "Lizzie Leigh." Mrs Gaskell's second book, however, was *The Moorland Cottage*, a dainty little volume that appeared at Christmas 1850 with illustrations by Birket Foster. In the Christmas number of *Household Words* for 1853 appeared "The Squire's Story," reprinted in *Lizzie Leigh and other Tales* in 1865. In 1855 appeared another long novel, *Ruth*, and the incomparable

Cranford. This last—now the most popular of her books—is an idyll of village life, largely inspired by girlish memories of Knutsford and its people. In *Ruth*, which first appeared in three volumes, Mrs Gaskell turned to a delicate treatment of a girl's betrayal and her subsequent rescue. Once more we are introduced to Knutsford, thinly disguised, and to the little Unitarian chapel in that town where the author had worshipped in early years. In 1855 *North and South* was published. It had previously appeared serially in *Household Words*. Then came—in 1857—the *Life of Charlotte Brontë*, in two volumes. Miss Brontë, who had enjoyed the friendship of Mrs Gaskell and had exchanged visits, died in March 1855. Two years earlier she had begged her publishers to postpone the issue of her own novel *Villette* in order that her friend's *Ruth* should not suffer. This biography, by its vivid presentation of the sad, melancholy and indeed tragic story of the three Brontë sisters, greatly widened the interest in their writings and gave its author a considerable place among English biographers. But much matter was contained in the first and second editions that was withdrawn from the third. Certain statements made by the writer as to the school of Charlotte Brontë's infancy, an identification of the "Lowood" of *Jane Eyre* with the existing school, and the acceptance of the story of Bramwell Brontë's ruin having been caused by the woman in whose house he had lived as tutor, brought threats of libel actions. Apologies were published, and the third edition of the book was modified, as Mrs Gaskell declares, by "another hand." The book in any case remains one of the best biographies in the language. An introduction by Mrs Gaskell to the then popular novel, *Mabel Vaughan*, was also included in her work of this year 1857, but no further book was published by her until 1859, when, under the title of *Round the Sofa*, she collected many of her contributions to periodical literature. *Round the Sofa* appeared in two volumes, the first containing only "My Lady Ludlow," the second five short stories. These stories reappeared the same year in one volume as *My Lady Ludlow and other Tales*. In the next year 1860 appeared yet another volume of short stories, entitled *Right at Last and other Tales*. The title story had appeared two years earlier in *Household Words* as "The Sin of a Father." In 1862 Mrs Gaskell wrote a preface to a little book by Colonel Vecchji, translated from the Italian—*Garibaldi and Caprera*, and in 1863 she published her last long novel, *Sylvia's Lovers*, dedicated "to My dear Husband by her who best knows his Value." After this we have—in 1863—a one-volume story, *A Dark Night's Work*, and in the same year *Cousin Phyllis and other Tales* appeared. Reprinted short stories from *All the Year Round*, *Cornhill Magazine*, and other publications, tend to lengthen the number of books published by Mrs Gaskell during her lifetime. *The Grey Woman and other Tales* appeared in 1865.

Mrs Gaskell died on the 12th of November 1865 at Holyburn, Alton, Hampshire, in a house she had just purchased with the profits of her writings as a present for her husband. She was buried in the little graveyard of the Knutsford Unitarian church. Her unfinished novel *Wives and Daughters* was published in two volumes in 1866.

Mrs Gaskell has enjoyed an ever gaining popularity since her death. *Cranford* has been published in a hundred forms and with many illustrators. It is unanimously accepted as a classic. Scarcely less recognition is awarded to the *Life of Charlotte Brontë*, which is in every library. The many volumes of novels and stories seemed of less secure permanence until the falling in of their copyrights revealed the fact that a dozen publishers thought them worth reprinting. The most complete editions, however, are the "Knutsford Edition," edited with introductions by A. W. Ward, in eight volumes (Smith, Elder), and the "World's Classics" edition, edited by Clement Shorter, in 10 volumes (Henry Froude, 1908).

There is no biography of Mrs Gaskell, she having forbidden the publication of any of her letters. See, however, the biographical introduction to the "Knutsford" *Mary Barton* by A. W. Ward; the *Letters of Charles Dickens: Women Writers*, by C. J. Hamilton, second series; *H. B. Stone's Life and Letters*, edited by Annie Fields; *Autobiography of Mrs Fletcher: Mrs Gaskell and Knutsford*, by G. A. Payne; *Cranford*, with a preface by Anso Thackeray Ritchie; *Écrivains modernes de l'Angleterre*, by Emile Montégut. (C. K. S.)

GASSENDI¹ [GASSEND], PIERRE (1592-1655), French philosopher, scientist and mathematician, was born of poor parents at Champtercier, near Digne, in Provence, on the 22nd of January 1592. At a very early age he gave indications of remarkable mental powers and was sent to the college at Digne. He showed particular aptitude for languages and mathematics, and it is said that at the age of sixteen he was invited to lecture on rhetoric at the college. Soon afterwards he entered the university of Aix, to study philosophy under P. Fesaye. In 1612 he was called to the college of Digne to lecture on theology. Four years later he received the degree of doctor of theology at Avignon, and in 1617 he took holy orders. In the same year he was called to the chair of philosophy at Aix, and seems gradually to have withdrawn from theology. He lectured principally on the Aristotelian philosophy, conforming as far as possible to the orthodox methods. At the same time, however, he followed with interest the discoveries of Galileo and Kepler, and became more and more dissatisfied with the Peripatetic system. It was the period of revolt against the Aristotelianism of the schools, and Gassendi shared to the full the empirical tendencies of the age. He, too, began to draw up objections to the Aristotelian philosophy, but did not at first venture to publish them. In 1624, however, after he had left Aix for a canonry at Grenoble, he printed the first part of his *Exercitationes paradoxicae adversus Aristoteles*. A fragment of the second book was published later at La Haye (1659), but the remaining five were never composed, Gassendi apparently thinking that after the *Discusiones Peripateticæ* of Francesco Patrizzi little field was left for his labours.

After 1628 Gassendi travelled in Flanders and Holland. During this time he wrote, at the instance of Mersenne, his examination of the mystical philosophy of Robert Fludd (*Epistola dissertatio in qua præcipua principia philosophiæ R. Fluddi delegantur*, 1631), an essay on parhelia (*Epistola de parheliis*), and some valuable observations on the transit of Mercury which had been foretold by Kepler. He returned to France in 1631, and two years later became provost of the cathedral church at Digne. Some years were then spent in travelling through Provence with the duke of Angoulême, governor of the department. The only literary work of this period is the *Life of Peiresc*, which has been frequently reprinted, and was translated into English. In 1642 he was engaged by Mersenne in controversy with Descartes. His objections to the fundamental propositions of Descartes were published in 1642; they appear as the fifth in the series contained in the works of Descartes. In these objections Gassendi's tendency towards the empirical school of speculation appears more pronounced than in any of his other writings. In 1645 he accepted the chair of mathematics in the Collège Royal at Paris, and lectured for many years with great success. In addition to controversial writings on physical questions, there appeared during this period the first of the works by which he is known in the history of philosophy. In 1647 he published the treatise *De vita, moribus, et doctrina Epicuri libri octo*. The work was well received, and two years later appeared his commentary on the tenth book of Diogenes Laërtius, *De vita, moribus, et placitis Epicuri, seu Animadversiones in X. librum Diog. Laërt.* (Lyons, 1649; last edition, 1675). In the same year the more important *Synagma philosophiæ Epicuri* (Lyons, 1649; Amsterdam, 1684) was published.

In 1648 ill-health compelled him to give up his lectures at the Collège Royal. He travelled in the south of France, spending nearly two years at Toulon, the climate of which suited him. In 1653 he returned to Paris and resumed his literary work, publishing in that year lives of Copernicus and Tycho Brahe. The disease from which he suffered, lung complaint, had, however, established a firm hold on him. His strength gradually failed, and he died at Paris on the 24th of October 1655. A

bronze statue of him was erected by subscription at Digne in 1852.

His collected works, of which the most important is the *Synagma philosophicum* (*Opera*, i. and ii.), were published in 1658 by Montmort (6 vols., Lyons). Another edition, also in 6 folio volumes, was published by N. Averanius in 1727. The first two are occupied entirely with his *Synagma philosophicum*; the third contains his critical writings on Epicurus, Aristotle, Descartes, Fludd and Lord Herbert, with some occasional pieces on certain problems of physics; the fourth, his *Institutio astronomica*, and his *Commentarii de rebus celestibus*; the fifth, his commentary on the tenth book of Diogenes Laërtius, the biographies of Epicurus, N. C. F. de Peiresc, Tycho Brahe, Copernicus, Georg von Puerbach, and Regiomontanus, with some tracts on the value of ancient money, on the Roman calendar, and on the theory of music, to all which is appended a large and prolix piece entitled *Notitia ecclesiæ Diniensis*; the sixth volume contains his correspondence. The *Lives*, especially those of Copernicus, Tycho and Peiresc, have been justly admired. That of Peiresc has been repeatedly printed; it has also been translated into English. Gassendi was one of the first after the revival of letters who treated the *literature* of philosophy in a lively way. His writings of this kind, though too laudatory and somewhat diffuse, have great merit; they abound in those anecdotal details, natural yet not obvious reflections, and vivacious turns of thought, which made Gibbon style him, with some extravagance certainly, though it was true enough up to Gassendi's time—"le meilleur philosophe des littérateurs, et le meilleur littérateur des philosophes."

Gassendi holds an honourable place in the history of physical science. He certainly added little to the stock of human knowledge, but the clearness of his exposition and the manner in which he, like Bacon, urged the importance of experimental research, were of inestimable service to the cause of science. To what extent any place can be assigned him in the history of philosophy is more doubtful. The *Exercitationes* on the whole seem to have excited more attention than they deserved. They contain little or nothing beyond what had been already advanced against Aristotle. The first book expounds clearly, and with much vigour, the evil effects of the blind acceptance of the Aristotelian dicta on physical and philosophical study; but, as is the case with so many of the anti-Aristotelian works of this period, the objections show the usual ignorance of Aristotle's own writings. The second book, which contains the review of Aristotle's dialectic or logic, is throughout Ramist in tone and method. The objections to Descartes—one of which at least, through Descartes's statement of it in the appendix of objections in the *Meditationes* has become famous—have no speculative value, and in general are the outcome of the crudest empiricism. His labours on Epicurus have a certain historical value, but the want of consistency inherent in the philosophical system raised on Epicureanism is such as to deprive it of genuine worth. Along with strong expressions of empiricism we find him holding doctrines absolutely irreconcilable with empiricism in any form. For while he maintains constantly his favourite maxim "that there is nothing in the intellect which has not been in the senses" (*nihil in intellectu quod non prius fuerit in sensu*), while he contends that the imaginative faculty (*phantasia*) is the counterpart of sense—that, as it has to do with material images, it is itself, like sense, material, and essentially the same both in men and brutes; he at the same time admits that the intellect, which he affirms to be immaterial and immortal—the most characteristic distinction of humanity—attains notions and truths of which no effort of sensation or imagination can give us the slightest apprehension (*Op.* ii. 383). He instances the capacity of forming "general notions"; the very conception of universality itself (*ib.* 384), to which he says brutes, who partake as truly as men in the faculty called *phantasia*, never attain; the notion of God, whom he says we may imagine to be corporeal, but understand to be incorporeal; and lastly, the reflex action by which the mind makes its own phenomena and operations the objects of attention.

The *Synagma philosophicum*, in fact, is one of those eclectic systems which unite, or rather place in juxtaposition, irreconcilable dogmas from various schools of thought. It is divided, according to the usual fashion of the Epicureans, into logic (which, with Gassendi as with Epicurus, is truly *canonic*), physics and ethics. The logic, which contains at least one praiseworthy portion, a sketch of the history of the science, is divided into theory of right apprehension (*bene imaginari*), theory of right judgment (*bene proponere*), theory of right inference (*bene colligere*), theory of right method (*bene ordinare*). The first part contains the specially empirical positions which Gassendi afterwards neglects or leaves out of account. The senses, the sole source of knowledge, are supposed to yield us immediately cognition of individual things, *phantasia* (which Gassendi

¹ It was formerly thought that Gassendi was really the genitive of the Latin form *Gassendus*. C. Gätler, however, holds that it is a modernized form of the O. Fr. *Gassendy* (see paper quoted in bibliography).

takes to be material in nature) reproduces these ideas; understanding compares these ideas, which are particular, and frames general ideas. Nevertheless, he at the same time admits that the senses yield knowledge—*not of things—but of qualities only*, and holds that we arrive at the idea of thing or substance by induction. He holds that the true method of research is the analytic, rising from lower to higher notions; yet he sees clearly, and admits, that inductive reasoning, as conceived by Bacon, rests on a general proposition not itself proved by induction. He ought to hold, and in disputing with Descartes he did apparently hold, that the evidence of the senses is the only convincing evidence; yet he maintains, and from his special mathematical training it was natural he should maintain, that the evidence of reason is absolutely satisfactory. The whole doctrine of judgment, syllogism and method is a mixture of Aristotelian and Ramist notions.

In the second part of the *Synagma*, the physics, there is more that deserves attention; but here, too, appears in the most glaring manner the inner contradiction between Gassendi's fundamental principles. While approving of the Epicurean physics, he rejects altogether the Epicurean negation of God and particular providence. He states the various proofs for the existence of an immaterial, infinite, supreme Being, asserts that this Being is the author of the visible universe, and strongly defends the doctrine of the foreknowledge and particular providence of God. At the same time he holds, in opposition to Epicureanism, the doctrine of an immaterial soul, endowed with immortality and capable of free determination. It is altogether impossible to assent to the supposition of Lange (*Gesch. des Materialismus*, 3rd ed., i. 233), that all this portion of Gassendi's system contains nothing of his own opinions, but is introduced solely from motives of self-defence. The positive exposition of atomism has much that is attractive, but the hypothesis of the *calor vitalis* (vital heat), a species of *anima mundi* (world-soul) which is introduced as physical explanation of physical phenomena, does not seem to throw much light on the special problems which it is invoked to solve. Nor is his theory of the weight essential to atoms as being due to an inner force impelling them to motion in any way reconcilable with his general doctrine of mechanical causes.

In the third part, the ethics, over and above the discussion on freedom, which on the whole is indefinite, there is little beyond a milder statement of the Epicurean moral code. The final end of life is happiness, and happiness is harmony of soul and body (*tranquillitas animi et indolentia corporis*). Probably, Gassendi thinks, perfect happiness is not attainable in this life, but it may be in the life to come.

The *Synagma* is thus an essentially unsystematic work, and clearly exhibits the main characteristics of Gassendi's genius. He was critical rather than constructive, widely read and trained thoroughly both in languages and in science, but deficient in speculative power and original force. Even in the department of natural science he shows the same inability steadfastly to retain principles and to work from them; he wavers between the systems of Brahe and Copernicus. That his revival of Epicureanism had an important influence on the general thinking of the 17th century may be admitted; that it has any real importance in the history of philosophy cannot be granted.

AUTHORITIES.—Gassendi's life is given by Sorbière in the first collected edition of the works, by Bugerel, *Vie de Gassendi* (1737; 2nd ed., 1770), and by Damiron, *Mémoire sur Gassendi* (1839). An abridgment of his philosophy was given by his friend, the celebrated traveller, Bernier (*Abrégé de la philosophie de Gassendi*, 8 vols., 1678; 2nd ed., 7 vols., 1684). The most complete surveys of his work are those of G. S. Brett (*Philosophy of Gassendi*, London, 1908), Buhle (*Geschichte der neuern Philosophie*, iii. 1, 87-222), Damiron (*Mémoires pour servir à l'histoire de philosophie au XVII^e siècle*), and P. F. Thomas (*La Philosophie de Gassendi*, Paris, 1889). See also Ritter, *Geschichte der Philosophie*, x. 543-571; Feuerbach, *Gesch. d. neu. Phil. von Bacon bis Spinoza*, 127-150; F. X. Kieß, *P. Gassendi's Erkenntnistheorie und seine Stellung zum Materialismus* (1893) and "Gassendi's Skepticismus," in *Philos. Jahrb.*, vi. (1893); C. Güttler, "Gassend oder Gassendi?" in *Archiv f. Gesch. d. Philos.*, x. (1897), pp. 238-242. (R. A. v. X.)

GASTEIN, in the duchy of Salzburg, Austria, a side valley of the Pongau or Upper Salzburg, about 25 m. long and 1½ m. broad, renowned for its mineral springs. It has an elevation of between 3000 and 3500 ft. Behind it, to the S., tower the mountains Mallnitz or Nassfeld-Tauern (7907 ft.) and Ankogel (10,673 ft.), and from the right and left of these mountains two smaller ranges run northwards forming its two side walls. The river Ache traverses the valley, and near Wildbad-Gastein forms two magnificent waterfalls, the upper, the Kesselfall (196 ft.), and the lower, the Bärenfall (296 ft.). Near these falls is the Schleierfall (250 ft.), formed by the stream which drafts the Bockhart-see. The valley is also traversed by the so-called Tauern railway (opened up to Wildbad-Gastein in September 1905), which goes to Mallnitz, piercing the Tauern range by a

tunnel 9260 yds. in length. The principal villages of the valley are Hof-Gastein, Wildbad-Gastein and Böckstein.

HOF-GASTEIN, pop. (1900) 840, the capital of the valley, is also a watering-place, the thermal waters being conveyed here from Wildbad-Gastein by a conduit 5 m. long, constructed in 1828 by the emperor Francis I. of Austria. Hof-Gastein was, after Salzburg, the richest place in the duchy, owing to its gold and silver mines, which were already worked during the Roman period. During the 16th century these mines were yielding annually 1180 lb of gold and 9500 lb of silver, but since the 17th century they have been much neglected and many of them are now covered by glaciers.

WILDBAD-GASTEIN, commonly called *Bad-Gastein*, one of the most celebrated watering-places in Europe, is picturesquely situated in the narrow valley of the Gasteiner Ache, at an altitude of 3480 ft. The thermal springs, which issue from the granite mountains, have a temperature of 77°-120° F., and yield about 880,000 gallons of water daily. The water contains only 0.35 to 1000 of mineral ingredients and is used for bathing purposes. The springs are resorted to in cases of nervous affections, senile and general debility, skin diseases, gout and rheumatism. Wildbad-Gastein is annually visited by over 8500 guests. The springs were known as early as the 7th century, but first came into fame by a successful visit paid to them by Duke Frederick of Austria in 1436. Gastein was a favourite resort of William I. of Prussia and of the Austrian imperial family, and it was here that, on the 14th of August 1865, was signed the agreement known as the Gastein Convention, which by dividing the administration of the conquered provinces of Schleswig and Holstein between Austria and Prussia postponed for a while the outbreak of war between the two powers. It was also here (August-September 1879) that Prince Bismarck negotiated with Count Julius Andrassy the Austro-German treaty, which resulted in the formation of the Triple Alliance.

See Pröll, *Gastein, Its Springs and Climate* (Vienna, 5th ed., 1893).

GASTRIC ULCER (ulcer of the stomach), a disease of much gravity, commonest in females, and especially in anæmic domestic servants. It is connected in many instances with impairment of the circulation in the stomach and the formation of a clot in a small blood-vessel (thrombosis). It may be due to an impoverished state of the blood (anæmia), but it may also arise from disease of the blood-vessels, the result of long-continued indigestion and gastric catarrh.

When clotting takes place in a blood-vessel the nutrition of that limited area of the stomach is cut off, and the patch undergoes digestion by the unresisted action of the gastric juices, an ulcer being formed. The ulcer is usually of the size of a silver threepence or sixpence, round or oval, and, eating deeply, is apt to make a hole right through the coats of the stomach. Its usual site is upon the posterior wall of the upper curvature, near to the pyloric orifice. It may undergo a healing process at any stage, in which case it may leave but little trace of its existence; while, on the other hand, it may in the course of cicatrizing produce such an amount of contraction as to lead to stricture of the pylorus, or to a peculiar hour-glass deformity of the stomach. Perforation is in most cases quickly fatal, unless previously the stomach has become adherent to some neighbouring organ, by which the dangerous effects of this occurrence may be averted, or unless the condition has been promptly recognized and an operation has been quickly done. Usually there is but one ulcer, but sometimes there are several ulcers.

The symptoms of ulcer of the stomach are often indefinite and obscure, and in some cases the diagnosis has been first made on the occurrence of a fatal perforation. First among the symptoms is pain, which is present at all times, but is markedly increased after food. The pain is situated either at the lower end of the breast-bone or about the middle of the back. Sometimes it is felt in the sides. It is often extremely severe, and is usually accompanied with localized tenderness and also with a sense of oppression, and by an inability to wear tight clothing. The pain is due to the movements of the stomach set up by the presence

of the food, as well as to the irritation of the inflamed nerve filaments in the floor of the ulcer. Vomiting is a usual symptom. It occurs either soon after the food is swallowed or at a later period, and generally relieves the pain and discomfort. Vomiting of blood (haematemesis) is a frequent and important symptom. The blood may show itself in the form of a brown or coffee-like mixture, or as pure blood of dark colour and containing clots. It comes from some vessel or vessels which the ulcerative process has ruptured. Blood is also found mixed with the discharges from the bowels, rendering them dark or tarry-looking. The general condition of the patient with gastric ulcer is, as a rule, that of extreme ill-health, with pallor, emaciation and debility. The tongue is red, and there is usually constipation. In most of the cases the disease is chronic, lasting for months or years; and in those cases where the ulcers are large or multiple, incomplete healing may take place, relapses occurring from time to time. But the ulcers may give rise to no marked symptoms, and there have been instances where fatal perforation suddenly took place, and where post-mortem examination revealed the existence of long-standing ulcers which had given rise to no suggestive symptoms. While gastric ulcer is to be regarded as dangerous, its termination, in the great majority of cases, is in recovery. It frequently, however, leaves the stomach in a delicate condition, necessitating the utmost care as regards diet. Occasionally the disease proves fatal by sudden haemorrhage, but a fatal result is more frequently due to perforation and the escape of the contents of the stomach into the peritoneal cavity, in which case death usually occurs in from twelve to forty-eight hours, either from shock or from peritonitis. Should the stomach become adherent to another organ, and fatal perforation be thus prevented, chronic "indigestion" may persist, owing to interference with the natural movements of the stomach. Stricture of the pylorus and consequent dilatation of the stomach may be caused by the cicatrization of an ulcer.

The patient should at once be sent to bed and kept there, and allowed for a while nothing stronger than milk and water or milk and lime water. But if bleeding has recently taken place no food whatever should be allowed by the stomach, and the feeding should be by nutrient enemata. As the symptoms quiet down, eggs may be given beaten up with milk, and later, bread and milk and home-made broths and soups. Thus the diet advances to chicken and vegetables rubbed through a sieve, to custard pudding and bread and butter. As regards medicines, iron is the most useful, but no pills of any sort should be given. Under the influence of rest and diet most gastric ulcers get well. The presence of healthy-looking scars upon the surface of the stomach, which are constantly found in operating upon the interior of the abdomen, or as revealed in post-mortem examinations, are evidence of the truth of this statement. It is unlikely that under the treatment just described perforation of the stomach will take place, and if the surgeon is called in to assist he will probably advise that operation is inadvisable. Moreover, he knows that if he should open the abdomen to search for an ulcer of the stomach he might fail to find it; more than that, his search might also be in vain if he opened the stomach itself and examined the interior. Serious haemorrhages, however, may make it necessary that a prompt and thorough search should be made in order that the surgeon may endeavour to locate the ulcer, and, having found it, secure the damaged vessel and save the patient from death by bleeding.

Perforation of a gastric ulcer having taken place, the septic germs, which were harmless whilst in the stomach, escape with the rest of the contents of the stomach into the general peritoneal cavity. The immediate effects of this leakage are sudden and severe pain in the upper part of the abdomen and a great shock to the system (collapse). The muscles of the abdominal wall become hard and resisting, and as peritonitis appears and the intestines are distended with gas, the abdomen is distended and becomes greatly increased in size and ceases to move, the respiratory movements being short and quick. At first, most likely, the temperature drops below normal, and the pulse quickens. Later, the temperature rises. If nothing is

done, death from the septic poisoning of peritonitis is almost certain.

The treatment of ruptured gastric ulcer demands immediate operation. An incision should be made in the upper part of the middle line of the abdomen, and the perforation should be looked for. There is not, as a rule, much difficulty in finding it, as there are generally deposits of lymph near the spot, and other signs of local inflammation; moreover, the contents of the stomach may be seen escaping from the opening. The ulcer is to be closed by running a "purse-string" suture in the healthy tissue around it, and the place is then buried in the stomach by picking up small folds of the stomach-wall above and below it and fixing them together by suturing. This being done, the surface of the stomach, and the neighbouring viscera which have been soiled by the leakage, are wiped clean and the abdominal wound is closed, provision being made for efficient drainage. A large proportion of cases of perforated gastric ulcer thus treated recover. (E. O.)

GASTRITIS (Gr. *γαστήρ*, stomach), an inflammatory affection of the stomach, of which the condition of catarrh, or irritation of its mucous membrane, is the most frequent and most readily recognized. This may exist in an acute or a chronic form, and depends upon some condition, either local or general, which produces a congested state of the circulation in the walls of the stomach (see DIGESTIVE ORGANS: *Pathology*).

Acute Gastritis may arise from various causes. The most intense forms of inflammation of the stomach are the toxic conditions which follow the swallowing of corrosive poisons, such as strong mineral acids of alkalis which may extensively destroy the mucous membrane. Other non-corrosive poisons cause acute degeneration of the stomach wall (see POISONS). Acute inflammatory conditions may be secondary to zymotic diseases such as diphtheria, pyaemia, typhus fever and others. Gastritis is also caused by the ingestion of food which has begun to decompose, or may result from eating unsuitable articles which themselves remain undigested and so excite acute catarrhal conditions. These give rise to the symptoms well known as characterizing an acute "bilious attack," consisting in loss of appetite, sickness or nausea, and headache, frontal or occipital, often accompanied with giddiness. The tongue is furred, the breath foetid, and there is pain or discomfort in the region of the stomach, with sour eructations, and frequently vomiting, first of food and then of bilious matter. An attack of this kind tends to subside in a few days, especially if the exciting cause be removed. Sometimes, however, the symptoms recur with such frequency as to lead to the more serious chronic form of the disease.

The treatment bears reference, in the first place, to any known source of irritation, which, if it exist, may be expelled by an emetic or purgative (except in cases due to poisoning). This, however, is seldom necessary, since vomiting is usually present. For the relief of sickness and pain the sucking of ice and counter-irritation over the region of the stomach are of service. Further, remedies which exercise a soothing effect upon an irritable mucous membrane, such as bismuth or weak alkaline fluids, and along with these the use of a light milk diet, are usually sufficient to remove the symptoms.

Chronic Gastric Catarrh may result from the acute or may arise independently. It is not infrequently connected with antecedent disease in other organs, such as the lungs, heart, liver or kidneys, and it is especially common in persons addicted to alcoholic excess. In this form the texture of the stomach is more altered than in the acute form, except in the toxic and febrile forms above referred to. It is permanently in a state of congestion, and its mucous membrane and muscular coat undergo thickening and other changes, which markedly affect the function of digestion. The symptoms are those of dyspepsia in an aggravated form (see DYSPEPSIA), of which discomfort and pain after food, with distension and frequently vomiting, are the chief; and the treatment must be conducted in reference to the causes giving rise to it. The careful regulation of the diet, alike as to the amount, the quality, and the intervals between meals, demands special attention. Feeding on artificially soured milk may in

many cases be useful. Lavage or washing out of the stomach with weak alkaline solutions has been used with marked success in the treatment of chronic gastritis. Of medicinal agents, bismuth, arsenic, nux vomica, and the mineral acids are all of acknowledged efficacy, as are also preparations of pepsin.

GASTROPODA, the second of the five classes of animals constituting the phylum Mollusca. For a discussion of the relationship of the Gastropoda to the remaining classes of the phylum, see MOLLUSCA.

The Gastropoda are mainly characterized by a loss of symmetry, produced by torsion of the visceral sac. This torsion may be resolved into two successive movements. The first is a ventral flexure in the antero-posterior or sagittal plane; the result of this is to approximate the two ends of the alimentary canal. In development, the openings of the mantle-cavity and the anus are always originally posterior; later they are brought forward ventrally. During this first movement flexure is also produced by the coiling of the visceral sac and shell; primitively the latter was bowl-shaped; but the ventral flexure, which brings together the two extremities of the digestive tube, gives the visceral sac the outline of a more or less acute cone. The shell necessarily takes this form also, and then becomes coiled in a dorsal or anterior plane—that is to say, it becomes exogastric. This condition may be seen in embryonic *Patellidae*, *Fissurellidae* and *Trochidae* (fig. 1, A), and agrees with the method of coiling of a mollusc without lateral torsion, such as *Nautilus*. But ultimately the coil becomes ventral or endogastric, in consequence of the second torsion movement then apparent.

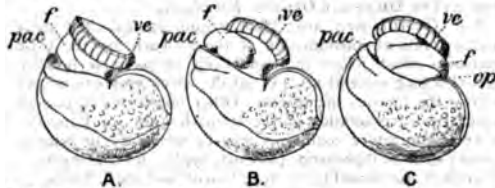

From Lankester's *Treatise on Zoology*.

FIG. 1.—Three stages in the development of *Trochus*, during the process of torsion. (After Robert.)

- A, Nearly symmetrical larva. *f*, Foot.
ve, Visceral sac.
pac, Pallial cavity.
op, Operculum.
 B, A stage 1 hour later than A.
 C, A stage 3 hours later than A.

The shell is represented as fixed, while the head and foot rotate from left to right. In reality the head and foot are fixed and the shell rotates from right to left.

The second movement is a lateral torsion of the visceral mass, the foot remaining a fixed point; this torsion occurs in a plane approximately at right angles to that of the first movement, and carries the pallial aperture and the anus from behind forwards. If, at this moment, the animal were placed with mouth and ventral surface turned towards the observer, this torsion carries the circumanal complex in a clockwise direction (along the right side in dextral forms) through 180° as compared with its primitive condition. The (primitively) right-hand organs of the complex thus become left-hand, and vice versa. The visceral commissure, while still surrounding the digestive tract, becomes looped; its right half, with its proper ganglion, passes to the left side over the dorsal face of the alimentary canal (whence the name supra-intestinal), while the left half passes below towards the right side, thus originating the name infra-intestinal given to this half and to its ganglion. Next, the shell, the coil of which was at first exogastric, being also included in this rotation through 180° , exhibits an endogastric coiling (fig. 1, B, C). This, however, is not generally retained in one plane, and the spire projects, little by little, on the side which was originally left, but finally becomes right (in dextral forms, with a clockwise direction, if viewed from the side of the spire; but counter-clockwise in sinistral forms). Finally, the original symmetry of the circumanal complex vanishes; the anus leaves the centre of the pallial cavity and passes towards the right side (left side in sinistral forms); the organs of this side become atrophied and disappear. The essential feature of the asymmetry of Gastropoda is the atrophy or disappearance of the primitively left half of the circumanal complex (the right half in sinistral forms), including the gill, the auricle, the osphradium, and the hypobranchial gland and the kidney.

In dextral Gastropods the only structure found on the topographically right side of the rectum is the genital duct. But this is not part of the primitive complex. It is absent in the most primitive and symmetrical forms, such as *Haliotis* and *Pleurotomaria*. Originally the gonads opened into the kidneys. In the most primitive existing Gastropods the gonad opens into the right kidney (*Patellidae*, *Trochidae*, *Fissurellidae*). The gonaduct, therefore, is derived from

the topographically right kidney. The transformation has been actually shown to take place in the development of *Paludina*. In a dextral Gastropod the shell is coiled in a right-handed spiral from apex to mouth, and the spire also projects to the right of the median plane of the animal.

When the shell is sinistral the asymmetry of the organs is usually reversed, and there is a complete situs inversus viscerum, the direction of the spiral of the shell corresponding to the position of the organs of the body. *Triforis*, *Physa*, *Clausilia* are examples of sinistral Gastropods, but reversal also occurs as an individual variation among forms normally dextral. But there are forms in which the involution is "hyperstrophic," that is to say, the turns of the spire projecting but slightly, the spire, after flattening out gradually, finally becomes re-entrant and transformed into a false umbilicus; at the same time that part which corresponds to the umbilicus of forms with a normal coil projects and constitutes a false spire; the coil thus appears to be sinistral, although the asymmetry remains dextral, and the coil of the operculum (always the opposite to that of the shell) sinistral (e.g. *Lanistes* among Streptoneura, *Limacinae* among Opisthobranchia). The same, *mutatis mutandis*, may occur in sinistral shells.

The problem of the causes of the torsion of the Gastropod body has been much discussed. E. R. Lankester in the ninth edition of this work attributed it to the pressure of the shell and visceral hump towards the right side. He referred also to the nautiloid shell of the larva falling to one side. But these are two distinct processes. In the larva a nautiloid shell is developed which is coiled exogastrically, that is, dorsally, and the pallial cavity is posterior or ventral (fig. 2, C); the larva therefore resembles *Nautilus* in the relations of body and shell. The shell then rotates towards the left side through 180° , so that it becomes ventral or endogastric (fig. 2, D). The pallial cavity, with its organs, is by this torsion moved up the right side of the larva to the dorsal surface, and thus the left organs become right and vice versa. In the subsequent growth of

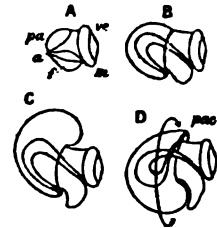

From Lankester's *Treatise on Zoology*.

FIG. 2.—Four stages in the development of a Gastropod showing the process of body torsion. (After Robert.)

- A, Embryo without flexure.
 B, Embryo with ventral flexure of the intestine.
 C, Embryo with ventral flexure and exogastric shell.
 D, Embryo with lateral torsion and an endogastric shell.
 g, Anus.
 f, Foot.
 m, Mouth.
 pa, Mantle.
 pac, Pallial cavity.
 ve, Velum.

FIG. 3.—Sketch of a model designed so as to show the effect of torsion or rotation of the visceral hump in Streptoneurous Gastropoda.

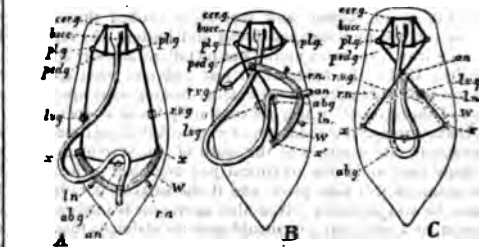

FIG. 3.—Sketch of a model designed so as to show the effect of torsion or rotation of the visceral hump in Streptoneurous Gastropoda.

- A, Unrotated ancestral condition.
 B, Quarter-rotation.
 C, Complete semi-rotation (the limit).
 an, Anus.
 ls, rn, Primarily left nephridium and primarily right nephridium.
 loy, Primarily left (subsequently the sub-intestinal) visceral ganglion.
 rvg, Primarily right (subsequently the sub-intestinal) visceral ganglion.
 cereg, Cerebral ganglion.
 ply, Pleural ganglion.
 pty, Pedal ganglion.
 abg, Abdominal ganglion.
 bucc, Buccal mass.
 W, Wooden arc representing the base-line of the wall of the visceral hump.
 s, s', Fins fastening the elastic cord (representing the visceral nerve loop) to W.

the shell the spire comes to project on the right side, which was originally the left. Neither the rotation of the shell as a whole nor its helicoid spiral coiling is the immediate cause of the torsion of the body in the individual, for the direction of the torsion is indicated in the segmentation of the ovum, in which there is a complete

reversal of the cleavage planes in sinistral as compared with dextral forms. The facts, however, strongly suggest that the original cause of the torsion was the weight of the exogastric shell and visceral hump, which in an animal creeping on its ventral surface necessarily fell over to one side. It is not certain that the projection of the spine to the originally left side of the shell has anything to do with the falling over of the shell to that side. The facts do not support such a suggestion. In the larva there is no projection at the time the torsion takes place. In some forms the coiling disappears in the adult, leaving the shell simply conical as in *Patellidae*, *Fissurellidae*, &c., and in some cases the shell is coiled in one plane, e.g. *Planorbis*. In all these cases the torsion and asymmetry of the body are unaffected.

The characteristic torsion attains its maximum effect among the majority of the Streptoneura. It is followed in some specialized Heteropoda and in the Euthyneura by a torsion in the opposite direction, or detorsion, which brings the anus farther back and untwists the visceral commissure (see Euthyneura, below). This conclusion has shown that the Euthyneura do not represent an archaic form of Gastropoda, but are themselves derived from streptoneurous forms. The difference between the two sub-classes has been shown to be slight; certain of the more archaic Tectibranchia (*Actaeon*) and Pulmonata (*Chilina*) still have the visceral commissure long and not untwisted. The fact that all the Euthyneura are hermaphrodite is not a fundamental difference; several Streptoneura are so, likewise *Valvata*, *Oncidiopsis*, *Marsennia*, *Odosomia*, *Bathysciadium*, *Entoconcha*.

Classification.—The class Gastropoda is subdivided as follows:

Sub-class I. Streptoneura.

Order 1. Aspidobranchia.

- Sub-order 1. Docoglossa.
" 2. Rhipidoglossa.

Order 2. Pectinibranchia.

- Sub-order 1. Taenioglossa.
Tribe 1. Platypoda.
" 2. Heteropoda.
Sub-order 2. Stenoglossa.
Tribe 1. Rachiglossa.
" 2. Toxioglossa.

Sub-class II. Euthyneura.

Order 1. Opisthobranchia.

- Sub-order 1. Tectibranchia.
Tribe 1. Bullomorpha.
" 2. Aplysiomorpha.
" 3. Pleurobranchomorpha.
Sub-order 2. Nudibranchia.
Tribe 1. Tritoniomorpha.
" 2. Doridomorpha.
" 3. Eolidomorpha.
" 4. Elysioromorpha.

Order 2. Pulmonata.

- Sub-order 1. Basommatophora.
" 2. Stylommatophora.
Tribe 1. Holognatha.
" 2. Agnatha.
" 3. Elasmognatha.
" 4. Ditremata.

Sub-Class I.—STREPTONEURA

In this division the torsion of the visceral mass and visceral commissure is at its maximum, the latter being twisted into a figure of eight. The right half of the commissure with its ganglion is supra-intestinal, the left half with its ganglion infra-intestinal. In some cases each pleural ganglion is connected with the opposite branch of the visceral commissure by anastomosis with the pallial nerve, a condition which is called dialyneury; or there may be a direct connective from the pleural ganglion to the visceral ganglion of the opposite side, which is called zygoneury. The head bears only one pair of tentacles. The radular teeth are of several different kinds in each transverse row. The heart is usually posterior to the branchia (proso-branchiate). The sexes are usually separate.

The old division into Zygobranchia and Azygobranchia must be abandoned, for the Azygobranchiate Rhipidoglossa have much greater affinity to the Zygobranchiate *Halitoidae* and *Fissurellidae* than to the Azygobranchia in general. This is shown by the labial commissure and pedal cords of the nervous system, by the opening of the gonad into the right kidney, and by other points. Further, the *Pleurotomaridae* have been discovered to possess two branchiae. The sub-class is now divided into two orders: the Aspidobranchia in which the branchia or ctenidium is bipectinate and attached only at its base, and the Pectinibranchia in which the ctenidium is monopectinate and attached to the mantle throughout its length.

Order 1. ASPIDOBANCHIA.—These are the most primitive Gastropods, retaining to a great degree the original symmetry of the



FIG. 4.—The Common Limpet (*Patella vulgata*) in its shell, seen from the pedal surface. (Lankester.)

- x, y, The median antero-posterior axis.
a, Cephalic tentacle.
b, Plantar surface of the foot.
c, Free edge of the shell.
d, The branchial efferent vessel carrying aerated blood to the auricle, and here interrupting the circle of gill lamellae.
e, Margin of the mantle-skirt.
f, Gill lamellae (not ctenidia, but

- special pallial growths, comparable with those of Pleurophyllidia).
g, The branchial efferent vessel.
h, Factor of the branchial afferent vessel.
i, Interspaces between the muscular bundles of the root of the foot, causing the separate areas seen in fig. 5, c.

organs of the pallial complex, having two kidneys, in some cases two branchiae, and two auricles. The gonad has no accessory organs and except in *Neritidae* no duct, but discharges into the right kidney.

Forms adapted to terrestrial life and to aerial respiration occur in various divisions of Gastropoda, and do not constitute a single homogeneous group. Thus the *Helicoidae*, which are terrestrial, are now placed among the Aspidobranchia. In these there are neither branchia nor osphradium, and the pallial chamber which retains its large opening serves as a lung. Degeneration of the shell occurs in some members of the order. It is largely covered by the mantle in some *Fissurellidae*, is entirely internal in *Papilia* and absent in *Titiscaniidae*.

The common limpet is a specially interesting and abundant example of the more primitive Aspidobranchia. The foot of the limpet is a nearly circular disk of muscular tissue; in front, projecting from and raised above it, are the head and neck (figs. 4, 13). The visceral hump forms a low conical dome above the sub-circular foot, and standing out all round the base of this dome so as completely to overlap the head and foot, is the circular mantle-skirt. The depth of free mantle-skirt is greatest in front, where the head and neck are covered in by it. Upon the surface of the



FIG. 5.—Dorsal surface of the Limpet removed from its shell and deprived of its black pigmented epithelium; the internal organs are seen through the transparent body-wall. (Lankester.)

- c, Muscular bundles forming the root of the foot, and adherent to the shell.
e, Free mantle-skirt. [same.
em, Tentaculiferous margin of the smaller (left) nephridium.
f, Larger (right) nephridium.
g, Pericardium. [cardium.
h, Fibrous septum, behind the pericardium.
i, Liver.
int, Intestine.
int, Anterior area of the mantle-skirt overhanging the head (cephalic hood).
The depth of free mantle-skirt is greatest in front, where the head and neck are covered in by it. Upon the surface of the visceral dome, and extending

to the edge of the free mantle-skirt, in the conical shell. When the shell is taken away (best effected by immersion in hot water) the surface of the visceral dome is found to be covered by a black-coloured epithelium, which may

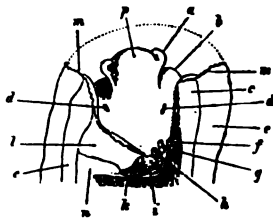

FIG. 6.—Anterior portion of the same Limpet, with the overhanging cephalic hood removed. (Lankester.)

- a, Cephalic tentacle.
b, Foot.
c, Muscular substance forming the root of the foot.
d, The capito-pedal organs of Lankester (= rudimentary ctenidia).
e, Mantle-skirt.
f, Papilla of the larger nephridium.
g, Anus.
h, Papilla of the smaller nephridium.
i, Larger nephridium.
l, Pericardium.
m, Cut edge of the mantle-skirt.
n, Liver.
p, Snout.

right and left renal papillae (discovered by Lankester in 1867) on either side of the anal papilla (fig. 6), but no gills. If a similar examination be made of the allied genus *Fissurella* (fig. 17, d), we find right and left of the two renal apertures a right and left gill-plume or ctenidium, which here as in *Haliotis* and *Plesrotomaria* retain their original paired condition. In *Patella* no such plumes exist, but right and left of the neck are seen a pair of minute oblong yellow bodies (fig. 6, d), which were originally described by Lankester as orifices possibly connected with the evacuation of the generative products. On account of their position they were termed by him the "capito-pedal orifices," being placed near the junction of head and foot. J. W. Spengel has, however, in a most ingenious way shown that these bodies are the representatives of the typical pair of ctenidia, here reduced to a mere rudiment. Near to each rudimentary ctenidium Spengel has discovered an olfactory patch or osphradium (consisting of modified epithelium) and an olfactory nerve-ganglion (fig. 8). It will be remembered that, according to Spengel, the osphradium of mollusca is definitely and intimately related to the gill-plume or ctenidium, being always placed near the

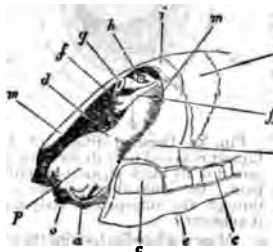

FIG. 7.—The same specimen viewed from the left front, so as to show the sub-anal tract (f) of the larger nephridium, by which it communicates with the pericardium. e, Mouth; other letters as in fig. 6.

the visceral loop of *Haliotis* to the olfactory patch or osphradium, which lies in immediate relation on the right and on the left side to the right and left gill-plumes (ctenidia) respectively. The same diagrams serve to demonstrate the streptoneurous condition of the visceral loop in *Aspidobranchia*.

Thus, then, we find that the limpet possesses a symmetrically disposed pair of ctenidia in a rudimentary condition, and justifies its position among *Aspidobranchia*. At the same time it possesses

a totally distinct series of functional gills, which are not derived from the modification of the typical molluscan ctenidium. These gills are in the form of delicate lamellae (fig. 4, f), which form a series extending completely round the inner face of the depending mantle

and opening through and opening on the right shoulder, so to speak, of the animal into the large anterior region of the sub-pallial space. Close to this the small renal organ (i, mediad) and the larger renal organ (k, to the right and posteriorly) are seen, also the pericardium (l) and a coil of the intestine (int) embedded in the compact liver.

On cutting away the anterior part of the mantle-skirt so as to expose the sub-pallial chamber in the region of the neck, we find the

right and left renal papillae (discovered by Lankester in 1867) on either side of the anal papilla (fig. 6), but no gills. If a similar examination be made of the allied genus *Fissurella* (fig. 17, d), we find right and left of the two renal apertures a right and left gill-plume or ctenidium, which here as in *Haliotis* and *Plesrotomaria* retain their original paired condition. In *Patella* no such plumes exist, but right and left of the neck are seen a pair of minute oblong yellow bodies (fig. 6, d), which were originally described by Lankester as orifices possibly connected with the evacuation of the generative products. On account of their position they were termed by him the "capito-pedal orifices," being placed near the junction of head and foot. J. W. Spengel has, however, in a most ingenious way shown that these bodies are the representatives of the typical pair of ctenidia, here reduced to a mere rudiment. Near to each rudimentary ctenidium Spengel has discovered an olfactory patch or osphradium (consisting of modified epithelium) and an olfactory nerve-ganglion (fig. 8). It will be remembered that, according to Spengel, the osphradium of mollusca is definitely and intimately related to the gill-plume or ctenidium, being always placed near the

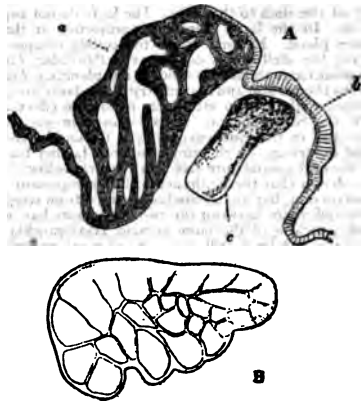

FIG. 8.—A, Section in a plane vertical to the surface of the neck of *Patella* through a, the rudimentary ctenidium (Lankester's organ), and b, the olfactory epithelium (osphradium); c, the olfactory (osphradial) ganglion. (After Spengel.)
B, Surface view of a rudimentary ctenidium of *Patella* excised and viewed as a transparent object. (Lankester.)

skirt. This circlet of gill-lamellae led Cuvier to class the limpets as Cyclobranchiata, and, by erroneous identification of them with the series of metamerically repeated ctenidia of *Chiton*, to associate the latter mollusc with the former. The gill-lamellae of *Patella* are processes of the mantle comparable with the plat-like folds often observed on the roof of the branchial chamber in other *Gastropoda* (e.g. *Buccinum* and *Haliotis*). They are termed pallial gills. The only other molluscs in which they are exactly represented are the curious Opisthobranchs *Phyllidia* and *Pleurophyllidia* (fig. 55). In these, as in *Patella*, the typical ctenidia are aborted, and the branchial function is assumed by close-set lamelliform processes arranged in a series beneath the mantle-skirt on either side of the foot. In fig. 4, d, the large branchial vein of *Patella* bringing blood from the heart is seen; where it crosses the series of lamellae there is a short interval devoid of lamellae.

The heart in *Patella* consists of a single auricle (not two as in *Haliotis* and *Fissurella*) and a ventricle; the former receives the blood from the branchial vein, the latter distributes it through a large aorta which soon leads into irregular blood-lacunae.

The existence of two renal organs in *Patella*, and their relation to the pericardium (a portion of the coelom), is important. Each renal organ is a sac lined with glandular epithelium (ciliated cell, with concretions) communicating with the exterior by its papilla, and by a narrow passage with the pericardium. The connexion with the pericardium of the smaller of the two renal organs was demonstrated by Lankester in 1867, at a time when the fact that the renal organ of the Mollusca, as a rule, opens into the pericardium, and is therefore a typical osphradium, was not known. Subsequent investigations carried on under the direction of the same naturalist have shown that the larger as well as the smaller renal sac is in communication with the pericardium. The walls of the renal sacs are deeply plaited and thrown into ridges. Below the surface these walls are excavated with blood-vessels, so that the sac is practically a series of blood-vessels covered with renal epithelium, and forming

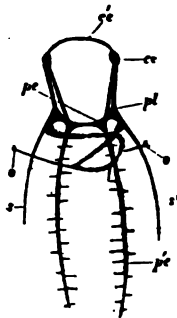
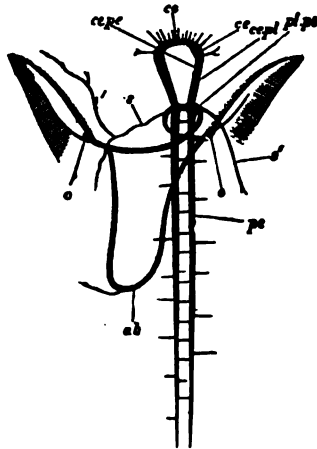

FIG. 9.—Nervous system of *Patella*; the visceral loop is lightly shaded; the buccal ganglia are omitted. (After Spengel.)

- cc, Cerebral ganglia.
c'c, Cerebral commissure.
pl, Pleural ganglion.
pe, Pedal ganglion.
p'e, Pedal nerve.
s, s', Nerves (right and left) to the mantle.
o, Olfactory ganglion, connected by nerve to the streptoneurous visceral loop.

ort within a space communicating with the exterior. The anal sac (remarkably enough, that which is aborted in other



—Nervous system of *Haliotis*; the visceral loop is lightly d; the buccal ganglia are omitted. (After Spengel.)
 s, s', Right and left mantle fused pleural and pedal ganglia.
 ab, Abdominal ganglion or site of right pedal nerve.
 o, o, Right and left olfactory ganglia and osphradia receiving nerve from visceral loop.

ura) extends between the liver and the integument of the lome very widely. It also bends round the liver as shown

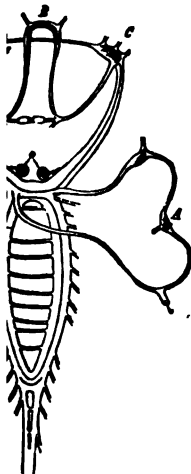

1.—Nervous system of (From Gegenbaur, ring.)
 d, nerve.
 e, nerve.
 f, nerve.
 g, nerve.
 h, nerve.
 i, nerve.
 j, nerve.
 k, nerve.
 l, nerve.
 m, nerve.
 n, nerve.
 o, nerve.
 p, nerve.
 q, nerve.
 r, nerve.
 s, nerve.
 t, nerve.
 u, nerve.
 v, nerve.
 w, nerve.
 x, nerve.
 y, nerve.
 z, nerve.

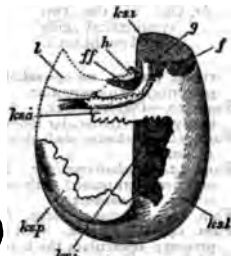

FIG. 12.—Diagram of the two renal organs (nephridia), to show their relation to the rectum and to the pericardium. (Lankester.)
 f, Papilla of the larger nephridium.
 g, Anal papilla with rectum leading from it.
 h, Papilla of the smaller nephridium, which is only represented by dotted outlines.
 i, Pericardium indicated by a dotted outline—at its right side are seen the two renopericardial pores.
 j, The sub-anal tract of the large nephridium given off near its papilla and seen through the unshaded smaller nephridium.
 ks, a, Anterior superior lobe of the large nephridium.
 ks, l, Left lobe of same.
 ks, p, Posterior lobe of same.
 ks, v, Inferior sub-visceral lobe of same.

in fig. 12, and forms a large sac on half of the upper surface of the muscular mass of the foot. Here it lies close upon the genital body (ovary or testis), and in such intimate relationship with it that, when ripe, the gonad bursts into the renal sac, and its products are carried to the exterior by the papilla on the right side of the anus

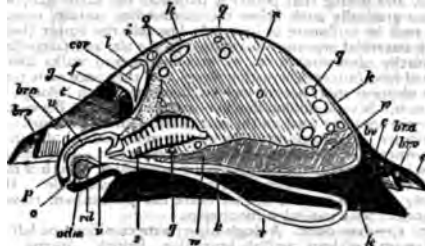

FIG. 13.—Diagram of a vertical antero-postero median section of a limpet. Letters as in fig. 6, 7, with following additions. (Lankester.)
 g, Intestine in transverse section.
 r, Lingual sac (radular sac).
 rd, Radula.
 s, Lamellated stomach.
 l, Salivary gland.
 w, Duct of same.
 v, Buccal cavity.
 br, a, Branchial advent vessel (artery).
 br, v, Branchial efferent vessel (vein).
 bv, Blood-vessel.
 odm, Muscles and cartilage of the odontophore.
 cor, Heart within the pericardium.

(Robin, Dall). This fact led Cuvier erroneously to the belief that a duct existed leading from the gonad to this papilla. The position of the gonad, best seen in the diagrammatic section (fig. 13), is, as in other Aspidobranchia, devoid of a special duct communicating with the exterior. This condition, probably an archaic one, distinguishes the Aspidobranchia from other Gastropoda.

The digestive tract of *Patella* offers some interesting features. The odontophore is powerfully developed; the radular sac is extraordinarily long, lying coiled in a space between the mass of the liver and the muscular foot. The radula has 160 rows of teeth with twelve teeth in each row. Two pairs of salivary ducts, each leading from a salivary gland, open into the buccal chamber. The oesophagus leads into a remarkable stomach, plaited like the manyplices of a sheep, and after this the intestine takes a very large number of turns embedded in the yellow liver, until at last it passes between the two renal sacs to the anal papilla. A curious ridge (spiral ? valve)



FIG. 14.—Vertical section in a plane running right and left through the anterior part of the visceral hump of *Patella* to show the two renal organs and their openings into the pericardium. (J. T. Cunningham.)
 a, Large or external or right renal organ.
 ab, Narrow process of the same running below the intestine and leading by k into the pericardium.
 b, Small or median renal organ.
 c, Pericardium.
 d, Rectum.
 e, Liver.
 f, Manyplices.
 g, Epithelium of the dorsal surface.
 h, Renal epithelium lining the renal sacs.
 i, Aperture connecting the small sac with the pericardium.
 k, Aperture connecting the large sac with the pericardium.

which secretes a slimy cord is found upon the inner wall of the intestine. The general structure of the Molluscan intestine has not been sufficiently investigated to render any comparison of this structure of *Patella* with that of other Mollusca possible. The eyes of the limpet deserve mention as examples of the most primitive kind of eye in the Molluscan series. They are found one on each cephalic tentacle, and are simply minute open pits or depressions of the epidermis, the epidermic cells lining them being pigmented and connected with nerves (compare fig. 14, art. CEPHALOPODA).

The limpet breeds upon the southern English coast in the early part of April, but its development has not been followed. It has simply been traced as far as the formation of a diblastula which acquires a ciliated band, and becomes a nearly spherical trochosphere. It is probable that the limpet takes several years to attain full growth, and during that period it frequents the same spot, which becomes gradually sunk below the surrounding surface, especially if the rock be carbonate of lime. At low tide the limpet (being a strictly intertidal organism) is exposed to the air, and (according to trustworthy observers) quits its attachment and walks away in search of food (minute encrusting algae), and then once more returns to the identical spot, not an inch in diameter, which belongs, as it were, to it. Several million limpets—twelve million in Berwickshire alone—are annually used on the east coast of Britain as bait.

Sub-order 1. *Docoglossa*.—Nervous system without dialynurey. Eyes are open invaginations without crystalline lens. Two ophradia present but no hypobranchial glands nor operculum. Teeth of radula beam-like, and at most three marginal teeth on each side. Heart has only a single auricle, neither heart nor pericardium traversed by rectum. Shell conical without spine.

Fam. 1.—*Aemoneidae*. A single biplicate ctenidium on left side.

Aemonea, without pallial branchiae. British. *Scurria*, with pallial branchiae in a circle beneath the mantle.

Fam. 2.—*Tryblitidae*. Muscle scar divided into numerous impressions. *Tryblidium*, Silurian.

Fam. 3.—*Patellidae*. No ctenidia but pallial branchiae in a circle between mantle and foot. *Patella*, pallial branchiae forming a complete circle, no epipodial tentacles, British. *Ancistro-mesus*, radula with median central tooth. *Nacella*, epipodial tentacles present. *Helcion*, circlet of branchiae interrupted anteriorly, British.

Fam. 4.—*Lepetidae*. Neither ctenidia nor pallial branchiae.

Lepeta, without eyes. *Ptidium*. *Propitidium*.

Fam. 5.—*Bathysciadidae*. Hermaphrodite; head with appendage on right side; radula without central tooth. *Bathysciadium*, abyssal.

Sub-order 2. *Rhipidoglossa*.—Aspidobranchia with a pallio-visceral anastomosis (dialynureous); eye-vesicle closed, with crystalline lens; ctenidia, ophradia and hypobranchial glands paired or single. Radula with very numerous marginal teeth arranged like the rays of a fan. Heart with two auricles; ventricle traversed by the rectum, except in the *Helicinidae*. An epipodial ridge on each side of the foot and cephalic expansions between the tentacles often present.

Fam. 1.—*Pleurotariidae*. Shell spiral; mantle and shell with an anterior fissure; two ctenidia; a horny operculum. *Pleurotaria*, epipodium without tentacles. Genus includes several hundred extinct species ranging from the Silurian to the Tertiary. Five living species from the Antilles, Japan and the Moluccas. Moluccan species is 19 cm. in height.

Fam. 2.—*Bellerophonidae*. 300 species, all fossil, from Cambrian to Trias.

Fam. 3.—*Euomphalidae*. Also extinct, from Cambrian to Cretaceous.

Fam. 4.—*Haliotidae*. Spire of shell much reduced; two biplicate ctenidia, the right being the smaller; no operculum. *Haliotis*.

Fam. 5.—*Velosinellidae*, an extinct family from the Eocene.

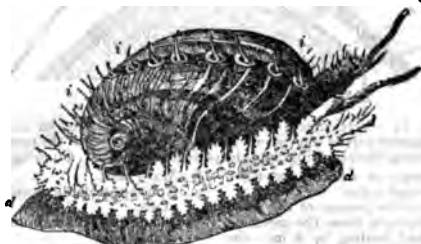

FIG. 15.—*Haliotis listuberculata*. *d*, Foot; *i*, tentacular processes of the mantle. (From Owen, after Cuvier.)

Fam. 6.—*Fissurellidae*. Shell conical; slit or hole in anterior part of mantle; two symmetrical ctenidia; no operculum. *Emarginula*, mantle and shell with a slit, British. *Scutum*, mantle split anteriorly and reflected over shell, which has no slit. *Puncturella*, mantle and shell with a foramen in front of the apex, British. *Fissurella*, mantle and shell perforated at apex, British.

Fam. 7.—*Cocculinidae*. Shell conical, symmetrical, without slit or perforation. *Cocculina*, abyssal.

Fam. 8.—*Trochidae*. Shell spirally coiled; a single ctenidium; eyes perforated; a horny operculum; lobes between the

tentacles. *Trochus*, shell umbilicated, spire pointed and prominent, British. *Monodonta*, no jaws, spire not prominent, no umbilicus, columella toothed. *Gibbula*, with jaws, three pairs of epipodial cirri without pigment spots at their bases, British. *Margarita*, five to seven pairs of epipodial cirri with a pigment spot at base of each.

Fam. 9.—*Stomatellidae*. Spire of shell much reduced; a single ctenidium. *Stomatella*, foot truncated posteriorly, an oper-

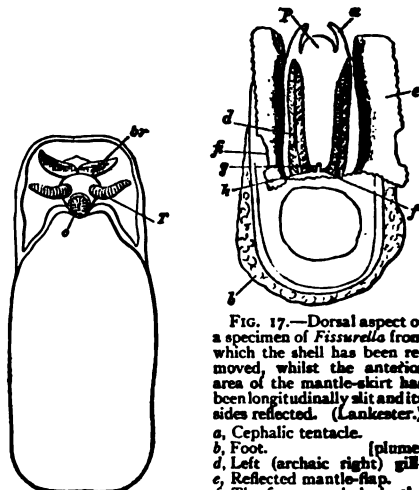

FIG. 16.—*Scutum*, seen from the pedal surface. (Lankester.)

a, Cephalic tentacle.
b, Foot.
d, Left (archaic right) gill.
e, Reflected mantle-flap.
f, The fissure or hole in the mantle-flap traversed by the longitudinal incision.
g, Right (archaic left) nephridium's aperture.
h, Anus.
i, Left (archaic right) aperture of nephridium.
p, Snout.

culum present, no epipodial tentacles. *Gemma*, foot elongated posteriorly, no operculum.

Fam. 10.—*Delphinulidae*. Shell spirally coiled; operculum horny; intertentacular lobes absent. *Delphinula*.

Fam. 11.—*Liotidae*, shell globular, margin of aperture thickened. *Liotia*.

Fam. 12.—*Cyclotrematidae*. Shell flattened, umbilicated; foot anteriorly truncated with angles produced into lobes. *Cyclotrema*. *Teinostoma*.

Fam. 13.—*Trochonematidae*. All extinct, Cambrian to Cretaceous.

Fam. 14.—*Turbinidae*. Shell spirally coiled; epipodial tentacles present; operculum thick and calcareous. *Turbo*. *Australium*. *Molleria*. *Cyclonema*.

Fam. 15.—*Phasianellidae*. Shell not nacreous, without umbilicus, with prominent spire and polished surface. *Phasianella*.

Fam. 16.—*Umbonidae*. Shell flattened, not umbilicated, generally smooth; operculum horny. *Umbonium*. *Isanda*.

Fam. 17.—*Neritopsidae*. Shell semi-globular, with short spire; operculum calcareous, not spiral. *Neritopsis*. *Naticopsis*, extinct.

Fam. 18.—*Maclureiidae*. Extinct, Cambrian and Silurian.

Fam. 19.—*Neritidae*. Shell with very low spire, without umbilicus, internal partitions frequently absorbed; a single ctenidium; a cephalic penis present. *Nerita*, marine. *Neritina*, freshwater, British. *Separia*, shell boat-shaped.

Fam. 20.—*Tiisacnidae*. Without shell and operculum, but with pallial cavity and ctenidium. *Tiisacna*, Pacific.

Fam. 21.—*Helicinidae*. No ctenidium, but a pulmonary cavity; heart with a single auricle, not traversed by the rectum. *Helicina*. *Eutrechalcia*. *Stoastoma*. *Bowseria*.

Fam. 22.—*Hydrocenidae*. No ctenidium, but a pulmonary cavity; operculum with an apophysis. *Hydrocena*, Dalmatia.

Fam. 23.—*Proserpinidae*. No operculum. *Proserpine*, Central America.

Order 2. *PECTINIBRANCHIA*.—In this order there is no longer any trace of bilateral symmetry in the circulatory, respiratory and excretory organs, the topographically right half of the pallial complex having completely disappeared, except the right kidney, which is

d by the genital duct. There is usually a penis in the male. The alimentary canal is monoplicate and attached to the mantle along

movement. The "introvert" in these Gastropods is not the pharynx as in the Chaetopod worms, but a pre-oral structure, its apical limit being formed by the true lips and jaws, whilst the apical limit of the Chaetopod's introvert is formed by the jaws placed at the junction of pharynx and oesophagus, so that the Chaetopod's introvert is part of the stomodaeum or fore-gut, whilst that of the Gastropod is external to the alimentary canal altogether, being in front of the mouth, not behind it, as is the Chaetopod's. Further, the Gastropod's introvert is pleurembolic (and therefore acrebolic), and is limited both in eversion and in introversion; it cannot be completely everted owing to the muscular bands (fig. 19, G), nor can it be fully introverted owing to the bands (fig. 19, F) which tie the axial pharynx to the adjacent wall of the apical part of the introvert. As in all such intro- and e-versible organs, eversion of the Gastropod proboscis is effected by pressure communicated by the muscular body-wall to the liquid contents (blood) of the body-space, accompanied by the relaxation of the muscles which directly pull upon either the sides or the apex of the tubular organ. The inversion of the proboscis is effected directly by the contraction of these muscles. In various members of the Pectinibranchia the mouth-bearing cylinder is introvertible (i.e. is a proboscis)—with rare exceptions these forms have a siphonate

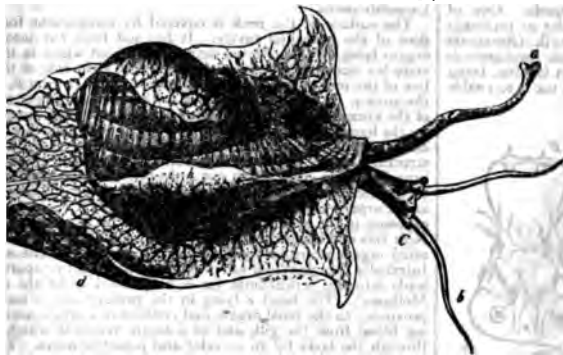

FIG. 18.—Animal and shell of *Pyrus laevigata*. (From Owen.)

ntacles.
The letter placed near the right eye.

d, The foot, expanded as in crawling.
b, The mantle-skirt reflected over the sides of the shell.

length, except in *Adeorbis* and *Valvata*; in the latter alone inate. There is a single well-developed, often pectinate n. The eye is always a closed vesicle, and the internal extensive. In the radula there is a single central tooth or

ner classification into *Holochlamyda*, *Pneumochlamyda* and *nochlamyda* has been abandoned, as it was founded on characters not always indicative of true affinities. The now divided into two sub-orders: the *Taenioglossa*, in which there are three teeth on each side of the median tooth of the Stenoglossa, in which there is only one tooth on each median tooth. In the latter a pallial siphon, a well-proboscis and an unpaired oesophageal gland are always the former they are usually absent. The siphon is an ally tubular outgrowth of the mantle margin on the left lined in a corresponding outgrowth of the edge of the mantle, and serving to conduct water to the respiratory cavity. The "proboscis" appears to be in the condition of a simple rostrum (having the mouth cavity) by the process of incomplete introversion of that rostrum. There is no reason in the actual significance of the term "proboscis" should be applied to an alter-overeversible and e-versible tube connected with an animal's yet such is a very customary use of the term. The introvert may be completely closed, as in the "proboscis" of worms, or it may have a passage in it leading into a pleurophagus, as in the present case, and in the case of the pharynx of the predatory Chaetopod worms. The diagrams introduced (fig. 19) are intended to show certain distinctions which obtain amongst the various "introvert- and e-versible tubes so frequently met with in animals opposing the tube to be completely introverted and to its eversion, we then find that eversion may take place, forward movement of the side of the tube near its apex; as in the proboscis of the Nemertine worms, the pharynx and the eye-tentacle of Gastropods, or by a forward of the inverted apex of the tube, as in the proboscis of coel Planarians, and in that of Gastropods here under n. The former case we call "pleurebolic" (fig. 19, I, K), the latter "acrebolic" tubes or introverts (fig. 19, C). It is clear that, if we start from the condition of a tube and watch the process of introversion, we have the pleurebolic variety is introverted by the apex sinking inwards; it may be called acrebolic, whilst the acrebolic tubes are pleurebolic. Further, it is clear that the process either of introversion or of eversion may be arrested at any point, by the development of ecting the wall of the introverted tube with the wall of or with an axial structure such as the oesophagus; on and, the range of movement of the tubular introvert may be arrested or complete. The acrebolic proboscis or frontal of the Nemertine worms has a complete range. So has the pharynx of Chaetopods, if we consider the organ as ter-that point where the jaws are placed and the oesophagus. So too the acrebolic eye-tentacle of the snail has a range of movement, and also the pleurebolic proboscis of coel prostoma. The introverted rostrum of the Pectinibranchia presents in contrast to these a limited range of

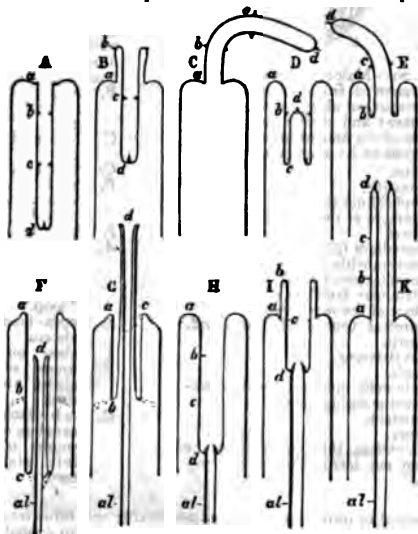

FIG. 19.—Diagrams explanatory of the nature of so-called proboscides or "introverts." (Lankester.)

- A, Simple introvert completely introverted.
- B, The same, partially everted by eversion of the sides, as in the Nemertine proboscis and Gastropod eye-tentacle = pleurebolic.
- C, The same, fully everted.
- D, E, A similar simple introvert in course of eversion by the forward movement, not of its sides, but of its apex, as in the proboscidean *Rhabdocoels* = acrebolic.
- F, Acrebolic (=pleurebolic) introvert, formed by the snout of the probosciferous Gastropod. *al*, alimentary canal; *d*, the true mouth. The introvert is not a simple one with complete range both in eversion and introversion, but is arrested in introversion by the fibrous bands at *c*, and similarly in eversion by the fibrous bands at *b*.
- G, The acrebolic snout of a probosciferous Gastropod, arrested short of complete eversion by the fibrous band *b*.
- H, The acrebolic (=pleurebolic) pharynx of a Chaetopod fully introverted. *al*, alimentary canal; at *d*, the jaws; at *a*, the mouth; therefore *a* to *d* is stomodaeum, whereas in the Gastropod (F) *a* to *d* is inverted body-surface.
- I, Partial eversion of H.
- K, Complete eversion of H.

mantle-skirt. On the other hand, many which have a siphonate mantle-skirt are not provided with an introvertible mouth-bearing

cylinder, but have a simple non-introvertible rostrum, as it has been termed, which is also the condition presented by the mouth-bearing region in nearly all other Gastropoda. One of the best examples of the introvertible mouth-cylinder or proboscis which can be found is that of the common whelk (*Buccinum undatum*) and its immediate allies. In fig. 23 the proboscis is seen in an everted state; it is only so carried when feeding, being withdrawn when the animal is at rest. Probably its use is to enable



FIG. 20.—Male of *Littorina littoralis*, Lin., removed from its shell; the mantle-skirt cut along its right line of attachment and thrown over to the left side of the animal so as to expose the organs on its inner face.

- a, Anus.
i, Intestine.
r, Nephridium (kidney).
r', Aperture of the nephridium.
c, Heart.
br, Ctenidium (gill-plume).
pbr, Parabranchia (= the osphradium or olfactory patch).
s, Glandular lamellae of the inner face of the mantle-skirt.
y, Adrectal (purpuriparous) gland.
t, Testis.
v, Vas deferens.
p, Penis.
mc, Columella muscle (muscular process grasping the shell).
v, Stomach.
l, Liver.

N.B.—Note the simple snout or rostrum not introverted as a "proboscis."

the animal to introduce its rasping and licking apparatus into very narrow apertures for the purposes of feeding, e.g. into a small hole bored in the shell of another mollusc.

The very large assemblage of forms coming under this order comprises the most highly developed predaceous sea-snails, numerous vegetarian species, a considerable number of freshwater and some terrestrial forms. The partial dissection of a male specimen of the common periwinkle, *Littorina littoralis*, drawn in fig. 20, will serve to exhibit the disposition of viscera which prevails in the group. The branchial chamber formed by the mantle-skirt overhanging the head has been exposed by cutting along a line extending backward from the letters *wd* to the base of the columella muscle *mc*, and the whole roof of the chamber thus detached from the right side of the animal's neck has been thrown over to the left, showing the organs which lie upon the roof. No opening into the body-cavity has been made; the organs which lie in the coiled visceral hump *shw* through its transparent walls. The head is seen in front resting on the foot and carrying a median non-retractile snout or rostrum, and a pair of cephalic tentacles at the base of each of which is an eye. In many Gastropoda the eyes are not thus sessile but raised upon special eye-tentacles (figs. 25, 56). To the right of the head is seen the muscular penis *p*, close to the termination of the vas deferens (spermatid duct) *vd*. The testis *t* occupies a median position in the coiled visceral mass. Behind the penis on the same side is the hook-like columella muscle, a development of the retractor muscle of the foot, which clings to the spiral column or columella of

the shell (see fig. 33). This columella muscle is the same thing as the muscles adhering to the shell in *Patella*, and the posterior adductor of Lamellibranchs.

The surface of the neck is covered by integument forming the floor of the branchial cavity. It has not been cut into. Of the organs lying on the reflected mantle-skirt, that which in the natural state lay nearest to the vas deferens on the right side of the median line of the roof of the branchial chamber is the rectum *r'*, ending in the anus *a*. It can be traced back to the intestine *i* near the surface of the visceral hump, and it is found that the apex of the coil formed by the hump is occupied by the liver *l* and the stomach *v*. Pharynx and oesophagus are concealed in the head. The enlarged glandular structure of the walls of the rectum is frequent in the Pectinibranchia, as is also though not universal the gland marked *y*, next to the rectum. It is the adrectal gland, and in the genera *Murex* and *Purpura* secretes a colourless liquid which turns purple upon exposure to the atmosphere, and was used by the ancients as a dye. Near this and less advanced into the branchial chamber is the single renal organ or nephridium *r* with its opening to the exterior *r'*. Internally this glandular sac presents a second slit or aperture which leads into the pericardium (as is now found to be the case in all Mollusca). The heart *c* lying in the pericardium is seen in close proximity to the renal organ, and consists of a single auricle receiving blood from the gill, and of a single ventricle which pumps it through the body by an anterior and posterior aorta. The surface *x* of the mantle between the rectum and the gill-plume is thrown into folds which in many sea-snails (whelks or *Buccinidae*, &c.) are very strongly developed. The whole of this surface appears to be active in the secretion of a mucous-like substance. The single gill-plume *br* lies to the left of the median line in natural position. It corresponds to the right of the two primitive ctenidia in the unadvanced archaic condition of the molluscan body, and does not project freely into the branchial cavity, but its axis is attached (by concrescence) to the mantle-skirt (roof of the branchial chamber). It is rare for the gill-plume of a Pectinibranch Gastropod to stand out freely as a plume, but occasionally this more archaic condition is exhibited as in *Valvata* (fig. 30). Next beyond (to the left of) the gill-plume we find the so-called parabranchia, which is here simple, but sometimes lamellated as in *Purpura* (fig. 22). This organ has, without reason, been supposed to represent the second ctenidium of the typical mollusc, which it cannot do on account of its position. It should be to the right of the anus were this the case. Spengel showed that the parabranchia of Gastropods is the typical olfactory organ or osphradium in a highly developed condition. The minute structure of the epithelium which clothes it, as well as the origin of the nerve which is distributed to the parabranchia, proves it to be the same organ which is found universally in molluscs at the base of each gill-plume, and tests the indrawn current of water by the sense of smell. The nerve to this organ is given off from the superior (original right, see fig. 3) visceral ganglion.

The figures which are given here of various Pectinibranchia are in most cases sufficiently explained by the references attached to them. As an excellent general type of the nervous system, attention may be directed to that of *Paludina* drawn in fig. 21. On the whole the ganglia are strongly individualized in the Pectinibranchia, nerve-cell tissue being concentrated in the ganglia and absent from the cords. At the same time, the junction of the visceral loop above the intestine prevents in all Streptoneura the shortening of the visceral loop, and it is rare to find a fusion of the visceral ganglia with either pleural, pedal or cerebral—a fusion which can and does take place where the visceral loop is not above but below the intestine, e.g. in the *Euthyneura* (fig. 48), Cephalopoda and Lamellibranchia. As contrasted with the Aspidobranchia, we find that in the Pectinibranchia the pedal nerves are distinctly nerves given off from the pedal ganglia, rather than cord-like nerve-tracts containing both nerve-cells or ganglionic elements and nerve-fibres. Yet in some Pectinibranchia (*Paludina*) a ladder-like arrangement of the two pedal nerves and their lateral branches has been detected. The histology of the nervous system of Mollusca has yet to be seriously inquired into.

The alimentary canal of the Pectinibranchia presents little diversity of character, except in so far as the buccal region is concerned. Salivary glands are present, and in some carnivorous forms (*Delium*) these secrete free sulphuric acid (as much as 2% is present in the secretion), which assists the animal in boring holes by means of its



FIG. 21.—Nervous system of *Paludina* as a type of the streptoneurous condition. (From Gegenbaur, after Jhering.)
B, Buccal (suboesophageal) ganglion.
C, Cerebral ganglion.
Co, Pleural ganglion.
P, Pedal ganglion with otocyst attached.
p, Pedal nerve.
A, Abdominal ganglion at the extremity of the twisted visceral "loop."
sp, Supra-intestinal visceral ganglion on the course of the right visceral cord.
sb, Sub-intestinal ganglion on the course of the left visceral cord.



FIG. 22.—Female of *Purpura lapillus* removed from its shell; the mantle-skirt cut along its left line of attachment and thrown over to the right side of the animal so as to expose the organs on its inner face.

- a, Anus.
vg, Vagina.
gp, Adrectal purpuriparous gland.
r', Aperture of the nephridium (kidney).
br, Ctenidium (branchial plume).
br', Parabranchia (= the comb-like osphradium or olfactory organ).

rasping tongue through the shells of other mollusca upon which it preys. A crop-like dilatation of the gut and a recurved intestine, embedded in the compact yellowish-brown liver, the ducts of which open into it, form the rest of the digestive tract and occupy a large bulk of the visceral hump. The buccal region presents a pair of shelly jaws placed laterally upon the lips, and a wide range of variation in the form of the denticles of the lingual ribbon or radula.

Well-developed glandular invaginations occur in different positions on the foot in Pectinibranchia. The most important of these opens by the ventral pedal pore, situated in the median line in the anterior half of the foot. This organ is probably homologous with the byssogenous gland of Lamellibranchia. The aperture, which was formerly supposed to be an aquiferous pore, leads into an extensive and often ramified cavity surrounded by glandular tubules. The gland has been found in both sub-orders of the Pectinibranchia, in *Cyclostoma* and *Cypraea* among the Taenioglossa, in *Hemifusus*, *Cassis*, *Nassa*, *Murex*, *Fasciolaridae*, *Turbinellidae*, *Olividae*, *Margarinellidae* and *Conidae* among the Stenoglossa. It was discovered by J. T. Cunningham that in *Buccinum* the egg-capsules are formed by this pedal gland and not by any accessory organ of the generative system. Such horny egg-capsules doubtless have the same origin in all other species in which they occur, e.g. *Fusus*, *Pyrrula*, *Purpura*, *Murex*, *Nassa*, *Trochus*, *Voluta*, &c. The float of the pelagic *Janthina*, to which the egg-capsules are attached, probably is also formed by the secretion of the pedal gland.

Other glands opening on or near the foot are. (1) The supra-pedal gland opening in the middle line between the snout and the anterior border of the foot. It is most commonly found in sessile

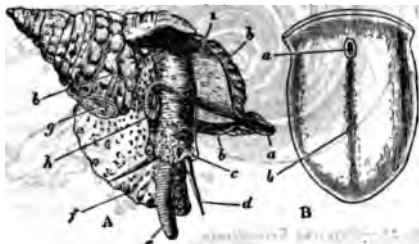

FIG. 23.—A, *Triton variegatum*, to show the proboscis or buccal introvert (e) in a state of eversion.

- a, Siphonal notch of the shell occupied by the siphonal fold of the mantle-skirt (Siphonochlamyda).
 b, Edge of the mantle-skirt resting on the shell.
 c, Cephalic eye.
 d, Cephalic tentacle.
 e, Everted buccal introvert (proboscis).
 f, Foot.
 g, Operculum.
 h, Penis.
 i, Under surface of the mantle-skirt forming the roof of the sub-pallial chamber.

B, Sole of the foot of *Pyrrula tuba*, to show a, the pore usually said to be "aquiferous" but probably the orifice of a gland; b, median line of foot.

forms and in terrestrial genera such as *Cyclostoma*; (2) the anterior pedal gland opening into the anterior groove of the foot, generally present in aquatic species; (3) dorsal posterior mucous glands in certain *Cyclostomatidae*.

The foot of the Pectinibranchia, unlike the simple muscular disk of the Isopleura and Aspidobranchia, is very often divided into lobes, a fore, middle and hind lobe (pro-, meso- and meta-podium, see figs. 24 and 25). Very usually, but not universally, the metapodium carries an operculum. The division of the foot into lobes is a simple case of that much greater elaboration or breaking up into processes and regions which it undergoes in the class Cephalopoda. Even among some Gastropoda (viz. the Opisthobranchia) we find the lobation of the foot still further carried out by the development of lateral lobes, the parapodia, whilst there are many Pectinibranchia, on the other hand, in which the foot has a simple oblong form without any trace of lobes.

The development of the Pectinibranchia has been followed in several examples, e.g. *Paludina*, *Purpura*, *Nassa*, *Vermetus*, *Neritina*. As in other Molluscan groups, we find a wide variation in the early process of the formation of the first embryonic cells, and their arrangement as a diblastula, dependent on the greater or less amount of food-yolk which is present in the egg-cell when it commences its embryonic changes. In fig. 26 the early stages of *Paludina vivipara* are represented. There is but very little food-material in the egg of this Pectinibranch, and consequently the diblastula forms by invagination; the blastopore or orifice of invagination coincides with the anus, and never closes entirely. A well-marked trochosphere is formed by the development of an equatorial ciliated band; and subsequently, by the disproportionate growth of the lower hemisphere, the trochosphere becomes a veliger. The primitive

shell-sac or shell-gland is well marked at this stage, and the pharynx is seen as a new ingrowth (the stomodaeum), about to fuse with and open into the primitively invaginated arch-enteron (fig. 26. F).

In other Pectinibranchia (and such variations are representative for all Mollusca, and not characteristic only of Pectinibranchia) we find that there is a very unequal division of the egg-cell at the commencement of embryonic development, as in *Nassa*. Consequently



FIG. 24.—Animal and shell of *Phorus exultus*.

- a, Snout (not introversible). d, Pro- and meso-podium; to the right of this is seen the metapodium bearing the sculptured operculum.
 b, Cephalic tentacles.
 c, Right eye.

there is, strictly speaking, no invagination (emboly), but an overgrowth (epiboly) of the smaller cells to enclose the larger. The general features of this process and of the relation of the blastopore to mouth and anus have been explained in treating of the development of Mollusca generally. In such cases the blastopore may entirely close, and both mouth and anus develop as new ingrowths (stomodaeum and proctodaeum), whilst, according to the observations of N. Bobretzky, the closed blastopore may coincide in position with the mouth in some instances (*Nassa*, &c.), instead of with the anus. But in these epibolic forms, just as in the embolic *Paludina*, the embryo proceeds to develop its ciliated band and shell-gland, passing through the earlier condition of a trochosphere to that of the veliger. In the veliger stage many Pectinibranchia (*Purpura*, *Nassa*, &c.) exhibit, in the dorsal region behind the head, a contractile area of the body-wall. This acts as a larval heart, but ceases to pulsate after a time. Similar rhythmically contractile

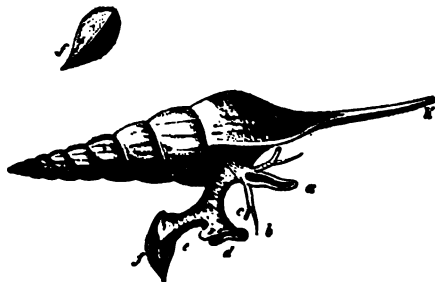

FIG. 25.—Animal and shell of *Rostellaria rectirostris*. (From Owen.)

- a, Snout or rostrum. f, Operculum.
 b, Cephalic tentacle. h, Prolonged siphonal notch of the shell occupied by the siphon, or trough-like process of the mantle-skirt.
 c, Eye.
 d, Propodium and mesopodium.
 e, Metapodium.

areas are found on the foot of the embryo Pulmonate *Limax* and on the yolk-sac (distended foot-surface) of the Cephalopod *Loligo*. The pre-conchylian invagination or shell-gland is formed in the embryo behind the velum, on the surface opposite the blastopore. It is surrounded by a ridge of cells which gradually extends over the visceral sac and secretes the shell. In forms which are naked in the adult state, the shell falls off soon after the reduction of the velum, but in *Cerata*, *Runcina* and *Vaginula* the shell-gland and shell are not developed, and the young animal when hatched has already the naked form of the adult.

One further feature of the development of the Pectinibranchia deserves special mention. Many Gastropoda deposit their eggs, after fertilization, enclosed in capsules; others, as *Paludina*, are viviparous; others, again, as the Zygobranchia, agree with the Lamelibranch Conchifera (the bivalves) in having simple exits for the ova without glandular walls, and therefore discharge their eggs unenclosed in capsules freely into the sea-water; such unencapsuled eggs are merely enclosed each in its own delicate chorion. When

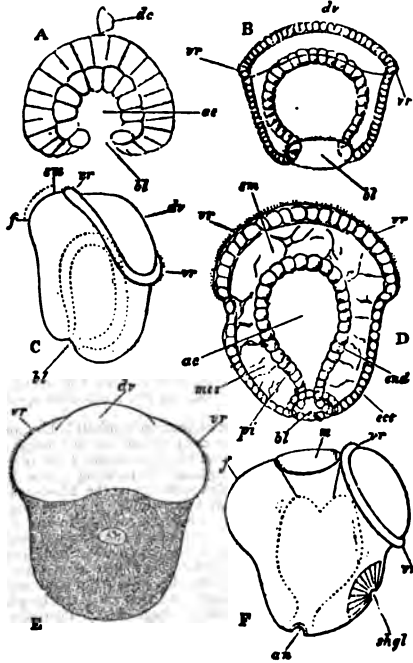

FIG. 26.—Development of the River-Snail, *Paludina vivipara*. (After Lankester, 17.)

- dc, Directive corpuscle (outcast cell).
 ae, Arch-enteron or cavity lined by the enteric cell-layer or endoderm.
 vr, Blastopore.
 bl, Velum or circle of ciliated cells.
 ds, Velar area or cephalic dome.
 sm, Site of the as yet unformed mouth.
 f, Foot.
 mes, Rudiments of the skeleto-trophic tissues.
 pi, The pedicle of invagination, the future rectum.
 shgl, The primitive shell-sac or shell-gland.
 m, Mouth.
 an, Anus.

- A, Diblastula phase (optical section).
 B, The diblastula has become a trochosphere by the development of the ciliated ring vr (optical section).
 C, Side view of the trochosphere with commencing formation of the foot.
 D, Further advanced trochosphere (optical section).
 E, The trochosphere passing to the veliger stage, dorsal view showing the formation of the primitive shell-sac.
 F, Side view of the same, showing foot, shell-sac (shgl), velum (vr), mouth and anus.

N.B.—In this development the blastopore is not elongated; it persists as the anus. The mouth and stomodaeum form independently of the blastopore.

egg-capsules are formed they are often of large size, have tough walls, and in each capsule are several eggs floating in a viscid fluid. In some cases all the eggs in a capsule develop; in other cases one egg only in a capsule (*Neritina*), or a small proportion (*Parpura*, *Buccinum*), advance in development; the rest are arrested either after the first process of cell-division (cleavage) or before that process. The arrested embryos or eggs are then swallowed and digested by those in the same capsule which have advanced in development. This is clearly the same process in essence as that of the formation of a vitellogenic gland from part of the primitive ovary, or of the feeding of an ovarian egg by the absorption of neighbouring potential

eggs; but here the period at which the sacrifice of one egg to another takes place is somewhat late. What it is that determines the arrest of some eggs and the progressive development of others in the same capsule is at present unknown.

In the tribe of Pectinibranchia called Heteropoda the foot takes the form of a swimming organ. The nervous system and sense organs are highly developed. The odontophore also is remarkably developed, its lateral teeth being mobile, and it serves as an efficient organ for attacking the other pelagic forms on which the Heteropoda prey. The sexes are distinct, as in all Streptoneura; and genital ducts and accessory glands and pouches are present, as in all Pectinibranchia. The Heteropoda exhibit a series of modifications in the form and proportions of the visceral mass and foot, leading from a condition readily comparable with that of a typical Pectinibranch such as *Rostellaria*, with the three regions of the foot strongly marked and a coiled visceral hump of the usual proportions, up to a condition in which the whole body is of a tapering cylindrical shape, the foot a plate-like vertical fin, and the visceral hump almost completely atrophied. Three steps of this modification may be

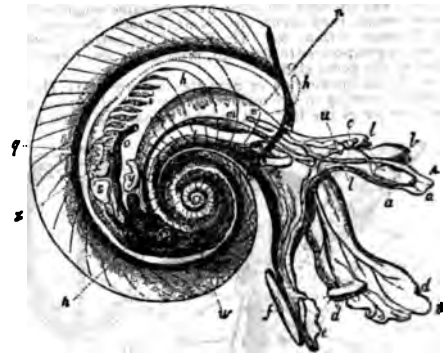

FIG. 27.—*Oxygyrus Keradrensis*.

(From Owen.)

- a, Mouth and odontophore.
 b, Cephalic tentacles.
 c, Eye.
 d, Propodium (B) and mesopodium.
 e, Metapodium.
 f, Operculum.
 h, Mantle-chamber.
 s, Ctenidium (gill-plume).
 k, Retractor muscle of foot.
 l, Optic tentacle.
 m, Stomach.
 n, Dorsal surface overhurling the mantle-skirt; the letter is close to the salivary gland.
 o, Rectum and anus.
 p, Liver.
 q, Renal organ (nephridium).
 s, Ventricle.
 u, The otocyst attached to the cerebral ganglion.
 w, Testis.
 x, Auricle of the heart.
 y, Vesicle on genital duct.
 z, Penis.

distinguished as three families:—*Atlantidae*, *Carinariidae* and *Pterotracheidae*. They are true Pectinibranchia which have taken to a pelagic life, and the peculiarities of structure which they exhibit are strictly adaptations consequent upon their changed mode of life. Such adaptations are the transparency and colourlessness of the tissues, and the modifications of the foot, which still shows in *Atlanta* the form common in Pectinibranchia (compare fig. 27 and fig. 24). The cylindrical body of *Pterotrachea* is paralleled by the slug-like forms of *Euthyneura*. J. W. Spengel has shown that the visceral loop of the Heteropoda is streptoneurous. Special to the Heteropoda is the high elaboration of the lingual ribbon, and, as an agreement with some of the opisthobranchiate *Euthyneura*, but as a difference from the Pectinibranchia, we find the otocysts closely attached to the cerebral ganglia. This is, however, less of a difference than it was at one time supposed to be, for it has been shown by H. Lacaze-Duthiers, and also by F. Leydig, that the otocysts of Pectinibranchia even when lying close upon the pedal ganglion (as in fig. 21) yet receive their special nerve (which can sometimes be readily isolated) from the cerebral ganglion (see fig. 11). Accordingly the difference is one of position of the otocyst and not of its nerve-supply. The Heteropoda are further remarkable for the high development of their cephalic eyes, and for the typical character of their osphradium (Spengel's olfactory organ). This is a groove, the edges of which are raised and ciliated, lying near the branchial plume in the genera which possess that organ, whilst in *Firola*, which has no branchial plume, the osphradium occupies a corresponding position. Beneath the ciliated groove is placed an elongated ganglion (olfactory ganglion) connected by a nerve to the supra-intestinal (therefore the primitively dextral) ganglion of the long

visceral nerve-loop, the strands of which cross one another—this being characteristic of Streptoneura (Spengel).

The Heteropoda belong to the "pelagic fauna" occurring near the surface in the Mediterranean and great oceans in company with the Pteropoda, the Siphonophorous Hydrozoa, Salpae, Leptocephali, and other specially-modified transparent swimming representatives

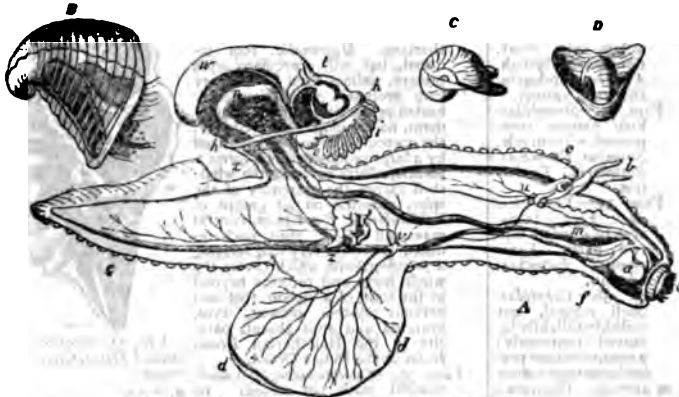

FIG. 28.—*Carinaria mediterranea*. (From Owen.)

- A. The animal. B. The shell removed. C, D. Two views of the shell of *Cardipoda*.
- a. Mouth and odontophore.
 - b. Cephalic tentacles.
 - c. Eye.
 - d. The fin-like mesopodium.
 - e. Its sucker.
 - f. Metapodium.
 - g. Salivary glands.
 - h. Border of the mantle-flap.
 - i. Ctenidium (gill-plume).
 - m. Stomach.
 - n. Intestine.
 - o. Anus.
 - p. Liver. [ventricle.
 - q. Aorta, springing from the
 - r. Cerebral ganglion.
 - s. Pleural and pedal ganglion.
 - t. Testis.
 - z. Visceral ganglion.
 - y. Vesicula seminalis.
 - z. Penis.

of various groups of the animal kingdom. In development they pass through the typical trochophore and veliger stages provided with boat-like shell.

Sub-order 1.—**Taenioglossa**. Radula with a median tooth and three teeth on each side of it. Formula 3 : 1 : 3.

Tribe 1.—**Platypoda**. Normal Taenioglossa of creeping habit. The foot is flattened ventrally, at all events in its anterior part (*Strombidae*). Ototyros situated close to the pedal nerve-centres. Accessory organs are rarely found on the genital ducts, but occur in *Paludina*, *Cyclostoma*, *Naticidae*, *Calyptraeidae*, &c. Mandibles usually present. This is the largest group of Mollusca, including nearly sixty families, some of which are insufficiently known from the anatomical point of view.

Fam. 1.—**Paludinae**. Pedal centres in the form of ganglionated cords; kidney provided with a ureter; viviparous; fluviatile. *Paludina*, *Neothauma*, from Lake Tanganyika. *Tylopoma*, extinct, Tertiary.

Fam. 2.—**Cyclophoridae**. No ctenidium, pallial cavity transformed into a lung; aperture of shell circular; terrestrial.

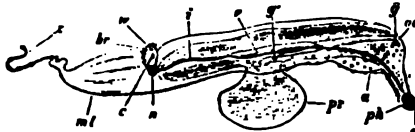

FIG. 29.—*Pterotrachea mutica* seen from the right side. (After Kelenstein.)

- a. Pouch for reception of the snout when retracted.
- c. Pericardium.
- ph. Pharynx.
- oc. Cephalic eye.
- g. Cerebral ganglion.
- g'. Pleuro-pedal ganglion.
- pr. Foot (mesopodium).
- v. Stomach.
- i. Intestine.
- n. So-called nucleus.
- br. Branchial plume (ctenidium).
- os. Osphradium.
- mf. Foot (metapodium).
- z. Caudal appendage.

Pomatias, shell turriculated. *Diplommatina Hybocystis Cyclophorus*, shell umbilicated, with a short spire and horny operculum. *Cyclosorus*, shell uncoiled. *Dermatocera*, foot with a horn-shaped protuberance at its posterior end. *Spiraculum*.

Fam. 3.—**Ampullaridae**. To the left of the ctenidium a pulmonary sac, separated from it by an incomplete septum, am-

phibious. *Ampullaris*, shell dextral, coiled. *Lanistes*, shell sinistral, spire short or obsolete. *Meladomus*.

Fam. 4.—**Littorinidae**. Oesophageal pouches present; pedal nerve-centres concentrated; a pedal penis near the right tentacle. *Littorina*, shell not umbilicated, littoral habit. *Lacuna*, foot with two posterior appendages, marine, entirely aquatic.

Cremnoconchus, entirely aerial, Indian. *Risella*, *Tectarius*.

Fam. 5.—**Fossaridae**. Head with two lobes in some Rhipidoglossa. *Fossaria*.

Fam. 6.—**Purpurinidae**, extinct.

Fam. 7.—**Planaxidae**. Shell with pointed spire; a short pallial siphon. *Planaxis*.

Fam. 8.—**Cyclostomatidae**. Pallial cavity transformed into a lung; pedal centres concentrated; a deep pedal groove. *Cyclostoma*, shell turriculated, operculum calcareous. British. *Omphalotrope*.

Fam. 9.—**Aciculiidae**. Pallial cavity transformed into a lung; operculum horny; shell narrow and elongated. *Acicula*.

Fam. 10.—**Valvatidae**. Ctenidium bipectinate, free; hermaphrodite; fluviatile. *Valvata*, British.

Fam. 11.—**Rissoidae**. Epipodial filaments present; one or two pallial tentacles. *Rissoa*, *Rissoina*, *Siroa*.

Fam. 12.—**Litopidae**. An epipodium bearing three pairs of tentacles and an operculigerous lobe with two appendages; inhabitants of the Sargasso weed. *Litopa*.

Fam. 13.—**Adeorbidae**. Mantle with two posterior appendages; ctenidium large and capable of protrusion from pallial cavity. *Adeorbis*, British.

Fam. 14.—**Jeffreyssidae**. Head with two long labial palps; shell ovoid; operculum horny, semicircular, carinated. *Jeffreyssa*.

Fam. 15.—**Homalogyridae**. Shell flattened; no cephalic tentacles. *Homalogyra*, British. *Ammonicerars*.

Fam. 16.—**Skeneidae**. Shell depressed, with rounded aperture; cephalic tentacles long. *Skenea*, British.

Fam. 17.—**Choristidae**. Shell spiral; four cephalic tentacles; eyes absent; two pedal appendages. *Choristes*.

Fam. 18.—**Assimineidae**. Eyes at free extremities of tentacles. *Assiminea*, estuarine, British.

Fam. 19.—**Truncatellidae**. Snout very long, bilobed; foot short. *Truncatella*.

Fam. 20.—**Hydrobiidae**. Shell with prominent spire; penis distant from right tentacle, generally appendiculated; brackish water or fluviatile. *Hydrobia*, British. *Baikalia*, from Lake Baikal. *Pomatopsis*, *Bithynella*, *Lithoglyphus*, *Spekia*, viviparous, from Lake Tanganyika. *Tanganyicia*, *Limnatochus*, from Lake Tanganyika. *Chytla*, *Littorinida*, *Bithynia*, British, fluviatile. *Stenothyra*.

Fam. 21.—**Melaninidae**. Spire of shell somewhat elongated; mantle-border fringed; viviparous; fluviatile. *Melania*, *Favosus*, *Paludomus*, *Melanopsis*, *Nasospsis*, *Bythoceras*, from Lake Tanganyika.

Fam. 22.—**Typhobiidae**. Foot wide; shell turriculated, with carinated whorls, the carinae tuberculated or spiny. *Typhobia*, *Bathmalia*, from Lake Tanganyika.

Fam. 23.—**Pleuroceridae**. Like *Melaninidae*, but mantle-border not fringed and reproduction oviparous. *Pleurocera*, *Anculotus*.

Fam. 24.—**Pseudomelaninidae**. All extinct.

Fam. 25.—**Subutilidae**. All extinct.

Fam. 26.—**Neritimidae**. All extinct.

Fam. 27.—**Cerithiidae**. Shell with numerous tuberculated whorls; aperture canaliculated anteriorly, short pallial siphon. *Cerithium*, *Bittium*, *Potamides*, *Triforis*, *Laecochelis*, *Cerithiopsis*.

Fam. 28.—**Modiolidae**. Shell with short spire; no siphon. *Modiolus*.



FIG. 30.—*Valvata cristata*, Mull.

- a. Mouth.
- op. Operculum.
- br. Ctenidium (branchial plume).
- z. Filiform appendage (rudimentary ctenidium).

The freely projecting ctenidium of typical form not having its axis fused to the roof of the branchial chamber is the notable character of this genus.

- Fam. 29.—*Vermetidae*. Animal fixed by the shell, the last whorls of which are not in contact with each other; foot small; two anterior pedal tentacles. *Vermetus*, *Siliquaria*.
 Fam. 30.—*Cacidae*. Shell almost completely uncoiled, in one plane, with internal septa. *Cacum*, British.
 Fam. 31.—*Turritellidae*. Shell very long; head large; foot broad. *Turritella*, British. *Mesalia*, *Malthida*.
 Fam. 32.—*Struthiolariidae*. Shell conical; aperture slightly canallicated; siphon slightly developed. *Struthiolaria*.
 Fam. 33.—*Chenopoidae*. Shell elongated; aperture expanded; siphon very short. *Chenopus*, British. *Alaria*, *Spinigera*, *Diartema*, extinct.



FIG. 31.—Shell of *Crucibulum*, seen from below so as to show the inner whorls, concealed by the cap-like outer whorl.

and foot. *Capulus*, *Thyca*, parasitic on asteroids. *Platyceas*, extinct.

- Fam. 37.—*Hippencyidae*. Shell conical; foot secreting a ventral calcareous plate; animal fixed. *Hippencyx*, *Mitularia*.
 Fam. 38.—*Calyptraeidae*. Shell with short spire; lateral cervical lobes present; accessory genital glands. *Calyptraea*, British. *Crepidula*, *Crucibulum*.
 Fam. 39.—*Nariciidae*. Foot divided into two, posterior half bearing the operculum; a wide epipodial velum; shell turbinated. *Narica*.
 Fam. 40.—*Naisidae*. Foot large, with aquiferous system; propodium reflected over head; eyes degenerate; burrowing habit. *Naisica*, British. *Amaura*, *Sigaretus*.
 Fam. 41.—*Lamellaridae*. Shell thin, more or less covered by the mantle; no operculum. *Lamellaria*, *Velutina*, *Marsenina*, *Oncidiopsis*, hermaphrodite.
 Fam. 42.—*Trichotropidae*. Shell with short spire, carinate and pointed. *Trichotropis*.
 Fam. 43.—*Seguenziidae*. Shell trochiform, with canallicated aperture and twisted columella. *Seguenzia*, abyssal.
 Fam. 44.—*Janthinidae*. Shell thin; operculum absent; tentacles bifid; foot secretes a float; pelagic. *Janthina*, *Recluzia*.
 Fam. 45.—*Cypraeidae*. Shell inrolled, solid, polished, aperture very narrow in adult; short siphon; anus posterior; osphradium with three lobes; mantle reflected over shell. *Cypraea*, *Pustularia*, *Ovula*, *Pedicularia*, attached to corals. *Eralia*.
 Fam. 46.—*Tritonidae*. Shell turriculated and siphonated, thick, each whorl with varices; foot broad and truncated anteriorly, pallial siphon well developed; proboscis present. *Triton*, *Perisoma*, *Ranella*.



FIG. 32.—Animal and shell of *Ovula*. a, Cephalic tentacles. b, Foot.

c, Mantle-skirt, which is naturally carried in a reflected condition so as to cover the sides of the shell.

- Fam. 47.—*Columbellinidae*. All extinct.
 Fam. 48.—*Cassidae*. Shell ventricose, with elongated aperture, and short spire; proboscis and siphon long; operculum with marginal nucleus. *Cassis*, *Cassidaria*, *Oniscia*.
 Fam. 49.—*Ocororyidae*. Shell globular and ventricose; aperture oval and canallicated; operculum spiral. *Ocororys*, abyssal.
 Fam. 50.—*Dolidae*. Shell ventricose, with short spire, and wide aperture; no varices and no operculum; foot very broad, with projecting anterior angles; siphon long. *Dolium*, *Pyrala*.
 Fam. 51.—*Solaridae*. *Solarium*, *Torina*, *Fusus*.
 Fam. 52.—*Scalaridae*. Shell turriculated, with elongated spire; proboscis short; siphon rudimentary. *Scalaria*, *Eggsia*, *Crossea*, *Adis*.

The three following families have neither radula nor jaws, and are therefore called *AglOSSA*. They have a well-developed proboscis which is used as a suction organ; some are abyssal, but the majority are either commensals or parasites of Echinoderms.

- Fam. 53.—*Pyramidellidae*. Summit of spire heterostrophic; a projection, the mentum, between head and foot; operculum present. *Pyramidella*, *Turbonilla*, *Odosomia*, British. *Myxa*.

Fam. 54.—*Eulimidae*. Visceral mass still coiled spirally; shell thin and shining. *Eulima*, foot well developed, with an operculum, animal usually free, but some live in the digestive cavity of Holothurians. *Mucronalia*, foot reduced, but still operculate, eyes present, animal fixed by its very long proboscis which is deeply buried in the tissues of an Echinoderm, no pseudopallium. *Stylifer*, the operculum is lost, animal fixed by a large proboscis which forms a pseudopallium covering the whole shell except the extremity of the spire, parasitic on all groups of Echinoderms. *Entosiphon*, visceral mass still coiled; shell much reduced, proboscis very long forming a pseudopallium which covers the whole body and projects beyond in the form of a siphon, foot and nervous system present, eyes, branchia and anus absent, parasite in the Holothurian *Deima bakesi* in the Indian Ocean.



FIG. 33.—Section of the shell of *Triton*, Cuv. (From Owen.)

- Fam. 55.—*Entoconchidae*. No shell; visceral mass not coiled; no sensory organs, nervous system, branchia or anus; body reduced to a more or less tubular sac; hermaphrodite and viviparous; parasitic in Holothurians; larvae are veligers, with shell and operculum. *Entocolax*, mouth at free extremity, animal fixed by aboral orifice of pseudopallium, Pacific. *Entoconcha*, body elongated and tubular, animal fixed by the oral extremity, protandric hermaphrodite, parasitic in testes of Holothurians causing their abortion. *Entoscaeus*, no pseudopallium and no intestine, hermaphrodite, larvae with operculum.

Tribe 2.—*STEREOPODA*. Pelagic Taenioglossa with foot large and laterally compressed to form a fin.
 Fam. 1.—*Alantidae*. Visceral sac and shell coiled in one plane; foot divided transversely into two parts, posterior part bearing an operculum, anterior part forming a fin provided with a sucker. *Alanta*, *Oxygyrus*.
 Fam. 2.—*Carinariidae*. Visceral sac and shell small in proportion to the rest of the body, which cannot be withdrawn into the shell; foot elongated, fin-shaped, with sucker, but without operculum. *Carinaria*, *Cardisopoda*.

- Fam. 3.—*Pterotracheidae*. Visceral sac very much reduced; without shell or mantle; anus posterior; foot provided with sucker in male only. *Pterotracheus*, *Firoloides*, *Pterosoma*.
 Sub-order 2.—*STENOGLLOSSA*. Radula narrow with one lateral tooth on each side, and one median tooth or none.
 Tribe 1.—*RACHIGLOSSA*. Radula with a median tooth and a single

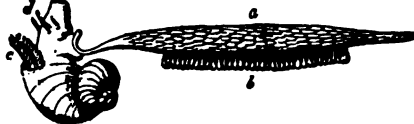

FIG. 34.—Female *Janthina*, with egg float (a) attached to the foot; b, egg capsules; c, ctenidium (gill-plume); d, cephalic tentacles.

tooth on each side of it. Formula 1 : 1 : 1. Rudimentary jaws present.

- Fam. 1.—*Turbinellidae*. Shell solid, piriform, with thick folded columella; lateral teeth of radula bicuspidate. *Turbinella*, *Cynodonta*, *Fulgur*, *Hemifusus*, *Tudicula*, *Streptidura*.
 Fam. 2.—*Fasciolariidae*. Shell elongated, with long siphon; lateral teeth of radula multicuspitate. *Fasciolaria*, *Fusus*, *Clavella*, *Latirus*.
 Fam. 3.—*Mitridae*. Shell fusiform and solid, aperture elongated, columella folded; no operculum; eyes on sides of tentacles. *Mitra*, *Turricula*, *Cylindecomitra*, *Imbricaria*.
 Fam. 4.—*Buccinidae*. Foot large and broad; eyes at base of

- tentacles; operculum horny. *Buccinum*. *Chrysodomus*. *Liomexis*. *Cosinella*. *Trilonidea*. *Piscania*. *Euthria*. *Phos*. *Dipancus*.
- Fam. 5.—*Nassidae*. Foot broad, with two slender posterior appendages; operculum unguiculate. *Nassa*, marine, British. *Canidia*, fluviatile. *Bullia*.
- Fam. 6.—*Muricidae*. Shell with moderately long spire and canal, ornamented with ribs, often spiny; foot truncated anteriorly. *Murex*, British. *Trochon*, British. *Typhis*. *Urosalpinx*. *Lachenis*.
- Fam. 7.—*Purpuridae*. Shell thick, with short spire, last whorl large and canal short; aperture wide; operculum horny. *Purpura*, British. *Rapana*. *Monaceros*. *Sistrum*. *Concholepas*.
- Fam. 8.—*Haliidae*. Shell ventricose, thin and smooth, with wide aperture; foot large and thick, without operculum. *Halia*.
- Fam. 9.—*Cancellariidae*. Shell ovoid, with short spire and folded columella; foot small, no operculum; siphon short. *Cancellaria*.
- Fam. 10.—*Columbellidae*. Spire of shell prominent, aperture narrow, canal very short, columella crenelated; foot large. *Columbella*.
- Fam. 11.—*Coralliophilidae*. Shell irregular; radula absent; foot and siphon short; sedentary animals, living in corals. *Coralliophila*. *Rhizochilus*. *Leptocoelus*. *Magulus*. *Rapa*.
- Fam. 12.—*Voluidae*. Head much flattened and wide, with eyes on sides; foot broad; siphon with internal appendages. *Voluta*. *Cuvillaea*. *Cymba*.
- Fam. 13.—*Olividae*. Foot with anterior transverse groove; a posterior pallial tentacle; generally burrowing. *Olivina*. *Olivella*. *Ancillaria*. *Agaronia*.
- Fam. 14.—*Marginellidae*. Foot very large; mantle reflected over shell. *Marginella*. *Pseudomarginella*.
- Fam. 15.—*Ilorpidae*. Foot very large; without operculum; shell with short spire and longitudinal ribs; siphon long. *Ilorpa*.
- Tribe 2.—*TOXIGLOSSA*. No jaws. No median tooth in radula. Formula: 1:0:1. Poison-gland present whose duct traverses the nerve-collar.
- Fam. 1.—*Pleurotomatidae*. Shell fusiform, with elongated spire; margin of shell and mantle notched. *Pleurotoma*. *Clavatul*. *Mangilia*. *Bela*. *Pusionella*. *Pontiothasuma*.
- Fam. 2.—*Terebridae*. Shell turriculated, with numerous whorls; aperture and operculum oval; eyes at summits of tentacles; siphon long. *Terebra*.
- Fam. 3.—*Conidae*. Shell conical, with very short spire, and narrow aperture with parallel borders; operculum unguiform. *Conus*.

Sub-Class II.—EUTHYNEURA

The most important general character of the Euthyneura is the absence of torsion in the visceral commissure, and the more posterior position of the anus and pallial organs. Comparative anatomy and embryology prove that this condition is due, not as formerly supposed to a difference in the relations of the visceral commissure which prevented it from being included in the torsion of the visceral hump, but to an actual detorsion which has taken place in evolution and is repeated to a great extent in individual development. In several of the more primitive forms the same torsion occurs as in Streptoneura, viz. in *Actaeon* and *Limacina* among Opisthobranchia, and *Chilina* among Pulmonata. *Actaeon* is prosobranchiate, the visceral commissure is twisted in *Actaeon* and *Chilina*, and even slightly still in *Bulla* and *Scaphander*; in *Actaeon* and *Limacina* the osphradium is to the left, innervated by the supra-intestinal ganglion. But in the other members of the sub-class the detorsion of the visceral mass has carried back the anus and circumanal complex from the anterior dorsal region to the right side, as in *Bulla* and *Aplysia*; or even to the posterior end of the body, as in *Philina*, *Oncidium*, *Doris*, &c. Different degrees of the same process of detorsion are, as we have seen, exhibited by the Heteropoda among the Streptoneura, and both in them and in the Euthyneura the detorsion is associated with degeneration of the shell. Where the modification is carried to its extreme degree, not only the shell but the pallial cavity, ctenidium and visceral hump disappear, and the body acquires a simple elongated form and a secondary external symmetry, as in *Pterotrachea* and in *Doris*, *Eolis*, and other Nudibranchia. These facts afford strong support to the hypothesis that the weight of the shell is the original cause of the torsion of the dorsal visceral mass in Gastropods. But this hypothesis leaves the elevation of the visceral mass and the zigzagging coiling of the shell in the ancestral form unexplained.

In those Euthyneura in which the shell is entirely absent in the adult, it is, except in the three genera *Cerata*, *Runcina* and *Vaginula*, developed in the larva and then falls off. In other cases (Tectibranchs) the reduced shell is enclosed by upgrowths of the edge of the mantle and becomes internal, as in many Cephalopods. A few Euthyneura in which the shell is not much reduced retain an operculum in the adult state, e.g. *Actaeon*, *Limacina*, and the marine Pulmonate, *Amphibola*. The detorted visceral commissure shows a tendency to the concentration of all its elements round the oesophagus, so that except in the Bullomorpha and in *Aplysia* the whole nervous system is aggregated in the cephalic region, either dorsally or ventrally. The



FIG. 35.—*Acera bullata*. A single row of teeth of the Radula. (Formula, x.l.x.)

radula has a number of uniform teeth on each side of the median tooth in each transverse row. The head in most cases bears two pairs of tentacles. All the Euthyneura are hermaphrodite.

In the most primitive condition the genital duct is single throughout its length and has a single external aperture; it is therefore said to be monaulic. The hermaphrodite aperture is on the right side near the opening of the pallial cavity, and a ciliated groove conducts the spermatozoa to the penis, which is situated more anteriorly. This is the condition in the Bullomorpha, the Aplysiomorpha, and in one Pulmonate, *Pythia*. In some cases while the original aperture remains undivided, the seminal groove is closed and so converted into a canal. This is the modification found in *Cavolinia longirostris* among the Bullomorpha, and in all the *Auriculidae* except *Pythia*. A further degree of modification occurs when the male duct takes its origin from the hermaphrodite duct above the external opening, so that there are two distinct apertures, one male and one female, the latter being the original opening. The genital duct is now said to be dialic, as in *Valvata*, *Oncidiopsis*, *Actaeon*, and *Lobiger* among the Bullomorpha, in the *Pleurobranchidae*, in the Nudibranchia, except the *Doridomorpha* and most of the Elysiomorpha, and in the Pulmonata. Originally in this condition the female aperture is at some distance from the male, as in the Basommatophora and in other cases; but in some forms the female aperture itself has shifted and come to be contiguous with the male opening and penis as in the Stylommatophora. In all these cases the female duct bears a bursa copulatrix or receptaculum seminis. In some forms this receptacle acquires a separate external opening remaining connected with the oviduct internally. There are thus two female openings, one for copulation, the other for oviposition, as well as a male opening. The genital duct is now trifurcated or triaulic, a condition which is confined to certain Nudibranchia, viz. the *Doridomorpha* and most of the Elysiomorpha.

The Pteropoda, formerly regarded as a distinct class of the Mollusca, were interpreted by E. R. Lankester as a branch of the Cephalopoda, chiefly on account of the protrusible sucker-bearing processes at the anterior end of *Pneumodermis*. These he considered to be homologous with the arms of Cephalopods. He fully recognized, however, the similarity of Pteropoda to Gastropods in their general asymmetry and in the torsion of the visceral mass in *Limacinae*. It is now understood that they are Euthyneurous Gastropods adapted to natatory locomotion and pelagic life. The sucker-bearing processes of *Pneumodermis* are outgrowths of the proboscis. The fins of Pteropods are now interpreted as the expanded lateral margins of the foot, termed parapodia, not homologous with the siphon of Cephalopods which is formed from epipodia. The Thecosomatous Pteropods are allied to *Bulla*, the Gymnosomatous forms to *Aplysia*. The Euthyneura comprises two orders, Opisthobranchia and Pulmonata.

Order 1.—OPISTHBRANCHIA. Marine Euthyneura, the more archaic forms of which have a relatively large foot and a small visceral hump, from the base of which projects on the right side a short mantle-skirt. The anus is placed in such forms far back beyond the mantle-skirt. In front of the anus, and only partially covered

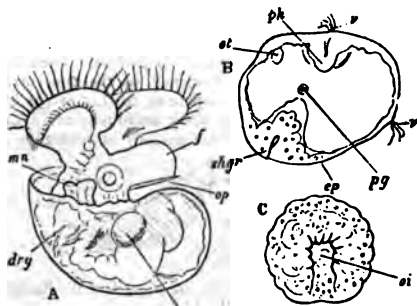

FIG. 36.

A. Veliger-larva of an Opisthobranch (*Polysera*). *f*, Foot; *op*, operculum; *mw*, anal papilla; *ry*, dry, two portions of unabsorbed nutritive yolk on either side of the intestine. The right otocyst is seen at the root of the foot.

B. Trochophere of an Opisthobranch (*Pleurobranchidium*) showing—*shg*, the shell-gland or primitive shell-sac; *v*, the cilia of the velum; *ph*, the commencing stomodaeum or oral invagination; *ot*, the left otocyst; *pg*, red-coloured pigment spot.

C. Diblastula of an Opisthobranch (*Polysera*) with elongated blastopore *oi*.

(All from Lankester.)

by the mantle-skirt, is the ctenidium with its free end turned backwards. The heart lies in front of, instead of to the side of, the attachment of the ctenidium—hence Opisthobranchia as opposed to "Prosobranchia," which correspond to the Streptoneura. A shell is possessed in the adult state by but few Opisthobranchia, but all pass through a veliger larval stage with a nautiloid shell (fig. 36). Many Opisthobranchia have by a process of atrophy lost the typical ctenidium and the mantle-skirt, and have developed other organs in their place.



FIG. 37.—*Phyllirhoe bucephala*, twice the natural size, a transparent pisciform pelagic Opisthobranch. The internal organs are shown as seen by transmitted light. (After W. Kesterstein.)

- a. Mouth.
- b. Radula sac.
- c. Oesophagus.
- d. Stomach.
- e. Intestine.
- f. Anus.
- g, g', g'', g'''. The four lobes of the liver.
- h. The heart (auricle and ventricle).
- i. The renal sac (nephridium).
- j. The ciliated communication of the renal sac with the pericardium.
- m. The external opening of the renal sac.
- n. The cerebral ganglion.
- o. The cephalic tentacles.
- p. The genital pore.
- q. The ovo-testes.
- w. The parasitic hydromedusa *Mnestra*, usually found attached in this position by the aboral pole of its umbrella.

the gill which the more degenerate Opisthobranchia exhibit, this order stands alone. Some Opisthobranchia are striking examples of degeneration (some Nudibranchia), having none of those regions or processes of the body developed which distinguish the archaic Mollusca from such flat-worms as the Dendrocoel Planarians. In-

deed, were it not for their retention of the characteristic odontophore we should have little or no indication that such forms as *Phyllirhoe* and *Limapontia* really belong to the Mollusca at all. The interesting little *Rhodope veranyi*, which has no odontophore, has been associated by systematists both with these simplified Opisthobranchs and with Rhabdocoel Planarians.

In many respects the sea-hare (*Aplysia*), of which several species are known (some occurring on the English coast), serves as a convenient example of the fullest development of the organization characteristic of Opisthobranchia. The woodcut (fig. 38) gives a faithful representation of the great mobility of the various parts of the body. The head is well marked and joined to the body by a somewhat constricted neck. It carries two pairs of cephalic tentacles and a pair of sessile eyes. The visceral hump is low and not drawn out into a spine. The foot is long, carrying the oblong visceral mass upon it, and projecting (as metapodium) a little beyond it (*f*). Laterally the foot gives rise to a pair of mobile fleshy lobes, the parapodia (*ep*), which can be thrown up so as to cover in the dorsal surface of the animal. Such parapodia are common, though by no means universal, among Opisthobranchia. The torsion of the visceral hump is not carried out very fully, the consequence being that the anus has a posterior position a little to the right of the median line above the metapodium, whilst the branchial chamber formed by the overhanging mantle-skirt faces the right side of the body instead of lying well to the front as in Streptoneura and as in Pulmonate Euthyneura. The gill-plume, which in *Aplysia* is the typical Molluscan ctenidium, is seen in fig. 39 projecting from the branchial sub-pallial space.

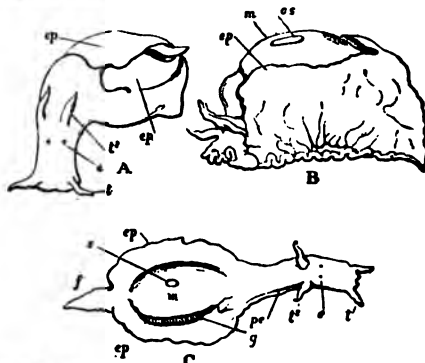
FIG. 38.—Three views of *Aplysia* sp., in various conditions of expansion and retraction. (After Cuvier.)

- a. Anterior cephalic tentacles.
- b. Posterior cephalic tentacles.
- e. Eyes.
- f. Metapodium.
- ep. Epipodium.
- g. Gill-plume (ctenidium).
- m. Mantle-flap reflected over the thin oval shell.
- o. Orifice formed by the unclosed border of the reflected mantle-skirt, allowing the shell to show.
- p. The spermatic groove.

The relation of the delicate shell to the mantle is peculiar, since it occupies an oval area upon the visceral hump, the extent of which is indicated in fig. 38, C, but may be better understood by a glance at the figures of the allied genus *Umbrella* (fig. 40), in which the margin of the mantle-skirt coincides, just as it does in the limpet, with the margin of the shell. But in *Aplysia* the mantle is reflected over the edge of the shell, and grows over its upper surface so as to completely enclose it, excepting at the small central area *s* where the naked shell is exposed. This enclosure of the shell is a permanent development of the arrangement seen in many Streptoneura (e.g. *Pyrula*, *Ovula*, see figs. 18 and 32), where the border of the mantle can be, and usually is, drawn over the shell, though it is withdrawn (as it cannot be in *Aplysia*) when they are irritated. From the fact that *Aplysia* commences its life as a free-swimming veliger with a nautiloid shell not enclosed in any way by the border of the mantle, it is clear that the enclosure of the shell in the adult is a secondary process. Accordingly, the shell of *Aplysia* must not be confounded with a primitive shell in its shell-sac, such as we find realized in the shells of *Chiton* and in the plugs which form in the remarkable transitory "shell-sac" or "shell-gland" of Molluscan embryos (see figs. 26, 60). *Aplysia*, like other Mollusca, develops a primitive shell-sac in its trochophere stage of development, which disappears and is succeeded by a nautiloid shell (fig. 36). This forms the nucleus of the adult shell, and, as the animal grows, becomes enclosed by a reflection of the mantle-skirt. When the shell of an *Aplysia* enclosed in its mantle is pushed well to the left, the sub-pallial space is fully exposed as in fig. 39, and the various apertures of the body are seen,

Posteriorly we have the anus, in front of this the lobate gill-plume, between the two (hence corresponding in position to that of the Pectinibranchia) we have the aperture of the renal organ. In front, near the anterior attachment of the gill-plume, is the osphradium (olfactory organ) discovered by J. W. Spengel, yellowish in colour, in the typical position, and overlying an olfactory ganglion with typical nerve-connection (see fig. 43). To the right of Spengel's osphradium is the opening of a peculiar gland which has, when dissected out, the form of a bunch of grapes; its secretion is said to be poisonous. On the under side of the free edge of the mantle are situated the numerous small cutaneous glands which, in the large *Aplysia camelus* (not in other species), form the purple secretion which was known to the ancients. In front of the osphradium is the single genital pore, the aperture of the common or hermaphrodite duct. From this point there passes forward to the right side of the head a groove—the spermatic groove—down which the spermatic fluid passes. In other Euthyneura this groove may close up and form a canal. At its termination by the side of the head is the muscular introverted penis. In the hinder part of the foot (not shown in any of the diagrams) is the opening of a large mucus-forming gland very often found in the Molluscan foot.

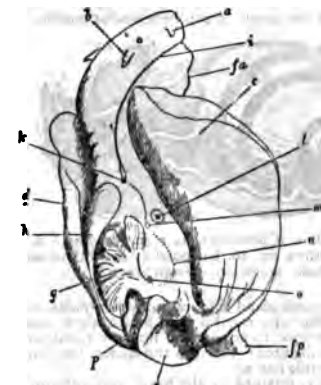

FIG. 39.—*Aplysia leporina* (*camelus*, Cuv.), with epipodia and mantle reflected away from the mid-line. (Lankester.)

- a, Anterior cephalic tentacle.
- b, Posterior cephalic tentacle; between a and b, the eyes.
- c, Right epipodium.
- d, Left epipodium.
- e, Hinder part of visceral hump.
- fp, Posterior extremity of the foot.
- fa, Anterior part of the foot underlying the head.
- g, The tenticulum (branchial pleure).
- h, The mantle-skirt tightly spread over the horny shell and pushed with it towards the left side.
- i, The spermatic groove.
- k, The common genital pore (male and female).
- l, Orifice of the grape-shaped (supposed poisonous) gland.
- m, The osphradium (olfactory organ of Spengel).
- n, Outline of part of the renal sac (nephridium) below the surface.
- o, External aperture of the nephridium.
- p, Anus.

renal organ (nephridium), the external opening of which has already been noted. The position of this opening and other features of the renal organ were determined by J. T. Cunningham.

There is considerable uncertainty with respect to the names of the species of *Aplysia*. There are two forms which are very common in the Gulf of Naples. One is quite black in colour, and measures when

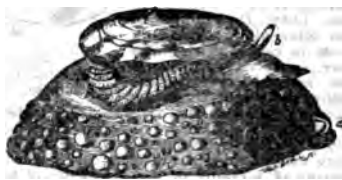

FIG. 40.—*Umbrella mediterranea*. a, mouth; b, cephalic tentacle; h, gill (tenticulum). The free edge of the mantle is seen just below the margin of the shell (compare with *Aplysia*, fig. 39). (From Owen.)

outstretched 8 or 9 in. in length. The other is light brown and somewhat smaller, its length usually not exceeding 7 in. The first is flaccid and sluggish in its movements, and has not much power of contraction; its epipodial lobes are enormously developed and extend far forward along the body; it gives out when handled an abundance of purple liquid, which is derived from cutaneous glands situated

on the under side of the free edge of the mantle. According to F. Blochmann it is identical with *A. camelus* of Cuvier. The other species is *A. depilans*; it is firm to the touch, and contracts forcibly when irritated; the secretion of the mantle-glands is not abundant, and is milky white in appearance. The kidney has similar relations in both species, and is identical with the organ spoken of by many authors as the triangular gland. Its superficial extent is seen when the folds covering the shell are cut away and the shell removed; the external surface forms a triangle with its base bordering the pericardium, and its apex directed posteriorly and reaching to the left-hand posterior corner of the shell-chamber. The dorsal surface of the kidney extends to the left beyond the shell-chamber beneath the skin in the space between the shell-chamber and the left parapodium.

When the animal is turned on its left-hand side and the mantle-chamber widely opened, the gill being turned over to the left, a part of the kidney is seen beneath the skin between the attachment of the gill and the right parapodium (fig. 39). On examination this is found to be the under surface of the posterior limb of the gland, the upper surface of which has just been described as lying beneath the shell. In the posterior third of this portion, close to that edge which is adjacent to the base of the gill, is the external opening (fig. 39, e).

When the pericardium is cut open from above in an animal otherwise entire, the anterior face of the kidney is seen forming the posterior wall of the pericardial chamber; on the deep edge of this face, a little to the left of the attachment of the auricle to the floor of the pericardium, is seen a depression; this depression contains the opening from the pericardium into the kidney.

To complete the account of the relations of the organ: the right anterior corner can be seen superficially in the wall of the mantle-chamber above the gill. Thus the base of the gill passes in a slanting direction across the right-hand side of the kidney, the posterior end being dorsal to the apex of the gland, and the anterior end ventral to the right-hand corner.

As so great a part of the whole surface of the kidney lies adjacent to external surfaces of the body, the remaining part which faces the internal organs is small; it consists of the left part of the under surface: it is level with the floor of the pericardium, and lies over the globular mass formed by the liver and convoluted intestine.

Thus the renal organ of *Aplysia* is shown to conform to the Molluscan type. The heart lying within the adjacent pericardium has the usual form, a single auricle and ventricle. The vascular system is not extensive, the arteries soon ending in the well-marked spongy tissue which builds up the muscular foot, parapodia, and dorsal body-wall.

The alimentary canal commences with the usual buccal mass; the lips are cartilaginous, but not armed with horny jaws, though these are common in other Opisthobranchs; the lingual ribbon is multidentate, and a pair of salivary glands pour in their secretion. The oesophagus expands into a curious gizzard, which is armed internally with large horny processes, some broad and thick, others spinous, fitted to act as crushing instruments. From this we pass to a stomach and a coil of intestine embedded in the lobes of a voluminous liver; a caecum of large size is given off near the commencement of the intestine. The liver opens by two ducts into the digestive tract.

The generative organs lie close to the coil of intestine and liver, a little to the left side. When dissected out they appear as represented in fig. 41.

i, Oyo-testis.
 h, Hermaphrodite duct, essential reproductive organ or gonad, consists of both ovarian and testicular cells (see fig. 42). It is an ovo-testis. From it passes a common or hermaphrodite duct, which very soon becomes entwined in the spine of a gland—the albuminiferous gland. The latter opens into the common duct at the point h, and here also is a small diverticulum of the duct f. Passing on, we find not far from the genital pore a glandular spherical body (the spermatheca c) opening by means of a longish duct into the common duct, and then we reach the pore (fig. 39, k). Here the female apparatus terminates. But when the male secretion of the ovo-testis is active, the seminal fluid passes from the genital pore along the spermatic groove (fig. 39) to the penis, and is by the aid of that ever-ready muscular organ introduced into the genital pore of a second *Aplysia*, whence it passes into the spermatheca there to await the activity of the female element of the ovo-testis of this second *Aplysia*. After an interval

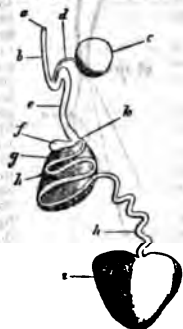

FIG. 41.—Gonad, and accessory glands and ducts of *Aplysia*. (Lankester.)

of some days—possibly weeks—the ova of the second *Aplysia* commence to descend the hermaphroditic duct; they become en-

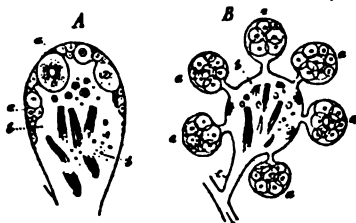

FIG. 42.—Follicles of the hermaphroditic gonads of Euthyneurous Gastropods. A, of *Helix*; B, of *Eolis*; a, ova; b, developing spermatozoa; c, common efferent duct.

closed in a viscid secretion at the point where the albuminiferous gland opens into the duct intertwined with it; and on reaching the point where the spermathecal duct debouches they are impregnated by the spermatozoa which escape now from the spermatheca and meet the ova.

The development of *Aplysia* from the egg presents many points of interest from the point of view of comparative embryology, but in relation to the morphology of the Opisthobranchia it is sufficient to point to the occurrence of a trochophore and a veliger stage (fig. 36), and of a shell-gland or primitive shell-sac (fig. 36 *skgr.*), which is succeeded by a nautiloid shell.

In the nervous system of *Aplysia* the great ganglion-pairs are well developed and distinct. The euthyneurous visceral loop is long, and presents only one ganglion (in *Aplysia camelus*, but two distinct ganglia joined to one another in *Aplysia hybrida* of the English coast), placed at its extreme limit, representing both the right and left visceral ganglia and the third or abdominal ganglion, which are so often separately present. The diagram (fig. 43) shows the nerve connecting this abdomino-visceral ganglion with the olfactory ganglion of Spengel. It is also seen to be connected with a more remote ganglion—the genital. Such special irregularities in the development of ganglia upon the visceral loop, and on one or more of the main nerves connected with it, are very frequent. Our figure of the nervous system of *Aplysia* does not give the small pair of buccal ganglia which are, as in all glossophorous Molluscs, present upon the nerves passing from the cerebral region to the odontophore.

For a comparison of various Opisthobranchs, *Aplysia* will be found to present a convenient starting-point. It is one of the more typical Opisthobranchs, that is to say, it belongs to the section Tectibranchia, but other members of the sub-order, namely, *Bulla* and *Actaeon* (figs. 44 and 45), are less abnormal than *Aplysia* in regard to their shells and the form of the visceral hump. They have naked spirally twisted shells which may be concealed from view in the living animal by the expansion and reflection of the parapodia, but are not enclosed by the mantle, whilst *Actaeon* is remarkable for possessing an operculum like that of so many Streptoneura.

The great development of the parapodia seen in *Aplysia* is usual in Tectibranchiate Opisthobranchs. The whole surface of the body becomes greatly modified in those Nudibranchiate forms which have lost not only the shell, but also the ctenidium. Many of these have peculiar processes developed on the dorsal surface (fig. 46, A, B), or retain purely negative characters (fig. 46, D). The chief modification of internal organization presented by these forms, as compared with *Aplysia*, is found in the condition of the alimentary canal. The liver is no longer a compact organ opening by a pair of ducts into the median

digestive tract, but we find very numerous hepatic diverticula on a shortened axial tract (fig. 47). These diverticula extend usually one into each of the dorsal papillae or "cerata" when these are present. They are not merely digestive glands, but are sufficiently wide to act as receptacles of food, and in them the digestion of food proceeds just as in the axial portion of the canal. A precisely similar modification



FIG. 44.—*Bulla verillum* (Chemnitz), as seen crawling. a, oral hood (compare with *Tethys*, fig. 46, B), possibly a continuation of the epipodia; b, b', cephalic tentacles. (From Owen.)

of the liver or great digestive gland is found in the scorpions, where the axial portion of the digestive canal is short and straight, and the lateral ducts sufficiently wide to admit food into the ramifications of the gland there to be digested; whilst in the spiders the gland is reduced to a series of simple caeca.

The typical character is retained by the heart, pericardium, and the communicating nephridium or renal organ in all Opisthobranchs. An interesting example of this is furnished by the fish-like transparent *Phyllirohōs* (fig. 37), in which it is possible most satisfactorily to study in the living animal, by means of the microscope, the course of the blood-stream, and also the reno-pericardial communication. In many of the Nudibranchiate Opisthobranchs the nervous system presents a concentration of the ganglia (fig. 48), contrasting greatly with what we have seen in *Aplysia*. Not only are the pleural ganglia fused to the cerebral, but also the visceral to these (see in further illustration the condition attained by the Pulmonate *Limnaeus*, fig. 59), and the visceral loop is astonishingly short and insignificant (fig. 48, e'). That the parts are rightly thus identified is probable from J. W. Spengel's observation of the osphradium and its nerve-supply in these forms; the nerve to that organ, which is placed somewhat anteriorly—on the dorsal surface—being given off from the hinder part (visceral) of the right compound ganglion—the fellow to that marked A in fig. 48. The Eolid-like Nudibranchs, amongst other specialities of structure, possess (in some cases at any rate) apertures at the apices of the "cerata" or dorsal papillae, which lead from the exterior into the hepatic caeca. Some amongst them (*Tergipes*, *Eolis*) are also remarkable for possessing peculiarly modified cells placed in sacs (midosses) at the apices of these same papillae, which resemble the "thread-cells" of the Coelentera. According to T. S. Wright and J. H. Grosvenor these nematocytes are derived from the hydroids on which the animals feed.

The development of many Opisthobranchia has been examined—e.g. *Aplysia*, *Pleurobranchidium*, *Elysia*, *Polytera*, *Doris*, *Tergipes*. All pass through trochophore and veliger stages, and in all a nautiloid or boat-like shell is developed, preceded by a well-marked "shell-gland" (see fig. 36). The transition from the free-swimming veliger larva with its nautiloid shell (fig. 36) to the adult form has not been properly observed, and many interesting points as to the true nature of folds (whether parapodia or mantle or velum) have yet to be cleared up by a knowledge of such development in forms like *Tethys*, *Doris*, *Phyllidia*, &c. As in other Molluscan groups, we find even in closely-allied genera (for instance, in *Aplysia* and *Pleurobranchidium*, and other genera), the greatest differences as to the amount of food-material by which the egg-shell is encumbered. Some form their diblastula by emboly, others by epiboly; and in the later history of the further development of the enclosed cells (archenteron) very marked variations occur in closely-allied forms, due to the influence of a greater or less abundance of food-material raised with the protoplasm of the egg.

Sub-order 1.—TECTIBRANCHIA. Opisthobranchs provided in the adult state with a shell and a mantle, except *Runcina*, *Pleurobranchaea*, *Cymbalidae*, and some Aplysiomorpha. There is a ctenidium, except in some Thecosomata and Gymnosomata, and an osphradium.

Tribe 1.—BULLOMORPHA. The shell is usually well developed, except in *Runcina* and *Cymbalidae*, and may be external or internal. No operculum, except in *Actaeonidae* and *Limacinae*. The pallial cavity is always well developed, and contains the ctenidium, at least in part; ctenidium, except in *Lephaeroides*, of folded type. With



FIG. 45.—*Actaeon*. a, shell; b, oral hood; c, foot; d, operculum.

the exception of the *Aplustridae*, *Lophocercidae* and *Thecosomata*, the head is devoid of tentacles, and its dorsal surface forms a digging

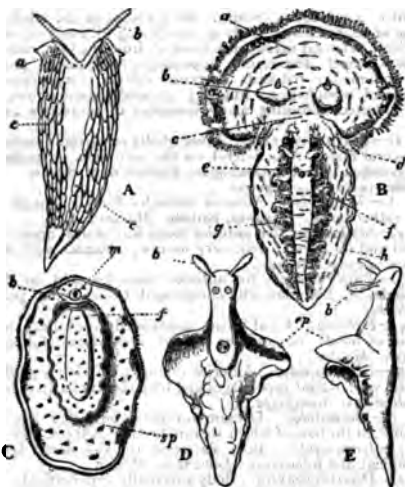

FIG. 46.

- A, *Eolis papillosa* (Lin.), dorsal view.
 a, b, Posterior and anterior cephalic tentacles. c, The dorsal "cerata."
 B, *Tethys leporina*, dorsal view.
 a, The cephalic hood.
 b, Cephalic tentacles.
 c, Neck.
 d, Genital pore.
 C, *Doris (Actinocyclus) tuberculatus* (Cuv.), seen from the pedal surface.
 m, Mouth.
 n, Margin of the head.
 D, E, Dorsal and lateral view of *Elysia (Actaeon) viridis*. ep, epipodial outgrowths. (After Kefelerstein.)
 disk or shield. The edges of the foot form parapodia, often transformed into fins. Posteriorly the mantle forms a large pallial lobe
- e, Anus.
 f, Large cerata.
 g, Smaller cerata.
 h, Margin of the foot.
 i, Sole of the foot.
 sp, The mantle-like epipodium.



FIG. 47.—Enteric Canal of *Eolis papillosa*. (From Gegenbaur, after Alder and Hancock.)
 ph, Pharynx.
 m, Midgut, with its hepatic appendages h, all of which are not figured.
 e, Hind gut.
 an, Anus.



FIG. 48.—Central Nervous System of *Fiona* (one of the Nudibranchia), showing a tendency to fusion of the great ganglia. (From Gegenbaur, after Bergh.)
 A, Cerebral, pleural and visceral ganglia united.
 B, Pedal ganglion.
 C, Buccal ganglion.
 D, Oesophageal ganglion connected with the buccal.
 a, Nerve to superior cephalic tentacle.
 b, Nerves to inferior cephalic tentacles.
 c, Nerve to generative organs.
 d, Pedal nerve.
 e, Pedal commissure.
 f, Visceral loop or commissure (?).

under the pallial aperture. Stomach generally provided with chitinous or calcified masticatory plates. Visceral commissure fairly

long, except in *Runcina*, *Lobiger* and *Thecosomata*. Hermaproditic genital aperture, connected with the penis by a ciliated groove, except in *Actaeon*, *Lobiger* and *Cavolinia longirostris*, in which the spermiduct is a closed tube. Animals either swim or burrow.

- Fam. 1.—*Actaeonidae*. Cephalic shield bifid posteriorly; margins of foot slightly developed; genital duct dialic; visceral commissure streptoneurous; shell thick, with prominent spire and elongated aperture; a horny operculum. *Actaeon*, British. *Solidula*. *Tornatellaea*, extinct. *Adelactaron*. *Bullina*. *Bullinula*.
 Fam. 2.—*Ringiculidae*. Cephalic disk enlarged anteriorly, forming an open tube posteriorly; shell external, thick, with prominent spire; no operculum. *Ringicula*. *Pugnus*.

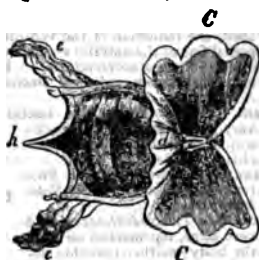

FIG. 49.—*Cavolinia tridentata*, Forsk. from the Mediterranean, magnified two diameters. (From Owen.)

- Fam. 3.—*Tornatimidae*. Margins of foot not prominent; no radula; shell external, with inconspicuous spire. *Tornatina*, British. *Retusa*. *Vobula*.
 Fam. 4.—*Scaphandridae*. Cephalic shield short, truncated posteriorly; eyes deeply embedded; three calcareous stomacal plates; shell external, with reduced spire. *Scaphander*, British. *Alys*. *Smaragdinella*. *Cylichna*, British. *Amphisphyrina*, British.
 Fam. 5.—*Bullidae*. Margins of foot well developed; eyes superficial; three chitinous stomacal plates; shell external, with reduced spire. *Bulla*, British. *Haminae*, British.
 Fam. 6.—*Acrotidae*. Cephalic shield continuous with neck; twelve to fourteen stomacal plates; a posterior pallial filament passing through a notch in shell. *Acera*, British. *Cylindrobulla*. *Volutella*.
 Fam. 7.—*Aplustridae*. Foot very broad; cephalic shield with four tentacles; shell external, thin, without prominent spire. *Aplustrum*. *Hydatina*. *Micromelo*.
 Fam. 8.—*Phyllinidae*. Cephalic shield broad, thick and simple; shell wholly internal, thin, spire much reduced, aperture very large. *Philine*, British. *Cryptophthalmus*. *Chelinodura*. *Phanerophthalmus*. *Colpodaspis*, British. *Coloboccephalus*.
 Fam. 9.—*Dorididae*. Cephalic shield ending posteriorly in a median point; shell internal, largely membranous; no radula or stomacal plates. *Doridium*. *Navarchus*.
 Fam. 10.—*Gastropteridae*. Cephalic shield pointed behind; shell internal, chiefly membranous, with calcified nucleus, nautiloid; parapodia forming fins. *Gastropteron*.
 Fam. 11.—*Runcinidae*. Cephalic shield continuous with dorsal integument; no shell; ctenidium projecting from mantle cavity. *Runcina*.
 Fam. 12.—*Lophocercidae*. Shell external, globular or ovoid; foot elongated, parapodia separate from ventral surface; genital duct dialic. *Lobiger*. *Lophocercus*.
 The next three families form the group formerly known as Thecosomatous Pteropods. They are all pelagic, the foot being entirely transformed into a pair of anterior fins; eyes are absent, and the nerve centres are concentrated on the ventral side of the oesophagus.
 Fam. 13.—*Limacinidae*. Dextral g animals, with shell coiled pseudo-sinistrally; operculum with sinistral spiral; pallial cavity dorsal. *Limacina*, British. *Peradis*, ctenidium present.
 Fam. 14.—*Cymbulidae*. Adult without shell; a sub-epithelial pseudoconch formed by connective tissue; pallial cavity ventral. *Cymbulia*. *Cymbulioopsis*. *Gleba*. *Desmopteris*.
 Fam. 15.—*Cavolinidae*. Shell not coiled, symmetrical; pallial cavity ventral. *Cavolinia*. *Clio*. *Cuvierina*.
 Tribe 2.—*APLYSIOMORPHA*. Shell more or less internal, much reduced or absent. Head bears two pairs of tentacles. Parapodia separate from ventral surface, and generally transformed into



FIG. 50.—Shell of *Cavolinia tridentata*, seen from the side.
 f, Postero-dorsal surface.
 g, Antero-ventral surface.
 h, Median dorsal spine.
 i, Mouth of the shell.

swimming lobes. Visceral commissure much shortened, except in *Aplysia*. Genital duct monaulic; hermaphrodite duct connected with penis by a ciliated groove. Animals either swim or crawl.

Fam. 1.—*Aplysiidae*. Shell partly or wholly internal, or absent; foot long, with well-developed ventral surface. *Aplysia*, *Dolabella*, *Dolabrifer*, *Aplysiella*, *Phyllaplysia*, *Notarachus*.

The next six families include the animals formerly known as Gymnosomatus Pteropods, characterized by the absence of mantle and shell, the reduction of the ventral surface of the foot, and the parapodial fins at the anterior end of the body. They are all pelagic.

Fam. 2.—*Pneumodermatidae*. Pharynx evaginable, with suckers. *Pneumoderma*, *Desiobranchea*, *Spongiobranchea*, *Schmibrachium*.

Fam. 3.—*Clionopsidae*. No buccal appendages or suckers; a very long evaginable proboscis; a quadriradiate terminal branchia. *Clionopsis*.

Fam. 4.—*Notobranchiidae*. Posterior branchia triradiate. *Notobranchia*.

Fam. 5.—*Thliptodontidae*. Head very large, not marked off from the body; neither branchia nor suckers; fins situated near the middle of the body. *Thliptodon*.

Fam. 6.—*Clionidae*. No branchia

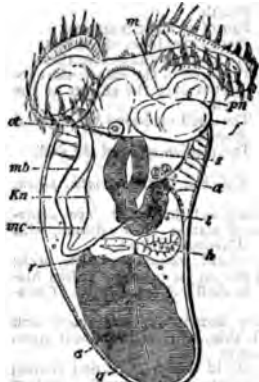

FIG. 51.—Embryo of *Cavolinia tridentata*. (From Balfour, after Fol.)

- a, Anus.
- f, Median portion of the foot.
- pn, Pteropodial lobe of the foot.
- h, Heart.
- i, Intestine.
- m, Mouth.
- ot, Otocyst.
- sh, Shell.
- g, Nephridium.
- r, Oesophagus.
- e, Sac containing nutritive yolk.
- mb, Mantle-skirt.
- mc, Sub-pallial chamber.
- Ka, Contractile sinus.

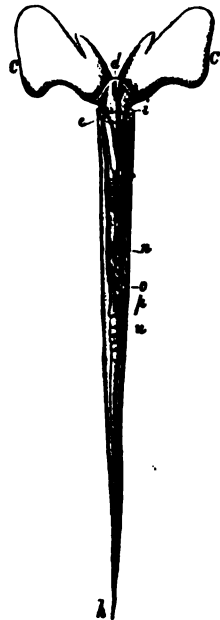

FIG. 52.—*Styliola acicula*, Rang. sp. enlarged. (From Owen.)

- C, C, The wing-like lobes of the foot.
- d, Median fold of same.
- e, Copulatory organ.
- h, Pointed extremity of the shell.
- i, Anterior margin of the shell.
- n, Stomach.
- o, Liver.
- s, Hermaphrodite gonad.

of any kind; a short evaginable pharynx, bearing paired conical buccal appendages or "cephalopods." *Cliona*, *Paraclyona*, *Fowlerina*.

Fam. 7.—*Halopsychidae*. No branchia; two long and branched buccal appendages. *Halopsyche*.

Tribe 3.—*PLEUROBRANCHIOMORPHA*. Two pairs of tentacles. Foot without parapodia; no pallial cavity, but always a single ctenidium situated on the right side between mantle and foot. Genital duct diallic, without open seminal groove; male and female apertures contiguous. Visceral commissure short, tendency to concentration of all ganglia in dorsal side of oesophagus.

Fam. 1.—*Tyloidiinidae*. Shell external and conical; anterior tentacles form a frontal veil; ctenidium extending only over right side; a distinct osphradium. *Tyloidiina*.

Fam. 2.—*Umbrellidae*. Shell external, conical, much flattened; anterior tentacles very small, and situated with the mouth in a notch of the foot below the head; ctenidium very large. *Umbrella*.

Fam. 3.—*Pleurobranchiidae*. Shell covered by mantle, or absent;

anterior tentacles form a frontal veil; mantle contains spicules. *Pleurobranchia*, *Berthella*, *Haliotinaella*, *Oscanius*, British. *Oscaniella*, *Oscaniopsis*, *Pleurobranchaea*.

Sub-order 2.—*NUDIBRANCHIA*. Shell absent in the adult; no ctenidium or osphradium. Body generally slug-like, and externally symmetrical. Visceral mass not marked off from the foot, except in *Hedyidae*. Dorsal respiratory appendages frequently present. Visceral commissure reduced; nervous system concentrated on dorsal side of oesophagus. Marine; generally carnivorous, and brightly coloured, affording many instances of protective resemblance.

Tribe 1.—*TRITONIOMORPHA*. Liver wholly or partially contained in the visceral mass. Anus lateral, on the right side. Usually two rows of ramified dorsal appendages. Genital duct dianlic; male and female apertures contiguous.

Fam. 1.—*Tritoniidae*. Anterior tentacles form a frontal veil; foot rather broad. *Tritonia*, British. *Marionia*.

Fam. 2.—*Scyllaciidae*. No anterior tentacles; dorsal appendages broad and foliaceous; foot very narrow; stomach with horny plates. *Scyllaea*, pelagic.

Fam. 3.—*Phyllitoidae*. No anterior tentacles, and no dorsal appendages; body laterally compressed, transparent; pelagic. *Phyllitoid*.

Fam. 4.—*Tethyidae*. Head broad, surrounded by a funnel-shaped velum or hood; no radula; dorsal appendages foliaceous. *Tethys*, *Melibe*.

Fam. 5.—*Dendronotidae*. Anterior tentacles forming a scalloped frontal veil; dorsal appendages and tentacles similarly ramified. *Dendronotus*, *Campaspe*.

Fam. 6.—*Bornellidae*. Dorsum furnished on either side with papillae, at the base of which are ramified appendages. *Bornella*.

Fam. 7.—*Lomanotidae*. Body flattened, the two dorsal borders prominent and foliaceous. *Lomanotus*, British.

Tribe 2.—*DORIDOMORPHA*. Body externally symmetrical; anus median, posterior, and generally dorsal, surrounded by ramified pallial appendages, constituting a secondary branchia. Liver not ramified in the integuments. Genital duct triaulic. Spicules present in the mantle.

Fam. 1.—*Polyceratidae*. A more or less prominent frontal

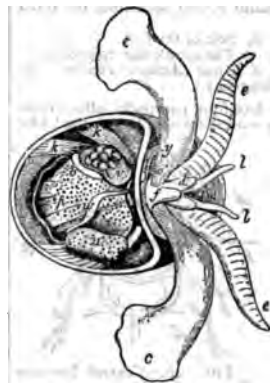

FIG. 53.—*Halopsyche gaudichaudii*, Soul. (From Owen.) Much enlarged; the body-wall removed.

- a, The mouth.
- c, The pteropodial lobes of the foot.
- f, The centrally-placed hind-foot.
- d, l, e, Three pairs of tentacle-like processes placed at the sides of the mouth, and developed (in all probability) from the fore-foot.
- o', Anus.
- y, Genital pore.
- k, Retractor muscles.
- o and p, The liver.
- s, v, Genitalia.

veil; branchiae non-retractile. *Euplocamus*, *Polycera*, British. *Thecacera*, British. *Aegirus*, British. *Placompherus*, *Polio*, *Crimora*, *Triopa*, British. *Triopella*.

Fam. 2.—*Goniodorididae*. Mantle-border projecting; frontal veil reduced, and often covered by the anterior border of the



FIG. 54.—*Anacis cristata*, one of the pygobranchiate Opisthobranchs (dorsal view). (From Gegenbaur, after Alder and Hancock.)

- a, Anus.
 - br, Secondary branchia surrounding the anus.
 - t, Cephalic tentacles.
- External to the branchia are seen ten club-like processes of the dorsal wall, these are the "cerata" which are characteristically developed in another sub-order of Opisthobranchs.

mante. *Geniodoris*, British. *Acanthodoris*, British. *Idalia*, British. *Ancula*, British. *Doridunculus*. *Lamelidoris*. *Ancylodoris*, the only fresh-water Nudibranch, from Lake Baikal.

Fam. 3.—*Heterodoriidae*. No branchia. *Heterodoris*.
Fam. 4.—*Dorididae*. Mantle oval, covering the head and the greater part of the body; anterior tentacles, ill-developed; branchiae generally retractile. *Doris*, British. *Hexabranchus*. *Chromodoris*.

Fam. 5.—*Doridopsidae*. Pharynx suctorial; no radula; branchial rosette on the dorsal surface, above the mantle-border. *Doridopsis*.

Fam. 6.—*Corambidae*. Anus and branchia posterior, below the mantle-border. *Corambe*.

Fam. 7.—*Phyllidiidae*. Pharynx suctorial; branchiae surrounding the body, between the mantle and foot. *Phyllidia*. *Frigeria*.

The last three families constitute the sub-tribe Porostomata, characterized by the reduction of the buccal mass, which is modified into a suctorial apparatus.

Tribe 3.—*EOLIDOMORPHA* (*Cladocarpica*). The whole of the liver contained in the integuments and tegumentary papillae. Genital duct dialytic; male and female apertures contiguous. The anus is antero-lateral, except in the *Proctonotidae*, in which it is median. Tegumentary papillae not ramified, and containing cnidosacs with nematocysts.

Fam. 1.—*Eolididae*. Dorsal papillae spindle-shaped or club-shaped. *Eolis*, British. *Facelina*, British. *Tergipes*, British. *Gonicolis*. *Cuthona*. *Embletonia*. *Galvina*. *Calma*. *Hera*.

Fam. 2.—*Glaucidae*. Body furnished with three pairs of lateral lobes, bearing the tegumentary papillae; foot very narrow; pelagic. *Glaucus*.

Fam. 3.—*Hedylidae*. Body elongated; visceral mass marked off from foot posteriorly; dorsal appendages absent, or reduced to a single pair; spicules in the integument. *Hedyle*.

Fam. 4.—*Pseudovermidae*. Head without tentacles; body elongated; anus on right side. *Pseudovermis*.

Fam. 5.—*Proctonotidae*. Anus posterior, median; anterior tentacles, atrophied; foot broad. *Janus*, British. *Proctonotus*, British.

Fam. 6.—*Dotonidae*. Bases of the rhinophores surrounded by a sheath; dorsal papillae tuberculated and club-shaped, in a single row on either side of the dorsum; no cnidosacs. *Doto*, British. *Gellina*. *Heromorpha*.

Fam. 7.—*Fionidae*. Dorsal papillae with a membranous expansion; male and female apertures at some distance from each other; pelagic. *Fiona*.

Fam. 8.—*Pleurophyllidae*. Anterior tentacles in the form of a digging shield; mantle without appendages, but respiratory papillae beneath the mantle-border. *Pleurophyllidia*.

Fam. 9.—*Dermatobranchidae*. Like the last, but wholly without branchiae. *Dermatobranchus*.

Tribe 4.—*ELYSIOMORPHA*. Liver ramifies in integuments and extends into dorsal papillae, but there are no cnidosacs. Genital duct always trialitic, and male and female apertures distant from each other. No mandibles, and radula uniserial. Never more than one pair of tentacles, and these are absent in *Alderia* and some species of *Limapontia*.

Fam. 1.—*Hermæidae*. Foot narrow; dorsal papillae linear or fusiform, in several series. *Hermæa*, British. *Siltiger*. *Alderia*, British.

Fam. 2.—*Phyllobranchidae*. Foot broad, dorsal papillae flattened and foliaceous. *Phyllobranchus*. *Cyerce*.

Fam. 3.—*Plakobranchidae*. Body depressed, without dorsal papillae, but with two very large lateral expansions, with dorsal plications. *Plakobranchus*.

Fam. 4.—*Elysiidae*. Body elongated, with lateral expansions; tentacles large; foot narrow. *Elysiæ*, British. *Trydactha*.

Fam. 5.—*Limapontidae*. No lateral expansions, and no dorsal papillae; body planariform; anus dorsal, median and posterior. *Limapontia*, British. *Acosmia*, British. *Cosia*.

Order 2 (of the Euthyneura).—*PULMONATA*. Euthyneurous Gastropoda, probably derived from ancestral forms similar to the

Tectibranchiate Opisthobranchia by adaptation to a terrestrial life. The ctenidium is atrophied, and the edge of the mantle-skirt is fused to the dorsal integument by concrescence, except at one point which forms the aperture of the mantle-chamber, thus converted into a nearly closed sac. Air is admitted to this sac for respiratory and hydrostatic purposes, and it thus becomes a lung. An operculum is present only in *Amphibola*; a contrast being thus afforded with the operculate pulmonate Streptoneura (*Cyclostoma*, &c.), which differ in other essential features of structure from the Pulmonata. The Pulmonata are, like the other Euthyneura, hermaphrodite, with elaborately developed copulatory organs and accessory glands. Like other Euthyneura, they have very numerous small denticles on the lingual ribbon. In aquatic Pulmonata the ophradium is retained.

In some Pulmonata (snails) the foot is extended at right angles to the visceral hump, which rises from it in the form of a coil as in Streptoneura; in others the visceral hump is not elevated, but is extended with the foot, and the shell is small or absent (slugs).

Pulmonata are widely distinguished from a small number of Streptoneura at one time associated with them on account of their mantle-chamber being converted, as in Pulmonata, into a lung, and the ctenidium or branchial plume aborted. The terrestrial Streptoneura (represented in England by the common genus *Cyclostoma*)



FIG. 56.—A Series of Stylommatophorous Pulmonata, showing transitional forms between snail and slug.

A, *Helix pomatia*. (From Kieferstein.)
B, *Helicophanta brempes*. (From Kieferstein, after Pfeiffer.)
C, *Testacella haliotidea*. (From Kieferstein.)
D, *Arion ater*, the great black slug. (From Kieferstein.)
a, Shell in A, B, C, shell-sac (closed) in D; b, orifice leading into the subpallial chamber (lung).

have a twisted visceral nerve-loop, an operculum on the foot, a complex rhipidoglossate or taenio-glossate radula, and are of distinct sexes. The Pulmonata have a straight visceral nerve-loop, usually no operculum even in the embryo, and a multidenticulate radula, the teeth being equi-formal; and they are hermaphrodite. Some Pulmonata (*Limnæa*, &c.) live in fresh waters although breathing air. The remarkable discovery has been made that in deep lakes such *Limnæa* do not breathe air, but admit water to the lung-sac and live at the bottom. The lung-sac serves undoubtedly as a hydrostatic apparatus in the aquatic Pulmonata, as well as assisting respiration.

The same general range of body-form is shown in Pulmonata as in the Heteropoda *fluviatilis*, a patellid and in the Opisthobranchia; at one extreme form aquatic Pulmonata have snails with coiled visceral hump, at monate.

the other cylindrical or flattened slugs (see fig. 56). Limpet-like forms are also found (fig. 57, *Ancylus*). The foot is always simple, with its flat crawling surface extending from end to end, but in the embryo *Limnæa* it shows a bilobed character, which leads on to the condition characteristic of Pteropoda.



FIG. 57.—*Ancylus fluviatilis*, a patellid and in the Opisthobranchia; at one extreme form aquatic Pulmonata have snails with coiled visceral hump, at monate.

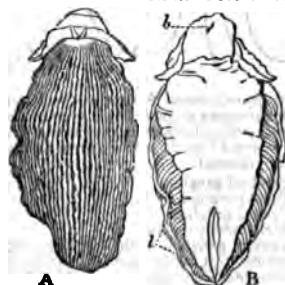

FIG. 55.—Dorsal and Ventral View of *Pleurophyllidia lineata* (Otto), one of the Eolidomorph Nudibranchs. (After Kieferstein.)
A, The mantle.
B, The mouth.
i, The lamelliform sub-pallial gills, which (as in Patella) replace the typical Molluscan ctenidium.

dorsal, median and posterior. *Limapontia*, British. *Acosmia*, British. *Cosia*.

The adaptation of the Pulmonata to terrestrial life has entailed little modification of the internal organization. In one genus (*Planorbis*) the plasma of the blood is coloured red by haemoglobin, this being the only instance of the presence of this body in the blood of Glossophorous Mollusca, though it occurs in corpuscles in the blood of the bivalves *Arca* and *Solen* (Lankester).

The generative apparatus of the snail (*Helix*) may serve as an example of the hermaphroditic apparatus common to the Pulmonata



FIG. 58.—Hermaphroditic Reproductive Apparatus of the Garden Snail (*Helix hortensis*).

- s, Ovo-testis.
 ed, Hermaphroditic duct.
 a, Albuminiferous gland.
 u, Uterine dilatation of the hermaphroditic duct.
 d, Digitate accessory glands on the female duct.
 ps, Calciferous gland or dart-sac on the female duct.
 Rf, Spermatheca or receptacle of the sperm in copulation, opening into the female duct.
 sd, Male duct (vas deferens).
 p, Penis.
 fl, Flagellum.

favourable, as an example on account of the fusion of the ganglia to form an almost uniform ring of nervous matter around the oesophagus. The pond-snail (*Limnaeus*) furnishes, on the other hand, a very beautiful case of distinct ganglia and connecting cords (fig. 59). The demonstration which it affords of the extreme shortening of the Euthyneurous visceral nerve-loop is most instructive and valuable for comparison with and explanation of the condition of the nervous centres in Cephalopoda, as also of some Opisthobranchia. The figure (fig. 59) is sufficiently described in the letterpress attached to it; the pair of buccal ganglia joined by the connectives to the cerebrals are, as in most of our figures, omitted. Here we need only further draw attention to the osphradium, discovered by Lacaze-Duthiers, and shown by Spengel to agree in its innervation with that organ in all other Gastropoda. On account of the shortness of the visceral loop and the proximity of the right visceral ganglion to the oesophageal nerve-ring, the nerve to the osphradium and olfactory ganglion is very long. The position of the osphradium corresponds more or less closely with that of the vanished right ctenidium, with which it is normally associated. In *Helix* and *Limax* the osphradium has not been described, and possibly its discovery might clear up the doubts which have been raised as to the nature of the mantle-chamber of those genera. In *Planorbis*, which is sinistral (as are a few other genera or exceptional varieties of various Anisopleurous Gastropods), instead of being dextral, the osphradium is on the left side, and receives its nerve from the left visceral ganglion, the whole series of unilateral organs being reversed. This is, as

might be expected, what is found to be the case in all "reversed" Gastropods.

The shell of the Pulmonata, though always light and delicate, is in many cases a well-developed spiral "house," into which the creature can withdraw itself; and, although the foot possesses no operculum, yet in *Helix* the aperture of the shell is closed in the winter by a complete lid, the "hybernaculum," more or less calcareous in nature, which is secreted by the foot. In *Clausilia* a peculiar modification of this lid exists permanently in the adult, attached by an elastic stalk to the mouth of the shell, and known as the "clausilium." In *Limnaeus* the permanent shell is preceded in the embryo by a well-marked shell-gland or primitive shell-sac (fig. 60), at one time supposed to be the developing anus, but shown by Lankester to be identical with the "shell-gland" discovered by him in other Mollusca (*Pisidium*, *Pleurobranchidium*, *Neritina*, &c.). As in other Gastropoda Anisopleura, this shell-sac may abnormally develop a plug of chitinous matter, but normally it flattens out and disappears, whilst the cap-like rudiment of the permanent shell is shed out from the dome-like surface of the visceral hump, in the centre of which the shell-sac existed for a brief period.

In *Clausilia*, according to the observations of C. Gegenbaur, the primitive shell-sac does not flatten out and disappear, but takes the form of a flattened closed sac. Within this closed sac a plate of calcareous matter is developed, and after a time the upper wall of the sac disappears, and the calcareous plate continues to grow as the nucleus of the permanent shell. In the slug *Tastocella* (fig. 56, C) the shell-plate never attains a large size, though naked. In other slugs, namely, *Limax* and *Arion*, the shell-sac remains permanently closed over the shell-plate, which in the latter genus consists of a granular mass of carbonate of lime. The permanence of the primitive shell-sac in these slugs is a point of considerable interest. It is clear enough that the sac is of a different origin from that of *Aplysia* (described in the section treating of Opisthobranchia), being primitive instead of secondary. It seems probable that it is identical with one of the open sacs in which each shell-plate of a *Chiton* is formed, and the series of plate-like imbrications which are placed behind the single shell-sac on the dorsum of the curious slug, *Plectrophorus*, suggest the possibility of the formation of a series of shell-sacs on the back of that animal similar to those which we find in *Chiton*. Whether the closed primitive shell-sac of the slugs (and with it the transient embryonic shell-gland of all other Mollusca) is precisely the same thing as the closed sac in which the calcareous pen or shell of the Cephalopod *Sepia* and its allies is formed,

is a further question which we shall consider when dealing with the Cephalopoda. It is important here to note that *Clausilia* furnishes us with an exceptional instance of the continuity of the shell or secreted product of the primitive shell-sac with the adult shell. In most other Mollusca (Anisopleurous Gastropods, Pteropods and Conchifera) there is a want of such continuity, the primitive shell-sac contributes no factor to the permanent shell, or only a very minute knob-like particle (*Neritina* and *Paludina*). It flattens out and disappears before the work of forming the permanent shell commences. And just as there is a break at this stage, so (as observed by A. Krohn in *Marsena* = *Echino-spira*) there may be a break at a later stage, the nautiloid shell formed on the larva being cast, and a new shell of a different form being formed afresh on

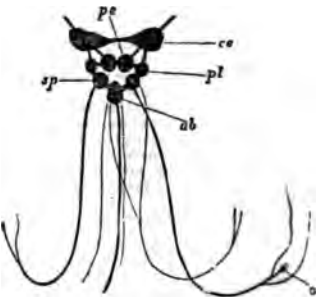

FIG. 59.—Nervous System of the Pond-Snail, *Limnaeus stagnalis*, as a type of the short-looped euthyneurous condition. The short visceral "loop" with its three ganglia is lightly-shaded.

pe, Cerebral ganglion.
 pe, Pedal ganglion.
 pl, Pleural ganglion.
 ab, Abdominal ganglion.
 sp, Visceral ganglion of the left side; opposite to it is the visceral ganglion of the right side, which gives off the long nerve to the olfactory ganglion and osphradium o.

In *Planorbis* and in *Auricula* (Pulmonata, allied to *Limnaeus*) the olfactory organ is on the left side and receives its nerve from the left visceral ganglion. (After Spengel.)

the surface of the visceral hump. It is, then, in this sense that we may speak of primary, secondary and tertiary shells in Mollusca, recognising the fact that they may be merely phases fused by continuity of growth so as to form but one shell, or that in other cases they may be presented to us as separate individual things, in virtue of the non-development of the later phases, or in virtue of sudden changes in the activity of the mantle-surface causing the shedding

or disappearance of one phase of shell-formation before a later one is entered upon.

The development of the aquatic Pulmonata from the egg offers considerable facilities for study, and that of *Limnaeus* has been elucidated by E. R. Lankester, whilst H. Rabl has with remarkable skill applied the method of sections to the study of the minute embryos of *Planorbis*. The chief features in the development of *Limnaeus* are exhibited in fig. 60. There is not a very large amount of food-material present in the egg of this snail, and accordingly the cells resulting from division are not so unequal as in many other cases. The four cells first formed are of equal size, and then four smaller cells are formed by division of these four so as to lie at one end of the first four (the pole corresponding to that at which the "directive corpuscles" are extruded and remain). The smaller cells now divide and spread over the four larger cells; at the same time a space—the cleavage cavity or blastocoel—forms in the centre of the mulberry-like mass. Then the large cells recommence the process of division and sink into the hollow of the sphere, leaving an elongated groove, the blastopore, on the surface. The invaginated cells (derived from the division of the four big cells) form the endoderm or arch-enteron; the outer cells are the ectoderm. The blastopore now closes along the middle part of its course, which coincides

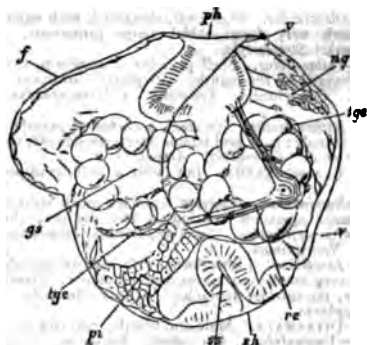

FIG. 60.—Embryo of *Limnaeus stagnalis*, at a stage when the Trochosphere is developing foot and shell-gland and becoming a Veliger, seen as a transparent object under slight pressure. (Lankester.)

ph, Pharynx (stomodaeal invagination).

v, v, The ciliated band marking out the velum.

ng, Cerebral nerve-ganglion.

re, Stiebel's canal (left side), probably an evanescent embryonic nephridium.

sh, The primitive shell-sac or shell-gland.

pi, The rectal peduncle or pedicle of invagination; its

attachment to the ectoderm is coincident with the hindmost extremity of the elongated blastopore of fig. 3, C.

gs, Mesoblastic (sketotrophic and muscular) cells investing gs, the bilobed arch-enteron or lateral vesicles of invaginated endoderm, which will develop into liver. The foot.

in position with the future "foot." One end of the blastopore becomes nearly closed, and an ingrowth of ectoderm takes place around it to form the stomodaeum or fore-gut and mouth. The other extreme end closes, but the invaginated endoderm cells remain in continuity with this extremity of the blastopore, and form the "rectal peduncle" or "pedicle of invagination" of Lankester, although the endoderm cells retain no contact with the middle region of the now closed-up blastopore. The anal opening forms at a late period by a very short ingrowth or proctodaeum coinciding with the blind termination of the rectal peduncle (fig. 60, p).

The body-cavity and the muscular, fibrous and vascular tissues are traced partly to two symmetrically disposed "mesoblasts," which bud off from the invaginated arch-enteron, partly to cells derived from the ectoderm, which at a very early stage is connected by long processes with the invaginated endoderm. The external form of the embryo goes through the same changes as in other Gastropods, and is not, as was held previously to Lankester's observations, exceptional. When the middle and hinder regions of the blastopore are closing in, an equatorial ridge of ciliated cells is formed, converting the embryo into a typical trochosphere.

The foot now protrudes below the mouth, and the post-oral hemisphere of the trochosphere grows more rapidly than the anterior or velar area. The young foot shows a bilobed form. Within the velar area the eyes and the cephalic tentacles commence to rise up, and on the surface of the post-oral region is formed a cap-like shell and an encircling ridge, which gradually increases in prominence and becomes the freely depending mantle-skirt. The outline of the velar

area becomes strongly emarginated and can be traced through the more mature embryos to the cephalic lobes or labial processes of the adult *Limnaeus* (fig. 61).

The increase of the visceral dome, its spiral twisting, and the gradual closure of the space overhung by the mantle-skirt so as to

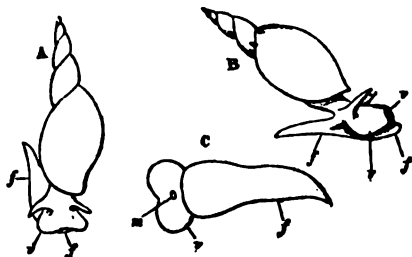

FIG. 61.—A, B, C. Three views of *Limnaeus stagnalis*, in order to show the persistence of the larval velar area v, as the circum-oral lobes of the adult. m, Mouth; f, foot; v, velar area, the margin v corresponding with the ciliated band which demarcates the velar area or velum of the embryo Gastropod (see fig. 4, D, E, F, H, I, v). (Original.)

convert it into a lung-sac with a small contractile aperture, belong to stages in the development later than any represented in our figures.

We may now revert briefly to the internal organization at a period when the trochosphere is beginning to show a prominent foot growing out from the area where the mid-region of the elongated blastopore was situated, and having therefore at one end of it the mouth and at the other the anus. Fig. 60 represents such an embryo under slight compression as seen by transmitted light. The ciliated band of the left side of the velar area is indicated by a line extending from v to v; the foot f is seen between the pharynx ph and the pedicle of invagination pi. The mass of the arch-enteron or invaginated endodermal sac has taken on a bilobed form, and its cells are swollen (gs and ige). This bilobed sac becomes entirely the liver in the adult; the intestine and stomach are formed from the pedicle of invagination, whilst the pharynx, oesophagus and crop form from the stomodaeal invagination ph. To the right (in the figure) is the rectal peduncle seen the deeply invaginated shell-gland sh, with a secretion sh protruding from it. The shell-gland is destined in *Limnaeus* to become very rapidly stretched out, and to disappear. Farther up, within the velar area, the rudiments of the cerebral nerve-ganglion ng are seen separating from the ectoderm. A remarkable cord of cells having a position just below the integument occurs on each side of the head. In the figure the cord of the left side is seen, marked re. This paired organ consists of a string of cells which are perforated by a duct opening to the exterior and ending internally in a flame-cell. Such canulated cells are characteristic of the nephridia of many worms, and the organs thus formed in the embryo *Limnaeus* are embryonic nephridia. The most important fact about them is that they disappear, and are in no way connected with the typical nephridium of the adult. In reference to their first observer they were formerly called "Stiebel's canals." Other Pulmonata possess, when embryos, Stiebel's canals in a more fully developed state, for instance, the common slug *Limax*. Here too they disappear during embryonic life. Similar larval nephridia occur in other Gastropods. In the marine Streptoneura they are ectodermic projections which ultimately fall off; in the Opisthobranchs they are closed pouches; in *Paludina* and *Bithynia* they are canals as in Pulmonata.

Marine Pulmonata.—Whilst the Pulmonata are essentially a terrestrial and fresh-water group, there is one genus of slug-like

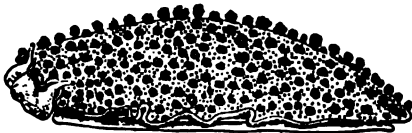

FIG. 62.—*Oncidium longanum*, a littoral Pulmonate, found on the shores of the Indian and Pacific Oceans (Mauritius, Japan).

Pulmonata which frequent the sea-coast (*Oncidium*, fig. 62). Karl Semper has shown that these slugs have, in addition to the usual pair of cephalic eyes, a number of eyes developed upon the dorsal integument. These dorsal eyes are very perfect in elaboration, possessing lens, retinal nerve-end cells, retinal pigment and optic nerve. Curiously enough, however, they differ from the cephalic Molluscan eye in the fact that, as in the vertebrate eye, the filaments of the optic nerve penetrate the retina, and are connected with the

surfaces of the nerve-end cells nearer the lens instead of with the opposite end. The significance of this arrangement is not known, but it is important to note, as shown by V. Henson, S. J. Hickson and others, that in the bivalves *Pecten* and *Spondylus*, which also have eyes upon the mantle quite distinct from typical cephalic eyes, there is the same relationship as in Oncididae of the optic nerve to the retinal cells. In both Oncididae and *Pecten* the pallial eyes have probably been developed by the modification of tentacles, such as coexist in an unmodified form with the eyes. The Oncididae are, according to K. Semper, pursued as food by the leaping fish *Periophthalmus*, and the dorsal eyes are of especial value to them in aiding them to escape from this enemy.

Sub-order 1.—**BASOMMATOPHORA.** Pulmonata with an external shell. The head bears a single pair of contractile but not invaginable tentacles, at the base of which are the eyes. Penis at some distance from the female aperture, except in *Amphibola* and *Siphonaria*. All have an osphradium, except the *Auriculidae*, which are terrestrial, and it is situated outside the pallial cavity in those forms in which water is not admitted into the lung. There is a veliger stage in development, but the velum is reduced.

Fam. 1.—*Auriculidae*. Terrestrial and usually littoral; genital duct monalike, the penis being connected with the aperture by an open or closed groove; shell with a prominent spire, the internal partitions often absorbed and the aperture denticulated. *Auricula*, *Cassidula*, *Alexis*, *Melampus*, *Carychium*, terrestrial, British. *Scarabus*, *Leucocina*, British. *Blauweria*, *Pedipes*.

Fam. 2.—*Olinidae*. Shell with short spire, and wide oval aperture; tentacles short. *Otina*, British. *Camponyx*, terrestrial.

Fam. 3.—*Amphibolidae*. Shell spirally coiled; head broad, without prominent tentacles; foot short, operculated; marine. *Amphibola*.

Fam. 4.—*Siphonariidae*. Visceral mass and shell conical; tentacles atrophied; head expanded; genital apertures contiguous; marine animals, with an aquatic pallial cavity containing secondary branchial laminae. *Siphonaria*.

Fam. 5.—*Gadinidae*. Visceral mass and shell conical; head flattened; pallial cavity aquatic, but without a branchia; genital apertures separated. *Gadina*.

Fam. 6.—*Chiliniidae*. Shell ovoid, with short spire, wide aperture and folded columella; inferior pallial lobe thick; visceral commissure still twisted. *Chilina*.

Fam. 7.—*Limnaeidae*. Shell thin, dextral, with prominent spire and oval aperture; no inferior pallial lobe. *Limnaea*, British.

Fam. 8.—*Pompholytidae*. Shell dextral, hyperstrophic, animal sinistral. *Pompholyx*, *Choanophthalus*.

Fam. 9.—*Planorbidae*. Visceral mass and shell sinistral; inferior pallial lobe very prominent, and transformed into a branchia. *Planorbis*, British. *Bulinus*, *Miraxesta*.

Fam. 10.—*Ancylidae*. Shell conical, not spiral; inferior pallial lobe transformed into a branchia. *Ancylus*, British. *Lasia*, *Grandlachia*.

Fam. 11.—*Physidae*. Visceral mass and shell sinistral; shell thin, with narrow aperture; no inferior pallial lobe. *Physa*, British. *Aplexa*, British.

Sub-order 2.—**STYLOMMATOPHORA.** Pulmonata with two pairs of tentacles, except *Janellidae* and *Vertigo*; these tentacles are invaginable, and the eyes are borne on the summits of the posterior pair. Male and female genital apertures open into a common vestibule, except in *Vaginulidae* and *Oncididae*. Except in *Oncidium*, there is no longer a veliger stage in development.

Tribe 1.—**HOLOGNATHA.** Jaw simple, without a superior appendage.

Fam. 1.—*Seleniidae*. Radula with elongated and pointed teeth, like those of the Agnatha; a jaw present. *Plutonia*, *Triglochlamys*.

Fam. 2.—*Zonitidae*. Shell external, smooth, heliciform or flattened; radula with pointed marginal teeth. *Zonites*, British. *Ariophanta*, *Orpella*, *Vitina*, *Helicarian*.

Fam. 3.—*Limacidae*. Shell internal. *Limax*, British. *Parmacella*, *Urocylus*, *Parmarian*, *Amalia*, *Ariolimax*, *Mesolimax*, *Monochroma*, *Parolimax*, *Metalimax*.

Fam. 4.—*Philomyxidae*. No shell; mantle covers the whole surface of the body; radula with squarish teeth. *Philomyxus*.

Fam. 5.—*Ostracolethidae*. Shell largely chitinous, not spiral, its calcareous apex projecting through a small hole in the mantle. *Ostracoletha*.

Fam. 6.—*Arionidae*. Shell internal, or absent; mantle restricted to the anterior and middle part of the body; radula with squarish teeth. *Arion*, British. *Geomalacus*, *Ariolimax*, *Anadenus*.

Fam. 7.—*Halicidae*. Shell with medium spire, external or partly covered by the mantle; genital aperture below the right posterior tentacle; genital apparatus generally provided with a dart-sac and multilobed vesicles. *Halicis*, British. *Bulimus*, *Hemphillia*, *Berenidisa*, *Cochlostylo*, *Rhodax*.

Fam. 8.—*Endodontidae*. Shell external, spiral, generally ornamented with ribs; borders of aperture thin and not reflected; radula with square teeth; genital ducts without accessory

organs. *Endodonta*, *Punctum*, *Sphyradium*, *Laoma*, *Pyramidula*.

Fam. 9.—*Orthalicidae*. Shell external, ovoid, the last whorl swollen, aperture oval with a simple border; radular teeth in oblique rows. *Orthalicus*.

Fam. 10.—*Bulimulidae*. Jaw formed of folds imbricated externally and meeting at an acute angle near the base. *Bulimulus*, *Peliella*, *Amphibulimus*.

Fam. 11.—*Cylindrellidae*. Shell turriculated, with numerous whorls, the last more or less detached. *Cylindrella*.

Fam. 12.—*Pupidae*. Shell external, with elongated spire and numerous whorls, aperture generally narrow; male genital duct without multilobed vesicles. *Pupa*, British. *Eucalodium*, *Vertigo*, British. *Bulimulus*, British. *Clausilia*, British. *Bales*, *Zospeum*, *Megaspira*, *Strophia*, *Anostoma*.

Fam. 13.—*Stenogyridae*. Shell elongated, with a more or less obtuse summit; aperture with a simple border. *Achatina*, *Stenogyra*, *Ferussacia*, British. *Cionella*, *Caecilianella*, *Aseca*, *Opeas*.

Fam. 14.—*Heliciteridae*. Shell bulimoid, dextral or sinistral; radular teeth, expanded at their extremities and multicuspidate. *Heliciter*, *Tornatellina*.

Tribe 2.—**AGNATHA.** No jaws; teeth narrow and pointed; carnivorous.

Fam. 1.—*Oleacinidae*. Shell oval, elongated, with narrow aperture; neck very long; labial palps prominent. *Oleacius* (*Cloudina*), *Sirapostyla*.

Fam. 2.—*Testacellidae*. Shell globular or auriform, external or partly covered by the mantle. *Sireptaxis*, *Gibbulina*, *Arcepe*, *Rhytida*, *Daudebardia*, *Testicella*, *Chlamydothorus*, *Schizoglossa*.

Fam. 3.—*Rathouisiidae*. No shell, a carinated mantle covering the whole body; male and female apertures distant, the female near the anus. *Rathousia*, *Atopos*.

Tribe 3.—**ELASMOGNATHA.** Jaw with a well-developed dorsal appendage.

Fam. 1.—*Succineidae*. Anterior tentacles much reduced; male and female apertures contiguous but distinct; shell thin, spiral, with short spire. *Succinea*, British. *Homalonyx*, *Hyalimax*, *Neohyalimax*.

Fam. 2.—*Janellidae*. Limaciform, with internal rounded shell; mantle very small and triangular; pulmonary chamber with tracheae; no anterior tentacles. *Janella*, *Aurelicia*, *Aucilia*, *Triboniophorus*.

Tribe 4.—**DIUREMATA.** Male and female apertures distant.

Fam. 1.—*Vaginulidae*. No shell; limaciform; terrestrial; female aperture on right side in middle of body; anus posterior. *Vaginula*.

Fam. 2.—*Oncididae*. No shell; limaciform; littoral; female aperture posterior, near anus; a reduced pulmonary cavity with a distinct aperture. *Oncidium*, *Oncidiella*, British. *Peronia*.

AUTHORITIES.—L. Boutan, "La Cause principale de l'asymétrie des mollusques gastéropodes," *Arch. de zool. expér.* (3), vii. (1899); A. Lang, "Versuch einer Erklärung der Asymmetrie der Gastropoden," *Vierteljahrsschr. naturforsch. Gesellschafts*, Zürich, 36 (1892); A. Robert, "Recherches sur le développement des Troques," *Arch. de zool. expér.* (3), x. (1903); P. Pelseener, "Report on the Pteropoda," *Zool. Challenger Exped.* pts. lviii., lxx., lxxvi. (1887, 1888); P. Pelseener, "Protobranchiens aériens et Pulmonés branchifères," *Arch. de biol.* xiv. (1895); W. A. Herdman, "On the Structure and Functions of the Cerata or Dorsal Papillae in some Nudibranchiate Mollusca," *Quart. Journ. Mic. Sci.* (1892); J. T. Cunningham, "On the Structure and Relations of the Kidney in Aplysia," *Mitt. Zool. Stat. Neapel*, iv. (1883); Böhmig, "Zur feineren Anatomie von *Rhodope veranyi*, Kölliker," *Zeitschr. f. wiss. Zool.* vol. lvi. (1893).

TREATISES.—S. P. Woodward, *Manual of the Mollusca* (2nd ed., with appendix, London, 1869); E. Forbes and S. Hanley, *History of British Mollusca* (4 vols., London, 1853); Alder and Hancock, *Monograph of British Nudibranchiate Mollusca* (London, Roy. Society, 1845); P. Pelseener, *Mollusca. Treatise on Zool.*, edited by E. Ray Lankester, pt. v. (1906); E. Ray Lankester, "Mollusca," in 9th ed. of this Encyclopaedia, to which this article is much indebted. (J. T. C.)

GASTROTRICHA, a small group of fairly uniform animals which live among Rotifers and Protozoa at the bottom of ponds and marshes, hiding amongst the recesses of the algae and sphagnum and other fresh-water plants and eating organic debris and Infusoria. They are of minute size varying from one-sixtieth to one-three-hundredth of an inch, and they move by means of long cilia. Two ventral bands composed of regular transverse rows of cilia are usually found. The head bears some especially large cilia. The cuticle which covers the body is here and there raised into overlapping scales which may be prolonged into bristles. An enlarged, frontal scale may cover the head, and a row of scales separates the ventral ciliated areas from one

another, whilst two series of alternating rows cover the back and side. The body, otherwise circular in section, is slightly flattened ventrally. The mouth is anterior and slightly ventral; it leads into a protrusible pharynx armed with recurved teeth that can be everted. This leads to a muscular oesophagus with a tripartite lumen, which acts as a sucking pump and ends in a funnel-valve projecting into the stomach. The last named is oval and formed of four rows of large cells; it is separated by a sphincter from the rectum, which opens posteriorly and dorsally. The nitrogenous excretory apparatus consists of a coiled tube on each side of the stomach; internally the tubes end in large flame-cells, and externally by small pores which lie on the edges of the ventral row of scales. A cerebral ganglion rests on the oesophagus and supplies the cephalic cilia and hairs; it is continued some way back as two dorsal nerve trunks. The sense organs are the hairs and bristles and in some species eyes. The muscles are simple and unstriated and for the most part run longitudinally.

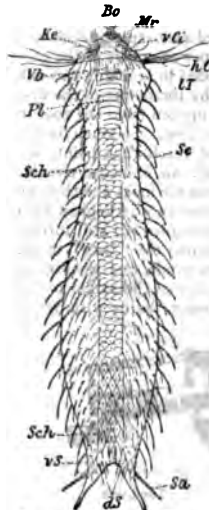

From *Zeitschrift für Wissenschaftliche Zoologie*, vol. xlix, p. 209, by permission of Wilhelm Engelmann.

Chaetonotus maximus, Ehrb., ventral side. (After Zelinka.)

- Bo, Bristles surrounding the mouth.
 ds, Dorsal bristles.
 hCi, Posterior lateral cilia.
 Ke, Cuticular dome.
 Mr, Oral cavity.
 IT, Lateral sensory hairs.
 Pf, Cuticular plates.
 Sa, Dorsal bristle of the basal part.
 Sch, Plates.
 Se, Lateral bristles.
 Vb, Part of union of ciliated tract.
 vCi, Anterior group of cilia.
 vS, Ventral bristles of the basal part.

The two ovaries lie at the level of the juncture of the stomach and rectum. The eggs become very large, sometimes half the length of the mother; they are laid amongst waterweeds. The male reproductive system is but little known, a small gland lying between the ovaries has been thought to be a testis, and if it be, the Gastrotricha are hermaphrodite.

Zelinka classifies the group as follows:—

Sub-order 1.—EUICHTHYDINA with a forked tail.

(i.) Fam. Ichthyidae, without bristles. Genera: *Ichthyidium*, *Lepidoderma*.

(ii.) Fam. Chaetonotidae, with bristles. Genera: *Chaetonotus*, *Chaetura*.

Sub-order 2.—AFODINA, tail not forked. Genera: *Dasydytes*, *Gossea*, *Stylochaeta*.

The genus *Aspidiophorus* recently described by Voigt seems in some respects intermediate between *Lepidoderma* and *Chaetonotus*.

Zelinkia and *Philosyllis* are two slightly aberrant forms described by Giard from certain diatomaceous sands. Altogether there must be some forty to fifty described species.

The group is an isolated one and shows no clear affinities with any of the other phyla. Those that are usually dwell on or are treated with the Rotifers and Nematoda and Turbellaria.

LITERATURE.—A. C. Stokes, *The Microscope* (Detroit, 1887-1888); C. Zelinka, *Zeitschr. wiss. Zool.* xlix., 1890, p. 209; M. Voigt, *Forschber. Plön.* Th. ix., 1904, p. 1; A. Giard, *C. R. Soc. Biol.* lvi., pp. 1061 and 1063; E. Daday, *Termes. Faulek.* xxiv. p. 1; F. Zschokke, *Denk. Schweiz. Ges.* xxxvii. p. 109; S. Hlava, *Zool. Anz.* xxviii., 1905, p. 331. (A. E. S.)

GATAKER, THOMAS (1574-1654), English divine, was born in London in September 1574, and educated at St John's College, Cambridge. From 1601 to 1611 he held the appointment of preacher to the society of Lincoln's Inn, which he resigned on accepting the rectory of Rotherhithe. In 1642 he was chosen a member of the assembly of divines at Westminster, and annotated for that assembly the books of Isaiah, Jeremiah and Lamentations. He disapproved of the introduction of the Covenant, and declared himself in favour of episcopacy. He was one of the forty-seven London clergymen who disapproved of the

trial of Charles I. He was married four times, and died in July 1654.

His principal works, besides some volumes of sermons are—*On the Nature and Use of Lots* (1619), a curious treatise which led to his being accused of favouring games of chance; *Dissertatio de stylo Novi Testamenti* (1648); *Cynus, sive Adversaria miscellanea, in quibus Sacrae Scripturae primo, deinde aliorum scriptorum, locis aliquam multis lux redditur* (1651), to which was afterwards subjoined *Adversaria Posthuma*; and his edition of *Marcus Antoninus* (1652), which, according to Hallam, is the "earliest edition of any classical writer published in England with original annotations," and, for the period at which it was written, possesses remarkable merit. His collected works were published at Utrecht in 1698.

GATCHINA, a town of Russia, in the government of St Petersburg, 20 m. by rail S. of the city of St Petersburg, in 59° 34' N. and 30° 6' E. Pop. (1860) 9184; (1897) 14,735. It is situated in a flat, well-wooded, and partly marshy district, and on the south side of the town are two lakes. Among its more important buildings are the imperial palace, which was founded in 1770 by Prince Orlov, and constructed according to the plans of the Italian architect Rinaldi; a military orphanage, founded in 1803; and a school for horticulture. Among the few industrial establishments is a porcelain factory. At Gatchina an alliance was concluded between Russia and Sweden on the 29th of October 1790.

GATE, an opening into any enclosure for entrance or exit, capable of being closed by a barrier at will. The word is of wide application, embracing not only the defensive entrance ways into a fortified place, with which this article mainly deals, or the imposing architectural features which form the main entrances to palaces, colleges, monastic buildings, &c., but also the common five-barred barrier which closes an opening into a field. The most general distinction that can be made between "door" and "gate" is that of size, the greater entrance into a court containing other buildings being the "gate," the smaller entrances opening directly into the particular buildings the "doors," or that of construction, the whole entrance way being a "gate" or gateway, the barrier which closes it a "door." A further distinction is drawn by applying "door" to the solid barriers or "valves" of wood, metal, &c., made in panels and fitted to a framework, and "gate" to an openwork structure, whether of metal or wood (see further **DOOR** and **METAL-WORK**). The ultimate origin of the word is obscure; the early forms appear with a palatalized initial letter, still surviving in such dialectical forms as "yate," or in Scots "yett." It is probably connected with the root of "get," in the sense either of "means of access" or of "holding," "receptacle"; cf. Dutch *gat*, hole. There may be a connexion, however, with "gate," now usually spelled "gait," a manner of walking,¹ but originally a way, passage; cf. Ger. *Gasse*, narrow street, lane.

The entrance through the enclosing walls of a city or fortification has been from the earliest times a place of the utmost importance, considered architecturally, socially or from the point of view of the military engineer. In the East the "gate" was and still is in many Mahomedan countries the central place of civic life. Here was the seat of justice and of audience, the most important market-place, the spot where men gathered to receive and exchange news. The references in the Bible to the gates of the city in all these varied aspects are innumerable (cf. Gen. xix. 1; Deut. xxv. 7; Ruth iv. 1; 2 Sam. xix. 8; 2 Kings vii. 1). Later the seat of justice and of government is transferred to the gate of the palace of the king (cf. Dan. ii. 49, and Esther ii. 19), and this use is preserved to-day in the official title of the seat of government of the Turkish empire at Constantinople, the "Sublime Porte," a translation of the Turkish *Bab Alîyî* (*bab*, gate, and *alîyî*, high). A full account with many modern instances of Eastern customs will be found in Sir Charles Warren's article "Gate" in

¹ The spelling "gait" is confined to this meaning—the only literary one surviving. In the form "gate" it appears dialectally in this sense and in such particular meanings as a right to run cattle on common or private ground or as a passage way in mines. The principal survival is in names of streets in the north and midlands of England and in Scotland, e.g. Briggate at Leeds, Wheeler Gate and Castle Gate at Nottingham, Gallow Tree Gate at Leicester, and Canongate and Cowgate at Edinburgh.

Hastings's *Dict. of Bible*. For the "pylon," the typical gate of Egyptian architecture, see ARCHITECTURE.

The gates into a walled town or other fortified place were necessarily in early times the chief points on which the attack concentrated, and the features, common throughout the ages, of flanking or surmounting towers and of galleries over the entrance way, are found in the Assyrian gate at Khorsabad (cf. 2 Chron. xxvi. 9; 2 Sam. xviii. 24). With the coming of peaceful times to a city or the removal of the fear of sudden attack, the gateways would take a form adapted more for ready exit and entrance than for defence, though the possibility of defending them was not forgotten. Such city gates often had separate openings for entrance and exit, and again for foot passengers and for vehicles. The Gallo-Roman gate at Autun has four entrances, two just wide enough to admit carriages, and two narrow alleys for foot passengers. A fine example of a Roman city gate, dating from the time of Constantine, is at Trèves. It is four storeys high, with ornamental windows, and decorated with columns on each storey. The two outer wings project beyond the central part, the two entrance ways are 14 ft. wide, and could be closed by doors and a portcullis. The chambers in the storeys above were used for the purposes of civil administration. In more modern times city gateways have often followed the type of the Roman triumphal arch, with a single wide opening and purely ornamental superstructure. On the other hand, the defensive gate formed by an archway entering as it were through a tower has been constantly followed as a type of entrance to buildings of an entirely peaceful character. A fine example of such a gateway, originally built for defence, is at Battle Abbey; this was built by Abbot Retlynge in 1338, when Edward III. granted a licence to fortify and crenellate the abbey. Such gateways are typical of Tudor palaces, as at St James's or at Hampton Court, and are the most common form in the colleges of Oxford and Cambridge. The Tom Gate at Christ Church, Oxford, with its surmounted domed bell tower, or the cupola resting on columns at Queen's College, Oxford, are further examples of the gate architecturally considered.

The changes the fortified gateway has undergone in construction and the varying relative importance it has held in the scheme of defence follow the lines of development taken by the history of FORTIFICATION AND SIEGECRAFT (q.v.). The following is a short sketch of the main stages in its history. A good example of the Roman fortified city gate still remains at Pompeii. Here there is one passage way for vehicles, 14 ft. wide; this is open to the sky. The two footways on either side are arched, with openings in the centre on to the central way. The doors of the gate are on the city side, but a portcullis (*cataracta*) closed it on the country side. The gateways of the Roman permanent camps (*castra stativa*) were four in number, the *porta praetoria* and *Decumana* at either end, with *principalis dextra* and *sinistra* on the side (see also CAMP). At Pevensey (*Anderida*) a small postern on the north side of the Roman walls was laid bare in 1906-1907, in which the passage curves in the thickness of the wall, and from a width admitting two men abreast narrows so that one alone could block it. Flanking towers or bastions guarded the main entrances, while in front were built outworks, of palisades, &c., to protect it; these were known as *pro-castra* or *antemuralia*, and the entrances to these were placed so that they could be flanked from the main walls.

In the defence of a fortified place the gate had not only to be protected from sudden surprise, but also had to undergo protracted attacks concentrated upon it during a siege. Thus until the coming of gunpowder, the ingenuity of military engineers was exhausted in accumulating the most complicated defences round the gateways, and the strength of a fortified place could be estimated by the fewness of its gates. Viollet-le-Duc (*Dict. de l'Arch. du moyen âge*, s.v. *Porte*) takes the Narbonne and Aude gates (E. and W.) of Carcassonne as typical instances of this complication. The following brief account of the Narbonne Gate (fig. 1), one of the principal parts of the work on the fortifications begun by Philip the Bold in 1285, will give some idea of the varied means of defence, which may be found individually if

not always in such collective abundance in the fortified gateways of the middle ages. Two massive towers flanked the actual entrance and were linked across by an iron chain; over the entrance (E) was a machicolation, further added to in time of war by a boarding of timber; and an outer portcullis fell in front of the heavy iron-lined doors. On to the passage way between the first and second doors opened a square machicolation (G) from which the defenders in the upper chambers of the gate could attack an enemy that had succeeded in breaking through the first entrance or had been trapped by the falling of the first portcullis. Another machicolation (I) opened from the roof in front of the second portcullis and second door. So much for the gate itself; but before an attack could reach that point, the following defences had to be passed: an immense circular barbican (A) protected the entrance across the moat and through the outer *enceinte* of the city. This entrance was flanked by a masked return of the wall (C), while palisades (P) still further hampered the assailant in his passage across the "lists" to the foot of the gate towers. Here sappers would find themselves exposed to a fire from the loopholes and from the machicolated boardings above them, while the projecting horns with which

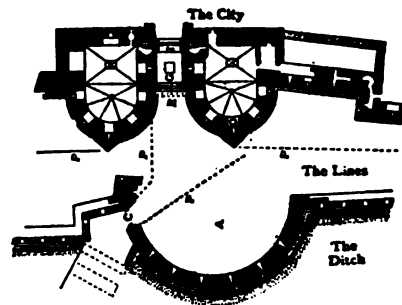

FIG. 1.—Plan of the Narbonne Gate of the city of Carcassonne.

the face of the towers terminated forced them to uncover themselves to a flanking fire from the indents in the main curtain on either side of the towers.

The later history of the gateway is merged in that of modern fortification. The more elaborate the gate defences the greater was the inducement for the besieger to attack the walls, and improvements in methods of siegcraft ultimately compelled the defender to develop the *enceinte* from its mediæval form of a ring wall with flanking towers to the 17th century form of bastions, curtains, tenailles and ravelins, all intimately connected in one general scheme of defence. By Vauban's time there is little to distinguish the position and defences of the gateways from the rest of the fortifications surrounding a town. A road from the country usually entered one of the ravelins, sinking into the glacis, crossing the ditch of the ravelin and piercing the parapet almost at right angles to its proper direction (see fig. 2, which also shows a typical arrangement of minor communications such as ramps and staircases). From the interior of the ravelin it passed across the main ditch to a gate in the curtain of the *enceinte*. The road was in fact artificially made to wind in such a way that it was kept under fire from the defences throughout, while the part of it inside the works was bent so as to place a covering mass between the enemy's fire and troops using the road for a sortie. Thus the gate itself was merely a barrier against a *coup de main* and to keep out unauthorized persons. In conditions precluding the making of a breach in the walls, i.e. in surprises and assaults *de vive force*, the gateway and accompanying drawbridge continue to play their part in the 16th, 17th and 18th centuries, but they seldom or never appear as the objectives of a siege *en règle*. In Vauban's works, and those of most other engineers, there was generally a postern giving access to the floor of the main ditch, in the centre of the curtain escarp. The gates of Vauban's and later fortresses are strong heavy wooden

doors, and the gateways more or less ornamental archways, exactly as in many private mansions of castellar form. In modern fortresses the gate of a detached fort or an *enceinte de surélé* is intended purely as a defence against an unexpected rush. The usual method is to have two gates, the outer one a lattice or portcullis of iron bars and the inner one a plate of half-inch steel armour, backed by wood and loopholed. The defenders of the gate can by this arrangement fire from the inner loopholes through the outer gate upon the approaches, and also keep the enemy under fire whilst he is trying to force the outer gate



Fig. 2.—Plan of Gate Arrangements of an 18th Century Fortress.

itself. The ditches are crossed either by drawbridges or by ramps leading the road down to the floor of the ditch.

The "gate" as a barrier to be removed and as an entrance to be passed is of constant occurrence in figurative language and in symbolical usage. The gates of the temple of Janus (*q.v.*) at Rome stood open in war and closed in peace. The *pylon* of ancient Egypt had a symbolical meaning in the Book of the Dead, and religious significance attaches to the *torii*, one of the outward signs of the Shinto religion in Japan, the Buddhist *toran*, and to the Chinese *pai-foo*, the honorific gateways erected to ancestors. The gates of heaven and hell, the gates of death and darkness, the wide and narrow gates that lead to destruction and life (Matt. vii. 13 and 14), are familiar metaphorical phrases in the Bible. In Greek and Roman legend dreams pass through gates of transparent horn if true, if deceptive and false through opaque gates of ivory (Hom. *Od.* xix. 560 sq.; Virg. *Aen.* vi. 893). (C. Ws.)

GATEHOUSE. In the second half of the 16th century in England the entrance gateway, which formed part of the principal front of the earlier feudal castles, became a detached feature attached to the mansions only by a wall enclosing the entrance court. The gatehouse then constituted a structure of some importance, and included sometimes many rooms as at Stanway Hall, Gloucestershire, where it measures 44 ft. by 22 ft. and has three storeys; at Westwood, Worcestershire, it had a frontage of 54 ft. with two storeys; and at Burton Agnes, Yorkshire, it was still larger and was flanked by great octagonal towers at the angles and had three storeys. At a later period smaller accommodation was provided so that it virtually became a lodge, but being designed to harmonize with the mansion it presented sometimes a monumental structure. On the continent of Europe the gatehouse forms a much more important building, as it formed part of the town fortifications, where it sometimes defended the passage of a bridge across the stream or moat. There are numerous examples in France and Germany.

GATES, HORATIO (1728-1806), American general, was born at Maldon in Essex, England, in 1728. He entered the English army at an early age, and was rapidly promoted. He accompanied General Braddock in his disastrous expedition against Fort Duquesne in 1755, and was severely wounded in the battle of July 9; and he saw other active service in the Seven Years' War. After the peace of 1763 he purchased an estate in Virginia,

where he lived till the outbreak of the War of Independence in 1775, when he was named by Congress adjutant-general. In 1776 he was appointed to command the troops which had lately retreated from Canada, and in August 1777, as a result of a successful intrigue, was appointed to supersede General Philip Schuyler in command of the Northern Department. In the two battles of Saratoga (*q.v.*) his army defeated General Burgoyne, who, on the 17th of October, was forced to surrender his whole army. This success was, however, largely due to the previous manoeuvres of Schuyler and to Gates's subordinate officers. The intrigues of the Conway Cabal to have Washington superseded by Gates completely failed, but Gates was president for a time of the Board of War, and in 1780 was placed in chief command in the South. He was totally defeated at Camden, S.C., by Cornwallis on the 17th of August 1780, and in December was superseded by Greene, though an investigation into his conduct terminated in acquittal (1782). He then retired to his Virginian estate, whence he removed to New York in 1790, after emancipating his slaves and providing for those who needed assistance. He died in New York on the 10th of April 1806.

GATESHEAD, a municipal, county and parliamentary borough of Durham, England; on the S. bank of the Tyne opposite Newcastle, and on the North Eastern railway. Pop. (1891) 85,692; (1901) 109,888. Though one of the largest towns in the county, neither its streets nor its public buildings, except perhaps its ecclesiastical buildings, have much claim to architectural beauty. The parish church of St Mary is an ancient cruciform edifice surmounted by a lofty tower; but extensive restoration was necessitated by a fire in 1854 which destroyed a considerable part of the town. The town-hall, public library and mechanic's institute are noteworthy buildings. Education is provided by a grammar school, a large day school for girls, and technical and art schools. There is a service of steam trams in the principal streets, and three fine bridges connect the town with Newcastle-upon-Tyne. There are large iron works (including foundries and factories for engines, boilers, chains and cables), shipbuilding yards, glass manufactories, chemical, soap and candle works, brick and tile works, breweries and tanneries. The town also contains a depot of the North Eastern railway, with large stores and locomotive works. Extensive coal mines exist in the vicinity; and at Gateshead Fell are large quarries for grindstones, which are much esteemed and are exported to all parts of the world. Large gas-works of the Newcastle and Gateshead Gas Company are also situated in the borough. The parliamentary borough returns one member. The corporation consists of a mayor, 9 aldermen, and 27 councillors. Area, 3132 acres.

Gateshead (Gateshed) probably grew up during late Saxon times, the mention of the church there in which Bishop Walcher was murdered in 1080 being the first evidence of settlement. The borough probably obtained its charter during the following century, for Hugh de Puiset, bishop of Durham (1153-1195), confirmed to his burgesses similar rights to those of the burgesses of Newcastle, freedom of toll within the palatinate and other privileges. The bishop had a park here in 1348, and in 1438 Bishop Nevill appointed a keeper of the "tower." The position of the town led to a struggle with Newcastle over both fishing and trading rights. An inquisition of 1322 declared that the water of the Tyne was divided into three parts: the northern, belonging to Northumberland; the southern to Durham; and the central, common to all. At another inquisition held in 1336 the men of Gateshead claimed liberty of trading and fishing along the coast of Durham, and freedom to sell their fish where they would. In 1552, on the temporary extinction of the diocese of Durham, Gateshead was attached to Newcastle, but in 1554 was re-granted to Bishop Tunstall. As compensation the bishop granted to Newcastle, at a nominal rent, the Gateshead salt-meadows, with rights of way to the High Street, thus abolishing the toll previously paid to the bishop. During the next century Bishop Tunstall's successors incorporated nearly all the various trades of Gateshead, and Cromwell continued this policy. The town government during this period was by

the bishop's bailiff, and the holders of the burgages composed the juries of the bishop's courts leet and baron. No charter of incorporation is extant, but in 1563 contests were carried on under the name of the bailiffs, burgesses and commonalty, and a list of borough accounts exists for 1696. The bishop appointed the last borough bailiff in 1681, and though the inhabitants in 1772 petitioned for a bailiff the town remained under a steward and grassmen until the 19th century. As part of the palatinate of Durham, Gateshead was not represented in parliament until 1832. At the inquisition of 1336 the burgesses claimed an annual fair on St Peter's Day, and dispositions in 1577 mention a borough market held on Tuesday and Friday, but these were apparently extinct in Camden's day, and no grant of them is extant. The medieval trade seems to have centred round the fisheries and the neighbouring coal mines which are mentioned in 1364 and also by Leland.

GATH, one of the five chief cities of the Philistines. It is frequently mentioned in the historical books of the Old Testament, and from Amos vi. 2 we conclude that, like Ashdod, it fell to Sargon in 711. Its site appears to have been known in the 4th century, but the name is now lost. Eusebius (in the *Onomasticon*) places it near the road from Eleutheropolis (Beit Jibrin) to Diospolis (Ludd) about five Roman miles from the former. The Roman road between these two towns is still traceable, and its milestones remain in places. East of the road at the required distance rises a white cliff, almost isolated, 300 ft. high and full of caves. On the top is the little mud village of Tell eš-Šāfi ("the shining mound"), and beside the village is the mound which marks the site of the Crusaders' castle of Blanchegarde (Alba Custodia), built in 1144. Tell eš-Šāfi was known by its present name as far back as the 12th century; but it appears not improbable that the strong site here existing represents the ancient Gath. The cliff stands on the south side of the mouth of the Valley of Elah, and Gath appears to have been near this valley (1 Sam. xvii. 2, 52). This identification is not certain, but it is at least much more probable than the theory which makes Gath, Eleutheropolis, and Beit Jibrin one and the same place. The site was partially excavated by the Palestine Exploration Fund in 1899, and remains extending in date back to the early Canaanite period were discovered.

GATLING, RICHARD JORDAN (1818-1903), American inventor, was born in Hertford county, North Carolina, on the 12th of September 1818. He was the son of a well-to-do planter and slave-owner, from whom he inherited a genius for mechanical invention and whom he assisted in the construction and perfecting of machines for sowing cotton seeds, and for thinning the plants. He was well educated and was successively a school teacher and a merchant, spending all his spare time in developing new inventions. In 1839 he perfected a practical screw propeller for steamboats, only to find that a patent had been granted to John Ericsson for a similar invention a few months earlier. He established himself in St Louis, Missouri, and taking the cotton-sowing machine as a basis he adapted it for sowing rice, wheat and other grains, and established factories for its manufacture. The introduction of these machines did much to revolutionize the agricultural system in the country. Becoming interested in the study of medicine through an attack of smallpox, he completed a course at the Ohio Medical College, taking his M.D. degree in 1850. In the same year he invented a hemp-breaking machine, and in 1857 a steam plough. At the outbreak of the Civil War he was living in Indianapolis, and devoted himself at once to the perfecting of fire-arms. In 1861 he conceived the idea of the rapid fire machine-gun which is associated with his name. By 1862 he had succeeded in perfecting a gun that would discharge 350 shots per minute; but the war was practically over before the Federal authorities consented to its official adoption. From that time, however, the success of the invention was assured, and within ten years it had been adopted by almost every civilized nation. Gatling died in New York City on the 26th of February 1903.

† **GATTY, MARGARET** (1809-1873), English writer, daughter of the Rev. Alexander Scott (1768-1840), chaplain to Lord Nelson,

was born at Burnham, Essex, in 1809. She early began to draw and to etch on copper, being a regular visitor to the print-room of the British Museum from the age of ten. She also illuminated on vellum, copying the old strawberry borders and designing initials. In 1839 Margaret Scott married the Rev. Alfred Gatty, D.D., vicar of Ecclesfield near Sheffield, subdean of York cathedral, and the author of various works both secular and religious. In 1842 she published in association with her husband a life of her father; but her first independent work was *The Fairy Godmother and other Tales*, which appeared in 1851. This was followed in 1855 by the first of five volumes of *Parables from Nature*, the last being published in 1871. It was under the *nom de plume* of Aunt Judy, as a pleasant and instructive writer for children, that Mrs Gatty was most widely known. Before starting *Aunt Judy's Magazine* in May 1866, she had brought out *Aunt Judy's Tales* (1858) and *Aunt Judy's Letters* (1862), and among the other children's books which she subsequently published were *Aunt Judy's Song Book for Children* and *The Mother's Book of Poetry*. "Aunt Judy" was the nickname given by her daughter Juliana Horatia Ewing (q.v.): The editor of the magazine was on the friendliest terms with her young correspondents and subscribers, and her success was largely due to the sympathy which enabled her to look at things from the child's point of view. Besides other excellences her children's books are specially characterized by wholesomeness of sentiment and cheerful humour. Her miscellaneous writings include, in addition to several volumes of tales, *The Old Folks from Home*, an account of a holiday ramble in Ireland; *The Travels and Adventures of Dr Wolff the Missionary* (1861), an autobiography edited by her; *British Sea Weeds* (1862); *Walls and Strays of Natural History* (1871); *A Book of Emblems* and *The Book of Sun-Dials* (1872). She died at Ecclesfield vicarage on the 4th of October 1873.

GAU, JOHN (c. 1495-? 1553), Scottish translator, was born at Perth towards the close of the 15th century. He was educated in St Salvator's College at St Andrews. He appears to have been in residence at Malmö in 1533, perhaps as chaplain to the Scots community there. In that year John Hochstraten, the exiled Antwerp printer, issued a book by Gau entitled: *The Richt way to the Kingdome of Hewine*, of which the chief interest is that it is the first Scottish book written on the side of the Reformers. It is a translation of Christiern Pedersen's *Den rechte vey till Hiemmerigis Rige* (Antwerp, 1531), for the most part direct, but showing intimate knowledge in places of the German edition of Urbanus Rhegius. Only one copy of Gau's text is extant, in the library of Britwell Court, Bucks. It has been assumed that all the copies were shipped from Malmö to Scotland, and that the cargo was intercepted by the Scottish officers on the look out for the heretical works which were printed abroad in large numbers. This may explain the silence of all the historians of the Reformed Church—Knox, Calderwood and Spottiswood. Gau married in 1536 a Malmö citizen's daughter, bearing the Christian name Birgitta. She died in 1551, and he in or about 1553.

The first reference to the *Richt Vay* appeared in Chalmers's *Caledonia*, ii. 616. Chalmers, who was the owner of the unique volume before it passed into the Britwell Court collection, considered it to be an original work. David Laing printed extracts for the Bannatyne Club (*Miscellany*, iii., 1855). The evidence that the book is a translation was first given by Sonnenstein Wendt in a paper "Om Reformatorerna i Malmö," in Rordam's *Ny Kirkehistoriske Samlinger*, ii. (Copenhagen, 1860). A complete edition was edited by A. F. Mitchell for the Scottish Text Society (1888). See also Lorimer's *Patrick Hamilton*.

GAUDEN, JOHN (1605-1662), English bishop and writer, reputed author of the *Eikon Basilike*, was born in 1605 at Mayland, Essex, where his father was vicar of the parish. Educated at Bury St Edmunds school and at St John's College, Cambridge, he took his M.A. degree in 1625/6. He married Elizabeth, daughter of Sir William Russell of Chippenham, Cambridgeshire, and was tutor at Oxford to two of his wife's brothers. He seems to have remained at Oxford until 1630, when he became vicar of Chippenham. His sympathies were at first with the parliamentary party. He was chaplain to Robert Rich, second earl of Warwick, and preached before the House of Commons in 1640.

In 1641 he was appointed to the rural deanery of Bocking. Apparently his views changed as the revolutionary tendency of the Presbyterian party became more pronounced, for in 1648/9 he addressed to Lord Fairfax *A Religious and Loyal Protestation* . . . against the proceedings of the parliament. Under the Commonwealth he faced both ways, keeping his ecclesiastical preferment, but publishing from time to time pamphlets on behalf of the Church of England. At the Restoration he was made bishop of Exeter. He immediately began to complain to Hyde, earl of Clarendon, of the poverty of the see, and based claims for a better benefice on a certain secret service, which he explained on the 20th of January 1661 to be the sole invention of the *Eikon Basilike*, *The Pourtraicture of his sacred Majestie in his Solitudes and Sufferings* put forth within a few hours after the execution of Charles I. as written by the king himself. To which Clarendon replied that he had been before acquainted with the secret and had often wished he had remained ignorant of it. Gauden was advanced in 1662, not as he had wished to the see of Winchester, but to Worcester. He died on the 23rd of May of the same year.

The evidence in favour of Gauden's authorship rests chiefly on his own assertions and those of his wife (who after his death sent to her son John a narrative of the claim), and on the fact that it was admitted by Clarendon, who could have had means of being acquainted with the truth. Gauden's letters on the subject are printed in the appendix to vol. iii. of the *Clarendon Papers*. The argument is that Gauden had prepared the book to inspire sympathy with the king by a representation of his pious and forgiving disposition, and so to rouse public opinion against his execution. In 1693 further correspondence between Gauden, Clarendon, the duke of York, and Sir Edward Nicholas was published by Mr Arthur North, who had found them among the papers of his sister-in-law, a daughter-in-law of Bishop Gauden; but doubt has been thrown on the authenticity of these papers. Gauden stated that he had begun the book in 1647 and was entirely responsible for it. But it is contended that the work was in existence at Naseby,¹ and testimony to Charles's authorship is brought forward from various witnesses who had seen Charles himself occupied with it at various times during his imprisonment. It is stated that the MS. was delivered by one of the king's agents to Edward Symmons, rector of Raine, near Bocking, and that it was in the handwriting of Oudart, Sir Edward Nicholas's secretary. The internal evidence has, as is usual in such cases, been brought forward as a conclusive argument in favour of both contentions. Doubt was thrown on Charles's authorship in Milton's *Eikonoklastes* (1649), which was followed almost immediately by a royalist answer, *The Princely Pelican. Royall Resolves—Extracted from his Majesty's Divine Meditations, with satisfactory reasons . . . that his Sacred Person was the only Author of them* (1649). The history of the whole controversy, which has been several times renewed, was dealt with in Christopher Wordsworth's tracts in a most exhaustive way. He eloquently advocated Charles's authorship. Since he wrote in 1820, some further evidence has been forthcoming in favour of the Naseby copy. A correspondence relating to the French translation of the work has also come to light among the papers of Sir Edward Nicholas. None of the letters show any doubt that King Charles was the author. S. R. Gardiner (*Hist. of the Great Civil War*, iv. 325) regards Mr Doble's articles in the *Academy* (May and June 1883) as finally disposing of Charles's claim to the authorship, but this is by no means the attitude of other recent writers. If Gauden was the author, he may have incorporated papers, &c., by Charles, who may have corrected the work and thus been joint-author. This theory would reconcile the conflicting evidence, that of those who saw Charles writing parts and read the MS. before publication, and the deliberate statements of Gauden.

See also the article by Richard Hooper in the *Dict. Nat. Biog.*; Christopher Wordsworth, *Who wrote Eikon Basilike?* two letters addressed to the archbishop of Canterbury (1822); and King Charles the First, the Author of *Icon Basilikè* (1828); H. J. Todd, *A Letter*

to the Archbishop of Canterbury concerning *Eikon Basilike* (1825); *Bishop Gauden. The Author of the Icon Basilikè* (1829); W. G. Broughton, *A Letter to a Friend* (1828), *Additional Reasons* . . . (1829), supporting the contention in favour of Dr Gauden; Mr E. J. L. Scott's introduction to his reprint (1880) of the original edition; articles in the *Academy*, May and June 1883, by Mr C. E. Doble; another reprint edited by Mr Edward Almack for the King's Classics (1904); and Edward Almack, *Bibliography of the King's Book* (1896). This last book contains a summary of the arguments on either side, a full bibliography of works on the subject, and facsimiles of the title pages, with full descriptions of the various extant copies.

GAUDICHAUD-BEAUPRÉ, CHARLES (1780-1854), French botanist, was born at Angoulême on the 4th of September 1789. He studied pharmacy first in the shop of a brother-in-law at Cognac, and then under P. J. Robiquet at Paris, where from R. L. Desfontaines and L. C. Richard he acquired a knowledge of botany. In April 1810 he was appointed dispenser in the military marine, and from July 1811 to the end of 1814 he served at Antwerp. In 1817 he joined the corvette "Uranie" as pharmaceutical botanist to the circumpolar expedition commanded by D. de Freycinet. The wreck of the vessel on the Falkland Isles, at the close of 1819, deprived him of more than half the botanical collections he had made in various parts of the world. In 1830-1833 he visited Chile, Peru and Brazil, and in 1836-1837 he acted as botanist to "La Bonite" during its circumnavigation of the globe. His theory accounting for the growth of plants by the supposed coalescence of elementary "phytons" involved him, during the latter years of his life, in much controversy with his fellow-botanists, more especially C. F. B. de Mirbel. He died in Paris on the 16th of January 1854.

Besides accounts of his voyages round the world, Gaudichaud-Beaupré wrote "Lettres sur l'organographie et la physiologie," *Arch. de botanique*, ii., 1883; "Recherches générales sur l'organographie," &c. (prize essay, 1835), *Mém. de l'Académie des Sciences*, t. viii. and kindred treatises, with memoirs on the potato-blight, the multiplication of bulbous plants, the increase in diameter of dicotyledonous plants, and other subjects; and *Réfutation de toutes les objections contre les nouveaux principes physiologiques* (1852).

GAUDRY, JEAN ALBERT (1827-1908), French geologist and palaeontologist, was born at St Germain-en-Laye on the 16th of September 1827, and was educated at the college, Stanislas. At the age of twenty-five he made explorations in Cyprus and Greece, residing in the latter country from 1855 to 1860. He then investigated the rich deposit of fossil vertebrata at Pikerini and brought to light a remarkable mammalian fauna, Miocene in age, and intermediate in its forms between European, Asiatic and African types. He also published an account of the geology of the island of Cyprus (*Mém. Soc. Géol. de France*, 1862). In 1853, while still in Cyprus, he was appointed assistant to A. d'Orbigny, who was the first to hold the chair of palaeontology in the museum of natural history at Paris. In 1872 he succeeded to this important post; in 1882 he was elected member of the Academy of Sciences; and in 1900 he presided over the meetings of the eighth International Congress of Geology then held in Paris. He died on the 27th of November 1908. He is distinguished for his researches on fossil mammalia, and for the support which his studies have rendered to the theory of evolution.

PUBLICATIONS.—*Animaux fossiles et géologie de l'Attique* (2 vols., 1864-1867); *Cours de paléontologie* (1873); *Animaux fossiles du Mont Leberon* (1873); *Les Enchaînements du monde animal dans les temps géologiques (Mammifères Tertiaires, 1878; Fossiles primaires, 1883; Fossiles secondaires, 1890); Essai de paléontologie philosophique* (1896). Brief memoir with portrait in *Geol. Mag.* (1903), p. 49. (H. B. W.)

GAUDY, an adjective meaning showy, very bright, gay, especially with a sense of tasteless or vulgar extravagance, of colour or ornament. The accurate origin of the various senses which this word and the substantive "gaud" have taken are somewhat difficult to trace. They are all ultimately to be referred to the Lat. *gaudere*, to rejoice, *gaudium*, joy, some of them directly, others to the French derivative *gaudir*, to rejoice, and O Fr. *gaudie*. As a noun, in the sense of rejoicing or feast, "gaudy" is still used of a commemoration dinner at a college at the university of Oxford. "Gaud," meaning generally a toy, a gay adornment, a piece of showy jewelry, is more specifically applied to larger and more decorative beads in a rosary.

¹ See a note in Archbishop Tenison's handwriting in his copy of the *Eikon Basilike* preserved at Lambeth Palace, and quoted in Almack's *Bibliography*, p. 15.

GAUERMANN, FRIEDRICH (1807-1862), Austrian painter, son of the landscape painter Jacob Gauermann (1773-1843), was born at Wiesenbach near Gutenstein in Lower Austria on the 20th of September 1807. It was the intention of his father that he should devote himself to agriculture, but the example of an elder brother, who, however, died early, fostered his inclination towards art. Under his father's direction he began studies in landscape, and he also diligently copied the works of the chief masters in animal painting which were contained in the academy and court library of Vienna. In the summer he made art tours in the districts of Styria, Tirol and Salzburg. Two animal pieces which he exhibited at the Vienna Exhibition of 1824 were regarded as remarkable productions for his years, and led to his receiving commissions in 1825 and 1826 from Prince Metternich and Caraman, the French ambassador. His reputation was greatly increased by his picture "The Storm," exhibited in 1829, and from that time his works were much sought after and obtained correspondingly high prices. His "Field Labourer" was regarded by many as the most noteworthy picture in the Vienna exhibition of 1834, and his numerous animal pieces have entitled him to a place in the first rank of painters of that class of subjects. The peculiarity of his pictures is the representation of human and animal figures in connexion with appropriate landscapes and in characteristic situations so as to manifest nature as a living whole, and he particularly excels in depicting the free life of animals in wild mountain scenery. Along with great mastery of the technicalities of his art, his works exhibit patient and keen observation, free and correct handling of details, and bold and clear colouring. He died at Vienna on the 7th of July 1862.

Many of his pictures have been engraved, and after his death a selection of fifty-three of his works was prepared for this purpose by the Austrian *Kunstverein* (Art Union).

GAUGE, or GAGE (Med. Lat. *gauge*, *jaugia*, Fr. *jauge*, perhaps connected with Fr. *jale*, a bowl, *galun*, gallon), a standard of measurement, and also the name given to various instruments and appliances by which measurement is effected. The word seems to have been primarily used in connexion with the process of ascertaining the contents of wine casks; the name gauger is still applied to certain custom-house officials in the United States, and in Scotland it means an exciseman. Thence it was extended to other measurements, and used of the instruments used in making them or of the standards to which they were referred. In the mechanical arts gauges are employed in great variety to enable the workmen to ascertain whether the object he is making is of the proper dimensions (see TOOL), and similar gauges of various forms are employed to ascertain and to specify the sizes of manufactured articles such as wire and screws. A rain gauge is an apparatus for measuring the amount of the rainfall at any locality, and a wind gauge indicates the pressure and force of the wind. The boilers of steam engines are provided with a water gauge and a steam or pressure gauge. The purpose of the former is to enable the attendant to see whether or not there is a sufficient quantity of water in the boiler. It consists of two cocks or taps communicating with the interior, one being placed at the lowest point to which it is permissible for the water to fall, and the other at the point above which it should not rise; a glass tube connects the two cocks, and when they are both open the water in this stands at the same level as in the boiler. The steam gauge shows the pressure of the steam in the boiler. One of the commonest forms, known as the Bourdon gauge, depends on the fact that a curved tube tends to straighten itself if the pressure within it is greater than that outside it. This gauge therefore consists of a curved or coiled tube of elastic material, and preferably of elliptic section, connected with the boiler and arranged with a multiplying gear so that its bending or unbending actuates a pointer moving over a graduated scale. If the pressure within the tube is less than that outside it, the tube tends to bend or coil itself up further; with a pointer arranged as before, the gauge then becomes a vacuum gauge, indicating how far the pressure in the vessel to which it is attached is below that of the atmosphere. In railway engineering the gauge of a line is the distance between the two rails (see RAILWAY). In nautical

language, a ship is said to have the weather gage when she is to windward of another, and similarly the lee gage when to leeward of another; in this sense the word is usually spelt "gage," a spelling which prevails in America for all senses.

GAUHATI, a town of British India, in the Kamrup district of Eastern Bengal and Assam, mainly on the left or south, but partly on the right bank of the Brahmaputra. Pop. (1901) 14,244. It is beautifully situated, with an amphitheatre of wooded hills to the south, but is not very healthy. There are many evidences, such as ancient earthworks and tanks, of its historical importance. During the 17th century it was taken and retaken by Mahomedans and Ahoms eight times in fifty years, but in 1681 it became the residence of the Ahom governor of lower Assam, and in 1786 the capital of the Ahom raja. On the cession of Assam to the British in 1826 it was made the seat of the British administration of Assam, and so continued till 1874, when the headquarters were removed to Shillong in the Khasi hills, 67 m. distant, with which Gauhati is connected by an excellent cart-road. Two much-frequented places of Hindu pilgrimage are situated in the immediate vicinity, the temple of Kamakhya on a hill 2 m. west of the town, and the rocky island of Umananda in the mid-channel of the Brahmaputra. Gauhati is still the headquarters of the district and of the Brahmaputra Valley division, though no longer a military cantonment. It is the river terminus of a section of the Assam-Bengal railway. There are a second-grade college, a government high school, a law class and a training school for masters. Gauhati is an important centre of river trade, and the largest seat of commerce in Assam. Cotton-ginning, flour-milling, and an export trade in mustard seed, cotton, silk, and forest produce are carried on. Gauhati suffered very severely from the earthquake of the 12th of June 1897.

GAUL, GILBERT WILLIAM (1855-), American artist, was born in Jersey City, New Jersey, on the 31st of March 1855. He was a pupil of J. G. Brown and L. E. Wilmarth, and he became a painter of military pictures, portraying incidents of the American Civil War. He was elected an associate of the National Academy of Design in 1880, and in 1882 a full academician, and in the latter year became a member of the Society of American Artists. His important works include: "Charging the Battery," "News from Home," "Cold Comfort on the Outpost," "Silenced," "On the Look-out," and "Guerillas returning from a Raid."

GAUL, the modern form of the Roman *Gallia*, the name of the two chief districts known to the Romans as inhabited by Celtic-speaking peoples, (a) *Gallia Cisalpina* (or *Citerior*, "Hither"), i.e. north Italy between Alps and Apennines and (b) the far more important *Gallia Transalpina* (or *Ulerior*, "Further"), usually called *Gallia* (Gaul) simply, the land bounded by the Alps, the Mediterranean, the Pyrenees, the Atlantic, the Rhine, i.e. modern France and Belgium with parts of Holland, Germany and Switzerland. The Greek form of *Gallia* was Γαλαρία, but *Galatia* in Latin denoted another Celtic region in central Asia Minor, sometimes styled *Gallagracia*.

(a) *Gallia Cisalpina* was mainly conquered by Rome by 222 B.C.; later it adopted Roman civilization; about 42 B.C. it was united with Italy and its subsequent history is merged in that of the peninsula. Its chief distinctions are that during the later Republic and earlier Empire it yielded excellent soldiers, and thus much aided the success of Caesar against Pompey and of Octavian against Antony, and that it gave Rome the poet Virgil (by origin a Celt), the historian Livy, the lyricist Catullus, Cornelius Nepos, the elder and the younger Pliny and other distinguished writers.¹

(b) Gaul proper first enters ancient history when the Greek colony of Massilia was founded (?600 B.C.). Roman armies began to enter it about 218 B.C. In 121 B.C. the coast from

¹ When Cisalpine Gaul became completely Romanized, it was often known as "Gallia Togata," while the Province was distinguished as "Gallia Braccata" (*bracae*, incorrectly *braccae*, "trousers"), from the long trousers worn by the inhabitants, and the rest of Gaul as "Gallia Comata," from the inhabitants wearing their hair long.

Montpellier to the Pyrenées (*i.e.* all that was not Massiliot) with its port of Narbo (mod. *Narbonne*) and its trade route by Toulouse to the Atlantic, was formed into the province of Gallia Narbonensis and Narbo itself into a Roman municipality. Commercial motives prompted the step, and Roman traders and land speculators speedily flocked in. Gradually the province was extended north of Massilia, up the Rhone, while the Greek town itself became weak and dependent on Rome.

It is not, however, until the middle of the 1st century B.C. that we have any detailed knowledge of pre-Roman Gaul. The earliest account is that contained in the *Commentaries* of Julius Caesar. According to this authority, Gaul was at that time divided among three peoples, more or less distinct from one another, the Aquitani, the Gauls, who called themselves Celts, and the Belgae. The first of these extended from the Pyrenées to the Garumna (Garonne); the second, from that river to the Sequana (Seine) and its chief tributary the Matrona (Marne), reaching eastward presumably as far as the Rhenus (Rhine); and the third, from this bounding line to the mouth of the last-named river, thus bordering on the Germans. By implication Caesar recognizes as a fourth division the province of Gallia Narbonensis. By far the greater part of the country was a plain watered by numerous rivers, the chief of which have already been mentioned, with the exception of its great central stream, the Liger or Ligeris (Loire). Its principal mountain ranges were Cebenna or Oebenna (Cévennes) in the south, and Jura, with its continuation Vosagus or Vogesus (Vosges), in the east. The tribes inhabiting Gaul in Caesar's time, and belonging to one or other of the three races distinguished by him, were numerous. Prominent among them, and dwelling in the division occupied by the Celts, were the Helvetii, the Sequani and the Aedui, in the basins of the Rhodanus and its tributary the Arar (Saône), who, he says, were reckoned the three most powerful nations in all Gaul; the Arverni in the mountains of Cebenna; the Senones and Carnutes in the basin of the Liger; the Veneti and other Armorican tribes between the mouths of the Liger and Sequana. The Nervii, Bellovaci, Suessiones, Remi, Morini, Menapii and Aduatuci were Belgic tribes; the Tarbelli and others were Aquitani; while the Allobroges inhabited the north of the Provincia, having been conquered in 121 B.C. The ethnological divisions thus set forth by Caesar have been much discussed (see *CELT*, and articles on the chief tribes).

The Gallic Wars (58-51) of Caesar (*g.v.*) added all the rest of Gaul, north-west of the Cévennes, to the Rhine and the Ocean, and in 49 also annexed Massilia. All Gaul was now Roman territory. Now the second period of her history opens; it remained for Roman territory to become romanized.

Caesar had no time to organize his conquest; this work was left to Augustus. As settled by him, and in part perhaps also by his successor Tiberius, it fell into the following five administrative areas.

(i) *Narbonensis*, that is, the land between Alps, sea and Cévennes, extending up the Rhone to Vienne, was as Augustus found it, distinct in many ways from the rest of Gaul. By nature it is a sun-steeped southern region, the home of the vine and olive, of the minstrelsy of the Provençal and the exuberance of Tartarin, distinct from the colder and more sober north. By history it had already (in the time of Augustus) been Roman for from 80 to 100 years and was familiar with Roman ways. It was ready to be Italianized and it was civilized enough to need no garrison. Accordingly, it was henceforward governed by a proconsul (appointed by the senate) and freed from the burden of troops, while its local government was assimilated to that of Italy. The old Celtic tribes were broken up; instead, municipalities of Roman citizens were founded to rule their territories. Thus the Allobroges now disappear and the *colonia* of Vienna takes their place; the Volcae vanish and we find Nemausus (Nîmes). Thus thrown into Italian fashion, the province took rapidly to Italian ways. By A.D. 70 it was "Italia verius quam provincia" (Pliny). The Gauls obviously had a natural bias towards the Italian civilization, and there soon became no difference between Italy and southern Gaul. But though educa-

tion spread, the results were somewhat disappointing. Trade flourished; the corporations of bargemen and the like on the Rhone made money; the many towns grew rich and could afford splendid public buildings. But no great writer and no great administrator came from Narbonensis; itinerant lecturers and journalists alone were produced in plenty, and at times minor poets.

(ii.-iv.) Across the Cévennes lay Caesar's conquests, Atlantic in climate, new to Roman ways. The whole area, often collectively styled "Gallia Comata," often "Tres Provinciae," was divided into three provinces, each under a *legatus pro praetore* appointed by the emperor, with a common capital at Lugudunum (Lyons). The three provinces were: *Aquilonia*, reaching from the Pyrenées almost to the Loire; *Lugdunensis*, the land between Loire and Seine, reaching from Brittany in the west to Lyons in the south-east; and *Belgica* in the north. The boundaries, it will be observed, were wholly artificial. Here also it was found possible to dispense with garrisons, not because the provinces were as peaceful as Narbonensis, but because the Rhine army was close at hand. As befitted an unromanized region, the local government was unlike that of Italy or Narbonensis. Roman municipalities were not indeed unknown, but very few; the local authorities were the magistrates of the old tribal districts. Local autonomy was here carried to an extreme. But the policy succeeded. The Gauls of the Three Provinces, or some of them, revolted in A.D. 21 under Florus and Sacrovir, in 68 under Vindex, and in 70 under Classicius and Tutor (see *CIVILIS*, *CLAUDIUS*). But all five leaders were romanized nobles, with Roman names and Roman citizenship, and their risings were directed rather against the Roman government than the Roman empire. In general, the Gauls of these provinces accepted Roman civilization more or less rapidly, and in due course became hardly distinguishable from the Italian. In particular, they eagerly accepted the worship of "Augustus and Rome," devised by the first emperor as a bond of state religion connecting the provinces with Rome. Each August, despite the heat, representatives from the 60 (or 64) tribes of Gallia Comata met at Lyons, elected a priest, "sacerdos ad aram Augusti et Romae," and held games. The post of representative, and still more that of priest, was eagerly coveted and provided a scope for the ambitions which despotism usually crushes. It agrees with the vigorous development of this worship that the Three Provinces, though romanized, retained their own local feeling. Even in the 3rd century the cult of Celtic deities (Hercules Magusanus, Deusonensis, &c.) were revived, the Celtic *leuga* reintroduced instead of the Roman mile on official milestones, and a brief effort made to establish an independent, though romanized, Gaul under Postumus and his short-lived successors (A.D. 259-273). Not only was the area too large and strong to lose its individuality: it was also too rural and too far from the Mediterranean to be romanized as fully and quickly as Narbonensis. It is even probable that Celtic was spoken in forest districts into the 4th century A.D. Town life, however, grew. The *chefs-lieux* of the tribes became practically, though not officially, municipalities, and many of these towns reached considerable size and magnificence of public buildings. But they attest their tribal relations by their appellations, which are commonly drawn from the name of the tribe and not of the town itself. Thus the capitals of the Remi and Parisii were actually Durocortorum and Lutetia: the appellations in use were Remis or Remus, Parisiis or Parisius—these forms being indeclinable nouns formed from a sort of locative of the tribe names. Literature also flourished. In the latest empire Ausonius, Symmachus, Apollinaris, Sidonius and other Gaulish writers, chiefly of Gallia Comata, kept alive the classical literary tradition, not only for Gaul but for the world.

(v.) The fifth division of Gaul was the Rhenish military frontier. Augustus had planned the conquest of Germany up to the Elbe. His plans were foiled by the courage of Arminius and the inability of the Roman exchequer to pay a larger army. Instead, his successor Tiberius organized the Rhine frontier in two military districts. The northern one was the valley of the Meuse and that of the Rhine to a point just south of Bonn: the southern was the rest of the Rhine valley to Switzerland. Each

district was garrisoned at first by four, later by fewer legions, which were disposed at various times in some of the following fortresses: Vetera (Xanten), Novesium (Neuss), Bonne (Bonn), Moguntiacum (Mainz), Argentorate (Strassburg) and Vindonissa (Windisch in Switzerland). At first the districts were purely military, were called, after the garrisons, "exercitus Germanicus superior" (south) and "inferior" (north). Later one or two municipalities were founded—Colonia Agrippinensis at Cologne (A.D. 51), Colonia Augusta Treverorum at Trier (date uncertain), Colonia Ulpia Traiana outside Vetera—and about 80-90 A.D. the two "Exercitus" were turned into the two provinces of Upper and Lower Germany. The armies in these districts formed the defence of Gaul against German invaders. They also helped to keep Gaul itself in order and their presence explains why the four provinces of Gaul proper contained no troops.

These provincial divisions were modified by Diocletian but without seriously affecting the life of Gaul. The whole country, indeed, continued Roman and fairly safe from barbarian invasions till after 400. In 407 a multitude of Franks, Vandals, &c., burst over Gaul. Roman rule practically ceased and the three kingdoms of the Visigoths, Burgundians and Franks began to form. There were still a Roman general and Roman troops when Attila was defeated in the *campi Catalaunici* in A.D. 451, but the general, Aetius, was "the last of the Romans," and in 486 Clovis the Frank ended the last vestige of Roman rule in Gaul.

For Roman antiquities in Gaul see, beside articles on the modern towns (ARLES, NÎMES, ORANGE, &c.), BÛBRACTE, ALESIA, ITIUS PORTUS, AQUEDUCT, ARCHITECTURE, AMPHITHEATRE, &c.; for religion see DRUIDISM; for the famous schools of Autun, Lyons, Toulouse, Nîmes, Vienne, Marseilles and Narbonne, see J. E. Sandys, *History of Classical Scholarship* (ed. 1906-1908), i. pp. 247-250; for the Roman provinces, Th. Mommsen, *Provinces of the Roman Empire* (trans. 1886), vol. i. chap. iii. See also Desjardins, *Géographie historique et administrative de la Gaule romaine* (Paris, 1877); Fustel de Coulanges, *Histoire des institutions politiques de l'ancienne France* (Paris, 1877); for Caesar's campaigns, article CÆSAR, JULIUS, and works quoted; for coins, art. NUMISMATICS and articles in the *Numismatische Zeitschrift* and *Revue numismatique* (e.g. Blanchet, 1907, pp. 461 foll.). (F. J. H.)

GAULT, in geology, one of the members of the Lower Cretaceous System. The name is still employed provincially in parts of England for a stiff blue clay of any kind; by the earlier writers it was sometimes spelt "Galt" or "Golt."

The formation now known as Gault in England has been variously designated "Blue Marl," "Brick Earth," "Golt Brick Earth" and "Oak-tree-soil." In certain parts of the south of England the Gault appears as a well-marked deposit of clay, lying between two sandy formations; the one above came to be known as the "Upper Greensand," the one below being the "Lower Greensand" (see GREENSAND). Since the typical clayey Gault is continually taking on a sandy facies as it is traced both horizontally and vertically; and since the fossils of the Upper Greensand and Gault are inseparably related, it has been proposed by A. J. Jukes-Browne that these two series of beds should be regarded as the arenaceous and argillaceous phases of a single formation, to which he has given the name "Selbornian" (from the village of Selborne where the beds are well developed). Lithologically, then, the Selbornian includes the blue and grey clays and marls of the Gault proper; the glauconitic sands of the Upper Greensand, and their local equivalent, the "malm," "malm rock" or "firestone," which in places passes into the micaceous sandstone containing sponge spicules and globules of silica, the counterpart of the rock called "gaize" on the same horizon in northern France. In Yorkshire, Lincolnshire and parts of Norfolk the Selbornian is represented by the Red Chalk. The malm is a ferruginous siliceous rock, the silica being mainly in the colloidal condition in the form of globules and sponge spicules; some quartz grains, mica and glauconite are usually present along with from 2 to 25% of calcareous matter. Chert-bands and nodules are common in the Upper Greensand of certain districts; and calcareous concretions, locally recognized as cowstones (Lyme Regis), doggers or buhrstones, are not infrequent.

The principal divisions of the Selbornian stage with their characteristic zonal fossils are as follows:—

Warminster Beds	<i>Pecten asper</i> and <i>Cardiaster fossarius</i> .
Upper Gault	Devizes Beds or Merstham Beds with <i>Schlotheimia rostratus</i> .
Lower Gault	{ <i>Hoplites laevis</i> , <i>H. interruptus</i> , <i>Acanthoceras mammillatum</i> .

The Gault (with Upper Greensand) crops out all round the Wealden area; it extends beneath the London basin and reappears from beneath the northern scarp of the Chalk along the foot of the Chiltern Hills to near Tring. In the south of England the Gault clay is fairly constant in the lower part, with the Greensand above; the clay, however, passes into sand as it is followed westward and, as already pointed out, the clay and sand appear to pass into a red chalk towards the north-east. The Gault overlaps the Lower Greensand towards the east, where it rests upon the old Paleozoic axis; it also overlaps the same formation towards the west about Frome, and thence passes unconformably across the Portlandian beds, Kimmeridge Clay, Corallian beds and Oxford Clay; in south Dorsetshire it rests upon the Wealden Series. The Gault (with Upper Greensand) passes on to the Jurassic and Rhaetic rocks near Axmouth, and oversteps farther westward, in the Haldon Hills, on to the Permian. A large outlier occurs on the Blackdown Hills of Devonshire. Good localities for fossils are Folkestone—where many of the shells are preserved with their original pearly nacre.—Burnham, Merstham, Huntstanton and Speeton, Black Venn near Lyme Regis, and Devizes (malmstone and gaize). The beds are well developed in the vale of Wardour, and in the Isle of Wight; the Gault forms the so-called "blue slipper" at Ventnor which has been the cause of the landslide or underlift.

The Gault of north France is very similar to that in the south of England, but the French term *Albien* includes only a portion of the Selbornian formation. The Gault of north-west Germany embraces beds that would be classed as *Albien* and *Aptian* by French authors; it comprises the "Flammenmergel"—a pale siliceous marl shot with flame-shaped darker patches—a clay with *Belonites minimus*, and the "Gargasmergel" (Aptian). In the Diester and Teutoburger Wald, and in the region of Halberstadt, the clays and marls are replaced by sandstones, the so-called *Gault-Quader*. Continental writers usually place the Gault or Albien at the summit of the Lower Cretaceous; while with English geologists the practice is to commence the Upper Cretaceous with this formation. In addition to the fossils already noticed, the following may be mentioned: *Acanthoceras Desmocerus Beudanti*, *Hoplites splendens*, *Hemias*, *Scaphites*, *Turritulus*, *Aporrhais retusa*, *Trigonis aliformis*, also *Ichthyosaurus* and *Ornithoceras* (Pterodactyl). From the clays, bricks and tiles are made at Burham, Barnwell, Dunton Green, Arlesey, Hitchin, &c. The cherts in the Greensand portion are used for road metal, and in the Blackdown Hills, for scythe stones; hearthstone is obtained about Merstham; phosphatic nodules occur at several horizons.

See CRETACEOUS SYSTEM; ALBIAN; APTIAN; also A. J. Jukes-Browne, "The Gault and Upper Greensand of England," vol. i., *Cretaceous Rocks of Britain*; *Mem. Geol. Surv.*, 1900.

GAUNTLET (a diminutive of the Fr. *gant*, glove), a large form of glove, and especially the steel-plated glove of mediæval armour. To "run the gauntlet," *i.e.* to run between two rows of men who, armed with sticks, rope-ends or other weapons, beat and strike at the person so running, was formerly a punishment for military and naval offences. It was abolished in the Prussian army by Scharnhorst. As a method of torturing prisoners, it was employed among the North American Indians. "Gauntlet" (earlier "gantlet") in this expression is a corruption of "gantlope," from a Swedish *gallope*, from *gata*, lane, and *legg*, a course (cf. Ger. *gassenlaufen*, to run the gauntlet). According to the *New English Dictionary* the word became familiar in England at the time of the Thirty Years' War.

GAUR, or LAKHNAUTI, a ruined city of British India, in Malda district of Eastern Bengal and Assam. The ruins are situated about 8 m. to the south of English Bazar, the civil station of the district of Malda, and on the eastern bank of the Bhagirathi, an old channel of the Ganges. It is said to have been founded by Lakshman, and its most ancient name was Lakshmanavati, corrupted into Lakhnauti. Its known history begins with its conquest in A.D. 1108 by the Mahommedans, who retained it as the chief seat of their power in Bengal for more than three centuries. When the Afghan kings of Bengal established their independence, they transferred their seat of government (about 1350) to Pandua (*q.v.*), also in Malda district, and to build their new capital they plundered Gaur of every monument that could be removed. When Pandua was in its turn deserted (A.D. 1453), Gaur once more became the capital under the

name of Jannatabad; it remained so as long as the Mahomedan kings retained their independence. In A.D. 1564 Sulaiman Kirani, a Pathan adventurer, abandoned it for Tanda, a place somewhat nearer the Ganges. Gaur was sacked by Sher Shah in 1539, and was occupied by Akbar's general in 1575, when Daud Shah, the last of the Afghan dynasty, refused to pay homage to the Mogul emperor. This occupation was followed by an outbreak of the plague, which completed the downfall of the city, and since then it has been little better than a heap of ruins, almost overgrown with jungle.

The city in its prime measured $7\frac{1}{2}$ m. from north to south, with a breadth of 1 to 2 m. With suburbs it covered an area of 20 to 30 sq. m., and in the 16th century the Portuguese historian Faria y Sousa described it as containing 1,200,000 inhabitants. The ramparts of this walled city, which was surrounded by extensive suburbs, still exist; they were works of vast labour, and were on the average about 40 ft. high, and 180 to 200 ft. thick at the base. The facing of masonry and the buildings with which they were covered have now disappeared, and the embankments themselves are overgrown with dense jungle. The western side of the city was washed by the Ganges, and within the space enclosed by these embankments and the river stood the city of Gaur proper, with the fort containing the palace in its south-west corner. Radiating north, south and east from the city, other embankments are to be traced running through the suburbs and extending in certain directions for 30 or 40 m. Surrounding the palace is an inner embankment of similar construction to that which surrounds the city, and even more overgrown with jungle. A deep moat protects it on the outside. To the north of the outer embankment lies the Sagar Dighi, a great reservoir, 1600 yds. by 800 yds., dating from A.D. 1126.

Fergusson in his *History of Eastern Architecture* thus describes the general architectural style of Gaur:—"It is neither like that of Delhi nor Jaunpore, nor any other style, but one purely local and not without considerable merit in itself; its principal characteristic being heavy short pillars of stone supporting pointed arches and vaults in brick—whereas at Jaunpore, for instance, light pillars carried horizontal architraves and flat ceilings." Owing to the lightness of the small, thin bricks, which were chiefly used in the making of Gaur, its buildings have not well withstood the ravages of time and the weather: while much of its enamelled work has been removed for the ornamentation of the surrounding cities of more modern origin. Moreover, the ruins long served as a quarry for the builders of neighbouring towns and villages, till in 1900 steps were taken for their preservation by the government. The finest ruin in Gaur is that of the Great Golden Mosque, also called Bara Darwaza, or twelve-doored (1526). An arched corridor running along the whole front of the original building is the principal portion now standing. There are eleven arches on either side of the corridor and one at each end of it, from which the mosque probably obtained its name. These arches are surmounted by eleven domes in fair preservation; the mosque had originally thirty-three.

The Small Golden or Eunuch's mosque, in the ancient suburb of Firozpur, has fine carving, and is faced with stone fairly well preserved. The Tantipara mosque (1475-1480) has beautiful moulding in brick, and the Lotan mosque of the same period is unique in retaining its glazed tiles. The citadel, of the Mahomedan period, was strongly fortified with a rampart and entered through a magnificent gateway called the Dakhil Darwaza (? 1459-1474). At the south-east corner was a palace, surrounded by a wall of brick 66 ft. high, of which a part is standing. Near by were the royal tombs. Within the citadel is the Kadam Rasul mosque (1530), which is still used, and close outside is a tall tower called the Firoz Minar (perhaps signifying "tower of victory"). There are a number of Mahomedan buildings on the banks of the Sagar Dighi, including, notably, the tomb of the saint Makhdum Shaikh Akbi Siraj (d. 1357), and in the neighbourhood is a burning ghat, traditionally the only one allowed to the use of the Hindus by their Mahomedan conquerors, and still greatly venerated and frequented by them.

Many inscriptions of historical importance have been found in the ruins.

See M. Martin (Buchanan Hamilton), *Eastern India*, vol. iii. (1831); G. H. Ravenshaw, *Gaur* (1878); James Fergusson, *History of Indian and Eastern Architecture* (1876); *Reports of the Archaeological Surveyor, Bengal Circle* (1900-1904).

GAUR, the native name of the wild ox, *Bos (Bibos) gaurus*, of India, mis-called bison by sportsmen. The gaur, which extends into Burma and the Malay Peninsula, where it is known as seladang, is the typical representative of an Indo-Malay group of wild cattle characterized by the presence of a ridge on the withers, the compressed horns, and the white legs. The gaur, which reaches a height of nearly 6 ft. at the shoulder, is specially characterized by the forward curve and great elevation of the ridge between the horns. The general colour is blackish-grey. Hill-forests are the resort of this species.

GAUSS, KARL FRIEDRICH (1777-1855), German mathematician, was born of humble parents at Brunswick on the 30th of April 1777, and was indebted for a liberal education to the notice which his talents procured him from the reigning duke. His name became widely known by the publication, in his twenty-fifth year (1801), of the *Disquisitiones arithmeticae*. In 1807 he was appointed director of the Göttingen observatory, an office which he retained to his death: it is said that he never slept away from under the roof of his observatory, except on one occasion, when he accepted an invitation from Baron von Humboldt to attend a meeting of natural philosophers at Berlin. In 1809 he published at Hamburg his *Theoria motus corporum coelestium*, a work which gave a powerful impulse to the true methods of astronomical observation; and his astronomical workings, observations, calculations of orbits of planets and comets, &c., are very numerous and valuable. He continued his labours in the theory of numbers and other analytical subjects, and communicated a long series of memoirs to the Royal Society of Sciences (*Königliche Gesellschaft der Wissenschaften*) at Göttingen. His first memoir on the theory of magnetism, *Intensitas vis magneticae terrestris ad mensuram absolutam revocata*, was published in 1833, and he shortly afterwards proceeded, in conjunction with Wilhelm Weber, to invent new apparatus for observing the earth's magnetism and its changes; the instruments devised by them were the declination instrument and the bifilar magnetometer. With Weber's assistance he erected in 1833 at Göttingen a magnetic observatory free from iron (as Humboldt and F. J. D. Arago had previously done on a smaller scale), where he made magnetic observations, and from this same observatory he sent telegraphic signals to the neighbouring town, thus showing the practicability of an electromagnetic telegraph. He further instituted an association (*Magnetischer Verein*), composed at first almost entirely of Germans, whose continuous observations on fixed term-days extended from Holland to Sicily. The volumes of their publication, *Resultate aus den Beobachtungen des magnetischen Vereins*, extend from 1836 to 1839; and in those for 1838 and 1839 are contained the two important memoirs by Gauss, *Allgemeine Theorie des Erdmagnetismus*, and the *Allgemeine Lehrsätze*—on the theory of forces attracting according to the inverse square of the distance. The instruments and methods thus due to him are substantially those employed in the magnetic observatories throughout the world. He co-operated in the Danish and Hanoverian measurements of an arc and trigonometrical operations (1821-1848), and wrote (1843, 1846) the two memoirs *Über Gegenstände der höheren Geodäsie*. Connected with observations in general we have (1812-1826) the memoir *Theoria combinationis observationum erroribus minimis obnoxia*, with a second part and a supplement. Another memoir of applied mathematics is the *Dioptrische Untersuchungen* (1840). Gauss was well versed in general literature and the chief languages of modern Europe, and was a member of nearly all the leading scientific societies in Europe. He died at Göttingen on the 23rd of February 1855. The centenary of his birth was celebrated (1877) at his native place, Brunswick.

Gauss's collected works were published by the Royal Society of Göttingen, in 7 vols. 4to (Gott., 1863-1871), edited by E. J. Schering.

—(1) the *Disquisitiones arithmeticae*, (2) *Theory of Numbers*, (3) *Analysis*, (4) *Geometry and Method of Least Squares*, (5) *Mathematical Physics*, (6) *Astronomy*, and (7) the *Theoria motus corporum coelestium*. Additional volumes have since been published, *Fundamenta der Geometrie usw.* (1900), and *Geodätische Nachträge zu Band iv.* (1903). They include, besides his various works and memoirs, notices by him of many of these, and of works of other authors in the *Göttingen gelehrte Anzeigen*, and a considerable amount of previously unpublished matter, *Nachlass*. Of the memoirs in pure mathematics, comprised for the most part in vols. ii., iii., and iv., (but to these must be added those on *Attractions* in vol. v.), it may be safely said there is not one which he not signally contributed to the progress of the branch of mathematics to which it belongs, or which would not require to be carefully analysed in a history of the subject. Running through these volumes in order, we have in the second the memoir, *Summatio quarundam serierum singularium*, the memoirs on the theory of biquadratic residues, in which the notion of complex numbers of the form $a+bi$ was first introduced into the theory of numbers; and included in the *Nachlass* are some valuable tables. That for the conversion of a fraction into decimals (giving the complete period for all the prime numbers up to 997) is a specimen of the extraordinary love which Gauss had for long arithmetical calculations, and the amount of work gone through in the construction of the table of the number of the classes of binary quadratic forms must also have been tremendous. In vol. iii. we have memoirs relating to the proof of the theorem that every numerical equation has a real or imaginary root, the memoir on the *Hypergeometric Series*, that on *Interpolation*, and the memoir *Determinatio attractionis*—in which a planetary mass is considered as distributed over its orbit according to the time in which each portion of the orbit is described, and the question (having an implied reference to the theory of secular perturbations) is to find the attraction of such a ring. In the solution the value of an elliptic function is found by means of the *arithmetico-geometrical mean*. The *Nachlass* contains further researches on this subject, and also researches (unfortunately very fragmentary) on the lemniscate-function, &c., showing that Gauss was, even before 1800, in possession of many of the discoveries which have made the names of N. H. Abel and K. G. J. Jacobi illustrious. In vol. iv. we have the memoir *Allgemeine Auflösung*, on the graphical representation of one surface upon another, and the *Disquisitiones generales circa superficies curvas*. (An account of the treatment of surfaces which he originated in this paper will be found in the article *SURFACE*.) And in vol. v. we have a memoir *On the Attraction of Homogeneous Ellipsoids*, and the already mentioned memoir *Allgemeine Lehrsatze*, on the theory of forces attracting according to the inverse square of the distance. (A. CA.)

GAUSSEN, FRANÇOIS SAMUEL ROBERT LOUIS (1790-1863), Swiss Protestant divine, was born at Geneva on the 25th of August 1790. His father, Georg Markus Gausen, a member of the council of two hundred, was descended from an old Languedoc family which had been scattered at the time of the religious persecutions in France. At the close of his university career at Geneva, Louis was in 1816 appointed pastor of the Swiss Reformed Church at Satigny near Geneva, where he formed intimate relations with J. E. Cellérier, who had preceded him in the pastorate, and also with the members of the dissenting congregation at Bourg-de-Four, which, together with the Église du témoignage, had been formed under the influence of the preaching of James and Robert Haldane in 1817. The Swiss revival was distasteful to the pastors of Geneva (*Vénérable Compagnie des Pasteurs*), and on the 7th of May 1817 they passed an ordinance hostile to it. As a protest against this ordinance, in 1819 Gausen published in conjunction with Cellérier a French translation of the Second Helvetic Confession, with a preface expounding the views he had reached upon the nature, use and necessity of confessions of faith, and in 1830, for having discarded the official catechism of his church as being insufficiently explicit on the divinity of Christ, original sin and the doctrines of grace, he was censured and suspended by his ecclesiastical superiors. In the following year he took part in the formation of a *Société Évangélique* (*Evangelische Gesellschaft*). When this society contemplated, among other objects, the establishment of a new theological college, he was finally deprived of his charge. After some time devoted to travel in Italy and England, he returned to Geneva and ministered to an independent congregation until 1834, when he joined Merle d'Aubigné as professor of systematic theology in the college which he had helped to found. This post he continued to occupy until 1857, when he retired from the active duties of the chair. He died at Les Grottes, Geneva, on the 18th of June 1863.

His best-known work, entitled *La Théopneustie ou pléne inspiration des saintes écritures*, an elaborate defence of the doctrine of "plenary inspiration," was originally published in Paris in 1840, and rapidly gained a wide popularity in France, as also, through translations, in England and America. It was followed in 1860 by a supplementary treatise on the canon (*Le Canon des saintes écritures au double point de vue de la science et de la foi*), which, though also popular, has hardly been so widely read.

See the article in Herzog-Hauck, *Realencyclopædie* (1899).

GAUTIER, ÉMILE THÉODORE LÉON (1832-1897), French literary historian, was born at Hâvre on the 8th of August 1832. He was educated at the École des Chartes, and became successively keeper of the archives of the department of Haute-Marne and of the imperial archives at Paris under the empire. In 1871 he became professor of palaeography at the École des Chartes. He was elected member of the Academy of Inscriptions in 1887, and became chief of the historical section of the national archives in 1893. Léon Gautier rendered great services to the study of early French literature, the most important of his numerous works on medieval subjects being a critical text (Tours, 1872) with translation and introduction of the *Chanson de Roland*, and *Les Épopées françaises* (3 vols., 1866-1867; 2nd ed., 5 vols., 1878-1897, including a *Bibliographie des chansons de geste*). He died in Paris on the 25th of August 1897.

GAUTIER, THÉOPHILE (1811-1872), French poet and miscellaneous writer, was born at Tarbes on the 31st of August 1811. He was educated at the grammar school of that town, and afterwards at the Collège Charlemagne in Paris, but was almost as much in the studios. He very early devoted himself to the study of the older French literature, especially that of the 16th and the early part of the 17th century. This study qualified him well to take part in the Romantic movement, and enabled him to astonish Sainte-Beuve by the phraseology and style of some literary essays which, when barely eighteen years old, he put into the critic's hands. In consequence of this introduction he at once came under the influence of the great Romantic *école*, to which, as to Victor Hugo in particular, he was also introduced by his gifted but ill-starred schoolmate Gérard de Nerval. With Gérard, Petrus Borel, Corot, and many other less known painters and poets whose personalities he has delightfully sketched in the articles collected under the titles of *Histoire du Romantisme*, &c., he formed a minor romantic clique who were distinguished for a time by the most extravagant eccentricity. A flaming crimson waistcoat and a great mass of waving hair were the outward signs which qualified Gautier for a chief rank among the enthusiastic devotees who attended the rehearsals of *Hervans* with red tickets marked "Hierro," performed mocking dances round the bust of Racine, and were at all times ready to exchange word or blow with the *perruques* and *grisettes* of the classical party. In Gautier's case these freaks were not inconsistent with real genius and real devotion to sound ideals of literature. He began (like Thackeray, to whom he presents in other ways some striking points of resemblance) as an artist, but soon found that his true powers lay in another direction.

His first considerable poem, *Albertus* (1830), displayed a good deal of the extravagant character which accompanied rather than marked the movement, but also gave evidence of uncommon command both of language and imagery, and in particular of a descriptive power hardly to be excelled. The promise thus given was more than fulfilled in his subsequent poetry, which, in consequence of its small bulk, may well be noticed at once and by anticipation. The *Comédie de la mort*, which appeared soon after (1832), is one of the most remarkable of French poems, and though never widely read has received the suffrage of every competent reader. Minor poems of various dates, published in 1840, display an almost unequalled command over poetical form, an advance even over *Albertus* in vigour, wealth and appropriateness of diction, and abundance of the special poetical essence. All these good gifts reached their climax in the *Émaux et camées*, first published in 1856, and again, with additions, just before the poet's death in 1872. These poems are in their own way such as

cannot be surpassed. Gautier's poetical work contains in little an expression of his literary peculiarities. There are, in addition to the peculiarities of style and diction already noticed, an extraordinary feeling and affection for beauty in art and nature, and a strange indifference to anything beyond this range, which has doubtless injured the popularity of his work.

But it was not, after all, as a poet that Gautier was to achieve either profit or fame. For the theatre, he had but little gift, and his dramatic efforts (if we except certain masques or ballets in which his exuberant and graceful fancy came into play) are by far his weakest. It was otherwise with his prose fiction. His first novel of any size, and in many respects his most remarkable work, was *Mademoiselle de Maupin* (1835). Unfortunately this book, while it establishes his literary reputation on an imperishable basis, was unfitted by its subject, and in parts by its treatment, for general perusal, and created, even in France, a prejudice against its author which he was very far from really deserving. During the years from 1833 onwards, his fertility in novels and tales was very great. *Les Jeunes-France* (1833), which may rank as a sort of prose *Albertus* in some ways, displays the follies of the youthful Romantics in a vein of humorous and at the same time half-pathetic satire. *Fortunio* (1838) perhaps belongs to the same class. *Jettatura*, written somewhat later, is less extravagant and more pathetic. A crowd of minor tales display the highest literary qualities, and rank with Mérimée's at the head of all contemporary works of the class. First of all must be mentioned the ghost-story of *La Mort amoureuse*, a gem of the most perfect workmanship. For many years Gautier continued to write novels. *La Belle Jenny* (1864) is a not very successful attempt to draw on his English experience, but the earlier *Militona* (1847) is a most charming picture of Spanish life. In *Spirite* (1866) he endeavoured to enlist the fancy of the day for supernatural manifestations, and a *Roman de la momie* (1856) is a learned study of ancient Egyptian ways. His most remarkable effort in this kind, towards the end of his life, was *Le Capitaine Fracasse* (1863), a novel, partly of the picaresque school, partly of that which Dumas was to make popular, projected nearly thirty years earlier, and before Dumas himself had taken to the style. This book contains some of the finest instances of his literary power.

Yet neither in poems nor in novels did the main occupation of Gautier as a literary man consist. He was early drawn to the more lucrative task of feuilleton-writing, and for more than thirty years he was among the most expert and successful practitioners of this art. Soon after the publication of *Mademoiselle de Maupin*, in which he had not been too polite to journalism, he became irrevocably a journalist. He was actually the editor of *L'Artiste* for a time: but his chief newspaper connexions were with *La Presse* from 1836 to 1854 and with the *Moniteur* later. His work was mainly theatrical and art criticism. The rest of his life was spent either at Paris or in travels of considerable extent to Spain, the Netherlands, Italy, Turkey, England, Algeria and Russia, all undertaken with a more or less definite purpose of book-making. Having absolutely no political opinions, he had no difficulty in accepting the Second Empire, and received from it considerable favours, in return for which, however, he in no way prostituted his pen, but remained a literary man pure and simple. He died on the 23rd of December 1872.

Accounts of his travels, criticisms of the theatrical and literary works of the day, obituary notices of his contemporaries and, above all, art criticism occupied him in turn. It has sometimes been deplored that this engagement in journalism should have diverted Gautier from the performance of more capital work in literature. Perhaps, however, this regret springs from a certain misconception. Gautier's power was literary power pure and simple, and it is as evident in his slightest sketches and criticisms as in *Émaux et camées* or *La Mort amoureuse*. On the other hand, his weakness, if he had a weakness, lay in his almost total indifference to the matters which usually supply subjects for art and therefore for literature. He has thus been accused of "lack of ideas" by those who have not cleared their own minds of cant; and in the recent set-back of the critical current against form and

in favour of "philosophic" treatment, comment upon him has sometimes been unfavourable. But this unjust will, beyond all question, be redressed again. He was neither immoral, irreligious nor unduly subservient to despotism, but morals, religion and politics (to which we may add science and material progress) were matters of no interest to him. He was to all intents a humanist, as the word was understood in the 19th century. But he was a humorist as well, and this combination, joined to his singularly kindly and genial nature, saved him from some dangers and deprivations as well as some absurdities to which the humanist temper is exposed. As time goes on it may be predicted that, though Gautier may not be widely read, yet his writings will never cease to be full of indescribable charm and of very definite instruction to men of letters. Besides those of his works which have been already cited, we may notice *Une Larme du diable* (1839), a charming mixture of humour and tenderness; *Les Grottes* (1844), a volume of early criticisms on some oddities of 17th-century literature; *Caprices et signés* (1845), miscellanies dealing in part with English life; *Voyage en Espagne* (1845), *Constantinople* (1854), *Voyage en Russie* (1866), brilliant volumes of travel; *Ménagerie intime* (1866) and *Tableaux de siège* (1872), his two latest works, which display his incomparable style in its quietest but not least happy form.

There is no complete edition of Gautier's works, and the vicomte Spoelberch de Lovenjoul's *Histoire des œuvres de Théophile Gautier* (1887) shows how formidable such an undertaking would be. But since his death numerous further collections of articles have been made: *Fusains et eaux-fortes et Tableaux à la plume* (1880); *L'Orient* (2 vols., 1881); *Les Vacances du lundi* (new ed., 1888); *La Nature chez elle* (new ed., 1891). In 1879 his son-in-law, E. Bergerat, who had married his younger daughter Estelle (the elder, Mme Judith Gautier—herself a writer of distinction—was at one time Mme Gatulle Mendès), issued a biography, *Théophile Gautier*, which has been often reprinted. With it should be compared Maxime du Camp's volume in the *Grands Écrivains français* (1890) and the numerous references in the *Journal des Goncourt*. Critical eulogues, from Sainte-Beuve (repeatedly in the *Causeries*) and Baudelaire (two articles in *L'Art romantique*) downwards, are numerous. The chief of the decifiers is Emile Faguet in his *Études littéraires sur le XIX^e siècle*. In 1902 and 1903 there appeared two respectable academic eulogies by H. Menal and H. Potez. (G. S.A.)

GAUTIER D'ARRAS, French *trouvère*, flourished in the second half of the 12th century. Nothing is known of his biography except what may be gleaned from his works. He dedicated his romance of *Éracle* to Theobald V., count of Blois (d. 1191); among his other patrons were Marie, countess of Champagne, daughter of Louis VII. and Eleanor of Guienne and Baldwin IV., count of Hainaut. *Éracle*, the hero of which becomes emperor of Constantinople as Heraclius, is purely a *roman d'aventures* and enjoyed great popularity. His second romance, *Ille et Galeron*, dedicated to Beatrix, the second wife of Frederick Barbarossa, treats of a similar situation to that outlined in the lay of "Éliduc" by Marie de France.

See the *Œuvres de Gautier d'Arras*, ed. E. Lösch (2 vols., Paris, 1890); *Hist. litt. de la France*, vol. xxii. (1852); A. Dinaux, *Les Trouvères* (1833-1843), vol. iii.

GAUZE, a light, transparent fabric, originally of silk, and now sometimes made of linen or cotton, woven in an open manner with very fine yarn. It is said to have been originally made at Gaza in Palestine, whence the name. Some of the gauzes from eastern Asia were brocaded with flowers of gold or silver. In the weaving of gauze the warp threads, in addition to being crossed as in plain weaving, are twisted in pairs from left to right and from right to left alternately, after each shot of weft, thereby keeping the weft threads at equal distances apart, and retaining them in their parallel position. The textures are woven either plain, striped or figured; and the material receives many designations, according to its appearance and the purposes to which it is devoted. A thin cotton fabric, woven in the same way, is known as leno, to distinguish it from muslin made by plain weaving. Silk gauze was a prominent and extensive industry in the west of Scotland during the second half of the 18th century, but on the introduction of cotton-weaving it greatly declined. In addition to its use for dress purposes silk gauze is much employed for bolting or sifting flour and other finely ground substances. The term gauze is applied generally

to transparent fabrics of whatever fibre made, and to the finest woven wire-cloth used in safety-lamps, sieves, window-blinds, &c.

GAVARNI, the name by which **SULPICE GUILLAUME CHEVALIER** (1801–1866), French caricaturist, is known. He is said to have taken the *nom de plume* from the place where he made his first published sketch. He was born in Paris of poor parents, and started in life as a workman in an engine-building factory. At the same time he attended the free school of drawing. In his first attempts to turn his abilities to some account he met with many disappointments, but was at last entrusted with the drawing of some illustrations for a journal of fashion. Gavarni was then thirty-four years of age. His sharp and witty pencil gave to these generally commonplace and unartistic figures a life-likeness and an expression which soon won for him a name in fashionable circles. Gradually he gave greater attention to this more congenial work, and finally ceased working as an engineer to become the director of the journal *Les Gens du monde*. His ambition rising in proportion to his success, Gavarni from this time followed the real bent of his inclination, and began a series of lithographed sketches, in which he portrayed the most striking characteristics, foibles and vices of the various classes of French society. The letterpress explanations attached to his drawings were always short, but were forcible and highly humorous, if sometimes trivial, and were admirably adapted to the particular subjects. The different stages through which Gavarni's talent passed, always elevating and refining itself, are well worth being noted. At first he confined himself to the study of Parisian manners, more especially those of the Parisian youth. To this vein belong *Les Lorettes*, *Les Actrices*, *Les Coulisées*, *Les Fashionables*, *Les Gentilshommes bourgeois*, *Les Artistes*, *Les Débardeurs*, *Clichy*, *Les Étudiants de Paris*, *Les Baliverneries parisiennes*, *Les Plaisirs champêtres*, *Les Bals masqués*, *Le Carnaval*, *Les Souvenirs du carnaval*, *Les Souvenirs du bal Chicard*, *La Vie des jeunes hommes*, *Les Palais de Paris*. He had now ceased to be director of *Les Gens du monde*; but he was engaged as ordinary caricaturist of *Le Charivari*, and, whilst making the fortune of the paper, he made his own. His name was exceedingly popular, and his illustrations for books were eagerly sought for by publishers. *Le Juif errant*, by Eugène Sue (1843, 4 vols. 8vo), the French translation of Hoffman's tales (1843, 8vo), the first collective edition of Balzac's works (Paris, Houssiaux, 1850, 20 vols. 8vo), *Le Diable à Paris* (1844–1846, 2 vols. 4to), *Les Français peints par eux-mêmes* (1840–1843, 9 vols. 8vo), the collection of *Physiologies* published by Aubert in 38 vols. 18mo (1840–1842).—all owed a great part of their success at the time, and are still sought for, on account of the clever and telling sketches contributed by Gavarni. A single frontispiece or vignette was sometimes enough to secure the sale of a new book. Always desiring to enlarge the field of his observations, Gavarni soon abandoned his once favourite topics. He no longer limited himself to such types as the *lorette* and the Parisian student, or to the description of the noisy and popular pleasures of the capital, but turned his mirror to the grotesque sides of family life and of humanity at large. *Les Enfants terribles*, *Les Parents terribles*, *Les Fourberies des femmes*, *La Politique des femmes*, *Les Maris vengés*, *Les Nuances du sentiment*, *Les Rêves*, *Les Petits Jeux de société*, *Les Petits Malheurs du bonheur*, *Les Impressions de ménage*, *Les Interjections*, *Les Traductions en langue vulgaire*, *Les Propas de Thomas Vireloque*, &c., were composed at this time, and are his most elevated productions. But whilst showing the same power of irony as his former works, enhanced by a deeper insight into human nature, they generally bear the stamp of a bitter and even sometimes gloomy philosophy. This tendency was still more strengthened by a visit to England in 1849. He returned from London deeply impressed with the scenes of misery and degradation which he had observed among the lower classes of that city. In the midst of the cheerful atmosphere of Paris he had been struck chiefly by the ridiculous aspects of vulgarity and vice, and he had laughed at them. But the debasement of human nature which he saw in London appears to have affected him so forcibly that from that time the cheerful caricaturist never laughed or made others laugh again. What he had

witnessed there became the almost exclusive subject of his drawings, as powerful, as impressive as ever, but better calculated to be appreciated by cultivated minds than by the public, which had in former years granted him so wide a popularity. Most of these last compositions appeared in the weekly paper *L'Illustration*. In 1857 he published in one volume the series entitled *Masques et visages* (1 vol. 12mo), and in 1860, about two years after his death, his last artistic work, *Les Douze Mois* (1 vol. fol.), was given to the world. Gavarni was much engaged, during the last period of his life, in scientific pursuits, and this fact must perhaps be connected with the great change which then took place in his manner as an artist. He sent several communications to the Académie des Sciences, and till his death on the 23rd of November 1866 he was eagerly interested in the question of aerial navigation. It is said that he made experiments on a large scale with a view to find the means of directing balloons; but it seems that he was not so successful in this line as his fellow-artist, the caricaturist and photographer, Nadar.

Gavarni's *Œuvres choisies* were edited in 1845 (4 vols. 4to) with letterpress by J. Janin, Th. Gautier and Balzac, followed in 1859 by two other volumes named *Perles et perures*; and some essays in prose and in verse written by him were collected by one of his biographers, Ch. Yriarte, and published in 1869. See also E. and J. de Goncourt, *Gavarni, l'homme et l'œuvre* (1873, 8vo). J. Clafetie has also devoted to the great French caricaturist a curious and interesting essay. A catalogue raisonné of Gavarni's works was published by J. Armelthaut and E. Bocher (Paris, 1873, 8vo).

GAVAZZI, ALESSANDRO (1809–1889), Italian preacher and patriot, was born at Bologna on the 21st of March 1809. He at first became a monk (1825), and attached himself to the Barnabites at Naples, where he afterwards (1829) acted as professor of rhetoric. In 1840, having already expressed liberal views, he was removed to Rome to fill a subordinate position. Leaving his own country after the capture of Rome by the French, he carried on a vigorous campaign against priests and Jesuits in England, Scotland and North America, partly by means of a periodical, the *Gavazzi Free Word*. While in England he gradually went over (1855) to the Evangelical church, and became head and organizer of the Italian Protestants in London. Returning to Italy in 1860, he served as army-chaplain with Garibaldi. In 1870 he became head of the Free Church (*Chiesa libera*) of Italy, united the scattered Congregations into the "Unione delle Chiese libere in Italia," and in 1875 founded in Rome the theological college of the Free Church, in which he himself taught dogmatics, apologetics and polemics. He died in Rome on the 9th of January 1889.

Amongst his publications are *No Union with Rome* (1871); *The Priest in Absolution* (1877); *My Recollections of the Last Four Popes*, &c., in answer to Cardinal Wiseman (1858); *Orationes*, 2 decades (1851).

GAVELKIND,¹ a peculiar system of tenure associated chiefly with the county of Kent, but found also in other parts of England. In Kent all land is presumed to be held by this tenure until the contrary is proved, but some lands have been disengaged by particular statutes. It is more correctly described as socage tenure, subject to the custom of gavelkind. The chief peculiarities of the custom are the following. (1) A tenant can alienate his lands by feoffment at fifteen years of age. (2) There is no escheat on attainder for felony, or as it is expressed in the old rhyme—

"The father to the bough,
The son to the plough."

(3) Generally the tenant could always dispose of his lands by will. (4) In case of intestacy the estate descends not to the eldest son but to all the sons (or, in the case of deceased sons, their representatives) in equal shares. "Every son is as great a gentleman as the eldest son is." It is to this remarkable peculiarity that gavelkind no doubt owes its local popularity. Though

¹ This word is generally taken to represent in O. Eng. *gafalgaynd*, from *gafol*, payment, tribute, and *gæcynd*, species, kind, and originally to have meant tenure by payment of rent or non-military services, cf. *gafol-land*, and thence to have been applied to the particular custom attached to such tenure in Kent. *Gafol* apparently is derived from the Teutonic root seen in "to give"; the Med. Lat. *gabulum*, *gabium* gives the Fr. *gabelle*, tax.

females claiming in their own right are postponed to males, yet by representation they may inherit together with them.

(5) A wife is dowerable of one-half, instead of one-third of the land.
 (6) A widower may be tenant by courtesy, without having had any issue, of one-half, but only so long as he remains unmarried. An act of 18 1, for commuting manorial rights in respect of lands of copyhold and customary tenure, contained a clause specially exempting from the operation of the act "the custom of gavelkind as the same now exists and prevails in the county of Kent." Gavelkind is one of the most interesting examples of the customary law of England; it was, previous to the Conquest, the general custom of the realm, but was then superseded by the feudal law of primogeniture. Its survival in this instance in one part of the country is regarded as a concession extorted from the Conqueror by the superior bravery of the men of Kent. *Irish gavelkind* was a species of tribal succession, by which the land, instead of being divided at the death of the holder amongst his sons, was thrown again into the common stock, and redivided among the surviving members of the sept. The equal division amongst children of an inheritance in land is of common occurrence outside the United Kingdom and is discussed under SUCCESSION.

See INHERITANCE; TENURE. Also Robinson, *On Gavelkind*; Digby, *History of the Law of Real Property*; Pollock and Maitland, *History of English Law*; Challis, *Real Property*.

GAVESTON, PIERES (d. 1312), earl of Cornwall, favourite of the English king Edward II., was the son of a Gascon knight, and was brought up at the court of Edward I. as companion to his son, the future king. Strong, talented and ambitious, Gaveston gained great influence over young Edward, and early in 1307 he was banished from England by the king; but he returned after the death of Edward I. a few months later, and at once became the chief adviser of Edward II. Made earl of Cornwall, he received both lands and money from the king, and added to his wealth and position by marrying Edward's niece, Margaret, daughter of Gilbert de Clare, earl of Gloucester (d. 1295). He was regent of the kingdom during the king's short absence in France in 1308, and took a very prominent part at Edward's coronation in February of this year. These proceedings aroused the anger and jealousy of the barons, and their wrath was diminished neither by Gaveston's superior skill at the tournament, nor by his haughty and arrogant behaviour to themselves. They demanded his banishment; and the king, forced to assent, sent his favourite to Ireland as lieutenant, where he remained for about a year. Returning to England in July 1309, Edward persuaded some of the barons to sanction this proceeding; but as Gaveston was more insolent than ever the old jealousies soon broke out afresh. In 1311 the king was forced to agree to the election of the "ordainers," and the ordinances they drew up provided *inter alia* for the perpetual banishment of his favourite. Gaveston then retired to Flanders, but returned secretly to England at the end of 1311. Soon he was publicly restored by Edward, and the barons had taken up arms. Deserted by the king he surrendered to Aymer de Valence, earl of Pembroke (d. 1324), at Scarborough in May 1312, and was taken to Deddington in Oxfordshire, where he was seized by Guy de Beauchamp, earl of Warwick (d. 1315). Conveyed to Warwick castle he was beheaded on Blacklow Hill near Warwick on the 19th of June 1312. Gaveston, whose body was buried in 1315 at King's Langley, left an only daughter.

See W. Stubbs, *Constitutional History*, vol. ii. (Oxford, 1896); and *Chronicles of the Reigns of Edward I. and Edward II.*, edited by W. Stubbs. Rolls series (London, 1887-1888).

GAVOTTE (a French word adopted from the Provençal *gavoto*), properly the dance of the Gavots or natives of Gap, a district in the Upper Alps, in the old province of Dauphiné. It is a dance of a brisk and lively character, somewhat resembling the minuet, but quicker and less stately (see DANCE); hence also the use of this name for a corresponding form of musical composition.

GAWAIN (Fr. *Wahwein* (*Brut*), *Gawain*, *Gaugain*; Lat. *Walganus*, *Walwanus*; Dutch, *Walwein*, Welsh, *Gwalchmei*), son of King Lotb of Orkney and nephew to Arthur on his

mother's side, the most famous hero of Arthurian romance. The first mention of his name is in a passage of William of Malmesbury, recording the discovery of his tomb in the province of Ros in Wales. He is there described as "*Walwen qui fuit hanc degener Arturis ex sorore nepos*." Here he is said to have reigned over Galloway; and there is certainly some connexion, the character of which is now not easy to determine, between the two. In the later *Historia* of Goeffrey of Monmouth, and its French translation by Wace, Gawain plays an important and "pseudo-historic" rôle. On the receipt by Arthur of the insulting message of the Roman emperor, demanding tribute, it is he who is despatched as ambassador to the enemy's camp, where his arrogant and insulting behaviour brings about the outbreak of hostilities. On receipt of the tidings of Mordred's treachery, Gawain accompanies Arthur to England, and is slain in the battle which ensues on their landing. Wace, however, evidently knew more of Gawain than he has included in his translation, for he speaks of him as

Li quens Walwains
 Qui tant fu preudom de ses mains (11. 9057-58).

and later on says

Prous fu et de mult grant mesure,
 D'orgoill et de forfait n'ot cure
 Plus vaut faire qu'il ne dist
 Et plus doer qu'il ne premist (10. 106-109).

The English Arthurian poems regard him as the type and model of chivalrous courtesy, "the fine father of nurture," and as Professor Maynadier has well remarked, "previous to the appearance of Malory's compilation it was Gawain rather than Arthur, who was the typical English hero." It is thus rather surprising to find that in the earliest preserved MSS. of Arthurian romance, *i.e.* in the poems of Chrétien de Troyes, Gawain, though generally placed first in the list of knights, is by no means the hero *par excellence*. The latter part of the *Pecheval* is indeed devoted to the recital of his adventures at the *Chastel Merveilleux*, but of none of Chrétien's poems is he the protagonist. The anonymous author of the *Chevalier à l'Épée* indeed makes this apparent neglect of Gawain a ground of reproach against Chrétien. At the same time the majority of the short episodic poems connected with the cycle have Gawain for their hero. In the earlier form of the prose romances, *e.g.* in the *Merlin* proper, Gawain is a dominant personality, his feats rivalling in importance those ascribed to Arthur, but in the later forms such as the *Merlin* continuations, the *Tristan*, and the final *Lancelot* compilation, his character and position have undergone a complete change, he is represented as cruel, cowardly and treacherous, and of indifferent moral character. Most unfortunately our English version of the romances, Malory's *Morte Artur*, being derived from these later forms (though his treatment of Gawain is by no means uniformly consistent), this unfavourable aspect is that under which the hero has become known to the modern reader. Tennyson, who only knew the Arthurian story through the medium of Malory, has, by exaggeration, largely contributed to this misunderstanding. Morris, in *The Defence of Guinevere*, speaks of "gloomy Gawain"; perhaps the most absurdly misleading epithet which could possibly have been applied to the "gay, gracious, and gude" knight of early English tradition.

The truth appears to be that Gawain, the Celtic and mythic origin of whose character was frankly admitted by the late M. Gaston Paris, belongs to the very earliest stage of Arthurian tradition, long antedating the crystallization of such tradition into literary form. He was certainly known in Italy at a very early date; Professor Rajna has found the names of Arthur and Gawain in charters of the early 12th century, the bearers of those names being then grown to manhood; and Gawain is figured in the architrave of the north doorway of Modena cathedral, a 12th-century building. Recent discoveries have made it practically certain that there existed, prior to the extant romances, a collection of short episodic poems, devoted to the glorification of Arthur's famous nephew and his immediate kin (his brother Ghaeris, or Gareth, and his son Guinglain), the authorship of which was attributed to a Welshman, Bleheris; fragments of this

collection have been preserved to us alike in the first continuation of Chrétien de Troyes *Perceval*, due to Wauchier de Denain, and in our vernacular *Gawain* poems. Among these "Bleheris" poems was one dealing with Gawain's adventures at the Grail castle, where the Grail is represented as non-Christian, and presents features strongly reminiscent of the ancient Nature mysteries. There is good ground for believing that as Grail quester and winner, Gawain preceded alike Perceval and Galahad, and that the solution of the mysterious Grail problem is to be sought rather in the tales connected with the older hero than in those devoted to the glorification of the younger knights. The explanation of the very perplexing changes which the character of Gawain has undergone appears to lie in a misunderstanding of the original sources of that character. Whether or no Gawain was a sun-hero, and he certainly possessed some of the features—we are constantly told how his strength waxed with the waxing of the sun till noontide, and then gradually decreased; he owned a steed known by a definite name le Gringalet; and a light-giving sword, Escalibur (which, as a trait, is represented as belonging to Gawain, not to Arthur)—all traits of a sun-hero—he certainly has much in common with the primitive Irish hero Cuchullin. The famous head-cutting challenge, so admirably told in *Syr Gawayne and the Grene Knight*, was originally connected with the Irish champion. Nor was the lady of Gawain's love a mortal maiden, but the queen of the other-world. In Irish tradition the other-world is often represented as an island, inhabited by women only; and it is this "Isle of Maidens" that Gawain visits in *Diu Cronc*; returning therefrom dowered with the gift of eternal youth. The Chastel Merveilleus adventure, related at length by Chrétien and Wolfram is undoubtedly such an "other-world" story. It seems probable that it was this connexion which won for Gawain the title of the "Maidens' Knight," a title for which no satisfactory explanation is ever given. When the source of the name was forgotten its meaning was not unnaturally misinterpreted, and gained for Gawain the reputation of a facile morality, which was exaggerated by the pious compilers of the later Grail romances into persistent and aggravated wrong-doing; at the same time it is to be noted that Gawain is never like Tristan and Lancelot, the hero of an illicit connexion maintained under circumstances of falsehood and treachery. Gawain, however, belonged to the pre-Christian stage of Grail tradition, and it is not surprising that writers, bent on spiritual edification, found him somewhat of a stumbling-block. Chaucer, when he spoke of Gawain coming "again out of faerie," spoke better than he knew; the home of that very gallant and courteous knight is indeed Fairy-land, and the true Gawain-tradition is informed with fairy glamour and grace.

See *Syr Gawayne*, the English poems relative to that hero, edited by Sir Frederick Madden for the Bannatyne Club, 1839 (out of print and difficult to procure); *Histoire littéraire de la France*, vol. xxx.; introduction and summary of episodic "Gawain" poems by Gaston Paris; *The Legend of Sir Gawain*, by Jessie L. Weston, Grimm Library, vol. vii.; *The Legend of Sir Perceval*, by Jessie L. Weston, Grimm Library, vol. xvii.; "Sir Gawain and the Green Knight," "Sir Gawain at the Grail Castle" and "Sir Gawain and the Lady of Lys," vols. i., vi and vii. of *Arthurian Romances* (Nutt).

GAWLER, a town of Gawler county, South Australia, on the Para river, 24½ m. by rail N.E. of Adelaide. It is one of the most thriving places in the colony, being the centre of a large wheat-growing district; it has also engineering works, foundries, flour-mills, breweries and saw-mills, while gold, silver, copper and lead are found in the neighbouring hills. The inhabitants of the town and its extensive suburbs number about 7000; though the population of the town itself in 1901 was 1996.

GAY, JOHN (1685-1732), English poet, was baptized on the 16th of September 1685 at Barnstaple, where his family had long been settled. He was educated at the grammar school of the town under Robert Luck, who had published some Latin and English poems. On leaving school he was apprenticed to a silk mercer in London, but being weary, according to Dr Johnson, "of either the restraint or the servility of his occupation," he soon returned to Barnstaple, where he spent some time with his uncle, the Rev. John Hanmer, the Nonconformist minister of the

town. He then returned to London, and though no details are available for his biography until the publication of *Wine* in 1708, the account he gives in *Rural Sports* (1713), of years wasted in attending on courtiers who were profuse in promises never kept, may account for his occupations. Among his early literary friends were Aaron Hill and Eustace Budgell. In *The Present State of Wit* (1711) Gay attempted to give an account of "all our periodical papers, whether monthly, weekly or diurnal." He especially praised the *Tatler* and the *Spectator*, and Swift, who knew nothing of the authorship of the pamphlet, suspected it to be inspired by Steele and Addison. To Lintot's *Miscellany* (1712) Gay contributed "An Epistle to Bernard Lintot," containing some lines in praise of Pope, and a version of the story of Arachne from the sixth book of the *Metamorphoses* of Ovid. In the same year he was received into the household of the duchess of Monmouth as secretary, a connexion which was, however, broken before June 1714.

The dedication of his *Rural Sports* (1713) to Pope was the beginning of a lasting friendship. Gay could have no pretensions to rivalry with Pope, who seems never to have tired of helping his friend. In 1713 he produced a comedy, *The Wife of Bath*, which was acted only three nights, and *The Fan*, one of his least successful poems; and in 1714 *The Shepherd's Week*, a series of six pastorals drawn from English rustic life. Pope had urged him to undertake this last task in order to ridicule the Arcadian pastorals of Ambrose Philips, who had been praised by the *Guardian*, to the neglect of Pope's claims as the first pastoral writer of the age and the true English Theocritus. Gay's pastorals completely achieved this object, but his ludicrous pictures of the English swains and their loves were found to be abundantly entertaining on their own account. Gay had just been appointed secretary to the British ambassador to the court of Hanover through the influence of Jonathan Swift, when the death of Queen Anne three months later put an end to all his hopes of official employment. In 1715, probably with some help from Pope, he produced *What d'ye call it?* a dramatic skit on contemporary tragedy, with special reference to Otway's *Venice Preserved*. It left the public so ignorant of its real meaning that Lewis Theobald and Benjamin Griffin (1680-1740) published a *Complete Key to what d'ye call it* by way of explanation. In 1716 appeared his *Trivia, or the Art of Walking the Streets of London*, a poem in three books, for which he acknowledged having received several hints from Swift. It contains graphic and humorous descriptions of the London of that period. In January 1717 he produced the comedy of *Three Hours after Marriage*, which was grossly indecent without being amusing, and was a complete failure. There is no doubt that in this piece he had assistance from Pope and Arbuthnot, but they were glad enough to have it assumed that Gay was the sole author.

Gay had numerous patrons, and in 1720 he published *Poems on Several Occasions* by subscription, realizing £1000 or more. In that year James Craggs, the secretary of state, presented him with some South Sea stock. Gay, disregarding the prudent advice of Pope and other of his friends, invested his all in South Sea stock, and, holding on to the end, he lost everything. The shock is said to have made him dangerously ill. As a matter of fact Gay had always been a spoilt child, who expected everything to be done for him. His friends did not fail him at this juncture. He had patrons in William Pulteney, afterwards earl of Bath, in the third earl of Burlington, who constantly entertained him at Chiswick or at Burlington House, and in the third earl of Queensberry. He was a frequent visitor with Pope, and received unvarying kindness from Congreve and Arbuthnot. In 1724 he produced a tragedy called *The Captives*. In 1727 he wrote for Prince William, afterwards duke of Cumberland, his famous *Fifty-one Fables in Verse*, for which he naturally hoped to gain some preferment, although he has much to say in them of the servility of courtiers and the vanity of court honours. He was offered the situation of gentleman-usher to the Princess Louise, who was still a child. He refused this offer, which all his friends seem to have regarded, for no very obvious reason, as an indignity. As the *Fables* were written for the amusement of one royal child,

there would appear to have been a measure of reason in giving him a sinecure in the service of another. His friends thought him unjustly neglected by the court, but he had already received (1722) a sinecure as lottery commissioner with a salary of £150 a year, and from 1722 to 1729 he had lodgings in the palace at Whitehall. He had never rendered any special services to the court.

He certainly did nothing to conciliate the favour of the government by his next production, the *Beggars' Opera*, a lyrical drama produced on the 29th of January 1728 by Rich, in which Sir Robert Walpole was caricatured. This famous piece, which was said to have made "Rich gay and Gay rich," was an innovation in many respects, and for a time it drove Italian opera off the English stage. Under cover of the thieves and highwaymen who figured in it was disguised a satire on society, for Gay made it plain that in describing the moral code of his characters he had in mind the corruptions of the governing class. Part of the success of the *Beggars' Opera* may have been due to the acting of Lavinia Fenton, afterwards duchess of Bolton, in the part of Polly Peachum. The play ran for sixty-two nights, though the representations, four of which were "benefits" of the author, were not, as has sometimes been stated, consecutive. Swift is said to have suggested the subject, and Pope and Arbuthnot were constantly consulted while the work was in progress, but Gay must be regarded as the sole author. He wrote a sequel, *Polly*, the representation of which was forbidden by the lord chamberlain, no doubt through the influence of Walpole. This act of "oppression" caused no loss to Gay. It proved an excellent advertisement for *Polly*, which was published by subscription in 1729, and brought its author more than £1000. The duchess of Queensberry was dismissed from court for enlisting subscribers in the palace. The duke of Queensberry gave him a home, and the duchess continued her affectionate patronage until Gay's death, which took place on the 4th of December 1732. He was buried in Westminster Abbey. The epitaph on his tomb is by Pope, and is followed by Gay's own mocking couplet:—

"Life is a jest, and all things show it,
I thought so once, and now I know it."

Acis and Galatea, an English pastoral opera, the music of which was written by Handel, was produced at the Haymarket in 1732. The profits of his posthumous opera of *Achilles* (1733), and a new volume of *Fables* (1738) went to his two sisters, who inherited from him a fortune of £6000. He left two other pieces, *The Distressed Wife* (1743), a comedy, and *The Rehearsal at Goatham* (1754), a farce. The *Fables*, slight as they may appear, cost him more labour than any of his other works. The narratives are in nearly every case original, and are told in clear and lively verse. The moral which rounds off each little story is never strained. They are masterpieces in their kind, and the very numerous editions of them prove their popularity. They have been translated into Latin, French and Italian, Urdu and Bengali.

See his *Poetical Works* (1893) in the Muses' Library, with an introduction by Mr John Underhill; also Samuel Johnson's *Lives of the Poets*, John Gay's *Singspiel* (1898), edited by G. Sarrazin (*Englische Textbibliothek II.*); and an article by Austin Dobson in vol. 21 of the *Dictionary of National Biography*; *Gay's Chair* (1820), edited by Henry Lee, a fellow-townsmen, contained a biographical sketch by his nephew, the Rev. Joseph Baller.

GAY, MARIE FRANÇOISE SOPHIE (1776-1852), French author, was born in Paris on the 1st of July 1776. Madame Gay was the daughter of M. Nichault de la Valette and of Francesca Peretti, an Italian lady. In 1793 she was married to M. Liottier, an exchange broker, but she was divorced from him in 1799, and shortly afterwards was married to M. Gay, receiver-general of the department of the Roër or Ruhr. This union brought her into intimate relations with many distinguished personages; and her salon came to be frequented by all the distinguished litterateurs, musicians, actors and painters of the time, whom she attracted by her beauty, her vivacity and her many amiable qualities. Her first literary production was a letter written in 1802 to the *Journal de Paris*, in defence of

Madame de Staël's novel, *Delphine*; and in the same year she published anonymously her first novel *Laure d'Estel*. *Leonia de Montbresse*, which appeared in 1813, is considered by Sainte-Beuve her best work; but *Anatole* (1815), the romance of a deaf-mute, has perhaps a higher reputation. Among her other works, *Salons célèbres* (2 vols., 1837) may be especially mentioned. Madame Gay wrote several comedies and opera libretti which met with considerable success. She was also an accomplished musician, and composed both the words and music of a number of songs. She died in Paris on the 5th of March 1852. For an account of her daughter, Delphine Gay, Madame de Girardin, see GIRARDIN.

See her own *Souvenirs d'une vieille femme* (1834); also Théophile Gautier, *Portraits contemporains*; and Sainte-Beuve, *Causeries du Lundi*, vol. vi.

GAY, WALTER (1856-), American artist, was born at Hingham, Massachusetts, on the 22nd of January 1856. In 1876 he became a pupil of Léon Bonnat in Paris. He received an honourable mention in the Salon of 1885; a gold medal in 1888, and similar awards at Vienna (1894), Antwerp (1895), Berlin (1896) and Munich (1897). He became an officer of the Legion of Honour and a member of the Society of Secession, Munich. Works by him are in the Luxembourg, the Tate Gallery (London), and the Boston and Metropolitan (New York) Museums of Art. His compositions are mainly figure subjects portraying French peasant life.

GAYA, a city and district of British India, in the Patna division of Bengal. The city is situated 85 m. S. of Patna by rail. Pop. (1901) 71,288. It consists of two distinct parts, adjoining each other; the part containing the residences of the priests is Gaya proper; and the other, which is the business quarter, is called Sahibganj. The civil offices and residences of the European inhabitants are situated here. Gaya derives its sanctity from incidents in the life of Buddha. But a local legend also exists concerning a pagan monster of great sanctity, named Gaya, who by long penance had become holy, so that all who saw or touched him were saved from perdition. Yama, the lord of hell, appealed to the gods, who induced Gaya to lie down in order that his body might be a place of sacrifice; and once down, Yama placed a large stone on him to keep him there. The tricked demon struggled violently, and, in order to pacify him, Vishnu promised that the gods should take up their permanent residence in him, and that any one who made a pilgrimage to the spot where he lay should be delivered from the terrors of the Hindu place of torment. This may possibly be a Brahmanic rendering of Buddha's life and work. There are forty-five sacred spots (of which the temple of Vishnupada is the chief) in and around the city, and these are visited by thousands of pilgrims annually. During the Mutiny the large store of treasure here was conveyed safely to Calcutta by Mr A. Money. The city contains a government high school and an hospital, with a Lady Elgin branch for women.

The DISTRICT OF GAYA comprises an area of 4712 sq. m. Generally speaking, it consists of a level plain, with a ridge of prettily wooded hills along the southern boundary, whence the country falls with a gentle slope towards the Ganges. Rocky hills occasionally occur, either detached or in groups, the loftiest being Maher hill about 12 m. S.E. of Gaya city, with an elevation of 1620 ft. above sea-level. The eastern part of the district is highly cultivated; the portions to the north and west are less fertile; while in the south the country is thinly peopled and consists of hills, the jungles on which are full of wild animals. The principal river is the Son, which marks the boundary between Gaya and Shahabad, navigable by small boats throughout the year, and by craft of 20-tons burden in the rainy season. Other rivers are the Punpun, Phalgu and Jamuna. Two branches of the Son canal system, the eastern main canal and the Patna canal, intersect the district. In 1901 the population was 2,059,933, showing a decrease of 3% in the decade. Among the higher castes there is an unusually large proportion of Brahmans, a circumstance due to the number of sacred places which the district contains. The Gayawals, or priests in charge of the holy

places, are held in high esteem by the pilgrims; but they are not pure Brahmans, and are looked down upon by those who are. They live an idle and dissolute life, but are very wealthy, from contributions extorted from the pilgrims. Buddh Gaya, about 6 m. S. of Gaya city, is one of the holiest sites of Buddhism, as containing the tree under which Sakyamuni attained enlightenment. In addition to many ruins and sculptures, there is a temple restored by the government in 1881. Another place of religious interest is a temple of great antiquity, which crowns the highest peak of the Barabar hills, and at which a religious fair is held each September, attended by 10,000 to 20,000 pilgrims. At the foot of the hill are numerous rock caves excavated about 200 B.C. The opium poppy is largely cultivated. There are a number of lac factories. Manufactures consist of common brass utensils, black stone ornaments, pottery, tussur-silk and cotton cloth. Formerly paper-making was an important manufacture in the district, but it has entirely died out. The chief exports are food grains, oil seeds, indigo, crude opium (sent to Patna for manufacture), saltpetre, sugar, blankets, brass utensils, &c. The imports are salt, piece goods, cotton, timber bamboos, tobacco, lac, iron, spices and fruits. The district is traversed by four branches of the East Indian railway. In 1901 it suffered severely from the plague.

See *District Gazetteer* (1906); Sir A. Cunningham, *Mahabodhi* (1892).

GAYAL, a domesticated ox allied to the Gaur, but distinguished, among other features, by the more conical and straighter horns, and the straight line between them. Gayal are kept by the natives of the hill-districts of Assam and parts of Tenasserim and Upper Burma. Although it has received a distinct name, *Bos (Bibos) frontalis*, there can be little doubt that the gayal is merely a domesticated breed of the gaur, many gayal-skulls showing characters approximating to those of the gaur.

GAYANGOS Y ARCE, PASCUAL DE (1809-1897), Spanish scholar and Orientalist, was born at Seville on the 21st of June 1809. At the age of thirteen he was sent to be educated at Pont-le-Voy near Blois, and in 1828 began the study of Arabic under Silvestre de Sacy. After a visit to England, where he married, he obtained a post in the Spanish treasury, and was transferred to the foreign office as translator in 1833. In 1836 he returned to England, wrote extensively in English periodicals, and translated Almakkarî's *History of the Mahommedan Dynasties in Spain* (1840-1843) for the Royal Asiatic Society. In England he also made the acquaintance of Ticknor, to whom he was very serviceable. In 1843 he returned to Spain as professor of Arabic at the university of Madrid, which post he held until 1881, when he was made director of public instruction. This office he resigned upon being elected senator for the district of Huelva. His latter years were spent in cataloguing the Spanish manuscripts in the British Museum; he had previously continued Bergenroth's catalogue of the manuscripts relating to England in the Simancas archives. His best-known original work is his dissertation on Spanish romances of chivalry in Rivadeneyra's *Biblioteca de autores españoles*. He died in London on the 4th of October 1897.

GAYARRÉ, CHARLES ÉTIENNE ARTHUR (1805-1895), American historian, was born in New Orleans, Louisiana, on the 9th of January 1805. After studying at the Collège d'Orléans he began, in 1826, to study law in Philadelphia, and three years later was admitted to the bar. In 1830 he was elected a member of the House of Representatives of Louisiana, in 1831 was appointed deputy attorney-general of his state, in 1833 became presiding judge of the city court of New Orleans, and in 1834 was elected as a Jackson Democrat to the United States Senate. On account of ill-health, however, he immediately resigned without taking his seat, and for the next eight years travelled in Europe and collected historical material from the French and the Spanish archives. In 1844-1845 and in 1856-1857 he was again a member of the state House of Representatives, and from 1845 to 1853 was secretary of state of Louisiana. He supported the Southern Confederacy during the Civil War, in which he lost a large fortune,

and after its close lived chiefly by his pen. He died in New Orleans on the 11th c. February 1895. He is best known as the historian of Louisiana. He wrote *Histoire de la Louisiane* (1847); *Romance of the History of Louisiana* (1848); *Louisiana: its Colonial History and Romance* (1851), reprinted in *A History of Louisiana; History of Louisiana; the Spanish Domination* (1854); *Philip II. of Spain* (1866); and *A History of Louisiana* (4 vols., 1866), the last being a republication and continuation of his earlier works in this field, the whole comprehending the history of Louisiana from its earliest discovery to 1861. He wrote also several dramas and romances, the best of the latter being *Fernando de Lemos* (1872).

GAY-LUSSAC, JOSEPH LOUIS (1778-1850), French chemist and physicist, was born at St Léonard, in the department of Haute Vienne, on the 6th of December 1778. He was the elder son of Antoine Gay, *procureur du roi* and judge at Pont-de-Noblac, who assumed the name Lussac from a small property he had in the neighbourhood of St Léonard. Young Gay-Lussac received his early education at home under the direction of the abbé Bourdieu and other masters, and in 1794 was sent to Paris to prepare for the École Polytechnique, into which he was admitted at the end of 1797 after a brilliant examination. Three years later he was transferred to the École des Ponts et Chaussées, and shortly afterwards was assigned to C. L. Berthollet, who wanted an able student to help in his researches. The new assistant scarcely came up to expectations in respect of confirming certain theoretical views of his master's by the experiments set him to that end, and appears to have stated the discrepancy without reserve; but Berthollet nevertheless quickly recognized the ability displayed, and showed his appreciation not only by desiring to be Gay-Lussac's "father in science," but also by making him in 1807 an original member of the Société d'Arcueil. In 1802 he was appointed demonstrator to A. F. Fourcroy at the École Polytechnique, where subsequently (1809) he became professor of chemistry, and from 1808 to 1832 he was professor of physics at the Sorbonne, a post which he only resigned for the chair of chemistry at the Jardin des Plantes. In 1831 he was elected to represent Haute Vienne in the chamber of deputies, and in 1839 he entered the chamber of peers. He died in Paris on the 9th of May 1850.

Gay-Lussac's earlier researches were mostly physical in character and referred mainly to the properties of gases, vapour-tensions, hygrometry, capillarity, &c. In his first memoir (*Ann. de Chimie*, 1802) he showed that different gases are dilated in the same proportion when heated from 0° to 100° C. Apparently he did not know of Dalton's experiments on the same point, which indeed were far from accurate; but in a note he explained that "le cit. Charles avait remarqué depuis 15 ans la même propriété dans ces gaz; mais n'ayant jamais publié ses résultats, c'est par le plus grand hasard que je les ai connus." In consequence of his candour in thus rescuing from oblivion the observation which his fellow-citizen did not think worth publishing, his name is sometimes dissociated from this law, which instead is known as that of Charles. In 1804 he had an opportunity of prosecuting his researches on air in somewhat unusual conditions, for the French Academy, desirous of securing some observations on the force of terrestrial magnetism at great elevations above the earth, through Berthollet and J. E. Chaptal obtained the use of the balloon which had been employed in Egypt, and entrusted the task to him and J. B. Biot. In their first ascent from the garden of the Conservatoire des Arts on the 24th of August 1804 an altitude of 4000 metres (about 13,000 ft.) was attained. But this elevation was not considered sufficient by Gay-Lussac, who therefore made a second ascent by himself on the 16th of September, when the balloon rose 7016 metres (about 23,000 ft.) above sea-level. At this height, with the thermometer marking 9° degrees below freezing, he remained for a considerable time, making observations not only on magnetism, but also on the temperature and humidity of the air, and collecting several samples of air at different heights. The magnetic observations, though imperfect, led him to the conclusion that the magnetic effect at all attainable elevations above

the earth's surface remains constant; and on analysing the samples of air he could find no difference of composition at different heights. (For an account of both ascents see *Journ. de phys.* for 1804.) On the 1st of October in the same year, in conjunction with Alexander von Humboldt, he read a paper on eudiometric analysis (*Ann. de Chim.*, 1805), which contained the germ of his most important generalization, the authors noting that when oxygen and hydrogen combine together by volume, it is in the proportion of one volume of the former to two volumes of the latter. But his law of combination by volumes was not enunciated in its general form until after his return from a scientific journey through Switzerland, Italy and Germany, on which with Humboldt he started from Paris in March 1805. This journey was interrupted in the spring of 1806 by the news of the death of M. J. Brisson, and Gay-Lussac hurried back to Paris in the hope, which was gratified, that he would be elected to the seat thus vacated in the Academy. In 1807 an account of the magnetic observations made during the tour with Humboldt was published in the first volume of the *Mémoires d'Arcueil*, and the second volume, published in 1809, contained the important memoir on gaseous combination (read to the Société Philomathique on the last day of 1808), in which he pointed out that gases combining with each other in volume do so in the simplest proportions—1 to 1, 1 to 2, 1 to 3—and that the volume of the compound formed bears a simple ratio to that of the constituents.

About this time Gay-Lussac's work, although he by no means entirely abandoned physical questions, became of a more chemical character; and in three instances it brought him into direct rivalry with Sir Humphry Davy. In the first case Davy's preparation of potassium and sodium by the electric current spurred on Gay-Lussac and his collaborator L. J. Thénard, who had no battery at their disposal, to search for a chemical method of obtaining those metals, and by the action of red-hot iron on fused potash—a method of which Davy admitted the advantages—they succeeded in 1808 in preparing potassium, going on to make a full study of its properties and to use it, as Davy also did, for the reduction of boron from boric acid in 1809. The second concerned the nature of "oxymuriatic acid" (chlorine). While admitting the possibility that it was an elementary body, after many experiments they finally declared it to be a compound (*Mém. d'Arcueil*, 1809). Davy, on the other hand, could see no reason to suppose it contained oxygen, as they surmised, and ultimately they had to accept his view of its elementary character. The third case roused most feeling of all. Davy, passing through Paris on his way to Italy at the end of 1813, obtained a few fragments of iodine, which had been discovered by Bernard Courtois (1777-1838) in 1811, and after a brief examination by the aid of his limited portable laboratory perceived its analogy to chlorine and inferred it to be an element. Gay-Lussac, it is said, was nettled at the idea of a foreigner making such a discovery in Paris, and vigorously took up the study of the new substance, the result being the elaborate "Mémoire sur l'iode," which appeared in the *Ann. de chim.* in 1814. He too saw its resemblance to chlorine, and was obliged to agree with Davy's opinion as to its simple nature, though not without some hesitation, due doubtless to his previous declaration about chlorine. Davy on his side seems to have felt that the French chemist was competing with him, not altogether fairly, in trying to appropriate the honour of discovering the character of the substance and of its compound, hydriodic acid.

In 1810 he published a paper which contains some classic experiments on fermentation, a subject to which he returned in a second paper published in 1815. At the same time he was working with Thénard at the improvement of the methods of organic analysis, and by combustion with oxidizing agents, first potassium chlorate and subsequently copper oxide, he determined the composition of a number of organic substances. But his last great piece of pure research was on prussic acid. In a note published in 1811 he described the physical properties of this acid, but he said nothing about its chemical composition till 1815, when he described cyanogen as a compound radicle, prussic acid as a compound of that radicle with hydrogen alone,

and the prussiates (cyanides) as compounds of the radicle with metals. The proof that prussic acid contains hydrogen but no oxygen was a most important support to the hydrogen-acid theory, and completed the downfall of Lavoisier's oxygen theory; while the isolation of cyanogen was of equal importance for the subsequent era of compound radicles in organic chemistry.

After this research Gay-Lussac's attention began to be distracted from purely scientific investigation. He had now secured a leading if not the foremost place among the chemists of the French capital, and the demand for his services as adviser in technical problems and matters of practical interest made great inroads on his available time. He had been a member of the consultative committee on arts and manufactures since 1805; he was attached to the "administration des poudres et salpêtres" in 1818, and in 1829 he received the lucrative post of assayer to the mint. In these new fields he displayed the powers so conspicuous in his scientific inquiries, and he was now to introduce and establish scientific accuracy where previously there had been merely practical approximations. His services to industry included his improvements in the processes for the manufacture of sulphuric acid (1818) and oxalic acid (1829); methods of estimating the amount of real alkali in potash and soda by the volume of standard acid required for neutralization, and for estimating the available chlorine in bleaching powder by a solution of arsenious acid; directions for the use of the centesimal alcoholometer published in 1824 and specially commended by the Institute; and the elaboration of a method of assaying silver by a standard solution of common salt, a volume on which was published in 1833. Among his research work of this period may be mentioned the improvements in organic analysis and the investigation of fulminic acid made with the help of Liebig, who gained the privilege of admission to his private laboratory in 1823-1824.

Gay-Lussac was patient, persevering, accurate to punctiliousness, perhaps a little cold and reserved, and not unaware of his great ability. But he was also bold and energetic, not only in his work but also in support and defence of his friends. His early childish adventures, as told by Arago, herald the fearless acrobat and the undaunted investigator of volcanic eruptions (Vesuvius was in full eruption when he visited it during his tour in 1805); and the endurance he exhibited under the laboratory accidents that befell him shows the power of will with which he would face the prospect of becoming blind and useless for the prosecution of the science which was his very life, and of which he was one of the most distinguished ornaments. Only at the very end, when the disease from which he was suffering left him no hope, did he complain with some bitterness of the hardship of leaving this world where the many discoveries being made pointed to yet greater discoveries to come.

The most complete list of Gay-Lussac's papers is contained in the Royal Society's *Catalogue of Scientific Papers*, which enumerates 148, exclusive of others written jointly with Humboldt, Thénard, Welter and Liebig. Many of them were published in the *Annales de chimie*, which after it changed its title to *Annales de chimie et physique* he edited, with Arago, up to nearly the end of his life; but some are to be found in the *Mémoires d'Arcueil* and the *Comptes rendus*, and in the *Recherches physiques et chimiques*, published with Thénard in 1811.

GAZA, THEODORUS (c. 1400-1475), one of the Greek scholars who were the leaders of the revival of learning in the 15th century, was born at Thessalonica. On the capture of his native city by the Turks in 1430 he fled to Italy. During a three years' residence in Mantua he rapidly acquired a competent knowledge of Latin under the teaching of Vittorino da Feltré, supporting himself meanwhile by giving lessons in Greek, and by copying manuscripts of the ancient classics.¹ In 1447 he became professor of Greek in the newly founded university of Ferrara, to which students in great numbers from all parts of Italy were soon attracted by his fame as a teacher. He had taken some part in the councils which were held in Siena (1423), Ferrara (1438), and Florence (1439), with the object of bringing about a reconciliation between

¹ According to Voigt, Gaza came to Italy some ten years later from Constantinople, where he had been a teacher or held some clerical office.

the Greek and Latin Churches; and in 1450, at the invitation of Pope Nicholas V., he went to Rome, where he was for some years employed by his patron in making Latin translations from Aristotle and other Greek authors. After the death of Nicholas (1455), being unable to make a living at Rome, Gaza removed to Naples, where he enjoyed the patronage of Alphonso the Magnanimous for two years (1456-1458). Shortly afterwards he was appointed by Cardinal Bessarion to a benefice in Calabria, where the later years of his life were spent, and where he died about 1475. Gaza stood high in the opinion of most of his learned contemporaries, but still higher in that of the scholars of the succeeding generation. His Greek grammar (in four books), written in Greek, first printed at Venice in 1495, and afterwards partially translated by Erasmus in 1521, although in many respects defective, especially in its syntax, was for a long time the leading text-book. His translations into Latin were very numerous, including the *Problemata*, *De partibus animalium* and *De generatione animalium* of Aristotle; the *Historia plantarum* of Theophrastus; the *Problemata* of Alexander Aphrodisias; the *De instruendis aciebus* of Aelian; the *De compositione verborum* of Dionysius of Halicarnassus; and some of the *Homilies* of John Chrysostom. He also turned into Greek Cicero's *De senectute* and *Somnium Scipionis*—with much success, in the opinion of Erasmus; with more elegance than exactitude, according to the colder judgment of modern scholars. He was the author also of two small treatises entitled *De mensibus* and *De origine Turcarum*.

See G. Voigt, *Die Wiederbelebung des klassischen Altertums* (1893), and article by C. F. Bähr in Ersch and Gruber's *Allgemeine Encyclopädie*. For a complete list of his works, see Fabricius, *Bibliotheca Graeca* (ed. Harles), x.

GAZA (or 'AZZAR, mod. *Ghuzzeh*), the most southerly of the five princely Philistine cities, situated near the sea, at the point where the old trade routes from Egypt, Arabia and Petra to Syria met. It was always a strong border fortress and a place of commercial importance, in many respects the southern counterpart of Damascus. The earliest notice of it is in the Tell el-Amarna tablets, in a letter from the local governor, who then held it for Egypt, with which country it always stood in close connexion. It never passed for long into Israelite hands, though subject for a while to Hezekiah of Judah; from him it passed to Assyria. In Amos i. 6 the city is denounced for giving up Hebrew slaves to Edom. To Herodotus (iii. 5) the place seemed as important as Sardis. The city withstood Alexander the Great for five months (332 B.C.), and in 96 B.C. was razed to the ground by Alexander Jannaeus. It was rebuilt by Aulus Gabinus, 57 B.C., but on a new site; the old site was remembered and spoken of as "Old" or "Desert Gaza"; compare Acts viii. 26. In the 2nd and 3rd centuries Gaza was a thriving Greek city, with good schools and famous temples, especially one to the local god Marna (i.e. "Lord" or "Our Lord"). A statue of this god has been found near Gaza; it much resembles the Greek representation of Zeus. The struggle with Christianity here was long and intense. Egyptian monks gradually won over the country folk, and in 402, under the influence of Theodosius and Porphyry the local bishop, the Marneion was destroyed and the cross made politically supreme. In the 5th and 6th centuries Gaza was held in high repute as a place of learning. But after it passed into Moslem hands (635) it gradually lost all save commercial importance, and even the Crusaders did little to revive its old military glory. It finally was captured by the Moslems in 1244. Napoleon captured it in 1799.

The modern town (pop. 16,000) is divided into four quarters, one of which is built on a low hill. A magnificent grove of very ancient olives forms an avenue 4 m. long to the north. There are many lofty minarets in various parts of the town, and a fine mosque built of ancient materials. A 12th century church towards the south side of the hill has also been converted into a mosque. On the east is shown the tomb of Samson (an erroneous tradition dating back to the middle ages). The ancient walls are now covered up beneath green mounds of rubbish. The water-supply is from wells sunk through the sandy soil to

the rock; of these there are more than twenty—an unusual number for a Syrian town. The land for the 3 m. between Gaza and the sea consists principally of sand dunes. There is no natural harbour, but traces of ruins near the shore mark the site of the old Maiuma Gazae or Port of Gaza, now called el Mineh, which in the 5th century was a separate town and episcopal see, under the title Constantia or Limena Gaza. Hâshem, an ancestor of Mahomet, lies buried in the town. On the east are remains of a race-course, the corners marked by granite shafts with Greek inscriptions on them. To the south is a remarkable hill, quite isolated and bare, with a small mosque and a graveyard. It is called el Muntâr, "the watch tower," and is supposed to be the mountain "before (or facing) Hebron," to which Samson carried the gates of Gaza (Judg. xvi. 3). The bazaars of Gaza are considered good. An extensive pottery exists in the town, and black earthenware peculiar to the place is manufactured there. The climate is dry and comparatively healthy, but the summer temperature often exceeds 110° Fahr. The surrounding country is partly cornland, partly waste, and is inhabited by wandering Arabs. The prosperity of Ghuzzeh has partially revived through the growing trade in barley, of which the average annual export to Great Britain for 1897-1899 was over 30,000 tons. The dress of the people is Egyptian rather than Syrian. Gaza is an episcopal see both of the Greek and the Armenian church. The Church Missionary Society maintains a mission, with schools for both sexes, and a hospital.

GAZALAND, a district of Portuguese East Africa, extending north from the Komati or Manhissa river, Delagoa Bay, to the Pungwe river. It is a well-watered, fertile country. Gazaland is one of the chief recruiting grounds for negro labour in the Transvaal gold mines. The country derives its name from a Swazi chief named Gaza, a contemporary of Chaka, the Zulu king. Refugees from various clans oppressed by Dingaan (Chaka's successor) were welded into one tribe by Gaza's son Manikusa, who took the name of Sotshangana, his followers being known generally as Matshangana. A section of them was called Maviti or Landeens (i.e. couriers), a designation which persists as a tribal name. Between 1833 and 1836 Manikusa made himself master of the country as far north as the Zambezi and captured the Portuguese posts at Delagoa Bay, Inhambane, Sofala and Sena, killing nearly all the inhabitants. The Portuguese reoccupied their posts, but held them with great difficulty, while in the interior the Matshangana continued their ravages unchecked, depopulating large regions. Manikusa died about 1860, and his son Umzila, receiving some help from the Portuguese at Delagoa Bay in a struggle against a brother for the chieftainship, ceded to them the territory south of the Manhissa river. North of that stream as far as the Zambezi and inland to the continental plateau Umzila established himself in independence, a position he maintained till his death (c. 1884). His chief rival was a Goanese named Gouveia, who came to Africa about 1850. Having obtained possession of a *prazo* in the Gorongosa district, he ruled there as a feudal lord while acknowledging himself a Portuguese subject. Gouveia recovered from the Matshangana and other troublemakers of the peace much of the country in the Zambezi valley, and was appointed by the Portuguese captain-general of a large region. From 1868 onward the country began to be better known. Probably the first European to penetrate any distance inland from the Sofala coast since the Portuguese gold-seekers of the 16th century was St Vincent W. Erskine, who explored the region between the Limpopo and Pungwe (1868-1875). Portugal's hold on the coast had been more firmly established at the time of Umzila's death, and Gungunyana, his successor, was claimed as a vassal, while efforts were made to open up the interior. This led in 1890-1891 to collisions on the borderland of the plateau with the newly established British South Africa Company, and to the arrest by the company's agents of Gouveia, who was, however, set at liberty and returned to Mozambique via Cape Town. An offer made by Gungunyana (1891) to come under British protection was not accepted. In 1892 Gouveia was killed in a war with a native chief. Gungunyana maintained his independence until

1805, when he was captured by a Portuguese force and exiled, first to Lisbon and afterwards to Angola, where he died in 1906. With the capture of Gungunyana opposition to Portuguese rule largely ceased.

In flora, fauna and commerce Gazaland resembles the neighbouring regions of Portuguese East Africa. (g.v.).

See G. McCall Theal, *History of South Africa since 1795*, vol. v. (London, 1908).

GAZEBO (usually explained as a comic Latinism, for "I will gaze"; the *New English Dictionary* suggests a possible oriental origin now lost), a term used in the 18th century for a structure on the outer wall of a garden, having an upper storey with windows on each side so as to overlook the road. Similar buildings are found in Holland on the borders of the canals, which in some cases form very picturesque features.

GAZETTE, a name given to news-sheets or newspapers having an abstract of current events (see **NEWSPAPERS**). The *London Gazette* is the title of the English official organ for announcements by the government, and is published every Tuesday and Friday. It contains all proclamations, orders of council, promotions and appointments to commissions in the army and navy, all appointments to offices of state, and such other orders, rules and regulations as are directed by act of parliament to be published therein. It also contains notices of proceedings in bankruptcy, dissolutions of partnership, &c. By the Documentary Evidence Act 1868 the production of a copy of the *Gazette* is prima facie evidence of royal proclamations and government orders and regulations. Similar gazettes are also published in Edinburgh and Dublin. Most countries (the United States excepted) have official journals containing information more or less similar to that of the *London Gazette*, as the French *Journal officiel*, the German *Deutscher Reichs- und Kgl. Preuss. Staats-Anzeiger*, &c. The word "gazetteer" was originally applied to one who wrote for "gazettes," but is now only used for a geographical dictionary arranged on an alphabetical plan.

GEAR (connected with "garb," properly elegance, fashion, especially of dress, and with "gar," to cause to do, only found in Scottish and northern dialects; the root of the word is seen in the Old Teut. *garujan*, to make ready), an outfit, applied to the wearing apparel of a person, or to the harness and trappings of a horse or any draft animal, as riding-gear, hunting-gear, &c.; also to household goods or stuff. The phrase "out of gear," though now connected with the mechanical application of the word, was originally used to signify "out of harness" or condition, not ready to work, not fit. The word is also used of apparatus generally, and especially of the parts collectively in a machine by which motion is transmitted from one part to another by a series of cog-wheels, continuous bands, &c. It is used in a special sense in reference to a bicycle, meaning the diameter of an imaginary wheel, the circumference of which is equal to the distance accomplished by one revolution of the pedals (see **BICYCLE**).

GEBER. The name Geber has long been used to designate the author of a number of Latin treatises on alchemy, entitled *Summa perfectionis magisterii*, *De investigatione perfectionis*, *De inventione veritatis*, *Liber fornacum*, *Testamentum Geberii Regis Indiae* and *Alchemia Geberii*, and these writings were generally regarded as translations from the Arabic originals of Abu Abdallah Jaber ben Hayyam (Haiyan) ben Abdallah al-Kufi, who is supposed to have lived in the 8th or 9th century of the Christian era. About him, however, there is considerable uncertainty. According to the *Kutub-al-Fihrist* (10th century), which gives his name as above, the authorities disagree, some asserting him to have been a writer on philosophy and rhetoric, and others claiming for him the first place among the adepts of his time in the art of making gold and silver. The writer of the *Kutub-al-Fihrist* says he had been assured that Jaber only wrote one book and even that he never existed at all, but these statements he scouts as ridiculous, and expressing the conviction that Jaber really did exist, and that his works were numerous and important, goes on to quote the titles of some 500 treatises attributed to him. He is said to have resided most frequently at Kufa, where he prepared the "elixir," but,

according to others, he never spent long in one place, having reason to keep his whereabouts unknown. His patron or master is variously given as Ja'far ben Yahya, and as Ja'far es-Sadiq; in the Arabic *Book of Royalty*, professedly written by him, he addresses the last-named as his master. In addition to these details the *Fihrist* mentions a tradition that he originally came from Khorasan. Another story given by d'Herbelot (*Bibliothèque orientale*, s.v. "Glabur") makes him a native of Harran in Mesopotamia and a Sabaeen. Leo Africanus, who in 1526 gave an account of the Alchemists of Fez in Africa (see the English translation of his *Africae descriptio* by John Pory, *A Geographical History of Africa*, London, 1600, p. 155), states that their principal authority was Geber, a Greek who had apostatized to Mahomedanism and lived a century after Mahomet. In Albertus Magnus the name Geber occurs only once and then with the epithet "of Seville"; doubtless the reference is to the Arabian Jaber ben Afah, who lived in that city in the 11th century, and wrote an astronomy in 9 books which is of importance in the history of trigonometry.

The great puzzle connected with the name Geber lies in the character of the writings attributed to him, their style and matter differentiating them strongly from those of even the best authors of the later alchemical period, and making it difficult to account for their existence at all. The researches of M. P. E. Berthelot threw a great deal of light on this question. Taking the six treatises enumerated above he concluded, after critical examination, that the two last may be disregarded as of later date than the others, and that the *De investigatione perfectionis*, the *De inventionis* and the *Liber fornacum* are merely extracts from or summaries of the *Summa perfectionis* with later additions. The *Summa* he therefore regarded as representative of the work of the Latin Geber, and study of it convinced him that it contains no indication of an Arabic origin, either in its method, which is conspicuous for clearness of reasoning and logical co-ordination of material, or in its facts, or in the words and persons quoted. Without going so far as to deny that some words and phrases may be taken from the writings of the Arabian Jaber, he was disposed to hold that it is the original work of some unknown Latin author, who wrote it in the second half of the 13th century and put it under the patronage of the venerated name of Geber. The MS. of this work in the Bibliothèque Nationale at Paris dates from about the year 1300. Berthelot further investigated Arabic MSS. existing in the Paris library and in the university of Leiden, and containing works attributed to Jaber, and had translations made of six treatises—two, of which he gives the titles as *Livre de la royauté* and *Petit Livre de la miséricorde*,—from Paris, and four—*Livre des balances*, *Livre de la miséricorde*, *Livre de la concentration* and *Livre de la mercure orientale*—from Leiden. Berthelot was not prepared to assert that these treatises were actually written by Jaber, but he held it certain that they are works written in Arabic between the 9th and 12th centuries, at a period anterior to the relations of the Latins with the Arabs. In style these treatises are entirely different from the *Summa* of Geber. Their language is vague and allegorical, full of allusions and pious Mussulman invocations; the author continually announces that he is about to speak without mystery or reserve, but all the same never gives any precise details of the secrets he professes to reveal. He holds the doctrine that everything endowed with an apparent quality possesses an opposite occult quality in much the same terms as it is found in Latin writers of the middle ages, but he makes no allusion to the theory of the generation of the metals by sulphur and mercury, a theory generally attributed to Geber, who also added arsenic to the list. Again he fully accepts the influence of the stars on the production of the metals, whereas the Latin Geber disputes it, and in general the chemical knowledge of the two is on a different plane. Here again the inference is that the Latin treatises printed from the 15th century onwards as the work of Geber are not authentic, regarded as translations of the Arabic author Jaber, always supposing that the Arabic MSS. transcribed and translated for Berthelot are really, as they profess to be, the work of Jaber, and as representative of his opinions and attainments.

But while Berthelot thus deprived the world of what were long regarded as genuine Latin versions of Jaber's works, he also gave it something in their place, for among the Paris MSS. he found a mutilated treatise, hitherto unpublished, entitled *Liber de Septuaginta (Johannis)*, translated a *Magistro Renaldo Cremonensi*, which he considered the only known Latin work that can be regarded as a translation from the Arabic Jaber. The latter states in the Arabic works referred to above that under that title he collected 70 of the 500 little treatises or tracts of which he was the author, and the titles of those tracts enumerated in the *Kitáb-al-Fihrist* as forming the chapters of the *Liber de Septuaginta* correspond in general with those of the Latin work, which further is written in a style similar to that of the Arabic Jaber and contains the same doctrines. Hence Berthelot felt justified in assigning it to Jaber, although no Arabic original is known.

The evidence collected by Berthelot has an important bearing on the history of chemistry. Most of the chemical knowledge attributed to the Arabs has been attributed to them on the strength of the reputed Latin writings of Geber. If, therefore, these are original works rather than translations, and contain facts and doctrines which are not to be found in the Arabian Jaber, it follows that, on the one hand, the chemical knowledge of the Arabs has been overestimated and, on the other, that more progress was made in the middle ages than has generally been supposed.

See M. P. E. Berthelot's works on the history of alchemy and especially his *Chimie au moyen âge* (3 vols., Paris, 1893), the third volume of which contains a French translation of Jaber's works together with the Arabic text.

GEBHARD TRUCHSESS VON WALDBURG (1547-1601), elector and archbishop of Cologne, was the second son of William, count of Waldburg, and nephew of Otto, cardinal bishop of Augsburg (1514-1573). Belonging thus to an old and distinguished Swabian family, he was born on the 10th of November 1547, and after studying at the universities of Ingolstadt, Perugia, Louvain and elsewhere began his ecclesiastical career at Augsburg. Subsequently he held other positions at Strassburg, Cologne and Augsburg, and in December 1577 was chosen elector of Cologne after a spirited contest. Gebhard is chiefly noted for his conversion to the reformed doctrines, and for his marriage with Agnes, countess of Mansfeld, which was connected with this step. After living in concubinage with Agnes he decided, perhaps under compulsion, to marry her, doubtless intending at the same time to resign his see. Other counsels, however, prevailed. Instigated by some Protestant supporters he declared he would retain the electorate, and in December 1582 he formally announced his conversion to the reformed faith. The marriage with Agnes was celebrated in the following February, and Gebhard remained in possession of the see. This affair created a great stir in Germany, and the clause concerning ecclesiastical reservation in the religious peace of Augsburg was interpreted in one way by his friends, and in another way by his foes; the former holding that he could retain his office, the latter that he must resign. Anticipating events Gebhard had collected some troops, and had taken measures to convert his subjects to Protestantism. In April 1583 he was deposed and excommunicated by Pope Gregory XIII.; a Bavarian prince, Ernest, bishop of Liège, Freising and Hildesheim, was chosen elector, and war broke out between the rivals. The cautious Lutheran princes of Germany, especially Augustus I., elector of Saxony, were not enthusiastic in support of Gebhard, whose friendly relations with the Calvinists were not to their liking; and although Henry of Navarre, afterwards Henry IV. of France, tried to form a coalition to aid the deposed elector, the only assistance which he obtained came from John Casimir, administrator of the Palatinate of the Rhine. The inhabitants of the electorate were about equally divided on the question, and Ernest, supported by Spanish troops, was too strong for Gebhard. John Casimir, who acted as commander-in-chief, returned to the Palatinate in October 1593, and early in the following year Gebhard was driven from Bonn and took refuge in the Netherlands. The electorate was soon completely in the possession of Ernest, and the defeat of Gebhard was a serious blow to Protestantism, and marks a stage in the history of the Reformation. *Living in the Netherlands he became very intimate with Eliza-*

beth's envoy, Robert Dudley, earl of Leicester, but he failed to get assistance for renewing the war either from the English queen or in any other quarter. In 1580 Gebhard took up his residence at Strassburg, where he had held the office of dean of the cathedral since 1574. Before his arrival some trouble had arisen in the chapter owing to the fact that three excommunicated canons persisted in retaining their offices. He joined thus party, which was strongly supported in the city, took part in a double election to the bishopric in 1592, and in spite of some opposition retained his office until his death at Strassburg on the 31st of May 1601. Gebhard was a drunken and licentious man, who owes his prominence rather to his surroundings than to his abilities.

See M. Lössen, *Der kölnische Krieg* (Gotha, 1882), and the article on Gebhard in band viii. of the *Allgemeine deutsche Biographie* (Leipzig, 1878); J. H. Hennes, *Der Kampf um das Erzbistum Köln* (Cologne, 1878); L. Ennen, *Geschichte der Stadt Köln* (Cologne, 1863-1880); and *Nuntiatarberichte aus Deutschland. Der Kampf um Köln*, edited by J. Hansen (Berlin, 1892).

GEBWEILER (Fr. *Guebwiller*), a town of Germany in the imperial province of Alsace-Lorraine, at the foot of the Vosges, on the Lauch, 13 m. S. of Colmar, on the railway Bollweiler-Lautenbach. Pop. (1905) 13,259. Among the principal buildings are the Roman Catholic church of St Leodgar, dating from the 12th century, the Evangelical church, the synagogue, the town-house, and the old Dominican convent now used as a market and concert hall. The chief industries are spinning and dyeing, and the manufacture of cloth and of machinery; quarrying is carried on and the town is celebrated for its white wines.

Gebweiler is mentioned as early as 774. It belonged to the religious foundation of Murbach, and in 1750 the abbots chose it for their residence. In 1789, at the outbreak of the Revolution, the monastic buildings were laid in ruins, and, though the archives were rescued and removed to Colmar, the library perished.

GECKO,¹ the common name applied to all the species of the *Geckones*, one of the three sub-orders of the *Lucertilia*. The geckoes are small creatures, seldom exceeding 8 in. in length including the tail. With the head considerably flattened, the body short and thick, the legs not high enough to prevent the body dragging somewhat on the ground, the eyes large and almost destitute of eyelids, and the tail short and in some cases nearly as thick as the body, the geckoes altogether lack the liteness and grace characteristic of most lizards. Their colours also are dull,



Leaf-tailed Gecko (*Gymnodactylus platurus*) of Australia.

and to the weird and forbidding aspect thus produced the general prejudice against those creatures in the countries where they occur, which has led to their being classed with toads and snakes, is no doubt to be attributed. Their bite was supposed to be venomous, and their saliva to produce painful cutaneous eruptions; even their touch was thought sufficient to convey a dangerous taint. It is needless to say that in this instance the popular mind was misled by appearances. The geckoes are not only harmless, but are exceedingly useful creatures, feeding on insects, which, owing to the great width of their oesophagus, they are enabled to swallow whole, and in pursuit of which they do not hesitate to enter human dwellings, where they are often killed on

¹The Malay name *gê-hoq* imitates the animal's cry.

suspicion. The structure of the toes in these lizards forms one of their most characteristic anatomical features.

Most geckoes have adhesive digits and toes, by means of which they are enabled not only to climb absolutely smooth and vertical surfaces, for instance a window-pane, but to run along a white-washed ceiling, back downwards. The adhesion is not produced by sticky matter but by numerous transverse lamellae, each of which is further beset with tiny hair-like excrescences. The arrangement of the lamellae and pads differs much in the various genera and is used for classificatory purposes. Those which live on sandy ground have narrow digits without the adhesive apparatus. Most species have sharp, curved claws, often

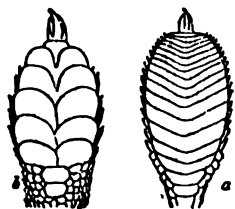

Lower Surface of the Toe of (a) *Gecko*, (b) *Hemidactylus*—enlarged.

retractile between some of the lamellae or into a special sheath. The tail is very brittle and can be quickly regenerated; it varies much in size and shape; the most extraordinary is that of the leaf-tailed gecko. *Ptychozoon homalocephalon* of the Malay countries has membranous expansions on the sides of the head, body, limbs and tail, which look like parachutes, but more probably they aid in concealing the creature when it is

closely pressed to the similarly coloured bark of a tree. Most geckoes are dull coloured, yellow to brown, and they soon change colour from lighter to dark tints. They are insectivorous and chiefly nocturnal, but are fond of basking in the sun, motionless on the bark of a tree, or on a rock the colour of which is then imitated to a nicety. Some species are more or less transparent. Geckoes, of which about 270 species are known, subdivided into about 50 genera, are cosmopolitan within the warmer zones, including New Zealand, and even the remotest volcanic islands. This wide distribution is due partly to the great age of the suborder (although fossils are unknown), partly to their being able to exist for several months without food so that, concealed in hollow trunks of trees, they may float about for a very long time. Ships, also, act as distributors. In south Europe occur only *Hemidactylus turcicus*, *Tarentola mauritanica* (*Platydactylus socianus*) and *Phyllodactylus europaeus*.

GED, WILLIAM (1690-1749), the inventor of stereotyping, was born at Edinburgh in 1690. In 1725 he patented his invention, developed from the simple process of soldering together loose types of Van der Mey. Ged, although he succeeded in obtaining a cast in similar metal, of a type page, could not persuade Edinburgh printers to take up his invention, and finally entered into partnership with a London stationer named Jenner and Thomas James, a typesetter. The partnership, however, turned out very ill; and Ged, broken-hearted at his want of success due to trade jealousy and the composers' dislike of the innovation, died in poverty on the 19th of October 1749. Two prayer-books for the university of Cambridge and an edition of Sallust were printed from his stereotype plates. In his time the best type was imported from Holland, and Ged's daughter reports that he had repeated offers from the Dutch king, from patriotic motives, he refused. His sons tried to carry out his patent, and it was eventually perfected by Andrew Wilson.

GEDDES, ALEXANDER (1737-1802), Scottish Roman Catholic theologian, was born in Rathven, Banffshire, on the 14th of September 1737. He was trained at the Roman Catholic seminary at Scalán and at the Scottish College in Paris, where he studied biblical philology, school divinity and modern languages. In 1764 he officiated as a priest in Dundee, but in May 1765 accepted an invitation to live with the earl of Traquair, where, with abundance of leisure and the free use of an adequate library, he made further progress in his favourite biblical studies. After a second visit to Paris, which was employed by him in reading and making extracts from rare books and manuscripts,

he was appointed in 1769 priest of Auchinhalrig and Preshome in his native county. The freedom with which he fraternized with his Protestant neighbours called forth the rebuke of his bishop (George Hay), and ultimately, for hunting and for occasionally attending the parish church of Cullen, where one of his friends was minister, he was deprived of his charge and forbidden the exercise of ecclesiastical functions within the diocese. This happened in 1779; and in 1780 he went with his friend Lord Traquair to London, where he spent the rest of his life. Before leaving Scotland he had received the honorary degree of LL.D. from the university of Aberdeen, and had been made an honorary member of the Society of Antiquaries, in the institution of which he had taken a very active part. In London Geddes soon received an appointment in connexion with the chapel of the imperial ambassador, and was also helped by Lord Petre in his scheme for a new Catholic version of the Bible. In 1786, supported also by such scholars as Benjamin Kennicott and Robert Lowth, Geddes published a *Prospectus of a new Translation of the Holy Bible*, a considerable quarto volume, in which the defects of previous translations were fully pointed out, and the means indicated by which these might be removed. It was well received, and led to the publication in 1788 of *Proposals for Printing*, with a specimen, and in 1790 of a *General Answer to Queries, Counsels and Criticisms*. The first volume of the translation itself, which was entitled *The Holy Bible . . . faithfully translated from corrected Texts of the Originals, with various Readings, explanatory Notes and critical Remarks*, appeared in 1792, and was the signal for a storm of hostility on the part of both Catholics and Protestants. It was obvious enough—no small offence in the eyes of some—that as a critic Geddes had identified himself with C. F. Houbigant (1686-1783), Kennicott and J. D. Michaelis, but others did not hesitate to stigmatize him as the would-be "corrector of the Holy Ghost." Three of the vicars-apostolic almost immediately warned all the faithful against the "use and reception" of his translation, on the ostensible ground that it had not been examined and approved by due ecclesiastical authority; and by his own bishop (Douglas) he was in 1793 suspended from the exercise of his orders in the London district. The second volume of the translation, completing the historical books, published in 1797, found no more friendly reception; but this circumstance did not discourage him from giving forth in 1800 the volume of *Critical Remarks on the Hebrew Scriptures*, which presented in a somewhat brusque manner the then novel and startling views of Eichhorn and his school on the primitive history and early records of mankind.

Geddes was engaged on a critical translation of the Psalms (published in 1807) when he was seized with an illness of which he died on the 26th of February 1802. Although under ecclesiastical censures, he had never swerved from a consistent profession of faith as a Catholic; and on his death-bed he duly received the last rites of his communion.

Besides pamphlets on the Catholic and slavery questions, as well as several fugitive *Jeux d'esprit*, and a number of unsigned articles in the *Analytical Review*, Geddes also published a free metrical version of *Select Satires of Horace* (1779), and a verbal rendering of the *First Book of the Iliad of Homer* (1792). The *Memoirs of his life and writings* by his friend John Mason Good appeared in 1803.

GEDDES, ANDREW (1783-1844), British painter, was born at Edinburgh. After receiving a good education in the high school and in the university of that city, he was for five years in the excise office, in which his father held the post of deputy auditor. After the death of his father, who had opposed his desire to become an artist, he came to London and entered the Royal Academy schools. His first contribution to the exhibitions of the Royal Academy, a "St John in the Wilderness," appeared at Somerset House in 1806, and from that year onwards Geddes was a fairly constant exhibitor of figure-subjects and portraits. His well-known portrait of Wilkie, with whom he was on terms of intimacy, was at the Royal Academy in 1816. He alternated for some years between London and Edinburgh, with some excursions on the Continent, but in 1831 settled in London, and was elected associate of the Royal Academy in 1832; and he

died in London of consumption in 1844. A very able executant, a good colourist, and a close student of character, he made his chief success as a portrait-painter, but he produced occasional figure subjects and landscapes, and executed some admirable copies of the old masters as well. He was also a good etcher. His portrait of his mother, and a portrait study, called "Summer," are in the National Gallery of Scotland, and his portrait of Sir Walter Scott is in the Scottish National Portrait Gallery.

See *Art in Scotland: its Origin and Progress*, by Robert Brydall (1889); *The Scottish School of Painting*, by William D. McKay, R.S.A. (1906).

GEDDES, JAMES LORRAINE (1827-1887), American soldier and writer, was born in Edinburgh, Scotland, on the 10th of March 1827. In his boyhood he was taken to Canada, but in 1843 he returned to Scotland; then studied at Calcutta in the military academy, entered the army, and after distinguishing himself in the Punjab campaign, returned to Canada, whence in 1857 he removed to Vinton, Iowa. In the American Civil War he served in the Federal army first as lieutenant-colonel and after February 1862 as colonel of volunteers, taking part in the fighting at Shiloh, Vicksburg and Corinth. He was captured at Shiloh and was imprisoned for a time at Madison, Ga., and in Libby prison, Richmond, Va., and in 1865 was brevetted brigadier-general of volunteers. He was principal of the College for the Blind at Vinton after the war, and until his death was connected with the Iowa College of Agriculture at Ames, being military instructor and cashier in 1870-1882, acting president in 1876-1877, librarian in 1877-1878, vice-president and professor of military tactics in 1880-1882, and treasurer in 1884-1887. He died at Ames on the 21st of February 1887. He wrote a number of war songs, including "The Soldiers' Battle Prayer" and "The Stars and Stripes."

GEDDES, SIR WILLIAM DUGUID (1828-1900), Scottish scholar and educationist, was born in Aberdeenshire. He was educated at Elgin academy and university and King's College, Aberdeen, and after having held various scholastic posts he was appointed in 1860 professor of Greek and in 1885 principal of the (united) university of Aberdeen. He was knighted in 1892. He died in Aberdeen on the 9th of February 1900. It is chiefly as a teacher that Geddes will be remembered, and in his enthusiastic and successful efforts to raise the standard of Greek at the Scottish universities he has been compared with the humanists of the Renaissance. Amongst other works he was the author of *A Greek Grammar* (1855; 17th edition, 1883; new and revised edition, 1893); a meritorious edition of the *Phædo* of Plato (2nd ed., 1885); and *The Problem of the Homeric Poems* (1878), in which, while supporting Grote's view that the *Iliad* consisted of an original Achilleid with insertions or additions by later hands, he maintains that these insertions are due to the author of the *Odyssey*.

GEDYMIN (d. 1342), grand-duke of Lithuania, was supposed by the earlier chroniclers to have been the servant of Witen, prince of Lithuania, but more probably he was Witen's younger brother and the son of Lutouwer, another Lithuanian prince. Gedymin inherited a vast domain, comprising Lithuania proper, Samogitia, Red Russia, Polotsk and Minsk; but these possessions were envied by powerful and greedy foes, the most dangerous of them being the Teutonic Knights and the Livonian knights of the Sword. The systematic raiding of Lithuania by the knights under the pretext of converting it had long since united all the Lithuanian tribes against the common enemy; but Gedymin aimed at establishing a dynasty which should make Lithuania not merely secure but mighty, and for this purpose he entered into direct diplomatic negotiations with the Holy See. At the end of 1322 he sent letters to Pope John XXII. soliciting his protection against the persecution of the knights, informing him of the privileges already granted to the Dominicans and the Franciscans in Lithuania for the preaching of God's Word, and desiring that legates should be sent to receive him also into the bosom of the church. On receiving a favourable reply from the Holy See, Gedymin issued circular letters, dated 25th of January 1325, to the principal Hanse towns, offering a free access into his

domains to men of every order and profession from nobles and knights to tillers of the soil. The immigrants were to choose their own settlements and be governed by their own laws. Priests and monks were also invited to come and build churches at Vilna and Novogrodek. Similar letters were sent to the Wendish or Baltic cities, and to the bishops and landowners of Livonia and Esthonia. In short Gedymin, recognizing the superiority of western civilization, anticipated Ivan the Terrible and Peter the Great by throwing open the semi-savage Russian lands to influences of culture.

In October 1323 representatives of the archbishop of Riga, the bishop of Dorpat, the king of Denmark, the Dominican and Franciscan orders, and the Grand Master of the Teutonic Order assembled at Vilna, when Gedymin confirmed his promises and undertook to be baptized as soon as the papal legates arrived. A compact was then signed at Vilna, "in the name of the whole Christian World," between Gedymin and the delegates, confirming the promised privileges. But the christianizing of Lithuania was by no means to the liking of the Teutonic Knights, and they used every effort to nullify Gedymin's far-reaching design. This, unfortunately, it was easy to do. Gedymin's chief object was to save Lithuania from destruction at the hands of the Germans. But he was still a pagan reigning over semi-pagan lands; he was equally bound to his pagan kinsmen in Samogitia, to his orthodox subjects in Red Russia, and to his Catholic allies in Masovia. His policy, therefore, was necessarily tentative and ambiguous, and might very readily be misinterpreted. Thus his raid upon Dobrzyn, the latest acquisition of the knights on Polish soil, speedily gave them a ready weapon against him. The Prussian bishops, who were devoted to the knights, at a synod at Elbing questioned the authority of Gedymin's letters and denounced him as an enemy of the faith; his orthodox subjects reproached him with leaning towards the Latin heresy; while the pagan Lithuanians accused him of abandoning the ancient gods. Gedymin disentangled himself from his difficulties by repudiating his former promises; by refusing to receive the papal legates who arrived at Riga in September 1323; and by dismissing the Franciscans from his territories. These apparently retrogressive measures simply amounted to a statesmanlike recognition of the fact that the pagan element was still the strongest force in Lithuania, and could not yet be dispensed with in the coming struggle for nationality. At the same time Gedymin through his ambassadors privately informed the papal legates at Riga that his difficult position compelled him for a time to postpone his steadfast resolve of being baptized, and the legates showed their confidence in him by forbidding the neighbouring states to war against Lithuania for the next four years, besides ratifying the treaty made between Gedymin and the archbishop of Riga. Nevertheless in 1325 the Order, disregarding the censures of the church, resumed the war with Gedymin, who had in the meantime improved his position by an alliance with Wladislaus Lokietek, king of Poland, whose son Casimir now married Gedymin's daughter Aldona.

While on his guard against his northern foes, Gedymin from 1316 to 1340 was aggrandizing himself at the expense of the numerous Russian principalities in the south and east, whose incessant conflicts with each other wrought the ruin of them all. Here Gedymin's triumphal progress was irresistible; but the various stages of it are impossible to follow, the sources of its history being few and conflicting, and the date of every salient event exceedingly doubtful. One of his most important territorial accretions, the principality of Halicz-Vladimir, was obtained by the marriage of his son Lubart with the daughter of the Haliczian prince; the other, Kiev, apparently by conquest. Gedymin also secured an alliance with the grand-duchy of Muscovy by marrying his daughter, Anastasia, to the grand-duke Simeon. But he was strong enough to counterpoise the influence of Muscovy in northern Russia, and assisted the republic of Pskov, which acknowledged his overlordship, to break away from Great Novgorod. His internal administration bears all the marks of a wise ruler. He protected the Catholic as well as the orthodox clergy, encouraging them both to civilize his

subjects; he raised the Lithuanian army to the highest state of efficiency then attainable; defended his borders with a chain of strong fortresses; and built numerous towns including Vilna, the capital (c. 1321). Gedymin died in the winter of 1342 of a wound received at the siege of Wielowa. He was married three times, and left seven sons and six daughters.

See Teodor Narbutt, *History of the Lithuanian nation* (Pol.) (Vilna, 1835); Antoni Prochaska, *On the Genuineness of the Letters of Gedymin* (Pol.) (Cracow, 1895); Vladimir Bonifatovich Antonovich, *Monograph concerning the History of Western and South-western Russia* (Rus.) (Kiev, 1865). (R. N. B.)

GEE, THOMAS (1815-1898), Welsh Nonconformist preacher and journalist, was born at Denbigh on the 24th of January 1815. At the age of fourteen he went into his father's printing office, but continued to attend the grammar school in the afternoons. In 1837 he went to London to improve his knowledge of printing, and on his return to Wales in the following year ardently threw himself into literary, educational and religious work. Among his publications were the well-known quarterly magazine *Y Traethodydd* ("The Essayist"), *Gwyddoniadur Cymreig* ("Encyclopaedia Cambrensis"), and Dr Silvan Evans's *English-Welsh Dictionary* (1868), but his greatest achievement in this field was the newspaper *Baner Cymru* ("The Banner of Wales"), founded in 1857 and amalgamated with *Yr Amserau* ("The Times") two years later. This paper soon became an oracle in Wales, and played a great part in stirring up the nationalist movement in the principality. In educational matters he waged a long and successful struggle on behalf of undenominational schools and for the establishment of the intermediate school system. He was an enthusiastic advocate of church disestablishment, and had a historic newspaper duel with Dr John Owen (afterwards bishop of St David's) on this question. The *Eisteddfod* found in him a thorough friend and a wise counsellor. His commanding presence, mastery of diction, and resonant voice made him an effective platform speaker. He was ordained to the Calvinistic Methodist ministry at Bala in 1847, and gave his time and talents ungrudgingly to Sunday school and temperance work. Throughout his life he believed in the itinerant unpaid ministry rather than in the settled pastorate. He died on the 28th of September 1898, and his funeral was the most imposing ever seen in North Wales.

GEELE, JACOB (1780-1862), Dutch scholar and critic, was born at Amsterdam on the 12th of November 1780. In 1823 he was appointed sub-librarian, and in 1833 chief librarian and honorary professor at Leiden, where he died on the 11th of November 1862. Geel materially contributed to the development of classical studies in Holland. He was the author of editions of Theocritus (1820), of the Vatican fragments of Polybius (1829), of the *Orationes* of Dio Chrysostom (1840) and of numerous essays in the *Rheinisches Museum* and *Bibliotheca critica nova*, of which he was one of the founders. He also compiled a valuable catalogue of the MSS. in the Leiden library, wrote a history of the Greek sophists, and translated various German works into Dutch.

GEELONG, a seaport of Grant county, Victoria, Australia, situated on an extensive land-locked arm of Port Phillip known as Corio Bay, 45 m. by rail S.W. of Melbourne. Pop. of the city proper (1901) 12,399; with the adjacent boroughs of Geelong West, and Newton-and-Chilwell, 23,311. Geelong slopes to the bay on the north and to the Barwon river on the south, and its position in this respect, as well as the shelter it obtains from the Bellarine hills, renders it one of the healthiest towns in Victoria. As a manufacturing centre it is of considerable importance. The first woollen mill in the colony was established here, and the tweeds, cloths and other woollen fabrics of the town are noted throughout Australia. There are extensive tanneries, flour-mills and salt works, while at Eyanford, 3 m. distant, there are important cement works and paper-mills. The extensive vineyards in the neighbourhood of the town were destroyed under the Phylloxera Act, but replanting subsequently revived this industry. Corio Bay, a safe and commodious harbour, is entered by two channels across its bar, one of which has a depth of 23½ ft. There is extensive quayside, and the largest wool ships are able to load alongside the wharves, which are connected by rail with

all parts of the colony. The facilities given for shipping wool direct to England from this port have caused a very extensive wool-broking trade to grow up in the town. The country surrounding Geelong is agricultural, but there are large limestone quarries east of the town, and in the Otway Forest, 23 m. distant, coal is worked. Geelong was incorporated in 1849.

GEESTEMÜNDE, a seaport town of Germany, in the Prussian province of Hanover, on the right bank of the Weser, at the mouth of the Geeste, which separates it from Bremerhaven, 32 m. N. from Bremen by rail. Pop. (1905) 23,625. The interest of the place is purely naval and commercial, its origin dating no farther back than 1857, when the construction of the harbour was begun. The great basin, which can accommodate large sea-going vessels, was completed in 1863, the petroleum basin was opened in 1874, and additional wharves have been constructed for the reception of vessels engaged in the fishing industry. The fish market of Geestemünde is the most important in Germany, and the auction hall practically determines the price of fish throughout the empire. The whole port is protected by powerful fortifications. Among the industrial establishments of the town are shipbuilding yards, foundries, engineering works and saw-mills.

GEFFCKEN, FRIEDRICH HEINRICH (1830-1896), German diplomatist and jurist, was born on the 9th of December 1830 at Hamburg, of which city his father was senator. After studying law at Bonn, Göttingen and Berlin, he was attached in 1854 to the Prussian legation at Paris. For ten years (1856-1866) he was the diplomatic representative of Hamburg in Berlin, first as chargé d'affaires, and afterwards as minister-resident, being afterwards transferred in a like capacity to London. Appointed in 1872 professor of constitutional history and public law in the reorganized university of Strassburg, Geffcken became in 1880 a member of the council of state of Alsace-Lorraine. Of too nervous a temperament to withstand the strain of the responsibilities of his position, he retired from public service in 1882, and lived henceforth mostly at Munich, where he died, suffocated by an accidental escape of gas into his bedchamber, on the 1st of May 1896. Geffcken was a man of great erudition and wide knowledge and of remarkable legal acumen, and from these qualities proceeded the personal influence he possessed. He was moreover a clear writer and made his mark as an essayist. He was one of the most trusted advisers of the Prussian crown prince, Frederick William (afterwards the emperor Frederick), and it was he (it is said, at Bismarck's suggestion) who drew up the draft of the New German federal constitution, which was submitted to the crown prince's headquarters at Versailles during the war of 1870-71. It was also Geffcken who assisted in framing the famous document which the emperor Frederick, on his accession to the throne in 1888, addressed to the chancellor. This memorandum gave umbrage, and on the publication by Geffcken in the *Deutsche Rundschau* (Oct. 1888) of extracts from the emperor Frederick's private diary during the war of 1870-71, he was, at Bismarck's instance, prosecuted for high treason. The Reichsgericht (supreme court), however, quashed the indictment, and Geffcken was liberated after being under arrest for three months. Publications of various kinds proceeded from his pen. Among these are *Zur Geschichte des orientalischen Krieges 1853-1856* (Berlin, 1881); *Frankreich, Russland und der Dreieubund* (Berlin, 1894); and *Staat und Kirche* (1875). English translation by E. F. Fairfax (1877). His writings on English history have been translated by S. J. Macmillan and published as *The British Empire, with essays on Prince Albert, Palmerston, Beaconsfield, Gladstone, and reform of the House of Lords* (1889).

GEFFROY, MATHIEU AUGUSTE (1820-1895), French historian, was born in Paris. After studying at the École Normale Supérieure he held history professorships at various lycées. His French thesis for the doctorate of letters, *Étude sur les pamphlets politiques et religieux de Milton* (1848), showed that he was attracted towards foreign history, a study for which he soon qualified himself by mastering the Germanic and Scandinavian languages. In 1851 he published a *Histoire des États Scandinaves*, which is especially valuable for clear arrangement and for the trustworthiness of its facts. Later, a long

stay in Sweden furnished him with valuable documents for a political and social history of Sweden and France at the end of the 18th century. In 1864 and 1865 he published in the *Revue des deux mondes* a series of articles on Gustavus III. and the French court, which were republished in book form in 1867. To the second volume he appended a critical study on *Marie Antoinette et Louis XVI apocryphes*, in which he proved, by evidence drawn from documents in the private archives of the emperor of Austria, that the letters published by Feuillet de Conches (*Louis XVI, Marie Antoinette et Madame Elisabeth*, 1864-1873) and Hunoldstein (*Corresp. inédite de Marie Antoinette*, 1864) are forgeries. With the collaboration of Alfred von Arneth, director of the imperial archives at Vienna, he edited the *Correspondance secrète entre Marie-Thérèse et le comte de Mercy-Argenteau* (3 vols., 1874), the first account based on trustworthy documents of Marie Antoinette's character, private conduct and policy. The Franco-German War drew Geoffroy's attention to the origins of Germany, and his *Rome et les Barbares: étude sur la Germanie de Tacite* (1874) set forth some of the results of German scholarship. He was then appointed to superintend the opening of the French school of archaeology at Rome, and drew up two useful reports (1877 and 1884) on its origin and early work. But his personal tastes always led him back to the study of modern history. When the Paris archives of foreign affairs were thrown open to students, it was decided to publish a collection of the instructions given to French ambassadors since 1648 (*Recueil des instructions données aux ambassadeurs et ministres de France depuis le traité de Westphalie*), and Geoffroy was commissioned to edit the volumes dealing with Sweden (vol.ii., 1885) and Denmark (vol. xiii., 1895). In the interval he wrote *Madame de Maintenon d'après sa correspondance authentique* (2 vols., 1887), in which he displayed his penetrating critical faculty in discriminating between authentic documents and the additions and corrections of arrangers like La Beaumelle and Lavallée. His last works were an *Essai sur la formation des collections d'antiques de la Suède* and *Des institutions et des mœurs du paganisme Scandinave: Finlande avant le Christianisme*, both published posthumously. He died at Bièvre on the 16th of August 1895.

GEFLE, a seaport of Sweden on an inlet of the Gulf of Bothnia, chief town of the district (*län*) of Gefleborg, 112 m. N.N.W. of Stockholm by rail. Pop. (1900) 29,522. It is the chief port of the district of Kopparberg, with its iron and other mines and forests. The exports consist principally of timber and wood-pulp, iron and steel. The harbour, which has two entrances about 20 ft. deep, is usually ice-bound in mid-winter. Large vessels generally load in the roads at Graberg, 6 m. distant. There are slips and shipbuilding yards, and a manufacture of sail-cloth. The town is an important industrial centre, having tobacco and leather factories, electrical and other mechanical works, and breweries. At Skutskär at the mouth of the Dal river are wood-pulp and saw mills, dealing with the large quantities of timber floated down the river; and there are large wood-yards in the suburb of Bomhus. Gefle was almost destroyed by fire in 1869, but was rebuilt in good style, and has the advantage of a beautiful situation. The principal buildings are a castle, founded by King John III. (1568-1592), but rebuilt later, a council-house erected by Gustavus III., who held a diet here in 1792, an exchange, and schools of commerce and navigation.

GEGENBAUR, CARL (1826-1903), German anatomist, was born on the 21st of August 1826 at Würzburg, the university of which he entered as a student in 1845. After taking his degree in 1851 he spent some time in travelling in Italy and Sicily, before returning to Würzburg as *Privatdocent* in 1854. In 1855 he was appointed extraordinary professor of anatomy at Jena, where after 1865 his fellow-worker, Ernst Haeckel, was professor of zoology, and in 1858 he became the ordinary professor. In 1873 he was appointed to Heidelberg, where he was professor of anatomy and director of the Anatomical Institute until his retirement in 1901. He died at Heidelberg on the 14th of June 1903. The work by which perhaps he is best known is his *Grundriss der vergleichenden Anatomie* (Leipzig, 1874; 2nd

edition, 1878). This was translated into English by W. F. Jeffrey Bell (*Elements of Comparative Anatomy*, 1878), with additions by E. Ray Lankester. While recognising the importance of comparative embryology in the study of descent, Gegenbaur laid stress on the higher value of comparative anatomy as the basis of the study of homologies, i.e. of the relations between corresponding parts in different animals, as, for example, the arm of man, the foreleg of the horse and the wing of a fowl. A distinctive piece of work was effected by him in 1871 in supplementing the evidence adduced by Huxley in refutation of the theory of the origin of the skull from expanded vertebrae, which, formulated independently by Goethe and Oken, had been championed by Owen. Huxley demonstrated that the skull is built up of cartilaginous pieces; Gegenbaur showed that "in the lowest (gristly) fishes, where hints of the original vertebrae might be most expected, the skull is an unsegmented gristly brain-box, and that in higher forms the vertebral nature of the skull cannot be maintained, since many of the bones, notably those along the top of the skull, arise in the skin." Other publications by Gegenbaur include a *Text-book of Human Anatomy* (Leipzig, 1883, new ed. 1903), the *Epiglottis* (1892) and *Comparative Anatomy of the Vertebrates in relation to the Invertebrates* (Leipzig, 2 vols., 1898-1901). In 1875 he founded the *Morphologisches Jahrbuch*, which he edited for many years. In 1901 he published a short autobiography under the title *Erlebtes und Erstrebt*.

See Fürbringer in *Heidelberger Professoren aus dem 19ten Jahrhundert* (Heidelberg, 1903).

GEGENSCHIEIN (Ger. *gegen*, opposite, and *schein*, shine), an extremely faint luminescence of the sky, seen opposite the direction of the sun. Germany was the country in which it was first discovered and described. The English rendering "counter-glow" is also given to it. Its faintness is such that it can be seen only by a practised eye under favourable conditions. It is invisible during the greater part of June, July, December and January, owing to its being then blotted out by the superior light of the Milky Way. It is also invisible during moonlight and near the horizon, and the neighbourhood of a bright star or planet may interfere with its recognition. When none of these unfavourable conditions supervene it may be seen at nearly any time when the air is clear and the depression of the sun below the horizon more than 20°. (See ZODIACAL LIGHT.)

GEIBEL, EMANUEL (1815-1884), German poet, was born at Lübeck on the 17th of October 1815, the son of a pastor in the city. He was originally intended for his father's profession, and studied at Bonn and Berlin, but his real interests lay not in theology but in classical and romance philology. In 1838 he accepted a tutorship at Athens, where he remained until 1840. In the same year he brought out, in conjunction with his friend Ernst Curtius, a volume of translations from the Greek. His first poems, *Zeitstimmen*, appeared in 1841; a tragedy, *König Rodrich*, followed in 1843. In the same year he received a pension from the king of Prussia, which he retained until his invitation to Munich by the king of Bavaria in 1851 as honorary professor at the university. In the interim he had produced *König Sigurds Brautfahrt* (1846), an epic, and *Juniuslieder* (1848, 33rd ed. 1901), lyrics in a more spirited and manlier style than his early poems. A volume of *Neue Gedichte*, published at Munich in 1857, and principally consisting of poems on classical subjects, denoted a further considerable advance in objectivity, and the series was worthily closed by the *Spätherbstblätter*, published in 1877. He had quitted Munich in 1869 and returned to Lübeck, where he died on the 6th of April 1884. His works further include two tragedies, *Brunnhild* (1858, 5th ed. 1890), and *Sophonisbe* (1869), and translations of French and Spanish popular poetry. Beginning as a member of the group of political poets who heralded the revolution of 1848, Geibel was also the chief poet to welcome the establishment of the Empire in 1871. His strength lay not, however, in his political songs but in his purely lyric poetry, such as the fine cycle *Ada* and his still popular love-songs. He may be regarded as the leading representative of German lyric poetry between 1848 and 1870.

Geibel's *Gesammelte Werke* were published in 6 vols. (1883, 4th ed. 1906); his *Gedichte* have gone through about 130 editions. An excellent selection in one volume appeared in 1904. For biography and criticism, see K. Goedeke, *E. Geibel* (1869); W. Scherer's address on Geibel (1884); K. T. Gaedertz, *Geibel-Denkwürdigkeiten* (1886); C. C. T. Litzmann, *E. Geibel, aus Erinnerungen, Briefen und Tagebüchern* (1887), and biographies by C. Leimbach (2nd ed., 1894), and K. T. Gaedertz (1897).

GEIGE (O. Fr. *gigue*, *gige*; O. Ital. and Spañ. *gigo*; Prov. *gigu*; O. Dutch *gighe*), in modern German the violin; in mediæval German the name applied to the first stringed instruments played with a bow, in contradistinction to those whose strings were plucked by fingers or plectrum such as the cithara, rotta and fidula, the first of these terms having been very generally used to designate various instruments whose strings were plucked. The name *gige* in Germany, of which the origin is uncertain,¹ and its derivatives in other languages, were in the middle ages applied to rebecs having fingerboards. As the first bowed instruments in Europe were, as far as we know, those of the rebec type, both boat-shaped and pear-shaped, it seems probable that the name clung to them long after the bow had been applied to other stringed instruments derived from the cithara, such as the fiddle (*videl*) or *vielle*. In the romances of the 12th and 13th centuries the *gige* is frequently mentioned, and generally associated with the rotta. Early in the 16th century we find definite information concerning the Geige in the works of Sebastian Virdung (1511), Hans Judenkünig (1523), Martin Agricola (1532), Hans Gerle (1533); and from the instruments depicted, of two distinct types and many varieties, it would appear that the principal idea attached to the name was still that of the bow used to vibrate the strings. Virdung qualifies the word *Geige* with *Klein* (small) and *Gross* (large), which do not represent two sizes of the same instrument but widely different types, also recognized by Agricola, who names three or four sizes of each, discant, alto, tenor and bass. Virdung's *Klein Geige* is none other than the rebec with two C-shaped soundholes and a raised fingerboard cut in one piece with the vaulted back and having a separate flat soundboard glued over it, a change rendered necessary by the arched bridge. Agricola's *Klein Geige* with three strings was of a totally different construction, having ribs and wide incurvations but no bridge; there was a rose soundhole near the tailpiece and two C-shaped holes in the shoulders. Agricola (*Musica instrumentalis*) distinctly mentions three kinds of *Geigen* with three, four and five strings. From him we learn that only one position was as yet used on these instruments, one or two higher notes being occasionally obtained by sliding the little finger along. A century later Agricola's *Geige* was regarded as antiquated by Praetorius, who reproduces one of the bridgeless ones with five strings, a rose and two C-shaped soundholes, and calls it an old fiddle; under *Geige* he gives the violins. (K. S.)

GEIGER, ABRAHAM (1810-1874), Jewish theologian and orientalist, was born at Frankfurt-on-Main on the 24th of May 1810, and educated at the universities of Heidelberg and Bonn. As a student he distinguished himself in philosophy and in philology, and at the close of his course wrote on the relations of Judaism and Mahomedanism a prize essay which was afterwards published in 1833 under the title *Was hat Mohammed aus dem Judentum aufgenommen?* (English trans. *Judaism and Islam*, Madras, 1898). In November 1832 he went to Wiesbaden as rabbi of the synagogue, and became in 1835 one of the most

¹ The words *gige*, *gigen*, *geic* appear suddenly in the M. H. German of the 12th century, and thence passed apparently into the Romance languages, though some would reverse the process (e.g. Weigand, *Deutsches Wörterbuch*). An elaborate argument in the *Deutsches Wörterbuch* of J. and W. Grimm (Leipzig, 1897) connects the word with an ancient common Teut. root *gag*—meaning to sway to and fro, as preserved in numerous forms: e.g. M.H.G. *gagen*, *gugen*, "to sway to and fro"; *gugen*, *gagen*, the rocking of a cradle; the Swabian *gigen*, *gagen*, in the same sense, the Tyrolean *gaigern*, to sway, doubt, or the old Norse *geign*, to go astray or crooked. The reference is to the swaying motion of the violin bow. The English "jig" is derived from *gige* through the O. Fr. *gigue* (in the sense of a stringed instrument); the modern French *gigue* (a dance) is the English "jig" re-imported (Hatzfeld and Darmesteter, *Dictionnaire*). This opens up another possibility, of the origin of the name of the instrument in the dance which it accompanied. (W. A. P.)

active promoters of the *Zeitschrift für jüdische Theologie* (1835-1839 and 1842-1847). From 1838 to 1863 he lived in Breslau, where he organized the reform movement in Judaism and wrote some of his most important works, including *Lehr- und Lesebuch zur Sprache der Mischeim* (1845), *Studien* from Maimonides (1850), translation into German of the poems of Juda ha-Levi (1851), and *Urschrift und Übersetzungen der Bibel in ihrer Abhängigkeit von der innern Entwicklung des Judentums* (1857). The last-named work attracted little attention at the time, but now enjoys a great reputation as a new departure in the methods of studying the records of Judaism. The *Urschrift* has moreover been recognized as one of the most original contributions to biblical science. In 1863 Geiger became head of the synagogue of his native town, and in 1870 he removed to Berlin, where, in addition to his duties as chief rabbi, he took the principal charge of the newly established seminary for Jewish science. The *Urschrift* was followed by a more exhaustive handling of one of its topics in *Die Sadduceer und Phariseer* (1863), and by a more thorough application of its leading principles in an elaborate history of Judaism (*Das Judentum und seine Geschichte*) in 1865-1871. Geiger also contributed frequently on Hebrew, Samaritan and Syriac subjects to the *Zeitschrift der deutschen morgenländischen Gesellschaft*, and from 1862 until his death (on the 23rd of October 1874) he was editor of a periodical entitled *Jüdische Zeitschrift für Wissenschaft und Leben*. He also published a Jewish prayer-book (*Israelitisches Gebetbuch*) and a variety of minor monographs on historical and literary subjects connected with the fortunes of his people. (I. A.)

An *Allgemeine Einleitung* and five volumes of *Nachgelassene Schriften* were edited in 1875 by his son LUDWIG GEIGER (b. 1848), who in 1880 became extraordinary professor in the university of Berlin. Ludwig Geiger published a large number of biographical and literary works and made a special study of German humanism. He edited the *Goethe-Jahrbuch* from 1880, *Vierteljahrsschrift für Kultur und Litteratur der Renaissance* (1885-1886), *Zeitschr. für die Gesch. der Juden im Deutschland* (1886-1891), *Zeitschr. für vergleichende Literaturgeschichte und Renaissance-Litteratur* (1887-1891). Among his works are *Johann Reuchlin, sein Leben und seine Werke* (Leipzig, 1871); and *Johann Reuchlin's Briefwechsel* (Tübingen, 1875); *Renaissance und Humanismus in Italien und Deutschland* (1882, 2nd ed. 1901); *Gesch. des geistigen Lebens der preussischen Hauptstadt* (1892-1894); *Berlin's geistiges Leben* (1894-1896).

See also J. Derenbourg in *Jüd. Zeitschrift*, xl. 299-308; E. Schrieber, *Abraham Geiger als Reformator des Judentums* (1880), art. (with portrait) in *Jewish Encyclopedia*.

Abraham Geiger's nephew LAZARUS GEIGER (1820-1870), philosopher and philologist, born at Frankfurt-on-Main, was destined to commerce, but soon gave himself up to scholarship and studied at Marburg, Bonn and Heidelberg. From 1861 till his sudden death in 1870 he was professor in the Jewish high school at Frankfurt. His chief aim was to prove that the evolution of human reason is closely bound up with that of language. He further maintained that the origin of the Indo-Germanic language is to be sought not in Asia but in central Germany. He was a convinced opponent of rationalism in religion. His chief work was his *Ursprung und Entwicklung der menschlichen Sprache und Vernunft* (vol. I., Stuttgart, 1868), the principal results of which appeared in a more popular form as *Der Ursprung der Sprache* (Stuttgart, 1869 and 1878). The second volume of the former was published in an incomplete form (1872, 2nd ed. 1890) after his death by his brother Alfred Geiger, who also published a number of his scattered papers as *Zur Entwicklung der Menschheit* (1871, 2nd ed. 1878; Eng. trans. D. Asher, *Hist. of the Development of the Human Race*, Lond., 1880).

See L. A. Rosenthal, *Laz. Geiger: seine Lehre vom Ursprung d. Sprache und Vernunft und sein Leben* (Stuttgart, 1883); E. Peschier, *L. Geiger, sein Leben und Denken* (1871); J. Keller, *L. Geiger und d. Kritik d. Vernunft* (Wertheim, 1883); and *Der Ursprung d. Vernunft* (Heidelberg, 1884).

GEIJER, ERIK GUSTAF (1783-1847), Swedish historian, was born at Ransäter in Värmland, on the 12th of January 1783, of a family that had immigrated from Austria in the 17th century.

He was educated at the university of Upsala, where in 1803 he carried off the Swedish Academy's great prize for his *Avenimus öfver Sten Sture den äldre*. He graduated in 1806, and in 1810 returned from a year's residence in England to become *docent* in his university. Soon afterwards he accepted a post in the public record office at Stockholm, where, with some friends, he founded the "Gothic Society," to whose organ *Iduna* he contributed a number of prose essays and the songs *Manhem*, *Vikingen*, *Den siste hämpen*, *Den siste skalden*, *Odalbonden*, *Kolargossen*, which he set to music. About the same time he issued a volume of hymns, of which several are inserted in the Swedish Psalter.

Geijer's lyric muse was soon after silenced by his call to be assistant to Erik Michael Fant, professor of history at Upsala, whom he succeeded in 1817. In 1824 he was elected a member of the Swedish Academy. A single volume of a great projected work, *Svea Rikes Häfder*, itself a masterly critical examination of the sources of Sweden's legendary history, appeared in 1825. Geijer's researches in its preparation had severely strained his health, and he went the same year on a tour through Denmark and part of Germany, his impressions from which are recorded in his *Minnen*. In 1832-1836 he published three volumes of his *Svenska folkets historia* (Eng. trans. by J. H. Turner, 1845), a clear view of the political and social development of Sweden down to 1654. The acute critical insight, just thought, and finished historical art of these incomplete works of Geijer entitle him to the first place among Swedish historians. His chief other historical and political writings are his *Teckning af Sveriges tillstånd 1718-1772* (Stockholm, 1838), and *Feodalism och republikanism, ett bidrag till Samhällsförhållningens historia* (1844), which led to a controversy with the historian Anders Fryxell regarding the part played in history by the Swedish aristocracy. Geijer also edited, with the aid of J. H. Schröder, a continuation of Fant's *Scriptores rerum suevicarum mediæ ævi* (1818-1828), and, by himself, Thomas Thorild's *Samlade skrifter* (1819-1825), and *Konung Gustaf III.'s efterlemnade Papper* (4 vols., 1843-1846). Geijer's academic lectures, of which the last three, published in 1845 under the title *Om vår tids inre samhällsförhållanden, i synnerhet med afseende på Föderationslandet*, involved him in another controversy with Fryxell, but exercised a great influence over his students, who especially testified to their attachment after the failure of a prosecution against him for heresy. A number of his extempore lectures, recovered from notes, were published in 1856. He also wrote a life of Charles XIV. (Stockholm, 1844). Failing health forced Geijer to resign his chair in 1846, after which he removed to Stockholm for the purpose of completing his *Svenska folkets historia*, and died there on the 23rd of April 1847. His *Samlade skrifter* (13 vols., 1849-1855; new ed., 1873-1877) include a large number of philosophical and political essays contributed to reviews, particularly to *Litteraturläbet* (1838-1839), a periodical edited by himself, which attracted great attention in its day by its pronounced liberal views on public questions, a striking contrast to those he had defended in 1828-1830, when, as again in 1840-1841, he represented Upsala University in the Swedish diet. His poems were collected and published as *Skaldestycken* (Upsala, 1835 and 1878).

Geijer's style is strong and manly. His genius bursts out in sudden flashes that light up the dark corners of history. A few strokes, and a personality stands before us instinct with life. His language is at once the scholar's and the poet's; with his profoundest thought there beats in unison the warmest, the noblest, the most patriotic heart. Geijer came to the writing of history fresh from researches in the whole field of Scandinavian antiquity, researches whose first-fruits are garnered in numerous articles in *Iduna*, and his masterly treatise *Om den gamla nordiska folkvisan*, prefixed to the collection of *Svenska folkvisor* which he edited with A. Afzelius (3 vols., 1814-1816). The development of freedom is the idea that gives unity to all his historical writings.

For Geijer's biography, see his own *Minnen* (1834), which contains copious extracts from his letters and diaries; B. E. Malmström, *Minnet af E. G. Geijer*, addressed to the Upsala students (June 6, 1848), and printed among his *Tal och estetiska afhandlingar* (1868), and *Grunddrag af Svenska litteraturens häfder* (1866-1868);

and S. A. Hollander, *Mémoir de E. G. Geijer* (Örebro, 1869). See also lives of Geijer by J. Hellstenius (Stockholm, 1876) and J. Nickson (Odense, 1902).

GEIKIE, SIR ARCHIBALD (1835-), Scottish geologist, was born at Edinburgh on the 28th of December 1835. He was educated at the high school and university of Edinburgh, and in 1855 was appointed an assistant on the Geological Survey. Wielding the pen with no less facility than the hammer, he inaugurated his long list of works with *The Story of a Boulder; or, Gleanings from the Note-Book of a Geologist* (1858). His ability at once attracted the notice of his chief, Sir Roderick Murchison, with whom he formed a lifelong friendship, and whose biographer he subsequently became. With Murchison some of his earliest work was done on the complicated regions of the Highland schists; and the small geological map of Scotland published in 1862 was their joint work: a larger map was issued by Geikie in 1892. In 1863 he published an important essay "On the Phenomena of the Glacial Drift of Scotland," *Trans. Geol. Soc. Glasgow*, in which the effects of ice action in that country were for the first time clearly and connectedly delineated. In 1865 appeared Geikie's *Scenery of Scotland* (3rd edition, 1901), which was, he claimed, "the first attempt to elucidate in some detail the history of the topography of a country." In the same year he was elected F.R.S. At this time the Edinburgh school of geologists—prominent among them Sir Andrew Ramsay, with his *Physical Geology and Geography of Great Britain*—were maintaining the supreme importance of denudation in the configuration of land-surfaces, and particularly the erosion of valleys by the action of running water. Geikie's book, based on extensive personal knowledge of the country, was an able contribution to the doctrines of the Edinburgh school, of which he himself soon began to rank as one of the leaders.

In 1867, when a separate branch of the Geological Survey was established for Scotland, he was appointed director. On the foundation of the Murchison professorship of geology and mineralogy at the university of Edinburgh in 1871, he became the first occupant of the chair. These two appointments he continued to hold till 1881, when he succeeded Sir Andrew Ramsay in the joint offices of director-general of the Geological Survey of the United Kingdom and director of the museum of practical geology, London, from which he retired in February 1901. A feature of his tenure of office was the impetus given to microscopic petrography, a branch of geology to which he had devoted special study, by a splendid collection of sections of British rocks. Later he wrote two important and interesting Survey Memoirs, *The Geology of Central and Western Fife and Kinross* (1900), and *The Geology of Eastern Fife* (1902).

From the outset of his career, when he started to investigate the geology of Skye and other of the Western Isles, he took a keen interest in volcanic geology, and in 1871 he brought before the Geological Society of London an outline of the Tertiary volcanic history of Britain. Many difficult problems, however, remained to be solved. Here he was greatly aided by his extensive travels, not only throughout Europe, but in western America. While the canyons of the Colorado confirmed his long-standing views on erosion, the eruptive regions of Wyoming, Montana and Utah supplied him with valuable data in explanation of volcanic phenomena. The results of his further researches were given in an elaborate and charmingly written essay on "The History of Volcanic Action during the Tertiary Period in the British Isles," *Trans. Roy. Soc. Edin.*, (1888). His mature views on volcanic geology were given to the world in his presidential addresses to the Geological Society in 1891 and 1892, and afterwards embodied in his great work on *The Ancient Volcanoes of Great Britain* (1897). Other results of his travels are collected in his *Geological Sketches at Home and Abroad* (1882).

His experience as a field geologist resulted in an admirable text-book, *Outlines of Field Geology* (5th edition, 1900) After editing and practically re-writing Jukes's *Student's Manual of Geology* in 1872, he published in 1882 a *Text-Book* and in 1886 a *Class-Book* of geology, which have taken rank as standard works of their kind. A fourth edition of his *Text-Book*, in two vols., was

issued in 1903. His writings are marked in a high degree by charm of style and power of vivid description. His literary ability has given him peculiar qualifications as a writer of scientific biography, and the *Memoir of Edward Forbes* (with G. Wilson), and those of his old chiefs, Sir R. I. Murchison (2 vols., 1875) and Sir Andrew Crombie Ramsay (1895), are models of what such works should be. His *Founders of Geology* consists of the inaugural course of Lectures (founded by Mrs G. H. Williams) at Johns Hopkins University, Baltimore, delivered in 1897. In 1897 he issued an admirable *Geological Map of England and Wales, with Descriptive Notes*. In 1898 he delivered the Romanes Lectures, and his address was published under the title of *Types of Scenery and their Influence on Literature*. The study of geography owes its improved position in Great Britain largely to his efforts. Among his works on this subject is *The Teaching of Geography* (1887). His *Scottish Reminiscences* (1904) and *Landscape in History and other Essays* (1905) are charmingly written and full of instruction. He was foreign secretary of the Royal Society from 1890 to 1894, joint secretary from 1903 to 1908, president in 1909, president of the Geological Society in 1891 and 1892, and president of the British Association, 1892. He received the honour of knighthood in 1891.

GEIKIE, JAMES (1839—), Scottish geologist, younger brother of Sir Archibald Geikie, was born at Edinburgh on the 23rd of August 1839. He was educated at the high school and university of Edinburgh. He served on the Geological Survey from 1861 until 1882, when he succeeded his brother as Murchison professor of geology and mineralogy at the university of Edinburgh. He took as his special subject of investigation the origin of surface-features, and the part played in their formation by glacial action. His views are embodied in his chief work, *The Great Ice Age and its Relation to the Antiquity of Man* (1874; 3rd ed., 1894). He was elected F.R.S. in 1875. James Geikie became the leader of the school that upholds the all-important action of land-ice, as against those geologists who assign chief importance to the work of pack-ice and icebergs. Continuing this line of investigation in his *Prehistoric Europe* (1881), he maintained the hypothesis of five inter-Glacial periods in Great Britain, and argued that the palaeolithic deposits of the Pleistocene period were not post- but inter- or pre-Glacial. His *Fragment of Earth Lore: Sketches and Addresses, Geological and Geographical* (1893) and *Earth Sculpture* (1898) are mainly concerned with the same subject. His *Outlines of Geology* (1886), a standard text-book of its subject, reached its third edition in 1896; and in 1905 he published an important manual on *Structural and Field Geology*. In 1887 he displayed another side of his activity in a volume of *Songs and Lyrics by H. Heine and other German Poets, done into English Verse*. From 1888 he was honorary editor of the *Scottish Geographical Magazine*.

GEIKIE, WALTER (1795—1837), Scottish painter, was born at Edinburgh on the 9th of November 1795. In his second year he was attacked by a nervous fever by which he permanently lost the faculty of hearing, but through the careful attention of his father he was enabled to obtain a good education. Before he had the advantage of the instruction of a master he had attained considerable proficiency in sketching both figures and landscapes from nature, and in 1812 he was admitted into the drawing academy of the board of Scottish manufactures. He first exhibited in 1815, and was elected an associate of the Royal Scottish Academy in 1831, and a fellow in 1834. He died on the 21st of August 1837, and was interred in the Greyfriars churchyard, Edinburgh. Owing to his want of feeling for colour, Geikie was not a successful painter in oils, but he sketched in India ink with great truth and humour the scenes and characters of Scottish lower-class life in his native city. A series of etchings which exhibit very high excellence were published by him in 1820—1831, and a collection of eighty-one of these was republished posthumously in 1841, with a biographical introduction by Sir Thomas Dick Lauder, Bart.

GEILER (or **GEYLER**) **VON KAISERSBERG, JOHANN** (1445—1510), "the German Savonarola," one of the greatest of the popular preachers of the 15th century, was born at Schaffhausen

on the 16th of March 1445, but from 1448 passed his childhood and youth at Kaisersberg in Upper Alsace, from which place his current designation is derived. In 1460 he entered the university of Freiburg in Baden, where, after graduation, he lectured for some time on the *Sententiae* of Peter Lombard, the commentaries of Alexander of Hales, and several of the works of Aristotle. A living interest in theological subjects, awakened by the study of John Gerson, led him in 1471 to the university of Basel, a centre of attraction to some of the most earnest spirits of the time. Made a doctor of theology in 1475, he received a professorship at Freiburg in the following year; but his tastes, no less than the spirit of the age, began to incline him more strongly to the vocation of a preacher, while his fervour and eloquence soon led to his receiving numerous invitations to the larger towns. Ultimately he accepted in 1478 a call to the cathedral of Strassburg, where he continued to work with few interruptions until within a short time of his death on the 10th of March 1510. The beautiful pulpit erected for him in 1481 in the nave of the cathedral, when the chapel of St Lawrence had proved too small, still bears witness to the popularity he enjoyed as a preacher in the immediate sphere of his labours, and the testimonies of Sebastian Brant, Beatus Rhenanus, Johann Reuchlin, Melancthon and others show how great had been the influence of his personal character. His sermons—bold, incisive, denunciatory, abounding in quaint illustrations and based on texts by no means confined to the Bible,—taken down as he spoke them, and circulated (sometimes without his knowledge or consent) by his friends, told perceptibly on the German thought as well as on the German speech of his time.

Among the many volumes published under his name only two appear to have had the benefit of his revision, namely, *Der Seelen Paradies von waren und volkommen Tugenden*, and that entitled *Das irrig Schaf*. Of the rest, probably the best-known is a series of lectures on his friend Seb. Brant's work, *Das Narrenschiff* or the *Navicula* or *Speculum fatuorum*, of which an edition was published at Strassburg in 1511 under the following title:—*Navicula sive Speculum fatuorum praestantissimi sacrarum literarum doctoris Joannis Geiler Keyserbergii*.

See F. W. von Ammon, *Geiler's Leben, Lehren und Predigten* (1826); L. Dacheux, *Un Réformateur catholique à la fin du XV^e siècle*, J. G. de K. (Paris, 1876); R. Cruel, *Gesch. der deutschen Predigt*, pp. 538—576 (1879); P. de Lorenzi, *Geiler's ausgewählte Schriften* (4 vols., 1881); T. M. Lindsay, *History of the Reformation*, i, 118 (1906); and G. Kawerau in Herzog-Hauck, *Realencyclopädie*, vi, 427.

GEINITZ, HANS BRUNO (1814—1900), German geologist, was born at Altenburg, the capital of the duchy of Saxe-Altenburg, on the 16th of October 1814. He was educated at the universities of Berlin and Jena, and gained the foundations of his geological knowledge under F. A. Quenstedt. In 1837 he took the degree of Ph.D. with a thesis on the Muschelkalk of Thuringia. In 1850 he became professor of geology and mineralogy in the Royal Polytechnic School at Dresden, and in 1857 he was made director of the Royal Mineralogical and Geological Museum, he held these posts until 1894. He was distinguished for his researches on the Carboniferous and Cretaceous rocks and fossils of Saxony, and in particular for those relating to the fauna and flora of the Permian or Dyas formation. He described also the graptolites of the local Silurian strata, and the flora of the Coal-formation of Altai and Nebraska. From 1863 to 1878 he was one of the editors of the *Neues Jahrbuch*. He was awarded the Murchison medal by the Geological Society of London in 1878. He died at Dresden on the 28th of January 1900. His son FRANZ EUGEN GEINITZ (b. 1854), professor of geology in the university of Rostock, became distinguished for researches on the geology of Saxony, Mecklenburg, &c.

H. B. Geinitz's publications were *Das Quadersandsteingebirge oder Kredegebirge in Deutschland (1849—1850)*, *Die Versteinerungen der Steinohlenformation in Sachsen* (1855); *Dyas, oder die Zechsteinformation und das Rothliegende (1861—1862)*; *Das Eibthälgebirge in Sachsen (1871—1875)*.

GEISHA (a Chino-Japanese word meaning "person of pleasing accomplishments"), strictly the name of the professional dancing and singing girls of Japan. The word is, however, often loosely used for the girls and women inhabiting Shin Yoshiwara, the prostitutes' quarter of Tokyo. The training of the true Geisha

or singing girl, which includes lessons in dancing, begins often as early as her seventh year. Her apprenticeship over, she contracts with her employer for a number of years, and is seldom able to reach independence except by marriage. There is a capitation fee of two *yes* per month on the actual singing girls, and of one *yes* on the apprentices.

See Jukichi Inouye, *Sketches of Tokyo Life*.

GEISLINGEN, a town of Germany in the kingdom of Württemberg, on the Thierbach, 38 m. by rail E.S.E. of Stuttgart. Pop. (1905) 7050. It has shops for the carving and turning of bone, ivory, wood and horn, besides iron-works, machinery factories, glass-works, brewing and bleaching works, &c. The church of St Mary contains wood-carving by Jörg Syrlin the Younger. Above the town lie the ruins of the castle of Helfenstein, which was destroyed in 1552. Having been for a few years in the possession of Bavaria, the town passed to Württemberg in 1810.

See Weibrecht, *Wanderungen durch Geislingen und seine Umgehung* (Stuttgart, 1896).

GEISLER, HEINRICH (1814-1879), German physicist, was born at the village of Igelshieb in Saxe-Meiningen on the 26th of May 1814 and was educated as a glass-blower. In 1854 he settled at Bonn, where he speedily gained a high reputation for his skill and ingenuity of conception in the fabrication of chemical and physical apparatus. With Julius Plücker, in 1852, he ascertained the maximum density of water to be at 3.8° C. He also determined the coefficient of expansion for ice between -24° and -7°, and for water freezing at 0°. In 1869, in conjunction with H. P. J. Vogelsang, he proved the existence of liquid carbon dioxide in cavities in quartz and topaz, and later he obtained amorphous from ordinary phosphorus by means of the electric current. He is best known as the inventor of the sealed glass tubes which bear his name, by means of which are exhibited the phenomena accompanying the discharge of electricity through highly rarefied vapours and gases. Among other apparatus contrived by him were a vaporimeter, mercury air-pump, balances, normal thermometer, and areometer. From the university of Bonn, on the occasion of his jubilee in 1868, he received the honorary degree of doctor of philosophy. He died at Bonn on the 24th of January 1879.

See A. W. Hofmann, *Ber. d. deut. chem. Ges.* p. 148 (1879).

GELA, a city of Sicily, generally and almost certainly identified with the modern Terranova (q.v.). It was founded by Cretan and Rhodian colonists in 688 B.C., and itself founded Agragas (see AGRIGENTUM) in 582 B.C. It also had a treasure-house at Olympia. The town took its name from the river to the east (Thucydides vi. 2), which in turn was so called from its winter frost (γάλα in the Sicel dialect; cf. Lat. *gelidus*). The Rhodian settlers called it Lindioi (see LINDUS). Gela enjoyed its greatest prosperity under Hippocrates (q.v.) in 498-491 B.C., whose dominion extended over a considerable part of the island. Gelon, who seized the tyranny on his death, became master of Syracuse in 485 B.C., and transferred his capital thither with half the inhabitants of Gela, leaving his brother Hiero to rule over the rest. Its prosperity returned, however, after the expulsion of Thrasylbulus in 466 B.C.,¹ but in 405 it was besieged by the Carthaginians and abandoned by Dionysius' order, after his failure (perhaps due to treachery) to drive the besiegers away (E. A. Freeman, *Hist. of Sic.* iii. 562 seq.). The inhabitants later returned and rebuilt the town, but it never regained its position. In 311 B.C. Agathocles put to death 5000 of its inhabitants; and finally, after its destruction by the Mamertines about 281 B.C., Phintias of Agrigentum transferred the remainder to the new town of Phintias (now Licata, q.v.). It seems that in Roman times they still kept the name of Gelenses or Geloi in their new abode (Th. Mommsen in *C.I.L.* x., Berlin, 1883, p. 737). (T. As.)

GELADA, the Abyssinian name of a large species of baboon, differing from the members of the genus *Papio* (see BABOON) by the nostrils being situated some distance above the extremity of the muzzle, and hence made the type of a separate genus, under the name of *Theropithecus gelada*. In the heavy mantle of long brown hair covering the fore-quarters of the old males,

¹ *Aeschylus* died there in 456 B.C.

with the exception of the bare chest, which is reddish flesh-colour, the gelada recalls the Arabian baboon (*Papio hamadryas*), and from this common feature it has been proposed to place the two species in the same genus. The gelada inhabits the mountains of Abyssinia, where, like other baboons, it descends in droves to pillage cultivated lands. A second species, or race, *Theropithecus obscurus*, distinguished by its darker hairs and the presence of a bare flesh-coloured ring round each eye, inhabits the eastern confines of Abyssinia. (R. L. *)

GELASIUS, the name of two popes.

GELASIUS I., pope from 492 to 496, was the successor of Felix III. He confirmed the estrangement between the Eastern and Western churches by insisting on the removal of the name of Acacius, bishop of Constantinople, from the diptychs. He is the author of *De duabus in Christo naturis adversus Eutychen et Nestorium*. A great number of his letters has also come down to us. His name has been attached to a *Liber Sacramentorum* anterior to that of St Gregory, but he can have composed only certain parts of it. As to the so-called *Decretum Gelasii de libris recipiendis et non recipiendis*, it also is a compilation of documents anterior to Gelasius, and it is difficult to determine Gelasius' contributions to it. At all events, as we know it, it is of Roman origin, and 6th-century or later. (L. D. *)

GELASIUS II. (Giovanni Coniulo), pope from the 24th of January 1118 to the 29th of January 1119, was born at Gaeta of an illustrious family. He became a monk of Monte Cassino, was taken to Rome by Urban II., and made chancellor and cardinal-deacon of Sta Maria in Cosmedin. Shortly after his unanimous election to succeed Paschal II. he was seized by Cencius Frangipane, a partisan of the emperor Henry V., but freed by a general uprising of the Romans in his behalf. The emperor drove Gelasius from Rome in March, pronounced his election null and void, and set up Burdinus, archbishop of Braga, as antipope under the name of Gregory VIII. Gelasius fled to Gaeta, where he was ordained priest on the 9th of March and on the following day received episcopal consecration. He at once excommunicated Henry and the antipope and, under Norman protection, was able to return to Rome in July; but the disturbances of the imperialist party, especially of the Frangipani, who attacked the pope while celebrating mass in the church of St Prassede, compelled Gelasius to go once more into exile. He set out for France, consecrating the cathedral of Pisa on the way, and arrived at Marseilles in October. He was received with great enthusiasm at Avignon, Montpellier and other cities, held a synod at Vienne in January 1119, and was planning to hold a general council to settle the investiture contest when he died at Cluny. His successor was Calixtus II.

His letters are in J. P. Migne, *Patrol. Lat.* vol. 163. The original life by Pandulf is in J. M. Watterich, *Pontif. Roman. vitae* (Leipzig, 1862), and there is an important digest of his bulls and official acts in Jaffé-Wattenbach, *Regesta pontif. Roman.* (1885-1888).

See J. Langen, *Geschichte der römischen Kirche von Gregor VII. bis Innocenz III.* (Bonn, 1893); F. Gregorovius, *Rome in the Middle Ages*, vol. 4, trans. by Mrs G. W. Hamilton (London, 1896); A. Wagner, *Die unteritalischen Normannen und das Papsttum, 1086-1150* (Breslau, 1885); W. von Giezbrecht, *Geschichte der deutschen Kaiserzeit*, Bd. iii. (Brunswick, 1890); G. Richter, *Annalen der deutschen Geschichte im Mittelalter*, iii. (Halle, 1898); H. H. Müllner, *Latin Christianity*, vol. 4 (London, 1899). (C. H. HA.)

GELATI, a Georgian monastery in Russian Transcaucasia, in the government of Kutais, 11 m. E. of the town of Kutais, standing on a rocky spur (705 ft. above sea-level) in the valley of the Rion. It was founded in 1109 by the Georgian king David the Renovator. The principal church, a sandstone cathedral, dates from the end of the preceding century, and contains the royal crown of the former Georgian kingdom of Imeretia, besides ancient MSS., ecclesiastical furniture, and fresco portraits of the kings of Imeretia. Here also, in a separate chapel, is the tomb of David the Renovator (1089-1125) and part of the iron gate of the town of Ganja (now Elisavetpol), which that monarch brought away as a trophy of his capture of the place.

GELATIN, or **GELATINE**, the substance which passes into solution when "collagen," the ground substance of bone, cartilage and white fibrous tissue, is treated with boiling water

or dilute acids. It is especially characterized by its property of forming a jelly at ordinary temperature, becoming liquid when heated, and resolidifying to a jelly on cooling. The word is derived from the Fr. *gelatine*, and Ital. *gelatina*, from the Lat. *gelata*, that which is frozen, congealed or stiff. It is, therefore, in origin cognate with "jelly," which came through the Fr. *glace* from the same Latin original.

The "collagen," obtained from tendons and connective tissues, also occurs in the cornea and sclerotic coat of the eye, and in fish scales. Cartilage was considered to be composed of a substance chondrin, which gave chondrin or cartilage-glue on boiling with water. Recent researches make it probable that cartilage contains (1) chondromucoid, (2) chondroitin-sulphuric acid, (3) collagen, (4) an albumoid present in old but not in young cartilage; whilst chondrin is a mixture of gelatin and mucin. "Bone collagen" or "ossein," constitutes, with calcium salts, the ground substance of bones. Gelatin consists of two substances, glutin and chondrin; the former is the main constituent of skin-gelatin, the latter of bone-gelatin.

True gelatinous tissue occurs in all mature vertebrates, with the single exception, according to E. F. I. Hoppe-Seyler, of the *Amphioxus lanceolatus*. Gelatinous tissue was discovered by Hoppe-Seyler in the cephalopods *Octopus* and *Sepioida*, but in an extension of his experiments to other invertebrates, as cockchafers and *Anodon* and *Urisa*, no such tissue could be detected. Neither glutin nor chondrin occurs ready formed in the animal kingdom, but they separate when the tissues are boiled with water. A similar substance, vegetable gelatin, is obtained from certain mosses.

Pure gelatin is an amorphous, brittle, nearly transparent substance, faintly yellow, tasteless and inodorous, neutral in reaction and unaltered by exposure to dry air. Its composition is in round numbers C=50, H=7, N=18, O=25%; sulphur is also present in an amount varying from 0.25 to 0.7%.

Nothing is known with any certainty as to its chemical constitution, or of the mode in which it is formed from albuminoids. It exhibits in a general way a connexion with that large and important class of animal substances called *proteids*, being, like them, amorphous, soluble in acids and alkalis, and giving in solution a left-handed rotation of the plane of polarization. Nevertheless, the ordinary well-recognized reactions for proteids are but faintly observed in the case of gelatin, and the only substances which at once and freely precipitate it from solution are mercuric chloride, strong alcohol and tannic acid.

Although gelatin in a dry state is unalterable by exposure to air, its solution exhibits, like all the proteids, a remarkable tendency to putrefaction; but a characteristic feature of this process in the case of gelatin is that the solution assumes a transient acid reaction. The ultimate products of this decomposition are the same as are produced by prolonged boiling with acid. It has been found that oxalic acid, over and above the action common to all dilute acids of preventing the solidification of gelatin solutions, has the further property of preventing in a large measure this tendency to putrefy when the gelatin is treated with hot solutions of this acid, and then freed from adhering acid by means of calcium carbonate. Gelatin so treated has been called *metagelatin*.

In spite of the marked tendency of gelatin solutions to develop ferment-organisms and undergo putrefaction, the stability of the substance in the dry state is such that it has even been used, and with some success, as a means of preserving perishable foods. The process, invented by Dr Campbell Morfit, consists in impregnating the foods with gelatin, and then drying them till about 10% or less of water is present. Milk gelatinized in this way is superior in several respects to the products of the ordinary condensation process, more especially in the retention of a much larger proportion of albuminoids.

Gelatin has a marked affinity for water, abstracting it from admixture with alcohol, for example. Solid gelatin steeped for some hours in water absorbs a certain amount and swells up, in which condition a gentle heat serves to convert it into a liquid; or this may be readily produced by the addition of a trace of alkali or mineral acid, or by strong acetic acid. In the last case, however, or if we use the mineral acids in a more concentrated form, the solution obtained has lost its power of solidifying, though not that of acting as a glue. This property is utilized in the preparation of liquid glue (see *GLUE*). By prolonged boiling of strong aqueous solutions at a high, or of weak solutions at a lower temperature, the characteristic properties of gelatin are impaired and ultimately destroyed. After this treatment it acts less powerfully as a glue, loses its tendency to solidify, and becomes increasingly soluble in

cold water; nevertheless the solutions yield on precipitation with alcohol a substance identical in composition with gelatin.

By prolonged boiling in contact with hydrolytic agents, such as sulphuric acid or caustic alkali, it yields quantities of leucin and glycocoll (so-called "sugar of gelatin," this being the method by which glycocoll was first prepared), but no tyrosin. In this last respect it differs from the great body of proteids, the characteristic solid products of the decomposition of which are leucin and tyrosin.

Gelatin occurs in commerce in varying degrees of purity, the purer form obtained from skins and bones (to which this article is restricted) is named gelatin; a preparation of great purity is "patent isinglass," while isinglass (*q.v.*) itself is a fish-gelatin; less pure forms constitute glue (*q.v.*), while a dilute aqueous solution appears in commerce as size (*q.v.*). The manufacture follows much the same lines as that of glue, but it is essential that the raw materials must be carefully selected, and in view of the consumption of most of the gelatin in the kitchen—for soups, jellies, &c.—great care must be taken to ensure purity and cleanliness.

In the manufacture of bone-gelatin the sorted bones are degreased as in the case of glue manufacture, and then transferred to vats containing a dilute hydrochloric acid, by which means most of the mineral matter is dissolved out, and the bones become flexible. Instead of hydrochloric acid some French makers use phosphoric acid. After being well washed with water to remove all traces of hydrochloric acid, the bones are bleached by leading in sulphur dioxide. They are now transferred to the extractors, and heated by steam, care being taken that the temperature does not exceed 85° C. The digestion is repeated, and the runnings are clarified, concentrated, re-bleached and jellied as with glue. Skin-gelatin is manufactured in the same way as skin-glue. After steeping in lime pits the selected skins are digested three times; the first and second runnings are worked up for gelatin, while the third are filtered for "size."

Vegetable gelatin is manufactured from a seaweed, genus *Laminaria*; from the tengusa, an American seaweed, and from Irish moss. The *Laminaria* is first extracted with water, and the residue with sodium carbonate; the filtrate is acidified with hydrochloric acid and the precipitated alginic acid washed and bleached. It is then dissolved in an alkali, the solution concentrated, and cooled down by running over horizontal glass plates. Flexible colourless sheets resembling animal gelatin are thus obtained. In America the weed is simply boiled with water; the solution filtered, and cooled to a thick jelly. Irish moss is treated in the same way. Both tengusa and Irish moss yield a gelatin suitable for most purposes; tengusa gelatin clarifies liquids in the same way as isinglass, and forms a harder and firmer jelly than ordinary gelatin.

Applications of Gelatin.—First and foremost is the use of gelatin as a food-stuff—in jellies, soups, &c. Referring to the articles *GLUE*, *ISINGLASS* and *SIZE* for the special applications of these forms of gelatin, we here enumerate the more important uses of ordinary gelatin. In photography it is employed in carbon-processes, its use depending on the fact that when treated with potassium bichromate and exposed to light, it is oxidized to insoluble compounds; it plays a part in many other processes. A solution of gelatin containing readily crystallized salts—alum, nitre, &c.—solidifies with the formation of pretty designs; this is the basis of the so-called "crystalline glass" used for purposes of ornamentation. It is also used for coating pills to prevent them adhering together and to make them tasteless. Compounded with various mineral salts, the carbonates and phosphates of calcium, magnesium and aluminium, it yields a valuable ivory substitute. It also plays a part in the manufacture of artificial leather, of India inks, and of artificial silk (the Vanduara Company processes).

GELDERLAND, GELDERS, or GULDERS, formerly a duchy of the Empire, on the lower Rhine and the Yssel, bounded by Friesland, Westphalia, Brabant, Holland and the Zuider Zee; part of which has become the province of Holland, dealt with separately below. The territory of the later duchy of Gelderland was inhabited at the beginning of the Christian era by the Teutonic tribes of the Sicambri and the Batavi, and later, during the period of the decline of the Roman empire, by the Chamavi and other Frank peoples. It formed part of the Caroling kingdom of Austrasia, and was divided into *pagi* or *gauws*, ruled by official counts (*comites-graves*). In 843, by the treaty of Verdun, it became part of Lotharingia (Lorraine), and in 879 was annexed to the kingdom of East Francia (Germany) by the treaty of Meerssen. The nucleus of the later county and duchy was the *gau* or district surrounding the town of Gelder or Gelre, lying between the Meuse and the Niers, and since 1715 included in Rhenish Prussia.

The early history is involved in much obscurity. There were

the 11th century a number of counts ruling in various parts of what was afterwards known as Gelderland. Towards the close of that century Gerard of Wassenburg, who besides the county of Gelre ruled over portions of Hamaland and Teisterbant, acquired a dominant position amongst his neighbours. He is generally reckoned as the first hereditary count of Gelderland (d. 1117/8). His son, Gerard II.—the Long—(d. 1131), married Irmingardis, daughter and heiress of Otto, count of Zutphen, and their son, Henry I. (d. 1182), inherited both countships. His successors Otto I. (1182–1207) and Gerard III. (1207–1229) were lovers of peace and strong supporters of the Hohenstaufen emperors, through whose favour they were able to increase their territories by acquisitions in the districts of Veluwe and Betuwe. He acted as guardian to his nephew Floris IV of Holland during his minority Otto II., the Lame (1229–1271), fortified several towns and bestowed privileges upon them for the purpose of encouraging trade. He became a person of so much importance that he was urged to be a candidate for the dignity of emperor. He preferred to support the claims of his cousin, William II. of Holland. In return for the loan of a considerable sum of money William gave to him the city of Nijmegen in pledge. His son Reinald I. (d. 1326) married Irmingardis, heiress of Limburg, and in right of his wife laid claim to the duchy against Adolf of Berg, who had sold his rights to John I of Brabant. War followed, and on the 5th of June 1288 Reinald, who meantime had also sold his rights to the count of Luxembourg, was defeated and taken prisoner at the battle of Woeringen. In this battle the count of Luxembourg was slain, and Reinald had to surrender his claims as the price of his defeat to John of Brabant. In 1310, in return for his support, Reinald received from the emperor Henry VII for all his territories *privilegium de non evocando*, i.e. the exemption of his subjects from the liability to be sued before any court outside his jurisdiction. In 1317 he was made a prince of the Empire. A wound received at the battle of Woeringen had affected his brain, and an insurrection against him was in 1316 headed by his son Reinald, who assumed the government under the title of "Son of the Count." Reinald I. was finally in 1320 immured in prison, where he died in 1326.

Reinald II., the Black (1326–1343), was one of the foremost princes in the Netherlands of his day. He married (1) Sophia, heiress of Mechlin, and (2) in 1331 Eleanor, sister of Edward III. of England. By purchase or conquest he added considerably to his territories. He did much to improve the condition of the country, to foster trade, to promote the prosperity of the towns, and to maintain order and security in his lands by wise laws and firm administration. In 1338 the title of duke was bestowed upon him by the emperor Louis the Bavarian, who at the same time granted to him the fief of East Friesland. He died in 1343, leaving three daughters by his first marriage, and two sons, Reinald and Edward, both minors, by Eleanor of England. His elder son was ten years of age, and succeeded to the duchy under the guardianship of his mother Eleanor. Declared of age two years later, the youthful Reinald III. found himself involved in many difficulties through the struggles between the rival factions named after the two noble families of Bronkhorst and Hekeken. What was the quarrel between them; and what the causes they represented, cannot now be ascertained with certainty. There is good reason, however, to believe that they were the counterparts of the contemporary Cod and Hook parties in Holland, and of the Schieringers and Vetkoopers in Friesland. In Gelderland the quarrel between them was converted into a dynastic struggle, the Hekeken recognizing Duke Reinald, while the Bronkhorsten set up his younger brother Edward. At the battle of Tiel (1361) Reinald was defeated and taken prisoner, and Edward held the duchy till 1371. He was a good and successful ruler, and his death by an arrow wound after a brilliant victory over the duke of Brabant near Baesweiler (August 1371), was a loss to his country. He was in his thirty-fifth year and left no heirs. Reinald was now taken from the prison in which he had been confined to reign once more, but his health was broken and he died childless three years afterwards. The war of factions again broke out, the half-sisters of Reinald III. and Edward both

claiming the inheritance, the elder, Matilda (Machteld), in her own right, the younger Maria on behalf of her seven-year-old boy William of Jülich, as the only male representative of the family. The Hekeken supported Matilda, the Bronkhorsten William of Jülich. The war of succession lasted till 1379, and ended in William's favour, the emperor Wenceslas (Wenzel) recognizing him as duke four years later.

Duke William was able, restless and adventurous, an ideal knight of the palmy days of chivalry. He took part in no less than five crusades with the Teutonic order against the heathen Lithuanians and Prussians. In 1393 he inherited the duchy of Jülich, and died in 1402. He was succeeded by his brother, Reinald IV (d. 1423), in the united sovereignty of Gelderland, Zutphen and Jülich, who, in accordance with a promise made before his accession, ceded the town of Emmerich to Duke Adolf of Cleves. He took the part of his brother-in-law, John of Arkel, against William VI. of Holland, and in a war of several years' duration was not successful in preventing the Arkel territory being incorporated in Holland. On his death without legitimate issue, Gelderland passed to the young Arnold of Egmont, grandson of his sister Johanna, who had married John, lord of Arkel, their daughter Maria (d. 1415) being the wife of John, count of Egmont (d. 1451). Arnold was recognized as duke in 1424 by the emperor Sigismund, but in the following year the emperor revoked his decision and bestowed the duchy upon Adolf of Berg. Arnold in retaliation laid claim to the duchy of Jülich, which had likewise been granted to Adolf by Sigismund, and a war followed in which the cities and nobles of Gelderland stood by Arnold, it ended in Arnold retaining Gelderland and Zutphen, and Gerard, the son of Adolf (d. 1437), being acknowledged as duke of Jülich. To gain the support of the estates of Gelderland in this war of succession, Arnold had been compelled to make many concessions limiting the ducal prerogatives, and granting large powers to a council consisting of representatives of the nobles and the four chief cities, and his extravagance and exactions led to continual conflicts, in which the prince was compelled to yield to the demands of his subjects. In his later years a conspiracy was formed against him, headed by his wife, the violent and ambitious Catherine of Cleves, and his son Adolf. Arnold was at first successful and Adolf had to go into exile; but he returned, and in 1465, having taken his father prisoner by treachery, interned him in the castle of Buren. Charles the Bold of Burgundy now seized the opportunity to intervene. In 1471 he forced Adolf to release his father, who sold the reversion of the duchy to the duke of Burgundy for 92,000 golden gulden. On the 23rd of February 1473 Arnold died, and Charles of Burgundy became duke of Gelderland. His succession was not unopposed. Nijmegen offered an heroic resistance and only fell after a long siege. After Charles's death in 1477 Adolf was released from the captivity in which he had been held, and placed himself at the head of a party in the powerful city of Ghent, which sought to settle the disputed succession by forcing a match between him and Mary, the heiress of Burgundy. On the 29th of June 1477, however, he was killed at the siege of Tournai; and Mary gave her hand to Maximilian of Austria, afterwards emperor. Catherine, Adolf's sister, made an attempt to assert the rights of his son Charles to the duchy, but by 1483 Maximilian had crushed all opposition and established himself as duke of Gelderland.

Charles of Egmont, however, did not surrender his claims, but with the aid of the French collected an army, and in the course of 1492 and 1493 succeeded in reconquering his inheritance. The efforts of Maximilian to recover the country were vain, and the successive governors of the Netherlands, Philip the Fair and his sister Margaret, fared no better. In 1507 Charles of Egmont invaded Holland and Brabant, captured Harderwijk and Bommel in 1511, threatened Amsterdam in 1512, and took Groningen. It was, undoubtedly, a great and heroic achievement for the ruler of a petty state like Gelderland thus to assert and maintain his independence for a long period against the overwhelming power of the house of Austria. It was not till 1528 that the emperor Charles V. could force him to accept the compromise of the treaty of Gorichen, by which he received Gelderland and Zutphen for

life as fiefs of the Empire. In 1534 the duke, who was childless, attempted to transfer the reversion of Gelderland to France, but this project was violently resisted by the estates of the duchy, and Charles was compelled by them in 1538 to appoint as his successor William V.—the Rich—of Cleves (d. 1592). Charles died the same year, and William, with the aid of the French, succeeded in maintaining his position in Gelderland for several years. The Habsburg power was, however, in the end too great for him, and he was forced to cede the duchy to Charles V. by the treaty of Venloo, signed on the 7th of September 1543.

Gelderland was now definitely amalgamated with the Habsburg dominions in the Netherlands, until the revolt of the Low Countries led to its partition. In 1579 the northern and greater part, comprising the three "quarters" of Nijmegen, Arnhem and Zutphen, joined the Union of Utrecht and became the province of Gelderland in the Dutch republic. Only the quarter of Roermonde remained subject to the crown of Spain, and was called Spanish Gelderland. By the treaty of Utrecht (1715) this was ceded to Prussia with the exception of Venloo, which fell to the United Provinces, and Roermonde, which, with the remaining Spanish Netherlands, passed to Austria. Of this, part was ceded to France at the peace of Basel in 1795, and the whole by the treaty of Lunéville in 1801, when it received the name of the department of the Roer. By the peace of Paris of 1814 the bulk of Gelderland was incorporated in the United Netherlands, the remainder falling to Prussia, where it forms the circle of Düsseldorf.

The rise of the towns in Gelderland began in the 13th century, river commerce and markets being the chief cause of their prosperity, but they never attained to the importance of the larger cities in Holland and Utrecht, much less to that of the great Flemish municipalities. They differed also from the Flemish cities in the nature of their privileges and immunities, as they did not possess the rights of communes, but only those of "free cities" of the Rhenish type. The power of the feudal lord over them was much greater. The states of Gelderland first became a considerable power in the land during the reign of Arnold of Egmont (1423-1473). Their claim to large privileges and a considerable share in the government of the county were formulated in a document drawn up at Nijmegen in April 1436. These the duke had to concede, and to agree further to the appointment of a council to assist him in his administration. From this time the absolute authority of the sovereign in Gelderland was broken. The states consisted of two members—the nobility and the towns. The towns were divided into four separate districts or "quarters" named after the chief town in each—Nijmegen, Arnhem, Zutphen and Roermonde. In the time of the republic, as has been stated above, the province of Gelderland comprised the three first-named "quarters" only. The three quarters had each of them peculiar rights and customs, and their representatives met together in a separate assembly before taking part in the diet (*landdag*) of the states. The nobility possessed great influence in Gelderland and retained it in the time of the republic. (G. E.)

GELDERLAND (*Gueders*), a province of Holland, bounded S. by Rhenish Prussia and North Brabant, W. by Utrecht and South Holland, N. by the Zuider Zee, N.E. by Overysel, and S.E. by the Prussian province of Westphalia. It has an area of 1906 sq. m. and a pop. (1900) of 566,549. Historically it was part of the duchy of Gelderland, which is treated separately above.

The main portion of Gelderland north of the Rhine and the Old Ysel forms as it were an extension of the province of Overysel, being composed of diluvial sand and gravel, covered with sombre heaths and patches of fen. South of this line, however, the soil consists of fertile river-clay. The northern portion is divided by the New (or Gelders) Ysel into two distinct regions, namely, the Veluwe ("bad land") on the west, and the former countship of Zutphen on the east. In this last division the ground slopes downwards from south-east to north-west (131 to 26 ft.) and is intersected by several fertilizing streams which flow in the same direction to join the Ysel. The extreme eastern corner is occupied by older Tertiary loam, which is used for making bricks, and

upon this and the river-banks are the most fertile spots, woods, cultivated land, pastures, towns and villages. The highlands of the Veluwe lying west of the Ysel really extend as far as the Crooked Rhine and the Vecht in the province of Utrecht, but are slightly detached from the Utrecht hills by the so-called Gelders valley, which forms the boundary between the two provinces. This valley extends from the Rhine along the Grift, the Lunterche Beek, and the Eem to the Zuider Zee, and would still offer an outlet in this direction to the Rhine at high water if it were not for the river dikes. The two main ridges of the Veluwe hills (164 and 360 ft.) extend from the neighbourhood of Arnhem north to Harderwyk and north-east to Hattem. In the south they stretch themselves along the banks of the Rhine, forming a strip of picturesque river scenery made up of the varied elements of sandhills and trees, clay-lands and pastures. A large number of country-houses and villas are to be found here, and the river-side villages of Dieren, Velp and Renkum. All over the Veluwe, are heaths, scantily cultivated, with fields of rye and buckwheat, cattle of inferior quality, and sheep, and a sparse population. There is also a considerable cultivation of wood, especially of fir and copse, while tobacco plantations are found at Nykerk and Wageningen.

The southern division of the province presents a very different aspect, and contains many old towns and villages. It is watered by the three large rivers, the Rhine, the Waal and the Maas, and has a level clay soil, varied only by isolated hills and a sandy, wooded stretch between Nijmegen and the southern border. The region enclosed between the Rhine and the Waal and watered by the Linge is called the Betuwe ("good land"), and gave its name to the Germanic tribe of Batavians, who are sometimes wrongly regarded as the parent stock of the Dutch people. There is here a denser population, occupied in the cultivation of wheat, beetroot and fruit, the breeding of excellent cattle, shipping and industrial pursuits. The principal centres of population, such as Zutphen, Arnhem (the chief town of the province), Nijmegen and Tiel, lie along the large rivers. Smaller, but of equal antiquity, are the riverside towns of Doesburg, which is strongly fortified; Wageningen, with the State agricultural schools; Doetinchem, with a bridge over the Old Ysel which is mentioned as early as the 14th century; Zalt-Bommel, with an old church (1304), and a railway bridge over the Waal; and Kulenburg, with a fine railway bridge (1863-1868) over the Rhine. Five m. S. of Zalt-Bommel, on the Maas, is the medieval castle of Ammerzode or Ammersooi, also called Amelroy during the French occupation in 1674. It is in an excellent state of preservation and has been restored in modern times. The first authentic record of the castle is its possession by John de Herlar of the noble family of Loo at the end of the 13th century. In 1480 it passed by marriage to the powerful lords van Arkel, and was partly destroyed by fire at the end of the 16th century. The chapel dates from the 15th century, and the keep from 1564. Among the family portraits are works by Albert Dürer. Zetten, on the railway between Nijmegen and Tiel, is famous for the charitable institutions founded here by the preacher Otto Gerhard Heldring (d. 1876). They comprise a penitentiary (1849) for women; an educational home (1858) for girls; a theological training college (1864); and a Magdalen hospital. Nykerk, Harderwyk and Elburg are fishing towns on the Zuider Zee. Apeldoorn is situated on the edge of the sand-grounds. Heerenberg on the south-eastern border is remarkable for its ancient castle near the seat of the powerful lords van den Bergh. Other ancient and historical towns bordering on the Prussian frontier are Zevenaar, which was for long the cause of dispute between the houses of Cleves and Gelder and was finally attached to the kingdom of the Netherlands in 1816; Bredevoort, once the seat of a lordship of the same name belonging to the counts van Loon or Lohn, who built a castle here in the beginning of the 13th century which was destroyed in 1646—the lordship was presented to Prince William III. in 1697; Winterswyk, now an important railway junction, and of growing industrial importance; and Borkeloo, or Borkulo, the seat of an ancient lordship dating from the first half of the 12th century, which

GELSENKIRCHEN, a town of Germany in the Prussian province of Westphalia, 27 m. W. of Dortmund on the railway Duisburg-Hamm. Pop. (1905) 147,037. It has coal mines, iron furnaces, steel and boiler works, and soap, glass and chemical factories. In 1903 various neighbouring industrial townships were incorporated with the town.

GEM (Lat. *gemma*, a bud,—from the root *gen*, meaning “to produce,”—or precious stone; in the latter sense the Greek term is $\psi\acute{\eta}\phi\omicron\varsigma$), a word applied in a wide sense to certain minerals which, by reason of their brilliancy, hardness and rarity, are valued for personal decoration; it is extended to include pearl. In a restricted sense the term is applied only to precious stones after they have been cut and polished as jewels, whilst in their raw state the minerals are conveniently called “gem-stones.” Sometimes, again, the term “gem” is used in a yet narrower sense, being restricted to engraved stones, like seals and cameos.

The subject is treated here in two sections: (1) Mineralogy and general properties; (2) Gems in Art, *i.e.* engraved gems, such as seals and cameos. The artificial products which simulate natural gem-stones in properties and chemical composition are treated in the separate article **GEM, ARTIFICIAL**.

1. MINERALOGY AND GENERAL PROPERTIES

The gem-stones form a small conventional group of minerals, including principally the diamond, ruby, sapphire, emerald and opal. Other stones of less value—such as topaz, spinel, chrysoberyl, chrysolite, zircon and tourmaline—are sometimes called “fancy stones.” Many minerals still less prized, yet often used as ornamental stones,—like moonstone, rock-crystal and agate,—occasionally pass under the name of “semi-precious stones,” but this is rather a vague term and may include the stones of the preceding group. The classification of gem-stones is, indeed, to some extent a matter of fashion.

Descriptions of the several gem-stones will be found under their respective headings, and the present article gives only a brief review of the general characters of the group.

A high degree of hardness is an essential property of a gemstone, for however beautiful and brilliant a mineral may be it is useless to the jeweller if it lack sufficient hardness to withstand the abrasion to which articles of personal decoration are necessarily subjected. Even if not definitely scratched, the polished stone becomes dull by wear. Imitations in paste may be extremely brilliant, but being comparatively soft they soon lose lustre when rubbed. In the article **MINERALOGY** it is explained that the varying degrees of hardness are registered on a definite scale. The exceptional hardness of the diamond gives it a supreme position in this scale, and to it the arbitrary value of 10 has been assigned. The corundum gemstones (ruby and sapphire), though greatly inferior in hardness to the diamond, come next, with the value of 9; and it is notable that the sapphire is usually rather harder than ruby. Then follows the topaz, which, with spinel and chrysoberyl, has a hardness of 8; whilst quartz falls a degree lower. Most gemstones are harder than quartz, though precious opal, turquoise, moonstone and sphen are inferior to it in hardness. Those stones which are softer than quartz have been called by jewellers *demi-dures*. To test the hardness of a cut stone, one of its sharp edges may be drawn, with firm pressure, across the smooth surface of a piece of quartz; if it leave a scratch its hardness must be above 7. The stone is then applied in like manner to a fragment of topaz, preferably a cleavage-piece, and if it fail to leave a distinct scratch its hardness is between 7 and 8, whereas if the topaz be scratched it is above 8. An expert may obtain a fair idea of hardness by gently passing the stone over a fine steel file, and observing the feel of the stone and the grating sound which it emits. If a stone be scratched by a steel knife its hardness is below 6. The degree of hardness of a precious stone is soon ascertained by the lapidary when cutting it.

Gem-stones differ markedly among themselves in density or specific weight; and although this is a character which does not directly affect their value for ornamental purposes, it furnishes by its constancy an important means of distinguishing one stone

from another. Moreover, it is a character very easily determined and can be applied to cut stones without injury. The relative weightiness of a stone is called its specific gravity, and is often abbreviated as S.G. The number given in the description of a mineral as S.G. shows how many times the stone is heavier than an equal bulk of the standard with which it is compared, the standard being distilled water at 4° C. If, for example, the S.G. of diamond is said to be 3.5 it means that a diamond weighs $\frac{3}{2}$ times as much as a mass of water of the same bulk. The various methods of determining specific gravity are described under **DENSITY**. The readiest method of testing precious stones, especially when cut, is to use dense liquids. Suppose it be required to determine whether a yellow stone be true topaz or false topaz (quartz), it is merely necessary to drop the stone into a liquid made up to the specific gravity of about 3; and since topaz has S.G. of 3.5 it sinks in this medium, but as quartz has S.G. of only 2.65 it floats. The densest gemstone is zircon, which may have S.G. as high as 4.7, whilst the lowest is opal with S.G. 2.2. Amber, it is true, is lighter still, being scarcely denser than water, but this substance can hardly be called a gem.

Although the great majority of precious stones occur crystallized, the characteristic form is destroyed in cutting. The crystal-forms of the several stones are noticed under their respective headings, and the subject is discussed fully under **CRYSTALLOGRAPHY**. A few substances, used as ornamental stones—like opal, turquoise, obsidian and amber—are amorphous or without crystalline form; whilst others, like the various stones of the chalcocopy group, display no obvious crystal-characters, but are seen under the microscope to possess a crystalline structure. Gem-stones are frequently found in gravels or other detrital deposits, where they occur as rolled crystals or fragments of crystals, and in many cases have been reduced to the form of pebbles. By the disintegration of the rock which formed the original matrix, its constituent minerals were set free, and whilst many of them were worn away by long-continued attrition, the gem-stones survived by virtue of their superior hardness.

Many crystallized gem-stones exhibit cleavage, or a tendency to split in definite directions. The lapidary recognizes a “grain” in the stone. When the cleavage is perfect, as in topaz, it may render the working of the stone difficult, and produce incipient cracks in the cut gem. Flaws due to the cleavage planes are called “feathers.” The octahedral cleavage of the diamond is taken advantage of in dressing the stone before cutting it. The cutting of gem-stones is explained under **LAPIDARY**.

The beauty and consequent value of gems depend mainly on their colour. Some stones, it is true, are valued for entire absence of colour, as diamonds of pure “water.” Certain kinds of sapphire and topaz, too, are “water clear,” as also is pure rock-crystal; but in most stones colour is a prime element of attraction. The colour, however, is not generally an essential property of the mineral, but is due to the presence of foreign pigmentary matter, often in very small proportion and in some cases eluding determination. Thus, corundum when pure is colourless, but the presence of traces of certain mineral substances imparts to it not only the red of ruby and the blue of sapphire, but almost every other colour. The tinctorial matter may be distributed either uniformly throughout the stone or in regular zones, or in quite irregular patches. A tourmaline, for instance, may be red at one end of a prismatic crystal and green at the other extremity, or the colour may be so disposed that a transverse section the centre will be red and the outer zone green. A beryl may be yellow and green in the same crystal. Sapphire, again, is often parti-coloured, one portion of the stone being blue and other portions white or yellow; and the skilled lapidary, in cutting the stone, will take advantage of the blue portion. The character of the pigment is in many cases not definitely known. It by no means follows that the material capable of imparting a certain tint to glass is identical with that which naturally colours a stone of the same tint; thus a glass sapphire-blue may be obtained by the use of cobalt, yet cobalt



-5.—ORIENTAL.

1. Babylonian (late Sumerian) Cylinder of a Viceroy of Ur-Gur (or Ur-Engur), 2500 B.C.
2. Assyrian Cylinder. Woman adoring Goddess.
3. Assyrian Cylinder. Assur worshipped by two Assyrian Kings, and divine Attendants.
4. Persian Seal of Darius (500 B.C.). Lion Hunt.
5. Graeco-Persian Scarabaeoid. Boar Hunt.

-15.—CRETAN AND MYCENAEAN INTAGLIOS.

6. Cretan Symbols.
7. Man and Bull. Crete.
8. Lions and Column. Ialysus.
9. Daemon. Crete.
10. Lioness and Deer.
- 11-13. Three-sided Stone. Peloponnesus.
14. Man and Bull. Crete.
15. Bull and Palm. Ialysus.

16-18.—GEMS OF THE ISLANDS.

16. Goddess on Waves. Birds.
17. Lion and Goat.
18. Heracles and Nereus.

19.—PHOENICIAN SEAL, inscribed.

20-26.—GRAECO-PHOENICIAN SCARABS FROM TIARROS.

20. King, enthroned.
21. Bes with Antelope and Hound.
22. Bes with Lions.
23. Warrior.
24. Egyptian Device.
25. Bes and Goats.
26. Hawk of Horus.

All the above are in the British Museum.



27-34.—EARLY GREEK SCARABS AND SCARABAEIDS.

- 27. Pluto and Persephone. (New York.)
- 28. Boreas and Oreithya. (New York.)
- 29. Youth and Dog.
- 30. Archer feeling Arrow Tip. (Lord Southesk.)
- 31. Satyr and Wine Cup. 32. Archer and Dog.
- 33. Satyr with Wineskin.
- 34. Athena with Gorgon Spoils.

35-44.—FINEST GREEK SCARABS AND SCARABAEIDS.

- 35. Head of Young Warrior.
- 36. Lyre Player. (Cockerell Coll.)
- 37. Crane, with Deer's Antler. 38. Head of Eos.
- 39. Lyre Player. (Woodhouse Coll. and B.M.)
- 40. Lyre Player, signed by Syries.
- 41. Stork and Grasshopper, signed by Dexamenos. (St. Petersburg.)
- 42. Flying Crane, signed by Dexamenos. (St. Petersburg.)
- 43. Flying Goose. 44. Lion and Stag.

45-54.—ETRUSCAN SCARABS.

- 45. Achilles in Retirement.
- 46. Victory.
- 47. Capaneus struck by the Bolt.
- 48. Heracles.
- 49. Capaneus struck by the Bolt.
- 50. Achilles.
- 51. Heracles and Cycnus.
- 52. Heracles.
- 53. Heracles and the Lion.
- 54. Machaon bandaging Philoctetes.

55-57.—GREEK GEMS.

- 55. Girl with Scroll and Lyre. 56. Girl with Water-Jar.
- 57. Head of Aristippus—Deities.

58-61.—SIGNED GEMS.

- 58. Asclepius of Aulos. 59. Citharist of Allion.
- 60. Medusa of Solon. 61. Heracles of Gnaïos.

62-70.—ROMAN GEMS.

- 62. Portrait.
- 63. Head of Trajan Decius.
- 64. Ares and Aphrodite. 65. Jupiter of Heliopolis.
- 66. Artemis of Ephesus. 67. So-called Psyche.
- 68. So-called Psyche.
- 69. Minerva with Mask. Stamp for the Eye Balsam of Herophilus.
- 70. Helios.

71-72.—CHRISTIAN GEMS.

- 71. Crucifixion. 72. Good Shepherd. Jonah.

73-76.—EIGHTEENTH CENTURY GEMS.

- 73. Achilles of Pamphilus, copied from the antique.
- 74. Eros and Psyche, by Pichler.
- 75. Head of Athena.
- 76. Athena, from Townley Bust by Marchant.

All the above are in the British Museum, unless otherwise stated.

has not been detected in the sapphire. Probably the most common mineral pigments are compounds of iron, manganese, copper and chromium. If the colour of the stone be discharged by heat, an organic pigment is presumably present. Some ornamental stones change their colour, or even lose it, on exposure to sunlight and air: such is the case with rose-quartz, chrysoptase and certain kinds of topaz and turquoise. Exposure to heat alters the colour of some stones so readily that the change is taken advantage of commercially; thus, sherry-yellow topaz may be rendered pink, smoky and amethystine quartz may become yellow, and coloured zircons may be decolorized, so as to resemble diamonds.

The colours of some gem-stones are greatly affected by radioactivity, and Prof. F. Bords has found this to be particularly the case with sapphire. From his experiments he believes that yellow corundum, or oriental topaz, may have been formed from blue corundum under the influence of radioactive substances present in the soil in which the sapphire was embedded. Different shades of colour may be presented by different stones of the same species; and it was formerly the custom of lapidaries to regard the darker stones as masculine and the paler as feminine, a full blue sapphire, for instance, being called a "male sapphire" and a delicate blue stone a "female sapphire." It is notable that some stones appear to change colour by candle-light and by most other artificial means of illumination; some amethysts thus become inky, and certain sapphires acquire a murky tint, whilst others become amethystine. For an example of a remarkable change of this character, see ALEXANDRITE.

As the optical properties of minerals are fully explained under CRYSTALLOGRAPHY, little need be said here on this subject.

Refractive. The brilliancy of a cut stone depends on the amount of light reflected from its faces; and in the form known as the "brilliant" the gem is so cut that much of the incident light, after entering the stone and suffering refraction, is totally reflected from the facets at the back. The amount of light which is thus returned to the eye of the observer will be greater as the angle of total reflection, or critical angle, is smaller, but this angle will be small if the refractive power of the stone is great, so that the brilliancy directly depends on the refractivity. The diamond has the highest refractive index of any gem-stone (2.42). Jargon, or zircon, has also a high index (mean 1.95), and sphene, which is occasionally cut as a gem, is likewise very notable in this respect. The index of refraction generally bears a relation to the specific gravity of the stone, the heaviest gems having the highest indices, though a few minerals offer exceptions. The refractive index, which is thus a very important character in the scientific discrimination of gem-stones, may be conveniently determined, within certain limits, by means of the refractometer devised by Dr G. F. Herbert Smith. This instrument is an improved form of the total reflectometer, in which the refractive power of a given substance is determined by the method of total reflection. It may be used for indices ranging from 1.300 to 1.775, and may be applied to faceted stones without removal from their settings.

The play of prismatic colours exhibited by a cut stone, often known as its "fire," is due to the decomposition of the white light which enters the stone, and is returned, by internal reflection, after resolution into its coloured components.

Dispersion. This decomposition depends on the dispersive power of the substance. The exceptional beauty of the fiery flashes in the diamond is due to its high dispersion, in other words, to the difference between the refractive indices for the red rays and the violet rays at the extremities of the spectrum. The peculiar lustre exhibited by the diamond is called adamantine, and is shared to some extent by certain other stones which have a high refractive index and high dispersion, such as zircon.

The use of the spectroscope may be valuable in discriminating between certain precious stones. It was shown by Sir A. H.

Spectroscopic characters. Church that almandine garnet and zircon when simply viewed through this instrument give, under proper conditions, characteristic absorption spectra, due to the light reflected from the stone having penetrated to some extent into the substance of the mineral and suffered

absorption. It is sometimes useful to examine the behaviour of a stone under the action of the Röntgen rays.

A very useful means of discriminating between certain stones is found in their dichroism, or, to use a more general term, pleochroism. Neither amorphous minerals, like opal, nor minerals crystallizing in the cubic system, like spinel and garnet, possess this property; but coloured minerals which are doubly refracting may show different colours, when properly examined, in different directions. Occasionally this is so marked as to be detected by the naked eye, as in iolite or dichroite, but usually the stone needs to be examined with such an instrument as Haidinger's dichroscope (see CRYSTALLOGRAPHY). It must be remembered that in the direction of an optic axis the two images will be of the same colour in all positions of the instrument, and it is therefore necessary before reaching a definite conclusion to turn the stone about and examine it in various directions. The use of the dichroscope is so simple that it can be applied by any one to the examination of a cut stone, but there are other means of determining the nature of a stone by its optical properties available to the mineralogist and more suitably discussed under CRYSTALLOGRAPHY.

In chemical composition the gem-stones present great variety. Diamond is composed of only a single element; ruby, sapphire and the quartz-group are oxides; spinel and chrysoberyl may be regarded as aluminates; turquoise and beryllonite are phosphates; and a great number of ornamental stones are silicates of greater or less complexity, such as emerald, topaz, chrysolite, garnet, zircon, tourmaline, kunzite, sphene and benitoite. In the examination of a cut stone chemical tests are not available, since they usually involve the partial destruction of the mineral. The artificial production of certain gems by chemical processes which yield products identical in composition and physical properties with the natural stones, is described in the article GEM, ARTIFICIAL.

Doublets and triplets are composite stone, sometimes prepared for fraudulent purposes. In a doublet a slab of real gem-stone covers the face of a paste, whilst in a triplet the paste is both faced and backed by a slice of genuine stone. By the action of a suitable solvent, such as chloroform or in some cases even hot water, the cement uniting the pieces gives way and the compound character of the structure is detected.

Before the chemical composition of gem-stones was understood, their classification remained vague and unscientific. As the ancients depended almost entirely on the eye, the colour of the stone naturally became the chief factor in classification. A variety of stones agreeing roughly in colour would be grouped together under a common name, widely as they might differ in other respects. Thus the emerald, the peridot, green fluorspar, malachite, and certain kinds of quartz and jade seem to have been united under the general name of *σμάραγδος*; whilst the ruby, red spinel and garnet were probably grouped together as *carbunculus*. In this way minerals radically different were associated on the ground of what is generally a superficial and accidental character, and rarely of any classificatory value. On the other hand, a grouping based only on colour led to several names being in some cases applied to the same mineral species. Thus the ruby and sapphire are essentially identical in chemical composition and in all physical characters, save colour.

Descriptions of precious stones by ancient writers generally are too vague for exact diagnosis. The principal classical authorities are Theophrastus and the elder Pliny. Stones were formerly held in esteem not only for their beauty and rarity but for the medicinal and magical powers with which they were reputed to be endowed. Up to comparatively recent years the toadstone, for example, was worn not for beauty but for sake of occult virtue; and even at the present day certain stones, like jade, are valued for a similar reason. Prof. W. Ridgeway has suggested that jewelry took its origin not, as often supposed, in an innate love of personal decoration, but rather in the belief that the objects used possessed magical virtue. Small stones peculiar in colour or shape, especially those with natural perforations, are usually valued by uncivilized peoples

Dichroism.

Chemical composition.

Supernatural.

as amulets. The Orphic poem *Αἰθιᾶ*, reputed to be of very early though unknown date, is rich in allusions to the virtues of many of the gem-stones. Many of the medical and other virtues of precious stones were evidently attributed to them on the well-known doctrine of signatures. Thus, the blood-red colour of a fine jasper suggested that the stone would be useful in haemorrhage; a green jasper would bring fertility to the soil, and the purple wine-colour of amethyst pointed to its value as a preventive of intoxication. Many of the superstitions came down to modern times, and even at the present day the belief in "lucky stones" is by no means extinct.

BIBLIOGRAPHY.—The most comprehensive work on gem-stones is Professor Max Bauer's *Edelsteinkunde* (1896), translated, with additions, by L. J. Spencer under the title *Precious Stones* (1902). Less detailed are Professor P. Groth's *Grundriss der Edelsteinkunde* (1887) and Professor C. Doelter's *Edelsteinkunde* (1893). Sir A. H. Church's *Precious Stones* (1905), intended as a guide to the collections in the Victoria and Albert Museum, is a convenient introduction; and Professor H. A. Miers's Cantor Lectures at the Society of Arts on *Precious Stones* (1896) may be studied with advantage. For American stones, the valuable work of Dr G. F. Kunz, *The Gems and Precious Stones of N. America*, is a standard authority; and the Annual Reports of this writer and others, published by the Geological Survey of the United States in the *Mineral Resources*, form a repository of valuable information on precious stones in general. The articles in *The Mineral Industry* (founded by R. P. Rothwell) should also be consulted. See likewise O. C. Farrington, *Gems and Gem Minerals* (Chicago, 1903). For optical characters reference should be made to G. F. H. Smith, *The Herbert Smith Refractometer* (London, 1907); L. Claremont, *The Gem-Cutter's Craft* (London, 1906); W. Goodchild, *Precious Stones* (London, 1908). (F. W. R.)

2. GEMS IN ART

In art, the word *Gem* is the general term for precious stones when engraved with designs, whether adapted for sealing (*σφραγίς*, *sigillum*, *intaglio*), or mainly for artistic effect (*imagines ectypae*, *cameo*). They exist in a very large number of undoubtedly genuine old examples, extending from the mists of Babylonian antiquity to the decline of Roman civilization, and again starting with a new, but less original impulse on the revival of art. Apart from workmanship they possess the charms of colour deep, rich, and varied, of material unequalled for its endurance, and of scarcity, which in many instances has been enhanced by the remoteness of the lands whence they came or the fortuity of their occurrence. These qualities united within the small compass of a gem were precisely such as were required in a seal as a thing of constant use, so inalienable in its possession as to become naturally a personal ornament and an attractive medium of artistic skill, no less than the centre of traditions or of religious and legendary associations. As regards the nations of classical antiquity, all seals are classed as gems, though in many cases the material is not such as would strictly come under that heading, and precious stones in the modern sense are hardly known to occur. On the other hand it must not be supposed that gems engraved in intaglio were necessarily employed as seals. At all periods many intaglios are found which could not have been so employed without great difficulty. In Greece and Rome, within historic times, gems were worn engraved with designs to show that the bearer was an adherent of a particular worship, the follower of a certain philosopher, or the attached subject of an emperor. However, speaking generally, the intaglio engraving is a means to an end, namely, a seal-impression, while an engraving in relief is complete in itself.

Methods of Engraving (see also under **LAPIDARY**).—In gem-engraving the principal modern implement is a wheel or minute copper disk, driven in the manner of a lathe, and moistened with olive oil mixed with emery or diamond dust. There is no clear proof of the use among the ancients of a wheel mounted lathe-wise, but we have abundant indications of drilling with a revolving tool, which might be either a tubular drill making a ring-like depression, a pointed tool making a cup-like sinking, or a small wheel with a cutting edge, making a boat-shaped depression.

We have one sepulchral monument from Philadelphia showing the tool of an intaglio engraver (*δακτυλοκατοργήτης*; see *Athenische Mitteilungen des Arch. Inst.* xv. p. 333). Un-

fortunately the relief is incomplete, and the published illustration inadequate. It would seem, however, that a revolving tool was supported by a kind of mandrel, and actuated in primitive fashion by a bow. An alternative plan of working was to use a splinter of diamond set in a handle and applied like a graver. Both systems are clearly indicated by Pliny, who in one passage (*H.N.* xxxvii 60) states that diamond splinters are sought out by gem engravers and set in iron, and so easily hollow out stones of any degree of hardness; while elsewhere (*H.N.* xxxvii. 200) he speaks of the special efficacy of the *ferro terebrarum*, the vehement action of drills. A third method is also indicated by Pliny (*ibid*) when he speaks of the use of a blunted tool, which must have been moistened and supplied with emery of Naxos.

A four-sided pendant of the Hellenistic period published by Furtwangler (*Antike Gemmen, Gesch.* p. 40c) shows clearly the successive stages of the operation. On side *a* the subject is slightly sketched in with the diamond point. On side *b* the deepest parts of the figure have also been roughly scooped out with the wheel. On sides *c* and *d* the wheel work is fairly complete, but the finer internal work has not been begun.

After the design had been completed the stone must have received a final polish on its surface, to obliterate any erroneous strokes of the first sketch; but this process was not carried as far as in modern work. It is a popular error to suppose that a high degree of internal polish is a proof of antiquity. If the interior of the design has a high degree of polish it may be either ancient or modern, or it may be an ancient stone repolished in modern times. If it has a matt surface uniformly produced by intention, it is probably modern. If the design is slightly dimmed and worn or scratched the stone may be antique, but is not necessarily so, since modern engravers have observed this peculiarity, and have imitated it with a success which, were there no other grounds of suspicion, might escape detection.

History.—It has been a subject of controversy whether the first infancy of the art was passed in Egypt or in Babylonia, but it seems highly probable that it was developed in Babylonia, whence at any rate the oldest examples of engraved gems at present known are obtained. It does not necessarily follow, however, that Egypt was therefore a pupil. It may well be that the art was developed independently in the two countries, although certain points of possible contact in respect of the forms employed will be described below in the section dealing with primitive Egypt.

Babylonia.—At a very remote period the cylindrical form of stone was introduced and became the approved shape, while the technical skill of the artist was still slight, and the traces of the tools employed (drill and pencil point) were still unconcealed.

The cylinder was suspended by a string and used as a seal. Impressions of cylinders are frequent on contract tablets. If one of the parties cannot use a seal he makes a nail-mark in lieu thereof, as is recorded in the document.

But from a time that was still comparatively early the engravers could work with considerable skill in the hard stone. In particular a cylinder may be quoted in the de Clercq Collection bearing the name of Sargon I. of Agade, who is placed about 3500 B.C. The cylinder is engraved with the king's name and titles and two symmetrically disposed renderings of Izdubar, with a vase of flowing water giving drink to a bull. The whole is treated in a conventionalized style that indicates long traditions. An important early cylinder in the British Museum is inscribed with the name of a viceroy of Ur-Gur, king of Ur (about 2500 B.C.). The engraving shows Ur-Gur being led into the presence of Sin, the moon-god.

The cylinder seal was adopted by the Assyrians, and so was carried on continuously till the time of the Persian conquest of Babylon (538 B.C.). Meanwhile, as an alternative form the conoidal seal, rounded at the top and having a flat base for the intaglio, came into use beside the cylinder.

In style the Assyrians carried on the Babylonian tradition, but with no freedom of design. Subjects and treatment became rigidly conventional.

After the Persian conquest the victors adopted the cylinder

form of the conquered, and continued to use it. A Persian cylinder seal of Darius (probably about 500 B.C.) in the British Museum shows the king in his chariot, transfixing a lion with his arrows, in a palm wood. Above is the winged emblem of the Persian deity Ahuramazda. The inscription gives the name and titles of Darius in the Persian, Scythic and Babylonian languages. The style is accurate and minute. The idea of the lion hunt is borrowed from the Assyrian monuments, but the engraver has been careful to make the necessary changes of costume and treatment. The cylinder was, as might be anticipated, imitated to a certain extent by peoples of the Eastern world in touch with Babylonia. It occurs in Armenia, Media and Elam. It has been found in Crete (*British School Annual*, viii. p. 77) and is frequent in the early Cypriote deposits. In some instances it has been found unfinished and therefore must be supposed to be of local manufacture. Sometimes a direct imitation of cuneiform characters occurs on the Cypriote cylinders. The same form was also employed by the Phoenicians (about the 8th century-7th century B.C.). By the Greeks and Etruscans it was used, but only rarely, and by way of exception.

Egypt.—We must go back to the remotest periods for the origin of intaglio engraving in Egypt. Recent discoveries of tombs of the earliest dynasties at Abydos and Nagada have thrown much light on the early stages of Egyptian art, and have revealed the remarkable fact that in Egypt (as in Babylonia) the cylinder was the earliest form used for the purpose of a seal. The cylinders that have been found are comparatively few in number; but a large number of jar-stoppings of clay are preserved on which cylinder designs have been rolled off while the clay was still soft. Such early incised cylinders as are extant are made either of hard wood or (as in an instance in the British Museum) of stone. The identity of form has been thought to indicate a connexion with Babylonia, but none can be traced in the designs of the respective cylinders.

The Egyptians of the earliest dynasties had an admirable command of hard stones, as shown by their beads and stone vases, but with the exception of the cylinders quoted they are not known to have applied their skill to the production of intaglios. At this early period the scarab (or beetle) was still unknown as a gem-form. It was only about the time of the 4th dynasty that the scarab (*g.v.*) was first introduced, and gradually took the place of the cylinder as the prevailing shape.

The *Scarabaeus sacer* (Egyptian, *Kheperer*), rolling its eggs in a ball of mud, became the accepted emblem of the sun-god, and so the form had an amuletic value. Scarabs of obsidian and crystal date back to the 4th dynasty. Others, coarse and unscrubbed, belong to the beginning of the first Theban empire. After the 18th dynasty they are counted by thousands. While the beetle form was naturalistically treated, the flat surface underneath was well adapted to receive a hieroglyphic sign. The scarabs, however, are by no means the only product of the art. We have also figures of all kinds in the round and in intaglio—statuettes, figures of animals and of deities, and sacred emblems such as the ankh (or *crux ansata*) and the eye. Among interesting variations from the scarab form is the oblong intaglio of green jasper in the Louvre (*Gazette arch.*, 1878, p. 41) with a design on both sides. It represents on the obverse Tethmosis (Thothmes) II. (1800 B.C.) slaying a lion, and identified by his cartouche. On the reverse we have the same king drawing his bow against his enemies from a war chariot. The scarabs of Egypt though uninteresting in themselves, considered as examples of engraving, have this accidental importance in the history of art, that they furnished the Phoenicians with a model which they were able to improve as regards the intaglio by a more free spirit of design, gathered partly from Egypt and partly from Assyria. The scarab thus improved exercised a lasting influence on the later history, since, as will be seen below, it was adopted and modified both by Greeks and Etruscans.

Engraved Gems in the Bible.—While the Phoenicians have left actual specimens to show with what skill they could adopt the systems of gem-engraving prevailing at their time in Egypt and Assyria, the Israelites, on the other hand, have left records to

prove, if not their skill, at least the estimation in which they held engraved gems. "The sin of Judah is written with a pen of iron and with the point of a diamond" (Jerem. xvii. 1). To pledge his word Judah gave Tamar his signet, with its cord for suspension, and staff (Gen. xxxviii. 18); whence if this passage be compared with the frequent use of "seal" in a metaphorical sense in the Bible, and with the usage of the Babylonians of carrying a seal with an emblem engraved on it recorded by Herodotus, it may be concluded that among the Israelites also every man of mark at least wore a signet. Their acquaintance with the use of seals in Egypt and Assyria is seen in the statement that Pharaoh gave Joseph his signet ring as a badge of investiture (Gen. xli. 42), and that the stone which closed the den of lions was sealed by Darius with his own signet and with the signet of his lords (Daniel vi. 17). Then as to the stones which were most prized, Ezekiel (xxviii. 13), speaking of the prince of Tyre, mentions "the sardius, the topaz and the diamond, the beryl, the onyx, and the jasper, the sapphire, the emerald and the carbuncle," stones which again occur in that most memorable of records, the description of the breastplate of the high priest

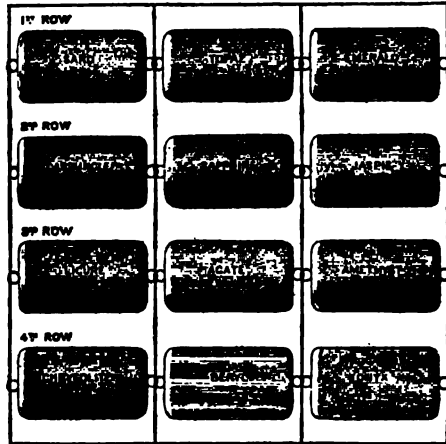

FIG. 1.—Jewish High Priest's Breastplate.

(Exodus xxviii. 16-21, and xxxix. 8-14). Twelve stones grouped in four rows, each with three specimens, may be arranged on a square, so as to have the rows placed either vertically or horizontally. If they are to cover the whole square, then, unless the gold mounts supplied the necessary compensation, they must be cut in an oblong form, and if the names engraved on them are to run lengthwise, as is the manner of Assyrian cylinders, then the stones, to be legible, must be grouped in four horizontal rows of three each. There is in fact no reason to suppose that the gems of the breastplate were in any other form than that of cylinders such as abounded to the knowledge of the Israelites, with this possibility, however, that they may have been cut lengthways into half-cylinders like a fragmentary one of sard in the British Museum, which has been mounted in bronze, and, as a remarkable exception, has been set with three small precious stones now missing. It could not have been a seal, because of this setting, and because the inscription is not reversed. The names of the twelve tribes, not their standards, as has been thought, may have been engraved in this fashion, just as on the two onyx stones in the preceding verses (Exodus xxviii. 9-11), where there can be no question but that actual names were incised. On these two stones the order of the names was according to primogeniture and this, it is likely, would apply to the breastplate also. The accompanying diagram will show how the stones, supposing them to have been cylinders or half-cylinders, may have been arranged consistently with the

descriptions of the Septuagint. In the arrangement of Josephus (iii. 7. 5) the jasper is made to change places with the sapphire, the amethyst with the agate, and the onyx with the beryl, while our version differs partly in the order and partly in the names of the stones; but probably in all these accounts the names had in some cases other meanings than those which they now carry. It must be remembered that we have two series of equivalents, namely, the Hebrew compared with the Septuagint, and the Greek words of the Septuagint compared with the modern names, which in many cases, though derived from the Greek, have changed their applications. From the fact that to each tribe was assigned a stone of different colour, it may be taken that in each case the colour was one which belonged prescriptively to the tribe and was symbolic, as in Assyria, where the seven planets appropriated each a special colour [see Brandis in *Hermes*, 1867, p. 259 seq., and de Saulcy, *Revue archéologique*, 1869, ii. p. 91; and compare Revelation xxi. 12, 13, where the twelve gates, which have the names of the twelve tribes written upon them, are grouped in four threes, and 19, 20, where the twelve precious stones of the walls are given]. The precious stones which occur among the cylinders of the British Museum are sard, emerald, lapis lazuli (sapphire of the ancients), agate, onyx, jasper and rock crystal.

Gem-Engraving in Greek Lands.—We must now turn to the history of gem-engraving in Greek lands. The excavations in Crete in the first years of the 20th century revealed a previously unknown culture, which lasted on the lowest computation for more than two thousand years, and was only interrupted by the national upheavals which preceded the opening of Greek history proper. (See CRETE; *Archæology*; and *ÆGÆAN CIVILIZATION*.) Throughout the whole period the products of the gem-engraver occupy an important place among the surviving remains. It must suffice, however, in this place to indicate the chief groups of stones.

The earliest engraved stones of Minoan Crete are three-sided prism seals, made of a soft steatite, native in S.E. Crete (*Journ. of Hellenic Studies*, xvii. p. 328). These are incised with pictorial signs evidently belonging to a rudimentary hieroglyphic system, and are dated before 3000 B.C. At a period placed by A. J. Evans between 2800 and 2200 the method was fully systematized and employed on the signets, as well as on tablets and other materials. This development of the hieroglyphic system was accompanied by an increasing power of working in hard material, and cornelian and chalcedony superseded soft steatite (*Journ. of Hell. Studies*, xvii. p. 334).

Towards 2000 B.C. a highly developed linear form began to supersede the pictorial signs. It is abundant on the tablets, but the gems thus inscribed are comparatively rare. The linear form in turn died out some six hundred years later.

The signs of the pictorial script incised on the gems are representations of objects, expressed with precision, but giving little scope for the higher side of the gem-engraver's art. Simultaneously, however, with the use of the script, a high degree of skill was acquired by the engravers in rendering animal and human forms. Scenes occur of ritual observance, hunting, animal life, and strange compounded forms of demons. The excavations did not yield a large number of original gems of this class, but a great number of clay sealings from such signets were discovered. That they were synchronous with the use of the forms of script described above is proved by the fact that in the palace at Cnossus deposits were found, both in the linear and the hieroglyphic script, sealed with these signets, the seal impressions being again endorsed in the script (*Brit. School Annual*, xi. pp. 56, 62). For a remarkable group of sealings found at Zakro see *Journ. of Hell. Studies*, xxii. pl. 6-10. The finest naturalistic engravings are placed towards the close of the "Mid-Minoan" and beginning of the "Late-Minoan" periods (about 2200-1800 B.C.). During the progress of the "Late-Minoan" period the subjects tended to assume a more formal and heraldic character. The forms of stones in favour were the disk convex on each side (lenticular or lentoid stones), and during the "Mid-Minoan" period, elaborate signets in the form of modern fob-seals. Apart from the use of intaglios for sealing,

the excavations have shown that the Cretan lapidaries were largely employed in the working of gems for purposes of decoration. Fragments of lapis lazuli and crystal for inlaying (the crystals having coloured designs on their lower surfaces) were found in the throne room at Cnossus; the royal gaming-board, also from the palace at Cnossus, had inlaid crystal disks and plaques. The workshop of a lapidary, with unfinished works in marble, steatite, jasper and beryl, was also found within the precincts of the palace (*Brit. School Annual*, vii. pp. 20, 77). Examples were also found of work in relief, substantially anticipating the art of cameo-cutting.

The area over which the Cretan influence extended was wide. Its manifestations in Greek lands proper, first revealed by Schliemann's excavation of the royal tombs of Mycenæ, ran parallel with and outlasted the later periods of the Cretan culture to which it stood in close relation (see *ÆGÆAN CIVILIZATION*). Its gems and intaglio works in gold are known to us from the finds at Mycenæ, and at analogous sites, such as Menidi, Vaphio and Ialysus. They have much in common with the finer class of Cretan stones already described. The engraved gems fall principally into two groups in respect of form, namely, the lenticular (or lentoid) Mus.



FIG. 2.—Lenticular Rock-Crystal from Ialysus. (Brit. Mus.)

namely, the lenticular (or lentoid) Mus. stones already mentioned, and (more rarely) glandular stones, so called from their resemblance to a *glans* or sling bolt. A Cretan fresco shows a figure wearing an agate lenticular stone suspended from the left wrist. The finer specimens of the Aegean gems are engraved with the wheel and the point in hard stones, such as chalcedony, amethyst, sard, rock-crystal and haematite. A lapidary's workshop similar to that at Cnossus has been found at Mycenæ, with a store of unused gems, and an unfinished lenticular stone (*Ephemeris Archæologiké*, 1897, p. 121). The characteristic of the Aegean engraver is the free expression of living forms. His subjects are figures of animals, men and demons in combat, and heraldic compositions recalling the Gate of Lions at Mycenæ. It was almost inevitable that the scarab should be found in the Cretan and Aegean deposits, but in such cases we have the Egyptian scarab directly imported, and not, as at a later period, non-Egyptian adaptations of the form. The cylinder also (except in Cyprus, the borderland between east and west) only occurs as an importation, and not as a currently manufactured shape.



FIG. 3.—Lenticular Sard from Ialysus. (Brit. Mus.)

The "Island Gems."—The Aegean culture was swept away probably by that dimly seen upheaval which separated Mycenæan from historical Greece, and which is commonly known as the Dorian invasion. One of the few facts which indicate a certain continuity of tradition in later Greece is this, that we again find the same characteristic forms, the glandular and lenticular stones, in the cemeteries, of Melos and elsewhere. It is only recently that archaeologists have learnt to distinguish between the later lenticular and glandular stones "of the Greek Islands," as they are commonly called, and those of the Aegean age. Engravings of the later class are worked in soft materials only, such as steatite. They have not the power of expressing action peculiar to the Aegean artist. In general, the continuity of tradition between the gems of the Mycenæan and the historical periods is in respect of shape rather than of art. The subjects are for the most part decorative forms (the Gryphon, the winged Sphinx, the winged horse, &c.) in course of development into characters of Greek myth.

The Phœnicians and the Greeks.—About the end of the 8th and beginning of the 7th century B.C. the Phœnicians began to exercise a powerful influence as intermediaries between Egypt and Assyria and the Mediterranean. Porcelain and other

imitations of Egyptian ornaments, and especially of Egyptian scarabs, are found in great numbers on such sites as Amathus in Cyprus, Camirus in Rhodes, in Etruria, and at Tharros in Sardinia. The Egyptian hieroglyphics are imitated with mistakes, the figures introduced are stiff and formal, the animals as a rule heraldic. The scarab form, which in Egypt had its sacred significance, was now become nothing more than a convenient shape for an object of jewelry or for the reverse side of a stone. It was adopted from the Phoenicians both by Greeks and Etruscans. By the Greeks, with whom we are at present concerned, its use was occasional, and about 500 B.C. it was superseded by the scarabaeoid. Under this name two forms, somewhat similar but independent in origin, are usually grouped without sufficient discrimination. The scarabaeoid proper is a simplification of the scarab, effected by the omission of all details of the beetle. But many of the stones known as scarabaeoids, with a flat and oval base and a convex back, are in respect of their form probably of North Syrian origin (so Furtwängler). The earliest examples of archaic Greek gem-engraving (other than the later "Island gems" already described) are works of Ionian art. They show a desire, only limited by imperfect power of expression, to represent the human figure, though the particular theme may be a god or other mythical personages. By the beginning of the 5th century the engravers had reached the



FIG. 4.—Victory. Early Greek Scarab. (Brit. Mus.)



FIG. 5.—Citharist. Early Greek Scarabaeoid. (Brit. Mus.)



FIG. 6.—Head of Eos. (Brit. Mus.)

point of full development, and the scarabaeoids of the time embody its results. As an example of fine scarabaeoids the Woodhouse intaglio of a seated citharist (fig. 5; *Cat. of Gems in Brit. Mus.* No. 555) may be quoted as perhaps the very finest example of Greek gem-engraving that has come down to us. It would stand early in the 5th century B.C., a date which would also suit the head of Eos from Ithome in Messenia (fig. 6). The number, however, of fine scarabaeoids known to us has been considerably increased in recent years. They are marked by a broad and simple treatment, which attains a large effect without excessive minuteness or laboured detail. In these respects the style has something in common with the reliefs of the 5th century.

Literary History.—The literary references to the early gem-engravers are no longer of the same importance as before in view of the fuller knowledge we possess as to the quality of early gem-engraving, but it is necessary that they should be taken into account.

The records of gem-engravers in Greece begin in the island of Samos, where Mnesarchus, the father of the philosopher Pythagoras, earned by his art more of praise than of wealth. "Not to carry the image of a god on your seal," was a saying of Pythagoras; and, whatever his reason for it may have been, it is interesting to observe him founding a maxim on his father's profession of gem-engraving (Diogenes Laërt. viii. 1, 17). From Samos also came Theodoros, who made for Polycrates the seal of emerald (Herodotus iii. 41), which, according to the curious story, was cast in vain into the deep sea on purpose to be lost. That the design on it was a lyre, as is stated in one authority, is unlikely, at least if we accept Benndorf's ingenious interpretation of Pliny (*Nat. Hist.* xxiv. 83). He has suggested that the portrait statue of Theodoros made by himself was in all probability a figure holding in one hand a graving tool, and in the other, not, as previously supposed, a quadriga so diminutive that a fly could cover it with its wings, but a scarab with the engraving

of a quadriga on its face (*Zeitschrift für die österreich. Gymnasien*, 1873, pp. 401-411), whence it is not unreasonable to conclude that this scarab in fact represented the famous seal of Polycrates. Shortly after 600 B.C. there was a law of Solon's forbidding engravers to retain impressions of the seals they made, and this date would fall in roundly with that of Theodoros and Mnesarchus, as if there had in fact been at that time a special activity and unusual skill. That the use of seals had been general long before, in Crete and Mycenaean times, we have seen above, and it is singular to find, as Pliny points out (xxxiii. 4), no direct mention of seals in Homer, not even in the passage (*Iliad*, vi. 168) where Bellerophon himself carries the tablets on which were written the orders against his life. From the time of Theodoros to that of Pyrgoteles in the 4th century B.C. is a long blank as to names, but not altogether as to gems, the production of which may be judged to have been carried on assiduously from the constant necessity of seals for every variety of purpose. The references to them in Aristophanes, for example, and the lists of them in the ancient inventories of treasures in the Parthenon and the Asclepion at Athens confirm this frequent usage during the period in question. The mention of a public seal for authenticating state documents also becomes frequent in the inscriptions. In the reign of Alexander the Great we meet the name of Pyrgoteles, of whom Pliny records that he was no doubt the most famous engraver of his time, and that Alexander decreed that Pyrgoteles alone should engrave his portrait. Nothing else is known of Pyrgoteles. A portrait of Alexander in the British Museum (No. 2307), purporting to be signed by him, is palpably modern.

From literary sources we also learn the names of the engravers Apollonides, Chronius and Dioscorides, but the date of the last-mentioned only is certain. He is said to have made an excellent portrait of Augustus, which was used as a seal by that emperor in the latter part of his reign and also by his successors. Inscriptions on extant gems make it probable that Dioscorides was a native of Aegeae in Cilicia, and that three sons, Hyllos, Herophilus and Eutyche, followed their father's occupation. We have also a few scattered notices of amateurs and collectors of gems, but it will be seen that for the whole period of classical antiquity the literary notices give little aid, and we must return to the gems.

Early Inscribed Gems.—Various early gems are inscribed with proper names, which may be supposed to indicate either the artist or the owner of the gem. In some cases there is no ambiguity, e.g. on a scarab is inscribed, "I am the seal of Thersia. Do not open me"; and a scarabaeoid (fig. 7) is inscribed, "Syries made me." But when we have the name alone, the general principle on which we must distinguish between owner and artist is that the name of the owner is naturally meant to be conspicuous (as in a gem in the British Museum inscribed in large letters with the name of Issag[as]), while the name of an artist is naturally inconspicuous and subordinate to the design.

The early engravers known to us by their signatures are: Syries, who was author of the modified scarab in the British Museum, mentioned above, with a satyr's head in place of the beetle, and a citharist on the base—a work of the middle of the 6th century; Semon, who engraved a black Jasper scarab now at Berlin, with a nude woman kneeling at a fountain filling her pitcher, of the close of the 6th century; Epimenes, who was the author of an admirable chalcidony scarabaeoid of a nude youth restraining a spirited horse—formerly in the Tyszkiewicz Collection, and of about the beginning of the 5th century. But better known to us than any of these artists is the 5th-century engraver, Dexamenus of Chios, of whose work four examples¹ survive, viz.:—



FIG. 7.—Scarabaeoid by Syries. (Brit. Mus.)

¹ For Nos. 1-4 see Furtwängler, pl. 14; for Nos. 2-4 see Evans, *Rev. archéologique*, xxxii. (1898) pl. 8.

1. A chalcedony scarabaeoid from Greece, in the Fitzwilliam Museum at Cambridge, with a lady at her toilet, attended by her maid. Inscribed ΔΕΞΑΜΕΝΟΣ, and with the name of the lady, ΜΙΚΗΞ.

2. An agate with a stork standing on one leg, inscribed ΔΕΞΑΜΕΝΟΣ simply.

3. A chalcedony with the figure of a stork flying, and inscribed in two lines, the letters carefully disposed above each other, ΔΕΞΑΜΕΝΟΣ ΕΠΟΙΕ ΧΙΟΣ.

4. A gem, apparently by the same Dexamenus, is a cornelian formerly belonging to Admiral Soteriades in Athens, and subsequently in the collection of Dr Arthur Evans.



FIG. 8.—Greek Sard. 5th Cent. B.C. (Brit. Mus.)

It has a portrait head, bearded and inscribed ΔΕΞΑΜΕΝΟΣ ΕΠΟΙΕ.

The design of a stork flying occurs on an agate scarab in the British Museum, from the old Cracherode Collection, and therefore beyond all suspicion of having been copied from the more recently discovered Kertch gem.

For the period immediately following that early prime to which the gems above described belong, our materials are less copious. Some of the finest examples are derived from the Greek tombs in the Crimea and South Russia. Reckoned among the best of the Crimean gems, and that is equivalent to saying among the best of all gems, are the following:

(1) a burnt scarabaeoid with an eagle carrying off a hare; (2) a gem with scarab border and the figure of a youth seated playing on the trigonon, very much resembling the Woodhouse intaglio (both engraved, *Compte rendu*, 1871, pl. vi. figs. 16, 17). In these, and in almost all Greek gems belonging to this period of excellence, the material is of indifferent quality, consisting of agate, chalcedony or cornelian, just as in the older specimens. Brilliant colour and translucency are as yet not a necessary element, and accordingly the design is worked out solely with a view to its own artistic merit. The scarab tends to die out. The scarabaeoid in its turn is abandoned for the simple ring stone. The subjects chosen take by degrees a different character. Aphrodite (nude),



FIG. 9.—Amethyst Pendant. (Brit. Mus.)

Eros, children and women tend to replace the older and severer themes. The motives of 4th-century sculpture appear by degrees on the gems.

Etruscan Gems.—At this point it is convenient to discuss the gem-engraving of the Etruscans, which came into being towards the close of the archaic period of Greek art. In the early Etruscan deposits, such as that of the Polledrara tomb in the British Museum (towards 600 B.C.), we find nothing except Phoenician imports of porcelain or stone scarabs, both strongly Egyptian in character. During the 6th century a few of the semi-Egyptian stones of Sardinia make their appearance. But in the latter part of the century these oriental products tend to die out, and we have in their place the native works of Etruscan artists. These engravings stand in the closest relation to Greek works of the close of the 6th century and many imported Greek scarabs also occur.

The Etruscan scarab has its beetle form more minutely engraved than that of the Greeks. It is further distinguished in the better examples, alike from the Greek and the Egyptian form, by a small border of a sort of petal ornament round the lower edge of the beetle. Like the earlier Greek scarabs it has

the cable border round the design, but the border continued in use in Etruria when it had been abandoned in Greece. The scarabaeoid form does not occur in Etruscan deposits. Etruscan engraving begins when Greek art was approaching maturity, with studies, sometimes stiff and cramped, of the heroic nude form. Some of the Greek deities such as Athena and Hermes occur, together with the winged personages of Greek mythology. To the heroic types the names of Greek legend are attached, with modifications of form, such as ΤΥΤΕ for Tydeus, and ΚΑΙΝΕ for Capaneus. Sometimes the names are appropriate and sometimes they are assigned at random. The subjects include certain favourite incidents in the Trojan and Theban cycles (e.g. the death of Capaneus); myths of Heracles; athletes; horsemen, a few scenes of daily life. Certain schemes of composition are frequent. In particular, a figure too large for the field, standing and bending over, is made to serve for many types. The engraving of the finer Etruscan gems is minute and precise, marked with elegance and command of the material. Its fault is its want of original inspiration. Special mention must be made of a very numerous group of cornelian scarabs, roughly engraved for the most part with cup-shaped sinkings (whence they are known as gems *a globolo tondo*) roughly joined together by furrows. Notwithstanding their apparent rudeness, these gems are shown, by the conditions in which they are found, to be comparatively late works of the 4th century. Furtwängler ingeniously suggests that the rough execution was intended to emphasize the shining surfaces of the cup-sinkings, rather than to produce any particular intaglio subject. (For an elaborate classification of the Etruscan scarabs see Furtwängler, *Geschichte*, p. 170.)

The Cameos.—After the beginning of the regal period, in the 4th century B.C., the introduction of more splendid materials from the East was turned to good account by the development of the cameo, i.e. of gem-carving in relief (for the origin of the word see *CAMEO*). But in its simpler forms the principle of the cameo necessarily dates from the beginning of the art. Thus a lion in rock-crystal was found in the very early royal tomb of Nagada (de Morgan, *Recherches, Tombeau de Nagada*, p. 193). The Egyptian scarab, on its rounded side, had been naturalistically carved in relief in beetle form. Steatite engravings in relief (notably the harvest festival vase from Hagia Triada) were found in the Cretan deposits. Subjects are found carved in the round in hard stone in Mycenaean graves. When we come to historical Greece and to Etruria the cameo of later times is anticipated by various attempts to modify the traditional form of the scarab. An example in cornelian was found at Orvieto in 1874 in a tomb along with vases dating from the beginning of the 5th century B.C., and it will be seen from the engraving of this gem (*Arch. Zeit.*, 1877, pl. xi. fig. 3) that, while the design on the face is in intaglio, the half-length figure of a Gorgon on the back is engraved in relief. Compare a cornelian fragment, apparently cut from the back of a scarabaeoid, now in the British Museum. As further examples of the same rare form of cameo, the following gems in the British Museum may be mentioned:—(1) a cornelian cut from back of a scarabaeoid, with head of Gorgon surrounded by wings; (2) cornelian scarabaeoid: Gorgon running to left; on face of the gem an intaglio of Thetis giving armour to Achilles; (3) steatite scarabaeoid, already mentioned, signed by Syries, head of a satyr, full face, with intaglio of citharist. There is, however, no evidence at present available to show that the cameo proper had been introduced in Greece before the time of Alexander. The earliest examples found in known conditions are derived from Crimean tombs of the middle of the 3rd century B.C.

Among the most splendid of ancient cameos are those at St Petersburg and Vienna, each representing a monarch of the Diadochi and his consort (Furtwängler, pl. 53). There is much controversy as to the persons represented, but the cameos are probably works of the 3rd century.

The materials which ancient artists used for cutting into cameos were chiefly those siliceous minerals which, under a variety of names, present various strata or bands of two or more distinct colours. The minerals, under different names, are

essentially the chalcedonic variety of quartz, and the differences of colour they present are due to the presence of variable proportions of iron and other foreign ingredients. These banded stones, when cut parallel to the layers of different colours, and when only two coloured bands—white and black, or sometimes white and black and brown—are present, are known as onyxes; but when they have with the onyx bands layers of cornelian or sard, they are termed sardonyxes. The sardonyx, which was the favourite stone of ancient cameo-engravers, and the material in which their masterpieces were cut, was procured from India, and the increased intercourse with the East after the death of Alexander the Great had a marked influence on the development of the art.

Akin in their nature to the great regal cameos, which from the nature of the case are cut on a nearly plane surface, are the cups and vases cut out of a homogeneous stone and therefore capable of being worked in the round. A few examples of such works survive. The most famous are the Farnese Tazza and the cup of the Ptolemies. The Tazza, which is now in the National Museum at Naples, was bought by Lorenzo de' Medici from Pope Paul II. in 1471. It is a large shallow bowl of sardonyx, 8 in. in diameter. On its exterior surface is a Gorgoneion upon an aegis; in the interior is an allegorical design, relating to the Nile flood. The cup of the Ptolemies, formerly known as the cup of St Denis, is preserved in the Cabinet des Médailles of the French Bibliothèque Nationale. It is a cup $4\frac{1}{2}$ in. high and $5\frac{1}{2}$ in. in diameter, carved out of oriental sardonyx, and richly decorated with Dionysiac emblems and attributes in relief.

The Cameo in the Roman Empire.—During the 1st century of the empire the engraver's art alike in cameo and in intaglio was at a high degree of excellence. The artist in cameo took full advantage of his rich opportunities in the way of sumptuous materials, and of the requirements of an imperial court. The two most famous examples of this art which have come down to the present day are the Great Agate of the Sainte Chapelle in the Bibliothèque Nationale, Paris, and the Augustus Cameo in the Vienna Collection. The former was pledged among other valuables in 1244 by Baldwin II. of Constantinople to Saint Louis. It is



FIG. 10.—Actaeon. Fragment of Sardonyx Cameo. (Brit. Mus.)

mentioned in 1344 as "Le Camahieu," having been sent in that year to Rome for the inspection of Pope Clement VI. It is a sardonyx of five layers of irregular shape, like all classical gems, measuring 12 in. by 10 $\frac{1}{2}$ in. It represents on its upper part the deified members of the Julian house. The centre is occupied with the reception of Germanicus on his return from his great German campaign by the emperor Tiberius and his mother Livia. The lower division is filled with a

group of captives in attitudes expressive of woe and deep dejection. The Vienna gem (*Gemma augustea*), an onyx of two layers measuring $8\frac{1}{2}$ in. by 7 $\frac{1}{2}$ in. is a work of still greater artistic interest. The upper portion is occupied with an allegorical representation of the coronation of Augustus, the emperor being represented as Jupiter with Livia as the goddess Roma at his side. In the composition deities of Earth and Sea, and several members of the family of Augustus, are introduced; on the exergue or lower portion are Roman soldiers preparing a trophy, barbarian captives and female figures. This gem was in the 15th century at the abbey of St Serinin at Toulouse. According to tradition it had been placed there by Charlemagne. It came into the possession of the emperor Rudolph II. in the 16th century for the enormous sum of 12,000 gold ducats. The principal cameo in the collection of the British Museum was acquired at the final dispersion of the Marlborough Collection in 1899. It is a sardonyx measuring $8\frac{1}{2}$ in. by 6 in., and appears to represent a Roman emperor and empress in the forms of Serapis and Isis. Here also, in imperial times as in the Hellenistic period, side by side with the great cameos, we meet with works carved out in the round. Noted examples of such

work are the Brunswick vase (at Brunswick), with the subject of Triptolemus; the Berlin vase with the lustration of a new-born imperial prince; and the Waddesdon vase in the British Museum, with a vine in relief set in a rich enamelled Renaissance mount. Hardly less precious than the cameos in sardonyx were the imitations carved out of coloured glass. The material was not costly, but its extreme fragility made the work of extreme difficulty. Examples of such work are the Barberini or Portland vase, deposited in the British Museum, with scenes supposed to be connected with the story of Peleus and Thetis; and the "vase of blue glass" from Pompeii, in the museum at Naples (see Mau and Kelsey, p. 408). The world's great cameos, which are hardly more than a dozen in number, have not been found by excavation. They remained as precious objects in imperial and ecclesiastical treasuries and passed thence to the royal and national collections of modern Europe.

The Intaglio in the Roman Empire.—The art of engraving in intaglio was also at a high level of excellence in the beginning of the Roman empire. This is to be inferred alike from the admirable portraits of the 1st century A.D., and from the number of signed gems bearing Roman artists' names, such as Aulus, Gnaius and the like, which could hardly belong to any other period. It is impossible, however, to found any argument upon the artists' signatures without taking into account the intricate questions of authenticity which are discussed in the following section.

Signed Gems.—The number of gems which have, or purport to have, the name of the artist inscribed upon them is very large. A great many of the supposed signatures are modern forgeries, dating from the period between 1724 (when the book of Stosch, *Gemmae antiquae coelatae, sculptorum nominibus insignitae*, first drew general attention to the subject) and 1833, when the multitude of forged signatures (about 1800 in number) in the collection of Prince Poniatowski made the whole pursuit ridiculous. It is known, however, that forged signatures were current before 1724 (see Stosch, p. xxi.), and in the period immediately following they were very numerous. Thus Laurence Natter (*Méthode de graver en pierres fines* (1754), p. xxx.) confesses that, whenever desired, he made copies. For example, he copied a Venus (Brit. Mus. No. 2206), converting the figure into a Danaë and affixing the name of Aulos which he found on the Venus. Cf. Mariette, *Traité* (1750), i. p. 101.

The question which of the multitude of supposed signatures can be accepted as genuine has been a subject of prolonged and intricate controversy. In the period immediately following the Poniatowski forgeries the extreme height of scepticism is represented by Kochler, who only acknowledged five gems (Kochler, iii. p. 206) as having genuine signatures. In recent years the subject has been principally dealt with by Furtwängler, whose conclusion is to admit a considerable number of gems rejected by his predecessors.

It must suffice here to point out a few general principles. In the first place a certain number of gems recently discovered have inscriptions which are undoubtedly genuine and which record the names of the engravers. The form of the signature may be a nominative with a verb, a nominative without a verb or a genitive. The artists in this class are Syries, Dexamenus, Epimenes and Semon, mentioned above, and a few others. Another group of gems which must be accepted consists of stones whose known history goes back to a period at which a forged inscription was impossible. Thus a bust of Athena in the Berlin Collection, signed by Eutyches, was seen by Cyriac of Ancona in 1445. A glass cameo signed by Herophilus, son of Dioscorides, now at Vienna, was, in the 17th century, in the monastery of Echternach, where it had probably been from old times. The portrait of Julia, daughter of Titus, by Euodos (now in the Bibliothèque Nationale) was formerly a part of a reliquary presented to the abbey of St Denis by Charles the Bold. Another group of undoubtedly genuine signatures occurs on cameos (in stone and paste) which have the inscriptions in relief, and therefore as part of the original design. Such are the works of Athenion, and of Quintus, son of Alexas.

For the great majority of signed gems which do not fall into these categories the reader must refer to the discussions of Furtwängler and others (see *Bibliography* below). It must suffice to say that Furtwängler arrives at the result that we have in all genuine signatures of at least fifty ancient gem-engravers.

Gem-Engraving in the Later Empire.—In the following centuries the art of intaglio engraving, which was still at a high degree of perfection in the first century of the Roman empire, became more mechanical. The designs have a very characteristic appearance, due to the method of production with rough and hasty strokes of the wheel only. A collection of gems found in England, such as that in the possession of the corporation of Bath, shows the feeble character in particular of the gems current in the provinces. Except in portraiture, and in grylli or conceits, in which various things are combined into one, often with much skill, the subjects were as a rule only variations or adaptations of old types handed down from the Greeks. When new and distinctly Roman subjects occur, such as the finding of the head on the Capitol, or Faustulus, or the she-wolf with the twins, both the stones and the workmanship are poor. In such cases, where the design stirs a genuine national interest, it may happen that very little of artistic rendering will be acceptable rather than otherwise, and much more is this true when the design is a symbol of some article of faith, as in the early Christian gems. There both the art and the material are at what may be called the lowest level. The usual subjects on the early Christian gems are the fish, anchor, ship, dove, the good shepherd, and, according to

Byzantine empire down to nearly the epoch of the Renaissance. From the Byzantine period downward one peculiarity of gem-engraving becomes noticeable. Cameo-work as compared with intaglios in classical times was rare and infrequent, but now and onwards the opposite is the case, intaglio-sinking having almost died out, and cameos being chiefly produced. Commercial intercourse with the East still secured for the engravers a supply of magnificent sardonyses, although blood-stone and other non-banded stones were very commonly used for works in relief. Cameos during the long dark ages were used chiefly for the decoration of reliquaries and other altar furniture, and as such their designs were purely ecclesiastical or scriptural. To this period also belongs the class of complimentary or motto cameos, which, containing only inscriptions and an ornamental border, executed in nicolo stones, were used as personal gifts and adornments.

In medieval times antique cameos were held in peculiar veneration on account of the belief, then universal, in their potency as medicinal charms. This power was supposed to be derived from their origin, of which two theories, equally satisfactory, were current. By the one they were held to be the work of the children of Israel during their sojourn in the wilderness (hence the name *Pietres d'Israël*), while the other theory held them to be direct products of nature, the engraved figures pointing to the peculiar virtue lodged in them. Interpreters less mystically inclined found Biblical interpretations for the subjects. Thus the cameo of the Sainte Chapelle was supposed to represent the triumph of Joseph in Egypt. A cameo with Poseidon, Athena and her serpent was Adam and Eve.

The revival of the glyptic arts in western Europe dates from the pontificate of the Venetian Paul II. (1464-1471), himself an ardent lover and collector of gems, to which passion, indeed, it is gravely affirmed he was a martyr, having died of a cold caught by the multiplicity of gems exposed on his fingers. The cameos of the early part of the 16th century rival in beauty of execution the finest classical works, and, indeed, many of them pass in the cabinets of collectors for genuine antiques, which they closely imitated. The Oriental sardonyx was not available for the purposes of the Renaissance artists, who were consequently obliged to content themselves with the colder German agate onyx. The scarcity of worthy materials led them to use the backs of ancient cameos, or to improve on classical works of inferior value executed on good material, and probably to this cause must also be assigned the development of shell cameos, which are rarely found, of an older period.

Among the means of distinguishing antique cameos from cinquecento work, the kind of stone is one of the best tests, the classical artists having used only rich and warm-tinted Oriental stones, which further are frequently drilled through their diameter with a minute hole, from having been used by their original Oriental possessors in the form of beads. The cinquecento artists also, as a rule, worked their subjects in high relief, and resorted to undercutting, no case of which is found in the flat low work of classical times. The projecting portions of antique work exhibit a dull chalky appearance, which, however, fabricators learned to imitate in various ways, one of which was by cramming the gizzards of turkey fowls with the gems. Another index of antiquity is found in the different methods of working adopted in classical and Renaissance times. The tools employed by the Renaissance engraver were the drill and the wheel, while the ancient artist also employed the diamond point.

The gem-engraver's art again during the 18th century revived under an even greater amount of encouragement from men of wealth and rank. In this last period the names of engravers who succeeded best in imitating classical designs were Natter, Pichler (fig. 14), and the Englishmen Marchant (fig. 15) and Burch. Compared with Greek gems, it will be seen that what



FIG. 11.—Christian Gem. The Good Shepherd. (Brit. Mus.)



FIG. 12.—Gnostic Gem. (Brit. Mus.)



FIG. 13.—Sassanian Gem. (Brit. Mus.)

Clemens, the lyre. Under the Gnostics, however, with whom there was more of speculation than of faith, symbolism was developed to an extent which no art could realize without the aid of writing. A gem was to them a talisman more or less elaborate with long, but for the most part quite unintelligible, engraved formulae. The difficulty is to make out how the stones were carried; many specimens exist, but none show signs of mounting. The materials are usually haematite or jasper. As regards the designs, it is clear that Egyptian sources have been most drawn upon. But the symbolism is also largely associated with Mithraic worship. The name Abraxas, or more correctly Abrasax, which, from its frequency on these gems, has led to their being called also "Abraxas gems," is, when the Greek letters of which it is composed are treated as Greek numerals, equal to 365, the number of days in a year, and the same is the case with ΜΕΙΟΡΑΣ.

More interesting, from the occasionally forcible portraiture and the splendour of some of the jacinths employed, are the Sassanian gems, which as a class may be said to represent the last stage of true gem-engraving in ancient times.

The art of cameo-engraving, which, as we have seen, attained its greatest splendour at the beginning of the empire, followed on the whole a similar course. It waned in the early part of the 3rd century after the death of the emperor Severus, but under the first Christian emperor Constantine it enjoyed a brief period of revival. Fine cameo portraits of Constantine are extant; and it was during or shortly after his reign that Christian Scripture subjects began to appear on cameos. That class of subjects constituted the staple of such work—generally rude and artistically debased—as continued to be cultivated under the



Fig. 14.—Muse, by Pichler. (Brit. Mus.)

at first sight is attractive as refined and delicate is after all an exaggerated minuteness of execution, entirely devoid of the ancient spirit. The success with which modern engravers imposed on collectors is recorded in many instances, of which one may be taken as an instructive type.

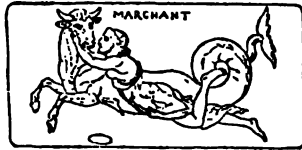

FIG. 15.—Nereid and Sea-bull by Marchant. (Brit. Mus.)

The Bibliothèque Nationale is a gem (Chabouillet's catalogue, No. 2337), familiarly known as the signet of Michelangelo, the subject being a Bacchanalian scene. So much did he admire it, the story says, that he copied from it one of the groups in his paintings in the Sistine chapel. The gem, however, is evidently in this part of it a mere copy from Michelangelo's group, and therefore a subsequent production, probably by da Pesca.

In our own day the engraving of cameos has practically ceased to be pursued as an art. Roman manufacturers cut stones in large quantities to be used as shirt-studs and for setting in finger-rings; and in Rome and Paris an extensive trade is carried on in the cutting of shell cameos, which are largely imported into England and mounted as brooches by Birmingham jewelry manufacturers. The principal shell used is the large bull's-mouth shell (*Cassis risfa*), found in East Indian seas, which has a sard-like underlayer. The black helmet (*Cassis tuberosa*) of the West Indian seas, the horned helmet (*C. cornuta*) of Madagascar, and the pinky queen's conch (*Strombus gigas*) of the West Indies are also employed. The famous potter Josiah Wedgwood introduced a method of making imitations of cameos in pottery by producing white figures on a coloured ground, thus constituting the peculiarity of what is now known as Wedgwood ware.

Gem Collectors.—The habit of gem-collecting is recorded first in the instance of Ismenias, a musician of Cyprus, who appears to have lived in the 4th century B.C. But though individual collectors are not again mentioned till the time of Mithradates, whose cabinet was carried off to Rome by Pompey, still it is to be inferred that they existed, if not pretty generally, yet in such places as Cyrene, where the passion for gems was so great that the thirtieth person owned one worth 10 minas, and where, according to Aelian (*Var. hist.* xii. 30), the skill in engraving was astonishing. The first cabinet (*dactylolitheca*) in Rome was that of Scaurus, a stepson of Sulla. Caesar is said to have formed six cabinets for public exhibition, and from the time of Augustus all men of refinement were supposed to be judges both of the art and of the quality of the stones.

In the middle ages the chief collections were incorporated in works of art in the church treasuries. The first collector of modern times was, as already mentioned, Pope Paul II., who was followed by a long succession of princely and noble collectors such as Lorenzo de' Medici and the great earl of Arundel. The collection of the latter passed into the hands of the dukes of Marlborough and thence into the possession of Mr David Bromilow. The collection was finally dispersed by auction in June 1809.

In modern times the principal collections are contained in state museums. The cabinets of Vienna and of the Bibliothèque Nationale are incomparably rich in the historic cameos. Those of the British Museum and of Berlin are the strongest in their range over the whole field of the gem-engraver's art.

BIBLIOGRAPHY.—For the fullest general account of the subject (with especial attention to the gems of classical antiquity) see A. Furtwängler, *Die antiken Gemmen, Geschichte der Steinschneiderkunst im klassischen Altertum*, in 3 vols (1900). See also E. Babelon, *La Gravure en pierres fines, camées et intailles* (1894); A. H. Smith, "Gemma" and "Sculptura," in the 3rd edition of Smith's *Dict. of Antiquities*; J. H. Middleton, *The Engraved Gems of Classical Times* (1891). Much curious information is in the works of C. W. King: *Handbook of Engraved Gems* (1866); *Antique Gems* (1866); *The Natural History, Ancient and Modern, of Precious Stones and Gems, and of the Precious Metals* (1865); *Antique Gems and Rings* (2 vols., 1873).

Special Periods:—*Babylonia, &c.*—Menant, "Les Pierres gravées de la haute Asie," *Recherches sur la glyptique orientale* (1883-1886).

Egypt.—For the early cylinder sealings, &c., see Petrie, "Royal Tombs of the First Dynasty" (*Egypt Explor. Fund., XVIIIth Memoir*), p. 24; pls. 12, figs. 3 to 7, and pls. 18-29; Amélineau, "Nouvelles Fouilles d'Abydos, 1897-1898," *Compte rendu*, pp. 78, 423; pl. 25, figs. 1-3.

The Bible.—Petrie, "Stones (Precious)," in Hastings' *Dict. of the Bible*.

Phoenician.—See M. A. Levy, *Stiegel und Gemmen*, with three plates of gems having Phoenician, Aramaic, old Hebrew and other inscriptions (Breslau, 1869); and, on the same subject, De Vogue, in the *Revue archéologique*, 2nd series (1868), xvii. p. 432, pls. 14-16.

Crete.—Articles by A. J. Evans in *Journal of Hellenic Studies*, xiv., xvii., xxi., and in *Annual of British School at Athens*, vi. and onwards.

Classical Gems.—See Furtwängler, *op. cit.*

Gnostic Gems.—Cabrol, *Dict. d'archéologie chrétienne, s.v. "Abraxas."*

For the controversy as to gems with artists' signatures, see Koehler, *Abhandlung über die geschnittenen Steine, mit den Namen der Künstler*; Koehler's collected works, ed. Stephani, vol. iii. (1851); Stephani, Notes to Koehler as above; also *Über einige angebliche Steinschneider des Alterthums* (St Petersburg, 1851); Brunn, *Geschichte der griechischen Künstler*, ii. (1859), pp. 442-637; Furtwängler, *Jahrbuch d. k. deutsch. arch. Inst.* iii. (1888), pp. 103, 193, 297; iv. (1889), p. 46, and *Geschichte*, passim.

For the history of the Poniatowski gems, see Reinach, *Pierres gravées*, p. 151.

Catalogues.—The chief catalogues dealing with modern public collections are: Berlin, A. Furtwängler, *Beschreibung der geschnittenen Steine im Antiquarium* (1896); British Museum, A. H. Smith, *A Catalogue of Engraved Gems in the British Museum (Dept. of Greek and Roman Antiquities)* (1888); Paris, Bibliothèque Nationale, Chabouillet, *Catologue . . . des camées et pierres gravées de la Bibliothèque Impériale* (1858); E. Babelon, *Catologue des camées . . . de la Bibliothèque Nationale* (1897).

Modern Engraving.—Vasari, vii. p. 113 (ed. Siena, 1792); continued by Mariette, *Traité des pierres gravées* (1750), l. p. 105.

The older books on gems are very numerous, but those of present-day importance are not many. Faber, *Illustrum imagines . . . apud Falsivum Ursinum* (Antwerp, 1606); Stosch, *Gemmae antiquae caelatae, sculptorum nominibus insigniæ* (Amsterdam, 1724); Winckelmann, *Description des pierres gravées du feu Baron de Stosch* (1760); Krause, *Pyrgoteles, oder die edlen Steine der Alten* (1856); a convenient reissue of Stosch, and seven others of the older works, by S. Reinach, *Pierres gravées, &c. . . réunies et rééditées, avec un texte nouveau* (1895).

Pastes.—The principal collection of glass and sulphur pastes from gems was that issued by James Tassie of Glasgow, with *A Description Catalogue of a General Collection of . . . Engraved Gems . . . arranged and described by R. E. Raspe* (the author of *Baron Munchausen*) (1791). (A. S. M.; A. H. Sm.)

GEM, ARTIFICIAL. The term "Artificial Gems" does not mean imitations of real gems, but the actual formation by artificial means of the real precious stone, so that the product is identical, chemically, physically and optically, with the one found in nature. For instance, in chemical composition the lustrous diamond is nothing but crystallized carbon. Could we take black amorphous carbon in the form of charcoal or lamp-black and dissolve it in a liquid, and by the slow evaporation of that liquid allow the dissolved carbon to separate out, it would probably crystallize in the transparent form of diamond. This would be a true synthesis of diamond, and the product would be just as much entitled to the name as the choicest products of Kimberley or Golconda. But this is a very different thing from the imitation diamond so common in shop windows. Here the chemist has only succeeded in making a paste or glass having limpidity and a somewhat high refractivity, but wanting the hardness and "fire" of the real stone.

The Diamond.—Within recent years chemists have actually succeeded in making the real diamond by artificial means, and although the largest yet made is not more than one-fiftieth of an inch across, the process itself and the train of reasoning leading up to such an achievement are sufficiently interesting to warrant a somewhat full description. Attempts to make diamonds artificially have been numerous, but, with the sole exception of those of Henri Moissan, all have resulted in failure. The nearest approach to success was attained by J. B. Hannay in 1880 and R. S. Marsden in 1881; but their results have not been verified by others who have tried to repeat them, and the probability is that what was then thought to be diamond was in reality carborundum or carbide of silicon.

Attempts have been made by two methods to make carbon crystallize in the transparent form. One is to crystallize it slowly from a solution in which it has been dissolved. The difficulty is to find a solvent. Many organic and some inorganic bodies hold carbon so loosely combined that it can be separated out under the influence of chemical action, heat or electricity, but invariably the carbon assumes the black amorphous form. The other method is to try to fuse the carbon by fierce heat, when from analogy it is argued that on cooling it will solidify to a clear limpid crystal. The progress of science in other directions has now made it pretty certain that the true mode of making diamond artificially is by a combination of these two methods. Until recently it was assumed that carbon was non-volatile at any attainable temperature, but it is now known that at a temperature of about 3600° C. it volatilizes readily, passing without liquefying directly from the solid to the gaseous state. Very few bodies act in this manner, the great majority when heated at atmospheric pressure to a sufficient temperature passing through the intermediate condition of liquidity. Some few, however, which when heated at atmospheric pressure do not liquefy, when heated at higher pressures in closed vessels obey the common rule and first become liquid and then volatilize. Sir James Dewar found the critical pressure of carbon to be about 15 tons on the sq. in.; that is to say, if heated to its critical temperature (3600° C.), and at the same time subjected to a pressure of 15 tons to the sq. in., it will assume the liquid form. Enormous as such pressures and temperatures may appear to be, they have been exceeded in some of Sir Andrew Noble's and Sir F. Abel's researches; in their investigations on the gases from gunpowder and cordite fired in closed steel chambers, these chemists obtained pressures as great as 95 tons to the sq. in., and temperatures as high as 4000° C. Here then, if the observations are correct, we have sufficient temperature and enough pressure to liquefy carbon; and, were there only sufficient time for these to act on the carbon, there is little doubt that the artificial formation of diamonds would soon pass from the microscopic stage to a scale more likely to satisfy the requirements of science, if not those of personal adornment.

It has long been known that the metal iron in a molten state dissolves carbon and deposits it on cooling as black opaque graphite. Moissan carried out a laborious and systematic series of experiments on the solubility of carbon in iron and other metals, and came to the conclusion that whereas at ordinary pressures the carbon separates from the solidifying iron in the form of graphite, if the pressure be greatly increased the carbon on separation will form liquid drops, which on solidifying will assume the crystalline shape and become true diamond. Many other metals dissolve carbon, but molten iron has been found to be the best solvent. The quantity entering into solution increases with the temperature of the metal. But temperature alone is not enough; pressure must be superadded. Here Moissan ingeniously made use of a property which molten iron possesses in common with some few other liquids—water, for instance—of increasing in volume in the act of passing from the liquid to the solid state. Pure iron is mixed with carbon obtained from the calcination of sugar, and the whole is rapidly heated in a carbon crucible in an electric furnace, using a current of 700 amperes and 40 volts. The iron melts like wax and saturates itself with carbon. After a few minutes' heating to a temperature above 4000° C.—a temperature at which the lime furnace begins to melt and the iron volatilizes in clouds—the dazzling, fiery crucible is lifted out and plunged beneath the surface of cold water, where it is held till it sinks below a red heat. The sudden cooling solidifies the outer skin of molten metal and holds the inner liquid mass in an iron grip. The expansion of the inner liquid on solidifying produces enormous pressure, and under this stress the dissolved carbon separates out in a hard, transparent, dense form—in fact, as diamond. The succeeding operations are long and tedious. The metallic ingot is attacked with hot *aqua regia* till no iron is left undissolved. The bulky residue consists chiefly of graphite, together with translucent flakes of chestnut-coloured carbon, *hard black opaque carbon of a density of from 3.0 to 3.5, black*

diamonds—carbonade, in fact—and a small quantity of transparent colourless diamonds showing crystalline structure. Besides these there may be corundum and carbide of silicon, arising from impurities in the materials employed. Heating with strong sulphuric acid, with hydrofluoric acid, with nitric acid and potassium chlorate, and fusing with potassium fluoride—operations repeated over and over again—at last eliminate the graphite and impurities and leave the true diamond untouched. The precious residue on microscopic examination shows many pieces of black diamond, and other colourless transparent pieces, some amorphous, others crystalline. Although many fragments of crystals are seen, the writer has scarcely ever met with a complete crystal. All appear broken up, as if, on being liberated from the intense pressure under which they were formed, they burst asunder. Direct evidence of this phenomenon has been seen. A very fine piece of diamond, prepared in the way just described and carefully mounted on a microscopic slide, exploded during the night and covered the slide with fragments. This bursting paroxysm is not unknown at the Kimberley mines.

Sir William Crookes in 1906 communicated to the Royal Society a paper on a new formation of diamond. Sir Andrew Noble has shown that in the explosion of cordite in closed steel cylinders pressures of over 50 tons to the sq. in. and a temperature probably reaching 5400° were obtained. Here then we have conditions favourable for the liquefaction of carbon, and if the time of explosion were sufficient to allow the reactions to take place we should expect to get liquid carbon solidified in the crystalline state. Experiment proved the truth of these anticipations. Working with specially prepared explosive containing a little excess of carbon Sir Andrew Noble collected the residue left in the steel cylinder. This residue was submitted by Sir William Crookes to the lengthy operations already described in the account of H. Moissan's fused iron experiment. Finally, minute crystals were obtained which showed octahedral planes with dark boundaries due to high refracting index. The position and angles of their faces, and cleavages, the absence of birefringence, and their high refractive index all showed that the crystals were true diamonds.

The artificial diamonds, so far, have not been larger than microscopic specimens, and none has measured more than about half a millimetre across. That, however, is quite enough to show the correctness of the train of reasoning leading up to the achievement, and there is no reason to doubt that, working on a larger scale, larger diamonds will result. Diamonds so made burn in the air when heated to a high temperature, with formation of carbonic acid; and in lustre, crystalline form, optical properties, density and hardness, they are identical with the natural stone.

It having been shown that diamond is formed by the separation of carbon from molten iron under pressure, it became of interest to see if in some large metallurgical operations similar conditions might not prevail. A special form of steel is made at some large establishments by cooling the molten metal under intense hydraulic pressure. In some samples of the steel so made Professor Rosel, of the university of Bern, has found microscopic diamonds. The higher the temperature at which the steel has been melted the more diamonds it contains, and it has even been suggested that the hardness of steel in some measure may be due to the carbon distributed throughout its mass being in this adamantine form. The largest artificial diamond yet formed was found in a block of steel and slag from a furnace in Luxembourg; it is clear and crystalline, and measures about one-fiftieth of an inch across.

A striking confirmation of the theory that natural diamonds have been produced from their solution in masses of molten iron, the metal from which has gradually oxidized and been washed away under cycles of atmospheric influences, is afforded by the occurrence of diamonds in a meteorite. On a broad open plain in Arizona, over an area of about 5 m. in diameter, lie scattered thousands of masses of metallic iron, the fragments varying in weight from half a ton to a fraction of an ounce. There is little doubt that these fragments formed part of a meteoric shower, although no record exists as to when the fall took place.

Near the centre, where most of the fragments have been found, is a crater with raised edges, three-quarters of a mile in diameter and 600 ft. deep, bearing just the appearance which would be produced had a mighty mass of iron—a falling star—struck the ground, scattered it in all directions, and buried itself deeply under the surface, fragments eroded from the surface forming the pieces now met with. Altogether ten tons of this iron have been collected, and specimens of the Canyon Diablo meteorite are in most collectors' cabinets. Dr A. E. Foote, a mineralogist, when cutting a section of this meteorite, found the tools injured by something vastly harder than metallic iron, and an emery wheel used for grinding it was ruined. He attacked the specimen chemically, and soon afterwards announced to the scientific world that the Canyon Diablo meteorite contained diamonds, both black and transparent. This startling discovery was subsequently verified by Professors C. Friedel and H. Moissan, and also by Sir W. Crookes.

The Ruby.—It is evident that of the other precious stones only the most prized are worth producing artificially. Apart from their inferior hardness and colour, the demand for what are known as "semi-precious stones" would not pay for the necessarily great expenses of the factory. Moreover, were it to be known that they were being produced artificially the demand—never very great—would almost cease. The only other gems, therefore, which need be mentioned in connexion with their artificial formation are those of the corundum or sapphire class, which include all the most highly prized gems, rivalling, and sometimes exceeding, the diamond in value. Here a remarkable and little-known fact deserves notice. Excepting the diamond and sapphire, each of the precious stones—the emerald, the topaz and amethyst—possesses a more noble, a harder, and more highly-prized counterpart of itself, alike in colour, but superior in brilliancy and hardness; still more strange, the precious stone to which its special name is usually attached is the variety the least prized. The ruby itself might almost be included in the same category. The true ruby consists of the earth alumina, in a clear, crystalline form, having a minute quantity of the element chromium as the colouring matter. It is often called the "Oriental Ruby," or red sapphire, and when of a paler colour, the "Pink Sapphire." But the ruby as met with in jewellers' shops of inferior standing is usually no true ruby, but a "spinel ruby" or "balas ruby," sometimes very beautiful in colour, but softer than the Oriental ruby, and different in chemical composition, consisting essentially of alumina and magnesia and a little silica, with the colouring matter chromium. The colourless basis of the true Oriental precious stones being taken as crystallized alumina or white sapphire, when the colouring matter is red the stone is called ruby, when blue sapphire, when green Oriental emerald, when orange-yellow Oriental topaz, and when violet Oriental amethyst. Clear, colourless crystals are known as white sapphire, and are very valuable. It is evident, therefore, that whosoever succeeds in making artificially clear crystals of white sapphire has the power, by introducing appropriate colouring matter, to make the Oriental ruby, sapphire, emerald, topaz and amethyst. All of these stones, even when of small size, are costly and readily saleable, while when they are of fine quality and large size they are highly prized, a ruby of fine colour, and free from flaws, a few carats in weight, being of more value than a diamond of the same weight.

This being the case, it is not surprising that repeated attempts have been made to effect the crystallization of alumina. This is not a matter of difficulty, but unfortunately the crystals generally form thin plates, of good colour, but too thin to be useful as gems. In 1837 M. A. A. Gaudin made true rubies, of microscopic size, by fusing alum in a carbon crucible at a very high temperature, and adding a little chromium as colouring matter. In 1847 J. J. Ebelmen produced the white sapphire and rose-coloured spinel by fusing the constituents at a high temperature in boracic acid. Shortly afterwards he produced the ruby by employing borax as the solvent. The boracic acid was found to be too volatile to allow the alumina to crystallize,

but the use of borax made the necessary difference. But it was not till about the year 1877 that E. Frémy and C. Feil first published a method whereby it was possible to produce a crystallized alumina from which small stones could be cut. They first formed lead aluminate by the fusion together of lead oxide and alumina. This was kept in a state of fusion in a fireclay crucible (in the composition of which silica enters largely). Under the influence of the high temperature the silica of the crucible gradually decomposes the lead aluminate, forming lead silicate, which remains in the liquid state, and alumina, which crystallizes as white sapphire. By the admixture of 2 or 3% of a chromium compound with original materials the resulting white sapphire became ruby. More recently Edmond Frémy and A. Verneuil obtained artificial rubies by reacting at a red heat with barium fluoride on amorphous alumina containing a small quantity of chromium. The rubies obtained in this manner are thus described by Frémy and Verneuil: "Their crystalline form is regular; their lustre is adamantine; they present the beautiful colour of the ruby; they are perfectly transparent, have the hardness of the ruby, and easily scratch topaz. They resemble the natural ruby in becoming dark when heated, resuming their rose-colour on cooling." Des Cloizeaux says of them that "under the microscope some of the crystals show bubbles. In converging polarized light the coloured rings and the negative black cross are of a remarkable regularity."

Other experimentalists have attacked the problem in other directions. Besides those already mentioned, L. Elsner, H. H. De Senarmont, Sainte-Claire Deville, and H. Caron and H. Debray have succeeded with more or less success in producing rubies. The general plan adopted has been to form a mixture of salts fusible at a red heat, forming a liquid in which alumina will dissolve. Alumina is now added till the fused mass will take up no more, and the crucible is left in the furnace for a long time, sometimes extending over weeks. The solvent slowly volatilizes, and the alumina is deposited in crystals, coloured by whatever colouring oxide has been added.

Mention has been made above of a stone frequently substituted for the true ruby, called the "spinel" or "balas" ruby. The spinel and ruby occur together in nature, stones from Burma being as often spinel as true Oriental ruby. In the artificial production of the ruby it sometimes happens that spinel crystallizes out when true Oriental ruby is expected. The fusion bath is so arranged that only red-coloured alumina shall crystallize out, but it is difficult to have all the materials of such purity as to ensure the complete absence of silica and magnesia. In this case, when these impurities have accumulated to a certain point they unite with the alumina, and spinel then separates, as it crystallizes more easily than ruby. When all the magnesia and silica have been eliminated in this way the bath resumes its deposition of crystalline ruby. Rubies of fine colour and of considerable size have been shown in London, made on the Continent by a secret process. The writer has seen several cut stones so made weighing over a carat each, the uncut crystals measuring half an inch along a crystal edge, and weighing over 70 grains, and a clear plate of ruby cut from a single crystal weighing over 10 grains. Ruby has been made by Sir W. Roberts-Austen as a by-product in the production of metallic chromium. Oxide of chromium and aluminium powder are intimately mixed together in a refractory crucible, and the mixture is ignited at the upper part. The aluminium and chromium oxide react with evolution of so much heat that the reduced chromium is melted. Such is the intensity of the reaction that the resulting alumina is also completely fused, floating as a liquid on the molten chromium. Sometimes the alumina takes up the right amount of chromium to enable it to assume the ruby colour. On cooling the melted alumina crystallizes in large flakes, which on examination by transmitted light are seen to be true ruby. The development of the red colour is said by C. Greville-Williams only to take place at a white heat. It is not due to the presence of chromic acid, but to a reaction between alumina and chromic oxide, which requires an elevated temperature.

Artificially made but real rubies have been put on the market;

prepared by a process of fusion by A. Verneuil. He finds that certain conditions have to be fulfilled in order to get the alumina in a transparent form. The temperature must not be higher than is absolutely necessary for fusion. The melted product must always be in the same part of the oxyhydrogen flame, and the point of contact between the melted product and the support should be reduced to as small an area as possible. M. Verneuil uses a vertical blowpipe flame directed on a support capable of movement up and down by means of a screw, so that the fused product may be removed from the zone of fusion as it gets higher by addition of fresh material. The material employed is either composed of small, valueless rubies, or alumina coloured with the right amount of chromium. It is very finely powdered and fed in through the blowpipe orifice, whence it is blown in a highly heated condition into the zone of fusion. The support is a small cylinder of alumina placed in the axis of the blowpipe. As the operation proceeds the fine grains of powder driven on to the support in the zone of fusion form a cone which gradually rises and broadens out until it becomes of sufficient size to be used for cutting. Rubies prepared in this way have the same specific gravity and hardness as the natural ruby, and they are also dichroic, and in the vacuum tube under the influence of the cathode stream they phosphoresce with a discontinuous spectrum showing the strong alumina line in the red. When properly cut and mounted it is almost impossible to distinguish them from natural stones.

The Sapphire.—Auguste Daubrée has shown that when a full quantity of chromium is added to the bath from which white sapphire crystallizes the colour is that of ruby, but when much less chromium is added the colour is blue, forming the true Oriental sapphire. The real colouring matter of the Oriental sapphire is not definitely known, some chemists considering it to be chromium and others cobalt. Artificial sapphires have been made of a fair size and perfectly transparent by the addition of cobalt to the igneous bath of alumina, but the writer does not consider them equal in colour to true Oriental sapphire.

The Oriental Emerald.—The stone known as emerald consists chemically of silica, alumina and glucina. Like the ruby, it owes its colour to chromium, but in a different state of oxidation. As already mentioned, there is another stone which consists of crystallized alumina coloured with chromium, but holding the chromium in a different state of oxidation. This is called the Oriental emerald, and, owing to its beauty of colour, its hardness and rarity, it is more highly prized than the emerald itself and commands higher prices. The Oriental emerald has been produced artificially in the same way as the ruby, by adding a larger amount of chromium to the alumina bath and regulating the temperature.

The Oriental Amethyst.—The amethyst is rock crystal (quartz) of a bluish-violet colour. It is one of the least valuable of the precious stones. The sapphire, however, is found occasionally of a beautiful violet colour; it is then called the Oriental amethyst, and, on account of its beauty and rarity, is of great value. It is evident that if to the igneous bath of alumina some colouring matter, such as manganese, is added capable of communicating a violet colour to the crystals of alumina, the Oriental amethyst will be the result. Oriental amethyst has been so formed artificially, but the stone being known only as a curiosity to mineralogists and experts in precious stones, and the public not being able to discriminate between the violet sapphire and amethystine quartz, there is no demand for the artificial stone.

The Oriental Topaz.—The topaz is what is called a semi-precious stone. It occurs of many colours, from clear white to pink, orange, yellow and pale green. The usual colour is from straw-yellow to sherry colour. The exact composition of the colouring matter is not known; it is not entirely of mineral origin, as it changes colour and sometimes fades altogether on exposure to light. Chemically the topaz consists of alumina, silica and fluorine. It is not so hard as the sapphire. There is also a yellow variety of quartz, which is sometimes called "false topaz." The Oriental topaz, on the other hand, is a precious stone of great value. It consists of clear crystalline sapphire

coloured with a small quantity of ferric oxide. It has been produced artificially by adding iron instead of chromium to the matrix from which the white sapphire crystallizes.

The Zircon.—The zircon is a very beautiful stone, varying in colour, like the topaz, from red and yellow to green and blue. It is sometimes met with colourless, and such are its refractive powers and brilliancy that it has been mistaken for diamond. It is a compound of silica and zirconia. H. Sainte-Claire Deville formed the zircon artificially by passing silicon fluoride at a red heat over the oxide zirconia in a porcelain tube. Octahedral crystals of zircon are then produced, which have the same crystalline form, appearance and optical qualities as the natural zircon.

BIBLIOGRAPHY.—Sir William Crookes, "A New Formation of Diamond," *Proc. Roy. Soc.* vol. lxxvi. p. 458; "Diamonds," a lecture delivered before the British Association at Kimberley, South Africa, 5th September, 1905, *Chemical News*, vol. xcii. pp. 135, 147, 159; J. J. Ebelmen, "Sur la production artificielle des pierres dures," *Comptes rendus*, vol. xxv. p. 279; "Sur une nouvelle méthode pour obtenir, par la voie sèche, des combinaisons cristallines, et sur ses applications à la reproduction de plusieurs espèces minérales," *Comptes rendus*, vol. xxv. p. 661; Edmond Frémy and C. Feil, "Sur la production artificielle du corindon, du rubis, et de différents silicates cristallisés," *Comptes rendus*, vol. lxxv. p. 1029; C. Friedel, "Sur l'existence du diamant dans le fer météorique de Cañon Diablo," *Comptes rendus*, vol. cxv. p. 1037, vol. cxvi. p. 290; H. Moissan, "Étude de météorite de Cañon Diablo," *Comptes rendus*, vol. cxvi. p. 288; "Expériences sur la reproduction du diamant," *Comptes rendus*, vol. cxviii. p. 320; "Sur quelques expériences relatives à la préparation du diamant," *Comptes rendus*, vol. cxviii. p. 206; *La Force Electrique* (Paris, 1897); H. Sainte-Claire Deville and H. Caron, "Sur un nouveau mode de production à l'état cristallisé d'un certain nombre d'espèces chimiques et minérales," *Comptes rendus*, vol. xlvi. p. 764; A. Verneuil, "Production artificielle des rubis par fusion," *ibid.* vol. cxxxv. p. 791; J. Boyer, *La Synthèse des pierres précieuses* (Paris, 1909). (W. C.)

GEMBLOUX, a town in the province of Namur and on the borders of Brabant, Belgium, 25 m. S.E. of Brussels on the main line to Namur and Luxembourg. Pop. (1904) 4643. It is a busy place with large railway and engine works, and the junction for several branch lines. On the 31st of January 1578 Don John of Austria gained here a signal victory over the army of the provinces led by Antony de Goignies.

GEMINI ("The Twins," i.e. Castor and Pollux), in astronomy, the third sign in the zodiac, denoted by the symbol ♊. It is also a constellation, mentioned by Eudoxus (4th century B.C.) and Aratus (3rd century B.C.), and catalogued by Ptolemy, 25 stars, Tycho Brahe 25, and Hevelius 38. By the Egyptians this constellation was symbolized as a couple of young kids; the Greeks altered this symbol to two children, variously said to be Castor and Pollux, Hercules and Apollo, or Triptolemus and Iasion; the Arabians used the symbol of a pair of peacocks. Interesting objects in this constellation are: a Geminorum or Castor, a very fine double star of magnitudes 2.0 and 2.8, the fainter component is a spectroscopic binary; η Geminorum, a long period (231 days) variable, the extreme range in magnitude being 3.2 to 4.5; Geminorum, a short period variable, 10.15 days, the extreme range in magnitude being 3.7 to 4.5; *Novæ* Geminorum, a "new" star discovered in 1903 by H. H. Turner of Oxford; and the star cluster M.35 Geminorum, a fine and bright, but loose, cluster, with very little central condensation.

GEMINIANI, FRANCESCO (c. 1680–1762), Italian violinist, was born at Lucca about 1680. He received lessons in music from Alessandro Scarlatti, and studied the violin under Lunati (Gobbo) and afterwards under Corelli. In 1714 he arrived in London, where he was taken under the special protection of the earl of Essex, and made a living by teaching and writing music. In 1715 he played his violin concertos with Handel at the English court. After visiting Paris and residing there for some time, he returned to England in 1755. In 1761 he went to Dublin, where a servant robbed him of a musical manuscript on which he had bestowed much time and labour. His vexation at this loss is said to have hastened his death on the 17th of September 1762. He appears to have been a first-rate violinist, but most of his compositions are dry and deficient in melody. His *Art of Playing the Violin* is a good work of its kind, but his *Grande*

armonica is an inferior production. He published a number of solos for the violin, three sets of violin concertos, twelve violin trios, *The Art of Accompaniment on the Harpsichord, Organ, &c., Lessons for the Harpsichord* and some other works.

GEMISTUS PLETHO (or PLETHON), **GEORGIUS** (c. 1355-1450), Greek Platonic philosopher and scholar, one of the chief pioneers of the revival of learning in Western Europe, was a Byzantine by birth who settled at Mistra in the Peloponnese, the site of ancient Sparta. He changed his name from Gemistus to the equivalent Pletho ("the full"), perhaps owing to the similarity of sound between that name and that of his master Plato. He invented a religious system founded on the speculative mysticism of the Neoplatonists, and founded a sect, the members of which believed that the new creed would supersede all existing forms of belief. But he is chiefly memorable for having introduced Plato to the Western world. This took place upon his visit to Florence in 1439, as one of the deputies from Constantinople on occasion of the general council. Cardinal Bessarion became his disciple; he produced a great impression upon Cosimo de' Medici; and though not himself making any very important contribution to the study of Plato, he effectually shook the exclusive domination which Aristotle had exercised over European thought for eight centuries. He promoted the union of the Greek and Latin Churches as far as possible, but his efforts in this direction bore no permanent fruit. He probably died before the capture of Constantinople. The most important of his published works are treatises on the distinction between Plato and Aristotle as philosophers (published at Venice in 1540); on the religion of Zoroaster (Paris, 1538); on the condition of the Peloponnese (ed. A. Ellissen in *Analekten der mittel- und neugriechischen Literatur*, iv.); and the *Nómoi* (ed. C. Alexandre, Paris, 1858). In addition to these he compiled several volumes of excerpts from ancient authors, and wrote a number of works on geography, music and other subjects, many of which still exist in MS. in various European libraries.

See especially F. Schultze, *Geschichte der Philosophie der Renaissance*, i. (1874); also J. A. Symonds, *The Renaissance in Italy* (1877), ii. p. 198; H. F. Tozer, "A Byzantine Reformer," in *Journal of Hellenic Studies*, vii. (1886), chiefly on Pletho's scheme of political and social reform for the Peloponnese, as set forth in the pamphlets addressed to Manuel II. Palaeologus and his son Theodore, despot of the Morea; W. Gass, *Gennadius und Pletho* (1844). Most of Pletho's works will be found in J. P. Migne, *Patrologia Graeca*, cix.; for a complete list see Fabricius, *Bibliotheca Graeca* (ed. Harles), xii.

GEMMI PASS, a pass (7641 ft.) leading from Frutigen in the Swiss canton of Bern to Leukerbad in the Swiss canton of the Valais. It is much frequented by travellers in summer. From Kandersteg (7½ m. by road above Frutigen, which is 12 m. by rail from Spiez on the Bernese-Interlaken line) a mule path leads to the summit of the pass, passing over the Spitalmatte plain, where in 1782 and again in 1805 a great avalanche fell from the Alps (11,930 ft.) to the S.E., causing on both occasions great loss of life and property. The mule path descends on the south side of the pass by an extraordinary series of zigzags, made accessible for mules (though no rider is now allowed to descend on mule-back) by a band of Tirolese workmen in 1740-1741. They are cut in a very steep wall of rock, about 1800 ft. in height, and lead down to the village of Leukerbad, which is 9½ m. by carriage road past Leuk above the Susten station in the Rhône valley and on the Simplon line. (W. A. B. C.)

GENDARMERIE, originally a body of troops in France composed of *gendarmes* or men-at-arms. In the days of chivalry, they were mounted and armed cap-à-pie, exactly as were the lords and knights, with whom they constituted the most important part of an army. They were attended each by five soldiers of inferior rank and more lightly armed. In the later middle-ages the men-at-arms were furnished by owners of fiefs. But after the Hundred Years' War this feudal gendarmerie was replaced by the *compagnies d'ordonnance* which Charles VII. formed when the English were driven out of France, and which were distributed throughout the whole extent of the kingdom for preserving order and maintaining the king's authority. These companies, fifteen in number, were composed of 100 lances or *gendarmes* fully

equipped, each of whom was attended by at least three archers, one *couillier* (soldier armed with a cutlass) and one *valet* (soldier's servant). The states-general of Orleans (1439) had voted a yearly subsidy of 1,200,000 livres in perpetuity to keep up this national soldiery, which replaced, and in fact was recruited chiefly amongst, the bands of mercenaries who for about a century had made France their prey. The number and composition of the *compagnies d'ordonnance* were changed more than once before the reign of Louis XIV. This sovereign on his accession to the throne found only eight companies of *gendarmes* surviving out of an original total of more than one hundred, but after the victory of Fleurus (1690), which had been decided by their courage, he increased their number to sixteen. The four first companies (which were practically guard troops) were designated by the names of *Gendarmes écossais*, *Gendarmes anglais*, *Gendarmes bourguignons* and *Gendarmes flamands*, from the nationality of the soldiers who had originally composed them; but at that time they consisted entirely of French soldiers and officers. These four companies had a captain-general, who was the king. The fifth company was that of the queen; and the others bore the name of the princes who respectively commanded them. This organization was dissolved in 1788. The Revolution swept away all these institutions of the monarchy, and, with the exception of a short revival of the *Gendarmes de la garde* at the Restoration, henceforward the word "gendarmerie" possesses an altogether different significance—viz. military police.

GENEALOGY (from the Gr. γένος, family, and λόγος, theory), a pedigree or list of ancestors, or the study of family history.

1. *Biblical Genealogies*.—The aims and methods of ancient genealogists require to be carefully considered before the value of the numerous ancestral lists in the Bible can be properly estimated. Many of the old "genealogies," like those of Greece, have arisen from the desire to explain the origin of the various groups which they include. Information relating to the subdivision of tribes, their relation to each other, the intermingling of populations and the like are thus frequently represented in the form of genealogies. The "sons" of a "father" often stand merely for the branches of a family as they existed at some one period, and since in course of time tribal relations would vary, lists which have originated at different periods will present discrepancies. It is obvious that many of the Biblical names are nothing more than personifications of nations, tribes, towns, &c., which are grouped together to convey some idea of the bond by which they were believed to be connected.

For the personification of a people or tribe, cp. Gen. xxxiv. 30 ("Jacob said . . . I am a few men"), Josh. xvii. 14 ("the children of Joseph said . . . I am a numerous people"), Ex. xiv. 25 ("Egypt said; let me flee"), Jos. ix. 7, 1 Sam. v. 10, &c.; see G. B. Gray on Numbers, xx. 14 (*Internat. Crit. Comm.*). Thus we find among the "sons" of Japheth: (the nations) Gomer, Javan, Tubal; Canaan "begat" Sidon and Heth; the "sons" of Ishmael include the well-known tribes Kedar and Jetur; Jacob, or the synonym Israel, personifies the "children of Israel" (cf. use of "I," "thou" of the Israelites in Deut., and in poetical passages). The recognition of this characteristic usage often furnishes an ethnological interpretation to those genealogical stories which obviously do not relate to persons, but to tribes or peoples personified. The Edomites and Israelites are regarded as "brothers" (cf. Num. xx. 14, Deut. ii. 4, Am. i. 11), and since Esau (Edom) was born before Jacob (Israel) it would appear that the Edomites were held to be the older nation. The union of two clans is expressed as a marriage, or the wife is the territory which is dominated by the husband (tribe); see CALEB. If the woman is not of noble blood, but is a handmaiden or concubine, her children are naturally not upon the same footing as those of the wife; consequently the descendants of Ishmael, the son of Hagar (Sarah's maid), are inferior to Isaac and his descendants, whilst the children of Keturah ("incense"), Abraham's concubine, are still lower—from the Israelite point of view. This application of the terms of relationship is characteristic of the Semites. The "father" of the Rechabites is their head or founder (cf. 1 Sam. x. 12: "who is their father?"), and a common bond, which is not necessarily physical, unites all "sons," whether they are "sons of the prophets" (members of prophetic guilds) or "sons of Belial" (worthless men).

The interpretation of ethnological or statistical genealogies may easily be pushed too far. Every case has to be judged upon

its own merits, and due allowance must be made both for the ambition of the weaker to claim or to strengthen an alliance with the stronger, and for the not unnatural desire of clans or individuals to magnify the greatness of their ancestry. The first step must always be the careful comparison of related lists in order to test the consistency of the tradition. Next, these must be critically studied in the light of all available historical material, though indeed such evidence is not necessarily conclusive. Finally, (a) literary criticism must be employed to determine if possible the dates of such lists, since obviously a contemporary register is more trustworthy than one which is centuries later; (b) a critical estimate of the character of the names and of their use in various periods of Old Testament history is of importance in estimating the antiquity of the list—for example, many of the names in Chronicles attributed to the time of David are indubitably exilic or post-exilic; and (c) principles of ordinary historical probability are as necessary here as in dealing with the genealogies of other ancient peoples, and attention must be paid to such features as fluctuation in the number of links, representation of theories inconsistent with the growth of national life, schemes of relationship not in accordance with sociological conditions, &c.

The Biblical genealogies commence with "the generations of the heaven and earth," and by a process of elimination pass from Adam and Eve by successive steps to Jacob and to his sons (the tribes), and finally to the subdivisions of each tribe (cp. 1 Chron. i.-ix. 1). According to this theory every Israelite could trace back his descent to Jacob, the common father of the whole nation (Josh. vii. 17 seq., 1 Sam. x. 21). Such a scheme, however, is full of manifest improbabilities. It demands that every tribe and every clan should have been a homogeneous group which had preserved its unity from the earliest times, that family records extending back for several centuries were in existence, and that such a tribe as Simeon was able to maintain its independence in spite of the tradition that it lost its autonomy in very early times (Gen. xlix. 7). The whole conception of the unity of the tribes cannot be referred to a date previous to the time of David, and in the older writings a David or a Jeroboam was sufficiently described as the son of Jesse or of Nebat. The genealogical zeal as represented in the Old Testament is chiefly of later growth, and the exceptions are due to interpolation (Josh. vii. 18, contrast v. 24), or to the desire to modify or qualify an older notice. This, in the case of Saul (1 Sam. ix. 1), has led to textual corruption; a list of such a length as his should have reached back to one of the "sons" of Benjamin (cf. e.g. Gen. xli. 21), else it were purposeless. The genealogies, too, are often inconsistent amongst themselves and in contradiction to their object. They show, for example, that the population of southern Judah, so far from being "Israelite" was half-Edomite (see JUDAH), and several of the clans in this district bear names which indicate their original affinity with Midian or Edom. Moreover, there was a free intermixture of races, and many cities had a Canaanite (i.e. pre-Israelite) population which must have been gradually absorbed by the Israelites (cf. Judg. i.). That spirit of religious exclusiveness which marked later Judaism did not become prominent before the Deuteronomistic reformation (see DEUTERONOMY), and it is under its influence that the writings begin to emphasize the importance of maintaining the purity of Israelite blood, although by this time the fusion was complete (see Judg. iii. 6) and for practical purposes a distinction between Canaanites and Israelites within the borders of Palestine could scarcely be discerned.

Many of the genealogical data are intricate. Thus, the interpretation of Gen. xxxiv. is particularly obscure (see LEVITES *ad fin.*; SIMEON). As regards the sons of Jacob, it is difficult to explain their division among the four wives of Jacob; viz. (a) the sons of Leah are Reuben, Simeon, Levi and Judah (S. Palestine), Issachar and Zebulun (in the north), and Dinah (associated with Shechem); (b) of Leah's maid Zilpah, Gad and Asher (E. and N. Palestine); (c) of Rachel, Joseph (Manasseh and Ephraim, i.e. central Palestine) and Benjamin; (d) of Rachel's maid Bilhah, Dan and Naphtali

¹ G. B. Gray's *Hebrew Proper Names* (1896), with his article in the *Expositor* (Sept. 1897), pp. 173-190, should be consulted for the application and range of Hebrew names in O.T. genealogies and lists.

(N. Palestine). It has been urged that (b) and (d) stood upon a lower footing than the rest, or were of later origin; or that Bilhah points to an old clan associated with Reuben (Gen. xxxv. 22) or Edom (Bilhan, Gen. xxvii. 27), while Zilpah represents an Aramaean strain. Tradition may have combined distinct schemes, and the belief that the wives were Aramaean at least coincides with the circumstance that Aramaean elements predominated in certain of the twelve tribes. The number "twelve" is artificial and can be obtained only by counting Manasseh and Ephraim as one or by omitting Levi, and a careful study of Old Testament history makes it extremely difficult to recover the tribes as historical units. See, on these points, the articles on the several tribes, B. Luther, *Zeit. d. alltest. Wissens.* (1901), pp. 1 sqq.; G. B. Gray, *Expositor* (March 1902), pp. 225-240, and in *Ency. Bib.*, art. "Tribes"; and H. W. Hogg's thorough treatment of the tribes in the last-mentioned work.

The ideal of purity of descent shows itself conspicuously in portions of Deuteronomistic law (Deut. vii. 1-3, xxiii. 2-8), and in the reforms of Nehemiah and Ezra (Ezr. ix. 1-4, 11 sqq.; Neh. xiii. 1-3). The desire to prove the continuity of the race, enforced by the experience of the exile, gave the impetus to genealogical zeal, and many of the extant lists proceed from this age when the true historical succession of names was a memory of the past. This applies with special force to the lists in Chronicles which present finished schemes of the Levitical divisions by the side of earlier attempts, with consequent confusion and contradiction. Thus the immediate ancestors of Ethan appear in the time of Hezekiah (2 Chron. xxix. 12), but he with Asaiah and Heman are contemporaries of David, and their genealogies from Levi downwards contain a very unequal number of links (1 Chron. vi.). By another application of genealogical method the account of the institution of priests and Levites by David (1 Chron. xxiv.) presents many names which belong solely to post-exilic days, thus suggesting that the scribes desired to show that the honourable families of their time were not unknown centuries previously. Everywhere we find the results of much skill and labour, often in accordance with definite theories, but a thorough investigation reveals their weakness and often quite incidentally furnishes valuable evidence of another nature.

The intricate Levitical genealogies betray the result of successive genealogists who sought to give effect to the development of the hierarchal system (see LEVITES). The climax is reached when all Levites are traced back to Gershon, Kehath and Merari, to which are ascribed respectively Asaph, Heman and Ethan (or Jeduthun). The last two were not originally Levites in the later accepted sense of the term (see 1 Kings iv. 31). To Kehath is reckoned an important subdivision descended from Korah, but in 2 Chron. xx. 19 the two are distinct groups, and Korah's name is that of an Edomite clan (Gen. xxxvii. 5, 14, 18) related to Caleb, and thus included among the descendants of Judah (1 Chron. ii. 43). Cases of adjustment, redistribution and "Levitzing" (i.e. individuals) are frequent. There are traces of varying divisions both of the singers (Neh. xi. 17) and of the Levites (Num. xxvi. 58; Ezr. ii. 40, iii. 9; 1 Chron. xv. 5-10, xxiii.), and it is noteworthy that in the case of the latter we have mention of such families as Hebronite (Hebronite), Libni (from Libnah)—ethnics of South Judaean towns. In fact, a significant number of Levitical names find their analogy in the lists of names belonging to Judah, Simeon and even Edom, or are closely connected with the family of Moses; e.g. Mushi (i.e. Mosaic), Gershon and Eleazar (cp. Gershom and Eliezer, sons of Moses). The Levites bear a class-name, and the genealogies show that many of them were connected with the minor clans and families of South Palestine which included among them Moses and his kin. Hence, it is not unnatural that Obad-edom, for example, obviously a southerner, should have been reckoned later as a Levite, and the work ascribed by the chronicler's history to the closing years of David's life may be influenced by the tradition that it was through him these mixed populations first attained importance. See further DAVID; JEWS; LEVITES.

In the time of Josephus every priest was supposed to be able to prove his descent, and perhaps from the time of Ezra downwards lists were carefully kept. But when Anna is called an Asherite (Luke ii. 36), or Paul a Benjamite (Rom. xi. 1), family tradition was probably the sole support to the claim, although the tribal feeling had not become entirely extinct. The genealogies of Jesus prefixed to two of the gospels are intended to prove that He was a son of David. But not that alone, for in Matt. i. he is traced back to Abraham the father of the Jews, whilst in Luke iii. He, as the second Adam, is traced back to the first man. The two lists are hopelessly inconsistent; not because one of them follows the line of Mary, but because they represent independent attempts. That in Matthew is characteristically arranged in

three series of fourteen generations each through the kings of Judah, whilst Luke's passes through an almost unknown son of David; in spite of this, however, both converge in the person of Zerubbabel.

See further, A. C. Hervey, *Genealogies of Our Lord*; H. von Soden, *Ency. Bib.* ii. col. 1666 sqq.; B. W. Bacon, *Hastings' Dict. Bib.* ii. pp. 138 sqq. On the subject generally see J. F. M'Lennan's *Studies* (2nd ser., ch. ix., "fabricated genealogies"); S. A. Cook, *Ency. Bib.* ii. col. 1657 sqq. (with references); W. R. Smith, *Kinship and Marriage* (2nd ed., especially ch. i.). (S. A. C.)

2. *Greek and Roman Genealogies*.—A passing reference only is needed to the intricate genealogies of gods and sons of gods which form so conspicuous a feature in classical literature.¹ In every one of the numerous states into which ancient Greece was divided there were aristocratic families, whose genealogies as a rule went back to prehistoric times, their first ancestor being some hero of divine descent, from whom, or from some distinguished younger ancestor, they derived their names. Many of these families were, as families, undoubtedly of great antiquity even at the beginning of the historical period; and in several instances they continued to maintain a conspicuous and separate existence for centuries. The element of family pride is prominent in the poetry of the Megarian Theogonist; and in an inscription belonging to the 2nd century B.C. the recipient of certain honours from the community of Gythium is represented as the thirty-ninth in direct descent from the Dioscuri and the forty-first from Heracles. Even in Athens, long after the constitution had become thoroughly democratic, some of the clans continued to be known as Eupatridæ (of noble family); and Alcibiades, for example, as a member of the phratry of the Eurysacidae, traced his origin through many generations to Eurysaces, who was represented as having been the first of the Aecidae to settle in Attica. The Corinthian Bacchiadae traced their descent back to Heracles, but took their name from Bacchis, a younger ancestor. It is very doubtful, however, whether such pedigrees as this were very seriously put forward by those who claimed them; and it is certain that, almost along the whole line, they were unsupported by evidence.² We have the authority of Pollux (viii. 111) for stating that the Athenian γένεα, of which there were thirty in each φάραξ, were organized without any exclusive regard being had to blood-relationship; they were constantly receiving accessions from without; and the public written registers of births, adoptions and the like do not appear to have been preserved with such care as would have made it possible to verify a pedigree for any considerable portion even of the strictly historical period.³

The great antiquity of the early Roman (patrician) *gentes*, who universally traced themselves back to illustrious ancestors, is indisputable; and the rigid exclusiveness with which each preserved its *hereditates gentiliciae* or *sacra gentilicia* is sufficiently illustrated by the fact that towards the close of the republic there were not more than fifty patrician families (Dion. Halic. i. 85). Yet even in these it is obvious that, owing to the frequency of resort to the well-recognized practice of adoption, while there was every guarantee for the historical identity of the family, there was none (documents apart) for the personal genealogy of the individual. There is no evidence that sufficient records of

¹ On the subject generally see articles "Gens" and "Gens." by A. H. Greenidge, in *Smith's Dictionary of Greek and Roman Antiquities* (3rd ed., 1890), where the chief authorities are given.

² The fondness of Euripides for genealogies is ridiculed by Aristophanes (*Acharnians*, 47).

³ All the earlier Greek historians appear to have constructed their narratives on assumed genealogical bases. The four books of Hecataeus of Miletus dealt respectively with the traditions about Deucalion, about Heracles and the Heraclidae, about the early settlements in Peloponnesus, and about those in Asia Minor; he further made a pedigree for himself, in which his sixteenth ancestor was a god. The works of Hellanicus of Lesbos bore titles (*Devaldiuria* and the like) which sufficiently explain their nature; his disciple, Damastes of Sigeum, was the author of genealogical histories of Trojan heroes; Apollodorus of Athens made use of three books of *Genealogiæ* by Acusilaus of Argos; Pherecydes of Leros also wrote *genealogiæ*. See J. A. F. Töpffer, *Attische Genealogie* (1849); also J. H. Schubert, *Quæritæ genealogicæ historicæ* (1832); G. Marchschafel, *De genealogiâ Graecorum potest.* (1840).

pedigree were kept during the earlier centuries of the Roman commonwealth, although the leading houses drew up genealogical tables, and their family pedigree was painted on the walls of the entrance hall. In later times, it is true, even plebeian families began to establish a prescriptive right (known as the *jus imaginis*) to preserve in small wooden shrines in their halls the busts (or rather, wax portrait masks fastened on to busts) of those of their members who had attained to curule office, and to exhibit these in public on appropriate occasions. Under these *imagines majorem*⁴ it became usual to inscribe on the wall their respective *lituli*, the relationship of each to each being indicated by means of connecting lines; and thus arose the *stemmata gentilicia*, which at a later time began to be copied into family records. In the case of plebeian families (whose *stemmata* in no case went farther back than 366 B.C.) these written genealogies were probably trustworthy enough; but in the case of patricians who went back to Aeneas,⁵ so much cannot, it is obvious, be said; and from a comparatively early period it was clearly recognized that such records lent themselves too readily to the devices of the falsifier and the forger to deserve confidence or reverence (Pliny, *H. N.* xxxv. 2; Juv. viii. 1).

Thus, parvenus were known to place the busts of fictitious ancestors in the shrines and to engage needy literary men to trace back their descent even to Aeneas himself.

The many and great social changes which marked the closing centuries of the Western empire almost invariably militated with great strength against the maintenance of an aristocracy of birth; and from the time of Constantine the dignity of patrician ceased to be hereditary.⁶

3. *Modern*.—Two forces have combined to give genealogy its importance during the period of modern history: the laws of inheritance, particularly those which govern the descent of real estate, and the desire to assert the privileges of a hereditary aristocracy. But it is long before genealogies are found in the possession of private families. The succession of kings and princes are in the chronicle book; the line of the founders and patrons of abbeys are recorded by the monks with curious embellishment of legend. But the famous suit of Scrope against Grosvenor will illustrate the late appearance of private genealogies in England. In 1385 Sir Richard Scrope, lord of Bolton, displaying his banner in the host that invaded Scotland, found that his arms of a golden bend in a blue field were borne by a knight of the Chester palatinate, one Sir Robert Grosvenor. He carried the dispute to a court of chivalry, whose decision in his favour was confirmed on appeal to the king. Grosvenor asserted that he derived his right from an ancestor, Sir Gilbert Grosvenor, who had come over with the Conqueror, while an intervening claimant, a Cornish squire named Thomas Carminow, boasted that his own ancestors had borne the like arms since the days of King Arthur's Round Table. It is remarkable that in support of the false statements made by the claimants no written genealogy is produced. The evidence of tombs and monuments and the reports of ancient men are advanced, but no pedigree is exhibited in a case which hangs upon genealogy. It is possible that the art of pedigree-making had its first impulse in England from the many genealogies constructed to make men familiar with the claims of Edward III. to the crown of France, a second crop of such royal pedigrees being raised in later generations during the contests of York and Lancaster. But it is not until after the close of the middle ages that genealogies multiply in men's houses and are collected into volumes. The medieval baron, knight or squire, although proud of the nobility of his race, was content to let it rest upon legend handed down the

⁴ The chief authority on this subject is Polybius (vi. 53); see also T. Mommsen, *Römische Staatsrecht*, i. (1887), p. 442.

⁵ At the funeral of Drusus the images of Aeneas, of the Alban kings, of Romulus, of the Sabine nobles, of Attus Clausus, and of "the rest of the Claudians" were exhibited (*Tac. Ann.* iv. 9).

⁶ The Roman *stemmata* had, as will be seen afterwards, great interest for the older modern genealogists. Reference may be made to J. Glandorp's *Descriptio gentis Antoniae* (1557); to the *Descriptio gentis Julianae* (1576) of the same author; and to J. Hübnér's *Genealogische Tabellen*. See also G. A. Ruperti's *Tabulae genealogicae novæ stemmata nobilitatis gent. Rom.* (1794).

generations. The exact line of his descent was sought only when it was demanded for a plea in the king's courts to support his title to his lands.

From the first the work of the genealogist in England had that taint of inaccuracy tempered with forgery from which it has not yet been cleansed. The medieval kings, like the Welsh gentry of later ages, traced their lines to the household of Eden garden, while lesser men, even as early as the 14th century, eagerly asserted their descent from a companion of the Conqueror. Yet beside these false imaginations we find the law courts, whose business was often a clash of pedigrees, dealing with genealogies centuries long which, constructed as it would seem from worthy evidences, will often bear the test of modern criticism.

Genealogies in great plenty are found in manuscripts and printed volumes from the 16th century onward. Remarkable among these are the descents recorded in the Visitation Books of the heralds, who, armed with commissions from the crown, the first of which was issued in 20 Hen. VIII., perambulated the English counties, viewing arms and registering pedigrees. The notes in their register books range from the simple registration of a man's name and arms to entries of pedigrees many generations long. To the heralds these visitations were rare opportunities of obtaining fees from the visited, and the value of the pedigrees registered is notably unequal. Although it has always been the boast of the College of Arms that Visitation records may be produced as evidence in the law courts, few of these officially recorded genealogies are wholly trustworthy. Many of the officers of arms who recorded them were, even by the testimony of their comrades, of indifferent character, and even when the visiting herald was an honourable man and an industrious he had little time to spare for the investigation of any single genealogy. Deeds and evidences in private hands may have been hastily examined in some instances—indeed, a herald's summons invites their production—and monuments were often viewed in the churches, but for the most part men's memories and the hearsay of the country-side made the backbone of the pedigree. The further the pedigree is carried beyond the memory of living men the less trustworthy does it become. The principal visitations took place in the reigns of Elizabeth, James I. and Charles II. No commission has been issued since the accession of William and Mary, but from that time onwards large numbers of genealogies have been recorded in the registers of the College of Arms, the modern ones being compiled with a care which contrasts remarkably with the unsupported statements of the Tudor heralds.

Outside the doors of the College of Arms genealogy has now been for some centuries a favourite study of antiquaries, whose researches have been of the utmost value to the historian, the topographer and the biographer. County histories, following the example of Dugdale's Warwickshire folios, have given much space to the elucidation of genealogies and to the amassing of material from which they may be constructed. Dugdale's great work on the English baronage heads another host of works occupied with the genealogy of English noble families, and the second edition of "G.E.C.'s" *Complete Peerage* shows the mighty advance of the modern critical spirit. Nevertheless, the 20th century has not yet seen the abandoning of all the genealogical fables nourished by the Elizabethan pedigree-mongers, and the ancestry of many noble houses as recorded in popular works of reference is still derived from mythical forefathers. Thus the dukes of Norfolk, who, by their office of earl marshal are patrons of the heralds, are provided with a 10th-century Hereward for an ancestor; the dukes of Bedford, descendants of a 15th-century burgess of Weymouth, are traced to the knightly house of Russell of Kingston Russell, and the dukes of Westminster to the mythical Gilbert le Grosvenor who "came over in the train of the Conqueror."

Genealogical research has, however, made great advance during the last generation. The critical spirit shown in such works as Round's *Studies in Peerage and Family History* (1901) has assailed with effective ridicule the methods of dishonest pedigree-

makers. Much raw material of genealogy has been made available for all by the publication of parish registers, marriage-licence allegations, monumental inscriptions and the like, and above all by the mass of evidences contained in the volumes issued by the Public Record Office.

Within a small space it is impossible to set forth in detail the methods by which an English genealogy may be traced. But those who are setting out upon the task may be warned at the outset to avoid guesswork based upon the possession of a surname which may be shared by a dozen families between whom is no tie of kinship. A man whose family name is Howard may be presumed to descend from an ancestor for whom Howard was a personal name: it may not be presumed that this ancestor was he in whom the dukes of Norfolk have their origin. A genealogy should not be allowed to stray from facts which can be supported by evidence. A man may know that his grandfather was John Stiles who died in 1850 at the age of fifty-five. It does not follow that this John is identical with the John Stiles who is found as baptized in 1795 at Blackacre, the son of William Stiles. But if John the grandfather names in his letters a sister named Isabel Nokes, while the will of William Stiles gives legacies to his son and daughter John Stiles and Isabel Nokes, we may agree that reasonable proof has been given of the added generation. A new pedigree should begin with the carefully tested statements of living members of a family. The next step should be to collate such family records as bible entries, letters and diaries, and inscriptions on mourning rings, with monumental inscriptions of acknowledged members of the family. From such beginnings the genealogist will continue his search through the registers of parishes with which the family has been connected; wills and administrations registered in the various probate courts form, with parish registers, the backbone of most middle-class family histories. Court rolls of manors in which members of the family were tenants give, when existing and accessible, proofs which may carry back a line, however obscure, through many descents. When these have been exhausted the records of legal proceedings, and notably those of the court of chancery, may be searched. Few English households have been able in the past to avoid an appeal to the chancery court, and the bill and answer of a chancery plaintiff and defendant will often tell the story of a family quarrel in which a score of kinsfolk are involved, and the pleadings may contain the material for a family tree of many branching generations. Coram Rege and De Banco rolls may even, in the course of a dispute over a knight's fee or a manor carry a pedigree to the Conquest of England, although such good fortune can hardly be expected by the searcher out of an undistinguished line. In proving a genealogy it must be remembered that in the descent of an estate in land must be sought the best evidence for a pedigree.

At the present time the study of genealogy grows rapidly in English estimation. It is no less popular in America, where societies and private persons have of late years published a vast number of genealogies, many of which combine the results of laborious research in American records with extravagant and unfounded claims concerning the European origin of the families dealt with. A family with the surname of Cuthbert has been known to hail St Cuthbert of Lindisfarne as its progenitor, and one surnamed Eberhardt has incorporated in its pedigree such German princes of old times as were found to have Eberhardt for a Christian name.

Genealogy in modern France has, with a few honourable exceptions, fallen into the hands of the popular pedigree-makers, whose concern is to gratify the vanity of their employers. Italy likewise has not yet shaken off the influence of those venal genealogists who, three hundred years ago, sold pedigrees cheaply to all comers. But much laborious genealogical inquiry had been made in Germany since the days of Hübner, and even in Russia there has been some attempt to apply modern standards of criticism to the chronicles of the swarming descendants of the blood of Rurik.

In no way is the gap made by the Dark Ages between ancient and modern history more marked than by the fact that so

European family makes a serious claim to bridge it with its genealogy. The unsupported claim of the Roman house of Massimo to a descent from Fabius Maximus is respectable beside such legends as that which made Lévis-Mirepoix head of the priestly tribe of Levi, but even the boast of such remote ancestry has now become rare. The ancient sovereign houses of Europe are, for the most part, content to attach themselves to some ancestor who, when the mist that followed the fall of the Western empire begins to lift, is seen rallying with his sword some group of spearmen.

AUTHORITIES.—Genealogical works have been published in such abundance that the bibliographies of the subject are already substantial volumes. Amongst the earlier books from the press may be noted Benvenuto de San Giorgio's *Montisferri marchionum et principum regie prepagium successionum series* (1515); Pinguetius's *Arbor gentilitiae Sabaudiae Saxonique domus* (1521); Gebwiler's *Epitome regii ac vetustissimi ortus Caroli V. et Ferdinandi I. omniumque archiducum Austriae et comitum Habsburgensium* (1527); Meyer's work on the counts of Flanders (1531), and Du Boulay's genealogies of the dukes of Lorraine (1547). Later in the same century Reineck of Helmstadt put forth many works having a wider genealogical scope, and we may cite Henninges's *Genealogie Saxonice* (1587) and *Theotrum genealogicum* (1598), and Reusner's *Opus genealogicum catholicum* (1589-1592). For the politically inconvenient falseness of François de Rosières's *Stemmata Lotharingiae ac Barri ducum* (1580), wherein the dukes of Lorraine were deduced from the line of Charlemagne, the author was sent to the Bastille by the parlement of Paris and his book suppressed.

The 17th century saw the production in England of Dugdale's great *Baronage* (1675-1676), a work which still holds a respectable place by reason of its citation of authorities, and of Sandford's history of the royal house. In the same century André Duchesne, the historian of the Montmorency, Pierre d'Hozier, the chronicler of the house of La Rochefoucauld, Ritterhusius, Imhoff, Spener, Lotzweier and many others contribute to the body of continental genealogy. Pierre de Guibours, known as Père Anselme de Ste Marie, published in 1674 the first edition of his magnificent *Histoire généalogique de la maison royale de France, des pairs, grands officiers de la couronne et de la maison du roy et des anciens barons du royaume*. Of this encyclopaedic work a third and complete edition appeared in 1726-1733. A modern edition under the editorship of M. Potier de Courcy began to be issued in 1873, but remains incomplete. Among 18th-century work Johann Hübnér's *Bibliotheca genealogica* (1729) and *Genealogische Tabellen* (1725-1733), with Lenzen's commentary on the latter work (c. 1756), may be signalled, with Gatterer's *Handbuch der Genealogie* (1761) and his *Abriss der Genealogie* (1788), the latter an early manual on the science of genealogy. Herpolt's *Genealogia diplomatica augustae gentis Habsburgicae* (1737) is the imperial genealogy compiled by the emperor's own historiographer.

Modern pepages in England may be said to date from that of Arthur Collins, whose one-volume first edition was published in 1702. The fifth edition appeared in 1778, in eight volumes, to be republished in 1812 by Sir Egerton Brydges, the "Baptist Hatton" of Disraeli's novel, who corrected many legendary pedigrees, besides inserting his own forged descent from a common ancestor with the dukes of Chandos. From this work and from the Irish peerage of Lodge (as re-edited by Archdall) most of the later pepages have quarried their material. With these may be named the baronetages of Wotton and Betham. Of modern popular pepages and baronetages that of Burke has been published since 1822 in many editions and now appears yearly. Most important for the historian are the *Complete Peerage* of G. E. C[ockayne] (2nd ed., 1910), and the *Complete Baronetage* of the same author. The *Peerage of Scotland* (1766) of Sir Robert Douglas of Glenberrie came to a second edition in 1813, edited by J. P. Wood, and the whole work has been revised and re-edited by Sir James Balfour Paul (1904, &c.). Of the popular manuals of English untitled families, Burke's *Genealogical and Heraldic Dictionary of the Commoners* (1833-1838) is now brought up to date from time to time and reissued as the *Landed Gentry*.

Lists of pedigrees in English printed works are supplied by Marshall's *Genealogist's Guide* (1903), while pedigrees in the manuscript collections of the British Museum are indexed in the list of R. Sims (1849). Valuable genealogical material will be found in such periodicals as the *Genealogist*, the *Herald and Genealogist*, the *Topographer and Genealogist*, *Collectanea topographica et genealogica*, *Miscellanea genealogica et heraldica* and the *Ancient*. In Germany the *Deutscher Herald* is the organ of the Berlin Heraldic and Genealogical Society. The *Nederlandsche Leeuw* is a similar publication in the Low Countries.

Modern criticism of the older genealogical methods will be found in J. H. Round's *Peerage and Pedigree*, 2 vols. (London, 1910), and in other volumes by the same author. The Harleian Society has published many volumes of the Herald's Visitations; and the British Record Society's publications, supplying a key to a vast mass of wills, Chancery suits and marriage licences, are of still greater importance. The *History of the Counties of England*

includes genealogies of the ancient English county families still among the land-owning classes. English pedigrees of the age before the Conquest are collected in W. G. Searle's *Anglo-Saxon Bishops, Kings and Nobles* (1899).

Genealogical dictionaries of noble French families include Victor de Saint Allais's *Nobiliaire universel* (21 vols., 1872-1877) and Aubert de la Chenaye-Desbois's *Dictionnaire de la noblesse* (15 vols., 1863-1876). A sumptuous work on the genealogy and heraldry of the ancient duchy of Savoy by Count Amédée de Foras began to appear in 1863. Spain has Lopez de Haro's *Nobiliaria genealogico de los reyes y titulos de España*. Italy has the *Teatro araldico* of Tettoni and Saladini (1841-1848), Litté's *Famiglie celebri* and an *Annuario della nobiltà*. Such annuals are now published more or less intermittently in many European countries. Finland has a *Ridderskap och Adels Kalender*, Belgium the *Annuaire de la noblesse*, the Dutch Netherlands an *Adelsboek*, Denmark the *Adels-Carbog* and Russia the *Annuaire* of Ermerin. But chief of all such publications is the ancient *Almanach de Götta*, containing the modern kinship of royal and princely houses, and now accompanied by volumes dealing with the houses of German and Austrian counts and barons, and with houses enrolled in modern times by patent. A useful modern reference book for students of history is Stokvis's *Manuel d'histoire et de généalogie de tous les états du globe* (1888-1893). The best manual for the English genealogist is Walter Rye's *Records and Record Searching* (1897), while an ill-arranged but valuable bibliography of English and foreign works on the subject is that of George Catfield (1892). (O. B.A.)

GENELLI, GIOVANNI BUONAVENTURA (1798-1868), German painter, was born at Berlin on the 28th of September 1798. He was the son of Janus Genelli, a painter whose landscapes are still preserved in the Schloss at Berlin, and grandson to Joseph Genelli, a Roman embroiderer employed to found a school of gobelins by Frederick the Great. Buonaventura Genelli first took lessons from his father and then became a student of the Berlin academy. After serving his time in the guards he went with a stipend to Rome, where he lived ten years, a friend and assistant to Koch the landscape painter, a colleague of the sculptor Ernst Hähnel (1811-1891), Reinhart, Overbeck and Führich, all of whom made a name in art. In 1830 he was commissioned by Dr Härtel to adorn a villa at Leipzig with frescoes, but quarrelling with this patron he withdrew to Munich, where he earned a scanty livelihood at first, though he succeeded at last in acquiring repute as an illustrative and figure draughtsman. In 1859 he was appointed a professor at Weimar, where he died on the 13th of November 1868. Genelli painted few pictures, and it is very rare to find his canvases in public galleries, but there are six of his compositions in oil in the Schack collection at Munich. These and numerous water-colours, as well as designs for engravings and lithographs, reveal an artist of considerable power whose ideal was the antique, but who was also fascinated by the works of Michelangelo. Though a German by birth, his spirit was unlike that of Overbeck or Führich, whose art was reminiscent of the old masters of their own country. He seemed to hark back to the land of his fathers and endeavour to revive the traditions of the Italian Renaissance. Subtle in thought and powerfully conceived, his compositions are usually mythological, but full of matter, energetic and fiery in execution, and marked almost invariably by daring effects of foreshortening. Impeded by straitened means, the artist seems frequently to have drawn from imagination rather than from life, and much of his anatomy of muscle is in consequence conventional and false. But none the less Genelli merits his reputation as a bold and imaginative artist, and his name deserves to be remembered beyond the narrow limits of the early schools of Munich and Weimar.

GENERAL (Lat. *generalis*, of or relating to a *genus*, kind or class), a term which, from its pointing to all or most of the members of a class, the whole of an area, &c., as opposed to "particular" or to "local," is hence used in various shades of meaning, for that which is prevalent, usual, widespread or miscellaneous, indefinite, vague. It has been added to the titles of various officials, military officers and others; thus the head of a religious order is the "superior-general," more usually the "general," and we find the same combination in such offices as that of "accountant-general," "postmaster-general," "attorney" or "solicitor-general," and many others, the additional word implying that the official in question is of superior rank, as having a wider

authority or sphere of activity. This is the use that accounts for the application of the term, as a substantive, to a military officer of superior rank, a "general officer," or "general," who commands or administers bodies of troops larger than a regiment, or consisting of more than one arm of the service (see also OFFICERS). It was towards the end of the 16th century that the word began to be used in its present sense as a noun, and in the armies of the time the "general" was commander-in-chief, the "lieutenant-general" commander of the horse and second in command of the army, and the "major-general" (strictly "sergeant-major-general") commander of the foot and chief of the staff. Field marshals, who have now the highest rank, were formerly subordinate to the general officers. These titles—general, lieutenant-general and major-general—are still applied in most armies to the first, second and third grades of general officer, and in the French service until 1870 the chief of the staff of the army bore the title of major-general. In the German and Russian services the three grades are qualified by the addition of the words "of cavalry," "of infantry" and "of artillery." The French service possesses only two grades, "general of brigade" and "general of division." The Austrian service has two ranks of general officers peculiar to itself, "lieutenant field marshal," equivalent to lieutenant-general, and *Feldzeugmeister* (master of the ordnance), equivalent to the German general of infantry or artillery. There is also the rank of "general of cavalry." The Spanish army still retains the old term "captain-general." In the German service *General Oberst* (colonel-general) and *General Feldzeugmeister* (master-general of ordnance) are ranks intermediate between that of full general and that of general field marshal. It may be noted that during the 17th century "general" was not confined to a commanding officer of an army, and was also equivalent to "admiral"; thus when under the Protectorate the office of lord high admiral was put into commission, the three first commissioners, Blake, Edward Popham and Richard Deane, were styled "generals at sea."

GENERATION (from Lat. *generare*, to beget, procreate; *genus*, stock, race), the act of procreation or begetting, hence any one of the various methods by which plants, animals or substances are produced. As applied to the result of procreation, "generation" is used of the offspring of the same parents, taken as one degree in descent from a common ancestor, or, widely, of the body of living persons born at or near the same time; thus the word is also used of the age or period of a generation, usually taken as about thirty years, or three generations to a century. As a term in biology or physiology, generation is synonymous with the Gr. *βιολογία* and the Ger. *Zzeugung*, and may comprehend the whole history of the first origin and continued reproduction of living bodies, whether plants or animals; but it is frequently restricted to the sexual reproduction of animals. The subject may be divided into the following branches, viz.: (1) the first origin of life and living beings, (2) non-sexual or agamic reproduction, and (3) gamic or sexual reproduction. For the first two of these topics see ABIOTIC GENESIS, BIOTIC GENESIS and BIOLOGY; for the third and more extensive division, including (1) the formation and fecundation of the ovum, and (2) the development of the embryo in different animals, see REPRODUCTION and EMBRYOLOGY.

GENESIS (Gr. *γένεσις*, becoming; the term being used in English as a synonym for origin or process of coming into being), the name of the first book in the Bible, which derives its title from the Septuagint rendering of ch. ii. 4. It is the first of the five books (the Pentateuch), or, with the inclusion of Joshua, of the six (the Hexateuch), which cover the history of the Hebrews to their occupation of Canaan. The "genesis" of Hebrew history begins with records of antediluvian times: the creation of the world, of the first pair of human beings, and the origin of sin (i.-iii.), the civilization and moral degeneration of mankind, the history of man to the time of Noah (iv.-vi. 8), the flood (vi. 9-ix.), the confusion of languages and the divisions of the human race (x.-xi.). Turning next to the descendants of Shem, the book deals with Abraham (xii.-xxv. 18), Isaac and Jacob (xxv. 19-xxxv.), the "fathers" of the tribes of Israel, and concludes with

the personal history of Joseph, and the descent of his father Jacob (or Israel) and his brethren into the land of Egypt (xxxvii.-l.). The book of Genesis, as a whole, is closely connected with the subsequent oppression of the sons of Israel, the revelation of Yahweh the God of their fathers (Ex. iii. 6, 15 seq., vi. 2-8), the "exodus" of the Israelites to the land promised to their fathers (Ex. xiii. 5; Deut. i. 8, xxvi. 3 seq., xxxiv. 4) and its conquest (Josh. i. 6, xxiv.); cf. also the summaries Neh. ix. 7 seq., Pa. cv. 6 seq.

The words, "these are the generations of the heavens and of the earth when they were created" (ii. 4), introduce an account of the creation of the world, which, however, is preceded by a *Amoritic*, relatively later and less primitive record (i. 1-ii. 3). The differences between the two accounts lie partly in the style and partly in the form and contents of the narratives. i. 1-ii. 3 is marked by stereotyped formulae ("and God [Elohim] said . . . and it was so . . . and God saw that it was good, and there was evening and there was morning," &c.); it is precise and detailed, whereas ii. 4b-iii. is less systematic, fresher and more anthropomorphic. The former is cosmic, the latter is local. It is the latter which mentions the mysterious garden and the wonderful trees which Yahweh planted, and depicts Yahweh conversing with man and walking in the garden in the cool of the evening. The former, on the other hand, has an enlightened conception of Elohim; the Deity, though grand, is a lifeless figure; several antique ideas are nevertheless preserved. The account of the creation, too, is different; for example, in chap. i. man and woman are created together, whereas in ii. man is at first alone. The naiveness of the story of the creation of woman is in line with the interest which this more popular source takes in the origin or existence of phenomena, customs and contemporary beliefs (the garden, the naming of animals, &c.). The primitive record is continued in the story of Cain and Abel (iv.), where the old-time problem of Cain's wife and the reference to other human beings (iv. 14 seq.) gave rise in pre-critical days to the theory of pre-Adamites, as though Adam and Eve were not the only inhabitants of the earth. But all the indications go to show that there were at least two distinct popular narratives, one of which ignores the flood. Cain the murderer, doomed to be a wanderer, now becomes the builder of a city, and his descendants introduce various arts (iv. 16b-24).¹ (See the articles ABEL; ADAM; CAIN; COSMOGONY; ENOCH; EVE; LAMECH.) From the "generations" of the heavens and the earth (which one would have expected at the head of ch. i.) we pass to the "generations of Adam" (v. 1). The list of the "Sethites," with its characteristically stereotyped framework, has an older parallel in iv. 25 seq. (with the origin of the worship of Yahweh contrast Ex. vi. 2, seq.), and a fragment from the same source is found in v. 20.

After the birth of Noah the son of Lamech (v. 29, contrast iv. 19 seq.) comes the brief story of the demigods (vi. 1-4). It is no part of the account of the fall or of the flood (note verse 4 and Num. xiii. 33), least of all does it furnish grounds for the old view of the division of the human race into evil Cainites and God-fearing Sethites. The excerpt with its description of the fall of the angels is used to form a prelude to the wickedness of man and the avenging flood (vi. 5). Noah, the father of Ham, Shem and Japheth, appears as the hero in the Hebrew version of the flood (see DELUGE; NOAH). Duplicates (vi. 5-8, 9-13) and discrepancies (vi. 19 seq. contrasted with vii. 2; or vii. 11, viii. 14 contrasted with viii. 8, 10, 12) point to the use of two sources (harmonizing passages in vii. 3, 7-9). The later narrative, which begins with "the generations of Noah" (vi. 9-22; vii. 6, 11, 13-17, 18-21, 24; viii. 1-20, 30-5, 13, 14-19; ix. 1-17), is almost complete; note the superscription and the length of the flood (365 days; according to other notices the flood apparently lasted only 61 or 68 days). In the earlier source Noah collects seven pairs of clean animals, one of each kind; he sacrifices after leaving the ark, and Yahweh promises not to curse the ground or to smite living things again. But in the later, he takes only one pair, and subsequently Elohim blesses Noah and makes a covenant never again to destroy all flesh by a flood.² The covenant (characteristic of the latest narratives in Genesis) also prohibits the shedding of blood (cf. the story of Cain and Abel in the earlier source). Mankind is now made to descend from the three sons of Noah. The older story, however, continues with another step in the history of civilization, and to Noah is ascribed the cult of the vine, the abuse of which leads to the utterance of a curse upon Canaan and a blessing upon Shem and Japheth (ix. 20-27). The table of nations in x. ("the generations of the sons of Noah") preserves several signs of composite origin (contrast e.g. x. 7 with pr. 28 sq., Ludim v. 13 with v. 22, and the Canaanite families v. 16 with the dispersion "afterwards," v. 18, &c.); see CANAAN; GENEALOGY; NIMROD. The history of the primitive age concludes with the story of the tower

¹ The abrupt introduction of a small poem (iv. 23 seq.) was long ago regarded as due to the use of separate sources (so the Calvinist Isaac de la Peyrère, 1654).

² The divergences of detail, with corresponding stylistic variations, were recognized long ago (e.g. by Father Simon in 1682).

of Babel (xi. 1-9), which, starting from a popular etymology of Babel ("gate of God"), as though from Balbel ("confusion"), tells how Yahweh feared lest mankind should become too powerful (cf. iii. 22-24), and seeks to explain the origin of the numerous languages in use. It is independent of x., which already assumes a confusion of tongues (v. 2, 20, 31), the existence of Babel (v. 10), and gives a different account of the rise of the various races. This incident in the journey eastwards (xi. 2) is equally independent of the story of the Deluge and of Noah's family (see Wellhausen, *Prolegomena*, p. 316). The continuation of the chapter, "the generations of Shem" (xi. 10-27, see the Shemite genealogy in x. 21 sqq., and contrast the ages with vi. 3), is in the same stereotyped style as ch. v., and prepares the way for the history of the patriarchs.

The "generations of Terah" (xi. 27) lead to the introduction of the first great patriarch Abraham (g.v.).¹ There is a twofold account of his migration to Bethel with his nephew Lot; the more statistical form in xi. 31 sqq., xii. 4b, 5 belongs to the latest source. The statement that the Canaanite was then in the land (xii. 6, cf. xiii. 7) points to a time long after the Israelite conquest, when readers needed such a reminder (so Hobbes in his *Leviathan*, 1651). A famine forces him to descend into Egypt, where a story of Sarai (here at least 65 years of age; see xii. 4, xvii. 17) is one of three variants of a similar peculiar incident (cf. xx. 1-17, xxvi. 6-14). The passage is an insertion (xii. 10-xiii. 2; xii. 9, xiii. 3 seq. being harmonistic). The thread is resumed in the account of the separation of the patriarch and his nephew Lot, who divide the land between them. Abraham occupies Canaan, but moves south to Hebron, which, according to Josh. xiv. 15, was formerly known as Kirjath-Arba. Lot dwells in the basin of the Jordan, and his history is continued in the story of the destruction of Sodom and Gomorrah (xviii.-xix.; Hos. xi. 8, Deut. xxxix. 23 speak of Admah and Zeboim). Lot is saved and becomes the ancestor of the Moabites and Ammonites, who are thus closely related to the descendants of Abraham (note xix. 37, "unto this day"). The great war with Amraphel and Chedorlaomer—the defeat of a world-conquering army by 318 men—with the episode of Melchizedek, noteworthy for the reference to Jerusalem (xiv. 18, cf. Ps. lxxvii. 2), has nothing in common with the context (see ABRAHAM; MELCHIZEDEK). It treats as individuals the place-names Mamre and Eshcol (xiv. 13, cf. Num. xiii. 23 seq.), and by mentioning Dan (v. 14) anticipates the events in Josh. xix. 47, Judg. xviii. 20.² A cycle of narratives deals with the promise that the barren Sarai (Sarah) should bear a child whose descendants would inhabit the land of Canaan. The importance of the tradition for the history of Israel explains both the prominence given to it (cf. already xii. 7, xiii. 14-17) and their present complicated character (due to repeated revision). The older narratives comprise (a) the promise that Abraham shall have a son of his own flesh (xv.)—the account is composite;³ (b) the birth of Ishmael, Abraham's son by Hagar, their exile, and Yahweh's promise (xvi., with a separate framework in v. 10, 3, 15 seq.)—before the birth of Isaac; and (c) the promise of a son to Sarai (xviii. 1-15), now combined with the story of Lot and the overthrow of Sodom. The latest source (xvii.) is marked by the solemn covenant between Yahweh and Abraham, the revelation of God Almighty (El-Shaddai, cf. Ex. vi. 3), and the institution of circumcision (otherwise treated in Ex. iv. 26, Josh. v. 2 seq.). The more elevated character of this source as contrasted with xv. and xviii. is as striking as the difference of religious tone in the two accounts of the creation (above). Abraham now travels thence (xx. 1, Hebron, see xviii. 1), and his adventure in the land of Abimelech, king of Gerar (xx.), is a duplicate of xii. (above). It is continued in xii. 22-24, which has a close parallel in the life of Isaac (xvii. below). Isaac is born in accordance with the divine promise (xviii. 10 at Hebron); the scene is the south of Palestine. The story of the dismissal of Hagar and Ishmael, and the revelation (xii. 6-21) cannot be separated from xvi. 4-14, where v. 9 seq. are intended to harmonize the passages. Although about sixteen years intervene (see xvi. 16; xxi. 5, 8), Ishmael is a young child who has to be carried (xvi. 15), but the Hebrew text of xii. 14 (not, however, the Septuagint) endeavours to remove the discrepancy.⁴ "After these things" comes the offering of Isaac which implicitly annuls the sacrifice of the first-born, a not unfamiliar rite in Palestine as the denunciations prove (cf. Ezek. xvi. 20 seq., xx. 26; Mic. vi. 7; Is. lviii. 5), and thus marks an advance, e.g. upon the story of Jephthah's daughter (Judg. xi.). The story may be contrasted with the Phoenician account of the sacrifice by Cronos (to be identified with El) of his only son, which practically justified the horrid custom.

The detailed account of the purchase of the cave of Machpelah (contrast the brevity of xxxiii. 19) is of great importance for the traditions of the patriarchs, and, like the reference to the death of Sarah and Abraham, belongs to the latest source (xxiii., xxv. 7-11a).⁵ The idyllic picture of life in xxiv. presupposes that Isaac is sole heir (v. 36); since this is first stated in xxv. 5, it is probable that xxv. 5, 11b (and perhaps v. 6, 18) are out of place. It is noteworthy that the district is Abraham's native place (xxiv. 4, 7, 10; contrast the Babylonian home specified in xi. 28, 31; xv. 7). In xxv. 1 sqq. Abraham takes as wife (but concubine, 1 Chron. i. 32 seq.) Keturah ("incense") and becomes the father of various Arab tribes, e.g. Sheba and Dedan (grandsons of Cush in x. 7).

After "the generations of Ishmael" (xxv. 12 sqq.) the narrative turns to "the generations of Isaac" (xxv. 19 sqq.). The story of the events at the court of Abimelech (xxvi.) finds a parallel in the now disjointed xx., xxi. 22-34; note the new explanation of Beer-sheba, the reference in xxvi. 1 to the parallel story in xii., the absence of allusion to xx., and the apparent editorial references to xxi. in v. 15, 18. On the whole, the story of Isaac's wife at Gerar is briefer and not so elevated as that of Sarah, but the parallel to xii. 22-34 is more detailed. The birth of Esau and Jacob (xxv. 21-34) introduces the story of Jacob's craft when Isaac is on the point of death (xxvii.). Jacob flees to Laban at Haran to escape Esau's hatred (xxvii. 41-45); but, according to the latest source (P), he is charged by Isaac to go to Paddan-Aram, and take a wife there, and his father transfers to him the blessing of Abraham (xxvii. 46-xxviii. 9). On his way to Haran he stops at Bethel (formerly Luz, according to Judg. i. 22-26), where a vision prompts him to accept the God of the place should he return in peace to his father's home (xxviii. 10-22). He passes to the land of "the children of the east" (xxix. 1), and the scenes which follow are scarcely situated at Haran, the famous and ancient seat of the worship of the moon-god, but in the desert. Here he resides fifteen years or more, and by the daughters of Laban and their handmaidens becomes the "father" of the tribes of Israel. There are numerous traces of composition from different sources, but a satisfactory analysis is impossible.⁶ The flight of Jacob and his household (from Paddan-Aram, xxiii. 18 P) leads over "the River" (v. 21, i.e. the Euphrates; though the seven days' journey of this concourse of men and cattle suggests that he came to Gilgal, not from Haran (300 m. distant), but from some nearer locality. This is to be taken with the evidence against Haran already noticed, with the use of the term "children of the east" (xxix. 1; cf. Jer. xlix. 28; Ezek. xxv. 4, 10), and with the details of Laban's kindred (xxii. 20-24).⁷ The arrival at Mahanaim ("two ? camps") gives rise to specific allusions to the meaning of the name (xxiii. 1 seq., 7-12, 13-21; cf. also the plays upon Jabobk, Israel and Peniel in xxxii. 22-32. He meets Esau (xxiii. 3-21, xxxiii. 1-16, another reference to Peniel, "face of God," in v. 10), but they part. Jacob now comes to Shechem "in peace" (cf. the phrase in xxviii. 21), where he buys land and erects an altar (xxxiii. 18-20, cf. Abraham in xii. 6 seq.). There is a remarkable story of the violation of his daughter Dinah by Shechem, the son of Hamor of the Hivites (xxxiv.). It has been heavily revised; note the alternating prominence of Hamor and Shechem, the condemnation of Simcon and Levi for their vengeance (cf. the curse in xlix. 5-7), the destruction of the city Shechem by all the sons of Jacob, and the survival of the Hamorites as a family centuries later (xxxii. 19, Judg. ix. 28). The narrative continues with Jacob's journey to Bethel, the death of Deborah (who accompanied Rebekah to Palestine 140 years previously, see xxiv. 59, and the latest source in xxv. 20, xxv. 28), the death of Rachel (xxxv. 16-20, contrast xxxvii. 10), and ceases abruptly in the middle of a sentence (xxxv. 22, but see xlix. 3-4). The latest source (xxxv. 9-13, 15, 22b-29) gives another account of the origin of the names Israel (cf. xxxii. 28) and Bethel (cf. xxxviii. 19), and the genealogy wrongly includes Benjamin among the sons born outside Palestine (v. 24-26). In narrating Jacob's leisurely return to Isaac at Hebron, the writers quite ignore the many years which have elapsed since he left his father at the point of death in Beersheba (xxvii. 1, 2, 7, 10, 41).

"The generations of Esau, the same is Edom," provide much valuable material for the study of Israel's rival (xxxvi.). The chapter gives yet another account of the separation of Jacob and Esau (with v. 6-8, cf. Abraham and Lot, xiii. 5 seq.), and describes the latter's withdrawal to Seir (cf. already xxxii. 3; xxxiii. 14, 16). It includes lists of diverse origin (e.g. v. 2-5, contrast xxvi. 34, xxviii. 9); various "dukes" (R.V. marg. "chiefs"), or rather

¹ As early as 1685 Jean le Clerc observed that Ur of the Chaldees (*Chasdim*) in xi. 28 anticipates *Chesed* in xii. 22, and implied some knowledge of the land of the Chaldaeans (cf. Ezek. i. 3, xi. 24).

² The Catholic priest Andrew du Maes (1750) already pointed to the names Hebron and Dan as signs of post-Mosaic date.

³ Note the repetitions in v. 2 and 3; Abraham's faith, v. 4-6, and his request, v. 8; contrast the time of day, v. 5 and v. 12, and the dates, v. 13 and v. 16. In v. 12-15 there is a reference to the bondage in Egypt.

⁴ These and other chronological embarrassments, now recognized as due to the framework of the post-exilic writer (P), have long been observed—by Spinosa, 1671.

⁵ Points of resemblance in xxiii. with Babylonian usage have often been exaggerated; comparison "shows noteworthy differences" (T. G. Pinches, *The Old Testament*, p. 238); see Carpenter and Harford-Battersby, *Hexateuch*, i. 64, Driver, *Gen.* p. 230, and *Addenda*.

⁶ Note, e.g., the sudden introduction of xxix. 15, the curious position of v. 24 (due to P), the double play upon the names Zebulun and Joseph, xxx. 20, 23 seq., the internal intricacies in the agreement, *ib.* v. 31-43; the difficulties in the reference to the latter in xxxi. 6 sqq. (especially v. 10).

⁷ See Ed. Meyer (and B. Luther), *Die Israeliten und ihre Nachbarstämme* (1906), pp. 238 sqq.; also the shrewd remarks of C. T. Beke, *Origines biblicae* (1834), pp. 123 sqq.

"thousands" or "clans"; and also the "sons" of Seir the Horite, i.e. Horite clans (vv. 20 seq. and vv. 29 seq.). A summary of Edomite kings is ascribed to the period before the Israelite monarchy (vv. 31-39), and the record concludes with the "dukes" of Esau, the father of the Edomites (vv. 40-43, cf. names in vv. 10-14, 15-19).¹

Finally, Genesis turns from the patriarchs to the "generations of Jacob" (xxxvii. 2), and we have stories of the "sons," the ancestors of the tribes. (In xxxiv. the incidents which primarily concerned Simeon and Levi alone have, however, been adjusted to the general history of Jacob and his family.) The first place is given to Joseph (xxxvii.), although xxxvii. crowds the early history of the family of Judah into the twenty-two years between xxxvii. 2 and Jacob's descent into Egypt (see xli. 46, 47; xlv. 6).² In xxxvii., xxxix. seq. we have an admirable specimen of writing quite distinct in stamp from the patriarchal stories. The romance which has here been utilized shows an acquaintance with Egypt; the narratives are discursive, not laconic, everything is more detailed, and more under the influence of literary art. The Reuben and Simeon which appear in it are not the characters which we meet in xxxiv., xxxv. 22, or in the poem xlix. 3-7; and the tribes of Ephraim and Manasseh do not scruple to claim ancestry from Joseph and the daughter of an Egyptian priest at the seat of the worship of the sun-god (xli. 45). The narratives are composite. Joseph incurs the ill-will of his brethren because of Israel's partiality or because of his significant dreams. He is at Shechem or at Dothan; and when the brothers seek to slay him, Judah proposes that he should be sold to Ishmaelites, or Reuben suggests that he should be cast into a pit, where Midianites find and kidnap him (xxxvii., cf. xl. 15). The latter sell him to the eunuch Potiphar, but he appears in the service of a married householder (xxxix., the second clause of v. 1 harmonizes). Among other signs of dual origin are the alternation of "Jacob" and "Israel" and the prominence of Judah (xliii. 5; 8; xlv. 14, 18) or of Reuben (xlii. 22, 37). The money is found in a "bag" as the brothers encamp (xlii. 27, 28; xliii. 1), or in a "sack" when they reach home (xlii. 8-26, 29-35, 28b, 36 seq.). When Israel and his family descend into Egypt, the latest source gives a detailed list which agrees in the main with the Israelite subdivisions (xli. 6-27, cf. Num. xxvii. and 1 Chron. ii.-viii.). The families dwell in the land of Goshen, east of the Delta, "for every shepherd is an abomination unto the Egyptians" (xlv. 10; xlv. 28-34; xlvii. 1-6); or they are in the "land of Rameses" (xlvii. 11, and Septuagint in xvi. 28);³ Joseph's policy during the famine is next described (xlvii. 13-26), although it would have been more in place after xli. (see *ib.* 34). There are several difficulties in Jacob's blessing of the sons of Joseph (xlviii.).⁴ The blessing in xlix. is a collection of poetical passages praising or blaming the various tribes, and must certainly date after the Israelite settlement in Palestine; see further the articles on the tribes. Jacob's dying instructions to Joseph (xlvii. 29-31) are continued in l. 1 seq., his charge to his sons (xlix. 28 seq., P) in l. 12 seq. It is significant that Jacob's body is taken to Palestine, but the brethren return to Egypt; in spite of a possible allusion to the famine in v. 21; the late chronological scheme would imply that it had long ceased (see xlv. 6, xviii. 28). The book closes with the death of Joseph about fifty years later, after the birth of the children of Machir, who himself was a contemporary of Moses forty years after the Exodus (Num. xxxii. 39-41). Joseph's body is embalmed, but it is not until the concluding chapter of the book of Joshua (xxiv. 32) that his bones find their last resting-place.

Only on the assumption that the book of Genesis is a composite work is it possible to explain the duplication of events, the varying use of the divine names *Yahweh* and *Elohim*, the linguistic and stylistic differences, the internal intricacies of the subject matter, and the differing standpoints as regards tradition, chronology, morals and religion.⁵ The cumulative effect of the whole evidence is too strong to be withstood, and already in the 17th century it was recognized that the book was of composite origin. Immense labour has been spent in the critical analysis of the contents, but it is only since the work of Graf (1866) and Wellhausen (1878) that a satisfactory literary hypothesis has been found which explained

¹ It is interesting to find that the Spanish Rabbi Isaac (of Toledo, A.D. 982-1057), noticing that the royal list must be later than the time of Saul (also recognized by Martin Luther and others), proposed to assign the chapter to the age of Jehoshaphat.

² But the chronology is hopeless, and only ten years are allowed according to another and later scheme (xxv. 26, xxxv. 28, xlvii. 9).

³ Cf. the account of the Israelites in Egypt, where they are in Goshen, unaffected by the plagues (Ex. viii. 25, ix. 26), or, according to another view, are living in the midst of the Egyptians (e.g. xii. 23).
⁴ V. 7 breaks the context; there is repetition in vv. 10b and 13b; interchange of the names Jacob and Israel; v. 12 suggests a blessing upon Joseph himself; and with vv. 15 seq. (the blessing of the sons, not of Joseph), contrast vv. 20 seq. (the singular "in thee," v. 20).
⁵ Only the more noticeable peculiarities have been mentioned in the preceding columns.

the most obvious intricacies. The Graf-Wellhausen literary theory has gained the assent of almost all trained and unbiased biblical scholars, it has not been shaken by the more recent light from external evidence, and no alternative theory has as yet been produced. The internal features of Genesis demand some formulated theory, more precise than the indefinite concessions of the 17th century, beyond which the opponents of modern literary criticism scarcely advance, and the Graf-Wellhausen theory, in spite of the numerous difficulties which it leaves untouched, is the only adequate starting-point for the study of the book. According to this, Genesis is a post-exilic work composed of a post-exilic priestly source (P) and non-priestly earlier sources which differ markedly from P in language, style and religious standpoint, but much less markedly from one and another.⁶ These sources can be traced elsewhere in the Pentateuch and Joshua, and P itself is related to the post-exilic works Chronicles, Ezra and Nehemiah. In its present form Genesis is an indispensable portion of the biblical history, and consequently its literary growth cannot be viewed apart from that of the books which follow. On internal grounds it appears that the Pentateuch and Joshua, as they now read, virtually come in between an older history by "Deuteronomical" compilers (easily recognizable in Judges and Kings), and the later treatment of the monarchy in Chronicles, where the influence of the circle which produced P and the present Mosaic legislation is quite discernible. There have been stages where earlier extant sources have been cut down, adjusted or revised by compilers who have incorporated fresh material, and it is the later compilers of Genesis who have made the book a fairly knit whole. The technical investigation of the literary problems (especially the extent of the earlier sources) is a work of great complexity, and, for ordinary purposes, it is more important to obtain a preliminary appreciation of the general features of the contents of Genesis.

That the records of the pre-historic ages in Gen. i.-xi. are at complete variance with modern science and archaeological research is unquestionable.⁷ But although it is impossible to regard them any longer either as genuine history or as subjects for an allegorical interpretation (which would prove the accuracy of any record) they are of distinct value as human documents. They reflect the ideas and thoughts of the Hebrews, they illustrate their conceptions of God and the universe, and they furnish material for a comparison of the moral development of the Hebrews with that of other early races. Some of the traditions are closely akin to those current in ancient Babylonia, but a careful and impartial comparison at once illustrates in a striking manner the relative moral and spiritual superiority of our writers. On these subjects see further COSMOGONY; DELUGE.⁸

The records of the patriarchal age, xii.-l. are very variously estimated, although the great majority of scholars agree that they are not contemporary and that they cannot be used, as they stand, for pre-Mosaic times. Apart from the ordinary arguments of historical criticism, it is to be noticed that external evidence does not support the assumption that the records preserve

⁶ On the course of modern criticism and on the various sources: P, J (Judæan or Yahwist), E (Ephraimite or Elohist), see BIBLE (Old Test. Criticism). The passages usually assigned to P in Genesis are: i. 1-ii. 4a; v. 1-28, 30-32; vi. 1-2a; vii. 6 (and parts of 7-9), 11, 13-16a, 18-21, 24; viii. 1-2a, 3b-5, 13a, 14-19; ix. 1-17, 28-29; x. 1-7, 20, 22-23, 31-32; xi. 10-27, 31-32; xii. 4b-5; xiii. 6, 11b-12a; xvi. 1a, 3, 15-16; xvii. 1; xix. 29; xxii. 18, 26-5; xxiii.; xxv. 7-11a, 12-17, 19-20, 26b; xxvii. 34-35; xxviii. 46-xxviii. 9; xxix. 24, 28b, 29; xxxi. 18b; xxxiii. 18a; xxxiv. 1-2a, 4, 6, 8-10, 13-18, 20-24, part of 25, 27-29; xxxv. 9-13, 15, 22b-29; xxxvi. (in the main); xxxvii. 1-2a; xli. 46; xlv. 6-27; xlvii. 5-6a, 7-11, 27b-28; xlviii. 3-7; xlix. 1a, 28b-33, l. 12-13.

⁷ See on this, especially, S. R. Driver's *Genesis in the Westminster Commentaries* (seventh ed., 1909).

⁸ The above is typical of modern biblical criticism which is compelled to recognise the human element (and can thus have no *a priori* preconceptions in approaching the Old Testament), but at the same time reveals ever more decisively the presence of purifying influences, without which the records of Israel would have had no permanent interest or value. They thus gain a new value which cannot be impaired when it is realized that their significance is quite independent of their origins.

genuine pre-Mosaic history. There are no grounds for any arbitrary distinction between the "pre-historic" pre-Abrahamic age and the later age. External evidence, which recognizes no universal deluge and no dispersal of mankind in the third millennium B.C., throws its own light upon the opening centuries of the second. It has revealed conditions which are not reflected in Genesis, and important facts upon which the book is silent—unless, indeed, there is a passing allusion to the great Babylonian monarch Khammurabi in the Amraphel of Gen. xiv. Any careful perusal of modern attempts to recover historical facts or an historical outline from the book will show how very inadequate the material proves to be, and the reconstructions will be found to depend upon an interpretation of the narratives which is often liberal and not rarely precarious, and to imply such reshaping and rewriting of the presumed facts that the cautious reader can place little reliance on them. Whatever future research may bring, it cannot remove the *internal* peculiarities which combine to show that Genesis preserves, not literal history, but popular traditions of the past. External evidence has proved the antiquity of various elements, but not that of the form or context in which they now appear; and the difference is an important one. We have now a background upon which to view the book, and, on the one hand, it has become obvious that the records preserve—as is only to be expected—Oriental customs, beliefs and modes of thought. But it has not been demonstrated that these are exclusively pre-Mosaic. On the other hand, a better acquaintance with the ancient political, sociological and religious conditions has made it increasingly difficult to interpret the records as a whole literally, or even to find a place in pre-Mosaic Palestine for the lives of the patriarchs as they are depicted.¹ Nevertheless, though one cannot look to Genesis for the history of the early part of the second millennium B.C., the study of what was thought of the past, proves in this, as in many other cases, to be more instructive than the facts of the past, and it is distinctly more important for the biblical student and the theologian to understand the thought of the ages immediately preceding the foundation of Judaism in the 5th century B.C. than the actual history of many centuries earlier.

A noteworthy feature is the frequent *personification* of peoples, tribes or clans (see *GENEALOGY: Biblical*). Midian (*i.e.* the Midianites) is a son of Abraham; Canaan is a son of Ham (ix. 22), and Cush the son of Ham is the father of Ramah and grandfather of the famous S. Arabian state Sheba and the traders of Dedan (x. 6 sq., cf. Ezek. xxvii. 20-22). Bethuel the father of Rebekah is the brother of the tribal names Uz and Buz (xxii. 21 sqq., cf. Jer. xxv. 20, 23). Jacob is otherwise known as Israel and becomes the father of the tribes of Israel; Joseph is the father of Ephraim and Manasseh, and incidents in the life of Judah lead to the birth of Perez and Zerah, Judean clans. This personification is entirely natural to the Oriental, and though "primitive" is not necessarily an ancient trait.² It gives rise to what may be termed the "prophetic interpretation of history" (S. R. Driver, *Genesis*, p. 111), where the character, fortunes or history of the apparent individual are practically descriptive of the people or tribe which, according to tradition, is named after or descended from him. The utterance of Noah over Canaan, Shem and Japheth (ix. 25 sqq.), of Isaac over Esau and Jacob (xxvii.), of Jacob over his sons (xlix.) or grandsons (xlviii.), would have no meaning to Israelites unless they had some connexion with and interest for contemporary life and thought. Herein lies the force of the description of the wild and independent Ishmael (xvi. 12), the "father" of certain well-known tribes (xxv. 13-15); or the contrast between the skillful hunter Esau and the quiet and respectable Jacob (xxv. 27), and between the

tiller Cain who becomes the typical nomad and the pastoral Abel (iv. 1-15). The interest of the struggles between Jacob and Esau lay, not in the history of individuals of the distant past, but in the fact that the names actually represented Israel and its near rival Edom. These features are in entire accordance with Oriental usage and give expression to current belief, existing relationships, or to a poetical foreshadowing of historical vicissitudes. But in the effort to understand them as they were originally understood it is very obvious that this method of interpretation can be pressed too far. It would be precarious to insist that the entrances into Palestine of Abraham and Jacob (or Israel) typified two distinct immigrations. The separation of Abraham from Lot (cf. Lotan, an Edomite name), of Isaac from Hagar-Ishmael, or of Jacob from Esau-Edom scarcely points to the relative antiquity of the origin of these non-Israelite peoples who, to judge from the evidence, were closely related. Or, if the "sons" of Jacob had Aramaean mothers, to prove that those which are derived from the wives were upon a higher level than the "sons" of the concubines is more difficult than to allow that certain of the tribes must have contained some element of Aramaean blood (cf. 1 Chron. vii. 14, and see ASHER; GAD; MANASSEH). Some of the names are clearly not those of known clans or tribes (*e.g.* Abraham, Isaac), and many of the details of the narratives obviously have no natural ethnological meaning. Stories of heroic ancestors and of tribal eponyms intermingle; personal, tribal and national traits are interwoven. The entrance of Jacob or Israel with his sons suggests that of the children of Israel. The story of Simcon and Levi at Shechem is clearly not that of two individuals, sons of the patriarch Israel; in fact the story actually uses the term "wrought folly in Israel" (cf. Jud. xx. 6, 10), and the individual Shechem, the son of Hamor, cannot be separated from the city, the scene of the incidents. Yet Jacob's life with Laban has many purely individual traits. And, further, there intervenes a remarkable passage with an account of his conflict with the divine being who fears the dawn and is unwilling to reveal his name. In a few verses the "wrestling" ('*b* -*ē*) of Jacob (*y'āqōb*) is associated with the Jabbok (*yabbōq*); his "striving" explains his name Israel; at Peniel he sees "the face of God," and when touched on his vulnerable spot—the hollow of the thigh—he is lamed, hence "the children of Israel eat not the sinew of the hip which is upon the hollow of the thigh unto this day" (xxxii. 24-32). Other examples of the fusion of different features can be readily found. Three divine beings appear to Abraham at the sacred tree of Hebron, and when the birth of Isaac (from *šāḥaq*, "laugh") is foretold, the account of Sarah's behaviour is merely a popular and trivial story suggested by the child's name (xviii. 12-15; see also xvii. 17, xxi. 6, 9). An extremely fine passage then describes the patriarch's intercession for Sodom and Gomorrah, and the narrative passes on to the catastrophe which explains the Dead Sea and its desert region and has parallels elsewhere (*e.g.* the Greek legend of Zeus and Hermes in Phrygia). Lot escapes to Zoar, the name gives rise to the pun on the "little" city (xix. 20), and his wife, on looking back, becomes one of those pillars of salt which still invite speculation. Finally the names of his children Moab and Ammon are explained by an incident when he is a cave-dweller on a mountain.

To primitive minds which speculated upon the "why and wherefore" of what they saw around them, the narratives of Genesis afforded an answer. They preserve, in fact, some of the popular philosophy and belief of the Hebrews. They furnish what must have been a satisfactory origin of the names Edom, Moab and Ammon, Mahanaim and Succoth, Bethel, Beersheba, &c. They explain why Shechem, Bethel and Beersheba were ancient sanctuaries (see further below); why the serpent writhes along the ground (iii. 14); and why the hip sinew might not be eaten (xxxii. 32). To these and a hundred other questions the national and tribal stories—of which no doubt only a few have survived, and of which other forms, earlier or later, more crude or more refined, were doubtless current—furnish an evidently adequate answer. Myth and legend, fact and fiction, the common stock of oral tradition, have been handed down, and thus constitute one of the most valuable sources for popular Hebrew thought.

The book is not to be judged from any one-sided estimate of its

¹ See the remarks of W. R. Smith, *Eng. Hist. Rev.* (1888), pp. 128 seq. (from the sociological side), and for general considerations, A. A. Bevan, *Crit. Rev.* (1893), pp. 138 sqq.; S. R. Driver, *Genesis*, pp. xliii. sqq.

² Cf. Amos i. 11; 1 Chron. ii. iv. (note iv. 10), the Book of Jubilees (see above), and also Arabian usage (W. R. Smith, *Kinship and Marriage*, ch. 1). For modern examples, see E. Littmann, *Oriental Stud. Theodor Nöldeke* (ed. Bezold, 1906), pp. 942-958.

contents. By the side of much that seems trivial, and even non-moral—for the patriarchs themselves are not saints—it is noteworthy how frequently the narratives are didactic. The characteristic sense of collective responsibility, which appears more incidentally in xx. 7, is treated with striking intensity in a passage (xviii. 23-33) which uses the legend of Sodom and Gomorrah as a vehicle for the statement of a familiar problem (cf. Ezek. xviii., Ps. lxxiii., Job). It will be observed that interviews with divine beings presented as little difficulty to the primitive minds of old as to the modern native; even the idea of intercourse of supernatural beings with mortals (vi. 1-4) is to-day equally intelligible. The modern untutored native has a not dissimilar undeveloped and childlike attitude towards the divine, a naive theology and a simple cultus. The most circumstantial tales are told of imaginary figures, and the most incredible details clothe the lives of the historical heroes of the past. So abundant is the testimony of the historical heroes to the extent to which Eastern custom and thought elucidate the interpretation of the Bible, that it is very important to notice those features which illustrate Genesis. "The Oriental," writes S. L. Curtis (*Bibl. sacra*, Jan. 1901, pp. 103 sqq.), "is least of all a scientific historian. He is the prince of story-tellers, narratives, real and imaginative, spring from his lips, which are the truest portraiture of composite rather than individual Oriental life, though narrated under forms of individual experience." There are, therefore, many preliminary points which combine to show that the critical student cannot isolate the book from Oriental life and thought; its uniqueness lies in the manner in which the material has been shaped and the use to which it has been put.

The Book of Jubilees (not earlier than the 2nd century B.C.) presents the history in another form. It retains some of the

Questions of date.

canonical matter, often with considerable reshaping, omits many details (especially those to which exception could be taken), and adds much that is novel. The chronological system of the latest source in Genesis becomes an elaborate reckoning of heavenly origin. Written under the obvious influence of later religious aims, it is especially valuable because one can readily compare the two methods of presenting the old traditions.¹ There is the same kind of personification, fresh examples of the "prophetic interpretation of history," and by the side of the older "primitive" thought are ideas which can only belong to this later period. In each case we have merely a selection of current traditional lore. For example, Gen. vi. 1-4 mentions the marriage of divine beings with the daughters of men and the birth of Nephilim or giants (cf. Num. xiii. 33). Later allusions to this myth (e.g. Baruch iii. 26-28, Book of Enoch vi. sqq., 2 Peter ii. 4, etc.) are not based upon this passage; the fragment itself is all that remains of some more organic written myth which, as is well-known, has parallels among other peoples.² Old myths underlie the account of the creation and the garden of Eden, and traces of other versions or forms appear elsewhere in the Old Testament. Again, the Old Testament throws no light upon the redemption of Abraham (Is. xxix. 22), although the Targums and other sources profess to be well-informed. The isolated reference to Jacob's conquest of Shechem in Gen. xlviii. 22 must have belonged to another context, and later writings give in a later and thoroughly incredible form allied traditions. In Hosea xii. 4, Jacob's wrestling is mentioned before the scene at Bethel (Gen. xxxii. 24 sqq., xxviii. 11 sqq.). The overthrow of Sodom and Gomorrah is described in Genesis (xviii. seq.), but Hosea refers only to that of Admah and Zeboim (zi. 8, cf. Deut. xxix. 23, Gen. x. 19)—different versions of the great catastrophe were doubtless current. Consequently investigation must start with the particular

¹ The Book of Jubilees also enables the student to test the arguments based upon any study restricted to Genesis alone. Thus it shows that the "primitive" features of Genesis afford a criterion which is sociological rather than chronological. This is often ignored. For example, the conveyance of the field of Machpelah (xxiii.) is conspicuous for the absence of any reference to a written contract in contrast to the "business" methods in Jer. xxxii. This does not prove that Gen. xxiii. is early, because writing was used in Palestine about 1400 B.C., and, on the other hand, the more simple forms of agreement are still familiar after the time of Jeremiah (e.g. Ruth. Proverbs). Similarly, no safe argument can be based upon the institution of blood-revenge in Gen. iv., when one observes the undeveloped conditions among the Trachonites of the time of Herod the Great (Josephus, *Ant.* xvi. 9, 1), or the varying usages among modern tribes.

² On the Jewish forms, see R. H. Charles, *Book of Jubilees* (1902), pp. 33 sqq.

details which happen to be preserved, and these not necessarily in their original or in their only form. Since the antiquity of elements of tradition is independent of the shape in which they appear before us, a careful distinction must be drawn between those details which do not admit of being dated or located and those which do. There is evidence for the existence of the names Abram, Jacob and Joseph previous to 600 B.C., but this does not prove the antiquity of the present narratives encircling them. Babylonian tablets of the creation date from the 7th century B.C., but their contents are many centuries earlier (viz. the age of Khammurabi), whereas the Phoenician myths of the origin of things are preserved in a late form by the late writers Damascus and Philo of Byblus. Gen. xiv., which may preserve some knowledge of the reign of Khammurabi, is on internal literary grounds of the post-exilic age, and it is at least a coincidence that the Babylonian texts, often quoted in support of the genuineness of the narrative, belong to about the same period and use early Babylonian history for purely didactic purposes.³ In general, just as the Book of Jubilees, while presenting many elements of old tradition, betrays on decisive internal grounds an age later than Genesis itself, so, in turn, there is sufficient conclusive evidence that Genesis in its present form includes older features, but belongs to the age to which (on quite independent grounds) the rest of the Pentateuch must be ascribed.

Popular tradition often ignores events of historical importance, or, as repeated experience shows, will represent them in such a form that the true historical kernel could never have been recovered without some external clue. The absence of definite references to the events of the Israelite monarchy does not necessarily point to the priority of the traditions in Genesis or their later date. Nevertheless, some allusion to national fortunes is reflected in the exaltation of Jacob (Israel) over Esau (Edom), and in the promise that the latter should break the yoke from his neck.⁴ Israelite kings are foreshadowed (xvii. 6, xxxv. 11, P), and Israel's kingdom has the ideal limits ascribed to Solomon (xv. 18, see 1 Kings iv. 21; but cf. art. SOLOMON). Judah is promised a world-wide king (xlix. 8-10), though elsewhere the supremacy of Joseph rouses the jealousy of his "brothers" (xxvii. 8). Different dates and circles of interest are thus manifest. The cursing and dispersion of Simeon and Levi (xlix. 5-7) recall the fact that Simeon's cities were in the territory of Judah (Josh. xix. 1, 9), and that the Levitical priests are later scattered and commended to the benevolence of the Israelites. But the curse obviously represents an attitude quite opposed to the blessing pronounced upon Levi by Moses (Deut. xxxiii. 8-11). The Edomite genealogies (xxxvii.) represent a more extensive people than the references in the popular stories suggest, and the latter by no means indicate that Edom had so important a career as we actually gather from a few allusions to its kings (xxxvi. 31-30).⁵ The references to Philistines are anachronistic for the pre-Mosaic age, and it is clear that the tradition of a solemn covenant with a Philistine king and his general (xxi. 22 seq., xxvi. 26 sqq.) does not belong to the age or the circle which remembered the grievous oppressions of the Philistines or felt contempt for these "uncircumcised" enemies of Israel. Finally, the thread of the tradition unmistakably represents a national unity of the twelve sons (tribes) of

³ A. H. Sayce, *Proc. of the Soc. of Bibl. Arch.* (1907), pp. 13-17.

⁴ xxvii. 27-29, 39 seq.—This is significantly altered in the later writings (Jub. xxvi. 34 and the Targums). It is worth noticing that in Jub. xxvi. 35 a new turn is given to Gen. xxvii. 41 by changing Isaac's approaching death (which raises serious difficulties in the history of Jacob) into Esau's wish that it may soon come.

⁵ See E. Meyer (and B. Luther), *Die Israeliten und ihre Nachbarstämme* (1906), pp. 386-389, 442-446.

⁶ See PHILISTINES. The covenant with Abimelech may be compared with the friendship between David and Achish (1 Sam. xxvii.), who is actually called Abimelech in the heading of Ps. xxxvii. (see 1 Sam. xxi. 10). If this is a mistake (and not a variant tradition) it is a very remarkable one. The treatment of the covenant by the author of Jubilees (xxiv. 28 sqq.), on the other hand, is only intelligible when one recalls the attitude of Judah to the Philistine cities in the 2nd century B.C.; see R. H. Charles, *ad loc.*

Israel; but this unity was not felt at certain periods of dis-organization, and the idea of including Judah among the sons of Israel could not have arisen at a time when Israel and Judah were rival kingdoms.¹ In so far as the traditions can be read in the light of biblical history it is evident that they belong to different ages and represent different national, tribal, or local standpoints.

Another noteworthy feature is the interest taken in *sacred sites*. Certain places are distinguished by theophanies or by the

erection of an altar (*lit.* place of sacrificial slaughter), and incidents are narrated with a very intelligible purpose. *Mispah* in Gilead is the scene of a covenant or treaty between Jacob and his Aramaean relative commemorated by a pillar (*Massebok*). It was otherwise known for an annual religious ceremony, the traditional origin of which is related in the story of Jephthah's vow and sacrifice (Judg. xi.), and its priests are denounced by Hosea (v. 1). *Shechem*, the famous city of the Samaritans ("the foolish nation," Ecclus. I. 26), where Joseph was buried (Josh. xxiv. 32), had a sanctuary and a sacred pillar and tree. It was the scene of the coronation (a religious ceremony) of Abimelech (Judg. ix.), and Rehoboam (1 Kings xii. 1). The pillar was ascribed to Joshua (Josh. xxiv. 26 seq.), and although Jacob set up at Shechem an "altar," the verb suggests that the original object was a pillar (Gen. xxxiii. 20). The first ancestor of Israel, on the other hand, is merely associated with a theophany at an oracular tree (xii. 6). The Benjaminite *Bethel* was especially famous in Israelite religious history. The story tells how Jacob discovered its sanctity,—it was the gate of heaven,—made a covenant with its God, established the sacred pillar, and instituted its tithes (xxviii.). The prophetess Deborah dwelt under a palm-tree near Bethel (Judg. iv. 5), and her name is also that of the foster-mother of Rebekah who was buried near Bethel beneath the "oak of weeping" (xxxv. 8). *Bochim* ("weeping") elsewhere receives its name when an angel appeared to the Israelites (Judg. ii. 1, Septuagint adds Bethel). To the prophets Hosea and Amos the cultus of Bethel was superstitious and immoral, even though it was Yahweh himself who was worshipped there (see *BETHEL*). South of Hebron lay *Beersheba*, an important centre and place of pilgrimage, with a special numen by whom oaths were taken (Amos viii. 14, see Sept. and the commentaries). Isaac built its altar, and Isaac's God guarded Jacob in his journeying (xxx. 29, xlvi. 1). This patriarch and his "brother" Ishmael are closely associated with the district south of Judah, both are connected with *Beer-lahai-roi* (xxiv. 62, Sept. xv. 11), whose fountain was the scene of a theophany (xvi.), and their traditions are thus localized in the district of Kadesh famous in the events of the Exodus (cf. xvi. 14, xxi. 21, xxv. 18, Ex. xv. 22). (See *EXODUS, THE*.) Abraham planted a sacred tree at Beersheba and invoked "the everlasting God" (xxi. 33). But the patriarch is more closely identified with *Hebron*, which had a sanctuary (cf. 2 Sam. xv. 7 seq.), and an altar which he built "unto Yahweh" (xiii. 18). The sacred oak of Mamre was famous in the time of Josephus (*B. J.* iv. 9, 7), it was later a haunt of "angels" (Sossomen), and Constantine was obliged to put down the heathenish cultus. The place still has its holy tree. Beneath the oak there appeared the three divine beings, and in the cave of Machpelah the illustrious ancestor and his wife were buried. The story of his descent into Egypt and the plagues of Pharaoh is a secondary insertion (xii. 10–xiii. 2), and where the patriarch appears at Beersheba it is in incidents which tend to connect him with his "son" Isaac. There is a very distinct tendency to emphasize the importance of Hebron. Taken from primitive giants by the non-Israelite clan Caleb (9.9) it has now become predominant in the patriarchal traditions. Jacob leaves his dying father at Beersheba (xxviii. 30), but according to the *latest* source he returns to him at Hebron (xxxv. 27), and here, north of Beersheba, he continues to live (xxxvii. 14, xlvi. 1–5). The cave of Machpelah became the grave of Isaac, Rebekah and Leah (but not Rachel), and though Jacob

Interest in holy places.

appears to be buried beyond the Jordan, it is the latest source which places his grave at Hebron (l. 1–11 and 12 seq.). So in still later tradition, all the sons of Jacob with the exception of Joseph find their last resting-place at Hebron, and in Jewish prayers for the dead it is besought that their souls may be bound up with those of the patriarchs, or that they may go to the cave of Machpelah and thence to the Cherubim.² The increasing prominence of the old Calebite locality is not the least interesting phase in the comparative study of the patriarchal traditions.

The association of the ancestors of Israel with certain sites is a feature which finds analogies even in modern Palestine. There are old centres of cult which have never lost the veneration of the people; the shrines are known as the tombs of saints or *walis* (patrons) with such orthodox names as St George, Elijah, &c. Traditions justify the reputation for sanctity, and not only are similar stories told of distinct figures, but there are varying traditions of a single figure.³ The places have retained their sacred character despite political and religious vicissitudes; they are far older than their present names, and such is the conservatism of the east that it is not surprising when, for example, a sacred tomb at Gezer stands quite close to the site of an ancient holy place, about 3000 years old, the existence of which was first made known in the course of excavation. Genesis preserves a selection of traditions relating to a few of the old Palestinian centres of cult. We cannot suppose that these first gained their sacred character in the pre-Mosaic "patriarchal" age, there is in any case the obvious difficulty of bridging the gap between the descent into Egypt and the Exodus, and it is clear that when the Israelites entered Palestine they came among a people whose religion, tradition and thought were fully established. It is only in accordance with analogy if stories were current in Israel of the institution of the sacred places, and closer study shows that we do not preserve the original version of these traditions.⁴

A venerated tree in modern Palestine will owe its sanctity to some tradition, associating it, it may be, with some saint; the Israelites in their turn held the belief that the sacred tree at Hebron was one beneath which their first ancestor sat when three divine beings revealed themselves to him. But it is noteworthy that Yahweh alone is now prominent; the tradition has been revised, apparently in writing, and, later, the author of Jubilees (xvi.) ignores the triad. At Beer-lahai-roi an El ("god") appeared to Hagar, whence the name of her child Ishmael; but the writer prefers the unambiguous proper name Yahweh, and, what is more, the divine being is now Yahweh's angel—the Almighty's subordinate (xvi.). The older traits show themselves partly in the manifestation of various *Els*, and partly in the cruder anthropomorphism of the earlier sources. Later hands have by no means eliminated or modified them altogether, and in xxxi. 53 one can still perceive that the present text has endeavoured to obscure the older belief that the God of Abraham was not the God of his "brother" Nahor (see the commentaries). The sacred pillar erected by Jacob at Bethel was solemnly anointed with oil, and it (and not the place) was regarded as the abode of the Deity (xxviii. 18, 22). This agrees with all that is known of stone-cults, but it is quite obvious that this interesting example of popular belief is far below the religious ideas of the writer of the chapter in its present form.⁵ There were many places where it could be said that Yahweh had recorded his name and would bless his worshippers (Ex. xx. 24). They were abhorrent to the advanced ethical teaching of prophets and of those imbued with the spirit of Deuteronomy (cf. 2 Kings xviii. 4 with v. 22), and it is patent from Jeremiah,

¹ Cf. Josephus, *Antiq.* ii. 8, 2; *Test. of xii. Patriarchs*; Acts vii. 16 (where Shechem is an error); Oesterley and Box, *Religion and Worship of the Synagogue*, pp. 340 seq.; M. G. Dampier, in *Church and Synagogue* (1909), p. 78.

² See J. P. Peters, *Early Heb. Story* (1904), pp. 81 seq.; S. A. Cook, *Relig. of Anc. Palestine* (1908), pp. 19 seq.

³ In like manner the Babylonian story of the flood has been revised and adapted to the Hebrew Noah (cf. *Nippur, ad fin.*).

⁴ The writer in Jub. xviii. 27 treats the pillar as a "sign." Another useful example of revision is to be found in Josh. xxiii., where what was regarded (by a reviser) as an object unworthy of the religion of Yahweh is now merely commemorated.

⁵ In 2 Sam. xix. 43 (original text) the men of Israel claim to be the first-born rather than Judah; cf. 1 Chron. v. 1 seq., where the birthright (after Reuben was degraded) is explicitly conferred upon Joseph (*Ephraim and Manasseh*).

Ezekiel and Is. lvi-lxvi. that even at a late date opinion varied as to how Yahweh was to be served.¹ It is significant, therefore, that the narratives in Genesis (apart from P) reflect a certain tolerant attitude; there is much that is contrary to prophetic thought, but even the latest compilers have not obliterated all features that, from a strict standpoint, could appear distasteful. Although the priestly source shows how the lore could be reshaped, and Jubilees represents later efforts along similar lines, it is evident that for ordinary readers the patriarchal traditions could not be presented in an entirely new form, and that to achieve their aims the writers could not be at direct variance with current thought.

It will now be understood why several scholars have sought to recover earlier forms of the traditions, the stages through which the material has passed, and the place of the earlier forms and stages in the history and religion of Israel. These labours are indispensable for scientific biblical study, and are most fruitful when they depend upon comprehensive methods of research. When, for example, one observes the usual forms of hero-cult and the tendency to regard the occupant of the modern sacred shrine as the ancestor of his clients, deeper significance is attached to the references to the protective care of Abraham and Israel (Is. lxiii. 16), or to the motherly sympathy of Rachel (Jer. xxxi. 15). And, again, when one perceives the tendency to look upon the alleged ancestor or *weli* as an almost divine being, there is much to be said for the view that the patriarchal figures were endowed by popular opinion with divine attributes. But here the same external evidence warns us that these considerations throw no light upon the original significance of the patriarchs. It is impossible to recover the earliest traditions from the present narratives, and these alone offer sufficiently perplexing problems.²

From a careful survey of all the accessible material it is beyond doubt that Genesis preserves only a selection of traditions of various ages and interests, and often not in their original form. We have relatively little tradition from North Israel; Beersheba, Beer-labai-roi and Hebron are more prominent than even Bethel or Shechem, while there are no stories of Gilgal, Shiloh or Dan. Yet in the nature of the case there must have been a great store of local tradition accessible to some writers and at some periods.³ Interest is taken not in Phoenicia, Damascus or the northern tribes, but in the east and south, in Gilead, Ammon, Moab and Ishmael. Particular attention is paid to Edom and Jacob, and there is good evidence for a close relationship between Edomite and allied names and those of South Palestine (including Simeon and Judah). Especially significant, too, is the interest in traditions which affected the South of Palestine, that district which is of importance for the history of Israel in the wilderness and of the Levites.⁴ It is noteworthy, therefore, that while different peoples had their own theories of their earliest history, the first-born of the first human pair is Cain, the eponym of the Kenites, and the ancestor of the beginnings of civilization (iv. 17, 20-22). This "Kenite" version had its own view of the institution of the worship of Yahweh (iv. 26); it appears to have ignored the Deluge, and it implies the existence of a fuller corpus of written tradition. Elsewhere, in the records of the Exodus, there are traces of specific traditions associated with Kadesh, Kenites, Caleb and Jerahmeel, and with a movement into Judah, all originally independent of their present context. Like the prominence of the traditions of Hebron and its hero Abraham, these features cannot be merely casual.⁵

¹ For popular religious thought and practice (often described as pre-prophetic, though non-prophetic would be a safer term), see **HEBREW RELIGION**.

² Among recent efforts to find and explain mythical elements, see especially Stucken, *Astralmythen*; H. Winckler, *Geschichte Israels*, vol. ii.; and P. Jensen, *Das Gilgamesch-Epos in der Weltliteratur*.

³ Again the analogy of the modern East is instructive. Especially interesting are the traditions associating the same figure or incident with widely separated localities.

⁴ See **EXODUS, THE; LEVITES**. On this feature see Luther and Meyer, *op. cit.* pp. 158 seq., 227 seq., 259, 279, 305, 386, 443. Their researches on this subject are indispensable for a critical study of Genesis.

⁵ The notion of an Eve (*hawwah*, "serpent") as the first woman may be conjecturally associated with (a) the frequent traditions of the serpent-origin of clans, and (b) with evidence which seems to connect the Levites and allied families with some kind of serpent-cult (see Meyer, *op. cit.* pp. 116, 426 seq., 443, and art. **SERPENT-CULT** (see Meyer, *op. cit.* pp. 116, 426 seq., 443, and art. **SERPENT-CULT**). The account of mankind as it now reads (ii. seq.) is in

The fact that one is not dealing with literal history complicates the question of the nomadic or semi-nomadic life of the Israelite ancestors.⁶ They are tent-dwellers, shepherds, sojourners (xvii. 8, xxiii. 4, xxviii. 4, xxvii. 7, xxxvii. 1), and we breathe the air of the open country. But the impression gained from the narratives is of course due to the narrators. The movements of the patriarchs serve mainly to connect them with traditions which were originally independent. When Abraham separates from Lot he settles in "the land of Canaan," while Lot dwells in "the cities of the plain" (xiii. 12). Isaac at Beersheba enters into an alliance with the Philistines (xxvi. 12 seq.), while Jacob seems to settle at Shechem (xxxiv.), and there or at Dothan, a few miles north, his sons pasture their father's flock (xxxvii. 12 seq.).⁷ Indeed, according to an isolated fragment Jacob conquered Shechem and gave it to Joseph (xlvi. 22), and this tradition underlies (and has not given birth to) the late and fantastic stories of his warfare (Jub. xxiv. 1-9, Test. of Judah iii.). Judah, also, is represented as settling among the Canaanites (xxxviii.), and Simeon marries a Canaanite—according to late tradition, a woman of Zephath (xvi. 10; Jub. xxxiv. 20, xlv. 13; see Judg. i. 17). These representations have been subordinated to others, in particular to the descent into Egypt of Jacob (Israel) and his sons, and the Exodus of the Israelites. But the critical study of these events raises very serious historical problems. Abraham's grandson, with his family—a mere handful of people—went down into Egypt during a famine (cf. Abraham xii. 10, and Isaac xxvi. 1 seq.); 400 years pass, all memory of which is practically obliterated, and the Israelite nation composed of similar subdivisions returns. Although the later genealogies from Jacob to Moses allow only four generations (cf. Gen. xv. 16), the difficulties are not removed. Joseph lived to see the children of Machir (i. 23, note Ex. i. 8), though Machir received Gilead from the hands of Moses (Num. xxxiii. 40); Levi descended with Kehath, who became the grandfather of Aaron and Moses, while Aaron married a descendant in the fifth generation from Judah (Ex. vi. 23). On the other hand the genealogies in 1 Chron. ii. seq. are independent of the Exodus; Ephraim's children raid Gath, his daughter founds certain cities, and Manasseh has an Aramaean concubine who becomes the mother of Machir (1 Chron. vii. 14, 20-24).⁸ Moreover the whole course of the invasion and settlement of Israel (under Joshua) has no real connexion with pre-Mosaic patriarchal history. If we reinterpret the history of the *family* and its descent into Egypt, and besetle its increase into a *nation*, and if we figure to ourselves a more gradual occupation of Palestine, we destroy the entire continuity of history as it was understood by those who compiled the biblical history, and we have no evidence for any confident reconstruction. With such thoroughness have the compilers given effect to their views that only on closer examination is it found that even at a relatively late period fundamentally differing traditions still existed, and that those which belonged to circles which did not recognize the Exodus have been subordinated and adjusted by writers to whom this was the profoundest event in their past.⁹

That the journey of Jacob-Israel from his Aramaean relatives into Palestine hints at some pre-Mosaic immigration is possible, but has not been either proved or disproved. The details point rather to a reflection of the entrance of the children of Israel, elsewhere ascribed to the leadership of Joshua (*q.v.*). Though the latter proceeded to Gilgal, a variant tradition, now almost lost, seems to have recorded an immediate journey to Shechem (Deut. xxvii. 1-10, Josh. viii. 30-35) previous to Joshua's great campaigns (Josh. x. seq., cf. Jacob's wars). His religious gathering at Shechem several respects less primitive (contrast vi. 1 seq.), and the present story of Cain and his murder of Abel really places the former in an unfavourable light.

⁶ See the discussion between B. D. Eerdmans and G. A. Smith in the *Expositor* (Aug.-Oct. 1908), and the former's *Alttest. Studien*, ii. (1908), *passim*.

⁷ xxxiv. (note v. 9) indicates a possible alliance with Shechemites, and xxxv. 4 (taken literally) implies a residence long enough for a religious reform to be necessary. Yet the present aim of the narratives is to link together the traditions and emphasize Jacob's return from Laban to his dying father (xxvii. 21; xxxi. 3, 13, 18; xxxii. 9; xxxv. 1, 27).

⁸ Cf. Benjamin's descendants in 1 Chron. viii. 6 seq. and see on the naive and primitive character of these traditions, Kittel, comment. *ad loc.*

⁹ That there are traditions in Genesis which do not form the prelude to Exodus is very generally recognized by those who agree that the Israelites after entering Palestine took over some of the indigenous lore (whether from the Canaanites or from a presumed earlier layer of Israelites). This adoption of native tradition by new settlers, however, cannot be confined to any single period. See further, Luther and Meyer, *op. cit.* pp. 108, 110, 156, 227 seq., 254 seq., 414 seq., 433; on traditions related to the descent into Egypt, *ib.* 122 seq., 151 seq., 260; and on the story of Joseph (ch. xxxv., xxxvii. seq.), as an independent cycle used to form a connecting link, Luther, *ib.* pp. 142-154.

The
Southern
nucleus.

before the dismissal of the tribes finds its parallel in Jacob's reforms before leaving for Bethel (xxiv.; cf. v. 26, Gen. xxv. 4). Owing, perhaps, to the locale of the writers, we hear relatively little of the northern tribes. Judah and Simeon are the first to conquer their lot, and the "house of Joseph" proceeds south to Bethel, where the story of the "weeping" at Bochim finds a parallel in the "oak of weeping" (Gen. xxxv. 8). In Gen. xxxviii. "at that time Judah went down from his brethren"—in xxxvii. they are at Shechem or Dothan—and settled among Canaanites, and there is a fragmentary allusion to a similar alliance of Simeon (xvi. 10). The trend of the two series of traditions is too close to be accidental, yet the present sequence of the narratives in Joshua and Judges associates them with the Exodus. Further, Jacob's move to Shechem, Bethel and the south is parallel to that of Abraham, but his history actually represents a twofold course. On the one hand, he is the Aramaean (Deut. xxvi. 5), the favourite son of his Aramaean mother. On the other, Rebekah is brought to Beer-lahai-roi (xxiv.), Jacob belongs to the south and he leaves Beersheba for his lengthy sojourn beyond the Jordan. His separation from Esau, the revelation at Bethel, and the new name Israel are recorded twice, and if the entrance into Palestine reflects one ethnological tradition, the possibility that his departure from Beersheba reflects another, finds support (a) in the genealogies which associate the nomad "father" of the southern clans Caleb and Jerahmeel with Gilead (1 Chron. ii. 21), and (b) in the hints of an "exodus" from the district of Kadesh northwards.

The history of an immigration into Palestine from beyond the Jordan would take various shapes in local tradition. In Genesis it is preserved from the southern point of view. The northern standpoint appears when Rachel, mother of Joseph and Benjamin, is the favoured wife in contrast to the despised Leah, mother of Judah and Simeon; when Joseph is supreme among his brethren; and when Judah is included among the "sons" of Israel. It is possible that the application of the traditional immigration to the history of the tribes is secondary. This at all events suggests itself when xxiv. extends to the history of all the sons, incidents which originally concerned Simeon and Levi alone, and which may have represented the Schemite version of a "Levitical" tradition (see LEVITES). However this may be, it is necessary to account for the nomadic colouring of the narratives (cf. Meyer, pp. 305, 472) and the prominence of southern interests, and it would be in accordance with biblical evidence elsewhere if northern tradition had been taken over and adapted to the standpoint of the southern members of Israel, with the incorporation of local tradition which could only have originated in the south.¹ These and other indications point to a late date in biblical history. There is a manifest difference between the religious importance of Shechem in the traditions of Joshua (xxiv.) and Jacob's reforms when he leaves behind him the heathen symbols before journeying to the holy site of Bethel (Gen. xxxv. 4). There is even some polemic against marriage with Shechemites (xxxiv.; more emphatic in Jub. xxx.), while in the story of the Hebronite Abraham, Bethel itself is avoided and Shechem is of little significance. Again, the present object of xxxviii. is to trace the origin of certain Judaeic subdivisions after the death of the wicked Er and Onan. It is purely local and is interested in Shelah, and more especially in Perez and Zerah, names of families or clans of the post-exilic age.² Else-

¹ Cf. the late "Deuteronomic" form of Judges where a hero of Kenizite origin (and therefore closely connected with Caleb) stands at the head of the Israelite "judges"; also, from another aspect, the specifically Judaeic and anti-Israelite treatment of the history of the monarchy. But in each case the feature belongs to a relatively late stage in the literary history of the books; see JUDGES; SAMUEL, BOOKS OF; KINGS.

² Mahalalel (son of Kenan, another form of Cain, v. 12) is also a prominent ancestor in Perez (Neh. xi. 4), and Zerah claimed the renowned sages of Solomon's day (1 Chron. ii. 6, 1 Kings iv. 31). The story implies that Perez surpassed his "brother" clan Zerah (xxxviii. 27-30), and in fact Perez is ultimately reckoned the head of the Judaeic subdivisions (1 Chron. ii. 4 seq.), and thus is the reputed ancestor of the Davidic dynasty (Ruth iv. 12, 18 seq.).

where, in 1 Chron. ii. and iv., the genealogies represent a Judah composed of clans from the south (Caleb and Jerahmeel) and of small families or guilds, Shelah included. It is not the Judah of the monarchy or of the post-exilic Babylonian-Israelite community. But the mixed elements were ultimately reckoned among the descendants of Judah, through Hezron the "father" of Caleb and Jerahmeel, and just as the southern groups finally, became incorporated in Israel, so it is to be observed that although Hebron and Abraham have gained the first place in the patriarchal history, the traditions are no longer specifically Calebite, but are part of the common Israelite heritage.

We are taken to a period in biblical history when, though the historical sources are almost inexplicably scanty, the narratives of the past were approaching their present shape. Some time after the fall of Jerusalem (587 B.C.) there was a movement from the south of Judah northwards to the vicinity of Jerusalem (Bethlehem, Kirjath-jearim, &c.), where, as can be gathered from 1 Chron. ii., were congregated Kenite and Rechabite communities and families of scribes. Names related to those of Edomite and kindred groups are found in the late genealogies of both Judah and Benjamin, and recur even among families of the time of Nehemiah.³ The same obscure period witnessed the advent of southern families,⁴ the revival of the Davidic dynasty and its mysterious disappearance, the outbreak of fierce hatred of Edom, the return of exiles from Babylonia, the separation of Judah from Samaria and the rise of bitter anti-Samaritan feeling. It closes with the reorganization associated with Ezra and Nehemiah and the compilation of the historical books in practically their present form. It contains diverse interests and changing standpoints by which it is possible to explain the presence of purely southern tradition, the southern treatment of national history, and the antipathy to northern claims. As has already been mentioned, the specifically southern writings have everywhere been modified or adjusted to other standpoints, or have been almost entirely subordinated, and it is noteworthy, therefore, that in narratives elsewhere which reflect rivalries and conflicts among the priestly families, there is sometimes an animus against those whose names and traditions point to a southern origin (see LEVITES).

Thus the book of Genesis represents the result of efforts to systematize the earliest history, and to make it a worthy prelude to the Mosaic legislation which formed the charter of Judaism as it was established in or about the 5th century B.C. It goes back to traditions of the most varied character, whose tone was originally more in accord with earlier religion and thought. Though these have been made more edifying, they have not lost their charm and interest. The latest source, it is true, is without their freshness and life, but it is a matter for thankfulness that the simple compilers were conservative, and have neither presented a work entirely on the lines of P, nor rewritten their material as was done by the author of Jubilees and by Josephus. It is obvious that from Jubilees alone it would have been impossible to conceive the form which the traditions had taken a few centuries previously—viz. in Genesis. Also, from P alone it would have been equally impossible to recover the non-priestly forms. But while there is no immeasurable gulf between the canonical book of Genesis and Jubilees, the internal study of the former reveals traces of earlier traditions most profoundly different as regards thought and contents. It

The sympathies of these traditions are as suggestive as their presence in the canonical history, which, it must be remembered, ultimately passed through the hands of Judaeic compilers.

³ Neh. iii. 9, 14; see Meyer, pp. 300, 430; S. A. Cook, *Critical Notes on O.T. History*, p. 58 n. 2. While the evidence points to an early close relationship among S. Palestinian groups (Edom, Ishmael, &c.; cf. Meyer, p. 446), there are many allusions to subsequent treacherous attacks which made Edom execrable. Here again biblical criticism cannot at present determine precisely when or precisely why the changed attitude began; see EDOM; JEWS, 11, 20, 22.

⁴ Although the movement reflected in 1 Chron. ii. is scarcely pre-exilic, yet naturally there had always been a close relation between Judah and the south, as the Assyrian inscriptions of the latter part of the 8th century B.C. indicate.

is not otherwise when one looks below the traditional history elsewhere (e.g. Samuel, Kings). An explanation may be found in the vicissitudes of the age. The movement from the south, which seems to account for a considerable cycle of the patriarchal traditions, belongs to the age after the downfall of the Israelite and (later) the Judaean monarchies when there were vital political and social changes. The removal of prominent inhabitants, by Assyria and later by Babylonia, the introduction of colonists from distant lands, and the movements of restless tribes around Palestine were more fatal to the continuity of trustworthy tradition than to the persistence of popular thought. New conditions arose as the population was reorganized, a new Israel claimed to be the heirs of the past (cf. e.g. the Samaritans, Ezr. iv. 2, Joseph. *Antiq.* ix. 14, 3; xi. 8, 6), and not until after these vicissitudes did the book of Genesis begin to assume its present shape.¹ (See JEWS; PALESTINE: *History*.)

The above pages handle only the more important details for the study of a book which, as regards contents and literary history, cannot be separated from the series to which it forms the introduction. As regards the literary-critical problems it is clear that with the elimination of P we have the sources (minor adjustment and revision excepted) which were accessible to the last compiler in the post-exilic age. Most critics have inclined to date these sources (J and E) as early as possible, whereas the admitted presence of secondary and of relatively late passages (e.g. xviii. 22 sqq.; J; xxii., E) shows that one must work back from the sources as known in P's age, and that one can rely only upon those criteria which can be approximately dated. It is usual to regard the more primitive character of J and E as a mark of antiquity; but this ignores the regular survival of primitive modes of thought and of popular tradition outside more cultured circles. It is also recognized that J and E are non-prophetic and non-Deuteronomic, but it has not been proved that the present J and E are earlier than the prophets or the Deuteronomic reforms of Josiah (2 Kings xxii. seq.). J and E are linguistically almost identical (in contrast to P), and differ from P in features which are often not of chronological but of sociological significance (e.g. the mentality of the writers). Their language is without some of the phenomena found in narratives which emanate from the north (e.g. Judges v., stories of Elijah and Elisha), and their stylistic variations may be, as Gunkel suggests, the mark of a district or region; for this district one would look in the neighbourhood of Jerusalem. The conclusion that P's narratives and laws in the Pentateuch are post-exilic was found by biblical scholars to be a necessary correction to the original hypothesis of Graf (1866) that P's narratives were to be retained (with J and E) at an early date. This view was influenced by the close connexion between the subject-matter, J, E and P representing the same trend of tradition. But by still ascribing J and E as written sources to about the 9th or 8th century (individual opinion varies), many difficulties and inconsistencies are involved. The present J and E reflect a re-shaping and readjustment of earlier tradition which is found elsewhere, and the suggestion that they are not far removed from the age of the priestly writers and redactors does not conflict with what is known of language, forms of religious thought, or tendencies of tradition. We reach thus approximately the age when post-Deuteronomic editors were able to utilize such records as Judg. i. xvii. sqq., 2 Sam. ix.-xx. (see JUDGES; SAMUEL, BOOKS OF), which are equally valuable as specimens of current thought and of written tradition. In conclusion, the tendency of criticism has been to recognize "schools" of J and E extending into the exile, thus making the three sources J, E and P more nearly contemporaneous. The most recent conservative authority also inclines to a similar contemporaneity ("collaboration" or "co-operation"), but at an impossibly early date (J. Orr, *Problems of the O. T.*, 1905, pp. 216, 345, 354, 375 seq., 527). By admitting possible revision in the post-exilic age (pp. 226, 369, 375 seq.), the conservative theory recalls the old legend that Ezra rewrote the Old Testament (2 Esd. xiv.) and thus restored the Law which had been lost; a view which, through the early Christian Fathers, gained currency and has enjoyed a certain popularity to the present day. But when once revision or rewriting is conceded, there is absolutely no guarantee that the present Pentateuch is in any way identical with the five books which tradition ascribed to Moses (e.g.), and the necessity for a comprehensive critical investigation of the present contents makes itself felt.²

LITERATURE.—Only a few of the numerous works can be mentioned. Of those written from a conservative or traditional stand-

point the most notable are: W. H. Green's *Unity of Genesis* (1895); and J. Orr, *Problems of the O. T.* (which is nevertheless a great advance upon earlier non-critical literature). S. R. Driver's commentary (*Westminster Series*) deals thoroughly with all preliminary problems of criticism, and is the best for the ordinary reader; that of W. H. Dillmann (6th ed., Eng. trans.) is more technical, that of W. H. Bennett (*Century Bible*) is more concise and popular. G. J. Spurrell, *Notes on the Text of Genesis*, and C. J. Ball (in Haupt's *Sacred Books of the O. T.*) appeal to Hebrew students. W. E. Addis, *Documents of the Hexateuch*, Carpenter and Harford-Battersby, *The Hexateuch*, and C. F. Kent, *Beginnings of Hebrew History*, are more important for the literary analysis. J. Wellhausen's sketch in his *Proleg. to Hist. of Israel* (Eng. trans., pp. 259-342) is admirable, as also is the general Introduction (trans. by W. H. Carruth, 1907) to H. Gunkel's valuable commentary. Of recent works bearing upon the subject-matter reference may be made to J. P. Peters, *Early Hebrew Story* (1904), A. R. Gordon, *Early Traditions of Genesis* (1907), and T. K. Cheyne, *Traditions and Beliefs of Ancient Israel* (1907). Special mention must be made of Eduard Meyer and B. Luther, to whose *Die Israeliten und ihre Nachbarstämme* (1906) the present writer is indebted for many valuable suggestions and hints. Fuller bibliographical information will be found in the works already mentioned, in the articles in the *Ency. Bib.* (G. F. Moore), and Hastings's *Dict.* (G. A. Smith), and in the volume by J. Skinner in the elaborate and encyclopaedic *International Critical Series*. (S. A. C.)

GENET, typically a south European carnivorous mammal referable to the *Viverridae* or family of civets, but also taken to include several allied species from Africa. The true genet (*Genetta vulgaris* or *Genetta genetta*) occurs throughout the south of Europe and in Palestine, as well as North Africa. The fur is of a dark-grey colour, thickly spotted with black, and having a dark streak along the back, while the tail, which is nearly as long as the



The Genet (*Genetta vulgaris*).

body, is ringed with black and white. The genet is rare in the south of France, but commoner in Spain, where it frequents the banks of streams, and feeds on small mammals and birds. It differs from the true civets in that the anal pouch is a mere depression, and contains only a faint trace of the highly characteristic odour of the former. In south-western Europe and North Africa it is sought for its soft and beautifully spotted fur. In some parts of Europe, the genet, which is easily tamed, is kept like a cat for destroying mice and other vermin.

GENEVA, a city of Ontario county, New York, U.S.A., at the N. end of Seneca Lake, about 52 m. S.E. of Rochester. Pop. (1890) 7557; (1900) 10,433 (of whom 1916 were foreign-born); (1910 census) 12,446. It is served by the New York Central & Hudson River, and the Lehigh Valley railways, and by the Cayuga & Seneca Canal. It is an attractively built city, and has good mineral springs. Malt, tinware, flour and grist-mill products,

¹ The south of Palestine, if less disturbed by these changes, may well have had access to older authoritative material.

² For Orr's other concessions bearing upon Genesis, see *op. cit.*, pp. 9 seq., 87, 93, and (on J, E, P) 196, 335, 340. These, like the concessions of other apologetic writers, far outweigh the often hypercritical, irrelevant, and superficial objections brought against the literary and historical criticism of Genesis.

boilers, stoves and ranges, optical supplies, wall-paper, cereals, canned goods, cutlery, tin cans and wagons are manufactured, and there are also extensive nurseries. The total value of the factory product in 1905 was \$4,951,964, an increase of 82.3 % since 1900. Geneva has a public library, a city hospital and hygienic institute. It is the seat of the New York State Agricultural Experiment Station and of Hobart College (non-sectarian), which was first planned in 1812, was founded in 1822 (the majority of its incorporators being members of the Protestant Episcopal church) as successor to Geneva Academy, received a full charter as Geneva College in 1825, and was renamed Hobart Free College in 1852 and Hobart College in 1860, in honour of Bishop John Henry Hobart. The college had in 1908-1909 107 students, 21 instructors, and a library of 50,000 volumes and 15,000 pamphlets. A co-ordinate woman's college, the William Smith school for women, opened in 1908, was endowed in 1906 by William Smith of Geneva, who at the same time provided for a Hall of Science and for further instruction in science, especially in biology and psychology. In 1888 the Smith Observatory was built at Geneva, being maintained by William Smith, and placed in charge of Dr William Robert Brooks, professor of astronomy in Hobart College. The municipality owns its water-supply system. Geneva was first settled about 1787 almost on the site of the Indian village of Kanadasaga, which was destroyed in 1779 during Gen. John Sullivan's expedition against the Indians in western New York. It was chartered as a city in 1808.

GENEVA (Fr. *Genève*, Ger. *Genf*, Ital. *Genova*, Late Lat. *Gebenna*, though *Genava* in good Latin), a city and canton of Switzerland, situated at the extreme south-west corner both of the country and of the Lake of Geneva or Lake Lemman. The canton is, save Zug, the smallest in the Swiss Confederation, while the city, long the most populous in the land, is now surpassed by Zürich and by Basel.

The canton has an area of 108.9 sq. m., of which 88.5 sq. m. are classed as "productive" (forests covering 9.9 sq. m. and vineyards 6.8 sq. m., the rest being cultivated land). Of the "unproductive" 20.3 sq. m., 11 are accounted for by that portion of the Lake of Geneva which belongs to the canton. It is entirely surrounded by French territory (the department of Haute Savoie lying to the south, and that of the Ain to the west and the north), save for about 3½ m. on the extreme north, where it borders on the Swiss canton of Vaud. The Rhone flows through it from east to west, and then along its south-west edge, the total length of the river in or within the canton being about 13 m., as it is very sinuous. The turbid Arve is by far its largest tributary (left), and flows from the snows of the chain of Mont Blanc, the only other affluent of any size being the London (right). Market gardens, orchards, and vineyards occupy a large proportion of the soil (outside the city), the apparent fertility of which is largely due to the unremitting industry of the inhabitants. In 1901 there were 6586 cows, 3881 horses, 2468 swine and 2048 bee-hives in the canton. Besides building materials, such as sandstone, slate, &c., the only mineral to be found within the canton is bituminous shale, the products of which can be used for petroleum and asphalt. The broad-gauge railways in the canton have a length of 18½ m., and include bits of the main lines towards Paris and Lausanne (for Bern or the Simplon), while there are also 7½ m. of electric tramways. The canton was admitted into the Swiss Confederation in 1815 only, and ranks as the junior of the 22 cantons. In 1815-1816 it was created by adding to the old territory belonging to the city (just around it, with the outlying districts of Jussy, Genthod, Satigny and Cartigny) 16 communes (to the south and east, including Carouge and Chêne) ceded by Savoy, and 6 communes (to the north, including Versoix), cut off from the French district of Gex.

In 1900 there were, not counting the city, 27,813 inhabitants in the canton, or, including the city, 132,609, the city alone having thus a population of 104,796. (In the following statistics those for the city are enclosed within brackets.) In 1900 this population was thus divided in point of religion: Romanists, 67,162 (49,965), Protestants, 62,400 (52,121), and Jews 1119 (1081).

In point of language 109,741 (84,359) were French-speaking, 13,343 (12,004) German-speaking, and 7345 (6574) Italian-speaking, while there were also 89 (76) Romansch-speaking persons. More remarkable are the results as to nationality: 43,550 (31,607) were Genevese citizens, and 36,415 (30,582) Swiss citizens of other cantons. Of the 52,644 (42,607) foreigners, there were 34,277 (26,018) French, 10,211 (9126) Italians, 4653 (4283) subjects of the German empire, 583 (468) British subjects, 832 (777) Russians, and 285 (251) citizens of the United States of America. In the canton there were 10,821 (5683) inhabited houses, while the number of separate households was 35,450 (28,621). Two points as to these statistics deserve to be noted. The number of foreign residents is steadily rising, for in 1900 there were only 79,965 (62,189) Swiss in all as against 52,644 (42,607) foreigners. One result of this foreign immigration, particularly from France and Italy, has been the rapid increase of Romanists, who now form the majority in the canton, while in the city they were still slightly less numerous than the Protestants in 1900; later (local) statistics give in the Canton 75,400 Romanists to 64,200 Protestants, and in the city 52,638 Romanists to 51,221 Protestants. Geneva has always been a favourite residence of foreigners, though few can ever have expected to hear that the "protestant Rome" has now a Romanist majority as regards its inhabitants. Galiffe (*Genève hist. et archéolog.*) estimates the population in 1356 at 5800, and in 1404 at 6400, in both cases within the fortifications. In 1536 the old city acquired the outlying districts mentioned above, as well as the suburb of St Gervais on the right bank of the Rhone, so that in 1545 the number is given as 12,500, reduced by 1572 to 11,000. After the revocation of the Edict of Nantes (1685) it rose, by 1698, to 16,934. Thenceforward the progress was fairly steady: 18,500 (1711); 24,712 (1782); 26,140 (1789). After the creation of the canton (1815) the numbers were (those for the city are enclosed within brackets) 48,489 (25,289), the city rising in 1837 to 33,714, and in 1843 to 36,452. The result of the Federal censuses (begun in 1850) are as follows: in 1850, 64,146 (42,127); in 1860, 81,876 (59,826); in 1870, 88,791 (65,606); in 1880, 99,712 (76,197), and in 1888, 105,500 (81,407).

The canton comprises 3 administrative districts: the 13 communes on the right bank and the 34 on the left bank each form one, while the city proper, on both sides of the river, forms one district and one commune. From 1815 to 1842 the city and the cantonal government were the same. But at that date the city obtained its independence, and is now ruled by a town council of 41 members, and an executive of 5 members, the election in each case being made direct by the citizens, and the term of office being 4 years. The existing cantonal constitution dates, in most of its main features, from 1847. The legislature or *Grand Conseil* (now composed of 200 members) is elected (in the proportion of 1 member for every 1000 inhabitants or fraction over 500) for 3 years by a direct popular vote, subject (since 1892) to the principles of proportional representation, while the executive or *conseil d'état* (7 members) is elected (no proportional representation) by a popular vote for 3 years. By the latest enactments (one dating from 1905) 2500 citizens can claim a vote ("facultative referendum") as to any legislative project, or can exercise the "right of initiative" as to any such project or as to the revision of the cantonal constitution. The canton sends 2 members (elected by a popular vote) to the Federal *Sonderath*, and 7 to the Federal *Nationalrat*.

The Consistory rules the Established Protestant Church, and is now composed of 31 members, 25 being laymen and 6 (formerly 15) clerics, while the "venerable company of pastors" (pastors actually holding cures) has greatly lost its former importance and can now only submit proposals to the Consistory. The Christian Catholic Church is also "established" at Geneva (since 1873) and is governed by the *conseil supérieur*, composed of 25 lay members and 5 clerics. No other religious denominations are "established" at Geneva. But the Romanists (who form 13 % of the electors) are steadily growing in numbers

Statistics
of canton
and city.

Govern-
ment.

Religion.

and in influence, while the Christian Catholics are losing ground rapidly, the highest number of votes received by a candidate for the *conseil supérieur* having fallen from 5003 in 1874 to 806 in 1890 and 507 in 1906, while they are abandoning the country churches (some were lost as early as 1892) which they had taken from the Romanists in the course of the *Kulturkampf*.

The fairs of Geneva (held 4 times a year) are mentioned as early as 1262, and attained the height of their prosperity about 1450, but declined after Louis XI.'s grants of 1462-1463 in favour of the fairs of Lyons. Among the

chief articles brought to these fairs (which were largely frequented by Italian, French and Swiss merchants) were cloth, silk, armour, groceries, wine, timber and salt, this last coming mainly from Provence. The manufacturers of Geneva formed in 1487 no fewer than 38 gilds, including tailors, hatters, mercers, weavers, tanners, saddle-makers, furriers, shoe-makers, painters on glass, &c. Goldsmiths are mentioned as early as 1290. Printing was introduced in 1478 by Steinschaber of Schweinfurth, and flourished much in the 16th century, though the rigorous supervision exercised by the Consistory greatly hampered the Estiennes (Stephanus) in their enterprises. Nowadays the best known industry at Geneva is that of watchmaking, which was introduced in 1587 by Charles Cusin of Autun, and two years later regulations as to the trade were issued. In 1685 there were in Geneva 100 master watchmakers, employing 300 work-people, who turned out 5000 pieces a year, while in 1760 this trade employed 4000 work-people. Of recent years its prosperity has diminished greatly, so that the watchmaking and jewelry trades in 1902 numbered respectively but 38 and 32 of the 394 establishments in Geneva which were subject to the factory laws. Lately, huge establishments have been constructed for the utilization of the power contained in the Rhone. The local commerce of Geneva is much aided by the fact that the city is nearly entirely surrounded by "free zones," in which no customs duties are levied, though the districts are politically French: this privilege was given to Gex in 1814, and to the Savoyard districts in 1860, when they were also neutralized.

Considering the small size of Geneva, till recently, it is surprising how many celebrated persons have been connected with it as

Celebrated natives or as residents. Here are a few of the principal, special articles being devoted to many of them in this work. In the 16th century, besides Calvin and Bonivard, we have Isaac Casaubon, the scholar; Robert and Henri Estienne, the printers, and, from 1572 to 1574, Joseph Scaliger himself, though but for a short time. J. J. Rousseau is, of course, the great Genevee of the 18th century. At that period, and in the 19th century, Geneva was a centre of light, especially in the case of various of the physical sciences. Among the scientific celebrities were de Saussure, the most many-sided of all; de Candolle and Boissier, the botanists; Alphonse Favre and Necker, the geologists; Marignac, the chemist; Deluc, the physicist, and Plantamour, the astronomer. Charles Bonnet was both a scientific man and a philosopher, while Amiel belonged to the latter class only. Pradier and Chaponnière, the sculptors; Arlaud, Diday and Calame, the artists; Mallet, who revealed Scandinavia to the literary world; Necker, the minister; Sismondi, the historian of the Italian republics; General Dufour, author of the great survey which bears the name of the "Dufour Map," have each a niche in the Temple of Fame. Of a less severe type were Cherbuliez, the novelist; Töpffer, who spread a taste for pedestrianism among Swiss youth; Duchosal, the poet; Marc Monnier, the littérateur; not to mention the names of any persons still living, or of politicians of any date.

The city of Geneva is situated at the south-western extremity of the beautiful lake of the same name, whence the "arrowy Rhone" flows westwards under the seven bridges by which the two halves of the town communicate with each other. To the south is the valley of the Arve (descending from the snows of the Mont Blanc chain), which unites with that of the Rhone a little below the town; while behind the Arve the grey and barren rocks of the Petit Salève rise like a wall, which in turn is overtopped by the distant

and ethereal snows of Mont Blanc. Yet the actual site of the town is not as picturesque as that of several other spots in Switzerland. Though the cathedral crowns the hillock round which clusters the old part of the town, a large portion of the newer town is built on the alluvial flats on either bank of the Rhone. Since the demolition of the fortifications in 1849 the town has extended in every direction, and particularly on the right bank of the Rhone. It possesses many edifices, public and private, which are handsome or elegant, but it has almost nothing to which the memory reverts as a masterpiece of architectural art. It is possible that this is, in part, due to the artistic blight of the Calvinism which so long dominated the town. But, while lacking the mediæval appearance of Fribourg or Bern, or Sion or Coire, the great number of modern fine buildings in Geneva, hotels, villas, &c., gives it an air of prosperity and comfort that attracts many visitors, though on others modern French architecture produces a blinding glare. On the other hand, there are broad quays along the river, while public gardens afford grateful shade.

The cathedral (Protestant) of St Pierre is the finest of the older buildings in the city, but is a second-rate building, though as E. A. Freeman remarks, "it is an excellent example of a small cathedral of its own style and plan, with unusually little later alteration." The hillock on which it rises was no doubt the site of earlier churches, but the present Transitional building dates only from the 12th and 13th centuries, while its portico was built in the 18th century, after the model of the Pantheon at Rome. It contains a few sepulchral monuments, removed from the cloisters (pulled down in 1721), and a fine modern organ, but the historical old bell *La Clémence* has been replaced by a newer and larger one which bears the same name. More interesting than the church itself is the adjoining chapel of the Maccabees, built in the 15th century, and recently restored. Near the cathedral are the arsenal (now housing the historical museum, in which are preserved many relics of the "Escalade" of 1602, including the famous ladders), and the maison de ville or town hall. The latter building is first mentioned in 1448, but most of the present building dates from far later times, though the quaint paved spiral pathway (taking the place of a staircase in the interior) was made in the middle of the 16th century. In the *Salle du Conseil d'État* some curious 15th-century frescoes have lately been discovered, while the old *Salle des Festins* is now known as the *Salle de l'Alabama*, in memory of the arbitration tribunal of 1872. In the 19th-century Tour Baudet, adjoining the Town Hall, are preserved the rich archives of the city. Not far away is the palais de justice, built in 1709 as a hospital, but used as a court house since 1858. On the Île in the Rhone stands the tower (built c. 1219) of the old castle belonging to the bishop. Among the modern buildings we may mention the following: the University (founded in 1559, but raised to the rank of a University in 1873 only), the Athénée, the Conservatoire de Musique, the Victoria Hall (a concert hall, presented in 1904 to the city by Mr Barton, formerly H.B.M.'s Consul), the theatre, the *Salle de la Réformation* (for religious lectures and popular concerts), the Bâtimement Electoral, the Russian church and the new post office. At present the museums of various kinds at Geneva are widely dispersed, but a huge new building in course of construction (1906) will ultimately house most of them. The Musée Rath contains pictures and sculptures; the Musée Fol, antiquities of various dates; the Musée des Arts Décoratifs, *inter alia*, a fine collection of prints; the Musée Industriel, industrial objects and models; the Musée Archéologique, prehistoric and archaeological remains; the Musée d'Histoire Naturelle, scientific collections, and the Musée Epigraphique, a considerable number of inscriptions. Some way out of the town is the Musée Ariana (extensive art collections), left, with a fine park, in 1890 to the city by a rich citizen, Gustave Revilliod. The public library is in the university buildings and contains many valuable MSS. and printed books. Geneva boasts also of a fine observatory and of a number of technical schools (watchmaking, chemistry, medicine, commerce, fine arts, &c.), some of which are really annexes of the university, which in June 1906 was attended by 1158 matriculated students, of whom 903

The city and its buildings.

were non-Swiss, the Russians (475 in number) forming the majority of the foreign students. Geneva is well supplied with charitable institutions, hospitals, &c. Among other remarkable sights of the city may be mentioned the great hydraulic establishment (built 1887-1899) of the *Forces Motrices du Rhône* (turbines), the singular monument set up to the memory of the late duke of Brunswick who left his fortune to the city in 1873, and the Île Jean-Jacques Rousseau now connected with the Point des Bergues. The house occupied by Rousseau is No. 40 in the Grand' Rue, while No. 13 in the same street is on the site of Calvin's house, though not the actual dwelling inhabited by him.

The real name of the city is *Genava*, that being the form under which it appears in almost all the known documents up to the 7th century, A.D., the variation *Genova* (which has led to great confusion with Genoa) being also found in the 6th century. But *Genosa* and *Gebenna* are of later date. The first mention of the city is made by Caesar (*Bell. Gall.* i. 6-7) who tells us that it was the last *oppidum* of the Allobroges, and the nearest to the territory of the Helvetii, with which it was connected by a bridge that, for military reasons, he was forced to destroy. Inscriptions of later date state that it was only a *vicus* of the Viennese province, while mentioning the fact that a gild of boatmen flourished there. But the many Roman remains found on the original site (in the region of the cathedral) of the city show that it must have been of some importance, and that it possessed a considerable commerce. About 400 the *Notitia Galliarum* calls it a *ciuitas* (so that it then had a municipal administration of its own), and reckons it as first among those of the Viennese. Probably this rise in dignity was connected with the establishment of a bishop's see there, the first bishop certainly known, Isaac, being heard of about 400 in a letter addressed by St. Eucherius to Salvius, while, in 450, a letter of St. Leo states that the see was then a suffragan of the archbishopric of Vienne. It is possible that there may be some ground for the local tradition that Christianity was introduced into this region by Dionysius and Paracodus, who successively occupied the see of Vienne, but another tradition that the first bishop was named St. Nazarius rests on a confusion, as that saint belongs to Genoa and not to Geneva.

About the middle of the 5th century A.D. it came into the possession of the Burgundians, who held it as late as 527 (thus leaving no room for any occupation by the Ostrogoths), and in 534 passed into the hands of the Franks. The Burgundian kings seem to have made Geneva one of their principal residences, and the *Notitia* (above named) tells us that the city was *restaurata* by King Gundibald (d. 516) which is generally supposed to mean that he first surrounded it with a wall, the city then comprising little more than the hill on which the present cathedral stands. That building is of course of much later date, but it seems certain that when (c. 513-516) Sigismund, son of King Gundibald, built a stone church on the site, it took the place of an earlier wooden church, constructed on Roman foundations, all three layers being clearly visible at the present day. We know that St. Avitus, archbishop of Vienne (d. 518), preached a sermon (preserved to us) at the dedication of a church at Geneva which had been built on the site of one burnt by the enemy, and the bits of half-burnt wood found in the second of the two layers mentioned above, seem to make it probable that the reference is to Sigismund's church. But Geneva was in no sense one of the great cities of the region, though it is mentioned in the *Antonine Itinerary* and in the *Peutinger Table* (both 4th century A.D.), no doubt owing to its important position on the bank of the Rhone, which then rose to the foot of the hill on which the original city stood. This is no doubt the reason why, apart from some passing allusions (for instance, Charles the Great held a council of war there in 773, on his first journey to Italy), we hear very little about it.

In 1032, with the rest of the kingdom of Burgundy or Arles, it reverted to the emperor Conrad II., who was crowned king at Payerne in 1033, and in 1034 was recognized as such at Geneva by a great assembly of nobles from Germany, Burgundy and Italy, this rather unwilling surrender signifying the union of

those 3 kingdoms. It is said that Conrad granted the temporal sovereignty of the city to the bishop, who, in 1162, was raised to the rank of a prince of the Holy Roman Empire, being elected, from 1215, by the chapter, but, after 1418, named directly by the pope himself.

Like many other prince-bishops, the ruler of Geneva had to defend his rights: without against powerful neighbours, and within against the rising power of the citizens. These struggles constitute the entire political history of Geneva up to about 1535, when a new epoch of unrest opens with the adoption of Protestantism. The first foe without was the family of the counts of the Genevois (the region south of the city and in the neighbourhood of Annecy), who were also "protectors" (*advocati*) of the church of Geneva, and are first heard of in the 11th and 12th centuries. Their influence was probably never stronger than during the rule as bishop (1118-1119) of Guy, the brother of the reigning count. But his successor, Humbert de Grammont, resumed the grants made to the count, and in 1125 by the Accord of Seyssel, the count fully acknowledged the suzerainty of the bishop. A fresh struggle under Bishop Arducius (1135-1185) ended in the confirmation by Frederick Barbarossa, as emperor, of the position of the bishop as subject to no one but himself (1153), this declaration being strengthened by the elevation of the bishop and his successors to the rank of princes of the empire (1162).

In 1250 the counts of Savoy first appear in connexion with Geneva, being mortgagees of the Genevois family, and, in 1263, practically their heirs as "protectors" of the city. It was thus natural that the citizens should invoke the aid of Savoy against their bishop, Robert of the Genevois (1276-1287). But Count Amadeus of Savoy not merely seized (1287) the castle built by the bishops (about 1219) on the Île, but also (1288) the office of *vicedominus* [*vidomne*], the official through whom the bishop exercised his minor judicial rights. The new bishop, William of Confians (1287-1295) could recover neither, and in 1290 had to formally recognize the position of Savoy (which was thus legalized) in his own cathedral city. It was during this struggle that about 1287 (these privileges were finally sanctioned by the bishop in 1309) the citizens organized themselves into a commune or corporation, elected 4 syndics, and showed their independent position by causing a seal for the city to be prepared. The bishop was thus threatened on two sides by foes of whom the influence was rising, and against whom his struggles were of no avail. In 1365 the count obtained from the emperor the office of imperial vicar over Geneva, but the next bishop William of Marcossay (1366-1377: he began the construction of a new wall round the greatly extended city, a process not completed till 1428) secured the withdrawal of this usurpation (1366-1367), which the count finally renounced (1371). One of that bishop's successors, Adhémar Fabri (1385-1388) codified and confirmed all the franchises, rights and privileges of the citizens (1387), this grant being the *Magna Carta* of the city of Geneva. In 1401 Amadeus VIII. of Savoy bought the county of the Genevois, as the dynasty of its rulers had become extinct. Geneva was now surrounded on all sides by the dominions of the house of Savoy.

Amadeus did homage, in 1405, to the bishop for those of the newly acquired lands which he held from the bishop. But, after his power had been strengthened by his elevation (1417) by the emperor to the rank of a duke, and by his succession to the principality of Piedmont (1418, long held by a cadet branch of his house), Amadeus tried to purchase Geneva from its bishop, John of Pierre-Scisé or Rochetaillée (1418-1422). This offer was refused both by the bishop and by the citizens, while in 1420 the emperor Sigismund declared that he alone was the suzerain of the city, and forbade any one to attack it or harm it in any fashion. Oddly enough Amadeus did in the end get hold of the city, for, having been elected pope under the name of Felix V., he named himself to the vacant see of Geneva (1444), and kept it, after his resignation of the Papacy in 1449, till his death in 1451. For the most part of this period he resided in Geneva. From 1451 to 1522 the see was almost continuously held by a cadet of the house of Savoy, which thus treated it as a kind of appanage.

Most probably Geneva would soon have become an integral part of the realms of the house of Savoy had it not been for the appearance of a new protector on the scene—the Swiss confederation. In the early 15th century the town of Fribourg made an alliance with Geneva for commercial purposes (the cloth warehouses of Fribourg at Geneva being enlarged in 1432 and 1465), as the cloth manufactured at Fribourg found a market in the fairs of Geneva (which are mentioned as early as 1262, and were at the height of their prosperity about 1450). The duke, however, was no better inclined towards the Swiss than towards Geneva. He struck a blow at both, when, in 1462–1463, he induced his son-in-law, Louis XI. of France, to forbid French merchants to attend the fairs of Geneva, altering also the days of the fairs at Lyons (established in 1420 and increased in number in 1463) so as to make them clash with those fixed for the fairs of Geneva. This nearly ruined Geneva, which, too, in 1477 had to pay a large indemnity to the Swiss army that, after the defeat of Charles the Bold, duke of Burgundy, advanced to take vengeance on the dominions of his ally, Yolande, dowager duchess of Savoy and sister of Louis XI., as well as on the bishop of Geneva, her brother-in-law. But, after this payment, the bishop made an alliance with the Swiss. A prolonged attempt was made (1517–1530) by the reigning duke of Savoy, Charles III. (1504–1553), to secure Geneva for his family, at first with the help of his bastard cousin John (1513–1522), the last of his house to hold the see. In this struggle the syndic, Philibert Berthelier, succeeded in concluding (1519) an alliance with Fribourg, which, however, had to be given up almost immediately. It split the citizens into two parties; the *Eidgenots* relying on the Swiss, while the *Mamelukes* supported the duke. Berthelier was executed in 1519, and Amé Lévrier in 1524, but Bezançon Hugues (d. 1532) took their place, and in 1526 succeeded in renewing the alliance with Fribourg and adding to it one with Bern. This much enraged the duke, who took active steps against the citizens, and tried (1527) to carry off the bishop, Pierre de la Baume (1522–1544), who soon found it best to make his submission.

The Genevèse, thus abandoned by their natural protector, looked to the Swiss for help. They sent (October 1530) a considerable army to save the city. This armed intervention compelled the duke to sign the treaty of St Julien (19th October) by which he engaged not to trouble the Genevèse any more, agreeing that if he did so the two towns of Fribourg and Bern should have the right to occupy his barony of Vaud. The two towns also, by the decision given as arbitrators at Payerne (30th December 1530), upheld their alliance with Geneva, condemned the duke to pay all the expenses of the war, and confirmed the clause as to their right to occupy Vaud; they also surrounding the exercise of the powers of *vidomnes* by the duke with so many restrictions that in 1532 the duke, after much resistance, formally agreed to recognize the alliance of Geneva with the two towns and not to annoy the Genevèse any more. Thus a legal tie between Geneva and two of the Swiss cantons was established, while the duke did not any longer venture to annoy the Genevèse, as he clung to his fine barony of Vaud. In the course of this struggle (and especially after the last episcopal *vidomne* had left the town in 1526) the municipal authorities of the city greatly developed, a *grand conseil* of 200 members being set up in imitation of those at Bern and at Fribourg, while within the larger assembly there was a *petit conseil* of 60 members for more confidential business. Thus 1530 marks the date at which Geneva became its own mistress within, while allied externally with the Swiss confederation. But hardly had this settlement been reached when a fresh element of discord threatened to wholly upset matters—the adoption of Protestant principles by the city. Just before this event, however, the fortifications were once more (1534) rebuilt (bits still remain) and extended so as to take in several new suburbs, including that of St Gervais on the right bank of the Rhone which, till then, seems to have been unenclosed (1511–1527).

In 1532 William Farel, a Protestant preacher from Dauphiné, who had converted Vaud, &c., to the new belief, first came to Geneva and settled there in 1533. But although Bern supported

the Reform, Fribourg did not, and in 1534 withdrew from its alliance with Geneva, while directly afterwards the duke of Savoy made a fresh attempt to seize the city. On the 10th of August 1535 the Protestant faith was formally adopted by Geneva, but an offer of help from France having been refused, as the city was unwilling to give up any of its sovereign rights, the duke's party continued its intrigues. Finally Bern, fearing that Geneva might fall to France instead of to itself, sent an army to protect the city (January 1536), but, not being able to persuade the citizens to give up their freedom, had to content itself with the conquest of the barony of Vaud and of the bishopric of Lausanne, thus acquiring rich territories, while becoming close neighbours of Geneva (January and March 1536). Meanwhile Farel had been advancing the cause of religious reform, which was definitively adopted on the 21st of May 1536. In July 1536 a French refugee, John Calviu (*q.v.*), came to Geneva for a night, but was detained by Farel who found in him a powerful helper. The opposition party of the *Libertins* succeeded in getting them both exiled in 1538, but, in September 1541, Calvin was recalled (Farel spending the rest of his life at Neuchâtel, where he died 1565) to Geneva. Born in 1509, he was then about 32 years of age. He set up this theocracy in Geneva, and ruled the reorganized republic with a strong hand till his death in 1564, when he was succeeded by the milder Theodore de Beza (1510–1605).

The great blot on Calvin's rule was his intolerance of other thinkers, as exemplified by his burning of Gruet (1547) and of Servetus (1553). But, on the other hand, he founded (1550) the Academy, which, originally meant as a seminary for his preachers, later greatly extended its scope, and in 1873 assumed the rank of a University. The strict rule of Calvin drove out many old Genevèse families, while he caused to be received as citizens many French, Italian and English refugees, so that Geneva became not merely the "Protestant Rome" but also quite a cosmopolitan little city. The Bernese often interfered with the internal affairs of Geneva (while Calvin, a Frenchman, naturally looked towards France), and refused to allow the city to conclude any alliances save with itself. That alliance was finally renewed in 1558, while in 1560 the Romanist cantons made one with the duke of Savoy, a zealous supporter of the old faith. In 1564, after long negotiations, Bern restored to the duke part of its conquests of 1536, viz. Gex, the Genevois and the Chablais, Geneva being thus once more placed amid the dominions of the duke; though by the same treaty (that of Lausanne, October 1564, Calvin having died the preceding May) the alliance of Bern with Geneva was maintained. In 1570 Geneva was included in the alliance concluded by France with Bern and Soleure, while in 1584 Zürich joined Bern in another alliance with Geneva. The struggle widened as Geneva became a pawn in the great attempt of the duke of Savoy to bring back his subjects to the old faith, his efforts being seconded by François de Sales, the "apostle of the Chablais." But the king of France, for political reasons, opposed Savoy, with whom, however, he made peace in 1601: In December 1602 François de Sales was consecrated bishop of Geneva (since 1533 the bishops had lived at Annecy), and a few days later the duke of Savoy made a final attempt to get hold of the city by a surprise attack in the night of 11–12th December 1602 (Old Style), known in history as the "Escalade," as ladders were used to scale the city walls. It was successfully repelled, over 200 of the foe being slain, while 17 Genevèses only perished. Filled with joy at their rescue from this attack, the citizens crowded to their cathedral, where Beza (then 83 years of age) bid them to sing the 124th Psalm which has ever since been sung on the anniversary of this great delivery. The peace of St Julien (21st of July 1603) marked the final defeat of the duke of Savoy in the long struggle waged (since 1290) by his house against the city of Geneva.

In the charter of 1387 we hear only of the *conseil général* (composed of all male heads of families) which acted as the legislature, and elected annually the executive of 4 *syndics*; no doubt this form of rule existed earlier than 1387. Even before 1387 there was also the *petit conseil* or *conseil ordinaire* or *conseil étroit*; a body not recognized by the law, though it became very

powerful; it was composed of the 4 syndics, with several other counsellors, and acted originally as the adviser of the syndics who were legally responsible for the rule of the city. In 1457 we first hear of the Council of the Fifty (re-established in 1502 and later known as the Sixty), and in 1526 of the Council of the Two Hundred (established in imitation of those of Bern and Fribourg), both being summoned in special cases of urgency. The members of both were named by the *petit conseil*, of which, in turn, the members were confirmed or not by the Two Hundred. By the Constitution of 1543 the *conseil général* had only the right of choosing the 4 syndics out of a list of 8 presented by the *petit conseil* and the Two Hundred, which therefore really elected them, subject to a formal approbation on the part of the larger body. This system was slightly modified in 1568, the constitution of that date lasting till 1794. The *conseil général* fell more and more into the background, the members of the other councils gradually obtained the privilege of being irremovable, and the system of co-optation resulted in the creation of a close monopoly of political offices in the hands of a few leading families.

During the 17th and 18th centuries, while the Romanist majority of the Swiss cantons steadily refused to accept Geneva as even a subordinate member of the Confederation, the city itself was distracted on several occasions by attempts of the citizens, as a whole, to gain some share in the aristocratic government of the town, though these attempts were only partially successful. But the last half of the 18th century marks the most brilliant period in the literary history of Geneva, whether as regards natives or resident foreigners, while in the succeeding half century the number of Genevese scientific celebrities is remarkable. In 1794 the effects of the French Revolution were shown in the more liberal constitution granted by the city government. But in 1798 the city was annexed to France and became the capital of the French department of Léman (to be carefully distinguished from the Swiss *canton* of Léman, that is Vaud, of the Helvetic Republic, also set up in 1798), while in 1803, by the Concordat, the ancient bishopric of Geneva was suppressed. On the fall of Napoleon (1813) the city recovered its independence, and finally, in 1815, was received as the junior member of the Swiss confederation, several bits of French and Savoyard territory (as pointed out above) being added to the narrow bounds of the old Genevese Republic in order to give the town some protection against its non-Swiss neighbours.

The constitution of 1814 set up a common form of government for the city and the canton, the city not obtaining its municipal independence till the constitution of 1842. From 1535 to 1798 public worship according to the Romanist form had been strictly forbidden. In 1799 already the first attempts were made to re-establish it, and in 1803 the church of St Germain was handed over to the Romanists. The constitution of 1814, looking forward to the annexation of Romanist districts to the city territory to form the new canton, guaranteed to that body the freedom of worship, at any rate in these newly gained districts. In 1819 the canton (the new portions of which were inhabited mainly by Romanists) was annexed to the bishopric of Lausanne, the bishop in 1821 being authorized to add "and of Geneva" to his episcopal style. After the adventure of the "Escalade" the fortifications were once more strengthened and extended, these works being completed about 1726. But, in 1823, some of the bastions were converted into promenades, while in 1849 the rest of the fortifications were pulled down so as to allow the city to expand and gradually assume its present aspect.

When Geneva recovered its political independence in 1814 a new constitution was drawn up, but it was very reactionary, for there is no mention in it of the sovereignty of the people. It set up a *conseil représentatif* or legislature of 250 members, which named the *conseil d'état* or executive, while it was itself elected by a limited class, for the electoral qualification was the annual payment of direct taxes to the amount of 20 Swiss livres or about 25 shillings. It was not till 1842 that this system, though much criticized, was modified. In the early part of 1841 the "Third of March Association" was formed to watch over the interests of the citizens, and in November of that year the

government was forced by a popular demonstration to summon an *assemblée constituante*, which in 1842 elaborated a new constitution that was accepted by the citizens. Besides bestowing on the city a government distinct from that of the canton, it set up for the latter a *grand conseil* or legislature, and a *conseil d'état* or executive of 13 members, both elected for the term of 4 years. But this constitution did not seem liberal enough to many citizens, so that in 1846 the government gave way to the Radicals, led by James Fazy (1794-1878), who drew up a constitution that was accepted by a popular vote on the 31st of May 1847. It was much more advanced than that of 1842, and in its main features still prevails. From that date till 1864 the Radicals ruled the state, their head, Fazy, being an able man, though extravagant and inclined to absolutism. Under his sway the town was modernized and developed, but the finances were badly administered, and Fazy became more and more a radical dictator. "On voudrait faire de Genève," sighed the conservative, de la Rive, "la plus petite des grandes villes, et pour moi je préfère qu'elle reste la plus grande des petites villes." In 1861 and in 1864 Fazy failed to secure his re-election to the *conseil d'état*, riots followed his defeat, and the Federal troops were forced to intervene so as to restore order.

The Democratic party (liberal-conservative) ruled from 1865 to 1870 and did much to improve the finances of the state. In 1870 the Radicals regained the supremacy under their new chief, Antoine Carteret (1813-1889) and kept it till 1878. This was a period of religious strife, due to the irritation caused by the Vatican council, and the pope's attempt to revive the bishopric of Geneva. Gaspard Mermillod (1824-1891) was named in 1864 *curé* of Geneva, and made bishop of Hebron *in partibus*, acting as the helper of the bishop of Lausanne. Early in 1873 the pope named him "vicar apostolic of Geneva," but he was expelled a few weeks later from Switzerland, not returning till 1883, when he became bishop of Lausanne, being made cardinal in 1890. The Radical government enacted severe laws as to the Romanists in Geneva, and gave privileges to the Christian Catholic Church, which, organized in 1874 in Switzerland, had absorbed the community founded at Geneva by Père Hyacinthe, an ex-Carmelite friar. The Romanists therefore were no longer recognized by the state, and were persecuted in divers ways, though the tide afterwards turned in their favour. The Democrats ruled from 1878 to 1880, and introduced the "Referendum" (1879) into the cantonal constitution, but, their policy of the separation of church and state having been rejected by the people at a vote, they gave way to the Radicals. The Radicals went out in 1889, and the Democrats held the reins of power till 1897, their leader being Gustave Ador. In 1891 they introduced the "Initiative" into the cantonal constitution, and in 1893 the principle of proportional representation so far as regards the *grand conseil*, while Th. Turrettini did much to increase the economical prosperity of the city. In 1897 the Radicals came in again, their leaders being first Georges Favon (1843-1902) till his death, and then Henri Fazy, a distant relative of James and an excellent historian. They attempted to rule by aid of the Socialists, but their power fluctuated as the demands of the Socialists became greater. On the 30th of June 1907 the Genevese, by a popular vote, decided on the separation of Church and State.

AUTHORITIES.—D. Baud-Bovy, *Peintres genevois, 1702-1807* (2 vols., Geneva, 1903-1904); J. T. de Belloc, *Le Cardinal Mermillod* (Fribourg, 1892); M. Besson, *Recherches sur les origines des bûchers de Genève, Lausanne et Sion* (Fribourg, 1906); J. D. Blavignac, *Armorial genevois* (Geneva, 1849), and *Études sur Genève depuis l'antiquité jusqu'à nos jours* (2 vols., Geneva, 1872-1874); Fr. Bonivard, *Chroniques de Genève* (Reprint) (2 vols., Geneva, 1867); F. Borel, *Les Foires de Genève au XV^e siècle* (Geneva, 1892); Ch. Borgeaud, *Histoire de l'université de Genève, 1550-1798* (Geneva, 1900); E. Choisy, *La Théocratie à Genève au temps de Calvin* (Geneva, 1898), and *L'État chrétien Calviniste à Genève au temps de Théodore de Bèze* (Geneva, 1902); F. de Crue, *La Guerre féodale de Genève et l'établissement de la Commune, 1205-1220* (Geneva, 1907); H. Denkinger, *Histoire populaire du canton de Genève* (Geneva, 1905); E. Doumergue, *La Genève Calviniste de Genève* (Geneva, 1905); geographical description of 16th-century Geneva, and forming vol. III. of the author's *Jean Calvin* (Lausanne, 1905); E. Dumant, *Les*

Relations politiques de Genève avec Berne et les Suisses, de 1536 à 1564 (Geneva, 1894); *Documents de l'Escalade de Genève* (Geneva, 1903); G. Fatio and F. Boissonnas, *La Campagne genevoise d'après nature* (Geneva, 1899), and *Genève à travers les siècles* (Geneva, 1900); H. Fazy, *Histoire de Genève à l'époque de l'Escalade, 1568-1603* (Geneva, 1902), and *Les Constitutions de la République de Genève* (to 1847) (Geneva, 1890); J. B. G. Galiffe, *Genève historique et archéologique* (2 vols., Geneva, 1869-1872); J. A. Gautier, *Histoire de Genève* (to 1691) (6 vols., 1896-1903); F. Gribble and J. H. and M. H. Lewis, *Geneva* (London, 1908); J. Jullien, *Histoire de Genève* (new ed., Geneva, 1889); C. Martin, *La Maison de Ville de Genève* (Geneva, 1906); *Mémoires et documents* (publ. by the local Historical Society since 1821); F. Mugnier, *Les Evêques de Genève-Annecy, 1535-1870* (Paris, 1888); *Pierre de Genève, St* (monograph on the cathedral), 4 parts (Geneva, 1891-1899); A. de Montet, *Dictionnaire biographique des Genevois, etc.* (2 vols., Lausanne, 1878); C. L. Perrin, *Les Vieux Quartiers de Genève* (Geneva, 1904); A. Pfelehart, *Die schweizerische Uhrenindustrie* (Leipzig, 1908); *Régiste genevois avant 1312* (Geneva, 1866); *Régistes du conseil de Genève*, vols. i. and ii., 1409-1477 (Geneva, 1900-1906); A. Roget, *Histoire du peuple de Genève depuis la Réforme jusqu'à l'Escalade* (7 vols., from 1535-1568; Geneva, 1870-1883); A. Rillet, *Le Rétablissement du Catholicisme à Genève il y a deux siècles* (Geneva, 1880); P. Vaucher, *Lutte de Genève contre la Savoie, 1517-1530* (Geneva, 1889); *Recueil généalogique suisse* (Geneva) (2 vols., Geneva, 1902-1907). (W. A. B. C.)

GENEVA CONVENTION, an international agreement for the purpose of improving the condition of wounded soldiers of armies in the field, originally adopted at an international conference held at Geneva, Switzerland, in 1864, and afterwards replaced by the convention of July 6, 1906, also adopted at Geneva. This later agreement is the one now known as the Geneva Convention. The conference of 1864 was the result of a movement which sprang from the publication in 1862 of a book entitled *Un Souvenir de Solferino* by Henri Dunant, a Genevese philanthropist, in which he described the sufferings of the wounded at the battle of Solferino with such vivid effect that the subject became forthwith one of public interest. It was energetically taken up by M. Gustave Moynier, whose agitation led to an unofficial congress being held at Geneva in October 1863. This was followed by an official one at Geneva, called by the Swiss government in 1864. The convention which was there signed (22nd August 1864) on behalf of the states represented, afterwards received the adherence of every civilized power.

At a second conference on the same subject, held at Geneva in 1868, a supplementary convention was drawn up, consisting of fourteen additional articles, five of which related to war on land and nine to naval warfare. The additional articles were not, however, ratified by the chief states, and never became operative. The Brussels International Conference (1874) for the codification of the law and customs of war occupied itself with the Geneva Convention and again drew up a number of articles which were submitted to the interested governments. But, as in the case of the additional articles of 1868, no effect was ever given to them.

At the Peace Conference of 1899 Great Britain withdrew her objections to the application of the convention to maritime warfare, and agreed to the adoption of a special convention "adapting to Maritime warfare the principles of the Geneva Convention." A *vœu* was also adopted by the conference expressing the wish that a special conference should be held as soon as possible for the purpose of revising the convention of 1864.

In deference to the above *vœu* the Swiss government in 1901 sounded the other parties to the convention of 1864 as to whether the time had not come to call the proposed special conference, but the replies received did not give much encouragement and the matter was dropped for the time being. By a circular note of the 17th of February 1903, the Swiss government invited all the states which had signed or adhered to the Geneva Convention to send representatives to a conference to be held at Geneva in the following September. Some governments did not accept the invitation in time and the conference had to be postponed. At the beginning of 1904, there being no apparent obstacle, the Swiss government again invited the powers to send delegates to a conference in the following May. Meanwhile war broke out between Russia and Japan and there was again an adjournment. At length in March 1906 an invitation was accepted by thirty-five states, only Turkey, Salvador, Bolivia, Venezuela,

Nicaragua and Colombia abstaining and the conference was held at Geneva in July 1906, when a full revised convention was adopted, which now takes the place of that of 1864.¹ The adoption of the new Geneva Convention entailed a revision of the above-mentioned Hague Convention and a new edition of the latter is one of the documents adopted at the Peace Conference of 1907.

The new Geneva Convention consists of thirty-three articles divided into the following chapters, (i) the wounded and sick; (ii.) medical units and establishments; (iii.) personnel; (iv.) material; (v.) convoys of evacuation; (vi.) the distinctive emblem; (vii.) application and carrying out of the Convention (viii.) prevention of abuses and infractions; (ix.) general provisions.

The essential parts of the new Hague Convention of 1907 (18th of October) adapting the above conventions to maritime warfare are as follows: (N.B. The alterations are in italics. The parts of the older convention of 1864 which have been suppressed are in brackets).

i. Military hospital-ships, that is to say, ships constructed or assigned by states specially and solely for the purpose of assisting the wounded, sick or shipwrecked, and the names of which shall have been communicated to the belligerent powers at the commencement or during the course of hostilities, and in any case before they are employed, shall be respected and cannot be captured while hostilities last.

These ships, moreover, are not on the same footing as men-of-war as regards their stay in a neutral port.

ii. Hospital-ships, equipped wholly or in part at the cost of private individuals or officially-recognized Relief Societies, shall likewise be respected and exempt from capture, provided the belligerent power to whom they belong has given them an official commission and has notified their names to the hostile power at the commencement of or during hostilities, and in any case before they are employed.

These ships should be furnished with a certificate from the competent authorities, declaring that they had been under their control while fitting out and on final departure.

iii. Hospital-ships, equipped wholly or in part at the cost of private individuals or officially-recognized Societies of neutral countries shall be respected and exempt from capture [if the neutral power to whom they belong has given them an official commission and notified their names to the belligerent powers at the commencement of or during hostilities, and in any case before they are employed] on condition that they are placed under the orders of one of the belligerents, with the previous consent of their own Government and with the authorization of the belligerent, and on condition that the latter shall have notified their names to the enemy at the commencement or during the course of hostilities, in any event, before they are employed.

iv. The ships mentioned in Articles i., ii. and iii. shall afford relief and assistance to the wounded, sick and shipwrecked of the belligerents independently of their nationality.

The governments engage not to use these ships for any military purpose.

These ships must not in any way hamper the movements of the combatants.

During and after an engagement they will act at their own risk and peril.

The belligerents will have the right to control and visit them, they can refuse to help them, order them off, make them take a certain course, and put a commissioner on board; they can even detain them, if important circumstances require it.

As far as possible the belligerents shall inscribe in the sailing papers of the hospital-ships the orders they give them.

v. The military hospital-ships shall be distinguished by being painted white outside with a horizontal band of green about a metre and a half in breadth.

The ships mentioned in Articles ii. and iii. shall be distinguished by being painted white outside with a horizontal band of red about a metre and a half in breadth.

The boats of the ships above mentioned, as also small craft which may be used for hospital work, shall be distinguished by similar painting.

All hospital-ships shall make themselves known by hoisting, together with their national flag, the white flag with a red cross provided by the Geneva Convention, and, in addition, if they belong to a neutral State, by hoisting on the mainmast the national flag of the belligerent under whose direction they are placed.

Hospital-ships which, under the terms of Article iv., are detained by

¹ Another International Conference held in December 1904 at the Hague dealt with the status of hospital-ships in time of war. Great Britain did not take part in this Conference. Her abstention, however, was not owing to any objection of principle, but purely to considerations of domestic legislation.

the enemy, must lower the national flag of the belligerent under whom they were acting.

The above-mentioned vessels and boats, desiring at night-time to ensure the respect due to them, shall, with the consent of the belligerent whom they are accompanying, take the necessary steps that the special painting denoting them shall be sufficiently conspicuous.

vi. [Neutral merchantmen, yachts or vessels, having, or taking on board, sick, wounded or shipwrecked of the belligerents, cannot be captured for so doing, but they are liable to capture for any violation of neutrality they may have committed.]

The distinctive signs provided by Article v. can only be used, whether in time of peace or in time of war, to protect ships therein mentioned.

vii. In the case of a fight on board a war-ship, the hospitals shall be respected and shall receive as much consideration as possible.

These hospitals and their belongings are subject to the laws of war, but shall not be employed for any other purpose so long as they shall be necessary for the sick and wounded.

Nevertheless, the commander who has them under his orders, may make use of them in case of important military necessity, but he shall first ensure the safety of the sick and wounded on board.

viii. The protection due to hospital-ships and to hospitals on board war-ships shall cease if they are used against the enemy.

The fact that the crew of hospital-ships, and attached to hospitals on war-ships, are armed for the maintenance of order and for the defence of the sick or wounded, and the existence of a radio-telegraphic installation on board, is not considered as a justification for withdrawing the above-mentioned protection.

ix. Belligerents may appeal to the charitable zeal of commanders of neutral merchant vessels, yachts or other craft, to take on board and look after the sick and wounded.

Ships having responded to this appeal, as well as those who have spontaneously taken on board sick, wounded or shipwrecked men, shall have the advantage of a special protection and of certain immunities. In no case shall they be liable to capture on account of such transport; but subject to any promise made to them they are liable to capture for any violation of neutrality they may have committed.

[vii.] x. The religious, medical or hospital staff of any captured ship is inviolable, and its members cannot be made prisoners of war. On leaving the ship they take with them the objects and surgical instruments which are their own private property.

This staff shall continue to discharge its duties while necessary, and can afterwards leave when the commander-in-chief considers it possible.

The belligerents must guarantee to the staff that has fallen into their hands [the enjoyment of their salaries intact] the same allowances and pay as those of persons of the same rank in their own navy.

[viii.] xi. Sailors and soldiers, and other persons officially attached to navies or armies, who are taken on board when sick or wounded, to whatever nation they belong, shall be [protected] respected and looked after by the captors.

xii. Every vessel of war of a belligerent party may claim the return of the wounded, sick or shipwrecked who are on board military hospital-ships, hospital-ships of aid societies or of private individuals, merchant ships, yachts or other craft, whatever be the nationality of these vessels.

xiii. If the wounded, sick or shipwrecked are received on board a neutral ship of war, it shall be provided, as far as possible, that they may take no further part in war operations.

xiv. The shipwrecked, wounded or sick of one of the belligerents who fall into the hands of the other, are prisoners of war. The captor must decide, according to circumstances, if it is best to keep them or send them to a port of his own country, to a neutral port, or even to a hostile port. In the last case, prisoners thus repatriated cannot serve as long as the war lasts.

xv. The shipwrecked, wounded or sick who are landed at a neutral port with the consent of the local authorities, must, failing a contrary arrangement between the neutral State and the belligerents, be guarded by the neutral State, so that they may not be again able to take part in the military operations.

The expenses of hospital treatment and internment shall be borne by the State to which the shipwrecked, wounded or sick belong. (T. B.A.)

GENEVA, LAKE OF, the largest lake of which any portion belongs to Switzerland, and indeed in central Europe. It is called *Lacus Lemannus* by the old Latin and Greek writers, in 4th century A.D. *Lacus Lausoniis* or *Losaneles*, in the middle ages generally *Lac de Lausanne*, but from the 16th century onwards *Lac de Genève*, though from the end of the 18th century the name *Lac Léman* was revived—according to Prof. Forel *Le Léman* is the proper form. Its area is estimated at 223 sq.m. (Swiss Topographical Bureau) or 225 sq. m. (Forel), of which about 140 sq. m. (134 sq. m. Forel) are politically Swiss (123 sq. m. belonging to the canton of Vaud, 11 sq. m. to that of Geneva, and 5 sq. m. to that of the Valais), the remainder (83 sq. m.) being French since the annexation of Savoy in 1860—the entire lake is included in the territory (Swiss or Savoyard) neutralized by the congress of Vienna in 1815. The French part takes in nearly the whole of

the south shore, save its western and eastern extremities, which belong respectively to Geneva and to the Valais.

The lake is formed by the Rhone, which enters it at its east end, between Villeneuve (E.) and St Gingolph (W.), and quits it at its west end, flowing through the city of Geneva. The only important tributaries are the Drance (S.), the Venoge (N.) and the Veveyse (N.). The form of the lake is that of a crescent, of which the east end is broad and rounded, while the west end tapers towards the city of Geneva. The bird's eye length of the whole lake, from Chillon to Geneva, is 59 m., but along its axis 45 m. The coast-line of the north shore is 59 m. in length and that of the south shore 44½ m. The maximum depth is 1015½ ft., but the mean depth only 500 ft. The surface is 1231½ ft. (Swiss Topog. Bureau) or 1220 ft. (Forel) above sea-level. The greatest width (between Morges and Amphion) is 8½ m., but the normal width is 5 m. The lake forms two well-marked divisions, separated by the strait of Promenthoux, which is 216 ft. in depth, as a bar divides the Grand Lac from the Petit Lac. The Grand Lac includes the greater portion of the lake, the *Petit Lac* (to the west of the strait or bar) being the special Genevese portion of the lake, and having an area of but 30½ sq. m. The unusual blueness of the waters has long been remarked, and the transparency increases the farther we get from the point where the Rhone enters it, the deposits which the river brings down from the Alps gradually sinking to the bottom of the lake. At Geneva we recall Byron's phrase, "the blue rushing of the arrowy Rhone" (*Child Harold*, canto iii, stanza 71). The limit of visibility of a white disk is 33 ft. in winter (in February 1891 Prof. Forel observed an extreme of 70½ ft.) and 21½ ft. in summer. Apart from the seasonal changes in the level of the lake (which is highest in summer, no doubt because of the melting of the Alpine snows that feed the Rhone), there are also the remarkable temporary disturbances of level known as the *seiches*, in which the whole mass of water in the lake rhythmically swings from shore to shore. According to Prof. Forel there are both longitudinal and transverse *seiches*. The effect of the longitudinal *seiches* at Geneva is four times as great as at Chillon, at the other end of the lake, while the extreme duration of this phenomenon is 73 minutes for the unimodal longitudinal *seiches* (35½ minutes for the binodal) and 10 minutes for the transverse *seiches* (5 minutes for the binodal). The maximum height of a recorded *seiche* at Geneva is rather over 6 ft. (October 1841). The currents in the water itself are irregular. The principal winds that blow over the lake are the *bise* (from the N.E.), the *ouedaine* or *Föhn* (from the S.E.), the *sudess* or *vent de pluie* (from the S.W.) and the *iran* (from the N.W.). The storm winds are the *molan* (from the Arve valley towards Geneva) and the *bornan* (from the Drance valley towards the central portion of the lake). The lake is not as rich in fish as the other Swiss lakes, one reason being the obstacle opposed by the Perte du Rhône to fish seeking to ascend that river. Prof. Forel knows of but twenty indigenous species (of which the *Fira*, or *Coregonus fera*, is the principal) and six that have been introduced by man in the 19th century. A number of lake dwellings, of varying dates, have been found on the shores of the lake. The first steamer placed on the lake was the "Guillaume Tell," built in 1823 at Geneva by an Englishman named Church, while in 1873 the present *Compagnie générale de navigation sur le lac Léman* was formed, and in 1875 constructed the first saloon steamer, the "Mont Blanc." But despite this service and the railways along each shore, the red lateen sails of minor craft still brighten the landscape. The railway along the northern shore runs from Geneva past Nyon, Rolle, Morges, Ouchy (the port of Lausanne), Vevey and Montreux to Villeneuve (56½ m.). That on the south shore gains the edge of the lake at Thonon only (22 m. from Geneva), and then runs past Evian and St Gingolph to Le Bouveret (20 m. from Thonon). In the harbour of Geneva two erratic boulders of granite project above the surface of the water, and are named *Pierres du Nilon* (supposed to be altars to Neptune). The lower of the two, which is also the farther from the shore, has been taken as the basis of the triangulation of Switzerland: the official height is 376.86 metres, which in 1891 was reduced to 373.54 metres, though 376.6 metres is now said to be the real figure. Of course the heights given on the Swiss Government map vary with these different estimates of the point taken as basis.

For all matters relating to the lake, see Prof. F. A. Forel's monumental work, *Le Léman* (3 vols., Lausanne, 1892-1904); also (with fine illustrations) G. Fatio and F. Boissonnas, *Ajour du lac Léman* (Geneva, 1902). (W. A. B. C.)

GENEVÈVE, or **GENOVEFA, ST** (c. 422-512), patroness of Paris, lived during the latter half of the 5th century. According to tradition, she was born about 422 at Nanterre near Paris; her parents were called Severus and Gerontia, but accounts differ widely as to their social position. According to the legend, she was only in her seventh year when she was induced by St Germain, bishop of Auxerre, to dedicate herself to the religious life. On the death of her parents she removed to Paris, where she distinguished herself by her benevolence, as well as by her austere life. She is said to have predicted the invasion of the Huns, and

when Attila with his army was threatening the city, she persuaded the inhabitants to remain on the island and encouraged them by an assurance, justified by subsequent events, that the attack would come to nothing (451). She is also said to have had great influence over Childeric, father of Clovis, and in 460 to have caused a church to be built over the tomb of St Denis. Her death occurred about 512 and she was buried in the church of the Holy Apostles, popularly known as the church of St Geneviève. In 1793 the body was taken from the new church, built in her honour by Louis XV., when it became the Panthéon, and burnt on the Place de Grève; but the relics were enshrined in a chapel of the neighbouring church of St Étienne du Mont, where they still attract pilgrims; her festival is celebrated with great pomp on the 3rd of January. The frescoes of the Panthéon by Puvis de Chavannes are based upon the legend of the saint.

BIBLIOGRAPHY.—The main source is the anonymous *Vita s. Genovefæ virginis Parisiorum*, published in 1687 by D. P. Charpentier. The genuineness of this life was attacked by B. Krusch (*Neues Archiv*, 1893 and 1894) and defended by L. Duchesne, *Bibliothèque de l'École des Chartes* (1893), *Bulletin critique* (1897), p. 473. Krusch continued to hold that the life was an 8th-century forgery (*Scriptores rer. Merov.* iii. 204-238). See A. Potthast, *Bibliotheca mediæ ævæ* (1331, 1332), and G. Kurth, *Clovis*, ii. 249-254. The legends and miracles are given in the Bollandists' *Acta Sanctorum*, January 1st; there is a short sketch by Henri Lesêtre, *St Geneviève*, in "Les Saints" series (Paris, 1900).

GENEVIÈVE, GENOVEVA or GENOVEFA, OF BRABANT, heroine of mediæval legend. Her story is a typical example of the widespread tale of the chaste wife falsely accused and repudiated, generally on the word of a rejected suitor. Genovefa of Brabant was said to be the wife of the palatine Siegfried of Treves, and was falsely accused by the majordomo Golo. Sentenced to death she was spared by the executioner, and lived for six years with her son in a cave in the Ardennes nourished by a roe. Siegfried, who had meanwhile found out Golo's treachery, was chasing the roe when he discovered her hiding-place, and reinstated her in her former honour. Her story is said to rest on the history of Marie of Brabant, wife of Louis II., duke of Bavaria, and count-palatine of the Rhine, who was tried by her husband and beheaded on the 18th of January 1256, for supposed infidelity, a crime for which Louis afterwards had to do penance. The change in name may have been due to the cult of St Geneviève, patroness of Paris. The tale first obtained wide popularity in *L'Innocence reconnue, ou vie de Sainte Geneviève de Brabant* (pr. 1638) by the Jesuit René de Cérinier (1603-1662), and was a frequent subject for dramatic representation in Germany. With Genovefa's history may be compared the Scandinavian ballads of *Ravengård* or *Memering*, which exist in many recensions. These deal with the history of Gunild, who married Henry, duke of Brunswick and Schleswig. When Duke Henry went to the wars he left his wife in charge of Ravengård, who accused her of infidelity. Gunild is cleared by the victory of her champion Memering, the "smallest of Christian men." The Scottish ballad of Sir Aldingar is a version of the same story. The heroine Gunhilda is said to have been the daughter of Canute the Great and Emma. She married in 1036 King Henry, afterwards the emperor Henry III., and there was nothing in her domestic history to warrant the legend, which is given as authentic history by William of Malmesbury (*De gestis regum Anglorum*, lib. ii. § 188). She was called Cunigund after her marriage, and perhaps was confused with St Cunigund, the wife of the emperor Henry II. In the *Karlamagnus-saga* the innocent wife is Oliva, sister of Charlemagne and wife of King Hugo, and in the French Carolingian cycle the emperor's wife Sibille (*La Reine Sibille*) or Blancheur (*Macaire*). Other forms of the legend are to be found in the story of Doolin's mother in *Doon de Mayence*, the English romance of *Sir Triamour*, in the story of the mother of Octavian in *Octavian the Emperor*, in the German folk book *Historie von der geduldigen Königin Crescentia*, based on a 12th-century poem to be found in the *Kaiserchronik*; and the English *Erl of Toulouse* (c. 1400). In the last-named romance it has been suggested that the story gives the relations between Bernard I. count of Toulouse, son of the Guillaume d'Orange of the *Carolingian romances*, and the empress Judith, second wife of Louis *le Pieux*.

See F. J. Child, *English and Scottish Popular Ballads*, vol. ii. (1886), art. "Sir Aldingar"; S. Grundtvig, *Danske Kæmpeviser* (Copenhagen, 1867); "Sir Triamore," in *Bishop Percy's Folio MS.*, ed. Hales and Furnivall, vol. ii. (London, 1868); *The Romance of Octavian*, ed. E. M. Goldsmid (Aungervyle Soc., Edinburgh, 1882); *The Erl of Toulouse and the Emperer of Almayn*, ed. G. Lüdtke (Berlin, 1881); B. Seuffert, *Die Legende von der Pfalzgräfin Genovefa* (Würzburg, 1877); B. Goltz, *Pfalzgräfin Genovefa in der deutschen Dichtung* (Leipzig, 1897); R. Köhler, "Die deutsche Volksbücher von der Pfalzgräfin Genovefa," in *Zeitschr. für deutsche Philologie* (1874).

GENGA, GIROLAMO (c. 1476-1551), Italian painter and architect, was born in Urbino about 1476. At the age of ten he was apprenticed to the woollen trade, but showed so much inclination for drawing that he was sent to study under an obscure painter, and at thirteen under Luca Signorelli, with whom he remained a considerable while, frequently painting the accessories of his pictures. He was afterwards for three years with Pietro Perugino, in company with Raphael. He next worked in Florence and Siena, along with Timoteo della Vite; and in the latter city he painted various compositions for Pandolfo Petrucci, the leading local statesman. Returning to Urbino, he was employed by Duke Guidobaldo in the decorations of his palace, and showed extraordinary aptitude for theatrical adornments. Thence he went to Rome; and in the church of S. Caterina da Siena, in that capital, is one of his most distinguished works, "The Resurrection," remarkable both for design and for colouring. He studied the Roman antiquities with zeal, and measured a number of edifices; this practice, combining with his previous mastery of perspective, qualified him to shine as an architect. Francesco Maria della Rovere, the reigning duke of Urbino, recalled Genga, and commissioned him to execute works in connexion with his marriage-festivities. This prince being soon afterwards expelled by Pope Leo X., Genga followed him to Mantua, whence he went for a time to Pesaro. The duke of Urbino was eventually restored to his dominions; he took Genga with him, and appointed him the ducal architect. As he neared the close of his career, Genga retired to a house in the vicinity of Urbino, continuing still to produce designs in pencil; one of the "Conversion of St Paul" was particularly admired. Here he died on the 11th of July 1551. Genga was a sculptor and musician as well as painter and architect. He was jovial, an excellent talker, and kindly to his friends. His principal pupil was Francesco Menozzochi. His own son Bartolommeo (1518-1558) became an architect of celebrity. In Genga's paintings there is a great deal of freedom, and a certain peculiarity of character consonant with his versatile, lively and social temperament. One of his leading works is in the church of S. Agostino in Cesena—a triptych in oil-colours, representing the "Annunciation," "God the Father in Glory," and the "Madonna and Child." Among his architectural labours are the church of San Giovanni Battista in Pesaro; the bishop's palace at Sinigaglia; the façade of the cathedral of Mantua, ranking high among the productions of the 16th century; and a new palace for the duke of Urbino, built on the Monte Imperiale. He was also concerned in the fortifications of Pesaro.

GENISTA, in botany, a genus of about eighty species of shrubs belonging to the natural order Leguminosæ, and natives of Europe, western Asia and North Africa. Three are native in Britain. *G. anglica* is the needle-furze or petty whin, found on heaths and moist moors, a spinous plant with slender spreading branches 1 to 2 ft. long, very small leaves and short racemes of small yellow papilionaceous flowers. The pollen is emitted in a shower when an insect alights on it. *G. tinctoria*, dyer's green-weed, the flowers of which yield a yellow dye, has no spines. Other species are grown on rock-work or as greenhouse plants.

GENIUS (from Lat. *genere, gignere*), a term which originally meant, in Roman mythology, a generative and protecting spirit, who has no exact parallel in Greek religion, and at least in his earlier aspect is of purely Italian origin as one of the deities of family or household. Every man has his genius, who is not his creator, but only comes into being with him and is allotted to him at his birth. As a creative principle the genius is restricted

to man, his place being taken by a Juno (cp. Juno Lucina, the goddess of childbirth) in the case of women. The male and female spirit may thus be distinguished respectively as the protector of generation and of parturition (*iusula generandi, pariendi*), although the female appears less prominent. It is the genius of the *paterfamilias* that keeps the marriage bed, named after him *lectus genialis* and dedicated to him, under his special protection. The genius of a man, as his higher intellectual self, accompanies him from the cradle to the grave. In many ways he exercises a decisive influence on the man's character and mode of life (Horace, *Epistles*, ii. 2. 187). The responsibility for happiness or unhappiness, good or bad fortune, lay with the genius; but this does not suppose the existence of two genii for man, the one good and the other bad (*κρυπτοδαίμων, κακοδαίμων*), an idea borrowed from the Greek philosophers. The Roman genius, representing man's natural optimism, always endeavoured to guide him to happiness; that man was intended to enjoy life is shown by the fact that the Roman spoke of indulging or cheating his genius of his due according as he enjoyed himself or failed to do so, when he had the opportunity. A man's birthday was naturally a suitable occasion for honouring his genius, and on that occasion offerings of incense, wine, garlands, and cakes were made (Tibullus ii. 2; Ovid, *Tristia*, iii. 13. 18). As the representative of a man's higher self and participating in a divine nature, the genius could be sworn by, and a person could take an oath by his own or some one else's genius. When under Greek influence the Roman idea of the gods became more and more anthropomorphized, a genius was assigned to them, not however as a distinct personality. Thus we hear of the genius of Jupiter (Jovis Genio, *C.I.L.* i. 603), Mars, Juno, Pluto, Priapus. In a more extended sense the genius is also the generator and preserver of human society, as manifested in the family, corporate unions, the city, and the state generally. Thus, the genius publicus Populi Romani—probably distinct from the genius Urbis Romae, to whom an old shield on the Capitol was dedicated, with an inscription expressing doubt as to the sex (*Genio . . . sive mas sive femina*)—stood in the forum near the temple of Concord, in the form of a bearded man, crowned with a diadem, and carrying a cornu copiae and sceptre. It frequently appears on the coins of Trajan and Hadrian. Sacrifice, not confined to bloodless offerings like those of the genius of the house, was offered to him annually on the 8th of October. There were genii of cities, colonies, and even of provinces; of artists, business people and craftsmen; of cooks, gladiators, standard-bearers, a legion, a century, and of the army generally (*genius sanctus castrorum peregrinorum totiusque exercitus*). In imperial times the genius of Augustus and of the reigning emperor, as part of the *sacra* of the imperial family, were publicly worshipped. It was a common practice (often compulsory) to swear by the genius of the emperor, and any one who swore falsely was flogged. Localities also, such as theatres, baths, stables, streets, and markets, had their own genius. The word thus gradually lost its original meaning; the nameless local genii became an expression for the universality of the *divinum numen* and were sometimes identified with the higher gods. The local genius was usually represented by a snake, the symbol of the fruitfulness of the earth and of perpetual youth. Hence snakes were usually kept in houses (Virgil, *Aen.* v. 95; Persius l. 113), their death in which was considered a bad omen. The personal genius usually appeared as a handsome youth in a toga, with head sometimes veiled and sometimes bare, carrying a drinking cup and cornu copiae, frequently in the position of one offering sacrifice.

See W. H. Roscher, *Lexikon der Mythologie*, and article by J. A. Hild in Daremberg and Saglio, *Dictionnaire des antiquités*, where full references to ancient and modern authorities are given; L. Preller, *Römische Mythologie*, 3rd ed., by H. Jordan; G. Wissowa, *Religion und Kultur der Römer*.

Apart from the Latin use of the term, the plural "genii" (with a singular "genie") is used in English, as equivalent to the Arabic *jinn*, for a class of spirits, good or bad, such as are described, for instance, in *The Arabian Nights*. But "genius" itself has become the regular English word for the highest

conceivable form of original ability, something altogether extraordinary and beyond even supreme educational prowess, and differing, in kind apparently, from "talent," which is usually distinguished as marked intellectual capacity short only of the inexplicable and unique endowment to which the term "genius" is confined. The attempt, however, to define either quality, or to discriminate accurately between them, has given rise to continual controversy, and there is no agreement as to the nature of either; and the commonly quoted definitions of genius—such as Carlyle's "transcendent capacity of taking trouble, first of all,"¹ in which the last three words are usually forgotten—are either admittedly incomplete or are of the nature of epigrams. Nor can it be said that any substantial light has been thrown on the matter by the modern physiological school, Lombroso and others, who regard the eccentricity of genius as its prime factor, and study it as a form of mental derangement. The error here is partly in ignoring the history of the word, and partly in misrepresenting the nature of the fact. There are many cases, no doubt, in which persons really insane, of one type or another, or with a history of physical degeneration or epilepsy, have shown remarkable originality, which may be described as genius, but there are at least just as many in whom no such physical abnormality can be observed. The word "genius" itself however has only gradually been used in English to express the degree of original greatness which is beyond ordinary powers of explanation, *i.e.* far beyond the capacity of the normal human being in creative work; and it is a convenient term (like Nietzsche's "superman") for application to those rare individuals who in the course of evolution reveal from time to time the heights to which humanity may develop, in literature, art, science, or administrative life. The English usage was originally derived, naturally enough, from the Roman ideas contained in the term (with the analogy of the Greek *δαίμων*), and in the 16th and 17th centuries we find it equivalent simply to "distinctive character or spirit," a meaning still commonly given to the word. The more modern sense is not even mentioned in Johnson's *Dictionary*, and represents an 18th-century development, primarily due to the influence of German writers; the meaning of "distinctive natural capacity or endowment" had gradually been applied specially to creative minds such as those of poets and artists, by contrast with those whose mental ability was due to the results of education and study, and the antithesis has extended since, through constant discussions over the attempt to differentiate between the real nature of genius and that of "talent," until we now speak of the exceptional person not merely as having genius but as "a genius." This phraseology appears to indicate some reversion to the original Roman usage, and the identification of the great man with a generative spirit. Modern theories on the nature of "genius" should be studied with considerable detachment, but there is much that is interesting and thought-provoking in such works as J. F. Nisbet's *Insanity of Genius* (1891), Sir Francis Galton's *Hereditary Genius* (new ed., 1892), and C. Lombroso's *Man of Genius* (Eng. trans., 1891).

GENLIS, STÉPHANIE-FÉLICITÉ DU CREST DE SAINT-AUBIN, COMTESSE DE (1746-1830), French writer and educator, was born of a noble but impoverished Burgundian family, at Champcéry, near Autun, on the 25th of January 1746. When six years of age she was received as a canoness into the noble chapter of Alix, near Lyons, with the title of Madame la Comtesse de Lancy, taken from the town of Bourbon-Lancy. Her entire education, however, was conducted at home. In 1758, in Paris, her skill as a harpist and her vivacious wit speedily attracted admiration. In her sixteenth year she was married to Charles Brûlard de Genlis, a colonel of grenadiers, who afterwards became marquis de Sillery, but this was not allowed to interfere with her determination to remedy her incomplete education, and to satisfy a taste for acquiring and imparting knowledge. Some years later, through the influence of her aunt, Madame de Montesson, who had been clandestinely married to the duke of Orleans, she entered the Palais Royal as lady-in-waiting to the duchess of Chartres (1770). She acted with great energy and zeal as governess to the daughters of the family, and was in 1780

¹ Frederick the Great, iv. 160.

appointed by the duke of Chartres to the responsible office of *gouverneur* of his sons, a bold step which led to the resignation of all the tutors as well as to much social scandal, though there is no reason to suppose that the intellectual interests of her pupils suffered on that account. The better to carry out her ingenious theories of education, she wrote several works for their use, the best known of which are the *Théâtre d'éducation* (4 vols., 1779-1780), a collection of short comedies for young people, *Les Annales de la vertu* (2 vols., 1781) and *Adèle et Théodore* (3 vols., 1782). Sainte-Beuve tells how she anticipated many modern methods of teaching. History was taught with the help of magic lantern slides and her pupils learnt botany from a practical botanist during their walks. In 1789 Madame de Genlis showed herself favourable to the Revolution, but the fall of the Girondins in 1793 compelled her to take refuge in Switzerland along with her pupil Mademoiselle d'Orléans. In this year her husband, the marquis de Sillery, from whom she had been separated since 1782, was guillotined. An "adopted" daughter, Pamela, had been married to Lord Edward Fitzgerald (*q.v.*) in the preceding December.

In 1794 Madame de Genlis fixed her residence at Berlin, but, having been expelled by the orders of King Frederick William, she afterwards settled in Hamburg, where she supported herself for some years by writing and painting. After the revolution of 18th Brumaire (1799) she was permitted to return to France, and was received with favour by Napoleon, who gave her apartments at the arsenal, and afterwards assigned her a pension of 6000 francs. During this period she wrote largely, and produced, in addition to some historical novels, her best romance, *Mademoiselle de Clermont* (1802). Madame de Genlis had lost her influence over her old pupil Louis Philippe, who visited her but seldom, although he allowed her a small pension. Her government pension was discontinued by Louis XVIII., and she supported herself largely by her pen. Her later years were occupied largely with literary quarrels, notably with that which arose out of the publication of the *Diners du Baron d'Holbach* (1822), a volume in which she set forth with a good deal of sarcastic cleverness the intolerance, the fanaticism, and the eccentricities of the "philosophes" of the 18th century. She survived until the 31st of December 1830, and saw her former pupil, Louis Philippe, seated on the throne of France:

The numerous works of Madame de Genlis (which considerably exceed eighty), comprising prose and poetical compositions on a vast variety of subjects and of various degrees of merit, owed much of their success to adventitious causes which have long ceased to operate. They are useful, however (especially the voluminous *Mémoires inédits sur le XVIII^e siècle*, 10 vols., 1825), as furnishing material for history. Most of her writings were translated into English almost as soon as they were published. A list of her writings with useful notes is given by Quérard in *La France littéraire*. Starting light was thrown on her relations with the duc de Chartres by the publication (1904) of her correspondence with him in *L'Idylle d'un "gouverneur"* by G. Maugras. See also Sainte-Beuve, *Causeries du lundi*, vol. iii.; H. Austin Dobson, *Four Frenchwomen* (1890); L. Chabaud, *Les Précurseurs du féminisme* (1901); W. de Chabreuil, *Gouverneur de princes, 1737-1830* (1906); and *Lettres inédites à . . . Casimir Baecher, 1802-1830* (1902), edited by Henry Lapaue.

GENNA, a word of obscure origin borrowed from the Assamese, and used technically by anthropologists to describe a class of social and religious ordinances based on sanctions which derive their validity from a vague sense of mysterious danger which results from disobedience to them. These prohibitions—or system of things forbidden—affect the relations, permanent and temporary, of individuals (either as members of a tribe, village, clan or household, or as occupying an official position in the village or clan) towards other persons or groups of persons and towards material objects which possess intrinsic sanctity. The term is extended to the communal rites performed by the village, clan or household, either as magical ceremonies or as prophylactics on special occasions when the social, commensal, conjugal and alimentary relations of the group affected are subjected to temporary modifications. These practices and beliefs are observed among the hill tribes of Assam from the Abors and Mishmis on the north to the Lusheis on the south, all linguistically members

¹ See Gerald Campbell, *Edward and Pamela Fitzgerald* (1905).

of the Tibeto-Burman group, and among the Khasis, members of the Mon-Khmer group. Genna and taboo (*q.v.*) are products of an identical level of culture and similar psychological processes, and provide the mechanism of the social and religious systems.

Permanent Gennas.—The only universal genna is that which forbids the intermarriage of members of the same clan. In some cases in Manipur animals are genna to the tribe—i.e. they must not be killed or eaten—but tribal differentiation is, in practice, based on dialectical distinctions rather than on tribal gennas. The village as such possesses no permanent gennas, but the clans, as the units of marriage under the law of exogamy, have distinct elementary gennas, especially the clan to which the priest-chief belongs. The most important individual gennas are those which protect the priest-chief from impurity or contact with "sacred" substances such as the flesh of animals used in sacrifices. He may neither eat in a strange house, nor utter words of abuse, nor take an oath in a dispute, except in his representative capacity on behalf of his village. The first-fruits are genna to the village until he eats, thus establishing an opposition between him and his co-villagers. Married and unmarried women are subject to alimentary gennas; thus unmarried girls are forbidden the flesh of any male animal or of any female animal dying gravid.

Ritual Gennas.—Ritual gennas are held annually to foster the rice crops, all other industries and activities being genna (forbidden) during the cultivating season, to secure good hunting, to avert sickness, especially epidemics, to take omens, and to lay finally to rest the ghosts of all that have died within the year. The village gates are closed, men and women eat apart, and conjugal relations are suspended. Special village gennas are held when rain is needed, when a villager dies in any manner out of the ordinary, as women in childbirth, when an animal gives birth to still-born offspring, and when any permanent genna has been violated. Clan gennas are held for all ordinary cases of death. Household gennas are held on the occasions of birth (when the aliment and conduct of the father are specially regulated), naming, ear-piercing, the first hair-cutting, sickness, and, in certain areas, tattooing. Individuals are subjected to temporary gennas as warriors both before and after a head-hunting raid, pregnant women, married persons at the beginning of their married life, the wives of the priest-chief, and those who from ambition or pride of wealth seek to perpetuate their names by erecting a stone monument, an act which confers the right to wear the distinctive clothes of the priest-chief which otherwise are genna to the whole village. Ritual gennas are of varying duration. Some last for a month while others are complete in two days. As religious or magical rites, they prevent danger or establish and restore normal relations with powers which are potentially harmful or require placation.

AUTHORITIES.—Official records of the government of India, Nos. 23 (1855), 27 (1859), 68 (1870); Colonel T. H. Lewin, *Hill Tracts of Chittagong; Report on the Census of Assam* (1891), vol. I. Report, note by A. W. Davis, p. 237 seq.; Major P. R. T. Curdon, *The Khasis* (1907); T. C. Hodson, *Journal of the Royal Anthropological Institute*, vol. xxxvi. (1906), (T. C. H.)

GENNADIUS II. [as layman GEORGIOS SCHOLARIOS] (d. c. 1468), patriarch of Constantinople from 1454 to 1456, philosopher and theologian, was one of the last representatives of Byzantine learning. Extremely little is known of his life, but he appears to have been born at Constantinople about 1400 and to have entered the service of the emperor John VII. Paleologus as imperial judge or counsellor. Georgios first appears conspicuously in history as present at the great council held in 1438 at Ferrara and Florence with the object of bringing about a union between the Greek and Latin Churches. At the same council was present the celebrated Platonist, Gemistus Pletho, the most powerful opponent of the then dominant Aristotelianism, and consequently the special object of reprobation to Georgios. In church matters, as in philosophy, the two were opposed.—Pletho maintaining strongly the principles of the Greek Church, and being unwilling to accept union through compromise, while Georgios, more politic and cautious, pressed the necessity for union and was instrumental in drawing up a form which from its vagueness and ambiguity might be accepted by both parties.

He was at a disadvantage because, being a layman, he could not directly take part in the discussions of the council. But on his return to Greece his views changed, and he violently and obstinately opposed the union he had previously urged. In 1448 he became a monk at Pantokrator and took the name Gennadius. In 1453, after the capture of Constantinople by the Turks, Mahommed II., finding that the patriarchal chair had been vacant for some time, resolved to elect some one to the office, and the choice fell on Gennadius. While holding the episcopal office Gennadius drew up, apparently for the use of Mahommed, a lucid confession or exposition of the Christian faith, which was translated into Turkish by Ahmed, judge of Beroea, and first printed by A. Brassicanus at Vienna in 1530. After a couple of years Gennadius found the position of patriarch under a Turkish sultan so irksome that he retired to the monastery of John the Baptist near Serree in Macedonia, where he died about 1468. About one hundred of his alleged writings exist, the majority in manuscript and of doubtful authenticity.

The fullest account of his writings is given in Gass, *Gennadius and Pseudo* (Berlin, 1844), the second part of which contains Pletho's *Contro Gennadium*. See also F. Schultze, *Gesch. der Phil. d. Renaissance*, I. (1874). A list of the known writings of Gennadius is given in Fabricius, *Bibliotheca Graeca*, ed. Harles, vol. xi., and what has been printed is to be found in Migne, *Patrol. Gr.* vol. cix.

GENOA (anc. *Genua*, Ital. *Genova*, Fr. *Gènes*), the chief port of Liguria, Italy, and capital of the province of Genoa, 119 m. N.W. of Leghorn by rail. Pop. (1906) 255,294 (town); 267,248 (commune). The town is situated on the Gulf of Genoa, and is the chief port and commercial town of Italy, the seat of an archbishop and a university, the headquarters of the IV. Italian army corps, and a strong fortress. The city, as seen from the sea, is "built nobly," and deserves the title it has acquired or assumed of the Superb. Finding only a small space of level ground along the shore, it has been obliged to climb the lower hills of the Ligurian Alps, which afford many a coign of vantage for the effective display of its architectural magnificence. The original nucleus of the city is that portion which lies to the east of the port in the neighbourhood of the old pier (Molo Vecchio). In the 10th century it began to feel a lack of room within the limits of its fortifications; and accordingly, in the middle of the 12th century, it was found necessary to extend the line of circumvallation. Even this second circuit, however, was of small compass, and it was not till 1320-1330 that a third line took in the greater part of the modern site of the city proper. This presented about 3 m. of rampart towards the land side, and can still be easily traced from point to point through the city, though large portions, especially towards the east, have been dismantled. The present line of circumvallation dates from 1626-1632, the period when the independence of Genoa was threatened by the dukes of Savoy. From the mouth of the Bisagno in the east, and from the lighthouse point in the west, it stretches inland over hill and dale to the great fort of Sperrone, i.e. the Spur, on the summits of Monte Peraldo at a height of 1650 ft.,—the circuit being little less than 12 m., and all the important points along the line being defended by forts or batteries.

A portion of the enclosed area is open country, dotted only here and there with houses and gardens. There are eight gates, the more important being Porta Pila and Porta Romana towards the east, and the Porta Lanterna or Lighthouse Gate to the west. The main architectural features of Genoa are its medieval churches, with striped façades of black and white marble, and its magnificent 16th-century palaces. The earlier churches of Genoa show a mixture of French Romanesque and the Pisan style—they are mostly basilicas with transepts, and as a rule a small dome; the pillars are sometimes ancient columns, and sometimes formed of alternate layers of black and white marble. The façades are simple, without galleries, having only pilasters projecting from the wall, and are also alternately black and white. This style continued in Gothic times also. The oldest is S. Maria di Castello (11th century), the columns and capitals of which are almost all antique. S. Cosma, S. Donato (with remains of the 10th-century building) and others belong to the

11th century, and S. Giovanni di Prè, S. Agostino (with a fine campanile), S. Stefano, S. Matteo and others to the 13th. The famous painting of the martyrdom of S. Stephen, by Giulio Romano, carried off by Napoleon in 1811, was restored to S. Stefano in 1815. S. Matteo, the church of the D'Orta or Doria family, was founded in 1126 by Martino Doria. The façade dates from 1278, and the interior of the edifice dates in the main from 1543. In the crypt is the tomb of Andrea Doria by Montorsoli, and above the main altar hangs the dagger presented to the doge by Pope Paul III. To the left of the church is an exquisite cloister of 1308 with double columns, in which a number of inscriptions relating to the Doria family and also the statue of Andrea Doria by Montorsoli are preserved. The little square in front of the church is surrounded by Gothic palaces of the Doria family. Of the churches the principal is the comparatively small cathedral of S. Lorenzo. Tradition makes its first foundation contemporary with St Lawrence himself; and a document of 987 implies that it was even then the metropolitan church. Reconstructed about the end of the 11th and beginning of the 12th century, it was formally consecrated by Pope Gelastus II. on the 18th of October 1118; and since then it has undergone a large number of extensive though partial renovations. The façade, with its three elaborate doorways, belongs to the 14th century and is a copy of French models of the 13th. The two side portals with Romanesque sculptures belong to the 12th-14th centuries. Some pagan reliefs are built into the tower. The interior was rebuilt in 1307, the old columns being used. The belfry, which rises above the right-hand doorway, was erected about 1520 by the doge, Ottaviano da Campofragnoso, and the cupola was erected after the designs of the architect Galeazzo Alessi in 1567. The fine Early Renaissance (1448) sculptural decorations of the chapel of S. John the Baptist were due to Domenico Gagini of Bisone on the Lake of Lugano, who later transferred his activities to Naples and Palermo, and other Lombard masters. An edict of Innocent VIII. forbids women to enter the chapel except on one day in the year. In the treasury of the cathedral is a magnificent silver monstrance dating from 1553, and an octagonal bowl, the Sacro Catino, brought from Caesarea in 1201, which corresponds to the descriptions given of the Holy Grail, and was long regarded as an emerald of matchless value, but was found when broken at Paris, whither it had been carried by Napoleon I., to be only a remarkable piece of ancient glass. The choir-stalls are a very fine work of the 15th century and later, with intarsias. Near the cathedral is a small 12th-century (?) cloister.

Of older date than the cathedral is the church of S. Ambrose and S. Andrew, if its first foundation be correctly assigned to the Milanese bishop Honoratus of the 6th century; but the present edifice is due to the Society of Jesus, who obtained possession of the church in 1587. The interior is richly decorated and contains the "Circumcision" and "St Ignatius" by Rubens, and the "Assumption" of Guido Reni. The Annunziata del Guastato is one of the largest churches in the city, erected in 1587. It is a cruciform structure, with a dome, and the central nave is supported by fourteen Corinthian columns of white marble. To the otherwise unfinished brick façade a portal borne by marble columns was added in 1843. The interior is covered with gilding and frescoes of the 17th century, and is somewhat overloaded with rich decoration, while a range of white marble columns supports the nave. Santa Maria delle Vigne probably dates from the 9th century, but the present structure was erected in 1586. The campanile, however, is a remarkable work of the 13th century. Adjoining the church is a ruined cloister of the 11th century. San Siro, originally the "Church of the Apostles" and the cathedral of Genoa, was rebuilt by the Benedictines in the 11th century, and restored and enlarged by the Theatines in 1576, the façade being added in 1830; in this church in 1339 Simone Boccanera was elected first doge of Genoa. Santa Maria di Carignano, or more correctly Santa Maria Assunta e SS. Fabiano e Sebastiano, belongs mainly to the 16th century, and was designed by Galeazzo Alessi, in imitation of Bramante's plan for S. Peter's at Rome, as it was then being executed by

mainly in Corsica, formed during this period the most stable element in the state, until in 1528 the national spirit appeared to regain its ancient vigour when Andrea Doria succeeded in throwing off the French domination and restoring the old form of government. It was at this very period—the close of the 15th and commencement of the 16th century—that the genius and daring of a Genoese mariner, Christopher Columbus, gave to Spain that new world, which might have become the possession of his native state, had Genoa been able to supply him with the ships and seamen which he so earnestly entreated her to furnish. The government as restored by Andrea Doria, with certain modifications tending to impart to it a more conservative character, remained unchanged until the outbreak of the French Revolution and the creation of the Ligurian republic. During this long period of nearly three centuries, in which the most dramatic incident is the conspiracy of Fieschi, the Genoese found no small compensation for their lost traffic in the East in the vast profits which they made as the bankers of the Spanish crown and outfitters of the Spanish armies and fleets both in the old world and the new, and Genoa, more fortunate than many of the other cities of Italy, was comparatively immune from foreign domination.

At the end of the 17th century the city was bombarded by the French, and in 1746, after the defeat of Piacenza, surrendered to the Austrians, who were, however, soon driven out. A revolt in Corsica, which began in 1729, was suppressed with the help of the French, who in 1768 took possession of the island for themselves (see *CORSICA: History*).

The short-lived Ligurian republic was soon swallowed up in the French empire, not, however, until Genoa had been made to experience, by the terrible privations of the siege when Masséna held the city against the Austrians (1800), all that was meant by a participation in the vicissitudes of the French Revolution. In 1814 Genoa rose against the French, on the assurance given by Lord William Bentinck that the allies would restore to the republic its independence. It had, however, been determined by a secret clause of the treaty of Paris that Genoa should be incorporated with the dominions of the king of Sardinia. The discontent created at the time by the provision of the treaty of Paris as confirmed by the congress of Vienna had doubtless no slight share in keeping alive in Genoa the republican spirit which, through the influence of a young Genoese citizen, Joseph Mazzini, assumed forms of permanent menace not only to the Sardinian monarchy but to all the established governments of the peninsula. Even the material benefits accruing from the union with Sardinia and the constitutional liberty accorded to all his subjects by King Charles Albert were unable to prevent the republican outbreak of 1848, when, after a short and sharp struggle, the city, momentarily seized by the republican party, was recovered by General Alfonso La Marmora.

Among the earlier Genoese historians the most important are Bartolomeo Fazio and Jacopo Braccelli, both of the 15th century, and Paolo Partenopeo, Jacopo Bonifacio, Oberto Foglietta and Agostino Giustiniano of the 16th. Paganetti wrote the ecclesiastical history of the city; and Accinelli and Gaggero collected material for the ecclesiastical archaeology. The memoirs of local writers and artists were treasured by Soprani and Ratti. Among more general works are Bréquigny, *Histoire des révolutions de Gênes jusqu'en 1748*; Serra, *La Storia dell' antica Liguria e di Genova* (Turin, 1834); Varese, *Storia della repubblica di Genova sino al 1814* (Genoa, 1835-1839); Canale, *Storia dei Genovesi* (Genoa, 1844-1854), *Nuova storia della repubblica di Genova* (Florence, 1858), and *Storia della rep. di Genova dall' anno 1528 al 1550* (Genoa, 1874); Blumenthal, *Zur Verfassungsgeschichte Genoa's im 12ten Jahrhundert* (Kalbe an der Saale, 1872); Malletson, *Studies from Genoese History* (London, 1875). The *Liber jurisjur. respublicae Genuesis* was edited by Ricotti in the 7th, 8th and 9th volumes of the *Monumenta historiae patriae* (Turin, 1854-1857). A great variety of interesting matter will be found in the *Atti della Società Ligure di storia patria* (1861-809), and in the *Giornale Ligustico di archeologia, storia, e belle arti*. The history of the university has been written by Lorenzo Isaardi, and continued by Em. Celesia (2 vols., Genoa), (T. As.)

GENOVESI, ANTONIO (1712-1769), Italian writer on philosophy and political economy, was born at Castiglione, near Salerno, on the 1st of November 1712. He was educated for the church, and, after some hesitation, took orders in 1736 at Salerno,

where he was appointed professor of eloquence at the theological seminary. During this period of his life he began the study of philosophy, being especially attracted by Locke. Dissatisfied with ecclesiastical life, Genovesi resigned his post, and qualified as an advocate at Rome. Finding law as distasteful as theology, he devoted himself entirely to philosophy, of which he was appointed extraordinary professor in the university of Naples. His first works were *Elementa Metaphysicae* (1743 et seq.) and *Logica* (1745). The former is divided into four parts, Ontosophy, Cosmosophy, Theosophy, Psychosophy, supplemented by a treatise on ethics and a dissertation on first causes. The *Logic*, an eminently practical work, written from the point of view of Locke, is in five parts, dealing with (1) the nature of the human mind, its faculties and operations; (2) ideas and their kinds; (3) the true and the false, and the various degrees of knowledge; (4) reasoning and argumentation; (5) method and the ordering of our thoughts. If Genovesi does not take a high rank in philosophy, he deserves the credit of having introduced the new order of ideas into Italy, at the same time preserving a just mean between the two extremes of sensualism and idealism. Although bitterly opposed by the partisans of scholastic routine, Genovesi found influential patrons, amongst them Bartolomeo Intieri, a Florentine, who in 1754 founded the first Italian or European chair of political economy (commerce and mechanics), on condition that Genovesi should be the first professor, and that it should never be held by an ecclesiastic. The fruit of Genovesi's professorial labours was the *Lezioni di Commercio*, the first complete and systematic work in Italian on economics. On the whole he belongs to the "Mercantile" school, though he does not regard money as the only form of wealth. Specially noteworthy in the *Lezioni* are the sections on human wants as the foundation of economical theory, on labour as the source of wealth, on personal services as economic factors, and on the united working of the great industrial functions. He advocated freedom of the corn trade, reduction of the number of religious communities, and deprecated regulation of the interest on loans. In the spirit of his age he denounced the relics of medieval institutions, such as entails and tenures in mortmain. Gioja's more important treatise owes much to Genovesi's lectures. Genovesi died on the 22nd of September 1769.

See C. Ugoni, *Della letteratura italiana nella seconda metà del secolo XVIII* (1820-1822); A. Fabroni, *Vitae Italorum doctrina excellentium* (1778-1799); R. Bobba, *Commemorazione di A. Genovesi* (Benevento, 1867).

GENSONNÉ, ARMAND (1758-1793), French politician, the son of a military surgeon, was born at Bordeaux on the 10th of August 1758. He studied law, and at the outbreak of the Revolution was an advocate of the parlement of Bordeaux. In 1790 he became *procureur* of the Commune, and in July 1791 was elected by the newly created department of the Gironde a member of the court of appeal. In the same year he was elected deputy for the department to the Legislative Assembly. As reporter of the diplomatic committee, in which he supported the policy of Brissot, he proposed two of the most revolutionary measures passed by the Assembly: the decree of accusation against the king's brothers (January 1, 1792), and the declaration of war against the king of Bohemia and Hungary (April 20, 1792). He was vigorous in his denunciations of the intrigues of the court and of the "Austrian committee"; but the violence of the extreme democrats, culminating in the events of the 10th of August, alarmed him; and when he was returned to the National Convention, he attacked the Commune of Paris (October 24 and 25). At the trial of Louis XVI. he supported an appeal to the people, but voted for the death sentence. As a member of the Committee of General Defence, and as president of the Convention (March 7-11, 1793), he shared in the bitter attacks of the Girondists on the Mountain; and on the fatal day of the 2nd of June his name was among the first of those inscribed on the prosecution list. He was tried by the Revolutionary Tribunal on the 24th of October 1793, condemned to death and guillotined on the 31st of the month, displaying on the scaffold a stoic fortitude. Gensonné was accounted one of the most brilliant of the little band of brilliant

orators from the Gironde, though his eloquence was somewhat cold and he always read his speeches.

GENTIAN, botanically *Gentiana*, a large genus of herbaceous plants belonging to the natural order Gentianaceae. The genus comprises about 300 species,—most of them perennial plants with tufted growth, growing in hilly or mountainous districts, chiefly in the northern hemisphere, some of the blue-flowered species ascending to a height of 16,000 ft. in the Himalaya Mountains. The leaves are opposite, entire and smooth, and often strongly ribbed. The flowers have a persistent 4- to 5-lobed calyx and a 4- to 5-lobed tubular corolla; the stamens are equal in number to the lobes of the corolla. The ovary is one-celled, with two stigmas, either separate and rolled back or contiguous and funnel-shaped. The fruit when ripe separates into two valves, and contains numerous small seeds. The majority of the genus are remarkable for the deep or brilliant blue colour of their blossoms, comparatively few having yellow, white, or more rarely red flowers; the last are almost exclusively found in the Andes.

Only a few species occur in Britain. *G. amarella* (felwort) and *G. campestris* are small annual species growing on chalky or calcareous hills, and bear in autumn somewhat tubular pale purple flowers; the latter is most easily distinguished by having two of the lobes of the calyx larger than the other two, while the former has the parts of the calyx in fives, and equal in size. Some intermediate forms between these two species occur, although rarely, in England; one of these, *G. germanica*, has larger flowers of a bluer tint, spreading branches, and a stouter stem. Some of these forms flower in spring. *G. pneumonanthe*, the Calathian violet, is a rather rare perennial species, growing in moist heathy places from Cumberland to Dorsetshire. Its average height is from 6 to 9 in. It has linear leaves, and a bright blue corolla $1\frac{1}{2}$ in. long, marked externally with five greenish bands, is without hairs in its throat, and is found in perfection about the end of August. It is the handsomest of the British species; two varieties of it are known in cultivation, one with spotted and the other with white flowers. *G. verna* and *G. nivalis* are small species with brilliant blue flowers and small leaves. The former is a rare and local perennial, occurring, however, in Teesdale and the county of Clare in Ireland in tolerable abundance. It has a tufted habit of growth, and each stem bears only one flower. It is sometimes cultivated as an edging for flower borders. *G. nivalis* in Britain occurs only on a few of the loftiest Scottish mountains. It differs from the last in being an annual, and having a more isolated habit of growth, and in the stem bearing several flowers. On the Swiss mountains these beautiful little plants are very abundant; and the splendid blue colour of masses of gentian in flower is a sight which, when once seen, can never be forgotten. For ornamental purposes several species are cultivated. The great difficulty of growing them successfully renders them, however, less common than would otherwise be the case; although very hardy when once established, they are very impatient of removal, and rarely flower well until the third year after planting. Of the ornamental species found in British gardens some of the prettiest are *G. acutiloba*, *G. verna*, *G. pyrenaica*, *G. bavarica*, *G. septemfida* and *G. gelida*. Perhaps the handsomest and most easily grown is the first named, often called *Gentianella*, which produces its large intensely blue flowers early in the spring.

All the species of the genus are remarkable for possessing an intense but pure bitter taste and tonic properties. About forty species are used in medicine in different parts of the world. The name of felwort given to *G. amarella*, but occasionally applied to the whole genus, is stated by Dr Prior to be given in allusion to these properties—*fel* meaning gall, and *wort* a plant. In the same way the Chinese call *G. asclepiadea*, and the Japanese *G. Buergeri*, "dragon's gall plants," in common with several other very bitter plants whose roots they use in medicine. *G. campestris* is sometimes used in Sweden and other northern countries as a substitute for hops.

By far the most important of the species used in medicine is *G. lutea*, a large handsome plant 3 or 4 ft. high, growing in open

grassy places on the Alps, Apennines and Pyrenees, as well as on some of the mountainous ranges of France and Germany, extending as far east as Bosnia and the Danubian principalities. It has large oval strongly-ribbed leaves and dense whorls of conspicuous yellow flowers. Its use in medicine is of very ancient date. Pliny and Dioscorides mention that the plant was noticed by Gentius, a king of the Illyrians, living 180-167 B.C., from whom the name *Gentiana* is supposed to be derived. During the middle ages it was much employed in the cure of disease, and as an ingredient in counter-poisons. In 1552 Hieronymus Bock (Tragus) (1498-1554), a German priest, physician and botanist, mentions the use of the root as a means of dilating wounds.

The root, which is the part used in medicine, is tough and flexible, scarcely branched, and of a brownish colour and spongy texture. It has a pure bitter taste and faint distinctive odour. The bitter principle, known as *gentianin*, is a glucoside, soluble in water and alcohol. It can be decomposed into glucose and gentiopicrin by the action of dilute mineral acids. It is not precipitated by tannin or subacetate of lead. A solution of caustic potash or soda forms with gentianin a yellow solution, and the tincture of the root to which either of these alkalis has been added loses its bitterness in a few days. Gentian root also contains *gentianic acid* ($C_{11}H_{16}O_6$), which is inert and tasteless. It forms pale yellow silky crystals, very slightly soluble in water or ether, but soluble in hot strong alcohol and in aqueous alkaline solutions. This substance is also called *gentianin*, *gentisin* and *gentisic acid*.

The root also contains 12 to 15% of an uncrystallizable sugar called gentianose, of which fact advantage has long been taken in Switzerland and Bavaria for the production of a bitter cordial spirit called *Encianbranntwein*. The use of this spirit, especially in Switzerland, has sometimes been followed by poisonous symptoms, which have been doubtfully attributed to inherent narcotic properties possessed by some species of gentian, the roots of which may have been indiscriminately collected with it; but it is quite possible that it may be due to the contamination of the root with that of *Veratrum album*, a poisonous plant growing at the same altitude, and having leaves extremely similar in appearance and size to those of *G. lutea*.

Gentian is one of the most efficient of the class of substances which act upon the stomach so as to invigorate digestion and thereby increase the general nutrition, without exerting any direct influence upon any other portion of the body than the alimentary canal. Having a pleasant taste and being non-astringent (owing to the absence of tannic acid), it is the most widely used of all bitter tonics. The British Pharmacopoeia contains an aqueous extract (dose, 2-8 grains), a compound infusion with orange and lemon peel (dose, $\frac{1}{2}$ -1 ounce), and a compound tincture with orange peel and cardamoms (dose $\frac{1}{2}$ -1 drachm). It is used in dyspepsia, chlorosis, anaemia and various other diseases, in which the tone of the stomach and alimentary canal is deficient, and is sometimes added to purgative medicines to increase and improve their action. In veterinary medicine it is also used as a tonic, and enters into a well-known compound called *diapente* as a chief ingredient.

GENTIANACEAE (the gentian family), in botany an order of Dicotyledons belonging to the sub-class Sympetalae or Gamopetalae, and containing about 750 species in 64 genera. It has a world-wide distribution, and representatives adapted to very various conditions, including, for instance, alpine plants, like the true gentians (*Gentiana*), meadow plants such as the British *Clivia perfoliata* (yellow-wort) or *Erythraea Centaurium* (centaury), marsh plants such as *Meyenianthes trifoliata* (bog-bean), floating water plants such as *Limnanthemum*, or steppe and sea-coast plants such as *Cicendia*. They are annual or perennial herbs, rarely becoming shrubby, and generally growing erect, with a characteristic forked manner of branching; the Asiatic genus *Crawfordia* has a climbing stem; they are often low-growing and caespitose, as in the alpine gentians.

The leaves are in decussating pairs (that is, each pair is in a plane at right angles to the previous or succeeding pair), except in

Menyanthes and a few allied aquatic or marsh genera, where they are alternate or radical. Several genera, chiefly American, are saphrophytes, forming slender low-growing herbs, containing little or no chlorophyll and with leaves reduced to scales; such are *Voyria* and *Leiphaimos*, mainly tropical American. The inflorescence is generally cymose, often dichasial, recalling that of Caryophyllaceae, the lateral branches often becoming monochasial; it is sometimes reduced to a few flowers or one only, as in some gentians. The flowers are hermaphrodite, and regular with parts in 4's and 5's, with reduction to 2 in the pistil; in *Chlora* there are 6 to 8 members in each whorl. The calyx generally forms a tube with teeth or segments which usually overlap in the bud. The corolla shows great variety in form; thus among the British genera it is rotate in *Chlora*, funnel-shaped in *Erythraea*, and cylindrical, bell-shaped, funnel-shaped or salver-shaped in *Gentiana*; the segments are



Central figure and figs. 1-4 after Curtis, *Flora Londinensis*.
Gentiana Amarella.

- 1, A small form, natural size.
- 2, Calyx and protruding style.
- 3, Corolla, laid open.
- 4, Capsule, bursting into two valves, and showing the seeds attached to their margins.
- 5, Floral diagram.

in length, is simple, with an undivided or bilobed or bipartite stigma. The fruit is generally a membranous or leathery capsule, splitting septically into two valves; the seeds are small and numerous, and contain a small embryo in a copious endosperm.

The brilliant colour of the flowers, often occurring in large numbers (as in the alpine gentians), the presence of honey-glands and the frequency of dimorphy and dichogamy, are adaptations for pollination by insect visitors. In the true gentians (*Gentiana*) the flowers of different species are adapted for widely differing types of insect visitors. Thus *Gentiana lutea*, with a rotate yellow corolla and freely exposed honey, is adapted to short-tongued insect visitors; *G. Pneumonanthe*, with a long-tubed, bright blue corolla, is visited by humble bees; and *G. verna*, with a still longer narrower tube, is visited by Lepidoptera.

Gentiana, the largest genus, contains nearly three hundred species, distributed over Europe (including arctic), five being British, the mountains of Asia, south-east Australia and New Zealand, the whole of North America and along the Andes to Cape Horn; it does not occur in Africa. Bitter principles are general in the

vegetative parts, especially in the rhizomes and roots, and have given a medicinal value to many species, e.g. *Gentiana lutea* and others.

GENTILE, in the English Bible, the term generally applied to those who were not of the Jewish race. It is an adaptation of the Lat. *gentilis*, of or belonging to the same *gens*, the clan or family; as defined in Paulus ex Festo "gentilis dicitur et ex eodem genere ortus et is qui simili nomine; ut ait Cincius, gentiles mihi sunt, qui meo nomine appellantur." In post-Augustan Latin *gentilis* became wider in meaning, following the usage of *gens*, in the sense of race, nation, and meant "national," belonging to the same race. Later still the word came to mean "foreign," i.e. other than Roman, and was so used in the Vulgate, with *gentes*, to translate the Hebrew *goyyim*, nations, LXX. *ἔθνη*, the non-Israelitish peoples (see further JEWS).

GENTILE DA FABRIANO (c. 1370-c. 1450), Italian painter, was born at Fabriano about 1370. He is said to have been a pupil of Allegretto di Nuzio, and has been supposed to have received most of his early instruction from Fra Angelico, to whose manner his bears in some respects a close similarity. About 1411 he went to Venice, where by order of the doge and senate he was engaged to adorn the great hall of the ducal palace with frescoes from the life of Barbarossa. He executed this work so entirely to the satisfaction of his employers that they granted him a pension for life, and accorded him the privilege of wearing the habit of a Venetian noble. About 1422 he went to Florence, where in 1423 he painted an "Adoration of the Magi" for the church of Santa Trinita, which is preserved in the Florence Accademia; this painting is considered his best work now extant. To the same period belongs a "Madonna and Child," which is now in the Berlin Museum. He had by this time attained a wide reputation, and was engaged to paint pictures for various churches, more particularly Siena, Perugia, Gubbio and Fabriano. About 1426 he was called to Rome by Martin V. to adorn the church of St John Lateran with frescoes from the life of John the Baptist. He also executed a portrait of the pope attended by ten cardinals, and in the church of St Francesco Romano a painting of the "Virgin and Child attended by St Benedict and St Joseph," which was much esteemed by Michelangelo, but is no longer in existence. Gentile da Fabriano died about 1450. Michelangelo said of him that his works resembled his name, meaning noble or refined. They are full of a quiet and serene joyousness, and he has a naive and innocent delight in splendour and in gold ornaments, with which, however, his pictures are not overloaded.

GENTILESCHI, ARTEMISIA and ORAZIO DE', - Italian painters.

ORAZIO (c. 1565-1646) is generally named Orazio Lomi de' Gentileschi; it appears that De' Gentileschi was his correct surname, Lomi being the surname which his mother had borne during her first marriage. He was born at Pisa, and studied under his half-brother Aurelio Lomi, whom in course of time he surpassed. He afterwards went to Rome, and was associated with the landscape-painter Agostino Tasi, executing the figures for the landscape backgrounds of this artist in the Palazzo Rospiigliosi, and it is said in the great hall of the Quirinal Palace, although by some authorities the figures in the last-named building are ascribed to Lanfranco. His best works are "Saints Cecilia and Valerian," in the Palazzo Borghese, Rome; "David after the death of Goliath," in the Palazzo Doria, Genoa; and some works in the royal palace, Turin, noticeable for vivid and uncommens colouring. At an advanced age Gentileschi went to England at the invitation of Charles I., and he was employed in the palace at Greenwich. Vandyck included him in his portraits of a hundred illustrious men. His works generally are strong in shadow and positive in colour. He died in England in 1646.

ARTEMISIA (1590-1642), Orazio's daughter, studied first under Guido, acquired much renown for portrait-painting, and considerably excelled her father's fame. She was a beautiful and elegant woman; her likeness, limned by her own hand, is to be seen in Hampton Court. Her most celebrated composition is "Judith and Holofernes" in the Uffizi Gallery; certainly a work of singular energy, and giving ample proof of executive faculty.

but repulsive and unwomanly in its physical horror. She accompanied her father to England, but did not remain there long; the best picture which she produced for Charles I. was "David with the head of Goliath." Artemisia refused an offer of marriage from Agostino Tusi, and bestowed her hand on Pier Antonio Schiattesi, continuing, however, to use her own surname. She settled in Naples, whither she returned after her English sojourn; she lived there in no little splendour, and there she died in 1642. She had a daughter and perhaps other children.

GENTILI, ALBERICO (1552-1608), Italian jurist, who has great claims to be considered the founder of the science of international law, second son of Matteo Gentili, a physician of noble family and scientific eminence, was born on the 14th of January 1552 at Sanginesio, a small town of the march of Ancona which looks down from the slopes of the Apennines upon the distant Adriatic. After taking the degree of doctor of civil law at the university of Perugia, and holding a judicial office at Ascoli, he returned to his native city, and was entrusted with the task of recasting its statutes, but, sharing the Protestant opinions of his father, shared also, together with a brother, Scipio, afterwards a famous professor at Altdorf, his flight to Carniola, where in 1570 Matteo was appointed physician to the duchy. The Inquisition condemned the fugitives as contumacious, and they soon received orders to quit the dominions of Austria.

Alberico set out for England, travelling by way of Tübingen and Heidelberg, and everywhere meeting with the reception to which his already high reputation entitled him. He arrived at Oxford in the autumn of 1580, with a commendatory letter from the earl of Leicester, at that time chancellor of the university, and was shortly afterwards qualified to teach by being admitted to the same degree which he had taken at Perugia. His lectures on Roman law soon became famous, and the dialogues, disputations and commentaries, which he published henceforth in rapid succession, established his position as an accomplished civilian, of the older and severer type, and secured his appointment in 1587 to the regius professorship of civil law. It was, however, rather by an application of the old learning to the new questions suggested by the modern relations of states that his labours have produced their most lasting result. In 1584 he was consulted by government as to the proper course to be pursued with Mendoza, the Spanish ambassador, who had been detected in plotting against Elizabeth. He chose the topic to which his attention had thus been directed as a subject for a disputation when Leicester and Sir Philip Sidney visited the schools at Oxford in the same year; and this was six months later expanded into a book, the *De legationibus libri tres*. In 1588 Alberico selected the law of war as the subject of the law disputations at the annual "Act" which took place in July; and in the autumn published in London the *De Jure Belli commentatio prima*. A second and a third *Commentatio* followed, and the whole matter, with large additions and improvements, appeared at Hanau, in 1598, as the *De Jure Belli libri tres*. It was doubtless in consequence of the reputation gained by these works that Gentili became henceforth more and more engaged in forensic practice, and resided chiefly in London, leaving his Oxford work to be partly discharged by a deputy. In 1600 he was admitted to be a member of Gray's Inn, and in 1605 was appointed standing counsel to the king of Spain. He died on the 19th of June 1608, and was buried, by the side of Dr Matteo Gentili, who had followed his son to England, in the churchyard of St Helen's, Bishopsgate. By his wife, Hester de Peigni, he left two sons, Robert and Matthew, and a daughter, Anna, who married Sir John Colt. His notes of the cases in which he was engaged for the Spaniards were posthumously published in 1613 at Hanau, as *Hispanicarum advocatorum libri duo*. This was in accordance with his last wishes; but his direction that the remainder of his MSS. should be burnt was not complied with, since fifteen volumes of them found their way, at the beginning of the 19th century, from Amsterdam to the Bodleian library.

The true history of Gentili and of his principal writings has only been ascertained in recent years, in consequence of a revived

appreciation of the services which he rendered to international law. The movement to do him honour originated in 1875 in England, as the result of the inaugural lecture of Prof. T. E. Holland, and was warmly taken up in Italy. In spreading through Europe it encountered two curious cross-currents of opinion,—one the ultra-Catholic, which three centuries before had ordered his name to be erased from all public documents and placed his works in the *Index*; another the narrowly-Dutch, which is, it seems, needlessly careful of the supremacy of Grotius. These two currents resulted respectively in a bust of Garcia Moreno being placed in the Vatican, and in the unveiling in 1886, with much international oratory, of a fine statue of Grotius at Delft. The English committee, under the honorary presidency of Prince Leopold, in 1877 erected a monument to the memory of Gentili in St Helen's church, and saw to the publication of a new edition of the *De Jure Belli*. The Italian committee, of which Prince (afterwards King) Humbert was honorary president, was less successful. It was only in 1908, the centenary of the death of Alberico, that the statue of the great heretic was at length unveiled in his native city by the minister of public instruction, in the presence of numerous deputations from Italian cities and universities. Preceding writers had dealt with various international questions, but they dealt with them singly, and with a servile submission to the decisions of the church. It was left to Gentili to grasp as a whole the relations of states one to another, to distinguish international questions from questions with which they are more or less intimately connected, and to attempt their solution by principles entirely independent of the authority of Rome. He uses the reasonings of the civil and even the canon law, but he proclaims as his real guide the *Jus Naturæ*, the highest common sense of mankind, by which historical precedents are to be criticized and, if necessary, set aside.

His faults are not few. His style is prolix, obscure, and to the modern reader pedantic enough; but a comparison of his greatest work with what had been written upon the same subject by, for instance, Belli, or Soto, or even Ayala, will show that he greatly improved upon his predecessors, not only by the fulness with which he has worked out points of detail, but also by clearly separating the law of war from martial law, and by placing the subject once for all upon a non-theological basis. If, on the other hand, the same work be compared with the *De Jure Belli et Pacis* of Grotius, it is at once evident that the later writer is indebted to the earlier, not only for a large portion of his illustrative erudition, but also for all that is commendable in the method and arrangement of the treatise.

The following is probably a complete list of the writings of Gentili, with the places and dates of their first publication: *De juris inter presibus dialogi sex* (London, 1582); *Lectionum et epistol. quæ ad jus civile pertinent libri tres* (London, 1583-1584); *De legationibus libri tres* (London, 1585); *Legal. comitorum Oxon. actio* (London, 1585-1586); *De divers. temp. appellacionibus* (Hanau, 1586); *De nascenti tempore disputatio* (Witteb., 1586); *Disputationum decas prima* (London, 1587); *Conditionum liber singularis* (London, 1587); *De jure belli comm. prima* (London, 1588); *secunda*, ib. (1588-1589); *tertia* (1589); *De injustitia bellica Romanorum* (Oxon, 1590); *Ad tit. de Malef. et Math. de Prof. et Med.* (Hanau, 1593); *De jure belli libri tres* (Hanau, 1598); *De armis Romanis, &c.* (Hanau, 1599); *De actoribus et de abusis mendacii* (Hanau, 1599); *De ludis scenicis epistol. duæ* (Middleburg, 1600); *Ad I. Maccabeorum et de linguarum mistura disp.* (Frankfurt, 1600); *Lectiones Virgilianæ* (Hanau, 1600); *De nuptiis libri septem* (1601); *In tit. si quis principis, et ad leg. Jul. maiest.* (Hanau, 1604); *De latin. vet. Bibl.* (Hanau, 1604); *De libro Pyron* (Oxon, 1604); *Laudes Acad. Perus. et Oxon.* (Hanau, 1605); *De unione Angliæ et Scotiæ* (London, 1605); *Disputationes tres, de libris jur. can., de libris jur. civ., de latinitate vet. vers.* (Hanau, 1605); *Regales disput. tres, de pol. regis absolutæ, de unione regnorum, de vi civium* (London, 1605); *Hispanicarum advocatorum libri duo* (Hanau, 1613); *In tit. de verb. signif.* (Hanau, 1614); *De legatis in text.* (Amsterdam, 1661) An edition of the *Opera omnia*, commenced at Naples in 1770, was cut short by the death of the publisher, Gravier, after the second volume. Of his numerous unpublished writings, Gentili complained that four volumes were lost "pessimo pontificiorum facinore," meaning probably that they were left behind in his flight to Carniola.

AUTHORITIES.—Several tracts by the Abate Benigni in Colucci, *Antichità Picene* (1790); a dissertation by W. Reiser annexed to the *Program of the Groningen Gymnasium* for 1867; an inaugural lecture delivered in 1874 by T. E. Holland, translated into Italian

with additions by the author, by A. Saffi (1884); the preface to a new edition of the *De jure belli* (1877) and *Studies in International Law* (1898) (which see, for details as to the family and MSS. of Gentili), by the same; works by Valdarnini and Foglietti (1875), Speranza and De Giorgi (1876), Fiorini (a translation of the *De jure belli*, with essay, 1877), A. Saffi (1878), L. Marson (1885), M. Thaman (1896), B. Brugé (1898) T. A. Walker (an analysis of the principal works of Gentili) in his *History of the Law of Nations*, vol. 1. (1899); H. Nézard, in Pillet's *Fondateurs de droit international* (1904); E. Agabiti (1908). See also E. Comba, in the *Rivista Christiana* (1876-1877); Sir T. Twiss, in the *Law Review* (1878); articles in the *Revue de droit international* (1875-1878, 1883, 1886, 1908); O. Scalvanti, in the *Annali dell' Univ. di Perugia*, N.S., vol. viii. (1898).

GENTLE (through the Fr. *gentil*, from Lat. *gentilis*, belonging to the same *gens*, or family), properly an epithet of one born of a "good family"; the Latin *generosus*, "well born" (see GENTLEMAN), contrasted with "noble" on the one side and "simple" on the other. The word followed the wider application of the word "gentleman"; implying the manners, character and breeding proper to one to whom that name could be applied, courteous, polite; hence, with no reference to its original meaning, free from violence or roughness, mild, soft, kind or tender. With a physical meaning of soft to the touch, the word is used substantively of the maggot of the bluebottle fly, used as a bait by fishermen. At the end of the 16th century the French *gentil* was again adapted into English in the form "gentile," later changed to "genteel." The word was common in the 17th and 18th centuries as applied to behaviour, manner of living, dress, &c., suitable or proper to persons living in a position in society above the ordinary, hence polite, elegant. From the early part of the 19th century it has also been used in an ironical sense, and applied chiefly to those who pay an excessive and absurd importance to the outward marks of respectability as evidence of being in a higher rank in society than that to which they properly belong.

GENTLEMAN (from Lat. *gentilis*, "belonging to a race or gens," and "man"; Fr. *gentilhomme*, Span. *gentil hombre*, Ital. *gentil huomo*, in its original and strict signification, a term denoting a man of good family, the Lat. *generosus* (its invariable translation in English-Latin documents). In this sense it is the equivalent of the Fr. *gentilhomme*, "nobleman," which latter term has in Great Britain been long confined to the peerage (see NOBILITY); and the term "gentry" ("gentrice" from O. Fr. *genterise* for *gentelise*) has much of the significance of the Fr. *noblesse* or the Ger. *Adel*. This was what was meant by the rebels under John Ball in the 14th century when they repeated:

"When Adam delved and Eve span,
Who was then the gentleman?"

Selden (*Titles of Honor*, 1672), discussing the title "gentleman," speaks of "our English use of it" as "convertible with *nobilis*," and describes in connexion with it the forms of ennobling in various European countries. William Harrison, writing a century earlier, says "gentlemen be those whom their race and blood, or at the least their virtues, do make noble and known." But for the complete gentleman the possession of a coat of arms was in his time considered necessary; and Harrison gives the following account of how gentlemen were made in Shakespeare's day:

"gentlemen whose ancestors are not known to come in with William duke of Normandy (for of the Saxon races yet remaining we now make none account, much less of the British issue) do take their beginning in England after this manner in our times. Who soever studieth the laws of the realm, who so abideth in the university, giving his mind to his book, or professeth physic and the liberal sciences, or beside his service in the room of a captain in the wars, or good counsel given at home, whereby his commonwealth is benefited, can live without manual labour, and thereto is able and will bear the port, charge and countenance of a gentleman, he shall for money have a coat and arms bestowed upon him by heralds (who in the charter of the same do of custom pretend antiquity and service, and many gay things) and therunto being made so good cheap be called master, which is the title that men give to esquires and gentlemen, and reputed for a gentleman ever after. Which is so much the less to be disallowed of, for that the prince doth lose nothing by it, the gentleman being so much subject to taxes and public payments as is the yeoman or husbandman, which he likewise doth bear the gladlier for the saving of his reputation. Being called also to the wars (for with the government of

the commonwealth he medleth little) what soever it cost him, he will both array and arm himself accordingly, and show the more manly courage, and all the tokens of the person which he representeth. No man hath hurt by it but himself, who peradventure will go in wider buskins than his legs will bear, or as our proverb saith, now and then bear a bigger sail than his boat is able to sustain."¹

In this way Shakespeare himself was turned, by the grant of his coat of arms, from a "vagabond" into a gentleman.

The fundamental idea of "gentry," symbolized in this grant of coat-armour, had come to be that of the essential superiority of the fighting man; and, as Selden points out (p. 707), the fiction was usually maintained in the granting of arms "to an ennobled person though of the long Robe wherein he hath little use of them as they mean a shield." At the last the wearing of a sword on all occasions was the outward and visible sign of a "gentleman"; and the custom survives in the sword worn with "court dress." This idea that a gentleman must have a coat of arms, and that no one is a "gentleman" without one is, however, of comparatively late growth, the outcome of the natural desire of the heralds to magnify their office and collect fees for registering coats; and the same is true of the conception of "gentlemen" as a separate class. That a distinct order of "gentry" existed in England very early has, indeed, been often assumed, and is supported by weighty authorities. Thus, the late Professor Freeman (*Ency. Brit.* xvii. p. 540 b, 9th ed.) said: "Early in the 11th century the order of 'gentlemen' as a separate class seems to be forming as something new. By the time of the conquest of England the distinction seems to have been fully established." Stubbs (*Const. Hist.*, ed. 1878, iii. 544, 548) takes the same view. Sir George Sitwell, however, has conclusively proved that this opinion is based on a wrong conception of the conditions of mediæval society, and that it is wholly opposed to the documentary evidence. The fundamental social cleavage in the middle ages was between the *nobiles*, i.e. the tenants in chivalry, whether earls, barons, knights, esquires or franklins, and the *ignobiles*, i.e. the villeins, citizens and burghesses;² and between the most powerful noble and the humblest franklin there was, until the 15th century, no "separate class of gentlemen." Even so late as 1400 the word "gentleman" still only had the sense of *generosus*, and could not be used as a personal description denoting rank or quality, or as the title of a class. Yet after 1413 we find it increasingly so used; and the list of landowners in 1431, printed in *Feudal Aids*, contains besides knights, esquires, yeomen and husbandmen (i.e. householders), a fair number who are classed as "gentilman."

Sir George Sitwell gives a lucid explanation of this development, the incidents of which are instructive and occasionally amusing. The immediate cause was the statute 1 Henry V. cap. v. of 1413, which laid down that in all original writs of action, personal appeals and indictments, in which process of outlawry lies, the "estate degree or mystery" of the defendant must be stated, as well as his present or former domicile. Now the Black Death (1340) had put the traditional social organization out of gear. Before that the younger sons of the *nobiles* had received their share of the farm stock, bought or hired land, and settled down as agriculturists in their native villages. Under the new conditions

¹ *Description of England*, bk. ii. ch. v. p. 128. Henry Peacham, in his *Compleat Gentleman* (1634), takes this matter more seriously. "Neither must we honour or esteem," he writes, "those ennobled, or made gentle in blood, who by mechanic and base means have raked up a mass of wealth . . . or have purchased an ill coat (of arms) at a good rate; no more than a player upon the stage, for wearing a lord's cast suit: since nobility hangeth not upon the airy esteem of vulgar opinion, but is indeed of itself essential and absolute" (Reprint, p. 3). Elsewhere (p. 161) he deplores the abuse of heraldry, which had even in his day produced "all the world over such a medley of coats" that, but for the commendable activity of the earls' marshals, he feared that women would soon be "as rare in England as they are in France." See also an amusing instance from the time of Henry VIII., given in "The Gentility of Richard Barker," by Oswald Barron, in the *Ascentor*, vol. ii. (July 1902).

² Even this classification would seem to need modifying. For certain of the great patrician families of the cities were certainly *nobiles*.

this became increasingly impossible, and they were forced to seek their fortunes abroad in the French wars, or at home as hangers-on of the great nobles. These men, under the old system, had no definite status; but they were *generosi*, men of birth, and, being now forced to describe themselves, they disdained to be classed with franklins (now sinking in the social scale), still more with yeomen or husbandmen; they chose, therefore, to be described as "gentlemen." On the character of these earliest "gentlemen" the records throw a lurid light. According to Sir George Sitwell (p. 76), "the premier gentleman of England, as the matter now stands, is 'Robert Erdeswyke of Stafford, gentleman,'" who had served among the men-at-arms of Lord Talbot at Agincourt (*ib. note*). He is typical of his class. "Fortunately—for the gentle reader will no doubt be anxious to follow in his footsteps—some particulars of his life may be gleaned from the public records. He was charged at the Staffordshire Assizes with housebreaking, wounding with intent to kill, and procuring the murder of one Thomas Page, who was cut to pieces while on his knees begging for his life." If any earlier claimant to the title of "gentleman" be discovered, Sir George Sitwell predicts that it will be within the same year (1414) and in connexion with some similar disreputable proceedings.¹

From these unpromising beginnings the separate order of "gentlemen" was very slowly evolved. The first "gentleman" commemorated on an existing monument was John Daundelyon of Margate (d. c. 1445); the first gentleman to enter the House of Commons, hitherto composed mainly of "valets," was "William Weston, gentylman"; but even in the latter half of the 15th century the order was not clearly established. As to the connexion of "gentlesse" with the official grant or recognition of coat-armour, that is a profitable fiction invented and upheld by the heralds; for coat-armour was but the badge assumed by gentlemen to distinguish them in battle, and many gentlemen of long descent never had occasion to assume it, and never did. This fiction, however, had its effect; and by the 16th century, as has been already pointed out, the official view had become clearly established that "gentlemen" constituted a distinct order, and that the badge of this distinction was the heralds' recognition of the right to bear arms. It is unfortunate that this view, which is quite unhistorical and contradicted by the present practice of many undoubtedly "gentle" families of long descent, has of late years been given a wide currency in popular manuals of heraldry.

In this narrow sense, however, the word "gentleman" has long since become obsolete. The idea of "gentry" in the continental sense of *noblesse* is extinct in England, and is likely to remain so, in spite of the efforts of certain enthusiasts to revive it (see A. C. Fox-Davies, *Armorial Families*, Edinburgh, 1895). That it once existed has been sufficiently shown; but the whole spirit and tendency of English constitutional and social development tended to its early destruction. The comparative good order of England was not favourable to the continuance of a class, developed during the foreign and civil wars of the 14th and 15th centuries, for whom fighting was the sole honourable occupation. The younger sons of noble families became apprentices in the cities, and there grew up a new aristocracy of trade. Merchants are still "citizens" to William Harrison; but he adds "they often change estate with gentlemen, as gentlemen do with them, by a mutual conversion of the one into the other." A frontier line between classes so indefinite could not be maintained, especially as in England there was never a "nobiliary prefix" to stamp a person as a gentleman by his

¹The designation "gentilman" is, indeed, found some two centuries earlier. In the *Inquisitio maneriorum Ecclesie S. Pauli Londin.* of A.D. 1222 (W. A. Hale, *Domusday of St Paul's*, Camden Soc., 1858, p. 80) occurs the entry: *Adam gentilmā dim acra, p' sii. d.* This is probably the earliest record of the "grand old name of gentleman"; but Adam, who held half an acre at a rent of three pence—less by half than that held by "Ralph the bondsman" (*Rad' le bunde*) in the same list—was certainly not a "gentleman." "Gentilman" here was a nickname, perhaps suggested by Adam's name, and thus in some sort anticipating the wit of the famous couplet repeated by John Bull's rebels.

surname, as in France or Germany.² The process was hastened, moreover, by the corruption of the Heralds' College and by the ease with which coats of arms could be assumed without a shadow of claim; which tended to bring the "science of armory" into contempt. The word "gentleman" as an index of rank had already become of doubtful value before the great political and social changes of the 19th century gave to it a wider and essentially higher significance. The change is well illustrated in the definitions given in the successive editions of the *Encyclopædia Britannica*. In the 5th edition (1815) "a gentleman is one, who without any title, bears a coat of arms, or whose ancestors have been freemen." In the 7th edition (1845) it still implies a definite social status: "All above the rank of yeomen." In the 8th edition (1856) this is still its "most extended sense"; "in a more limited sense" it is defined in the same words as those quoted above from the 5th edition; but the writer adds, "By courtesy this title is generally accorded to all persons above the rank of common tradesmen when their manners are indicative of a certain amount of refinement and intelligence." The Reform Bill of 1832 has done its work; the "middle classes" have come into their own; and the word "gentleman" has come in common use to signify not a distinction of blood, but a distinction of position, education and manners. The test is no longer good birth, or the right to bear arms, but the capacity to mingle on equal terms in good society. In its best use, moreover, "gentleman" involves a certain superior standard of conduct, due, to quote the 8th edition once more, to "that self-respect and intellectual refinement which manifest themselves in unrestrained yet delicate manners." The word "gentle," originally implying a certain social status, had very early come to be associated with the standard of manners expected from that status. Thus by a sort of punning process the "gentleman" becomes a "gentle-man." Chaucer in the *Melibeus* (c. 1386) says: "Certes he sholde not be called a gentil man, that . . . ne dooth his diligence and bisynesse, to keepen his good name"; and in the *Wife of Bath's Tale*:

"Loke who that is most vertuous away
Prive and apert, and most entendeth ay
To do the gentil dedes that he can
And take him for the grettest gentilman,"

and in the *Romance of the Rose* (c. 1400) we find "he is gentil bycause he doth as longeth to a gentilman." This use develops through the centuries, until in 1714 we have Steele, in the *Tatler* (No. 207), laying down that "the appellation of Gentleman is never to be affixed to a man's circumstances, but to his Behaviour in them," a limitation over-narrow even for the present day. In this connexion, too, may be quoted the old story, told by some—very improbably—of James II., of the monarch who replied to a lady petitioning him to make her son a gentleman, "I could make him a nobleman, but God Almighty could not make him a gentleman." Selden, however, in referring to similar stories "that no Charter can make a Gentleman, which is cited as out of the mouth of some great Princes that have said it," adds that "they without question understood Gentleman for *Generosus* in the ancient sense, or as if it came from *Gentilis* in that sense, as *Gentilis* denotes one of a noble Family, or indeed for a Gentleman by birth." For "no creation could make a man of another blood than he is." The word "gentleman," used in the wide sense with which birth and circumstances have nothing to do, is necessarily incapable of strict definition. For "to behave like a gentleman" may mean little or much, according to the person by whom the phrase is used; "to spend money like a gentleman" may even be no great praise; but "to conduct a business like a gentleman" implies a standard at least as high as that involved

²The prefix "de" attached to some English names is in no sense "nobiliary." In Latin documents *de* was the equivalent of the English "of," as *de la of* "at" (so de la Pole for Atte Poole, cf. such names as Attwood, Attwater). In English this "of" was in the 15th century dropped; e.g. the grandson of Johannes de Stoke (John of Stoke) in a 14th-century document becomes John Stoke. In modern times, under the influence of romanticism, the prefix "de" has been in some cases "revived" under a misconception, e.g. "de Trafford," "de Hoghton." Very rarely it is correctly retained as derived from a foreign place-name, e.g. de Grey.

arc of France by P. F. A. Méchain and J. B. J. Delambre had for its end the determination of the true length of the "metre" which was to be the legal standard of length of France (see EARTH, FIGURE OF THE).

The basis of every extensive survey is an accurate triangulation, and the operations of geodesy consist in the measurement, by theodolites, of the angles of the triangles; the measurement of one or more sides of these triangles on the ground, the determination by astronomical observations of the azimuth of the whole network of triangles; the determination of the actual position of the same on the surface of the earth by observations, first for latitude at some of the stations, and secondly for longitude; the determination of altitude for all stations.

For the computation, the points of the actual surface of the earth are imagined as projected along their plumb lines on the mathematical figure, which is given by the stationary sea-level, and the extension of the sea through the continents by a system of imaginary canals. For many purposes the mathematical surface is assumed to be a plane; in other cases a sphere of radius 6371 kilometres (20,900,000 ft.). In the case of extensive operations the surface must be considered as a compressed ellipsoid of rotation, whose minor axis coincides with the earth's axis, and whose compression, flattening, or ellipticity is about $1/208$.

Measurement of Base Lines.

To determine by actual measurement on the ground the length of a side of one of the triangles ("base line"), wherefrom to infer the lengths of all the other sides in the triangulation, is not the least difficult operation of a trigonometrical survey. When the problem is stated thus—To determine the number of times that a certain standard or unit of length is contained between two finely marked points on the surface of the earth at a distance of some miles asunder, so that the error of the result may be pronounced to lie between certain very narrow limits,—then the question demands very serious consideration. The representation of the unit of length by means of the distance between two fine lines on the surface of a bar of metal at a certain temperature is never itself free from uncertainty and probable error, owing to the difficulty of knowing at any moment the precise temperature of the bar; and the transference of this unit, or a multiple of it, to a measuring bar will be affected not only with errors of observation, but with errors arising from uncertainty of temperature of both bars. If the measuring bar be not self-compensating for temperature, its expansion must be determined by very careful experiments. The thermometers required for this purpose must be very carefully studied, and their errors of division and index error determined.

In order to avoid the difficulty in exactly determining the temperature of a bar by the mercury thermometer, F. W. Bessel introduced in 1834 near Königsberg a compound bar which constituted a metallic thermometer.¹ A zinc bar is laid on an iron bar two toises long, both bars being perfectly planed and in free contact, the zinc bar being slightly shorter and the two bars rigidly united at one end. As the temperature varies, the difference of the lengths of the bars, as perceived by the other end, also varies, and affords a quantitative correction for temperature variations, which is applied to reduce the length to standard temperature. During the measurement of the base line the bars were not allowed to come into contact, the interval being measured by the insertion of glass wedges. The results of the comparisons of four measuring rods with one another and with the standards were elaborately computed by the method of least-squares. The probable error of the measured length of 935 toises (about 6000 ft.) has been estimated as $1/863500$ or 1.2μ (μ denoting a millionth). With this apparatus fourteen base lines were measured in Prussia and some neighbouring states; in these cases a somewhat higher degree of accuracy was obtained.

The principal triangulation of Great Britain and Ireland has seven base lines: five have been measured by steel chains, and two, more exactly, by the compensation bars of General T. F. Colby, an apparatus introduced in 1827-1828 at Lough Foyle in Ireland. Ten base lines were measured in India in 1831-1869 by the same apparatus. This is a system of six compound-bars self-correcting for temperature. The bars may be thus described: Two bars, one of brass and the other of iron, are laid in parallelism side by side, firmly united at their centres, from which they may freely expand or contract; at the standard temperature they are of the same length. Let AB be one bar, A'B' the other; draw lines through the corresponding extremities AA' (to P) and BB' (to Q), and make A'P=B'Q, AA' being equal to BB'. If the ratio A'P/AP equals the ratio of the coefficients of expansion of the bars A'B' and AB, then, obviously, the distance PQ is constant (or nearly so). In the actual instrument

P and Q are finely engraved dots 10 ft. apart. In practice the bars, when aligned, are not in contact, an interval of 6 in. being allowed between each bar and its neighbour. This distance is accurately measured by an ingenious micrometrical arrangement constructed on exactly the same principle as the bars themselves.

The last base line measured in India had a length of 8913 ft. In consequence of some suspicion as to the accuracy of the compensation apparatus, the measurement was repeated four times, the operations being conducted so as to determine the actual values of the probable errors of the apparatus. The direction of the line (which is at Cape Comorin) is north and south. In two of the measurements the brass component was to the west, in the others to the east; the differences between the individual measurements and the mean of the four were $+0.0017$, -0.0049 , -0.0015 , $+0.0045$ ft. These differences are very small; an elaborate investigation of all sources of error shows that the probable error of a base line in India is on the average $\pm 2.8 \mu$. These compensation bars were also used by Sir Thomas Maclear in the measurement of the base line in his extension of Lacaille's arc at the Cape. The account of this operation will be found in a volume entitled *Verification and Extension of Lacaille's Arc of Meridian at the Cape of Good Hope*, by Sir Thomas Maclear, published in 1866. A rediscussion has been given by Sir David Gill in his *Report on the Geodetic Survey of South Africa, &c., 1860*.

A very simple base apparatus was employed by W. Struve in his triangulations in Russia from 1817 to 1855. This consisted of four wrought-iron bars, each two toises (rather more than 13 ft.) long; one end of each bar is terminated in a small steel cylinder presenting a slightly convex surface for contact, the other end carries a contact lever rigidly connected with the bar. The shorter arm of the lever terminates below in a polished hemisphere, the upper and longer arm traversing a vertical divided arc. In measuring, the plane end of one bar is brought into contact with the short arm of the contact lever (pushed forward by a weak spring) of the next bar. Each bar has two thermometers, and a level for determining the inclination of the bar in measuring. The manner of transferring the end of a bar to the ground is simply this: under the end of the bar a stake is driven very firmly into the ground, carrying on its upper surface a disk, capable of movement in the direction of the measured line by means of slow-motion screws. A fine mark on this disk is brought vertically under the end of the bar by means of a theodolite which is planted at a distance of 25 ft. from the stake in a direction perpendicular to the base. Struve investigated for each base the probable errors of the measurement arising from each of these seven causes: Alignment, inclination, comparisons with standards, readings of index, personal errors, uncertainties of temperature, and the probable errors of adopted rates of expansion. He found that $\pm 0.8 \mu$ was the mean of the probable errors of the seven bases measured by him. The Austro-Hungarian apparatus is similar; the distance of the rods is measured by a slider, which rests on one of the ends of each rod. Twenty-two base lines were measured in 1840-1899.

General Carlos Ibañez employed in 1858-1879, for the measurement of nine base lines in Spain, two apparatus similar to the apparatus previously employed by Porro in Italy; one is complicated, the other simplified. The first, an apparatus of the brothers Brunner of Paris, was a thermometric combination of two bars, one of platinum and one of brass, in length 4 metres, furnished with three levels and four thermometers. Suppose A, B, C three micrometer microscopes very firmly supported at intervals of 4 metres with their axes vertical, and aligned in the plane of the base line by means of a transit instrument, their micrometer screws being in the line of measurement. The measuring bar is brought under say A and B, and those microscopes read; the bar is then shifted and brought under B and C. By repetition of this process, the reading of a micrometer indicating the end of each position of the bar, the measurement is made.

Quite similar apparatus (among others) has been employed by the French and Germans. Since, however, it only permitted a distance of about 300 m. to be measured daily, Ibañez introduced a simplification; the measuring rod being made simply of steel, and provided with inlaid mercury thermometers. This apparatus was used in Switzerland for the measurement of three base lines. The accuracy is shown by the estimated probable errors. $\pm 0.2 \mu$ to $\pm 0.8 \mu$. The distance measured daily amounts at least to 800 m.

A greater daily distance can be measured with the same accuracy by means of Bessel's apparatus; this permits the ready measurement of 2000 m. daily. For this, however, it is important to notice that a large staff and favourable ground are necessary. An important improvement was introduced by Edward Jäderin of Stockholm, who measures with stretched wires of about 24 metres long; these wires are about 1.65 mm. in diameter, and when in use are stretched by an accurate spring balance with a tension of 10 kg.¹ The nature of the ground has a very trifling effect on this method. The difficulty of temperature determinations is removed by employing wires made of Invar, an alloy of steel (64%) and nickel (36%) which has practically no linear expansion for small thermal changes

¹ An arrangement acting similarly had been previously introduced by Borda.

² *Geodetic Survey of South Africa*, vol. iii. (1905), p. viii; *Les Nouveaux Appareils pour la mesure rapide des bases géod.*, par J. Rané Benoit et Ch. Ed. Guillaume (1906).

at ordinary temperatures; this alloy was discovered in 1896 by Benoit and Guillaume of the International Bureau of Weights and Measures at Breteuil. Apparently the future of base-line measurements rests with the invar wires of the Jäderin apparatus; next comes Porro's apparatus with invar bars 4 to 5 metres long.

Results have been obtained in the United States, of great importance in view of their accuracy, rapidity of determination and economy. For the measurement of the arc of meridian in longitude 98° E., in 1900, nine base lines of a total length of 69.2 km. were measured in six months. The total cost of one base was \$1231. At the beginning and at the end of the field-season a distance of exactly 100 m. was measured with R. S. Woodward's "5-m. ice-bar" (invented in 1891); by means of the remeasurement of this length the standardization of the apparatus was done under the same conditions as existed in the case of the base measurements. For the measurements there were employed two steel tapes of 100 m. long, provided with supports at distances of 25 m., two of 30 m., and the duplex apparatus of Eimbeck, consisting of four 5-m. rods. Each base was divided into sections of about 1000 m.; one of these, the "test kilometre," was measured with all the five apparatus, the others only with two apparatus, mostly tapes. The probable error was about $\pm 0.8 \mu$, and the day's work a distance of about 2000 m. Each of the four rods of the duplex apparatus consists of two bars of brass and steel. Mercury thermometers are inserted in both bars; these serve for the measurement of the length of the base lines by each of the bars, as they are brought into their consecutive positions, the contact being made by an elastic-sliding contact. The length of the base lines may be calculated for each bar only, and also by the supposition that both bars have the same temperature. The apparatus thus affords three sets of results, which mutually control themselves, and the contact adjustments permit rapid work. The same device has been applied to the older bimetallic-compensating apparatus of Bache-Wiedemann (six bases, 1847-1857) and of Schott. There was also employed a single rod bimetallic apparatus on F. Porro's principle, constructed by the brothers Repsold for some base lines. Excellent results have been more recently obtained with invar tapes.

The following results show the lengths of the same German base lines as measured by different apparatus:

		metres.	
Base at Berlin	1864	Apparatus of Bessel	2336.3920
" "	1880	" Brunner	.3924
Base at Strahlen	1854	" Bessel	2762.5824
" "	1879	" Brunner	.5852
Old base at Bonn	1847	" Bessel	2133.9093
" "	1892	" "	.9097
New base at Bonn	1892	" "	2512.9612
" "	1892	" Brunner	.9696

It is necessary that the altitude above the level of the sea of every part of a base line be ascertained by spirit levelling, in order that the measured length may be reduced to what it would have been had the measurement been made on the surface of the sea, produced in imagination. Thus if l be the length of a measuring bar, h its height at any given position in the measurement, r the radius of the earth, then the length radially projected on to the level of the sea is $l(1-h/r)$. In the Salisbury Plain base line the reduction to the level of the sea is -0.6294 ft.

The total number of base lines measured in Europe up to the present time is about one hundred and ten, nineteen of which do not exceed in length 2500 metres, or about $\frac{1}{2}$ miles, and three—

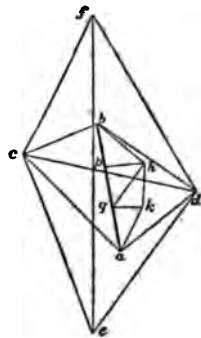

FIG. 1.

known; then, taking suitable external stations, as A, K , the angles of the triangles bhp, phq, hqk, kqs are measured. From these angles can be computed the ratios of the segments, which must agree, if all operations are correctly performed, with the ratios resulting from

the measure. Leaving the base line, the sides increase up to 10, 30 or 50 miles occasionally, but seldom reaching 100 miles. The triangulation points may either be natural objects presenting themselves in suitable positions, such as church towers; or they may be objects specially constructed in stone or wood on mountain tops or other prominent ground. In every case it is necessary that the precise centre of the station be marked by some permanent mark. In India no expense is spared in making permanent the principal trigonometrical stations—costly towers in masonry being erected. It is essential that every trigonometrical station shall present a fine object for observation from surrounding stations.

Horizontal Angles.

In placing the theodolite over a station to be observed from, the first point to be attended to is that it shall rest upon a perfectly solid foundation. The method of obtaining this desideratum must depend entirely on the nature of the ground; the instrument must if possible be supported on rock, or if that be impossible a solid foundation must be obtained by digging. When the theodolite is required to be raised above the surface of the ground in order to command particular points, it is necessary to build two scaffolds,—the outer one to carry the observatory, the inner one to carry the instrument,—and these two edifices must have no point of contact. Many cases of high scaffolding have occurred on the English Ordnance Survey, as for instance at Thaxted church, where the tower, 80 ft. high, is surmounted by a spire of 90 ft. The scaffold for the observatory was carried from the base to the top of the spire; that for the instrument was raised from a point of the spire 140 ft. above the ground, having its bearing upon timbers passing through the spire at that height. Thus the instrument, at a height of 178 ft. above the ground, was insulated, and not affected by the action of the wind on the observatory.

At every station it is necessary to examine and correct the adjustments of the theodolite, which are these: the line of collimation of the telescope must be perpendicular to its axis of rotation; this axis perpendicular to the vertical axis of the instrument; and the latter perpendicular to the plane of the horizon. The micrometer microscopes must also measure correct quantities on the divided circle or circles. The method of observing is this. Let A, B, C, \dots be the stations to be observed taken in order of azimuth; the telescope is first directed to A and the cross-hairs of the telescope made to bisect the object presented by A , then the microscopes or verniers of the horizontal circle (also of the vertical circle if necessary) are read and recorded. The telescope is then turned to B , which is observed in the same manner; then C and the other stations. Coming round by continuous motion to A , it is again observed, and the agreement of this second reading with the first is some test of the stability of the instrument. In taking this round of angles—or "arc," as it is called on the Ordnance Survey—it is desirable that the interval of time between the first and second observations of A should be as small as may be consistent with due care. Before taking the next arc the horizontal circle is moved through 30° or $30'$; thus a different set of divisions of the circle is used in each arc, which tends to eliminate the errors of division.

It is very desirable that all arcs at a station should contain one point in common, to which all angular measurements are thus referred,—the observations on each arc commencing and ending with this point, which is on the Ordnance Survey called the "referring object." It is usual for this purpose to select, from among the points which have to be observed, that one which affords the best object for precise observation. For mountain tops a "referring object" is constructed of two rectangular plates of metal in the same vertical plane, their edges parallel and placed at such a distance apart that the light of the sky seen through appears as a vertical line about $10''$ in width. The best distance for this object is from 1 to 2 miles.

This method seems at first sight very advantageous; but if, however, it be desired to attain the highest accuracy, it is better, as shown by General Schreiber of Berlin in 1878, to measure only single angles, and as many of these as possible between the directions to be determined. Division-errors are thus more perfectly eliminated, and errors due to the variation in the stability, &c., of the instruments are diminished. This method is rapidly gaining precedence.

The theodolites used in geodesy vary in pattern and in size—the horizontal circles ranging from 10 in. to 36 in. in diameter. In Ramsden's 36-in. theodolite the telescope has a focal length of 36 in. and an aperture of 2.5 in., the ordinarily used magnifying power being 54; this last, however, can of course be changed at the requirements of the observer or of the weather. The probable error of a single observation of a fine object with this theodolite is about $0''.2$. Fig. 2 represents an altazimuth theodolite of an improved pattern used on the Ordnance Survey. The horizontal circle of 14-in. diameter is read by three micrometer microscopes; the vertical circle has a diameter of 12 in., and is read by two microscopes. In the great trigonometrical survey of India the theodolites used in the more important parts of the work have been of 2 and 3 ft. diameter—the circle read by five equidistant microscopes. Every angle is measured twice in each position of the zero of the horizontal circle, of which there are generally ten; the entire

number of measures of an angle is never less than 20. An examination of 1407 angles showed that the probable error of an observed angle is on the average = 0".28.

For the observations of very distant stations it is usual to employ a heliotope (from the Gr. $\eta\lambda\iota\omicron\varsigma$, sun; $\tau\epsilon\lambda\epsilon\omicron\varsigma$, a turn), invented by Gauss at Göttingen in 1821. In its simplest form this is a plane mirror, 4, 6, or 8 in. in diameter, capable of rotation round a horizontal and a vertical axis. This mirror is placed at the station to be observed, and in fine weather it is kept so directed that the rays of the sun reflected by it strike the distant observing telescope. To the observer the heliotope presents the appearance of a star of the first or second magnitude, and is generally a pleasant object for observing.

Observations at night, with the aid of light-signals, have been repeatedly made, and with good results, particularly in France by General François Perrier, and more recently in the United States by the Coast and Geodetic Survey; the signal employed being an acetylene bicycle-lamp, with a lens 5 in. in diameter. Particularly noteworthy are the trigonometrical connexions of Spain and Algeria, which were carried out in 1879 by Generals Ibañez and Perrier (over a distance of 270 km.), of Sicily and Malta in 1900, and of the islands of Elba and Sardinia in 1902 by Dr Guarducci (over distances up to 230 km.); in these cases artificial

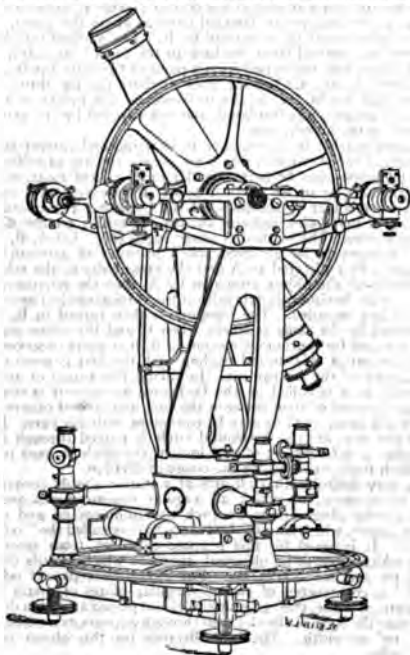

FIG. 2.—Altazimuth Theodolite.

light was employed: in the first case electric light and in the two others acetylene lamps.

Astronomical Observations.

The direction of the meridian is determined either by a theodolite for a portable transit instrument. In the former case the observation consists in observing the angle between a terrestrial object—generally a mark specially erected and capable of illumination at night—and a close circumpolar star at its greatest eastern or western azimuth, or, at any rate, when very near that position. If the observation be made t minutes of time before or after the time of greatest azimuth, the azimuth then will differ from its maximum value by $(450t)^2 \sin 1'' \sin 2\delta / \sin s$, in seconds of angle, omitting smaller terms, δ being the star's declination and s its zenith distance. The collimation and level errors are very carefully determined before and after these observations, and it is usual to arrange the observations by the reversal of the telescope so that collimation error shall disappear. If b , c be the level and collimation errors, the correction to the circle reading is $\delta \cot s = c \cos s$, b being positive when the west end of the axis is high. It is clear that any uncertainty as to the real state of the level will produce a corre-

sponding uncertainty in the resulting value of the azimuth,—an uncertainty which increases with the latitude and is very large in high latitudes. This may be partly remedied by observing in connexion with the star its reflection in mercury. In determining the value of "one division" of a level tube, it is necessary to bear in mind that in some the value varies considerably with the temperature. By experiments on the level of Ramsden's 3-foot theodolite, it was found that though at the ordinary temperature of 66° the value of a division was about one second, yet at 32° it was about five seconds.

In a very excellent portable transit used on the Ordnance Survey, the uprights carrying the telescope are constructed of mahogany; each upright being built of several pieces glued and screwed together; the base, which is a solid and heavy plate of iron, carries a reversing apparatus for lifting the telescope out of its bearings, reversing it and letting it down again. Thus is avoided the change of temperature which the telescope would incur by being lifted by the hands of the observer. Another form of transit is the German diagonal form, in which the rays of light after passing through the object-glass are turned by a total reflection prism through one of the transverse arms of the telescope, at the extremity of which arm is the eye-piece. The unused half of the ordinary telescope being cut away is replaced by a counterpoise. In this instrument there is the advantage that the observer without moving the position of his eye commands the whole meridian, and that the level may remain on the pivots whatever be the elevation of the telescope. But there is the disadvantage that the flexure of the transverse axis causes a variable collimation error depending on the zenith distance of the star to which it is directed; and moreover it has been found that in some cases the personal error of an observer is not the same in the two positions of the telescope.

To determine the direction of the meridian, it is well to erect two marks at nearly equal angular distances on either side of the north meridian line, so that the pole star crosses the vertical of each mark a short time before and after attaining its greatest eastern and western azimuths.

If now the instrument, perfectly levelled, is adjusted to have its centre wire on one of the marks, then when elevated to the star, the star will traverse the wire, and its exact position in the field at any moment can be measured by the micrometer wire. Alternate observations of the star and the terrestrial mark, combined with careful level readings and reversals of the instrument, will enable one, even with only one mark, to determine the direction of the meridian in the course of an hour with a probable error of less than a second. The second mark enables one to complete the station more rapidly and gives a check upon the work. As an instance, at Findlay Seat, in latitude 57° 35', the resulting azimuths of the two marks were 172° 45' 37".29 = 0°.20 and 152° 17' 15".61 = 0°.13, while the angle between the two marks directly measured by a theodolite was found to be 4° 31' 37".43 = 0°.23.

We now come to the consideration of the determination of time with the transit instrument. Let fig. 3 represent the sphere stereo-

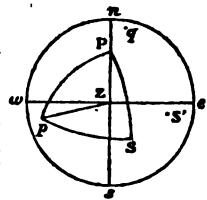

FIG. 3.

graphically projected on the plane of the horizon,— m being the meridian, z the prime vertical, Z, P the zenith and the pole. Let p be the point in which the production of the axis of the instrument meets the celestial sphere, S the position of a star when observed on a wire whose distance from the collimation centre is c . Let a be the azimuthal deviation, namely, the angle $\angle Zp$, b the level error so that $Zp = 90^\circ - b$. Let also the hour angle corresponding to p be $90^\circ - m$, and the declination of the same = δ , the star's declination being δ , and the latitude ϕ . Then to find the hour angle $ZPS = \tau$ of the star when observed, in the triangles pPS , pPZ we have, since $pPS = 90^\circ + \tau - m$,

$$-\sin c = \sin m \sin \delta + \cos m \cos \delta \sin (m - \tau),$$

$$\sin m = \sin b \sin \phi - \cos b \cos \phi \sin a,$$

$$\cos m \sin \delta = \sin \delta \cos \phi + \cos \delta \sin \phi \sin a.$$

And these equations solve the problem, however large be the errors of the instrument. Supposing, as usual, a , b , m , s to be small, we have at once $\tau = m + c \sec \delta + m \tan \delta$, which is the correction to the observed time of transit. Or, eliminating m and τ by means of the second and third equations, and putting s for the zenith distance of the star, t for the observed time of transit, the corrected time is $t + (a \sin s + b \cos s + c) / \cos \delta$. Another very convenient form for stars near the zenith is $\tau = \delta \sec \phi + c \sec \delta + m (\tan \delta - \tan \phi)$.

Suppose that in commencing to observe at a station the error of the chronometer is not known; then having secured for the instrument a very solid foundation, removed as far as possible, level and collimation errors, and placed it by estimation nearly in the meridian, let two stars differing considerably in declination be observed—the instrument not being reversed between them. From these two stars, neither of which should be a close circumpolar star, a good approximation to the chronometer error can be obtained; thus

let α_1, α_2 be the apparent clock errors given by these stars if δ_1, δ_2 be their declinations the real error is

$$e = \alpha_1 + (\alpha_1 - \alpha_2) \frac{(\tan \phi - \tan \delta_1)}{(\tan \delta_1 - \tan \delta_2)}$$

Of course this is still only approximate, but it will enable the observer (who by the help of a table of natural tangents can compute e in a few minutes) to find the meridian by placing at the proper time, which he now knows approximately, the centre wire of his instrument on the first star that passes—not near the zenith.

The transit instrument is always reversed at least once in the course of an evening's observing, the level being frequently read and recorded. It is necessary in most instruments to add a correction for the difference in size of the pivots.

The transit instrument is also used in the prime vertical for the determination of latitudes. In the preceding figure let q be the point in which the northern extremity of the axis of the instrument produced meets the celestial sphere. Let αZq be the azimuthal deviation $= a$, and b being the level error, $Zq = 90^\circ - b$; let also $\alpha Pq = r$ and $Pq = \psi$. Let S' be the position of a star when observed on a wire whose distance from the collimation centre is c , positive when to the south, and let h be the observed hour angle of the star, viz. ZPS' . Then the triangles qPS', qPZ give

$$\begin{aligned} -\sin c &= \sin \delta \cos \psi - \cos \delta \sin \psi \cos (A+r), \\ \cos \psi &= \sin \delta \sin \phi + \cos \delta \cos \phi \cos a, \\ \sin \psi \sin r &= \cos \delta \sin a. \end{aligned}$$

Now when a and b are very small, we see from the last two equations that $\psi = \phi - b$, $a = r \sin \psi$, and if we calculate ϕ' by the formula $\cot \phi' = \cot \delta \cos h$, the first equation leads us to this result—

$$\phi = \phi' + (a \sin s + b \cos s + c) / \cos s,$$

the correction for instrumental error being very similar to that applied to the observed time of transit in the case of meridian observations. When a is not very small and s is small, the formulae required are more complicated.

The method of determining latitude by transits in the prime vertical has the disadvantage of being a somewhat slow process, and of requiring a very precise knowledge of the time, a disadvantage from which the zenith telescope is free. In principle this instrument is based on the proposition that when the meridian zenith distances of two stars at their upper culminations—one being to the north and the other to the south of the zenith—are equal, the latitude is the mean of their declinations; or, if the zenith distance of a star culminating to the south of the zenith be Z , its declination being δ , and that of another culminating to the north with zenith distance Z' and declination δ' , then clearly the latitude is $\frac{1}{2}(\delta + \delta') + \frac{1}{2}(Z - Z')$. Now the zenith telescope does away with the divided circle, and substitutes the measurement micrometrically of the quantity $Z' - Z$.

In fig. 4 is shown a zenith telescope by H. Wanschaff of Berlin, which is the type used (according to the Central Bureau at Potsdam) since about 1850 for the determination of the variations of latitude due to different, but as yet imperfectly understood, influences. The instrument is supported on a strong tripod, fitted with levelling screws; to this tripod is fixed the azimuth circle and a long vertical steel axis. Fitting on this axis is a hollow axis which carries on its upper end a short transverse horizontal axis with a level. This

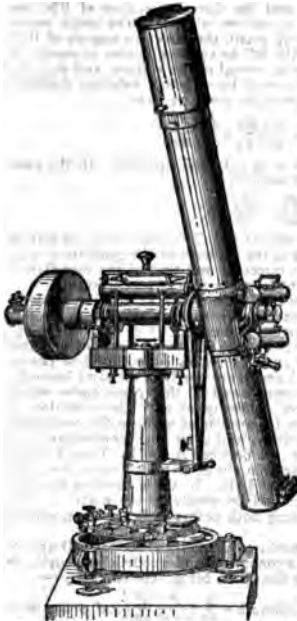

FIG. 4.—Zenith Telescope constructed for the International Stations at Mizusawa, Carlfort, Gaitersburg and Ukiah, by Hermann Wanschaff, Berlin.

latter carries the telescope, which, supported at the centre of its length, is free to rotate in a vertical plane. The telescope is thus mounted eccentrically with respect to the vertical axis around which it revolves. Two extremely sensitive levels are attached to

the telescope, which latter carries a micrometer in its eye-piece, with a screw of long range for measuring differences of zenith distance. Two levels are employed for controlling and increasing the accuracy. For this instrument stars are selected in pairs, passing north and south of the zenith, culminating within a few minutes of time and within about twenty minutes (angular) of zenith distance of each other. When a pair of stars is to be observed, the telescope is set to the mean of the zenith distances and in the plane of the meridian. The first star on passing the central meridional wire is bisected by the micrometer; then the telescope is rotated very carefully through 180° round the vertical axis, and the second star on passing through the field is bisected by the micrometer on the centre wire. The micrometer has thus measured the difference of the zenith distances, and the calculation to get the latitude is most simple. Of course it is necessary to read the level, and the observations are not necessarily confined to the centre wire. In fact if n, s be the north and south readings of the level for the south star, n', s' the same for the north star, l the value of one division of the level, m the value of one division of the micrometer, r, r' the refraction corrections, μ, μ' the micrometer readings of the south and north star, the micrometer being supposed to read from the zenith, then, supposing the observation made on the centre wire,—

$$\phi = \frac{1}{2}(\delta + \delta') + \frac{1}{2}(\mu - \mu')m + \frac{1}{2}(n + n' - s - s')l + \frac{1}{2}(r - r')$$

It is of course of the highest importance that the value m of the screw be well determined. This is done most effectually by observing the vertical movement of a close circumpolar star when at its greatest azimuth.

In a single night with this instrument a very accurate result, say with a probable error of about $0''.2$, could be obtained for latitude from, say, twenty pair of stars; but when the latitude is required to be obtained with the highest possible precision, two nights at least are necessary. The weak point of the zenith telescope lies in the circumstance that its requirements prevent the selection of stars whose positions are well fixed; very frequently it is necessary to have the declinations of the stars selected for this instrument specially observed at fixed observatories. The zenith telescope is made in various sizes from 30 to 54 in. in focal length; a 30-in. telescope is sufficient for the highest purposes and is very portable. The net observation probable-error for one pair of stars is only $\pm 0''.1$.

The zenith telescope is a particularly pleasant instrument to work with, and an observer has been known (a sergeant of Royal Engineers, on one occasion) to take every star in his list during eleven hours on a stretch, namely, from 6 o'clock p.m. until 5 a.m., and this on a very cold November night on one of the highest points of the Grampians. Observers accustomed to geodetic operations attain considerable powers of endurance. Shortly after the commencement of the observations on one of the hills in the Isle of Skye a storm carried away the wooden houses of the men and left the observatory roofless. Three observatory roofs were subsequently demolished, and for some time the observatory was used without a roof, being filled with snow every night and emptied every morning. Quite different, however, was the experience of the same party when on the top of Ben Nevis, 4406 ft. high. For about a fortnight the state of the atmosphere was unusually calm, so much so, that a lighted candle could often be carried between the tents of the men and the observatory, whilst at the foot of the hill the weather was wild and stormy.

The determination of the difference of longitude between two stations A and B resolves itself into the determination of the local time at each of the stations, and the comparison by signals of the clocks at A and B. Whenever telegraphic lines are available these comparisons are made by telegraphy. A small and delicately-made apparatus introduced into the mechanism of an astronomical clock or chronometer breaks or closes by the action of the clock an electric circuit every second. In order to record the minutes as well as seconds, one second in each minute, namely that numbered 0 or 60, is omitted. The seconds are recorded on a chronograph, which consists of a cylinder revolving uniformly at the rate of one revolution per minute covered with white paper, on which a pen having a slow movement in the direction of the axis of the cylinder describes a continuous spiral. This pen is deflected through the agency of an electromagnet every second, and thus the seconds of the clock are recorded on the chronograph by offsets from the spiral curve. An observer having his hand on a contact key in the same circuit can record in the same manner his observed times of transits of stars. The method of determination of difference of longitude is, therefore, virtually as follows. After the necessary observations for instrumental corrections, which are recorded only at the station of observation, the clock at A is put in connexion with the circuit so as to write on both chronographs, namely, that at A and that at B. Then the clock at B is made to write on both chronographs. It is clear that by this double operation one can eliminate the effect of the small interval of time consumed in the transmission of signals, for the difference of longitude obtained from the one chronograph will be in excess by as much as that obtained from the other will be in defect. The determination of the personal errors of the observers in this delicate operation is a matter of the greatest importance, as therein lies probably the chief source of residual error.

These errors can nevertheless be almost entirely avoided by using the impersonal micrometer of Dr Repsold (Hamburg, 1889). In this device there is a movable micrometer wire which is brought by hand into coincidence with the star and moved along with it; at fixed points there are electrical contacts, which replace the fixed wires. Experiments at the Geodetic Institute and Central Bureau at Potsdam in 1891 gave the following personal equations in the case of four observers:—

	Older Procedure.	New Procedure.
A-B	-0 ^o .108	-0 ^o .004
A-G	-0 ^o .314	-0 ^o .035
A-S	-0 ^o .184	-0 ^o .027
B-G	-0 ^o .225	+0 ^o .013
B-S	-0 ^o .086	-0 ^o .023
G-S	+0 ^o .109	-0 ^o .006

These results show that in the later method the personal equation is small and not so variable; and consequently the repetition of longitude determinations with exchanged observers and apparatus entirely eliminates the constant errors, the probable error of such determinations on ten nights being scarcely $\pm 0\text{''}.01$.

Calculation of Triangulation.

The surface of Great Britain and Ireland is uniformly covered by triangulation, of which the sides are of various lengths from 10 to 111 miles. The largest triangle has one angle at Snowdon in Wales, another on Slieve Donard in Ireland, and a third at Scaw Fell in Cumberland; each side is over a hundred miles and the spherical excess is 64'' . The more ordinary method of triangulation is, however, that of chains of triangles, in the direction of the meridian and perpendicular thereto. The principal triangulations of France, Spain, Austria and India are so arranged. Oblique chains of triangles are formed in Italy, Sweden and Norway, also in Germany and Russia, and in the United States. Chains are composed sometimes merely of consecutive plain triangles; sometimes, and more frequently in India, of combinations of triangles forming consecutive polygonal figures. In this method of triangulating, the sides of the triangles are generally from 20 to 30 miles in length—seldom exceeding 40.

The inevitable errors of observation, which are inseparable from all angular as well as other measurements, introduce a great difficulty into the calculation of the sides of a triangulation. Starting from a given base in order to get a required distance, it may generally be obtained in several different ways—that is, by using different sets of triangles. The results will certainly differ one from another, and probably no two will agree. The experience of the computer will then come to his aid, and enable him to say which is the most trustworthy result; but no experience or ability will carry him through a large network of triangles with anything like assurance. The only way to obtain trustworthy results is to employ the method of least squares. We cannot here give any illustration of this method as applied to general triangulation, for it is most laborious, even for the simplest cases.

Three stations, projected on the surface of the sea, give a spherical or spheroidal triangle according to the adoption of the sphere or the ellipsoid as the form of the surface. A spheroidal triangle differs from a spherical triangle, not only in that the curvatures of the sides are different one from another, but more especially in this that, while in the spherical triangle the normals to the surface at the angular points meet at the centre of the sphere, in the spheroidal triangle the normals at the angles A, B, C meet the axis of revolution of the spheroid in three different points, which we may designate α, β, γ respectively. Now the angle A of the triangle as measured by a theodolite is the inclination of the planes BA α and CA α , and the angle at B is that contained by the planes AB β and CB β . But the planes BA α and AB β containing the line AB in common cut the surface in two distinct plane curves. In order, therefore, that a spheroidal triangle may be exactly defined, it is necessary that the nature of the lines joining the three vertices be stated. In a mathematical point of view the most natural definition is that the sides be geodesic or shortest lines. C. C. G. Andrae, of Copenhagen, has also shown that other lines give a less convenient computation.

K. F. Gauss, in his treatise, *Disquisitiones generales circa superficies curvas*, entered fully into the subject of geodesic (or geodesic) triangles, and investigated expressions for the angles of a geodesic triangle whose sides are given, not certainly finite expressions, but approximations inclusive of small quantities of the fourth order, the side of the triangle or its ratio to the radius of the nearly spherical surface being a small quantity of the first order. The terms of the fourth order, as given by Gauss for any surface in general, are very complicated even when the surface is a spheroid. If we retain small quantities of the second order only, and put A, B, C for the angles of the geodesic triangle, while A, B, C are those of a plane triangle having sides equal respectively to those of the geodesic triangle, then, σ being the area of the plane triangle and a, b, r the measures of curvature at the angular points,

$$\begin{aligned} A &= A + \sigma(2a + b + r)/12, \\ B &= B + \sigma(a + 2b + r)/12, \\ C &= C + \sigma(a + b + 2r)/12. \end{aligned}$$

For the sphere $a = b = r$, and making this simplification, we obtain the theorem previously given by A. M. Legendre. With the terms of the fourth order, we have (after Andrae):

$$\begin{aligned} A - A &= \frac{\sigma}{3} + \frac{\sigma^2}{3} \left(\frac{m^2 - a^2}{20} k + \frac{a - h}{4k} \right), \\ B - B &= \frac{\sigma}{3} + \frac{\sigma^2}{3} \left(\frac{m^2 - b^2}{20} k + \frac{b - h}{4k} \right), \\ C - C &= \frac{\sigma}{3} + \frac{\sigma^2}{3} \left(\frac{m^2 - c^2}{20} k + \frac{c - h}{4k} \right), \end{aligned}$$

in which $e = \sigma k [1 + (m^2 h/B)]$, $3m^2 = a^2 + b^2 + c^2$, $3h = a + b + c$. For the ellipsoid of rotation the measure of curvature is equal to $1/\rho$, ρ and σ being the radii of curvature of the meridian and perpendicular.

It is rarely that the terms of the fourth order are required. As a rule spheroidal triangles are calculated as spherical (after Legendre), i.e. like plane triangles with a decrease of each angle of about $\sigma/3$; σ must, however, be calculated for each triangle separately with its mean measure of curvature k .

The geodesic line being the shortest that can be drawn on any surface between two given points, we may be conducted to its most important characteristics by the following considerations: let p, q be adjacent points on a curved surface; through s the middle point of the chord pq imagine a plane drawn perpendicular to pq , and let S be any point in the intersection of this plane with the surface; then $pS + Sq$ is evidently least when sS is a minimum, which is when sS is a normal to the surface; hence it follows that of all plane curves on the surface joining p, q , when those points are indefinitely near to one another, that is the shortest which is made by the normal plane. That is to say, the osculating plane at any point of a geodesic line contains the normal to the surface at that point. Imagine now three points in space, A, B, C, such that $AB = BC = c$; let the direction cosines of AB be l, m, n , those of BC l', m', n' , then x, y, z being the co-ordinates of B, those of A and C will be respectively—

$$\begin{aligned} x - c &= y - cm = z - cn \\ x + c &= y + cm' = z + cn'. \end{aligned}$$

Hence the co-ordinates of the middle point M of AC are $x + \frac{1}{2}c(l-l'), y + \frac{1}{2}c(m'-m), z + \frac{1}{2}c(n'-n)$, and the direction cosines of BM are therefore proportional to $l'-l$; $m'-m$; $n'-n$. If the angle made by BC with AB be indefinitely small, the direction cosines of BM are as $\delta l : \delta m : \delta n$. Now if AB, BC be two contiguous elements of a geodesic, then BM must be a normal to the surface, and since $\delta l, \delta m, \delta n$ are in this case represented by $\delta(dx/ds), \delta(dy/ds), \delta(dz/ds)$, and if the equation of the surface be $u = 0$, we have

$$\frac{\delta^2 x}{\delta s^2} \frac{dx}{\delta x} - \frac{\delta^2 y}{\delta s^2} \frac{dy}{\delta y} - \frac{\delta^2 z}{\delta s^2} \frac{dz}{\delta z} = 0,$$

which, however, are equivalent to only one equation. In the case of the spheroid this equation becomes

$$\gamma \frac{\delta^2 x}{\delta s^2} - x \frac{\delta^2 \gamma}{\delta s^2} = 0,$$

which integrated gives $\gamma ds - x dy = C ds$. This again may be put in the form $r \sin \alpha = C$, where α is the azimuth of the geodesic at any point—the angle between its direction and that of the meridian—and r the distance of the point from the axis of revolution.

From this it may be shown that the azimuth at A of the geodesic joining AB is not the same as the astronomical azimuth at A of B or that determined by the vertical plane ASB. Generally speaking, the geodesic lies between the two plane section curves joining A and B which are formed by the two vertical planes, supposing these points not far apart. If, however, A and B are nearly in the same latitude, the geodesic may cross (between A and B) that plane curve which lies nearest the adjacent pole of the spheroid. The condition of crossing is this. Suppose that for a moment we drop the consideration of the earth's non-sphericity, and draw a perpendicular from the pole C on AB, meeting it in S between A and B. Then A being that point which is nearest the pole, the geodesic will cross the plane curve if AS be between $\frac{1}{2}AB$ and $\frac{1}{2}AB$. If AS lie between this last value and $\frac{1}{2}AB$, the geodesic will lie wholly to the north of both plane curves, that is, supposing both points to be in the northern hemisphere.

The difference of the azimuths of the vertical section AB and of the geodesic AB, i.e. the astronomical and geodesic azimuths, is very small for all observable distances, being approximately—

$$\text{Geod. azimuth} - \text{Astr. azimuth} = \frac{1}{12} \frac{e^2}{1 - e^2} \frac{s^2}{\rho^2} (\cos^2 \phi \sin 2\alpha + \frac{1}{2} \sin 2\phi \sin \alpha),$$

in which: e and a are the numerical eccentricity and semi-major axis respectively of the meridian ellipse, ϕ and α are the latitude and azimuth at A, $s = AB$, and ρ and σ are the radii of curvature of the meridian and perpendicular at A. For $s = 100$ kilometres, only the first term is of moment; its value is $0\text{''}.008 \cos^2 \phi \sin 2\alpha$, and it lies well within the errors of observation. If we imagine the geodesic AB, it will generally trisect the angles between the vertical sections at A and B, so that the geodesic at A is $\frac{1}{3}$ astr.

the vertical section AB, and at B near the section BA.¹ The greatest sections in the vertical sections one from another is $e^2 \cos^2 \phi \sin 2a/16a^2$, in which ϕ and a are the mean latitude and azimuth respectively of the middle point of AB. For the value $s=64$ kilometres, the maximum distance is 3 mm.

An idea of the course of a longer geodetic line may be gathered from the following example. Let the line be that joining Cadiz and St Petersburg, whose approximate positions are—

	Cadiz.	St Petersburg.
	Lat. 36° 22' N.	59° 56' N.
	Long. 6° 18' W.	30° 17' E.

If G be the point on the geodetic corresponding to F on that one of the plane curves which contains the normal at Cadiz (by "corresponding" we mean that F and G are on a meridian) then G is to the north of F; at a quarter of the whole distance from Cadiz GF is 458 ft., at half the distance it is 637 ft., and at three-quarters it is 473 ft. The azimuth of the geodetic at Cadiz differs 20' from that of the vertical plane, which is the astronomical azimuth.

The azimuth of a geodetic line cannot be observed, so that the line does not enter of necessity into practical geodesy, although many formulæ connected with its use are of great simplicity and elegance. The geodetic line has always held a more important place in the science of geodesy among the mathematicians of France, Germany and Russia than has been assigned to it in the operations of the English and Indian triangulations. Although the observed angles of a triangulation are not geodetic angles, yet in the calculation of the distance and reciprocal bearings of two points which are far apart, and are connected by a long chain of triangles, we may fall upon the geodetic line in this manner:—

If A, Z be the points, then to start the calculation from A, we obtain by some preliminary calculation the approximate azimuth of Z, or the angle made by the direction of Z with the side AB or AC of the first triangle. Let P₁ be the point where this line intersects BC; then, to find P₂, where the line cuts the next triangle side CD, we make the angle BP₁P₂ such that BP₁P₂+BP₁A=180°. This fixes P₂, and P₃ is fixed by a repetition of the same process; so for P₄, P₅,... Now it is clear that the points P₁, P₂, P₃ so computed are those which would be actually fixed by an observer with a theodolite, proceeding in the following manner. Having set the instrument up at A, and turned the telescope in the direction of the computed bearing, an assistant places a mark P₁ on the line BC, adjusting it till bisected by the cross-hairs of the telescope at A. The theodolite is then placed over P₁, and the telescope turned to A; the horizontal circle is then moved through 180°. The assistant then places a mark P₂ on the line CD, so as to be bisected by the telescope, which is then moved to P₂, and in the same manner P₃ is fixed. Now it is clear that the series of points P₁, P₂, P₃ approaches to the geodetic line, for the plane of any two consecutive elements P₁P₂, P₂P₃ contains the normal at P₂.

If the objection be raised that not the geodetic azimuths but the astronomical azimuths are observed, it is necessary to consider that the observed vertical sections do not correspond to points on the sea-level but to elevated points. Since the normals of the ellipsoid of rotation do not in general intersect, there consequently arises an influence of the height on the azimuth. In the case of the measurement of the azimuth from A to B, the instrument is set to a point A' over the surface of the ellipsoid (the sea-level), and it is then adjusted to a point B', also over the surface, say at a height h'. The vertical plane containing A' and B' also contains A but not B; it must therefore be rotated through a small azimuth in order to contain B. The correction amounts approximately to $-e^2 h' \cos^2 \phi \sin 2a/2a$; in the case of h'=1000 m., its value is 0".108 cos² φ sin 2a.

This correction is therefore of greater importance in the case of observed azimuths and horizontal angles than in the previously considered case of the astronomical and the geodetic azimuths. The observed azimuths and horizontal angles must therefore also be corrected in the case, where it is required to dispense with geodetic lines.

When the angles of a triangulation have been adjusted by the method of least squares, and the sides are calculated, the next process is to calculate the latitudes and longitudes of all the stations starting from one given point. The calculated latitudes, longitudes and azimuths, which are designated geodetic latitudes, longitudes and azimuths, are not to be confounded with the observed latitudes, longitudes and azimuths, for these last are subject to somewhat large errors. Supposing the latitudes of a number of stations in the triangulation to be observed, practically the mean of these determines the position in latitude of the network, taken as a whole. So the orientation or general azimuth of the whole is inferred from all the azimuth observations. The triangulation is then supposed to be projected on a spheroid of given elements, representing as nearly as one knows the real figure of the earth. Then, taking the latitude of one point and the direction of the meridian there as given—

obtained, namely, from the astronomical observations there—one can compute the latitudes of all the other points with any degree of precision that may be considered desirable. It is necessary to employ for this purpose formulæ which will give results true even for the longest distances to the second place of decimals of seconds, otherwise there will arise an accumulation of errors from imperfect calculation which should always be avoided. For very long distances, eight places of decimals should be employed in logarithmic calculations; if seven places only are available very great care will be required to keep the last place true. Now let ϕ, ϕ' be the latitudes of two stations A and B; a, a' their mutual azimuths counted from north by east continuously from 0° to 360° ; ω their difference of longitude measured from west to east; and s the distance AB.

First compute a latitude ϕ_0 by means of the formula $\phi_0 = \phi + (s \cos a)/\rho$, where ρ is the radius of curvature of the meridian at the latitude ϕ ; this will require but four places of logarithms. Then, in the first two of the following, five places are sufficient—

$$\begin{aligned} a &= \frac{s^2}{2\rho n} \sin a \cos a, & \eta &= \frac{s^2}{2\rho n} \sin^2 a \tan \phi, \\ \phi' - \phi &= \frac{s}{\rho_0} \cos(a - \frac{1}{2}a) - \eta, \\ \omega &= \frac{s}{n} \frac{\sin(a - \frac{1}{2}a)}{\cos(\phi' + \frac{1}{2}a)}, \\ a' - a &= a \sin(\phi' + \frac{1}{2}a) - a + 180^\circ. \end{aligned}$$

Here n is the normal or radius of curvature perpendicular to the meridian; both n and ρ correspond to latitude ϕ_0 , and ρ_0 to latitude $\frac{1}{2}(\phi + \phi')$. For calculations of latitude and longitude, tables of the logarithmic values of $\rho \sin 1'$, $n \sin 1'$, and $2\rho n \sin 1'$ are necessary. The following table contains these logarithms for every ten minutes of latitude from 52° to 53° computed with the elements $a = 20926060$ and $a' = b = 295 : 294$:—

Lat.	$\text{Log} \frac{1}{\rho \sin 1'}$	$\text{Log} \frac{1}{n \sin 1'}$	$\text{Log} \frac{1}{2\rho n \sin 1'}$
52 0	7.9939434	7.9928231	0.37131
10	9309	8190	29
20	9185	8148	28
30	9066	8107	26
40	8936	8065	24
50	8812	8024	23
53 0	8688	7982	22

The logarithm in the last column is that required also for the calculation of spherical excesses, the spherical excess of a triangle being expressed by $ab \sin C/2\rho n \sin 1'$.

It is frequently necessary to obtain the co-ordinates of one point with reference to another point; that is, let a perpendicular arc be drawn from B to the meridian of A meeting it in P, then, a being the azimuth of B at A, the co-ordinates of B with reference to A are

$$AP = s \cos(a - \frac{1}{2}a), \quad BP = s \sin(a - \frac{1}{2}a),$$

where ϵ is the spherical excess of APB, viz. $s^2 \sin a \cos a$ multiplied by the quantity whose logarithm is in the fourth column of the above table.

If it be necessary to determine the geographical latitude and longitude as well as the azimuths to a greater degree of accuracy than is given by the above formulæ, we make use of the following formula: given the latitude ϕ of A, and the azimuth a and the distance s of B, to determine the latitude ϕ' and longitude ω of B, and the back azimuth a' . Here it is understood that a' is symmetrical to a , so that $a'' + a' = 360^\circ$.

Let

$$\theta = s\Delta/a, \quad \text{where } \Delta = (1 - e^2 \sin^2 \phi)^{\frac{1}{2}}$$

and

$$\zeta = \frac{e^2 \theta}{4(1 - e^2) \cos^2 \phi \sin 2a}, \quad \zeta' = \frac{e^2 \theta}{6(1 - e^2) \cos^2 \phi \cos^2 a};$$

ζ, ζ' are always very minute quantities even for the longest distances; then, putting $x = 90^\circ - \phi$,

$$\tan \frac{a' + \zeta' - \omega}{2} = \frac{\sin \frac{1}{2}(x - \theta - \zeta')}{\sin \frac{1}{2}(x + \theta + \zeta')} \cot \frac{a}{2}$$

$$\tan \frac{a' + \zeta' + \omega}{2} = \frac{\cos \frac{1}{2}(x - \theta - \zeta')}{\cos \frac{1}{2}(x + \theta + \zeta')} \cot \frac{a}{2}$$

$$\phi' - \phi = \frac{s \sin \frac{1}{2}(a' + \zeta' - a)}{\rho_0 \sin \frac{1}{2}(a' + \zeta' + a)} \left(1 + \frac{\theta}{12} \cos \frac{a'' - a}{2} \right);$$

here ρ_0 is the radius of curvature of the meridian for the mean latitude $\frac{1}{2}(\phi + \phi')$. These formulæ are approximate only, but they are sufficiently precise even for very long distances.

For lines of any length the formulæ of F. W. Bessel (*Astr. Nach.*, 1823, iv. 241) are suitable.

If the two points A and B be defined by their geographical

¹ See a paper "On the Course of Geodetic Lines on the Earth's Surface," in the *Phil. Mag.* 1870; *Helmert, Theorien der höheren Geodäsie*, i. 321.

616 GEOFFREY (PLANTAGENET)—GEOFFREY OF MONMOUTH

Saintonge in fief against his son. In 1036 Geoffrey Martel had to liberate William the Fat, on payment of a heavy ransom, but the latter having died in 1038, and the second son of William the Great, Odo, duke of Gascony, having fallen in his turn at the siege of Mauzé (10th of March 1039) Geoffrey made peace with his father in the autumn of 1039, and had his wife's two sons recognized as dukes. About this time, also, he had interfered in the affairs of Maine, though without much result, for having sided against Gervais, bishop of Le Mans, who was trying to make himself guardian of the young count of Maine, Hugh, he had been beaten and forced to make terms with Gervais in 1038. In 1040 he succeeded his father in Anjou and was able to conquer Touraine (1044) and assert his authority over Maine (see ANJOU). About 1050 he repudiated Agnes, his first wife, and married Grécie, the widow of Bellay, lord of Montreuil-Bellay (before August 1052), whom he subsequently left in order to marry Adela, daughter of a certain Count Odo. Later he returned to Grécie, but again left her to marry Adelaïde the German. When, however, he died on the 14th of November 1060, at the monastery of St Nicholas at Angers, he left no children, and transmitted the countship to Geoffrey the Bearded, the eldest of his nephews (see ANJOU).

See Louis Halphen, *Le Comté d'Anjou au XI^e siècle* (Paris, 1906). A summary biography is given by Célestin Port, *Dictionnaire historique, géographique et biographique de Maine-et-Loire* (3 vols., Paris-Angers, 1874-1878), vol. ii, pp. 252-253, and a sketch of the wars by Kate Norgate, *England under the Angevin Kings* (2 vols., London, 1887), vol. i, chs. iii, iv. (L. H.*)

GEOFFREY, surnamed **PLANTAGENET** [or **PLANTEGENET**] (1113-1151), count of Anjou, was the son of Count Fulk the Young and of Eremburga (or Arembourg) of La Flèche; he was born on the 24th of August 1113. He is also called "le bel" or "the handsome," and received the surname of Plantagenet from the habit which he is said to have had of wearing in his cap a sprig of broom (*genêt*). In 1127 he was made a knight, and on the 2nd of June 1129 married Matilda, daughter of Henry I. of England, and widow of the emperor Henry V. Some months afterwards he succeeded to his father, who gave up the countship when he definitively went to the kingdom of Jerusalem. The years of his government were spent in subduing the Angevin barons and in conquering Normandy (see ANJOU). In 1151, while returning from the siege of Montreuil-Bellay, he took cold, in consequence of bathing in the Loir at Château-du-Loir, and died on the 7th of September. He was buried in the cathedral of Le Mans. By his wife Matilda he had three sons: Henry Plantagenet, born at Le Mans on Sunday, the 5th of March 1133; Geoffrey, born at Argentan on the 1st of June 1134; and William Long-Sword, born on the 22nd of July 1136.

See Kate Norgate, *England under the Angevin Kings* (2 vols., London, 1887), vol. i, chs. v-viii.; Célestin Port, *Dictionnaire historique, géographique et biographique de Maine-et-Loire* (3 vols., Paris-Angers, 1874-1878), vol. ii, pp. 254-256. A history of Geoffrey le Bel has yet to be written; there is a biography of him written in the 12th century by Jean, a monk of Marmoutier, *Historia Gualfredi, ducis Normannorum et comitis Andegavorum*, published by Marchegay et Salmon; "Chroniques des comtes d'Anjou" (*Société de l'histoire de France*, Paris, 1856), pp. 229-310. (L. H.*)

GEOFFREY (1158-1186), duke of Brittany, fourth son of the English king Henry II. and his wife Eleanor of Aquitaine, was born on the 23rd of September 1158. In 1167 Henry suggested a marriage between Geoffrey and Constance (d. 1201), daughter and heiress of Conan IV., duke of Brittany (d. 1171); and Conan not only assented, perhaps under compulsion, to this proposal, but surrendered the greater part of his unruly duchy to the English king. Having received the homage of the Breton nobles, Geoffrey joined his brothers, Henry and Richard, who, in alliance with Louis VII. of France, were in revolt against their father; but he made his peace in 1174, afterwards helping to restore order in Brittany and Normandy, and aiding the new French king, Philip Augustus, to crush some rebellious vassals. In July 1181 his marriage with Constance was celebrated, and practically the whole of his subsequent life was spent in warfare with his brother Richard. In 1183 he made peace with his father, who had come to Richard's assistance; but a fresh struggle soon broke out for the possession of Anjou, and Geoffrey was in Paris treating for aid with Philip Augustus, when he died on the 19th of August

1186. He left a daughter, Eleanor, and his wife bore a posthumous son, the unfortunate Arthur.

GEOFFREY (c. 1152-1212), archbishop of York, was a bastard son of Henry II., king of England. He was distinguished from his legitimate half-brothers by his consistent attachment and fidelity to his father. He was made bishop of Lincoln at the age of twenty-one (1173); but though he enjoyed the temporalities he was never consecrated and resigned the see in 1183. He then became his father's chancellor, holding a large number of lucrative benefices in plurality. Richard nominated him archbishop of York in 1186, but he was not consecrated till 1191, or enthroned till 1194. Geoffrey, though of high character, was a man of uneven temper; his history in chiefly one of quarrels, with the see of Canterbury, with the chancellor William Longchamp, with his half-brothers Richard and John, and especially with his canons at York. This last dispute kept him in litigation before Richard and the pope for many years. He led the clergy in their refusal to be taxed by John and was forced to fly the kingdom in 1207. He died in Normandy on the 12th of December 1212.

See Giraldus Cambrensis, *Vita Galfridi*; Stubbs's prefaces to *Roger de Howden*, vols. iii and iv. (Rolls Series). (H. W. C. D.)

GEOFFREY DE MONTBRAY (d. 1093), bishop of Coutances (*Constantiensis*), a right-hand man of William the Conqueror, was a type of the great feudal prelate, warrior and administrator at need. He knew, says Orderic, more about marshalling mailed knights than edifying psalm-singing clerks. Obtaining, as a young man, in 1048, the see of Coutances, by his brother's influence (see MOWBRAY), he raised from his fellow nobles and from their Sicilian spoils funds for completing his cathedral, which was consecrated in 1056. With bishop Odo, a warrior like himself, he was on the battle-field of Hastings, exhorting the Normans to victory; and at William's coronation it was he who called on them to acclaim their duke asking. His reward in England was a mighty fief scattered over twelve counties. He accompanied William on his visit to Normandy (1067), but, returning, led a royal force to the relief of Montacute in September 1069. In 1075 he again took the field, leading with Bishop Odo a vast host against the rebel earl of Norfolk, whose stronghold at Norwich he besieged and captured.

Meanwhile the Conqueror had invested him with important judicial functions. In 1072 he had presided over the great Kentish suit between the primate and Bishop Odo, and about the same time over those between the abbot of Ely and his despoilers, and between the bishop of Worcester and the abbot of Ely, and there is some reason to think that he acted as a Domesday commissioner (1086), and was placed about the same time in charge of Northumberland. The bishop, who attended the Conqueror's funeral, joined in the great rising against William Rufus next year (1088), making Bristol, with which (as Domesday shows) he was closely connected and where he had built a strong castle, his base of operations. He burned Bath and ravaged Somerset, but had submitted to the king before the end of the year. He appears to have been at Dover with William in January 1090, but, withdrawing to Normandy, died at Coutances three years later. In his fidelity to Duke Robert he seems to have there held out for him against his brother Henry, when the latter obtained the Cotentin.

See E. A. Freeman, *Norman Conquest and William Rufus*; J. H. Round, *Feudal England*; and, for original authorities, the works of Orderic Vitalis and William of Poitiers, and of Florence of Worcester; the Anglo-Saxon Chronicle; William of Malmesbury's *Gesta pontificum*, and Lanfranc's works, ed. Giles; Domesday Book. (J. H. R.)

GEOFFREY OF MONMOUTH (d. 1154), bishop of St Asaph and writer on early British history, was born about the year 1100. Of his early life little is known, except that he received a liberal education under the eye of his paternal uncle, Uchtryd, who was at that time archdeacon, and subsequently bishop, of Llandaf. In 1129 Geoffrey appears at Oxford among the witnesses of an Osney charter. He subscribes himself Geoffrey Arturus; from this we may perhaps infer that he had already begun his experiments in the manufacture of Celtic mythology. A first edition of his *Historia Britonum* was in circulation by the year

1139, although the text which we possess appears to date from 1147. This famous work, which the author has the audacity to place on the same level with the histories of William of Malmesbury and Henry of Huntingdon, professes to be a translation from a Celtic source; "a very old book in the British tongue" which Walter, archdeacon of Oxford, had brought from Brittany. Walter the archdeacon is a historical personage; whether his book has any real existence may be fairly questioned. There is nothing in the matter or the style of the *Historia* to preclude us from supposing that Geoffrey drew partly upon confused traditions, partly on his own powers of invention, and to a very slight degree upon the accepted authorities for early British history. His chronology is fantastic and incredible; William of Newburgh justly remarks that, if we accepted the events which Geoffrey relates, we should have to suppose that they had happened in another world. William of Newburgh wrote, however, in the reign of Richard I. when the reputation of Geoffrey's work was too well established to be shaken by such criticisms. The fearless romancer had achieved an immediate success. He was patronized by Robert, earl of Gloucester, and by two bishops of Lincoln; he obtained, about 1140, the archdeaconry of Llandaff "on account of his learning"; and in 1151 was promoted to the see of St. Asaph.

Before his death the *Historia Britonum* had already become a model and a quarry for poets and chroniclers. The list of imitators begins with Geoffrey Gaimar, the author of the *Estorie des Engles* (c. 1147), and Wace, whose *Roman de Brut* (1155) is partly a translation and partly a free paraphrase of the *Historia*. In the next century the influence of Geoffrey is unmistakably attested by the *Brut* of Layamon, and the rhyming English chronicle of Robert of Gloucester. Among later historians who were deceived by the *Historia Britonum* it is only needful to mention Higdon, Hardyng, Fabyan (1512), Holinshed (1580) and John Milton. Still greater was the influence of Geoffrey upon those writers who, like Warner in *Albion's England* (1586), and Drayton in *Polybion* (1613), deliberately made their accounts of English history as poetical as possible. The stories which Geoffrey preserved or invented were not infrequently a source of inspiration to literary artists. The earliest English tragedy, *Corbodus* (1565), the *Mirror for Magistrates* (1587), and Shakespeare's *Lear*, are instances in point. It was, however, the Arthurian legend which of all his fabrications attained the greatest vogue. In the work of expanding and elaborating this theme the successors of Geoffrey went as far beyond him as he had gone beyond Nennius; but he retains the credit due to the founder of a great school. Marie de France, who wrote at the court of Henry II., and Chrétien de Troyes, her French contemporary, were the earliest of the avowed romancers to take up the theme. The succeeding age saw the Arthurian story popularized, through translations of the French romances, as far afield as Germany and Scandinavia. It produced in England the *Roman du Saint Graal* and the *Roman de Merlin*, both from the pen of Robert de Borron; the *Roman de Lancelot*; the *Roman de Tristan*, which is attributed to a fictitious Lucas de Gast. In the reign of Edward IV. Sir Thomas Malory paraphrased and arranged the best episodes of these romances in English prose. His *Morte d'Arthur*, printed by Caxton in 1485, epitomizes the rich mythology which Geoffrey's work had first called into life, and gave the Arthurian story a lasting place in the English imagination. The influence of the *Historia Britonum* may be illustrated in another way, by enumerating the more familiar of the legends to which it first gave popularity. Of the twelve books into which it is divided only three (Bks. IX., X., XI.) are concerned with Arthur. Earlier in the work, however, we have the adventures of Brutus; of his follower Corineus, the vanquisher of the Cornish giant Goemagol (Gogmagog); of Locrinus and his daughter Sabre (immortalized in Milton's *Comus*); of Bladud the builder of Bath; of Lear and his daughters; of the three pairs of brothers, Ferrer and Porrex, Brennius and Belinus, Eliure and Peridure. The story of Vortigern and Rowena takes its final form in the *Historia Britonum*; and Merlin makes his first appearance in the prelude to the Arthur legend. Besides

the *Historia Britonum* Geoffrey is also credited with a *Life of Merlin* composed in Latin verse. The authorship of this work has, however, been disputed, on the ground that the style is distinctly superior to that of the *Historia*. A minor composition, the *Prophecies of Merlin*, was written before 1136, and afterwards incorporated with the *Historia*, of which it forms the seventh book.

For a discussion of the manuscripts of Geoffrey's work, see Sir T. D. Hardy's *Descriptive Catalogue* (Rolls Series), i. pp. 341 ff. The *Historia Britonum* has been critically edited by San Marte (Halle, 1854). There is an English translation by J. A. Giles (London, 1842). The *Vita Merlini* has been edited by F. Michel and T. Wright (Paris, 1837). See also the *Dublin Univ. Magazine* for April 1876, for an article by T. Gilray on the literary influence of Geoffrey; G. Heeger's *Trojanerfahrt der Briten* (1889); and La Borderie's *Etudes historiques bretonnes* (1883). (H. W. C. D.)

GEOFFREY OF PARIS (d. c. 1330), French chronicler, was probably the author of the *Chronique métrique de Philippe le Bel*, or *Chronique rimée de Geoffroi de Paris*. This work, which deals with the history of France from 1300 to 1316, contains 7918 verses, and is valuable as that of a writer who had a personal knowledge of many of the events which he relates. Various short historical poems have also been attributed to Geoffrey, but there is no certain information about either his life or his writings.

The *Chronique* was published by J. A. Buchon in his *Collection des chroniques*, tome ix. (Paris, 1827), and it has also been printed in tome xxii. of the *Recueil des historiens des Gaules et de la France* (Paris, 1865). See C. Paris, *Histoire de la littérature française au moyen âge* (Paris, 1890); and A. Molinier, *Les Sources de l'histoire de France*, tome iii. (Paris, 1903).

GEOFFREY THE BAKER (d. c. 1360), English chronicler, is also called Walter of Swinbroke, and was probably a secular clerk at Swinbroke in Oxfordshire. He wrote a *Chronicon Angliæ temporibus Edwardi II. et Edwardi III.*, which deals with the history of England from 1303 to 1356. From the beginning until about 1324 this work is based upon Adam Murimuth's *Continuatio chronicarum*, but after this date it is valuable and interesting, containing information not found elsewhere, and closing with a good account of the battle of Poitiers. The author obtained his knowledge about the last days of Edward II. from William Bisschop, a companion of the king's murderers, Thomas Gurney and John Maltravers. Geoffrey also wrote a *Chroniculum* from the creation of the world until 1336, the value of which is very slight. His writings have been edited with notes by Sir E. M. Thompson as the *Chronicon Gulfridi le Baker de Swynebroke* (Oxford, 1889). Some doubt exists concerning Geoffrey's share in the compilation of the *Vita et mors Edwardi II.*, usually attributed to Sir Thomas de la More, or Moor, and printed by Camden in his *Anglica scripta*. It has been maintained by Camden and others that More wrote an account of Edward's reign in French, and that this was translated into Latin by Geoffrey and used by him in compiling his *Chronicon*. Recent scholarship, however, asserts that More was no writer, and that the *Vita et mors* is an extract from Geoffrey's *Chronicon*, and was attributed to More, who was the author's patron. In the main this conclusion substantiates the verdict of Stubbs, who has published the *Vita et mors* in his *Chronicles of the reigns of Edward I. and Edward II.* (London, 1883). The manuscripts of Geoffrey's works are in the Bodleian library at Oxford.

GEOFFRIN, MARIE THÉRÈSE RODET (1699-1777), a Frenchwoman who played an interesting part in French literary and artistic life, was born in Paris in 1699. She married, on the 19th of July 1713, Pierre François Geoffrin, a rich manufacturer and lieutenant-colonel of the National Guard, who died in 1750. It was not till Mme Geoffrin was nearly fifty years of age that we begin to hear of her as a power in Parisian society. She had learned much from Mme de Tencin, and about 1748 began to gather round her a literary and artistic circle. She had every week two dinners, on Monday for artists, and on Wednesday for her friends the Encyclopaedists and other men of letters. She received many foreigners of distinction, Hume and Horace Walpole among others. Walpole spent much time in her society before he was finally attached to Mme du Deffand, and speaks of her in his letters as a model of common sense. She was indeed somewhat of a small tyrant in her circle. She had adopted the pose of an old woman earlier than necessary, and her coquetry, &c.

such it can be called, took the form of being mother and mentor to her guests, many of whom were indebted to her generosity for substantial help. Although her aim appears to have been to have the *Encyclopédie* in conversation and action around her, she was extremely displeased with any of her friends who were so rash as to incur open disgrace. Marmontel lost her favour after the official censure of *Bélisaire*, and her advanced views did not prevent her from observing the forms of religion. A devoted Parisian, Mme Geoffrin rarely left the city, so that her journey to Poland in 1766 to visit the king, Stanislas Poniatowski, whom she had known in his early days in Paris, was a great event in her life. Her experiences induced a sensible gratitude that she had been born "*Française*" and "*particulière*." In her last illness her daughter, Thérèse, marquise de la Ferté Imbault, excluded her mother's old friends so that she might die as a good Christian, a proceeding wittily described by the old lady: "My daughter is like Godfrey de Bouillon, she wished to defend my tomb from the infidels." Mme Geoffrin died in Paris on the 6th of October 1777.

See *Correspondance inédite du roi Stanislas Auguste Poniatowski et de Madame Geoffrin*, edited by the comte de Mouÿ (1875); P. de Ségur, *Le Royaume de la rue Saint-Honoré, Madame Geoffrin et sa fille* (1897); A. Torney, *Un Bureau d'esprit au XVIII^e siècle: le salon de Madame Geoffrin* (1895); and Janet Aldis, *Madame Geoffrin, her Salon and her Times, 1750-1777* (1905).

GEOFFROY, ÉTIENNE FRANÇOIS (1672-1731), French chemist, born in Paris on the 13th of February 1672, was first an apothecary and then practised medicine. After studying at Montpellier he accompanied Marshal Tallard on his embassy to London in 1698 and thence travelled to Holland and Italy. Returning to Paris he became professor of chemistry at the Jardin du Roi and of pharmacy and medicine at the Collège de France, and dean of the faculty of medicine. He died in Paris on the 6th of January 1731. His name is best known in connexion with his tables of affinities (*tables des rapports*), which he presented to the French Academy in 1718 and 1720. These were lists, prepared by collating observations on the actions of substances one upon another, showing the varying degrees of affinity exhibited by analogous bodies for different reagents, and they retained their vogue for the rest of the century, until displaced by the profounder conceptions introduced by C. L. Berthollet. Another of his papers dealt with the delusions of the philosopher's stone, but nevertheless he believed that iron could be artificially formed in the combustion of vegetable matter. His *Tractatus de materia medica*, published posthumously in 1741, was long celebrated.

His brother CLAUDE JOSEPH, known as Geoffroy the younger (1685-1752), was also an apothecary and chemist who, having a considerable knowledge of botany, devoted himself especially to the study of the essential oils in plants.

GEOFFROY, JULIEN LOUIS (1743-1814), French critic, was born at Rennes in 1743. He studied in the school of his native town and at the Collège Louis le Grand in Paris. He took orders and fulfilled for some time the humble functions of an usher, eventually becoming professor of rhetoric at the *Collège Mazarin*. A bad tragedy, *Caton*, was accepted at the *Théâtre Français*, but was never acted. On the death of Élie Fréron in 1776 the other collaborators in the *Année Littéraire* asked Geoffroy to succeed him, and he conducted the journal until in 1792 it ceased to appear. Geoffroy was a bitter critic of Voltaire and his followers, and made for himself many enemies. An enthusiastic royalist, he published with Fréron's brother-in-law, the abbé Thomas Royou (1741-1792), a journal, *L'Ami du roi* (1790-1792), which possibly did more harm than good to the king's cause by its ill-advised partisanship. During the Terror Geoffroy hid in the neighbourhood of Paris, only returning in 1799. An attempt to revive the *Année Littéraire* failed, and Geoffroy undertook the dramatic feuilleton of the *Journal des débats*. His scathing criticisms had a success of notoriety, but their popularity was ephemeral, and the publication of them (5 vols., 1819-1820) as *Cours de littérature dramatique* proved a failure. He was also the author of a perfunctory *Commentaire* on the works of Racine prefixed to Lenormant's edition (1808). He died in Paris on the 27th of February 1814.

GEOFFROY SAINT-HILAIRE, ÉTIENNE (1772-1844), French naturalist, was the son of Jean Gérard Geoffroy, procurator and magistrate of Étampes, Seine-et-Oise, where he was born on the 15th of April 1772. Destined for the church he entered the college of Navarre, in Paris, where he studied natural philosophy under M. J. Brisson; and in 1788 he obtained one of the canonicates of the chapter of Sainte Croix at Étampes, and also a benefice. Science, however, offered him a more congenial career, and he gained from his father permission to remain in Paris, and to attend the lectures at the Collège de France and the Jardin des Plantes, on the condition that he should also read law. He accordingly took up his residence at Cardinal Lemoine's college, and there became the pupil and soon the esteemed associate of Brisson's friend, the abbé Haüy, the mineralogist. Having, before the close of the year 1790, taken the degree of bachelor in law, he became a student of medicine, and attended the lectures of A. F. de Fourcroy at the Jardin des Plantes, and of L. J. M. Daubenton at the Collège de France. His studies at Paris were at length suddenly interrupted, for, in August 1792, Haüy and the other professors of Lemoine's college, as also those of the college of Navarre, were arrested by the revolutionists as priests, and confined in the prison of St Firmin. Through the influence of Daubenton and others Geoffroy on the 14th of August obtained an order for the release of Haüy in the name of the Academy; still the other professors of the two colleges, save C. F. Lhomond, who had been rescued by his pupil J. L. Tallien, remained in confinement. Geoffroy, foreseeing their certain destruction if they remained in the hands of the revolutionists, determined if possible to secure their liberty by stratagem. By bribing one of the officials at St Firmin, and disguising himself as a commissioner of prisons, he gained admission to his friends, and entreated them to effect their escape by following him. All, however, dreading lest their deliverance should render the doom of their fellow-captives the more certain, refused the offer and one priest only, who was unknown to Geoffroy, left the prison. Already on the night of the 2nd of September the massacre of the proscribed had begun, when Geoffroy, yet int not on saving the life of his friends and teachers, repaired to St Firmin. At 4 o'clock on the morning of the 3rd of September, after eight hours' waiting, he by means of a ladder assisted the escape of twelve ecclesiastics, not of the number of his acquaintance, and then the approach of dawn and the discharge of a gun directed at him warned him, his chief purpose unaccomplished, to return to his lodgings. Leaving Paris he retired to Étampes, where, in consequence of the anxieties of which he had lately been the prey, and the horrors which he had witnessed, he was for some time seriously ill. At the beginning of the winter of 1792 he returned to his studies in Paris, and in March of the following year Daubenton, through the interest of Bernardin de Saint Pierre, procured him the office of sub-keeper and assistant demonstrator of the cabinet of natural history, vacant by the resignation of B. G. E. Lacépède. By a law passed in June 1793, Geoffroy was appointed one of the twelve professors of the newly constituted museum of natural history, being assigned the chair of zoology. In the same year he busied himself with the formation of a menagerie at that institution.

In 1794 through the introduction of A. H. Temier he entered into correspondence with Georges Cuvier, to whom, after the perusal of some of his manuscripts, he wrote: "Venez jouer parmi nous le rôle de Linné, d'un autre législateur de l'histoire naturelle." Shortly after the appointment of Cuvier as assistant at the Muséum d'Histoire Naturelle, Geoffroy received him into his house. The two friends wrote together five memoirs on natural history, one of which, on the classification of mammals, puts forward the idea of the subordination of characters upon which Cuvier based his zoological system. It was in a paper entitled "Histoire des Makis, ou singes de Madagascar," written in 1795, that Geoffroy first gave expression to his views on "the unity of organic composition," the influence of which is perceptible in all his subsequent writings; nature, he observes, presents us with only one plan of construction, the same in principle, but varied in its accessory parts.

Geoffroy was chosen a member of the great scientific to Egypt, and on the capitulation of Alexandria in 1801, he took part in resisting the claim made by the general to the collections of the expedition, declaring that, if demand persisted in, history would have to record how he had burnt a library in Alexandria. Early in January 1802 he returned to his accustomed labours in Paris. He had a member of the academy of sciences of that city in number 1807. In March of the following year the emperor, already recognized his national services by the award of the legion of honour, selected him to visit the king of Portugal, for the purpose of procuring collections in m, and in the face of considerable opposition from the king he eventually was successful in retaining them as a permanent possession for his country. In 1809, the year after he returned to France, he was made professor of zoology at the faculty of sciences at Paris, and from that period he devoted more exclusively than before to anatomical study. In 1810 he gave to the world the first part of his celebrated *Philosophie zoologique*, the second volume of which, published in 1813, and in subsequent memoirs account for the formation of species on the principle of arrest of development, and of the retention of similar parts. When, in 1830, Geoffroy proposed to apply to the invertebrata his views as to the unity of composition, he found a vigorous opponent in Georges Cuvier, and the discussion between them, continued up to the death of the latter, soon attracted the attention of the public throughout Europe. Geoffroy, a synthesist, conceived in accordance with his theory of unity of plan in organic life, that all animals are formed of the same elements, in the same number, and with the same connexions: homologous members, however they differ in form and size, must remain associated in the same invariable order. With Goethe he held that there is a law of compensation or balancing of growth, so that no one organ take on an excess of development, it is at the expense of some other part; and he maintained that, since life does not make sudden leaps, even organs which are superfluous in one species, if they have played an important part in the evolution of the same family, are retained as rudiments, simply to testify to the permanence of the general plan of creation. It is a conviction that, owing to the conditions of life, the forms had not been perpetuated since the origin of all things although it was not his belief that existing species are modified. Cuvier, who was an analytical observer of the world, admitted only the prevalence of "laws of co-existence" in animal organs, and maintained the absolute stability of species, which he declared had been created in regard to the circumstances in which they were placed, and contrived with a view to the function it had to perform. In Geoffroy's considerations, the effect for

of 1830 Geoffroy became blind, and some months later he had a paralytic attack. From that time his strength gradually failed. He resigned his chair at the museum in 1841, and died at Paris on the 19th of June 1844.

He wrote: *Catalogue des mammifères du Muséum National et Naturelle* (1813), not quite completed; *Philosophie anatomique. Des organes respiratoires* (1818), and t. ii., *Des monstruosités* (1822); *Système dentaire des mammifères et des oiseaux* (1824); *Sur le principe de l'unité de composition* (1828); *Cours de l'histoire naturelle des mammifères* (1830); *Études progressives naturalistes* (1835); *Fragments biographiques* (1832); *Synthétiques, historiques et physiologiques de philosophie zoologique* (1838), and other works; also part of the *Description de la commission des sciences* (1821-1830), and, with Cuvier (1773-1838), a younger brother of G. Cuvier, *Histoire des mammifères* (4 vols., 1820-1842); besides numerous papers on such subjects as the anatomy of marsupials, ruminant and fish, the vertebrate theory of the skull, the opercula of teratology, palaeontology and the influence of surrounding conditions in modifying animal forms.

He translated, and wrote the doctrine of Etienne Geoffroy Saint-Hilaire, son fils M. Isidore Geoffroy Saint-Hilaire (Paris and G., 1847), to which is appended a list of Geoffroy's works; in *Biog. universelle*, t. xvi. (1856).

GEOFFROY SAINT-HILAIRE, ISIDORE (1805-1861), French zoologist, son of the preceding, was born at Paris on the 16th of December 1805. In his earlier years he showed an aptitude for mathematics, but eventually he devoted himself to the study of natural history and of medicine, and in 1824 he was appointed assistant naturalist to his father. On the occasion of his taking the degree of doctor of medicine in September 1829, he read a thesis entitled *Propositions sur la monstruosité, considérée chez l'homme et les animaux*; and in 1832-1837 was published his great teratological work, *Histoire générale et particulière des anomalies de l'organisation chez l'homme et les animaux*, 3 vols. 8vo. with 20 plates. In 1829 he delivered for his father the second part of a course of lectures on ornithology, and during the three following years he taught zoology at the Athénée, and teratology at the École pratique. He was elected a member of the academy of sciences at Paris in 1833, was in 1837 appointed to act as deputy for his father at the faculty of sciences in Paris, and in the following year was sent to Bordeaux to organize a similar faculty there. He became successively inspector of the academy of Paris (1840), professor of the museum on the retirement of his father (1841), inspector-general of the university (1844), a member of the royal council for public instruction (1845), and on the death of H. M. D. de Blainville, professor of zoology at the faculty of sciences (1850). In 1854 he founded the Acclimatization Society of Paris, of which he was president. He died at Paris on the 10th of November 1861.

Besides the above-mentioned works, he wrote: *Essais de zoologie générale* (1841); *Vie . . . d'Etienne Geoffroy Saint-Hilaire* (1847); *Acclimatation et domestication des animaux utiles* (1849; 4th ed., 1861); *Lettres sur les substances alimentaires et particulièrement sur la viande de cheval* (1856); and *l'histoire naturelle générale des règnes organiques* (3 vols., 1854-1862), which was not quite completed. He was the author also of various papers on zoology, comparative anatomy and palaeontology.

GEOGRAPHY (Gr. γῆ, earth, and γράφω, to write), the exact and organized knowledge of the distribution of phenomena on the surface of the earth. The fundamental basis of geography is the vertical relief of the earth's crust, which controls all mobile distributions. The grander features of the relief of the lithosphere or stony crust of the earth control the distribution of the hydrosphere or collected waters which gather into the hollows, filling them up to a height corresponding to the volume, and thus producing the important practical division of the surface into land and water. The distribution of the mass of the atmosphere over the surface of the earth is also controlled by the relief of the crust, its greater or lesser density at the surface corresponding to the lesser or greater elevation of the surface. The simplicity of the zonal distribution of solar energy on the earth's surface, which would characterize a uniform globe, is entirely destroyed by the dissimilar action of land and water with regard to radiant heat, and by the influence of crust-forms on the direction of the resulting circulation. The influence of physical environment becomes clearer and stronger when the distribution of plant and animal life is considered, and if it is less distinct in the case of man, the reason is found in the modifications of environment consciously produced by human effort. Geography is a synthetic science, dependent for the data with which it deals on the results of specialized sciences such as astronomy, geology, oceanography, meteorology, biology and anthropology, as well as on topographical description. The physical and natural sciences are concerned in geography only so far as they deal with the forms of the earth's surface, or as regards the distribution of phenomena. The distinctive task of geography as a science is to investigate the control exercised by the crust-forms directly or indirectly upon the various mobile distributions. This gives to it unity and definiteness, and renders superfluous the attempts that have been made from time to time to define the limits which divide geography from geology on the one hand and from history on the other. It is essential to classify the subject-matter of geography in such a manner as to give prominence not only to facts, but to their mutual relations and their natural and inevitable order.

The fundamental conception of geography is form, including

the figure of the earth and the varieties of crustal relief. Hence mathematical geography (see MAP), including cartography as a practical application, comes first. It merges into physical geography, which takes account of the forms of the lithosphere (geomorphology), and also of the distribution of the hydrosphere and the rearrangements resulting from the workings of solar energy throughout the hydrosphere and atmosphere (oceanography and climatology). Next follows the distribution of plants and animals (biogeography), and finally the distribution of mankind and the various artificial boundaries and redistributions (anthropogeography). The applications of anthropogeography to human uses give rise to political and commercial geography, in the elucidation of which all the earlier departments or stages have to be considered, together with historical and other purely human conditions. The evolutionary idea has revolutionized and unified geography as it did biology, breaking down the old hard-and-fast partitions between the various departments, and substituting the study of the nature and influence of actual terrestrial environments for the earlier motive, the discovery and exploration of new lands.

HISTORY OF GEOGRAPHICAL THEORY

The earliest conceptions of the earth, like those held by the primitive peoples of the present day, are difficult to discover and almost impossible fully to grasp. Early generalizations, as far as they were made from known facts, were usually expressed in symbolic language, and for our present purpose it is not profitable to speculate on the underlying truths which may sometimes be suspected in the old mythological cosmogonies.

The first definite geographical theories to affect the western world those evolved, or at least first expressed, by the Greeks.

Early Greek ideas. The earliest theoretical problem of geography was the form of the earth. The natural supposition that the earth is a flat disk, circular or elliptical in outline, had in the time of Homer acquired a special definiteness by the introduction of the idea of the ocean river bounding the whole, an application of imperfectly understood observations. Thales of Miletus is claimed as the first exponent of the idea of a spherical earth; but, although this does not appear to be warranted, his disciple Anaximander (c. 580 B.C.) put forward the theory that the earth had the figure of a solid body hanging freely in the centre of the hollow sphere of the starry heavens.

The Pythagorean school of philosophers adopted the theory of a spherical earth, but from metaphysical rather than scientific reasons; their convincing argument was that a sphere being the most perfect solid figure was the only one worthy to circumscribe the dwelling-place of man. The division of the sphere into parallel zones and some of the consequences of this generalization seem to have presented themselves to Parmenides (c. 450 B.C.); but these ideas did not influence the Ionian school of philosophers, who in their treatment of geography preferred to deal with facts demonstrable by **Hecataeus**, travel rather than with speculations. Thus Hecataeus, claimed by H. F. Tozer¹ as the father of geography on account of his *Periodos*, or general treatise on the earth, did not advance beyond the primitive conception of a circular disk. He systematized the form of the land within the ring of ocean—the *oikoumene*, or habitable world—by recognizing two continents: Europe to the north, and Asia to the south of the midland sea.

Herodotus, Herodotus, equally oblivious of the sphere, criticized and ridiculed the circular outline of the *oikoumene*, which he knew to be longer from east to west than it was broad from north to south. He also pointed out reasons for accepting a division of the land into three continents—Europe, Asia and Africa. Beyond the limits of his personal travels Herodotus applied the characteristically Greek theory of symmetry to complete, in the unknown, outlines of lands and rivers analogous to those which had been explored. Symmetry was in fact the first geographical theory, and the effect of Herodotus's hypothesis that the Nile must flow from west to east before turning north in order to balance the Danube running from west to east before turning south lingered in the maps of Africa down to the time of Mungo Park.²

To Aristotle (384–322 B.C.) must be given the distinction of founding scientific geography. He demonstrated the sphericity of the

earth by three arguments, two of which could be tested by observation. These were: (1) that the earth must be spherical, because of the tendency of matter to fall together towards a common centre; (2) that only a sphere could allow the **Aristotle and the sphere.** a circular shadow on the moon during an eclipse; and (3) that the shifting of the horizon and the appearance of new constellations, or the disappearance of familiar stars, as one travelled from north to south, could only be explained on the hypothesis that the earth was a sphere. Aristotle, too, gave greater definiteness to the ideas of zones conceived by Parmenides, who had pictured a torrid zone uninhabitable by reason of heat, two frigid zones uninhabitable by reason of cold, and two intermediate temperate zones fit for human occupation. Aristotle defined the temperate zone as extending from the tropic to the arctic circle, but there is some uncertainty as to the precise meaning he gave to the term "arctic circle." Soon after his time, however, this conception was clearly established, and with so large a generalization the mental horizon was widened to conceive of a geography which was a science. Aristotle had himself shown that in the southern temperate zone winds similar to those of the northern temperate zone should blow, but from the opposite direction.

While the theory of the sphere was being elaborated the efforts of practical geographers were steadily directed towards ascertaining the outline and configuration of the *oikoumene*, or habitable world, the only portion of the terrestrial surface known to the ancients and to the medieval peoples, and still retaining a shadow of its old monopoly of geographical attention in its modern name of the "Old World." The fitting of the *oikoumene* to the sphere was the second theoretical problem. The circular outline had given way in geographical opinion to the elliptical with the long axis lying east and west, and Aristotle was inclined to view it as a very long and relatively narrow band almost encircling the globe in the temperate zone. His argument as to the narrowness of the sea between West Africa and East Asia, from the occurrence of elephants at both extremities, is difficult to understand, although it shows that he looked on the distribution of animals as a problem of geography.

Pythagoras had speculated as to the existence of antipodes, but it was not until the first approximately accurate measurements of the globe and estimates of the length and breadth of the **Problem of the oikoumene** were made by Eratosthenes (c. 250 B.C.) that the fact that, as then known, it occupied less than a quarter **Antipodes.** of the surface of the sphere was clearly recognized. It was natural, if not strictly logical, that the ocean river should be extended from a narrow stream to a world-embracing sea, and here again Greek theory, or rather fancy, gave its modern name to the greatest feature of the globe. The old instinctive idea of symmetry must often have suggested other *oikoumene* balancing the known world in the other quarters of the globe. The Stoic philosophers, especially Crates of Mallus, arguing from the love of nature for life, placed an *oikoumene* in each quarter of the sphere, the three unknown world-islands being those of the Antoece, Periocce and Antipodes. This was a theory not only attractive to the philosophical mind, but eminently adapted to promote exploration. It had its opponents, however, for Herodotus showed that sea-basins existed cut off from the ocean, and it is still a matter of controversy how far the pre-Ptolemaic geographers believed in a water-connection between the Atlantic and Indian oceans. It is quite clear that Pomponius Mela (c. A.D. 40), following Strabo, held that the southern temperate zone contained a habitable land, which he designated by the name *Antichthonos*.

Aristotle left no work on geography, so that it is impossible to know what facts he associated with the science of the earth's surface. The word geography did not appear before Aristotle, **Aristotle's first use of it being in the *Ilept xonou*, which is one of the writings doubtfully ascribed to him, and H. Berger considers that the expression was introduced by Eratosthenes.** Aristotle was certainly conversant with many facts, such as the formation of deltas, coast-erosion, and to a certain extent the dependence of plants and animals on their physical surroundings. He formed a comprehensive theory of the variations of climate with latitude and season, and was convinced of the necessity of a circulation of water between the sea and rivers, though, like Plato, he held that this took place by water rising from the sea through crevices in the rocks, losing its dissolved salts in the process. He speculated on the differences in the character of races of mankind living in different climates, and correlated the political forms of communities with their situation on a seashore, or in the neighbourhood of natural strongholds.

Strabo (c. 50 B.C.–A.D. 24) followed Eratosthenes rather than Aristotle, but with sympathies which went out more to the human interests than the mathematical basis of geography. He **Strabo** compiled a very remarkable work dealing, in large measure from personal travel, with the countries surrounding the Mediterranean. He may be said to have set the pattern which was followed in succeeding ages by the compilers of "political geographies"

¹ A concise sketch of the whole history of geographical method or theory as distinguished from the history of geographical discovery (see later section of this article) is only to be found in the introduction to H. Wagner's *Lehrbuch der Geographie*, vol. i. (Leipzig, 1900), which is in every way the most complete treatise on the principles of geography.

² *History of Ancient Geography* (Cambridge, 1897), p. 70.

³ See J. L. Myers, "An Attempt to reconstruct the Maps used by Herodotus," *Geographical Journal*, viii. (1896), p. 605.

⁴ *Geschichte der wissenschaftlichen Erdkunde der Griechen* (Leipzig 1891), Abt. 3, p. 60.

dealing less with theories than with facts, and illustrating rather than formulating the principles of the science.

Claudius Ptolemaeus (c. A.D. 150) concentrated in his writings the final outcome of all Greek geographical learning, and passed it across the gulf of the middle ages by the hands of the Arabs, to form the starting-point of the science in modern times.

Ptolemy. His geography was based more immediately on the work of his predecessor, Marinus of Tyre, and on that of Hipparchus, the follower and critic of Eratosthenes. It was the ambition of Ptolemy to describe and represent accurately the surface of the *oekumene*, for which purpose he took immense trouble to collect all existing determinations of the latitude of places, all estimates of longitudes, and to make every possible rectification in the estimates of distances by land or sea. His work was mainly cartographical in its aim, and theory was as far as possible excluded. The symmetrically placed hypothetical islands in the great continuous ocean disappeared, and the *oekumene* acquired a new form by the representation of the Indian Ocean as a larger Mediterranean completely cut off by land from the Atlantic. The *terra incognita* uniting Africa and Farther Asia was an unfortunate hypothesis which helped to retard exploration. Ptolemy used the word *geography* to signify the description of the whole *oekumene* on mathematical principles, while *chorography* signified the fuller description of a particular region, and *topography* the very detailed description of a smaller locality. He introduced the simile that geography represented an artist's sketch of a whole portrait, while chorography corresponded to the careful and detailed drawing of an eye or an ear.¹

The Caliph al-Mamun (c. A.D. 815), the son and successor of Harun al-Rashid, caused an Arabic version of Ptolemy's great astronomical work (*Ziyrat al-yawlayn*) to be made, which is known as the *Almagest*, the word being nothing more than the Gr. *psalms* with the Arabic article prefixed. The geography of Ptolemy was also known and is constantly referred to by Arab writers. The Arab astronomers measured a degree on the plains of Mesopotamia; thereby deducing a fair approximation to the size of the earth. The caliph's librarian, Abu Jafar Muhammad Ben Musa, wrote a geographical work, now unfortunately lost, entitled *Rasm al-Arzi* ("A Description of the World"), which is often referred to by subsequent writers as having been composed on the model of that of Ptolemy.

The middle ages saw geographical knowledge die out in Christendom, although it retained, through the Arabic translations of Ptolemy, a certain vitality in Islam. The verbal interpretation of Scripture led Lactantius (c. A.D. 320) and other ecclesiastics to denounce the spherical theory of the earth as heretical. The wretched subterfuge of Cosmas (c. A.D. 550) to explain the phenomena of the apparent movements of the sun by means of an earth modelled on the plan of the Jewish Tabernacle gave place ultimately to the wheel-maps—the T in an O—which reverted to the primitive ignorance of the times of Homer and Hecataeus.²

The journey of Marco Polo, the increasing trade to the East and the voyages of the Arabs in the Indian Ocean prepared the way for the reacceptance of Ptolemy's ideas when the sealed books of the Greek original were translated into Latin by Angelus in 1470.

The old arguments of Aristotle and the old measurements of Ptolemy were used by Toscanelli and Columbus in urging a westward voyage to India; and mainly on this account did the crossing of the Atlantic rank higher in the history of scientific geography than the laborious feeling out of the coast-line of Africa. But not until the voyage of Magellan shook the scales from the eyes of Europe did modern geography begin to advance. Discovery had outrun theory; the rush of new facts made Ptolemy practically obsolete in a generation, after having been the fount and origin of all geography for a millennium.

The earliest evidence of the reincarnation of a sound theoretical geography is to be found in the text-books by Peter Apian and Sebastian Münster. Apian in his *Cosmographicus liber*, published in 1524, and subsequently edited and added to by Gemma Frisius under the title of *Cosmographia*, based the whole science on mathematics and measurement. He followed Ptolemy closely, enlarging on his distinction between geography and chorography, and expressing the artistic analogy in a rough diagram. This slender distinction was made much of by most subsequent writers until Nathanael Carpenter in 1625 pointed out that the difference between geography and chorography was simply one of degree, not of kind.

Sebastian Münster, on the other hand, in his *Cosmographia universalis* of 1544, paid no regard to the mathematical basis of geography, but, following the model of Strabo, described the world according to its different political divisions, and entered with great zest into the question of the productions

¹ Bunbury's *History of Ancient Geography* (2 vols., London, 1879), Müller's *Geographi Graeci minores* (2 vols., Paris, 1855, 1861) and Berger's *Geschichte der wissenschaftlichen Erdkunde der Griechen* (4 vols., Leipzig, 1887-1893) are standard authorities on the Greek geographers.

² The period of the early middle ages is dealt with in Beasley's *Down of Modern Geography* (London; part i., 1897; part ii., 1901; part iii., 1906); see also Winstedt, *Cosmos Indicoplestus* (1910).

of countries, and into the manners and costumes of the various peoples. Thus early commenced the separation between what were long called mathematical and political geography, the one subject appealing mainly to mathematicians, the other to historians.

Throughout the 16th and 17th centuries the rapidly accumulating store of facts as to the extent, outline and mountain and river systems of the lands of the earth were put in order by the generation of cartographers of which Mercator was the chief; but the writings of Apian and Münster held the field for a hundred years without a serious rival, unless the many annotated editions of Ptolemy might be so considered. Meanwhile the new facts were the subject of original study by philosophers and by practical men without reference to classical traditions. Bacon argued keenly on geographical matters and was a lover of maps, in which he observed and reasoned upon such resemblances as that between the outlines of South America and Africa.

Philip Cluver's *Introductio in geographiam universam tam veterem quam novam* was published in 1624. Geography he defined as "the description of the whole earth, so far as it is known to us." It is distinguished from cosmography by dealing with the earth alone, not with the universe, and from chorography and topography by dealing with the whole earth, not with a country or a place. The first book, of fourteen short chapters, is concerned with the general properties of the globe; the remaining six books treat in considerable detail of the countries of Europe and of the other continents. Each country is described with particular regard to its people as well as to its surface, and the prominence given to the human element is of special interest.

A little-known book which appears to have escaped the attention of most writers on the history of modern geography was published at Oxford in 1625 by Nathanael Carpenter, fellow of Exeter College, with the title *Geographia delineata fortis in Two Books, containing the Spherick and Topick parts thereof*. It is discursive in its style and verbose; but, considering the period at which it appeared, it is remarkable for the strong common sense displayed by the author, his comparative freedom from prejudice, and his firm application of the methods of scientific reasoning to the interpretation of phenomena. Basing his work on the principles of Ptolemy, he brings together illustrations from the most recent travellers, and does not hesitate to take as illustrative examples the familiar city of Oxford and his native county of Devon. He divides geography into *The Spherick Part*, or that for the study of which mathematics alone is required, and *The Topick Part*, or the description of the physical relations of parts of the earth's surface, preferring this division to that favoured by the ancient geographers—into general and special. It is distinguished from other English geographical books of the period by confining attention to the principles of geography, and not describing the countries of the world.

A much more important work in the history of geographical method is the *Geographia generalis* of Bernhard Varenius, a German medical doctor of Leiden, who died at the age of twenty-eight in 1650, the year of the publication of his book. Although for a time it was lost sight of on the continent, Sir Isaac Newton thought so highly of this book that he prepared an annotated edition which was published in Cambridge in 1672, with the addition of the plates which had been planned by Varenius, but not produced by the original publishers. "The reason why this great man took so much care in correcting and publishing our author was, because he thought him necessary to be read by his audience, the young gentlemen of Cambridge, while he was delivering lectures on the same subject from the Lucasian Chair."³ The treatise of Varenius is a model of logical arrangement and terse expression; it is a work of science and of genius; one of the few of that age which can still be studied with profit. The English translation renders the definition thus: "Geography is that part of *mixed mathematics* which explains the state of the earth and of its parts, depending on quantity, viz. its figure, place, magnitude and motion, with the celestial appearances, &c. By some it is taken in too limited a sense, for a bare description of the several countries; and by others too extensively, who along with such a description would have their political constitution."

Varenius was reluctant to include the human side of geography in his system, and only allowed it as a concession to custom, and in order to attract readers by imparting interest to the sterner details of the science. His division of geography was into two parts—(i.) General or universal, dealing with the earth in general, and explaining its properties without regard to particular countries; and (ii.) Special or particular, dealing with each country in turn from the chorographical or topographical point of view. General geography was divided into—(1) the *Absolute* part, dealing with the form, dimensions, position and substance of the earth, the distribution of land and water, mountains, woods and deserts, hydrography (including all the waters of the earth) and the atmosphere; (2) the *Relative* part, including the celestial properties, i.e. latitude, climate zones, longitude, &c.; and (3) the *Comparative* part, which "considers the

³ From translator's preface to the English version by Mr Dugdale (1723), entitled *A Complete System of General Geography*, revised by Dr Peter Shaw (London, 1756).

rendered the greatest service to geography by the protection and encouragement of Eratosthenes, whose labours gave the first approximate knowledge of the true size of the spherical earth. The second Ptolemy and his successor Ptolemy the Geographer (118-115 B.C.) furnished Eudoxus with a fleet to explore the Arabian sea. After two successful voyages, Eudoxus, impressed with the idea that Africa was surrounded by ocean on the south, left the Egyptian service, and proceeded to Cadiz and other Mediterranean centres of trade seeking a patron who would finance an expedition for the purpose of African discovery; and we learn from Strabo that the veteran explorer made at least two voyages southward along the coast of Africa. The Ptolemies continued to send fleets annually from their Red Sea ports of Berenice and Myos Hormus to Arabia, as well as to ports on the coasts of Africa and India.

The Romans did not encourage navigation and commerce with the same ardour as their predecessors; still the luxury of Rome, which gave rise to demands for the varied products of all the countries of the known world, led to an active trade both by ships and caravans. But it was the military genius of Rome, and the ambition for universal empire, which led, not only to the discovery, but also to the survey of nearly all Europe, and of large tracts in Asia and Africa. Every new war produced a new survey and itinerary of the countries which were conquered, and added one more to the imperishable roads that led from every quarter of the known world to Rome. In the height of their power the Romans had surveyed and explored all the coasts of the Mediterranean, Italy, Greece, the Balkan Peninsula, Spain, Gaul, western Germany and southern Britain. In Africa their empire included Egypt, Carthage, Numidia and Mauritania. In Asia they held Asia Minor and Syria, had sent expeditions into Arabia, and were acquainted with the more distant countries formerly invaded by Alexander, including Persia, Srythia, Bactria and India. Roman intercourse with India especially led to the extension of geographical knowledge.

Before the Roman legions were sent into a new region to extend the limits of the empire, it was usual to send out exploring expeditions to report as to the nature of the country. It is narrated by Pliny and Seneca that the emperor Nero sent out two centuries on such a mission towards the source of the Nile (probably about A.D. 60), and that the travellers pushed southwards until they reached vast marshes through which they could not make their way either on foot or in boats. This seems to indicate that they had penetrated to about 9° N. Shortly before A.D. 79 Hippalus took advantage of the regular alternation of the monsoons to make the voyage from the Red Sea to India across the open ocean out of sight of land. Even though this sea-route was known, the author of the *Periplus of the Erythraean Sea*, published after the time of Pliny, recites the old itinerary around the coast of the Arabian Gulf. It was, however, in the reigns of Severus and his immediate successors that Roman intercourse with India was at its height, and from the writings of Pausanias (c. 174) it appears that direct communication between Rome and China had already taken place.

After the division of the Roman empire, Constantinople became the last refuge of learning, arts and taste; while Alexandria continued to be the emporium whence were imported the commodities of the East. The emperor Justinian (483-565), in whose reign the greatness of the Eastern empire culminated, sent two Nestorian monks to China, who returned with eggs of the silkworm concealed in a hollow cane, and thus silk manufactures were established in the Peloponnesus and the Greek islands. It was also in the reign of Justinian that Cosmas Indicopleustes, an Egyptian merchant, made several voyages, and afterwards composed his *Christian Topography* (Christian Topography), containing, in addition to his absurd cosmogony, a tolerable description of India.

The great outburst of Mahomedan conquest in the 7th century was followed by the Arab civilization, having its centres at Bagdad and Cordova, in connexion with which geography again received a share of attention. The works of the ancient Greek geographers were translated into Arabic, and starting with a sound basis of theoretical knowledge, exploration once more made progress. From the 9th to the 13th century intelligent Arab travellers wrote accounts of what they had seen and heard in distant lands. The earliest Arabian traveller whose observations have come down to us is the merchant Sulaiman, who embarked in the Persian Gulf and made several voyages to India and China, in the middle of the 9th century. Abu Zaid also wrote on India, and his work is the most important that we possess before the epoch-making discoveries of Marco Polo. Masudi, a great traveller who knew from personal experience all the countries between Spain and China, described the plains, mountains and seas, the dynasties and peoples, in his *Meadows of Gold*, an abstract made by himself of his larger work *News of the Time*. He died in 956, and was known, from the comprehensiveness of his survey, as the Pliny of the East. Amongst his contemporaries were Istakhri, who travelled through all the Mahomedan countries and wrote his *Book of Climates* in 950, and Ibn Haukal, whose *Book of Roads and Kingdoms*, based on the work of Istakhri, was written in 976. Idrisi, the best known of the Arabian geographical authors, after travelling far and wide in the first half of the 12th century, settled in Sicily, where he wrote a treatise descrip-

tive of an armillary sphere which he had constructed for Roger II, the Norman king, and in this work he incorporated all accessible results of contemporary travel.

The Northmen of Denmark and Norway, whose piratical adventures were the terror of all the coasts of Europe, and who established themselves in Great Britain and Ireland, in France and Sicily, were also geographical explorers in their rough but practical way during the darkest period of the middle ages. All Northmen were not bent on rapine and plunder; many were peaceful merchants. Alfred the Great, king of the Saxons in England, not only educated his people in the learning of the past ages; he inserted in the geographical works he translated many narratives of the travel of his own time. Thus he placed on record the voyages of the merchant Ulflaten in the Baltic, including particulars of the geography of Germany. And in particular he told of the remarkable voyage of Othar, a Norwegian of Helgeland, who was the first authentic Arctic explorer, the first to tell of the rounding of the North Cape and the sight of the midnight sun. This voyage of the middle of the 9th century deserves to be held in happy memory, for it unites the first Norwegian polar explorer with the first English collector of travels. Scandinavian merchants brought the products of India to England and Ireland. From the 8th to the 11th century a commercial route from India passed through Novgorod to the Baltic, and Arabian coins found in Sweden, and particularly in the island of Gotland, prove how closely the enterprise of the Northmen and of the Arabs intertwined. Five-sixths of these coins preserved at Stockholm were from the mints of the Samsanian dynasty, which reigned in Khorasán and Transoxiana from about A.D. 900 to 1000. It was the trade with the East that originally gave importance to the city of Visby in Gotland.

In the end of the 9th century Iceland was colonized from Norway; and about 985 the intrepid Viking, Eric the Red, discovered Greenland, and induced some of his Icelandic countrymen to settle on its inhospitable shores. His son, Leif Ericsson, and others of his followers were concerned in the discovery of the North American coast (see VINLAND), which, but for the isolation of Iceland from the centres of European awakening, would have had momentous consequences. As things were, the importance of this discovery passed unrecognized. The story of two Venetians, Nicolo and Antonio Zeno, who gave a vague account of voyages in the northern seas in the end of the 13th century, is no longer to be accepted as history.

At length the long period of barbarism which accompanied and followed the fall of the Roman empire drew to a close in Europe. The Crusades had a favourable influence on the intellectual state of the Western nations. Interesting regions, known only by the scant reports of pilgrims, were made the objects of attention and study; while religious zeal, and the hope of gain, combined with motives of mere curiosity, induced several persons to travel by land into remote regions of the East, far beyond the countries to which the operations of the crusaders extended. Among these was Benjamin of Tudela, who set out from Spain in 1160, travelled by land to Constantinople, and having visited India and some of the eastern islands, returned to Europe by way of Egypt after an absence of thirteen years.

Joannes de Plano Carpini, a Franciscan monk, was the head of one of the missions despatched by Pope Innocent to call the chief and people of the Tatars to a better mind. He reached the headquarters of Batu, on the Volga, in February 1246; and, after some stay, went on to the camp of the great khan near Karakorum in central Asia, and returned safely in the autumn of 1247. A few years afterwards, a Fleming named Rubruquis was sent on a similar mission, and had the merit of being the first traveller of this era who gave a correct account of the Caspian Sea. He ascertained that it had no outlet. At nearly the same time Hayton, king of Armenia, made a journey to Karakorum in 1254, by a route far to the north of that followed by Carpini and Rubruquis. He was treated with honour and hospitality, and returned by way of Samarkand and Tabris, to his own territory. The curious narrative of King Hayton was translated by Klaproth.

While the republics of Italy, and above all the state of Venice, were engaged in distributing the rich products of India and the Far East over the Western world, it was impossible that motives of curiosity, as well as a desire of commercial advantage, should not be awakened to such a degree as to impel some of the merchants to visit those remote lands. Among these were the brothers Polo, who traded with the East and themselves visited Tattary. The recital of their travels fired the youthful imagination of young Marco Polo, son of Nicolo, and he set out for the court of Kublai Khan, with his father and uncle, in 1265. Marco remained for seventeen years in the service of the Great Khan, and was employed on many important missions. Besides what he learnt from his own observation, he collected much information from others concerning countries which he did not visit. He returned to Europe possessed of a vast store of knowledge respecting the eastern parts of the world, and, being afterwards made a prisoner by the Genoese, he dictated the narrative of his travels during his captivity. The work of Marco Polo is the most valuable narrative of travels that appeared during the middle ages, and despite a cold reception and many denials of the accuracy of the record, its substantial truthfulness has been abundantly proved.

Missionaries continued to do useful geographical work. Among them were John of Monte Corvino, a Franciscan monk; Andrew of Perugia, John Marignoli and Friar Jordanus, who visited the west coast of India, and above all Friar Odoric of Pordenone. Odoric set out on his travels about 1318, and his journeys embraced parts of India, the Malay Archipelago, China and even Tibet, where he was the first European to enter Lhasa, not yet a forbidden city.

Ibn Batuta, the great Arab traveller, is separated by a wide space of time from his countrymen already mentioned, and he finds his proper place in a chronological notice after the days of Marco Polo, for he did not begin his wanderings until 1325, his career thus coinciding in time with the fabled journeyings of Sir John Mandeville. While Arab learning flourished during the darkest ages of European ignorance, the last of the Arab geographers lived to see the dawn of the great period of the European awakening. Ibn Batuta went by land from Tangier to Cairo, then visited Syria, and performed the pilgrimages to Medina and Mecca. After exploring Persia, and again residing for some time at Mecca, he made a voyage down the Red sea to Yemen, and travelled through that country to Aden. Thence he visited the African coast, touching at Mombasa and Quiloa, and then sailed across to Ormuz and the Persian Gulf. He crossed Arabia from Bahrein to Jidda, traversed the Red sea and the desert to Syene, and descended the Nile to Cairo. After this he revisited Syria and Asia Minor, and crossed the Black sea, the desert from Astrakhan to Bokhara, and the Hindu Kush. He was in the service of Muhammed Tughluk, ruler of Delhi, about eight years, and was sent on an embassy to China, in the course of which the ambassadors sailed down the west coast of India to Calicut, and then visited the Maldivic Islands and Ceylon. Ibn Batuta made the voyage through the Malay Archipelago to China, and on his return he proceeded from Malabar to Bagdad and Damascus, ultimately reaching Fez, the capital of his native country, in November 1349. After a journey into Spain he set out once more for Central Africa in 1352, and reached Timbuktu and the Niger, returning to Fez in 1353. His narrative was committed to writing from his dictation.

The European country which had come the most completely under the influence of Arab culture now began to send forth explorers to distant lands, and from this impulse came not only the Moorish but from Italian merchant navigators in Spanish service. The peaceful reign of Henry III. of Castile is famous for the attempts of that prince to extend the diplomatic relations of Spain to the remotest parts of the earth. He sent embassies to all the princes of Christendom and to the Moors. In 1493 the Spanish king sent a knight of Madrid, Ruy Gonzalez de Clavijo, to the distant court of Timur, at Samarkand. He returned in 1496, and wrote a valuable narrative of his travels.

Italians continued to make important journeys in the East during the 15th century. Among them was Nicolo Conti, who passed through Persia, sailed along the coast of Malabar, visited Sumatra, Java and the south of China, returned by the Red sea, and got home to Venice in 1444 after an absence of twenty-five years. He related his adventures to Poggio Bracciolini, secretary to Pope Eugenius IV.; and the narrative contains much interesting information. One of the most remarkable of the Italian travellers was Ludovico di Varthema, who left his native land in 1502. He went to Egypt and Syria, and for the sake of visiting the holy cities became a Mahomeddan. He was the first European who gave an account of the interior of Yemen. He afterwards visited and described many places in Persia, India and the Malay Archipelago, returning to Europe in a Portuguese ship after an absence of five years.

In the 15th century the time was approaching when the discovery of the Cape of Good Hope was to widen the scope of geographical enterprise. This great event was preceded by the general utilization in Europe of the polarity of the magnetic needle in the construction of the mariner's compass.

Portugal took the lead along this new path, and foremost among her pioneers stands Prince Henry the Navigator (1394-1460), who was a patron both of exploration and of the study of geographical theory. The great westward projection of the coast of Africa, and the islands to the north-west of that continent, were the principal scene of the work of the mariners sent out at his expense; but his object was to push onward and reach India from the Atlantic. The progress of discovery received a check on his death, but only for a time. In 1462 Pedro de Cintra extended Portuguese exploration along the African coast and discovered Sierra Leone. Fernan Gomez followed in 1469, and opened trade with the Gold Coast; and in 1484 Diogo Cao discovered the mouth of the Congo. The king of Portugal next despatched Bartolomeu Diaz in 1486 to continue discoveries southwards; while, in the following year, he sent Pedro de Covilhão and Alfonso de Payva to discover the country of Prester John. Diaz succeeded in rounding the southern point of Africa, which he named Cabo Tormentoso—the Cape of Storms—but King João II., foreseeing the realization of the long-sought passage to India, gave it the stimulating and enduring name of the Cape of Good Hope. Payva died at Cairo; but Covilhão, having heard that a Christian ruler reigned in the mountains of Ethiopia, penetrated into Abyssinia in 1490. He delivered the letter which João II. had addressed to Prester John to the Negus Alexander of Abyssinia, but he was detained by that prince and never allowed to leave the country.

21. 11

The Portuguese, following the lead of Prince Henry, continued to look for the road to India by the Cape of Good Hope. The same end was sought by Christopher Columbus, following the suggestion of Toscanelli, and under-estimating the diameter of the globe, by sailing due west. The voyages of Columbus (1492-1498) resulted in the discovery of the West Indies and North America which barred the way to the Far East. In 1493 the pope, Alexander VI., issued a bull instituting the famous "line of demarcation" running from N. to S. 100 leagues W. of the Azores, to the west of which the Spaniards were authorized to explore and to the east of which the Portuguese received the monopoly of discovery. The direct line of Portuguese exploration resulted in the discovery of the Cape route to India by Vasco da Gama (1498), and in 1500 to the independent discovery of South America by Pedro Alvarez Cabral. The voyages of Columbus and of Vasco da Gama were so important that it is unnecessary to detail their results in this place. See COLUMBUS, CHRISTOPHER; GAMA, VASCO DA.

The three voyages of Vasco da Gama (who died on the scene of his labours, at Cochin, in 1524) revolutionized the commerce of the East. Until then the Venetians held the carrying trade of India, which was brought by the Persian Gulf and Red sea into Syria and Egypt, the Venetians receiving the products of the East at Alexandria and Beirut and distributing them over Europe. This commerce was a great source of wealth to Venice; but after the discovery of the new passage round the Cape, and the conquests of the Portuguese, the trade of the East passed into other hands.

The discoveries of Columbus awakened a spirit of enterprise in Spain which continued in full force for a century; adventurers flocked eagerly across the Atlantic, and discovery followed discovery in rapid succession. Many of the companions of Columbus continued his work. Vicente Yañez Pinzon in 1500 reached the mouth of the Amazon. In the same year Alonso de Ojeda, accompanied by Juan de la Cosa, from whose maps we learn much of the discoveries of the 16th century navigators, and by a Florentine named Amerigo Vespucci, touched the coast of South America somewhere near Surinam, following the shore as far as the Gulf of Maracabibo. Vespucci afterwards made three voyages to the Brazilian coast; and in 1504 he wrote an account of his four voyages, which was widely circulated, and became the means of procuring for its author at the hands of the cartographer Waldseemüller in 1507 the disproportionate distinction of giving his name to the whole continent. In 1508 Alonso de Ojeda obtained the government of the coast of South America from Cabo de la Vela to the Gulf of Darien; Ojeda landed at Cartagena in 1510, and sustained a defeat from the natives, in which his lieutenant, Juan de la Cosa, was killed. After another reverse on the east side of the Gulf of Darien Ojeda returned to Hispaniola and died there. The Spaniards in the Gulf of Darien were left by Ojeda under the command of Francisco Pizarro, the future conqueror of Peru. After suffering much from famine and disease, Pizarro resolved to leave, and embarked the survivors in small vessels, but outside the harbour they met a ship which proved to be that of Martin Fernandez Enciso, Ojeda's partner, coming with provisions and reinforcements. One of the crew of Enciso's ship, Vasco Nuñez de Balboa, the future discoverer of the Pacific Ocean, induced his commander to form a settlement on the other side of the Gulf of Darien. The soldiers became discontented and deposed Enciso, who was a man of learning and an accomplished cosmographer. His work *Suma de Geografia*, which was printed in 1519, is the first Spanish book which gives an account of America. Vasco Nuñez, the new commander, entered upon a career of conquest in the neighbourhood of Darien, which ended in the discovery of the Pacific Ocean on the 25th of September 1513. Vasco Nuñez was beheaded in 1517 by Pedrarias de Avila, who was sent out to supersede him. This was one of the greatest calamities that could have happened to South America; for the discoverer of the South sea was on the point of sailing with a little fleet into his unknown ocean, and a humane and judicious man would probably have been the conqueror of Peru, instead of the cruel and ignorant Pizarro. In the year 1519 Panama was founded by Pedrarias; and the conquest of Peru by Pizarro followed a few years afterwards. Hernan Cortes overran and conquered Mexico from 1518 to 1521, and the discovery and conquest of Guatemala by Alvarado, the invasion of Florida by De Soto, and of Nueva Granada by Quesada, followed in rapid succession. The first detailed account of the west coast of South America was written by a keenly observant old soldier, Pedro de Cieza de Leon, who was travelling in South America from 1533 to 1550, and published his story at Seville in 1553.

The great desire of the Spanish government at that time was to find a westward route to the Moluccas. For this purpose Juan Diaz de Solis was despatched in October 1515, and in January 1516 he discovered the mouth of the Rio de la Plata. He was, however, killed by the natives, and his ships returned. In the following year the Portuguese Ferdinand Magalhães, familiarly known as Magellan, laid before Charles V., at Valladolid, a scheme for reaching the Spice Islands by sailing westward. He started on the 21st of September 1519, entered the strait which now bears his name in October 1520, worked his way through between Patagonia and Tierra del Fuego, and entered on

22

Columbus.

Vasco da Gama.

Spaniards in America.

Pacific Ocean.

Portuguese exploration—Prince Henry the Navigator.

the vast Pacific which he crossed without sighting any of its innumerable island groups. This was unquestionably the greatest of the voyages which followed from the impulse of Prince Henry, and it was rendered possible only by the magnificent courage of the commander in spite of rebellion, mutiny and starvation. It was the 6th of March 1521 when he reached the Ladrone Islands. Thence Magellan proceeded to the Philippines, and there his career ended in an unimportant encounter with hostile natives. Eventually a Biscayan named Sebastian del Cano, sailing home by way of the Cape of Good Hope, reached San Lucar in command of the "Victoria" on the 6th of September 1522, with eighteen survivors; this one ship of the squadron which sailed on the quest succeeded in accomplishing the first circumnavigation of the globe. Del Cano was received with great distinction by the emperor, who granted him a globe for his crest, and the motto *Primus circumdedisti me*.

While the Spaniards were circumnavigating the world and completing their knowledge of the coasts of Central and South America, the Portuguese were actively engaged on similar work as regards Africa and the East Indies.

With Abyssinia the mission of Covilhão led to further intercourse. In April 1520 Vasco da Gama, as viceroy of the Indies, took a fleet into the Red sea, and landed an embassy consisting of Dom Rodriguez de Lima and Father Francisco Alvarez, the most detailed narrative is the earliest and not the least interesting account we possess of Abyssinia. It was not until 1526 that the embassy was dismissed; and not many years afterwards the negus entreated the help of the Portuguese against Mahomedan invaders, and the viceroy sent an expeditionary force, commanded by his brother Cristoforo da Gama, with 450 musketeers. Da Gama was taken prisoner and killed, but his followers enabled the Christians of Abyssinia to regain their power, and a Jesuit mission remained in the country. The Portuguese also established a close connexion with the kingdom of Congo on the west side of Africa, and obtained much information respecting the interior of the continent. Duarte Lopez, a Portuguese settled in the country, was sent on a mission to Rome by the king of Congo, and Pope Sixtus V. caused him to recount to his chamberlain, Felipe Pigafetta, all he had learned during the nine years he had been in Africa, from 1578 to 1587. This narrative, under the title of *Description of the Kingdom of Congo*, was published at Rome by Pigafetta in 1591. A map was attached on which several great equatorial lakes are shown, and the empire of Monomwezi or Unyamwezi is laid down. The most valuable work on Africa about this time is, however, that written by the Moor Leo Africanus in the early part of the 16th century. Leo travelled extensively in the north and west of Africa, and was eventually taken by pirates and sold to a master who presented him to Pope Leo X. At the pope's desire he translated his work on Africa into Italian.

In further India and the Malay Archipelago the Portuguese acquired predominating influence at sea, establishing factories on the Malabar coast, in the Persian Gulf, at Malacca, and in the Spice Islands, and extending their commercial enterprises from the Red sea to China. Their missionaries were received at the court of Akbar, and Benedict Goes, a native of the Azores, was despatched on a journey overland from Agra to China. He started in 1603, and, after traversing the least-known parts of Central Asia, he reached the confines of China. He appears to have ascended from Kabul to the plateau of the Pamir, and thence onwards by Yarkand, Khotan and Aksu. He died on the journey in March 1607; and thus, as one of the brethren pronounced his epitaph, "seeking Cathay he found heaven."

The activity and love of adventure, which became a passion for two or three generations in Spain and Portugal, spread to other countries. It was the spirit of the age; and England, Holland and France were fired by it. English enterprise was first aroused by John and Sebastian Cabot, father and son, who came from Venice and settled at Bristol in the time of Henry VII. The Cabots received a patent in 1496, empowering them to seek unknown lands; and John Cabot discovered Newfoundland and part of the coast of America. Sebastian afterwards made a voyage to Rio de la Plata in the service of Spain, but he returned to England in 1548 and received a pension from Edward VI. At his suggestion a voyage was undertaken for the discovery of a north-east passage to Cathay, with Sir Hugh Willoughby as captain-general of the fleet and Richard Chancellor as pilot-major. They sailed in May 1553, but Willoughby and all his crew perished on the Lapland coast. Chancellor, however, was more fortunate. He reached the White Sea, performed the journey overland to Moscow, where he was well received, and may be said to have been the founder of the trade between Russia and England. He returned to Archangel and brought his ship back in safety to England. On a second voyage, in 1556, Chancellor was drowned; and three subsequent voyages, led by Stephen Burrough, Arthur Pet and Charles Jackman, in small craft of 50 tons and under, carried on an examination of the straits which lead into the Kara sea.

The French followed closely on the track of John Cabot, and Norman and Breton fishermen frequented the banks of Newfoundland at the beginning of the 16th century. In 1524 Francis I. sent Giovanni da Verazzano of Florence on an expedition of discovery

to the coast of North America; and the details of his voyage were embodied in a letter addressed by him to the king of France from Dieppe, in July 1524. In 1534 Jacques Cartier set out to continue the discoveries of Verazzano, and visited Newfoundland and the Gulf of St. Lawrence. In the following year he made another voyage, discovered the island of Anticosti, and ascended the St. Lawrence to Hochelaga, now Montreal. He returned, after passing two winters in Canada; and on another occasion he also failed to establish a colony. Admiral de Coligny made several unsuccessful endeavours to form a colony in Florida under Jean Ribault of Dieppe, René de Laudonnière and others, but the settlers were furiously assailed by the Spaniards and the attempt was abandoned.

The reign of Elizabeth is famous for the gallant enterprises that were undertaken by sea and land to discover and bring to light the unknown parts of the earth. The great promoter of geographical discovery in the Elizabethan period was Richard Hakluyt (1553-1616), who was active in the formation of the two companies for colonizing Virginia in 1606; and devoted his life to encouraging and recording similar undertakings. He published much, and left many valuable papers at his death, most of which, together with many other narratives, were published in 1722 in the great work of the Rev. Samuel Purchas, entitled *Pilgrimages Pastimes, or Purchases his Pilgrimes*.

It is from these works that our knowledge of the gallant deeds of the English and other explorers of the Elizabethan age is mainly derived. The great and splendidly illustrated collections of voyages and travels of Theodorus de Bry and Hulsius served a similar useful purpose on the continent of Europe. One important object of English maritime adventurers of those days was to discover a route to Cathay by the north-west, a second was to settle Virginia, and a third was to raid the Spanish settlements in the West Indies. Nor was the trade to Muscovy and Turkey neglected; while latterly a resolute and successful attempt was made to establish direct commercial relations with India.

The conception of the north-western route to Cathay now leads the story of exploration, for the first time as far as important and sustained efforts are concerned, towards the Arctic seas. This part of the story is fully told under the heading of POLAR REGIONS, and only the names of Martin Frobisher (1576), John Davis (1585), Henry Hudson (1607) and William Baffin (1616) need be mentioned here in order to preserve the complete conspectus of the history of discovery. The Dutch emulated the British in the Arctic seas during this period, directing their efforts mainly towards the discovery of a north-east passage round the northern end of Novaya Zemlya; and William Barents or Barendsz (1594-1597) is the most famous name in this connexion, his boat voyage along the coast of Novaya Zemlya after losing his ship and wintering in a high latitude, being one of the most remarkable achievements in polar annals.

Many English voyages were also made to Guinea and the West Indies, and twice English vessels followed in the track of Magellan, and circumnavigated the globe. In 1577 Francis Drake, who had previously served with Hawkins in the West Indies, undertook his celebrated voyage round the world. Reaching the Pacific through the Strait of Magellan, Drake proceeded northward along the west coast of America, resolved to attempt the discovery of a northern passage from the Pacific to the Atlantic. The coast from the southern extremity of the Californian peninsula to Cape Mendocino had been discovered by Juan Rodriguez Cabrillo and Francisco de Ulloa in 1539. Drake's discoveries extended from Cape Mendocino to 48° N., in which latitude he gave up his quest, sailed across the Pacific and reached the Philippine Islands, returning home round the Cape of Good Hope in 1580.

Thomas Cavendish, emulous of Drake's example, fitted out three vessels for an expedition to the South sea in 1586. He took the same route as Drake along the west coast of America. From Cape San Lucas Cavendish steered across the Pacific, seeing no land until he reached the Ladrone Islands. He returned to England in 1588. The third English voyage into the Pacific was not so fortunate. Sir Richard Hawkins (1593) on reaching the bay of Atacames, in 1° N. in 1594, was attacked by a Spanish fleet, and, after a desperate naval engagement, was forced to surrender. Hawkins declared his object to be discovery and the survey of unknown lands, and his voyage, though terminating in disaster, bore good fruit. The *Observations of Sir Richard Hawkins in his Voyage into the South Sea*, published in 1622, are very valuable. It was long before another British ship entered the Pacific Ocean. Sir John Narborough took two ships through the Strait of Magellan in 1670 and touched on the coast of Chile, but it was not until 1685 that Dampier sailed over the part of the Pacific where Hawkins met his defeat.

The exploring enterprise of the Spanish nation did not wane after the conquest of Peru and Mexico, and the acquisition of the vast empire of the Indies. It was spurred into renewed activity by the audacity of Sir John Hawkins in the West Indies, and by the appearance of Drake, Cavendish and Richard Hawkins in the Pacific.

In the interior of South America the Spanish conquerors had explored the region of the Andes from the isthmus of Panama to Chile. Pedro de Valdivia in 1540 made an expedition into the country of the Araucanian Indians of Chile, and was the first to

explore the eastern base of the Andes in what is now Argentine Patagonia. In 1541 Francisco de Orellana discovered the whole course of the Amazon from its source in the Andes to the Atlantic. A second voyage on the Amazon was made in 1561 by the mad pirate Lope de Aguirre; but it was not until 1639 that a full account was written of the great river by Father Cristoval de Acuña, who ascended it from its mouth and reached the city of Quito.

The voyage of Drake across the Pacific was preceded by that of Alvaro de Mendaña, who was despatched from Peru in 1567 to discover the great Antarctic continent which was believed to extend far northward into the South sea, the search for which now became one of the leading motives of exploration. After a voyage of eighty days across the Pacific, Mendaña discovered the Solomon Islands; and the expedition returned in safety to Callao. The appearance of Drake on the Peruvian coast led to an expedition being fitted out at Callao, to go in chase of him, under the command of Pedro Sarmiento. He sailed from Callao in October 1579, and made a careful survey of the Strait of Magellan, with the object of fortifying that entrance to the South sea. The colony which he afterwards took out from Spain was a complete failure, and is only remembered now from the name of "Port Famine," which Cavendish gave to the site at which he found the starving remnant of Sarmiento's settlers. In June 1595 Mendaña sailed from the coast of Peru in command of a second expedition to colonize the Solomon Islands. After discovering the Marquesas, he reached the island of Santa Cruz of evil memory, where he and many of the settlers died. His young widow took command of the survivors and brought them safely to Manila. The viceroys of Peru still persevered in their attempts to plant a colony in the hypothetical southern continent. Pedro Fernandez de Quiros, who was pilot under Mendaña and Luis Vaez de Torres, were sent in command of two ships to continue the work of exploration. They sailed from Callao in December 1605, and discovered several islands of the New Hebrides group. They anchored in a bay of a large island which Quiros named "Australia del Espíritu Santo."

From this place Quiros returned to America, but Torres continued the voyage, passed through the strait between Australia and New Guinea which bears his name, and explored and mapped the southern and eastern coasts of New Guinea. The Portuguese, in the early part of the 17th century (1578-1640), were under the dominion of Spain, and their enterprise was to some extent damped; but their missionaries extended geographical knowledge in Africa. Father Francisco Paez acquired great influence in Abyssinia, and explored its highlands from 1600 to 1622. Fathers Mendez and Lobo traversed the deserts between the coast of the Red sea and the mountains, became acquainted with Lake Tsana, and discovered the sources of the Blue Nile in 1624-1633.

But the attention of the Portuguese was mainly devoted to vain attempts to maintain their monopoly of the trade of India against the powerful rivalry of the English and Dutch. The English enterprises were persevering, continuous and successful. James Lancaster made a voyage to the Indian Ocean from 1591 to 1594; and in 1599 the merchants and adventurers of London resolved to form a company, with the object of establishing a trade with the East Indies. On the 31st of December 1599 Queen Elizabeth granted the charter of incorporation to the East India Company, and Sir James Lancaster, one of the directors, was appointed general of their first fleet. He was accompanied by John Davis, the great Arctic navigator, as pilot-major. This voyage was eminently successful. The ships touched at Achin in Sumatra and at Java, returning with full cargoes of pepper in 1603. The second voyage was commanded by Sir Henry Middleton; but it was in the third voyage, under Keeling and Hawkins, that the mainland of India was first reached in 1607. Captain Hawkins landed at Surat and travelled overland to Agra, passing some time at the court of the Great Mogul. In the voyage of Sir Edward Michelborne in 1605, John Davis lost his life in a fight with a Japanese junk. The eighth voyage, led by Captain Saris, extended the operations of the company to Japan; and in 1613 the Japanese government granted privileges to the company; but the British retired in 1623, giving up their factory. The chief result of this early intercourse between Great Britain and Japan was the interesting series of letters written by William Adams from 1611 to 1617. From the tenth voyage of the East India Company, commanded by Captain Best, who left England in 1612, dates the establishment of permanent British factories on the coast of India. It was Captain Best who secured a regular *firmán* for trade from the Great Mogul. From that time a fleet was despatched every year, and the company's operations greatly increased geographical knowledge of India and the Eastern Archipelago. British visits to Eastern countries, at this time, were not confined to the voyages of the company. Journeys were also made by land, and, among others, the enterprising author of the *Credulities*, Thomas Coryate, of Odcombe in Somersetshire, wandered on foot from France to India, and died (1617) in the company's factory at Surab. In 1561 Anthony Jenkinson arrived in Persia with a letter from Queen Elizabeth to the shah. He travelled through Russia to Bokhara, and returned by the Caspian and Volga. In 1579 Christopher Burroughs built a ship at Nishniy Novgorod and traded across the Caspian to Baku; and in 1598 Sir Anthony and Robert Shirley arrived in Persia, and

Robert was afterwards sent by the shah to Europe as his ambassador. He was followed by a Spanish mission under Garcia de Silva, who wrote an interesting account of his travels; and to Sir Dormer Cotton's mission, in 1628, we are indebted for Sir Thomas Herbert's charming narrative. In like manner Sir Thomas Roe's mission to India resulted not only in a large collection of valuable reports and letters of his own, but also in the detailed account of his chaplain Terry. But the most learned and intelligent traveller in the East, during the 17th century, was the German, Engelbrecht Kaempfer, who accompanied an embassy to Persia, in 1683, and was afterwards a surgeon in the service of the Dutch East India Company. He was in the Persian Gulf, India and Java, and resided for more than two years in Japan, of which he wrote a history.

The Dutch nation, as soon as it was emancipated from Spanish tyranny, displayed an amount of enterprise, which, for a long time, was fully equal to that of the British. The Arctic voyages of Barents were quickly followed by the establishment of a Dutch East India Company; and the Dutch, ousting the Portuguese, not only established factories on the mainland of India and in Japan, but acquired a preponderating influence throughout the Malay Archipelago. In 1583 Jan Hugen van Linschoten made a voyage to India with a Portuguese fleet, and his full and graphic descriptions of India, Africa, China and the Malay Archipelago must have been of no small use to his countrymen in their distant voyages. The first of the Dutch Indian voyages was performed by ships which sailed in April 1595, and rounded the Cape of Good Hope. A second large Dutch fleet sailed in 1598; and, so eager was the republic to extend her commerce over the world that another fleet, consisting of five ships of Rotterdam, was sent in the same year by way of Magellan's Strait, under Jacob Mahu as admiral, with William Adams as pilot. Mahu died on the passage out, and was succeeded by Simon de Cordes, who was killed on the coast of Chile. In September 1599 the fleet had entered the Pacific. The ships were then steered direct for Japan, and anchored off Bungo in April 1600. In the same year, 1598, a third expedition was despatched under Oliver van Noort, a native of Utrecht, but the voyage contributed nothing to geography. The Dutch Company in 1614 again resolved to send a fleet to the Moluccas by the westward route, and Joris Spilbergen was appointed to the command as admiral, with a commission from the States-General. He was furnished with four ships of Amsterdam, two of Rotterdam and one from Zealand. On the 6th of May 1615 Spilbergen entered the Pacific Ocean, and touched at several places on the coast of Chile and Peru, defeating the Spanish fleet in a naval engagement off Chilca. After plundering Payta and making requisitions at Acapulco, the Dutch fleet crossed the Pacific and reached the Moluccas in March 1616.

The Dutch now resolved to discover a passage into the Pacific to the south of Tierra del Fuego, the insular nature of which had been ascertained by Sir Francis Drake. The vessels fitted out for this purpose were the "Eendracht," of 360 tons, commanded by Jacob Lemaire, and the "Hoon," of 110 tons, under Willem Schouten. They sailed from the Texel on the 14th of June 1615, and by the 20th of January 1616 they were south of the entrance of Magellan's Strait. Passing through the strait of Lemaire they came to the southern extremity of Tierra del Fuego, which was named Cape Horn, in honour of the town of Hoon in West Friesland, of which Schouten was a native. They passed the cape on the 31st of January, encountering the usual westerly winds. The great merit of this discovery of a second passage into the South sea lies in the fact that it was not accidental or unforeseen, but was due to the sagacity of those who designed the voyage. On the 1st of March the Dutch fleet sighted the island of Juan Fernandez; and, having crossed the Pacific, the explorers sailed along the north coast of New Guinea and arrived at the Moluccas on the 17th of September 1616.

There were several early indications of the existence of the great Australian continent, and the Dutch endeavoured to obtain further knowledge concerning the country and its extent; but only its northern and western coasts had been visited before the time of Governor van Diemen. Dirk Hartog had been on the west coast in latitude 26° 30' S. in 1616. Pelsert struck on a reef called "Houtman's Abrolhos" on the 4th of June 1629. In 1697 the Dutch captain Vlamingh landed on the west coast of Australia, then called New Holland, in 31° 43' S., and named the Swan river from the black swans he discovered there. In 1642 the governor and council of Batavia fitted out two ships to prosecute the discovery of the south land, then believed to be part of a vast Antarctic continent, and entrusted the command to Captain Abel Jansen Tasman. This voyage proved to be the most important to geography that had been undertaken since the first circumnavigation of the globe. Tasman sailed from Batavia in 1642, and on the 24th of November sighted high land in 42° 30' S., which was named van Diemen's Land, and after landing there proceeded to the discovery of the western coast of New Zealand; at first called Staten Land, and supposed to be connected with the Antarctic continent from which this voyage proved New Holland to be separated. He then reached Tongatabu, one of the Friendly Islands of Cook; and returned by the north coast of New Guinea to Batavia. In 1644 Tasman made a second voyage to effect a fuller discovery of New Guinea.

The French directed their enterprise more in the direction of North America than of the Indies. One of their most distinguished explorers was Samuel Champlain, a captain in the navy, who, after a remarkable journey through Mexico and the West Indies from 1599 to 1602, established his historic connexion with Canada, to the geographical knowledge of which he made a very large addition.

The principles and methods of surveying and position finding had by this time become well advanced, and the most remarkable example of the early application of these improvements is to be found in the survey of China by Jesuit missionaries. They first prepared a map of the country round Peking, which was submitted to the emperor Kang-hi, and, being satisfied with the accuracy of the European method of surveying, he resolved to have a survey made of the whole empire on the same principles. This great work was begun in July 1708, and the completed maps were presented to the emperor in 1718. The records preserved in each city were examined, topographical information was diligently collected, and the Jesuit fathers checked their triangulation by meridian altitudes of the sun and pole star and by a system of remeasurements. The result was a more accurate map of China than existed at that time, of any country in Europe. Kang-hi next ordered a similar map to be made of Tibet, the survey being executed by two lamas who were carefully trained as surveyors by the Jesuits at Peking. From these surveys were constructed the well-known maps which were forwarded to Duhalde, and which D'Anville utilized for his atlas.

Several European missionaries had previously found their way from India to Tibet. Antonio Andrada, in 1624, was the first European to enter Tibet since the visit of Friar Odoric in 1325. The next journey was that of Fathers Grueber and Dorville about 1660, who succeeded in passing from China, through Tibet, into India. In 1715 Fathers Desideri and Freyre made their way from Agra, across the Himalayas, to Lhasa, and the Capuchin Friar Orazio della Penna resided in that city from 1735 until 1747. But the most remarkable journey in this direction was performed by a Dutch traveller named Samuel van de Putte. He left Holland in 1718, went by land through Persia to India, and eventually made his way to Lhasa, where he resided for a long time. He went thence to China, returned to Lhasa, and was in India in time to be an eye-witness of the sack of Delhi by Nadir Shah in 1737. In 1743 he left India and died at Kanavia Asia on the 27th of September 1745. The premature death of this illustrious traveller is the more to be lamented because his vast knowledge died with him. Two English missions sent by Warren Hastings to Tibet, one led by George Bogle in 1774, and the other by Captain Turner in 1783, complete Tibetan exploration in the 18th century.

From Persia much new information was supplied by Jean Chardin, Jean Tavernier, Charles Hamilton, Jean de Thévenot and Father Jude Kruksinski, and by English traders on the Caspian. In 1738 John Elton traded between Astrakhan and the Persian port of Enzeli on the Caspian, and undertook to build a fleet for Nadir Shah. Another English merchant, named Jonas Hanway, arrived at Astrabad from Russia, and travelled to the camp of Nadir at Kazvin. One lasting and valuable result of Hanway's wanderings was a charming book of travels. In 1700 Guillaume Delisle published his map of the continents of the Old World; and his successor D'Anville produced his map of India in 1752. D'Anville's map contained all that was then known, but ten years afterwards Major Rennell began his surveying labours, which extended over the period from 1763 to 1782. His survey covered an area 900 m. long by 300 wide, from the eastern confines of Bengal to Agra, and from the Himalayas to Calcutta. Rennell was indefatigable in collecting geographical information; his Bengal atlas appeared in 1781, his famous map of India in 1788 and the memoir in 1792. Surveys were also made along the Indian coast.

Arabia received very careful attention, in the 18th century, from the Danish scientific mission, which included Carsten Niebuhr among its members. Niebuhr landed at Loheia, on the coast of Yemen, in December 1762, and went by land to Sanaa. All the other members of the mission died, but he proceeded from Mokha to Bombay. He then made a journey through Persia and Syria to Constantinople, returning to Copenhagen in 1767. His valuable work, the *Description of Arabia*, was published in 1772, and was followed in 1774-1778 by two volumes of travels in Asia. The great traveller survived until 1815, when he died at the age of eighty-two.

James Bruce of Kinnaird, the contemporary of Niebuhr, was equally devoted to Eastern travel; and his principal geographical work was the tracing of the Blue Nile from its source to its junction with the White Nile. Before the death of Bruce an African Association was formed, in 1788, for collecting information respecting the interior of that continent, with Major Rennell and Sir Joseph Banks as leading members. The association first employed John Ledyard (who had previously made an extraordinary journey into Siberia) to cross Africa from east to west on the parallel of the Niger, and William Lucas to cross the Sahara to Fezzan. Lucas went from Tripoli to Mesurata, obtained some information respecting Fezzan and returned in 1789. One of the chief problems the association wished to solve was that of the exist-

ence and course of the river Niger, which was believed by some authorities to be identical with the Congo. Mungo Park, then an assistant surgeon of an Indian army, volunteered his services, which were accepted by the association, and in 1795 he succeeded in reaching the town of Segu on the Niger, but was prevented from continuing his journey to Timbuktu. Five years later he accepted an offer from the government to command an expedition into the interior of Africa, the plan being to cross from the Gambia to the Niger and descend the latter river to the sea. After losing most of his companions he himself and the rest perished in a rapid on the Niger at Busa, having been attacked from the shore by order of a chief who thought he had not received suitable presents. His work, however, had established the fact that the Niger was not identical with the Congo.

While the British were at work in the direction of the Niger, the Portuguese were not unmindful of their old exploring fame. In 1798 Dr F. J. M. de Lacerda, an accomplished astronomer, was appointed to command a scientific expedition of discovery to the north of the Zambesi. He started in July, crossed the Muchenja Mountains, and reached the capital of the Cazembe, where he died of fever. Lacerda left a valuable record of his adventurous journey; but with Mungo Park and Lacerda the history of African exploration in the 18th century closes.

In South America scientific exploration was active during this period. The great geographical event of the century, as regards that continent, was the measurement of an arc of the meridian. The undertaking was proposed by the French Academy as part of an investigation with the object of ascertaining the length of the degree near the equator and near the pole respectively so as to determine the figure of the earth. A commission left Paris in 1735, consisting of Charles Marie de la Condamine, Pierre Bouguer, Louis Godin and Joseph de Jussieu, the naturalist. Spain appointed two accomplished naval officers, the brothers Ulloa, as coadjutors. The operations were carried on during eight years on a plain to the south of Quito; and, in addition to his memoir on this memorable measurement, La Condamine collected much valuable geographical information during a voyage down the Amazon. The arc measured was $3^{\circ} 7' 3''$ in length; and the work consisted of two measured bases connected by a series of triangles, one north and the other south of the equator, on the meridian of Quito. Contemporaneously, in 1738, Pierre Louis Moreau de Maupertuis, Alexis Claude Clairaut, Charles Etienne Louis Camus, Pierre Charles Lemonnier and the Swedish physicist Celsius measured an arc of the meridian in Lapland.

The British and French governments despatched several expeditions of discovery into the Pacific and round the world during the 18th century. They were preceded by the wonderful and romantic voyages of the buccaners. The narratives of such men as Woodes Rogers, Edward Davis, George Shelvocke, Clipperton and William Dampier, can never fail to interest, while they are not without geographical value. The works of Dampier are especially valuable, and the narratives of William Funnell and Lionel Wafer furnished the best accounts then extant of the Isthmus of Darien. Dampier's literary ability eventually secured for him a commission in the king's service; and he was sent on a voyage of discovery, during which he explored part of the coasts of Australia and New Guinea, and discovered the strait which bears his name between New Guinea and New Britain, returning in 1701. In 1721 Jacob Roggeveen was despatched on a voyage of some importance across the Pacific by the Dutch West India Company, during which he discovered Easter Island on the 6th of April 1722.

The voyage of Lord Anson to the Pacific in 1740-1744 was of a predatory character, and he lost more than half his men from scurvy; while it is not pleasant to reflect that at the very time when the French and Spaniards were measuring an arc of the meridian at Quito, the British under Anson were pillaging along the coast of the Pacific and burning the town of Payta. But a romantic interest attaches to the wreck of the "Wager," one of Anson's fleet, on a desert island near Chiloe, for it bore fruit in the charming narrative of Captain John Byron, which will endure for all time. In 1764 Byron himself was sent on a voyage of discovery round the world, which led immediately after his return to the despatch of another to complete his work, under the command of Captain Samuel Wallis.

The expedition, consisting of the "Dolphin" commanded by Wallis, and the "Swallow" under Captain Philip Carteret, sailed in September 1766, but the ships were separated on entering the Pacific from the Strait of Magellan. Wallis discovered Tahiti on the 19th of June 1767, and he gave a detailed account of that island. He returned to England in May 1768. Carteret discovered the Charlotte and Gloucester Islands, and Pitcairn Island on the 2nd of July 1767; revisited the Santa Cruz group, which was discovered by Mendana and Quiros; and discovered the strait separating New Britain from New Ireland. He reached Spithead again in February 1769. Wallis and Carteret were followed very closely by the French expedition of Bougainville, which sailed from Nantes in November 1766. Bougainville had first to perform the unpleasant task of delivering up the Falkland Islands, where he had encouraged the formation of a French settlement, to the Spaniards. He then entered the Pacific, and reached Tahiti in April 1768. Passing through the New

Hebrides group he touched at Batavia, and arrived at St. Malo after an absence of two years and four months.

The three voyages of Captain James Cook form an era in the history of geographical discovery. In 1767 he sailed for Tahiti, with the object of observing the transit of Venus, accompanied by two naturalists, Sir Joseph Banks and Dr. Solander, a pupil of Linnaeus, as well as by two astronomers. The transit was observed on the 3rd of June 1769. After exploring Tahiti and the Society group, Cook spent six months surveying New Zealand, which he discovered to be an island, and the coast of New South Wales from latitude 38° S. to the northern extremity. The belief in a vast Antarctic continent stretching far into the temperate zone had never been abandoned, and was vehemently asserted by Charles Dalrymple, a disappointed candidate nominated by the Royal Society for the command of the *Transit expedition* of 1769. In 1772 the French explorer Yves Kerguelen de Tremarec had discovered the land that bears his name in the South Indian Ocean without recognizing it to be an island, and naturally believed it to be part of the southern continent.

Cook's second voyage was mainly intended to settle the question of the existence of such a continent once for all, and to define the limits of any land that might exist in navigable seas towards the Antarctic circle. James Cook at his first attempt reached a south latitude of 57° 15'. On a second cruise from the Society Islands, in 1773, he, first of all men, crossed the Antarctic circle, and was stopped by ice in 71° 10' S. During the second voyage Cook visited Easter Island, discovered several islands of the New Hebrides and New Caledonia; and on his way home by Cape Horn, in March 1774, he discovered the Sandwich Island group and described South Georgia. He proved conclusively that any southern continent that might exist lay under the polar ice. The third voyage was intended to attempt the passage from the Pacific to the Atlantic by the north-east. The "*Resolution*" and "*Discovery*" sailed in 1776, and Cook again took the route by the Cape of Good Hope. On reaching the North American coast, he proceeded northward, fixed the position of the western extremity of America and surveyed Bering Strait. He was stopped by the ice in 70° 41' N., and named the farthest visible point on the American shore icy Cape. He then visited the Asiatic shore and discovered Cape North. Returning to Hawaii, Cook was murdered by the natives. On the 14th of February 1779, his second, Captain Edward Clerke, took command, and proceeding to Petropavlovsk in the following summer, he again examined the edge of the ice, but only got as far as 70° 33' N. The ships returned to England in October 1780.

In 1785 the French government carefully fitted out an expedition of discovery at Brest, which was placed under the command of François La Pérouse, an accomplished and experienced officer. After touching at Concepcion in Chile and at Easter Island, La Pérouse proceeded to Hawaii and thence to the coast of California, of which he has given a very interesting account. He then crossed the Pacific to Macao, and in July 1787 he proceeded to explore the Gulf of Tartary and the shores of Sakhalin, remaining some time at Castris Bay, so named after the French minister of marine. Thence he went to the Kurile Islands and Kamchatka, and sailed from the far north down the meridian to the Navigator and Friendly Islands. He was in Botany Bay in January 1788; and sailing thence, the explorer, his ship and crew were never seen again. Their fate was long uncertain. In September 1791 Captain Antoine d'Entrecasteaux sailed from Brest with two vessels to seek for tidings. He visited the New Hebrides, Santa Cruz, New Caledonia and Solomon Islands, and made careful though rough surveys of the Louisiade Archipelago, islands north of New Britain and part of New Guinea. D'Entrecasteaux died on board his ship on the 20th of July 1793, without ascertaining the fate of La Pérouse. Captain Peter Dillon at length ascertained, in 1828, that the ships of La Pérouse had been wrecked on the island of Vanikoro during a hurricane.

The work of Captain Cook bore fruit in many ways. His master, Captain William Bliß, was sent in the "*Bounty*" to convey bread-fruit plants from Tahiti to the West Indies. He reached Tahiti in October 1788, and in April 1789 a mutiny broke out, and he, with several officers and men, was thrust into an open boat in mid-ocean. During the remarkable voyage he then made to Timor, Bliß passed amongst the northern islands of the New Hebrides, which he named the Banks Group, and made several running surveys. He reached England in March 1790. The "*Pandora*," under Captain Edwards, was sent out in search of the "*Bounty*," and discovered the islands of Cherry and Mitre, east of the Santa Cruz group, but she was eventually lost on a reef in Torres Strait. In 1796-1797 Captain Wilson, in the missionary ship "*Duff*," discovered the Gambier and other islands, and rediscovered the islands known to and seen by Quiros, but since called the Duff Group. Another result of Captain Cook's work was the colonization of Australia. On the 18th of January 1788 Admiral Phillip and Captain Hunter arrived in Botany Bay in the "*Supply*" and "*Sirius*," followed by six transports, and established a colony at Port Jackson. Surveys were then undertaken in several directions. In 1795 and 1796 Matthew Flinders and George Bass were engaged on exploring work in a small boat called the "*Tom Thumb*." In 1797 Bass, who had been a surgeon, made an expedition southwards, continued the work of Cook from Ram Head, and explored the strait which bears his

name, and in 1798 he and Flinders were surveying on the east coast of Van Diemen's land.

Yet another outcome of Captain Cook's work was the voyage of George Vancouver, who had served as a midshipman in Cook's second and third voyages. The Spaniards under Quadra had begun a survey of north-western America and occupied Nootka Sound, which their government eventually agreed to surrender. Captain Vancouver was sent out to receive the cession, and to survey the coast from Cape Mendocino northwards. He commanded the old "*Discovery*," and was at work during the seasons of 1792, 1793 and 1794, wintering at Hawaii. Returning home in 1795, he completed his narrative and a valuable series of charts.

The 18th century saw the Arctic coast of North America reached at two points, as well as the first scientific attempt to reach the North Pole. The Hudson Bay Company had been incorporated in 1670, and its servants soon extended their operations over a wide area to the north and west of Canada. In 1741 Captain Christopher Middleton was ordered to solve the question of a passage from Hudson Bay to the westward. Leaving Fort Churchill in July 1742, he discovered the Wager river and Repulse Bay. He was followed by Captain W. Moor in 1746, and Captain Coats in 1751, who examined the Wager Inlet up to the end. In November 1769 Samuel Hearne was sent by the Hudson Bay Company to discover the sea on the north side of America, but was obliged to return. In February 1770 he set out again from Fort Prince of Wales; but, after great hardships, he was again forced to return to the fort. He started once more in December 1771, and at length reached the Coppermine river, which he surveyed to its mouth, but his observations are unreliable. With the same object Alexander Mackenzie, with a party of Canadians, set out from Fort Chippewyan on the 3rd of June 1789, and descending the great river which now bears the explorer's name reached the Arctic sea.

In February 1773 the Royal Society submitted a proposal to the king for an expedition towards the North Pole. The expedition was fitted out under Captain Constantine Phipps, and Skellington Lutwidge, and the highest latitude reached was 80° 48' N., but no opening was discovered in the heavy Polar pack. The most important Arctic work in the 18th century was performed by the Russians, for they succeeded in delineating the whole of the northern coast of Siberia. Some of this work was possibly done at a still earlier date. The Cossack Simon Deshneff is thought to have made a voyage, in the summer of 1648, from the river Kolyma, through Bering Strait (which was rediscovered by Vitus Bering in 1728) to Anadyr. Between 1738 and 1750 Manin and Sterletoff made their way in small sloops from the mouth of the Yenesei as far north as 75° 15' N. The land from Taimyr to Cape Chelyuskin, the most northern extremity of Siberia, was mapped in many years of patient exploration by Chelyuskin, who reached the extreme point (77° 34' N.) in May 1742. To the east of Cape Chelyuskin the Russians encountered greater difficulties. They built small vessels at Yakutsk on the Lena, 900 m. from its mouth, whence the first expedition was despatched under Lieut. Pronschichev in 1735. He sailed from the mouth of the Lena to the east of the Olonek, where he wintered, and on the 1st of September 1736 he got as far as 77° 29' N., within 5 m. of Cape Chelyuskin. Both he and his young wife died of scurvy, and the vessel returned. A second expedition, under Lieut. Laptev, started from the Lena in 1739, but encountered masses of drift ice in Chatanga bay, and with this ended the voyages to the westward of the Lena. Several attempts were also made to navigate the sea from the Lena to the Kolyma. In 1736 Lieut. Laptev sailed, but was stopped by the drift ice in August, and in 1739, during another trial, he reached the mouth of the Indigirka, where he wintered. In the season of 1740 he continued his voyage to beyond the Kolyma, wintering at Nizhni Kolymsk. In September 1740 Vitus Bering sailed from Okhotsk on a second Arctic voyage with George William Steller on board as naturalist. In June 1741 he named the magnificent peak on the coast of North America Mount St. Elias and explored the Aleutian Islands. In November the ship was wrecked on Bering Island; and the gallant Dane, worn out with scurvy, died there on the 8th of December 1741. In March 1770 a merchant named Likhov saw a large herd of reindeer coming from the north to the Siberian coast, which induced him to start in a sledge in the direction whence they came. Thus he reached the New Siberian or Likhov Islands, and for years afterwards the seekers for fossil ivory resorted to them. The Russian Captain Vassili Chitshakov in 1765 and 1766 made two persevering attempts to penetrate the ice north of Spitzbergen, and reached 80° 30' N., while Russian parties twice wintered at Bell Sound.

In reviewing the progress of geographical discovery thus far, it has been possible to keep fairly closely to a chronological order. But in the 19th century and after exploring work was so generally and steadily maintained in all directions, and was in so many cases narrowed down from long journeys to detailed surveys within relatively small areas, that it becomes desirable to cover the whole period at one view for certain great divisions of the world. (See AFRICA; ASIA; AUSTRALIA; POLAR REGIONS; &c.) Here, however, may be noticed the development of geographical societies devoted to the encouragement of exploration and research. The first of the existing geographical societies was

Arctic regions.

Geographical societies.

that of Paris, founded in 1825 under the title of La Société de Géographie. The Berlin Geographical Society (Gesellschaft für Erdkunde) is second in order of seniority, having been founded in 1827. The Royal Geographical Society, which was founded in London in 1830, comes third on the list; but it may be viewed as a direct result of the earlier African Association founded in 1788. Sir John Barrow, Sir John Cam Hobhouse (Lord Broughton), Sir Roderick Murchison, Mr Robert Brown and Mr Bartle Frere formed the foundation committee of the Royal Geographical Society, and the first president was Lord Goderich. The action of the society in supplying practical instruction to intending travellers, in astronomy, surveying and the various branches of science useful to collectors, has had much to do with advancement of discovery. Since the war of 1870 many geographical societies have been established on the continent of Europe. At the close of the 19th century there were upwards of 100 such societies in the world, with more than 50,000 members, and over 150 journals were devoted entirely to geographical subjects.¹ The great development of photography has been a notable aid to explorers, not only by placing at their disposal a faithful and ready means of recording the features of a country and the types of inhabitants, but by supplying a method of quick and accurate topographical surveying.

THE PRINCIPLES OF GEOGRAPHY

As regards the scope of geography, the order of the various departments and their inter-relation, there is little difference of opinion, and the principles of geography² are now generally accepted by modern geographers. The order in which the various subjects are treated in the following sketch is the natural succession from fundamental to dependent facts, which corresponds also to the evolution of the diversities of the earth's crust and of its inhabitants.

The fundamental geographical conceptions are mathematical, the relations of space and form. The figure and dimensions of the earth are the first of these. They are ascertained by a combination of actual measurement of the highest precision on the surface and angular observations of the positions of the heavenly bodies. The science of geodesy is part of mathematical geography, of which the arts of surveying and cartography are applications. The motions of the earth as a planet must be taken into account, as they render possible the determination of position and direction by observations of the heavenly bodies. The diurnal rotation of the earth furnishes two fixed points or poles, the axis joining which is fixed or nearly so in its direction in space. The rotation of the earth thus fixes the directions of north and south and defines those of east and west. The angle which the earth's axis makes with the plane in which the planet revolves round the sun determines the varying seasonal distribution of solar radiation over the surface and the mathematical zones of climate. Another important consequence of rotation is the deviation produced in moving bodies relatively to the surface. In the form known as Ferrell's Law this runs: "If a body moves in any direction on the earth's surface, there is a deflecting force which arises from the earth's rotation which tends to deflect it to the right in the northern hemisphere but to the left in the southern hemisphere."³ The deviation is of importance in the movement of air, of ocean currents, and to some extent of rivers.⁴

In popular usage the words "physical geography"⁵ have come to mean geography viewed from a particular standpoint rather than any special department of the subject. The popular meaning is better conveyed by the word physiography, a term which appears to have been introduced by Linnaeus, and was reinvented as a substitute for the cosmography of the middle ages by Professor Huxley. Although the term has since been limited by some writers to one particular part of the subject, it seems best to maintain the original and literal meaning. In the stricter sense, physical geography is that part of geography which involves the processes of contemporary change in the crust and the circulation of the fluid envelopes. It thus draws upon physics for the explanation of the phenomena with the space-relations of which it is specially concerned. Physical geography naturally falls into three divisions, dealing respectively with the surface of the lithosphere—geomorphology; the hydrosphere—oceanography; and the atmosphere—climatology. All these rest upon the facts of mathematical geography, and the three are so closely inter-related that they cannot be rigidly separated in any discussion.

Geomorphology is the part of geography which deals with terrestrial relief, including the submarine as well as the subaerial portions of the crust. The history of the origin of the various forms belongs

¹ H. Wagner's year-book, *Geographische Jahrbuch*, published at Gotha, is the best systematic record of the progress of geography in all departments; and Haack's *Geographien Kalender*, also published annually at Gotha, gives complete lists of the geographical societies and geographers of the world.

² This phrase is old, appearing in one of the earliest English works on geography, William Cuninghame's *Cosmographical Classe containing the Elements of Cosmographie, Geographie, Hydrographie or Navigation* (London, 1539).

³ See also S. Günther, *Handbuch der mathematischen Geographie* (Stuttgart, 1890).

to geology, and can be completely studied only by geological methods. But the relief of the crust is not a finished piece of sculpture; the forms are for the most part transitional, owing to their characteristic outlines to the process by which they are produced; therefore the geographer must, for strictly geographical purposes, take some account of the processes which are now in action modifying the forms of the crust. Opinion still differs as to the extent to which the geographer's work should overlap that of the geologist.

The primary distinction of the forms of the crust is that between elevations and depressions. Granting that the geoid or mean surface of the ocean is a uniform spheroid, the distribution of land and water approximately indicates a division of the surface of the globe into two areas, one of elevation and one of depression. The increasing number of measurements of the height of land in all continents and islands, and the very detailed levellings in those countries which have been thoroughly surveyed, enable the average elevation of the land above sea-level to be fairly estimated, although many vast gaps in accurate knowledge remain, and the estimate is not an exact one. The only part of the sea-bed the configuration of which is at all well known is the zone bordering the coasts where the depth is less than about 100 fathoms or 200 metres, i.e. those parts which sailors speak of as "in soundings." Actual or projected routes for telegraph cables across the deep sea have also been sounded with extreme accuracy in many cases; but beyond these lines of sounding the vast spaces of the ocean remain unplumbed save for the rare researches of scientific expeditions, such as those of the "Challenger," the "Valdivia," the "Albatross" and the "Scotia." Thus the best approximation to the average depth of the ocean is little more than an expert guess; yet a fair approximation is probable for the features of sub-oceanic relief are so much more uniform than those of the land that a smaller number of fixed points is required to determine them.

The chief element of uncertainty as to the largest features of the relief of the earth's crust is due to the unexplored area in the Arctic region and the larger regions of the Antarctic, of which we know nothing. We know that the earth's surface if unveiled of water would exhibit a great region of elevation arranged with a certain rough radiate symmetry round the north pole, and extending southwards in three unequal arms which taper to points in the south. A depression surrounds the little-known south polar region in a continuous ring and extends northwards in three vast hollows lying between the arms of the elevated area. So far only is it possible to speak with certainty, but it is permissible to take a few steps into the twilight of dawning knowledge and indicate the chief subdivisions which are likely to be established in the great crust-hollow and the great crust-heap. The boundary between these should obviously be the mean surface of the sphere.

Sir John Murray deduced the mean height of the land of the globe as about 2250 ft. above sea-level, and the mean depth of the oceans as 2080 fathoms or 12,480 ft. below sea-level.⁶ Calculating the area of the land at 55,000,000 sq. m. (or 28.6% of the surface), and that of the oceans as 137,000,000 sq. m. (or 71.4% of the surface), he found that the volume of the land above sea-level was 23,450,000 cub. m., the volume of water below sea-level 323,800,000, and the total volume of the water equal to about 14th of the volume of the whole globe. From these data, as revised by A. Supan,⁷ H. R. Mill calculated the position of mean sphere-level at about 10,000 ft. or 1700 fathoms below sea-level. He showed that an imaginary spheroidal shell, concentric with the earth and cutting the slope between the elevated and depressed areas at the contour-line of 1700 fathoms, would not only leave above it a volume of the crust equal to the volume of the hollow left below it, but would also divide the surface of the earth so that the area of the elevated region was equal to that of the depressed region.⁸

A similar observation was made almost simultaneously by Romieu,⁹ who further speculated on the equilibrium between the weight of the elevated land mass and that of the total waters of the ocean, and deduced some interesting relations between them. Murray, as the result of his study, divided the earth's surface into three zones—the continental area containing all dry land, the transitional area including the submarine slopes down to 1000 fathoms, and the abyssal area consisting of the floor of the ocean beyond that depth; and Mill proposed to take the line of mean-sphere level, instead of the empirical depth of 1000 fathoms, as the boundary between the transitional and abyssal areas.

An elaborate criticism of all the existing data regarding the volume relations of the vertical relief of the globe was made in 1894 by Professor Hermann Wagner, whose recalculations of volumes

⁴ "On the Height of the Land and the Depth of the Ocean," *Scot. Geog. Mag.* iv. (1888), p. 1. Estimates had been made previously by Humboldt, De Lapparent, H. Wagner, and subsequently by Penck and Heiderich, and for the oceans by Karsten.

⁵ *Petersmanns Mitteilungen*, xxv. (1889), p. 17.

⁶ *Proc. Roy. Soc. Edin.* xvii. (1890), p. 185.

⁷ *Comptes rendus Acad. Sci.* (Paris, 1890), vol. iii. p. 994.

Crustal relief.

Areas of the crust according to Murray.

and mean heights—the best results which have yet been obtained—led to the following conclusions.¹

The area of the dry land was taken as 28.3% of the surface of the globe, and that of the oceans as 71.7%. The mean height deduced for the land was 2300 ft. above sea-level, the mean depth of the sea 11,500 ft. below, while the position of mean-sphere level comes out as 7500 ft. (1250 fathoms) below sea-level. From this it would appear that 43% of the earth's surface was above and 57% below the mean level. It must be noted, however, that since 1895 the soundings of Nansen in the north polar area, of the "Valdivia," "Belgica," "Gauss" and "Scotia" in the Southern Ocean, and of various surveying ships in the North and South Pacific, have proved that the mean depth of the ocean is considerably greater than had been supposed, and mean-sphere level must therefore lie deeper than the calculations of 1895 show; possibly not far from the position deduced from the freer estimate of 1888. The whole of the available data were utilized by the prince of Monaco in 1905 in the preparation of a complete bathymetrical map of the oceans on a uniform scale, which must long remain the standard work for reference on ocean depths.

Areas of the crust according to Wagner.

By the device of a hypsographic curve co-ordinating the vertical relief and the areas of the earth's surface occupied by each zone of elevation, according to the system introduced by Supan,² Wagner showed his results graphically.

This curve with the values reduced from metres to feet is reproduced below. Wagner subdivides the earth's surface, according to elevation, into the following five regions:

Wagner's Divisions of the Earth's Crust.

Name.	Per cent of Surface.	From	To
Depressed area	3	Deepest.	-16,400 feet.
Oceanic plateau	54	-16,400 feet.	-7,400 ..
Continental slope	9	-7,400 ..	-660 ..
Continental plateau	28	-660 ..	+3,000 ..
Culminating area	6	+3,000 ..	Highest.

The continental plateau might for purposes of detailed study be divided into the *continental shelf* from -660 ft. to sea-level, and *lowlands* from sea-level to +660 ft. (corresponding to the mean level of the whole globe).³ *Uplands* reaching from 660 ft. to 2300 (the approximate mean level of the land), and *highlands*, from 2300 upwards, might also be distinguished.

A striking fact in the configuration of the crust is that each continent, or elevated mass of the crust, is diametrically opposite to an ocean basin or great de-

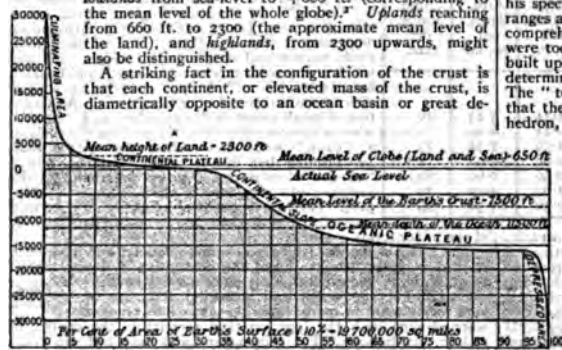

pression; the only partial exception being in the case of southern South America, which is antipodal to eastern Asia. Professor C. Lapworth has generalized the grand features of crustal relief in a scheme of attractive simplicity. He sees throughout all the chaos of irregular crust-forms the recurrence of a certain harmony, a succession of folds or waves which build up all the minor features.⁴ One great series of crust waves from east to west is crossed by a

¹ "Areal und mittlere Erhebung der Landflächen sowie der Erdkruste" in Gerland's *Beiträge zur Geophysik*, ii. (1895) p. 667. See also *Nature*, 54 (1896), p. 112.

² *Petermanns Mitteilungen*, xxv. (1889) p. 19.

³ The areas of the continental shelf and lowlands are approximately equal, and it is an interesting circumstance that, taken as a whole, the actual coast-line comes just midway on the most nearly level belt of the earth's surface, excepting the ocean floor. The configuration of the continental slope has been treated in detail by Nansen in *Scientific Results of Norwegian North Polar Expedition*, vol. iv. (1904), where full references to the literature of the subject will be found.

⁴ *British Association Report* (Edinburgh, 1892), p. 699.

second great series of crust waves from north to south, giving rise by their interference to six great elevated masses (the continents), arranged in three groups, each consisting of a northern and a southern member separated by a minor depression. These elevated masses are divided from one another by similar great depressions.

He says: "The surface of each of our great continental masses of land resembles that of a long and broad arch-like form, of which we see the simplest type in the New World. The surface of the North American arch is sagged downwards in the middle into a central depression which lies between two long marginal plateaus, and these plateaus are finally crowned by the wrinkled crests which form its two modern mountain systems. The surface of each of our ocean floors exactly resembles that of a continent turned upside down. Taking the Atlantic as our simplest type, we may say that the surface of an ocean basin resembles that of a mighty trough or syncline, buckled up more or less centrally in a medial ridge, which is bounded by two long and deep marginal hollows, in the cores of which still deeper grooves sink to the profoundest depths. This complementary relationship descends even to the minor features of the two. Where the great continental sag sinks below the ocean level, we have our gulfs and our Mediterraneans, seen in our type continent, as the Mexican Gulf and Hudson Bay. Where the central oceanic buckle attains the water-line we have our oceanic islands, seen in our type ocean, as St Helena and the Azores. Although the apparent crust-waves are neither equal in size nor symmetrical in form, this complementary relationship between them is always discernible. The broad Pacific depression seems to answer to the broad elevation of the Old World—the narrow trough of the Atlantic to the narrow continent of America."

The most thorough discussion of the great features of terrestrial relief in the light of their origin is that by Professor E. Suess,⁵ who points out that the plan of the earth is the result of two movements of the crust—one, subsidence over wide areas, giving rise to oceanic depressions and leaving the continents protuberant; the other, folding along comparatively narrow belts, giving rise to mountain ranges. This theory of crust blocks dropped by subsidence is opposed to Lapworth's theory of vast crust-folds, but geology is the science which has to decide between them.

Geomorphology is concerned, however, in the suggestions which have been made as to the cause of the distribution of heap and hollow in the larger features of the crust. Elie de Beaumont, in his speculations on the relation between the direction of mountain ranges and their geological age and character, was feeling towards a comprehensive theory of the forms of crustal relief; but his ideas were too geometrical, and his theory that the earth is a spheroid built up on a rhombic dodecahedron, the pentagonal faces of which determined the direction of mountain ranges, could not be proved.⁶ The "tetrahedral theory" brought forward by Lowthian Green,⁷ that the form of the earth is a spheroid based on a regular tetrahedron, is more serviceable, because it accounts for three very interesting facts of the terrestrial plan—(1) the antipodal position of continents and ocean basins; (2) the triangular outline of the continents; and (3) the excess of sea in the southern hemisphere. Recent investigations have recalled attention to the work of Lowthian Green, but the question is still in the controversial stage.⁸

The study of tidal strain in the earth's crust by Sir George Darwin has led that physicist to indicate the possibility of the triangular form and southerly direction of the continents being a result of the differential or tidal attraction of the sun and moon. More recently Professor A. E. H. Love has shown that the great features of the relief of the lithosphere may be expressed by spherical harmonics of the first, second and third degrees, and their formation related to gravitational action in a sphere of unequal density.⁹

In any case it is fully recognized that the plan of the earth is so clear as to leave no doubt as to its being due to some general cause which should be capable of detection.

If the level of the sea were to become coincident with the mean level of the lithosphere, there would result one tri-radiate land-mass of nearly uniform outline and one continuous sheet of water

⁵ *Das Antlitz der Erde* (4 vols., Leipzig, 1885, 1888, 1901). Translated under the editorship of E. de Margerie, with much additional matter, as *Les Faces de la terre*, vols. i. and ii. (Paris, 1897, 1900), and into English by Dr Hertha Soltas as *The Face of the Earth*, vols. i. and ii. (Oxford, 1904, 1906).

⁶ Elie de Beaumont, *Notice sur les systèmes de montagnes* (3 vols., Paris, 1852).

⁷ *Vestiges of the Modern Globe* (London, 1875).

⁸ See J. W. Gregory, "The Plan of the Earth and its Causes," *Geog. Journal*, xiii. (1899) p. 225; Lord Avebury, *ibid.* xv. (1900) p. 46; Marcel Bertrand, "Déformation tétraédrique de la terre et déplacement du pôle," *Comptes rendus Acad. Sci.* (Paris, 1900), vol. cxxx. p. 449; and A. de Lapparent, *ibid.* p. 614.

⁹ See A. E. H. Love, "Gravitational Stability of the Earth," *Phil. Trans. ser. A. vol. ccvii. (1907) p. 171.*

Lapworth's theory.

Suess's theory.

broken by few islands. The actual position of sea-level lies so near the summit of the crust-heap that the varied relief of the upper portion leads to the formation of a complicated coast-line and a great number of detached portions of land-masses. The hydrosphere is, in fact, continuous, and the land is all in insular masses: the largest is the Old World of Europe, Asia and Africa; the next in size, America; the third, possibly, Antarctica; the fourth, Australia; the fifth, Greenland. After this there is a considerable gap before New Guinea, Borneo, Madagascar, Sumatra and the vast multitude of smaller islands descending in size by regular gradations to mere rocks. The contrast between island and mainland was natural enough in the days before the discovery of Australia, and the mainland of the Old World was traditionally divided into three continents. These "continents," "parts of the earth," or "quarters of the globe," proved to be convenient divisions: America was added as a fourth, and subsequently divided into two, while Australia on its discovery was classed sometimes as a new continent, sometimes merely as an island, sometimes compromisingly as an island-continent, according to individual opinion. The discovery of the insularity of Greenland might again give rise to the argument as to the distinction between island and continent. Although the name of continent was not applied to large portions of land for any physical reasons, it so happens that there is a certain physical similarity or homology between them which is not shared by the smaller islands or peninsulas.

The typical continental form is triangular as regards its sea-level outline. The relief of the surface typically includes a central plain sometimes dipping below sea-level, bounded by lateral highlands or mountain ranges, loftier on one side than on the other, the higher enclosing a plateau shut in by mountains. South America and North America follow this type most closely; Eurasia (the land mass of Europe and Asia) comes next, while Africa and Australia are farther removed from the type, and the structure of Antarctica and Greenland is unknown.

If the continuous, unbroken, horizontal extent of land in a continent is termed its *trunk*, and the portions cut up by inlets or channels of the sea into islands and peninsulas the *limbs*, it is possible to compare the continents in an instructive manner.

The following table is from the statistics of Professor H. Wagner,³ his metric measurements being transposed into British units:

Comparison of the Continents.

	Area total, mil. sq. m.	Mean height, feet.	Area trunk, mil. sq. m.	Area peninsulas, mil. sq. m.	Area islands, mil. sq. m.	Area limbs, mil. sq. m.	Area limbs, per cent.
Old World . . .	35.8	2360					
New World . . .	16.2	2230					
Eurasia . . .	20.85	2620	15.42	4.09	1.34	5.43	26
Africa . . .	11.46	2130	11.22		0.24	0.24	2.1
North America . . .	9.26	2300	6.92	0.78	1.56	2.34	25
South America . . .	6.84	1970	6.76	0.02	0.06	0.06	1.1
Australia . . .	3.43	1310	2.77	0.16	0.50	0.66	19
Asia . . .	17.02	3120	12.93	3.05	1.04	4.09	24
Europe . . .	3.83	980	2.49	1.04	0.30	1.34	35

The usual classification of islands is into continental and oceanic. The former class includes all those which rise from the continental shelf, or show evidence in the character of their rocks of having at one time been continuous with a neighbouring continent. The latter rise abruptly from the oceanic abysses. Oceanic islands are divided according to their geological character into volcanic islands and those of organic origin, including coral islands. More elaborate subdivisions according to structure, origin and position have been proposed.³ In some cases a piece of land is only an island at high water, and by imperceptible gradation the form passes into a peninsula. The typical peninsula is connected with the mainland by a relatively narrow isthmus; the name is, however, extended to any limb projecting from the trunk of the mainland, even when, as in the Indian peninsula, it is connected by its widest part.

Small peninsulas are known as promontories or headlands, and the extremity as a cape. The opposite form, an inlet of the sea, is known when wide as a gulf, bay or bight, according to size and degree of inflection, or as a fjord or ria when long and narrow. It is convenient to employ a specific name for a projection of a coast-line less pronounced than a peninsula, and for an inlet less pronounced than a bay or bight; outcurve and incurve may serve the turn. The varieties of coast-lines were reduced to an exact classification by Richthofen, who grouped them according to the height and slope of the land into cliff-coasts (*Steilküsten*)—narrow beach coasts with cliffs, wide beach coasts with cliffs, and

low coasts, subdividing each group according as the coast-line runs parallel to or crosses the line of strike of the mountains, or is not related to mountain structure. A further subdivision depends on the character of the inter-relation of land and sea along the shore producing such types as a fjord-coast, ria-coast or lagoon-coast. This extremely elaborate subdivision may be reduced, as Wagner points out, to three types—the continental coast where the sea comes up to the solid rock-material of the land; the marine coast, which is formed entirely of soft material sorted out by the sea; and the composite coast, in which both forms are combined.

On large-scale maps it is necessary to show two coast-lines, one for the highest, the other for the lowest tide; but in small-scale maps a single line is usually wider than is required to represent the whole breadth of the inter-tidal zone. The measurement of a coast-line is difficult, because the length will necessarily be greater when measured on a large-scale map where minute irregularities can be taken into account. It is usual to distinguish between the general coast-line measured from point to point of the headlands disregarding the smaller bays, and the detailed coast-line which takes account of every inflection shown by the map employed, and follows up river entrances to the point where tidal action ceases. The ratio between these two coast-lines represents the "coastal development" of any region.

While the forms of the sea-bed are not yet sufficiently well known to admit of exact classification, they are recognized to be as a rule distinct from the forms of the land, and the importance of using a distinctive terminology is felt. Efforts have been made to arrive at a definite international agreement on this subject, and certain terms suggested by a committee were adopted by the Eighth International Geographical Congress at New York in 1904.⁴ The forms of the ocean floor include the "shelf," or shallow sea margin, the "depression," a general term applied to all submarine hollows, and the "elevation." A depression when of great extent is termed a "basin," when it is of a more or less round form with approximately equal diameters, a "trough" when it is wide and elongated with gently sloping borders, and a "tranch" when narrow and elongated with steeply sloping borders, one of which rises higher than the other. The extension of a trough or basin penetrating the land or an elevation is termed an "embayment" when wide and a "gully" when long and narrow; and the deepest part of a depression is termed a "deep." A depression of small extent when steep-sided is termed a "caldron," and a long narrow depression crossing a part of the continental border is termed a "furrow." An elevation of great extent which rises at a very gentle angle from a surrounding depression is termed a "rise," one which is relatively narrow and steep-sided a "ridge," and one which is approximately equal in length and breadth but steep-sided a "plateau," whether it springs direct from a depression or from a rise. An elevation of small extent is distinguished as a "dome" when it is more than 100 fathoms from the surface, a "bank" when it is nearer the surface than 100 fathoms but deeper than 6 fathoms, and a "shoal" when it comes within 6 fathoms of the surface and so becomes a serious danger to shipping. The highest point of an elevation is termed a "height," if it does not form an island or one of the minor forms.

The forms of the dry land are of infinite variety, and have been studied in great detail.⁵ From the descriptive or topographical point of view, geometrical form alone should be considered; but the origin and geological structure of land forms must in many cases be taken into account when dealing with the function they exercise in the control of mobile distributions. The geographers who have hitherto given most attention to the forms of the land have been trained as geologists, and consequently there is a general tendency to make origin or structure the basis of classification rather than form alone.

The fundamental form-elements may be reduced to the six proposed by Professor Penck as the basis of his double system of classification by form and origin.⁶ These may be looked upon as being all derived by various modifications or arrangements of the single form-unit, the slope or inclined plane surface. No one form occurs alone, but always grouped together with others in various ways to make up districts, regions and lands of distinctive characters. The form-elements are:

³ See *Geographical Journal*, xxii. (1903) pp. 191-194.

⁴ The most important works on the classification of land forms are F. von Richthofen, *Führer für Forschungsreisende* (Berlin, 1886); G. de la Noë and E. de Margerie, *Les Formes du terrain* (Paris, 1888); and above all A. Penck, *Morphologie der Erdoberfläche* (2 vols., Stuttgart, 1894). Compare also A. de Lapparent, *Leçons de géographie physique* (2nd ed., Paris, 1898), and W. M. Davis, *Physical Geography* (Boston, 1899).

⁵ "Geomorphologie als genetische Wissenschaft," in *Report of Sixth International Geog. Congress* (London, 1895), p. 735 (English Abstract, p. 748).

¹ *Rumpf*, in German, the language in which this distinction was first made.

² *Lehrbuch der Geographie* (Hanover and Leipzig, 1900), Bd. i. S. 249.

³ See, for example, F. C. Hahn's *Insel-Studien* (Leipzig, 1883).

1. The *Plain* or gently inclined uniform surface.
2. The *scarp* or steeply inclined slope, this is necessarily of small extent except in the direction of its length.
3. The *valley*, composed of two lateral parallel slopes inclined towards a narrow strip of plain at a lower level which itself slopes downwards in the direction of its length. Many varieties of this fundamental form may be distinguished.
4. The *mount*, composed of a surface falling away on every side from a particular place. This place may either be a point, as in a volcanic cone, or a line, as in a mountain range or ridge of hills.
5. The *hollow* or form produced by a land surface sloping inwards from all sides to a particular lowest place, the converse of a mount.
6. The *cavern* or space entirely surrounded by a land surface.

These forms never occur scattered haphazard over a region, but always in an orderly subordination depending on their mode of origin. The dominant forms result from crustal movements, the subsidiary from secondary reactions during the action of the primitive forms on mobile distributions. The geological structure and the mineral composition of the rocks are often the chief causes determining the character of the land forms of a region. Thus the scenery of a limestone country depends on the solubility and permeability of the rocks, leading to the typical Karst-formations of caverns, swallow-holes and underground stream courses, with the contingent phenomena of dry valleys and natural bridges. A sandy beach or desert owes its character to the mobility of its constituent sand-grains, which are readily drifted and piled up in the form of dunes. A region where volcanic activity has led to the embedding of dykes or bosses of hard rock amongst softer strata produces a plain broken by abrupt and isolated eminences¹.

It would be impracticable to go fully into the varieties of each specific form; but, partly as an example of modern geographical classification, partly because of the exceptional importance of mountains amongst the features of the land, one exception may be made. The classification of mountains into types has usually had regard rather to geological structure than to external form, so that some geologists would even apply the name of a mountain range to a region not distinguished by relief from the rest of the country if it bear geological evidence of having once been a true range. A mountain may be described (it cannot be defined) as an elevated region of irregular surface rising comparatively abruptly from lower ground. The actual elevation of a summit above sea-level does not necessarily affect its mountainous character; a gentle eminence, for instance, rising a few hundred feet above a tableland, even if at an elevation of say 15,000 ft., could only be called a hill.² But it may be said that any abrupt slope of 2000 ft. or more in vertical height may justly be called a mountain, while abrupt slopes of lesser height may be called hills. Existing classifications, however, do not take account of any difference in kind between mountain and hills, although it is common in the German language to speak of *Hugel-land*, *Mittelgebirge* and *Hochgebirge* with a definite significance. The simple classification employed by Professor James Geikie³ into mountains of accumulation, mountains of elevation and mountains of circumdenudation, is not considered sufficiently thorough by German geographers, who, following Richthofen, generally adopt a classification dependent on six primary divisions, each of which is subdivided. The terms employed, especially for the subdivisions, cannot be easily translated into other languages, and the English equivalents in the following table are only put forward tentatively:—

RICHTHOFEN'S CLASSIFICATION OF MOUNTAINS⁴.

- I. *Tektonische Gebirge*—Tectonic mountains.
 - (a) *Bruchgebirge* oder *Schollengebirge*—Block mountains.
 - (i.) *Tafelscholle*—Table blocks.
 - (ii.) *Abrasionscholle*—Abraded blocks.
 - (iii.) *Transgressionsscholle*—Blocks of unconformable strata.
 2. *Flexurgebirge*—Flexure mountains.
 3. *Horstgebirge*—Symmetrical block mountains.
- (b) *Faltungsgebirge*—Fold mountains.
 1. *Homöomorphe Faltungsgebirge*—Homomorphous fold mountains.
 2. *Heteromorphe Faltungsgebirge*—Heteromorphous fold mountains.

¹ On this subject see J. Geikie, *Earth Sculpture* (London, 1898); J. E. Marr, *The Scientific Study of Scenery* (London, 1900); Sir A. Geikie, *The Scenery and Geology of Scotland* (London, 2nd ed., 1887); Lord Avebury (Sir J. Lubbock), *The Scenery of Switzerland* (London, 1896) and *The Scenery of England* (London, 1902).

² Some geographers distinguish a mountain from a hill by origin; thus Professor Seeley says "a mountain implies elevation and a hill implies denudation, but the external forms of both are often identical." *Report VI. Int. Geog. Congress* (London, 1895), p. 751.

³ "Mountains," in *Sci. Geog. Mag.* ii. (1896) p. 145.

⁴ *Fähren für Forschungsreisende*, pp. 652-685.

- II. *Rumpfgebirge* oder *Abrasionsgebirge*—Trunk or abraded mountains.
- III. *Ausbruchgebirge*—Eruptive mountains.
- IV. *Aufschüttungsgebirge*—Mountains of accumulation.
- V. *Flachland*—Plateaux.
 - (a) *Abrasionsflachland*—Abraded plateaux.
 - (b) *Marnes Flachland*—Plain of marine erosion.
 - (c) *Schichtungstafelfeld*—Horizontally stratified tableland.
 - (d) *Übergusstafelfeld*—Lava plain.
 - (e) *Stromflachland*—River plain.
 - (f) *Flachböden der atmosphärischen Aufschüttung*—Plains of aeolian formation.
- VI. *Erosionsgebirge*—Mountains of erosion.

From the morphological point of view it is more important to distinguish the associations of forms, such as the *mountain mass* or group of mountains radiating from a centre, with the valleys furrowing their flanks spreading towards every direction; the *mountain chain* or line of heights, forming a long narrow ridge or series of ridges separated by parallel valleys, the *dissected plateau* or highland, divided into mountains of circumdenudation by a system of deep-cut valleys, and the *isolated peak*, usually a volcanic cone or a hard rock mass left projecting after the softer strata which embedded it have been worn away (Monadnock of Professor Davis).

The geographical distribution of mountains is intimately associated with the great structural lines of the continents of which they form the culminating region. Lofty lines of fold mountains form the "backbones" of North America in the Rocky Mountains and the west coast systems of South America in the Cordillera of the Andes, of Europe in the Pyrenæes, Alps, Carpathians and Caucasus, and of Asia in the mountains of Asia Minor, converging on the Pamirs and diverging thence in the Himalaya and the vast mountain systems of central and eastern Asia. The remarkable line of volcanoes around the whole coast of the Pacific and along the margin of the Caribbean and Mediterranean seas is one of the most conspicuous features of the globe.

If land forms may be compared to organs, the part they serve in the economy of the earth may, without straining the term, be characterized as functions. The first and simplest function of the land surface is that of guiding loose material to a lower level. The downward pull of gravity suffices to bring about the fall of such material, but the path it will follow and the distance it will travel before coming to rest depend upon the land form. The loose material may, and in an arid region does, consist only of portions of the higher parts of the surface detached by the expansion and contraction produced by heating and cooling due to radiation. Such broken material rolling down a uniform scarp would tend to reduce its steepness by the loss of material in the upper part and by the accumulation of a mound or scree against the lower part of the slope. But where the side is not a uniform scarp, but made up of a series of ridges and valleys, the tendency will be to distribute the detritus in an irregular manner, directing it away from one place and collecting it in great masses in another, so that in time the land form assumes a new appearance. Snow accumulating on the higher portions of the land, when compacted into ice and caused to flow downwards by gravity, gives rise, on account of its more coherent character, to continuous glaciers, which mould themselves to the slopes down which they are guided, different ice-streams converging to send forward a greater volume. Gradually coming to occupy definite beds, which are deepened and polished by the friction, they impress a characteristic appearance on the land, which guides them as they traverse it, and, although the ice melts at lower levels, vast quantities of clay and broken stones are brought down and deposited in terminal moraines where the glacier ends.

Rain is by far the most important of the inorganic mobile distributions upon which land forms exercise their function of guidance and control. The precipitation of rain from the aqueous vapour of the atmosphere is caused in part by vertical movements of the atmosphere involving heat changes and apparently independent of the surface upon which precipitation occurs; but in greater part it is dictated by the form and altitude of the land surface and the direction of the prevailing winds, which itself is largely influenced by the land. It is on the windward faces of the highest ground, or just beyond the summit of less dominant heights upon the leeward side, that most rain falls, and all that does not evaporate or percolate into the ground is conducted back to the sea by a route which depends only on the form of the land. More mobile and more searching than ice or rock rubbish, the trickling drops are guided by the deepest lines of the hillsides in their incipient flow, and as these lines converge, the stream, gaining strength, proceeds in its torrential course to carve its channel deeper and enter a trench itself in permanent occupation. Thus the stream, bed, from which at first the water might be blown away into a new channel by a gale of wind, ultimately grows to be the strongest line of the landscape. As the main valley deepens, the tributary streambeds are deepened also, and gradually cut their way headwards, enlarging the area whence they draw their supplies. Thus new land forms are created—valleys of curious complexity, for example—

Mountain forms.

Distribution of mountains.

Functions of land forms.

Land waste.

Glaciers.

Rain.

River systems.

by the "capture" and diversion of the water of one river by another, leading to a change of watershed.¹ The minor tributaries become more numerous and more constant, until the system of torrents has impressed its own individuality on the mountain side. As the river leaves the mountain, ever growing by the accession of tributaries, it ceases, save in flood time, to be a formidable instrument of destruction; the gentler slope of the land surface gives to it only power sufficient to transport small stones, gravel, sand and ultimately mud. Its valley banks are cut back by the erosion of minor tributaries, or by rain-wash if the climate be moist, or left steep and sharp while the river deepens its bed if the climate be arid. The outline of the curve of a valley's sides ultimately depends on the angle of repose of the detritus which covers them, if there has been no subsequent change, such as the passage of a glacier along the valley, which tends to destroy the regularity of the cross-section. The slope of the river bed diminishes until the plain compels the river to move slowly, swinging in meanders proportioned to its size, and gradually, controlled by the flattening land, ceasing to transport material, but raising its banks and silting up its bed by the dropped sediment, until, split up and shoaled, its distributaries struggle across its delta to the sea. This is the typical river of which there are infinite varieties, yet every variety would, if time were given, and the land remained unchanged in level relatively to the sea, ultimately approach to the type. Movements of the land

either of subsidence or elevation, changes in the land by the action of erosion in cutting back an escarpment or cutting through a col, changes in climate by affecting the rainfall and the volume of water, all tend to throw the river valley out of harmony with the actual condition of

its stream. There is nothing more striking in geography than the perfection of the adjustment of a great river system to its valleys when the land has remained stable for a very lengthened period. Before full adjustment has been attained the river bed may be broken in places by waterfalls or interrupted by lakes; after adjustment the bed assumes a permanent outline, the slope diminishing more and more gradually, without a break in its symmetrical descent. Excellent examples of the inefficacy of drainage of a new land surface, on which the river system has not had time to impress itself, are to be seen in northern Canada and in Finland, where rivers are separated by scarcely perceptible divides, and the numerous lakes frequently belong to more than one river system.

The action of rivers on the land is so important that it has been made the basis of a system of physical geography by Professor W. M. Davis, who classifies land surfaces in terms of the three factors—structure, process and time.² Of these time, during which the process is acting on the structure, is the most important. A land may thus be characterized by its position in the geographical cycle,³ or cycle of erosion, as young, mature or old, the last term being reached when the base-level of erosion is attained, and the land, however varied its relief may have been in youth or maturity, is reduced to a nearly uniform surface or peneplain. By a re-elevation of a peneplain the rivers of an old land surface may be restored to youthful activity, and resume their shaping action, deepening the old valleys and initiating new ones, starting afresh the whole course of the geographical cycle. It is, however, not the action of the running water on the land, but the function exercised by the land on the running water, that is considered here to be the special province of geography. At every stage of the geographical cycle the land forms, as they exist at that stage, are concerned in guiding the condensation and flow of water in certain definite ways. Thus, for example, in a mountain range at right angles to a prevailing sea-wind, it is the land forms which determine that one side of the range shall be richly watered and deeply dissected by a complete system of valleys, while the other side is dry, indefinite in its valley systems, and sends none of its scanty drainage to the sea. The action of rain, ice and rivers conspires with the movement of land waste to strip the layer of soil from steep slopes as rapidly as it forms, and to cause it to accumulate on the flat valley bottoms, on the graceful flattened cones of alluvial fans at the outlet of the gorges of tributaries, or in the smoothly-spread surface of alluvial plains.

The whole question of the régime of rivers and lakes is sometimes treated under the name hydrography, a name used by some writers in the sense of marine surveying, and by others as synonymous with oceanography. For the study of rivers alone the name potamology⁴ has been suggested by Penck, and the subject being of much practical importance has received a good deal of attention.⁵

The study of lakes has also been specialized under the name of

¹ See, for a summary of river-action, A. Phillipson, *Studien über Wasserschneise* (Leipzig, 1886); also I. C. Russell, *River Development* (London, 1898) (published as *The Rivers of North America*, New York, 1908).

² W. M. Davis, "The Geographical Cycle," *Geog. Journ.* xiv. (1899) p. 484.

³ A. Penck, "Potamology as a Branch of Physical Geography," *Geog. Journ.* x. (1897) p. 619.

⁴ See, for instance, E. Wisotzki, *Hauptfluss und Nebenfluss* (Stettin, 1889). For practical studies see official reports on the Mississippi, Rhine, Seine, Elbe and other great rivers.

limnology (see LAKE).⁶ The existence of lakes in hollows of the land depends upon the balance between precipitation and evaporation. A stream flowing into a hollow will tend to fill it up, and the water will begin to escape as soon as its level rises high enough to reach the lowest part of the rim. In the case of a large hollow in a very dry climate the rate of evaporation may be sufficient to prevent the water from ever rising to the lip, so that there is no outflow to the sea, and a basin of internal drainage is the result. This is the case, for instance, in the Caspian sea, the Aral and Balkhash lakes, the Tarim basin, the Sahara, inner Australia, the great basin of the United States and the Titicaca basin. These basins of internal drainage are calculated to amount to 22% of the land surface. The percentages of the land surface draining to the different oceans are approximately—Atlantic, 34.3%; Arctic sea, 16.5%; Pacific, 14.4%; Indian Ocean, 12.8%.⁷

The parts of a river system have not been so clearly defined as is desirable, hence the exaggerated importance popularly attached to "the source" of a river. A well-developed river system has in fact many equally important and widely-separated sources, the most distant from the mouth, the highest, or even that of largest initial volume not being necessarily of greater geographical interest than the rest. The whole of the land which directs drainage towards one river is known as its basin, catchment area or drainage area—sometimes, by an incorrect expression, as its valley or even its watershed. The boundary line between one drainage area and others is rightly termed the watershed, but on account of the ambiguity which has been tolerated it is better to call it water-parting or, as in America, divide. The only other important term which requires to be noted here is *talweg*, a word introduced from the German into French and English, and meaning the deepest line along the valley, which is necessarily occupied by a stream unless the valley is dry.

The functions of land forms extend beyond the control of the circulation of the atmosphere, the hydrosphere and the water which is continually being interchanged between them; they are exercised with increased effect in the higher departments of biogeography and anthropogeography.

The sum of the organic life on the globe is termed by some geographers the biosphere, and it has been estimated that the whole mass of living substance in existence at one time would cover the surface of the earth to a depth of one-fifth of an inch.⁸ The distribution of living organisms is a complex problem, a function of many factors, several of which are yet but little known. They include the biological nature of the organism and its physical environment, the latter involving conditions in which geographical elements, direct or indirect, preponderate. The direct geographical elements are the arrangement of land and sea (continents and islands standing in sharp contrast) and the vertical relief of the globe, which interposes barriers of a less absolute kind between portions of the same land area or oceanic depression. The indirect geographical elements, which, as a rule, act with and intensify the direct, are mainly climatic; the prevailing winds, rainfall, mean and extreme temperatures of every locality depending on the arrangement of land and sea and of land forms. Climate thus guided affects the weathering of rocks, and so determines the kind and arrangement of soil. Different species of organisms come to perfection in different climates; and it may be stated as a general rule that a species, whether of plant or animal, once established at one point, would spread over the whole zone of the climate congenial to it unless some barrier were interposed to its progress. In the case of land and fresh-water organisms the sea is the chief barrier; in the case of marine organisms, the land. Differences in land forms do not exert great influence on the distribution of living creatures directly, but indirectly such land forms as mountain ranges and internal drainage basins are very potent through their action on soil and climate. A snow-capped mountain ridge or an arid desert forms a barrier between different forms of life which is often more effective than an equal breadth of sea. In this way the surface of the land is divided into numerous natural regions, the flora and fauna of each of which include some distinctive species not shared by the others. The distribution of life is discussed in the various articles in this *Encyclopædia* dealing with biological, botanical and zoological subjects.⁹

⁶ F. A. Forel, *Handbuch der Seenkunde: allgemeine Limnologie* (Stuttgart, 1901); F. A. Forel, "La Limnologie, branche de la géographie," *Report VI. Int. Geog. Congress* (London, 1895), p. 593; also *Le Léman* (2 vols., Lausanne, 1892, 1894); H. Lullies, "Studien über Seen," *Jubiläumsschrift der Albertus-Universität* (Königsberg, 1894); and G. R. Credner, "Die Reliktenseen," *Petermanns Mitteilungen*, Ergänzungshäfte 86 and 89 (Gotha, 1887, 1888).

⁷ J. Murray, "Drainage Areas of the Continents," *Scott. Geog. Mag.* ii. (1886) p. 848.

⁸ Wagner, *Lehrbuch der Geographie* (1900), I. 886.

⁹ For details, see A. R. Wallace, *Geographical Distribution of Animals and Island Life*; A. Hülsemann, *Geographical and Geological Distribution of Animals* (1887); O. Drude, *Handbuch der Pflanzengeographie*; A. Engler, *Entwicklungsgeographie der Pflanzenwelt*; also Beddard, *Zoogeography* (Cambridge, 1895); and Sclater, *The Geography of Mammals* (London, 1899).

Lakes and internal drainage.

Terminology of river systems.

Biogeography.

The classification of the land surface into areas inhabited by distinctive groups of plants has been attempted by many phytogeographers, but without resulting in any scheme of general acceptance. The simplest classification is perhaps that of Drude according to climatic zones, subdivided according to continents. This takes account of—(1) the *Arctic-Alpine* zone, including all the vegetation of the region bordering on perpetual snow; (2) the *Boreal* zone, including the temperate lands of North America, Europe and Asia, all of which are substantially alike in botanical character; (3) the *Tropical* zone, divided sharply into (a) the tropical zone of the New World, and (b) the tropical zone of the Old World, the forms of which differ in a significant degree; (4) the *Austral* zone, comprising all continental land south of the equator, and sharply divided into three regions the floras of which are strikingly distinct—(a) South American, (b) South African and (c) Australian; (5) the *Oceanic*, comprising all oceanic islands, the flora of which consists exclusively of forms whose seeds could be drifted undestroyed by ocean currents or carried by birds. To these might be added the antarctic, which is still very imperfectly known. Many subdivisions and transitional zones have been suggested by different authors.

From the point of view of the economy of the globe this classification by species is perhaps less important than that by mode of life and physiological character in accordance with environment. The following are the chief areas of vegetational activity usually recognized: (1) The ice-deserts of the arctic and antarctic and the highest mountain regions, where there is no vegetation except the lowest forms, like that which causes "red snow." (2) The tundra or region of intensely cold winters, forbidding tree-growth, where mosses and lichens cover most of the ground when unfrozen, and shrubs occur of species which in other conditions are trees, here stunted to the height of a few inches. A similar zone surrounds the permanent snow on lofty mountains in all latitudes. The tundra passes by imperceptible gradations into the moor, bog and heath of warmer climates. (3) The temperate forests of evergreen or deciduous trees, according to circumstances, which occupy those parts of both temperate zones where rainfall and sunlight are both abundant. (4) The grassy steppes or prairies where the rainfall is diminished and temperatures are extreme, and grass is the prevailing form of vegetation. These pass imperceptibly into—(5) the arid desert, where rainfall is at a minimum, and the only plants are those modified to subsist with the smallest supply of water. (6) The tropical forest, which represents the maximum of plant luxuriance, stimulated by the heaviest rainfall, greatest heat and strongest light. These divisions merge one into the other, and admit of almost indefinite subdivision, while they are subject to great modifications by human interference in clearing and cultivating. Plants exhibit the controlling power of environment to a high degree, and thus vegetation is usually in close adjustment to the bolder geographical features of a region.

The divisions of the earth into faunal regions by Dr P. L. Sclater have been found to hold good for a large number of groups of animals as different in their mode of life as birds and mammals, and they may thus be accepted as based on nature.

Faunal realms. They are six in number: (1) *Palaearctic*, including Europe, Asia north of the Himalaya and Africa north of the Sahara; (2) *Ethiopian*, consisting of Africa south of the Atlas range, and Madagascar; (3) *Oriental*, including India, Indo-China and the Malay Archipelago north of Wallace's line, which runs between Bali and Lombok; (4) *Australian*, including Australia, New Zealand, New Guinea and Polynesia; (5) *Nearctic* or North America, north of Mexico; and (6) *Neotropical* or South America. Each of these divisions is the home of a special fauna, many species of which are confined to it alone; in the Australian region, indeed, practically the whole fauna is peculiar and distinctive, suggesting a prolonged period of complete biological isolation. In some cases, such as the Ethiopian and Neotropical and the Palaearctic and Nearctic regions, the faunas, although distinct, are related, several forms on opposite sides of the Atlantic being analogous, e.g. the lion and puma, ostrich and rhea. Where two of the faunal realms meet there is usually, though not always, a mixing of faunas. These facts have led some naturalists to include the Palaearctic and Nearctic regions in one, termed *Holarctic*, and to suggest transitional regions, such as the *Sonoran*, between North and South America, and the *Mediterranean*, between Europe and Africa, or to create sub-regions, such as Madagascar and New Zealand. Oceanic islands have, as a rule, distinctive faunas and floras which resemble, but are not identical with, those of other islands in similar positions.

The study of the evolution of faunas and the comparison of the faunas of distant regions have furnished a trustworthy instrument of pre-historic geographical research, which enables earlier geographical relations of land and sea to be traced out, and the approximate period, or at least the chronological order of the larger changes, to be estimated. In this way, for example, it has been suggested that a land, "Lemuria," once connected Madagascar with the Malay Archipelago, and that a northern extension of the antarctic land once united the three southern continents.

The distribution of fossils frequently makes it possible to map out

approximately the general features of land and sea in long-past geological periods, and so to enable the history of crustal relief to be traced.¹

While the tendency is for the living forms to come into harmony with their environment and to approach the state of equilibrium by successive adjustments if the environment should happen to change, it is to be observed that the action of organisms themselves often tends to change their environment. Corals and other quick-growing calcareous marine organisms are the most powerful in this respect by creating new land in the ocean. Vegetation of all sorts acts in a similar way, either in forming soil and assisting in breaking up rocks, in filling up shallow lakes, and even, like the mangrove, in reclaiming wide stretches of land from the sea. Plant life, utilizing solar light to combine the inorganic elements of water, soil and air into living substance, is the basis of all animal life. This is not by the supply of food alone, but also by the withdrawal of carbonic acid from the atmosphere, by which vegetation maintains the composition of the air in a state fit for the support of animal life. Man in the primitive stages of culture is scarcely to be distinguished from other animals as regards his subjection to environment, but in the higher grades of culture the conditions of control and reaction become much more complicated, and the department of anthropogeography is devoted to their consideration.

The first requisites of all human beings are food and protection, in their search for which men are brought into intimate relations with the forms and productions of the earth's surface. The degree of dependence of any people upon environment varies inversely as the degree of culture or civilization, which for this purpose may perhaps be defined as the power of an individual to exercise control over the individual and over the environment for the benefit of the community. The development of culture is to a certain extent a question of race, and although forming one species, the varieties of man differ in almost imperceptible gradations with a complexity defying classification (see ANTHROPOLOGY). Professor Keane groups man round four leading types, which may be named the black, yellow, red and white, or the Ethiopic, Mongolic, American and Caucasian. Each may be subdivided, though not with great exactness, into smaller groups, either according to physical characteristics, of which the form of the head is most important, or according to language.

The black type is found only in tropical or sub-tropical countries, and is usually in a primitive condition of culture, unless educated by contact with people of the white type. They follow the most primitive forms of religion (mainly fetishism), live on products of the woods or of the chase, with the minimum of work, and have only a loose political organization. The red type is peculiar to America, inhabiting every climate from polar to equatorial, and containing representatives of many stages of culture which had apparently developed without the aid or interference of people of any other race until the close of the 15th century. The yellow type is capable of a higher culture, cherishes higher religious beliefs, and inhabits as a rule the temperate zone, although extending to the tropics on one side and to the arctic regions on the other. The white type, originating in the north temperate zone, has spread over the whole world. They have attained the highest culture, profess the purest forms of monotheistic religion, and have brought all the people of the black type and many of those of the yellow under their domination.

The contrast between the yellow and white types has been softened by the remarkable development of the Japanese following the assimilation of western methods.

The actual number of human inhabitants in the world has been calculated as follows:

	By Continents. ²	By Race. ³
Asia	875,000,000	White (Caucasic) 770,000,000
Europe	392,000,000	Yellow (Mong.) 540,000,000
Africa	170,000,000	Black (Ethiopic) 175,000,000
America	143,000,000	Red (American) 22,000,000
Australia and Polynesia	7,000,000	
Total	1,587,000,000	Total 1,507,000,000

In round numbers the population of the world is about 1,600,000,000, and, according to an estimate by Ravenstein,⁴ the maximum population which it will be possible for the earth to maintain is 6000 millions, a number which, if the average rate of increase in 1891 continued, would be reached within 200 years.

While highly civilized communities are able to evade many of the restrictions of environment, to overcome the barriers to intercommunication interposed by land or sea, to counteract the adverse

¹ See particularly A. de Lapparent, *Traité de géologie* (4th ed., Paris, 1900).

² Estimate for 1900. H. Wagner, *Lehrbuch der Geographie*, I. p. 658.

³ Estimate for year not stated. A. H. Keane in *International Geography*, p. 108.

⁴ In *Proc. R.G.S.* xiii. (1891) p. 27.

influence of climate, and by the development of trade even to inhabit countries which cannot yield a food-supply, the mass of mankind is still completely under the control of those conditions which in the past determined the distribution and the mode of life of the whole human race.

In tropical forests primitive tribes depend on the collection of wild fruits, and in a minor degree on the chase of wild animals, for their food. Clothing is unnecessary; hence there is little occasion for exercising the mental faculties beyond the sense of perception to avoid enemies, or the inventive arts beyond what is required for the simplest weapons and the most primitive fortifications. When the pursuit of game becomes the chief occupation of a people there is of necessity a higher development of courage, skill, powers of observation and invention; and these qualities are still further enhanced in predatory tribes who take by force the food, clothing and other property prepared or collected by a feebler people. The fruit-eating savage cannot stray beyond his woods which bound his life as the water bounds that of a fish; the hunter is free to live on the margin of forests or in open country, while the robber or warrior from some natural stronghold of the mountains sweeps over the adjacent plains and carries his raids into distant lands. Wide grassy steppes lead to the organization of the people as nomads whose wealth consists in flocks and herds, and their dwellings are tents. The nomad not only domesticates and turns to his own use the gentler and more powerful animals, such as sheep, cattle, horses, camels, but even turns some predatory creatures, like the dog, into a means of defending their natural prey. They hunt the beasts of prey destructive to their flocks, and form armed bands for protection against marauders or for purposes of aggression on weaker sedentary neighbours. On the fertile low grounds along the margins of rivers or in clearings of forests, agricultural communities naturally take their rise, dwelling in villages and cultivating the wild grains, which by careful nurture and selection have been turned into rich cereals. The agriculturist as a rule is rooted to the soil. The land he tills he holds, and acquires a closer connexion with a particular patch of ground than either the hunter or the herdsman. In the temperate zone, where the seasons are sharply contrasted, but follow each other with regularity, foresight and self-denial were fostered, because if men did not exercise these qualities seed-time or harvest might pass into lost opportunities and the tribes would suffer. The more extreme climates of arid regions on the margins of the tropics, by the unpredictable succession of droughts and floods, confound the prevision of un instructed people, and make prudence and industry qualities too uncertain in their results to be worth cultivating. Thus the civilization of agricultural peoples of the temperate zone grew rapidly, yet in each community a special type arose adapted to the soil, the crop and the climate. On the seashore fishing naturally became a means of livelihood, and dwellers by the sea, in virtue of the dangers to which they are exposed from storm and unseaworthy craft, are stimulated to a higher degree of foresight, quicker observation, prompter decision and more energetic action in emergencies than those who live inland. The building and handling of vessels also, and the utilization of such uncontrollable powers of nature as wind and tide, helped forward mechanical invention. To every type of coast there may be related a special type of occupation and even of character; the deep and gloomy fjord, backed by almost impassable mountains, bred bold mariners whose only outlet for enterprise was seawards towards other lands—the vik created the vikings. On the gently sloping margin of the estuary of a great river a view of tranquil inland life was equally presented to the shore-dweller, and the ocean did not present the only prospect of a career. Finally the mountain valley, with its patches of cultivable soil on the alluvial fans of tributary torrents, its narrow pastures on the uplands only left clear of snow in summer, its intensified extremes of climates and its isolation, almost equal to that of an island, has in all countries produced a special type of brave and hardy people, whose utmost effort may bring them comfort, but not wealth, by honest toil, who know little of the outer world, and to whom the natural outlet for ambition is marauding on the fertile plains. The highlander and viking, products of the valleys raised high amid the mountains or half-drowned in the sea, are everywhere of kindred spirit.

It is in some such manner as these that the natural conditions of regions, which must be conformed to by prudence and utilized by labour to yield shelter and food, have led to the growth of peoples differing in their ways of life, thought and speech. The initial differences so produced are confirmed and perpetuated by the same barriers which divide the faunal or floral regions, the sea, mountains, deserts and the like, and much of the course of past history and present politics becomes clear when the combined results of differing race and differing environment are taken into account.¹

The specialization which accompanies the division of labour has important geographical consequences, for it necessitates communi-

cation between communities and the interchange of their products. Trade makes it possible to work mineral resources in localities where food can only be grown with great difficulty and expense, or which are even totally barren and waterless, entirely dependent on supplies from distant sources.

The population which can be permanently supported by a given area of land differs greatly according to the nature of the resources and the requirements of the people. Pastoral communities are always scattered very thinly over large areas; agricultural populations may be almost equally sparse where advanced methods of agriculture and labour-saving machinery are employed; but where a frugal people are situated on a fertile and inexhaustible soil, such as the deltas and river plains of Egypt, India and China, an enormous population may be supported on a small area. In most cases, however, a very dense population can only be maintained in regions where mineral resources have fixed the site of great manufacturing industries. The maximum density of population which a given region can support is very difficult to determine; it depends partly on the race and standard of culture of the people, partly on the nature and origin of the resources on which they depend, partly on the artificial burdens imposed and very largely on the climate. Density of population is measured by the average number of people residing on a unit of area; but in order to compare one part of the world with another the average should, strictly speaking, be taken for regions of equal size or of equal population; and the portions of the country which are permanently uninhabitable ought to be excluded from the calculation.² Considering the average density of population within the political limits of countries, the following list is of some value; the figures for a few smaller divisions of large countries are added (in brackets) for comparison:

Average Population on 1 sq. m. (For 1900 or 1901.)

Country.	Density of pop.	Country.	Density of pop.
(Saxony)	743 ³	Ceylon	141 ⁴
Belgium	589 ³	Greece	97
Java	568 ³	European Turkey	90
(England and Wales)	558	Spain	97
(Bengal)	493 ⁴	European Russia	55 ⁴
Holland	436	Sweden	30
United Kingdom	344	United States	25
Japan	317	Mexico	18
Italy	293	Norway	18
China proper	270 ⁴	Persia	15
German Empire	270	New Zealand	7
Austria	226	Argentina	5
Switzerland	207	Brazil	4.5
France	188	Eastern States of	
Indian Empire	167 ⁴	Australia	3
Denmark	160 ⁴	Dominion of Canada	1.5
Hungary	154 ⁴	Siberia	1
Portugal	146	West Australia	0.2

The movement of people from one place to another without the immediate intention of returning is known as migration, and according to its origin it may be classed as centrifugal (directed from a particular area) and centripetal (directed towards a particular area). Centrifugal migration is usually a matter of compulsion; it may be necessitated by natural causes, such as a change of climate leading to the withering of pastures or destruction of agricultural land, to inundation, earthquake, pestilence or to an excess of population over means of support; or to artificial causes, such as the wholesale deportation of a conquered people; or to political or religious persecution. In any case the people are driven out by some adverse change; and when the urgency is great they may require to drive out in turn weaker people who occupy a desirable territory, thus propagating the wave of migration, the direction of which is guided by the forms of the land into inevitable channels. Many of the great historic movements of peoples were doubtless due to the gradual change of geographical or climatic conditions; and the slow desiccation of Central Asia has been plausibly suggested as the real cause of the peopling of modern Europe and of the medieval wars of the Old World, the theatres of which were critical points on the great natural lines of communication between east and west.

In the case of centripetal migrations people flock to some particular place where exceptionally favourable conditions have been found to exist. The rushes to gold-fields and diamond-fields are typical instances; the growth of towns on coal-fields and near other sources of power, and the rapid settlement of such rich agricultural districts as the wheat-lands of the American prairies and great plains are other examples.

There is, however, a tendency for people to remain rooted to the

¹ On the influence of land on people see Shaler, *Nature and Man in America* (New York and London, 1892); and Ellen C. Semple's *American History and its Geographic Conditions* (Boston, 1902).

² See maps of density of population in Bartholomew's great large-scale atlases, *Atlas of Scotland* and *Atlas of England*.

³ Almost exclusively industrial.

⁴ Almost exclusively agricultural.

land of their birth, when not compelled or induced by powerful external causes to seek a new home.

Thus arises the spirit of patriotism, a product of purely geographical conditions, thereby differing from the sentiment of loyalty, which is of racial origin. Where race and soil conspire to

Political geography. evoke both loyalty and patriotism in a people, the moral qualities of a great and permanent nation are secured. It is noticeable that the patriotic spirit is strongest in those places where people are brought most intimately into relation with the land; dwellers in the mountain or by the sea, and, above all, the people of rugged coasts and mountainous archipelagos, have always been renowned for love of country, while the inhabitants of fertile plains and trading communities are frequently less strongly attached to their own land.

Amongst nomads the tribe is the unit of government, the political bond is personal, and there is no definite territorial association of the people, who may be loyal but cannot be patriotic. The idea of a country arises only when a nation, either homogeneous or composed of several races, establishes itself in a region the boundaries of which may be defined and defended against aggression from without. Political geography takes account of the partition of the earth amongst organized communities, dealing with the relation of races to regions, and of nations to countries, and considering the conditions of territorial equilibrium and instability.

The definition of boundaries and their delimitation is one of the most important parts of political geography. Natural boundaries are always the most definite and the strongest, lending themselves most readily to defence against aggression.

Boundaries. The sea is the most effective of all, and an island state is recognized as the most stable. Next in importance comes a mountain range, but here there is often difficulty as to the definition of the actual crest-line, and mountain ranges being broad regions, it may happen that a small independent state, like Switzerland or Andorra, occupies the mountain valleys between two or more great countries. Rivers do not form effective international boundaries, although between dependent self-governing communities they are convenient lines of demarcation. A desert, or a belt of country left purposely without inhabitants, like the mark, marches or debatable lands of the middle ages, was once a common means of separating nations which nourished hereditary grievances. The "buffer-state" of modern diplomacy is of the same ineffectual type. A less definite though very practical boundary is that formed by the meeting-line of two languages, or the districts inhabited by two races. The line of fortresses protecting Austria from Italy lies in some places well back from the political boundary, but just inside the linguistic frontier, so as to separate the German and Italian races occupying Austrian territory. Arbitrary lines, either traced from point to point and marked by posts on the ground, or defined as portions of meridians and parallels, are now the most common type of boundaries fixed by treaty. In Europe and Asia frontiers are usually strongly fortified and strictly watched in times of peace as well as during war. In South America strictly defined boundaries are still the exception, and the claims of neighbouring nations have very frequently given rise to war, though now more commonly to arbitration.¹

The modes of government amongst civilized peoples have little influence on political geography; some republics are as arbitrary and exacting in their frontier regulations as some absolute monarchies. It is, however, to be noticed that absolute monarchies are confined to the east of Europe and to Asia, Japan being the only established constitutional monarchy east of the Carpathians. Limited monarchies are (with the exception of Japan) peculiar to Europe, and in these the degree of democratic control may be said to diminish as one passes eastwards from the United Kingdom. Republics, although represented in Europe are the peculiar form of government of America and are unknown in Asia.

Forms of government. The forms of government of colonies present a series of transitional types from the autocratic administration of a governor appointed by the home government to complete democratic self-government. The latter occurs only in the temperate possessions of the British empire, in which there is no great preponderance of a coloured native population. New colonial forms have been developed during the partition of Africa amongst European powers, the sphere of influence being especially worthy of notice. This is a vaguer form of control than a protectorate, and frequently amounts merely to an agreement amongst civilized powers to respect the right of one of their number to exercise government within a certain area, if it should decide to do so at any future time.

The central governments of all civilized countries concerned with external relations are closely similar in their modes of action, but the internal administration may be very varied. In this respect a country is either centralized, like the United Kingdom or France,

or federated of distinct self-governing units like Germany (where the units include kingdoms, at least three minor types of monarchies, municipalities and a crown land under a nominated governor), or the United States, where the units are democratic republics. The ultimate cause of the predominant form of federal government may be the geographical diversity of the country, as in the cantons occupying the once isolated mountain valleys of Switzerland, the racial diversity of the people, as in Austria-Hungary, or merely political expediency, as in republics of the American type.

The minor subdivisions into provinces, counties and parishes, or analogous areas, may also be related in many cases to natural features or racial differences perpetuated by historical causes. The territorial divisions and subdivisions often survive the conditions which led to their origin; hence the study of political geography is allied to history as closely as the study of physical geography is allied to geology, and for the same reason.

The aggregation of population in towns was at one time mainly brought about by the necessity for defence, a fact indicated by the defensive sites of many old towns. In later times, towns have been more often founded in proximity to valuable mineral resources, and at critical points or nodes on lines of communication. These are places where the mode of travelling or of transport is changed, such as seaports, river ports and railway termini, or natural resting-places, such as a ford, the foot of a steep ascent on a road, the entrance of a valley leading up to a plain into the mountains, or a crossing-place of roads or railways.²

The existence of a good natural harbour is often sufficient to give origin to a town and to fix one end of a line of land communication.

In countries of uniform surface or faint relief, roads and railways may be constructed in any direction without regard to the configuration. In places where the low ground is marshy, roads and railways often follow the ridge-lines of hills, or, as in Finland, the old glacial eskers, which run parallel to the shore. Wherever the relief of the land is pronounced, roads and railways are obliged to occupy the lowest ground winding along the valleys of rivers and through passes in the mountains. In exceptional cases obstructions which it would be impossible or too costly to turn are overcome by a bridge or tunnel, the magnitude of such works increasing with the growth of engineering skill and financial enterprise. Similarly the obstructions offered to water communication by interruption through land or shallows are overcome by cutting canals or dredging out channels. The economy and success of most lines of communication depend on following as far as possible existing natural lines and utilizing existing natural sources of power.³

Commercial geography may be defined as the description of the earth's surface with special reference to the discovery, production, transport and exchange of commodities. The transport concerns land routes and sea routes, the latter being the more important. While steam has been said to make a ship independent of wind and tide, it is still true that a long voyage even by steam must be planned so as to encounter the least resistance possible from prevailing winds and permanent currents, and this involves the application of oceanographical and meteorological knowledge. The older navigation by utilizing the power of the wind demands a very intimate knowledge of these conditions, and it is probable that a revival of sailing ships may in the present century vastly increase the importance of the study of maritime meteorology.

The discovery and production of commodities require a knowledge of the distribution of geological formations for mineral products, of the natural distribution, life-conditions and cultivation or breeding of plants and animals and of the labour market. Attention must also be paid to the artificial restrictions of political geography, to the legislative restrictions bearing on labour and trade as imposed in different countries, and, above all, to the incessant fluctuations of the economic conditions of supply and demand and the combinations of capitalists or workers which affect the market.⁴

The term "applied geography" has been employed to designate commercial geography, the fact being that every aspect of scientific geography may be applied to practical purposes, including the purposes of trade. But apart from the applied science, there is an aspect of pure geography which concerns the theory of the relation of economics to the surface of the earth.

It will be seen that as each successive aspect of geographical science is considered in its natural sequence the conditions become

Towns.

Lines of communication.

Commercial geography.

Commercial geography.

Commercial geography.

Commercial geography.

Commercial geography.

Commercial geography.

Commercial geography.

Commercial geography.

Commercial geography.

Commercial geography.

Commercial geography.

Commercial geography.

Commercial geography.

Commercial geography.

Commercial geography.

Commercial geography.

¹ For numerous special instances of the determining causes of town sites, see G. G. Chisholm, "On the Distribution of Towns and Villages in England," *Geographical Journal* (1897), ix, 76, 81.

² The whole subject of anthropogeography is treated in a masterly way by F. Ratzel in his *Anthropogeographie* (Stuttgart, vol. i, 2nd ed., 1899, vol. ii, 1891), and in his *Politische Geographie* (Leipzig, 1897). The special question of the reaction of man on his environment is handled by G. P. Marsh in *Man and Nature, or Physical Geography as modified by Human Action* (London, 1864).

³ For commercial geography see G. G. Chisholm, *Manual of Commercial Geography* (1890).

more numerous, complex, variable and practically important. From the underlying abstract mathematical considerations all through the superimposed physical, biological, anthropological, political and commercial development of the subject runs the determining control exercised by crust-forms acting directly or indirectly on mobile distributions; and this is the essential principle of geography. (H. R. M.)

GEOID (from Gr. $\gamma\eta$, the earth), an imaginary surface employed by geodesists which has the property that every element of it is perpendicular to the plumb-line where that line cuts it. Compared with the "spheroid of reference" the surface of the geoid is in general depressed over the oceans and raised over the great land masses. (See EARTH, FIGURE OF THE.)

GEOK-TEPE, a former fortress of the Turkomans, in Russian Transcaspia, in the oasis of Akhal-tekke, on the Transcaspian railway, 28 m. N.W. of Askabad. It consisted of a walled enclosure 17m. in circuit, the wall being 18 ft. high and 20 to 30 ft. thick. In December 1880 the place was attacked by 6000 Russians under General Skobelev, and after a siege of twenty-three days was carried by storm, although the defenders numbered 25,000. A monument and a small museum commemorate the event.

GEOLOGY (from Gr. $\gamma\eta$, the earth, and $\lambda\omicron\gamma\omicron\varsigma$, science), the science which investigates the physical history of the earth. Its object is to trace the structural progress of our planet from the earliest beginnings of its separate existence, through its various stages of growth, down to the present condition of things. It seeks to determine the manner in which the evolution of the earth's great surface features has been effected. It unravels the complicated processes by which each continent has been built up. It follows, even into detail, the varied sculpture of mountain and valley, crag and ravine. Nor does it confine itself merely to changes in the inorganic world. Geology shows that the present races of plants and animals are the descendants of other and very different races which once peopled the earth. It teaches that there has been a progressive development of the inhabitants, as well as one of the globe on which they have dwelt; that each successive period in the earth's history, since the introduction of living things, has been marked by characteristic types of the animal and vegetable kingdoms; and that, however imperfectly the remains of these organisms have been preserved or may be deciphered, materials exist for a history of life upon the planet. The geographical distribution of existing faunas and floras is often made clear and intelligible by geological evidence; and in the same way light is thrown upon some of the remoter phases in the history of man himself. A subject so comprehensive as this must require a wide and varied basis of evidence. It is one of the characteristics of geology to gather evidence from sources which at first sight seem far removed from its scope, and to seek aid from almost every other leading branch of science. Thus, in dealing with the earliest conditions of the planet, the geologist must fully avail himself of the labours of the astronomer. Whatever is ascertainable by telescope, spectroscope or chemical analysis, regarding the constitution of other heavenly bodies, has a geological bearing. The experiments of the physicist, undertaken to determine conditions of matter and of energy, may sometimes be taken as the starting-points of geological investigation. The work of the chemical laboratory forms the foundation of a vast and increasing mass of geological inquiry. To the botanist, the zoologist, even to the unscientific, if observant, traveller by land or sea, the geologist turns for information and assistance.

But while thus culling freely from the dominions of other sciences, geology claims as its peculiar territory the rocky framework of the globe. In the materials composing that framework, their composition and arrangement, the processes of their formation, the changes which they have undergone, and the terrestrial revolutions to which they bear witness, lie the main data of geological history. It is the task of the geologist to group these elements in such a way that they may be made to yield up their evidence as to the march of events in the evolution of the planet. He finds that they have in large measure arranged themselves in chronological sequence,—the

oldest lying at the bottom and the newest at the top. Relics of an ancient sea-floor are overlain by traces of a vanished land-surface; these are in turn covered by the deposits of a former lake, above which once more appear proofs of the return of the sea. Among these rocky records lie the lavas and ashes of long-extinct volcanoes. The ripple left upon the shore, the cracks formed by the sun's heat upon the muddy bottom of a dried-up pool, the very imprint of the drops of a passing rain-shower, have all been accurately preserved, and yield their evidence as to geographical conditions often widely different from those which exist where such markings are now found.

But it is mainly by the remains of plants and animals imbedded in the rocks that the geologist is guided in unravelling the chronological succession of geological changes. He has found that a certain order of appearance characterizes these organic remains, that each great group of rocks is marked by its own special types of life, and that these types can be recognized, and the rocks in which they occur can be correlated even in distant countries, and where no other means of comparison would be possible. At one moment he has to deal with the bones of some large mammal scattered through a deposit of superficial gravel, at another time with the minute foraminifers and ostracods of an upraised sea-bottom. Corals and crinoids crowded and crushed into a massive limestone where they lived and died, ferns and terrestrial plants matted together into a bed of coal where they originally grew, the scattered shells of a submarine sand-bank, the snails and lizards which lived and died within a hollow-tree, the insects which have been imprisoned within the exuding resin of old forests, the footprints of birds and quadrupeds, the trails of worms left upon former shores—these, and innumerable other pieces of evidence, enable the geologist to realize in some measure what the faunas and floras of successive periods have been, and what geographical changes the site of every land has undergone.

It is evident that to deal successfully with these varied materials, a considerable acquaintance with different branches of science is needful. Especially necessary is a tolerably wide knowledge of the processes now at work in changing the surface of the earth, and of at least those forms of plant and animal life whose remains are apt to be preserved in geological deposits, or which in their structure and habitat enable us to realize what their forerunners were. It has often been insisted that the present is the key to the past; and in a wide sense this assertion is eminently true. Only in proportion as we understand the present, where everything is open on all sides to the fullest investigation, can we expect to decipher the past, where so much is obscure, imperfectly preserved or not preserved at all. A study of the existing economy of nature ought thus to be the foundation of the geologist's training.

While, however, the present condition of things is thus employed, we must obviously be on our guard against the danger of unconsciously assuming that the phase of nature's operations which we now witness has been the same in all past time, that geological changes have always or generally taken place in former ages in the manner and on the scale which we behold to-day, and that at the present time all the great geological processes, which have produced changes in the past eras of the earth's history, are still existent and active. As a working hypothesis we may suppose that the nature of geological processes has remained constant from the beginning; but we cannot postulate that the action of these processes has never varied in energy. The few centuries wherein man has been observing nature obviously form much too brief an interval by which to measure the intensity of geological action in all past time. For aught we can tell the present is an era of quietude and slow change, compared with some of the eras which have preceded it. Nor perhaps can we be quite sure that, when we have explored every geological process now in progress, we have exhausted all the causes of change which, even in comparatively recent times, have been at work.

In dealing with the geological record, as the accessible solid part of the globe is called, we cannot too vividly realize that at

the best it forms but an imperfect chronicle. Geological history cannot be compiled from a full and continuous series of documents. From the very nature of its origin the record is necessarily fragmentary, and it has been further mutilated and obscured by the revolutions of successive ages. And even where the chronicle of events is continuous, it is of very unequal value in different places. In one case, for example, it may present us with an unbroken succession of deposits many thousands of feet in thickness, from which, however, only a few meagre facts as to geological history can be gleaned. In another instance it brings before us, within the compass of a few yards, the evidence of a most varied and complicated series of changes in physical geography, as well as an abundant and interesting suite of organic remains. These and other characteristics of the geological record become more apparent and intelligible as we proceed in the study of the science.

Classification.—For systematic treatment the subject may be conveniently arranged in the following parts:—

1. *The Historical Development of Geological Science.*—Here a brief outline will be given of the gradual growth of geological conceptions from the days of the Greeks and Romans down to modern times, tracing the separate progress of the more important branches of inquiry and noting some of the stages which in each case have led up to the present condition of the science.

2. *The Cosmical Aspects of Geology.*—This section embraces the evidence supplied by astronomy and physics regarding the form and motions of the earth, the composition of the planets and sun, and the probable history of the solar system. The subjects dealt with under this head are chiefly treated in separate articles.

3. *Geognosy.*—An inquiry into the materials of the earth's substance. This division, which deals with the parts of the earth, its envelopes of air and water, its solid crust and the probable condition of its interior, especially treats of the more important minerals of the crust, and the chief rocks of which that crust is built up. Geognosy thus lays a foundation of knowledge regarding the nature of the materials constituting the mass of the globe, and prepares the way for an investigation of the processes by which these materials are produced and altered.

4. *Dynamical Geology* studies the nature and working of the various geological processes whereby the rocks of the earth's crust are formed and metamorphosed, and by which changes are effected upon the distribution of sea and land, and upon the forms of terrestrial surfaces. Such an inquiry necessitates a careful examination of the existing geological economy of nature, and forms a fitting introduction to an inquiry into the geological changes of former periods.

5. *Geotectonic or Structural Geology* has for its object the architecture of the earth's crust. It embraces an inquiry into the manner in which the various materials composing this crust have been arranged. It shows that some have been formed in beds or strata of sediment on the floor of the sea, that others have been built up by the slow aggregation of organic forms, that others have been poured out in a molten condition or in showers of loose dust from subterranean sources. It further reveals that, though originally laid down in almost horizontal beds, the rocks have subsequently been crumpled, contorted and dislocated, that they have been incessantly worn down, and have often been depressed and buried beneath later accumulations.

6. *Palaontological Geology.*—This branch of the subject, starting from the evidence supplied by the organic forms which are found preserved in the crust of the earth, includes such questions as the relations between extinct and living types, the laws which appear to have governed the distribution of life in time and in space, the relative importance of different genera of animals in geological inquiry, the nature and use of the evidence from organic remains regarding former conditions of physical geography. Some of these problems belong also to zoology and botany, and are more fully discussed in the articles PALAONTOLOGY and PALAEOBOTANY.

7. *Stratigraphical Geology.*—This section might be called

geological history. It works out the chronological succession of the great formations of the earth's crust, and endeavours to trace the sequence of events of which they contain the record. More particularly, it determines the order of succession of the various plants and animals which in past time have peopled the earth, and thus ascertains what has been the grand march of life upon this planet.

8. *Physiographical Geology*, proceeding from the basis of fact laid down by stratigraphical geology regarding former geographical changes, embraces an inquiry into the origin and history of the features of the earth's surface—continental ridges and ocean basins, plains, valleys and mountains. It explains the causes on which local differences of scenery depend, and shows under what very different circumstances, and at what widely separated intervals, the hills and mountains, even of a single country, have been produced.

Most of the detail embraced in these several sections is relegated to separate articles, to which references are here inserted. The following pages thus deal mainly with the general principles and historical development of the science:—

PART I.—HISTORICAL DEVELOPMENT

Geological Ideas among the Greeks and Romans.—Many geological phenomena present themselves in so striking a form that they could hardly fail to impress the imagination of the earliest and rudest races of mankind. Such incidents as earthquakes and volcanic eruptions, destructive storms on land and sea, disastrous floods and landslips suddenly strewn valleys with ruin, must have awakened the terror of those who witnessed them. Prominent features of landscape, such as mountain-chains with their snows, clouds and thunderstorms, dark river-chasms that seem purposely cleft open in order to give passage to the torrents that rush through them, crags with their impressive array of pinnacles and recesses must have appealed of old, as they still do, to the awe and wonder of those who for the first time beheld them. Again, banks of sea-shells in far inland districts would, in course of time, arrest the attention of the more intelligent and reflective observers, and raise in their minds some kind of surmise as to how such shells could ever have come there. These and other conspicuous geological problems found their earliest solution in legends and myths, wherein the more striking terrestrial features and the elemental forces of nature were represented to be the manifestation of the power of unseen supernatural beings.

The basin of the Mediterranean Sea was especially well adapted, from its physical conditions, to be the birth-place of such fables. It is a region frequently shaken by earthquakes, and contains two distinct centres of volcanic activity, one in the Aegean Sea and one in Italy. It is bounded on the north by a long succession of lofty snow-capped mountain-ranges, whence copious rivers, often swollen by heavy rains or melted snows, carry the drainage into the sea. On the south it boasts the Nile, once so full of mystery; likewise wide tracts of arid desert with their dreaded dust storms. The Mediterranean itself, though an inland sea, is subject to gales, which, on exposed coasts, raise breakers quite large enough to give a vivid impression of the power of ocean waves. The countries that surround this great sheet of water display in many places widely-spread deposits full of sea shells, like those that still live in the neighbouring bays and gulfs. Such a region was not only well fitted to supply subjects for mythology, but also to furnish, on every side, materials which, in their interest and suggestiveness, would appeal to the reason of observant men.

It was natural, therefore, that the early philosophers of Greece should have noted some of these geological features, and should have sought for other explanations of them than those to be found in the popular myths. The opinions entertained in antiquity on these subjects may be conveniently grouped under two heads: (1) Geological processes now in operation, and (2) geological changes in the past.

1. *Contemporary Processes.*—The geological processes of the present time are partly at work underground and partly on the surface of the earth. The former, from their frequently disastrous character, received much attention from Greek and Roman authors. Aristotle, in his *Meteorics*, cites the Earth-quake and volcano. speculations of several of his predecessors which he rejects in favour of his own opinion to the effect that earthquakes are due to the generation of wind within the earth, under the influence of the warmth of the sun and the internal heat. Wind, being the lightest and most rapidly moving body, is the cause of motion in other bodies, and fire, united with wind, becomes flame, which is endowed with great rapidity of motion. Aristotle looked upon earthquakes and volcanic eruptions as closely connected with each other, the discharge of hot materials to the surface being the result of a severe earthquake, when finally the wind rushes out with violence, and sometimes buries the surrounding country under sparks and cinders,

as had happened at Lipari. These crude conceptions of the nature of volcanic action, and the cause of earthquakes, continued to prevail for many centuries. They are repeated by Lucretius, who, however, following Anaximenes, includes as one of the causes of earthquakes the fall of mountainous masses of rock undermined by time, and the consequent propagation of gigantic tremors far and wide through the earth. Strabo, having travelled through the volcanic districts of Italy, was able to recognize that Vesuvius had once been an active volcano, although no eruption had taken place from it within human memory. He continued to hold the belief that volcanic energy arose from the movement of subterranean wind. He believed that the district around the Strait of Messina, which had formerly suffered from destructive earthquakes, was seldom visited by them after the volcanic vents of that region had been opened, so as to provide an escape for the subterranean fire, wind, water and burning masses. He cites in his *Geography* a number of examples of widespread as well as local sinkings of land, and alludes also to the uprise of the sea-bottom. He likewise regards some islands as having been thrown up by volcanic agency, and others as torn from the mainland by such convulsions as earthquakes.

The most detailed account of earthquake phenomena which has come down to us from antiquity is that of Seneca in his *Quaestiones Naturales*. This philosopher had been much interested in the accounts given him by survivors and witnesses of the earthquake which convulsed the district of Naples in February A.D. 63. He distinguished several distinct movements of the ground: 1st, the up and down motion (*suscussio*); 2nd, the oscillatory motion (*inclinatio*); and probably a third, that of trembling or vibration. While admitting that some earthquakes may arise from the collapse of the walls of subterranean cavities, he adhered to the old idea, held by the most numerous and important previous writers, that these commotions are caused mainly by the movements of wind imprisoned within the earth. As to the origin of volcanic outbursts he supposed that the subterranean wind in struggling for an outlet, and whirling through the chasms and passages, meets with great store of sulphur and other combustible substances, which by mere friction are set on fire. The elder Pliny reiterates the commonly accepted opinion as to the efficacy of wind underground. In discussing the phenomena of earthquakes he remarks that towns with many culverts and houses with cellars suffer less than others, and that at Naples those houses are most shaken which stand on hard ground. It thus appears that with regard to subterranean geological operations, no advance was made during the time of the Greeks and Romans as to the theoretical explanation of these phenomena; but a considerable body of facts was collected, especially as to the effects of earthquakes and the occurrence of volcanic eruptions.

The superficial processes of geology, being much less striking than those of subterranean energy, naturally attracted less attention in antiquity. The operations of rivers, however, which so intimately affect a human population, were watched with more or less care. Herodotus, struck by the amount of alluvial silt brought down annually by the Nile and spread over the flat inundated land, inferred that "Egypt is the gift of the river." Aristotle, in discussing some of the features of rivers, displays considerable acquaintance with the various drainage-systems on the north side of the Mediterranean basin. He refers to the mountains as condensers of the atmospheric moisture, and shows that the largest rivers rise among the loftiest high grounds. He shows how sensibly the alluvial deposits carried down to the sea increase the breadth of the land, and cites some parts of the shores of the Black Sea, where, in sixty years, the rivers had brought down such a quantity of material that the vessels then in use required to be of much smaller draught than previously, the water shallowing so much that the marshy ground would, in course of time, become dry land. Strabo supplies further interesting information as to the work of rivers in making their alluvial plains and in pushing their deltas seaward. He remarks that these deltas are prevented from advancing farther outward by the ebb and flow of the tides.

3. *Past Processes*.—The abundant well-preserved marine shells exposed among the upraised Tertiary and post-Tertiary deposits in the countries bordering the Mediterranean are not infrequently alluded to in Greek and Latin literature. Xenophanes of Colophon (614 B.C.) noticed the occurrence of shells and other marine productions inland among the mountains, and inferred from them that the land had risen out of the sea. A similar conclusion was drawn by Xanthus the Lydian (464 B.C.) from shells like scallops and cockles, which were found far from the sea in Armenia and Lower Phrygia. Herodotus, Eratosthenes, Strabo and Strabo noted the vast quantities of fossil shells in different parts of Egypt, together with beds of salt, as evidence that the sea had once spread over the country. But by far the most philosophical opinions on the past mutations of the earth's surface are those expressed by Aristotle in the treatise already cited. Reviewing the evidence of these changes, he recognized that the sea now covers tracts that were once dry land, and that land will one day reappear where there is now sea. These alternations are to be regarded as following each other in a certain order and periodicity. *But they are apt to escape our notice because they require successive periods of time, which, compared with our brief existence, are of*

enormous duration, and because they are brought about so imperceptibly that we fail to detect them in progress. In a celebrated passage in his *Metamorphoses*, Ovid puts into the mouth of the philosopher Pythagoras an account of what was probably regarded as the Pythagorean view of the subject in the Augustan age. It affirms the interchange of land and sea, the erosion of valleys by descending rivers, the washing down of mountains into the sea, the disappearance of the rivers and the submergence of land by earthquake movements, the separation of some islands from, and the union of others with, the mainland, the uprise of hills by volcanic action, the rise and extinction of burning mountains. There was a time before Etna began to glow, and the time is coming when the mountain will cease to burn.

From this brief sketch it will be seen that while the ancients had accumulated a good deal of information regarding the occurrence of geological changes, their interpretations of the phenomena were to a considerable extent mere fanciful speculation. They had acquired only a most imperfect conception of the nature and operation of the geological processes; and though many writers realized that the surface of the earth has not always been, and will not always remain, as it is now, they had no glimpse of the vast succession of changes of that surface which have been revealed by geology. They built hypotheses on the slenderest basis of fact, and did not realize the necessity of testing or verifying them.

Progress of Geological Conceptions in the Middle Ages.—During the centuries that succeeded the fall of the Western empire little progress was made in natural science. The schoolmen in the monasteries and other seminaries were content to take their science from the literature of Greece and Rome. The Arabs, however, not only collected and translated that literature, but in some departments made original observations themselves. To one of the most illustrious of their number, Avicenna, the translator of Aristotle, a treatise has been ascribed, in which singularly modern ideas are expressed regarding mountains, some of which are there stated to have been produced by an uplifting of the ground, while others have been left prominent, owing to the wearing away of the softer rocks around them. In either case, it is confessed that the process would demand long tracts of time for its completion.

After the revival of learning the ancient problem presented by fossil shells imbedded in the rocks of the interior of many countries received renewed attention. But the conditions for its solution were no longer what they had been in the days of the philosophers of antiquity. Men were not now free to adopt and teach any doctrine they pleased on the subject. The Christian church had meanwhile arisen to power all over Europe, and adjudged as heretics all who ventured to impugn any of her dogmas. She taught that the land and the sea had been separated on the third day of creation, before the appearance of any animal life, which was not created until the fifth day. To assert that the dry land is made up in great part of rocks that were formed in the sea, and are crowded with the remains of animals, was plainly to impugn the veracity of the Bible. Again, it had come to be the orthodox belief that only somewhere about 6000 years had elapsed since the time of Adam and Eve. If any thoughtful observer, impressed with the overwhelming force of the evidence that the fossiliferous formations of the earth's crust must have taken long periods of time for their accumulation, ventured to give public expression to his conviction, he ran considerable risk of being proceeded against as a heretic. It was needful, therefore, to find some explanation of the facts of nature, which would not run counter to the ecclesiastical system of the day. Various such interpretations were proposed, doubtless in an honest endeavour at reconciliation. Three of these deserve special notice: (1) Many able observers and diligent collectors of fossils persuaded themselves that these objects never belonged to organisms of any kind, but should be regarded as mere "freaks of nature," having no more connexion with any once living creature than the frost patterns on a window. They were styled "formed" or "figured" stones, "lapides sui generis," and were asserted to be due to some inorganic imitative process within the earth or to the influence of the stars. (2) Observers who could not resist the evidence of their senses that the fossil shells once belonged to living animals, and who, at the same time, felt the necessity of accounting for the presence of marine organisms in the rocks of which the dry land is largely built up, sought a way out of the difficulty by invoking the Deluge of Noah. Here was a catastrophe which, they said, extended over the whole globe, and by which the entire dry land was submerged even up to the tops of the high hills. True, it only lasted one hundred and fifty days, but so little were the facts then appreciated that no difficulty seems to have been generally felt in crowding the accumulation of the thousands of feet of fossiliferous formations into that brief space of time. (3) Some more intelligent men in Italy, recognizing that these interpretations could not be upheld, fell back upon the idea that the rocks in which fossil shells are imbedded might have been heaped up by repeated and vigorous eruptions from volcanic centres. Certain modern eruptions in the Aegean Sea and in the Bay of Naples had drawn attention to the rapidity with which hills of considerable size could be piled around an active crater. It was argued that if Monte Nuovo near Naples could have been accumulated to a height of nearly 500 ft. in two days, there seemed to be no reason against believing that, during the time of the Flood, and in the course of the

centuries that have elapsed since that event, the whole of the fossiliferous rocks might have been deposited. Unfortunately for this hypothesis it ignored the fact that these rocks do not consist of volcanic materials.

So long as the fundamental question remained in dispute as to the true character and history of the stratified portion of the earth's crust containing organic remains, geology as a science could not begin its existence. The diluvialists (those who relied on the hypothesis of the Flood) held the field during the 16th, 17th and a great part of the 18th century. They were looked on as the champions of orthodoxy; and, on that account, they doubtless wielded much more influence than would have been gained by them from the force of their arguments. Yet during those ages there were not wanting occasional observers who did good service in combating the prevalent misconceptions, and in preparing the way for the ultimate triumph of truth. It was more especially in Italy, where many of the more striking phenomena of geology are conspicuously displayed, that the early pioneers of the science arose, and that for several generations the most marked progress was made towards placing the investigations of the past history of the earth upon a basis of careful observation and scientific deduction. One of the first of these leaders was Leonardo da Vinci (1452-1519), who, besides his achievements in painting, sculpture, architecture and engineering, contributed some notable observations regarding the great problem of the origin of fossil shells. He ridiculed the notion that these objects could have been formed by the influence of the stars, and maintained that they had once belonged to living organisms, and therefore that what is now land was formerly covered by the sea. Girolamo Fracastorio (1483-1553) claimed that the shells could never have been left by the Flood, which was a mere temporary inundation, but that they proved the mountains, in which they occur, to have been successively uplifted out of the sea. On the other hand, even an accomplished anatomist like Gabriello Falloppio (1523-1562) found it easier to believe that the bones of elephants, teeth of sharks, shells and other fossils were mere earthy inorganic concretions, than that the waters of Noah's Flood could ever have reached as far as Italy.

By much the most important member of this early band of Italian writers was undoubtedly Nicolas Steno (1631-1687), who, though born in Copenhagen, ultimately settled in Florence. Having made a European reputation as an anatomist, his attention was drawn to geological problems by finding that the rocks of the north of Italy contained what appeared to be sharks' teeth closely resembling those of a dog-fish, of which he had published the anatomy. Cautiously at first, for fear of offending orthodox opinions, but afterwards more boldly, he proclaimed his conviction that those objects had once been part of living animals, and that they threw light on some of the past history of the earth. He published in 1669 a small tract, *De solido intra solidum naturaliter contento*, in which he developed the ideas he had formed of this history from an attentive study of the rocks. He showed that the stratified formations of the hills and valleys consist of such materials as would be laid down in the form of sediment in turbid water; that where they contain marine productions this water is proved to have been the sea; that diversities in their composition point to commingling of currents, carrying different kinds of sediment of which the heaviest would first sink to the bottom. He made original and important observations on stratification, and laid down some of the fundamental axioms in stratigraphy. He reasoned that as the original position of strata was approximately horizontal, when they are found to be steeply inclined or vertical, or bent into arches, they have been disrupted by subterranean exhalations, or by the falling in of the roofs of underground cavernous spaces. It is to this alteration of the original position of the strata that the inequalities of the earth's surface, such as mountains, are to be ascribed, though some have been formed by the outburst of fire, ashes and stones from the inside the earth. Another effect of the dislocation has been to provide fissures which serve as outlets for springs. Steno's anatomical training peculiarly fitted him for dealing authoritatively with the question of the nature and origin of the fossils contained in the rocks. He had no hesitation in affirming that, even if no shells had ever been found living in the sea, the internal structure of these fossils would demonstrate that they once formed parts of living animals. And not only shells, but teeth, bones and skeletons of many kinds of fishes had been quarried out of the rocks, while some of the strata had skulls, horns and teeth of land-animals. Illustrating his general principles by a sketch of what he supposed to have been the past history of Tuscany, he added a series of diagrams which show how clearly he had conceived the essential elements of stratigraphy. He thought he could perceive the records of six successive phases in the evolution of the framework of that country, and was inclined to believe that a similar chronological sequence would be found all over the world. He anticipated the objections that would be brought against his views on account of the insuperable difficulty in granting the length of time that would be required for all the geographical vicissitudes which his interpretation required. He thought that many of the fossils must be as old as the time of the general deluge, but he was careful not to indulge in any speculation as to the antiquity of the earth.

To the Italian school, as especially typified in Steno, must be assigned the honour of having thus begun to lay firmly and truly the first foundation stones of the modern science of geology. The same school included Antonio Vallisneri (1661-1730), who surpassed his predecessors in his wider and more exact knowledge of the fossiliferous rocks that form the backbone of the Italian peninsula, which he contended were formed during a wide and prolonged subsidence of the region, altogether different from the brief deluge of Noah. There was likewise Lazzaro Moro (1687-1740), who did good service against the diluvialists, but the fundamental feature of his system of nature lay in the preponderant part which, unaware of the great difference between volcanic materials and ordinary sediment, he assigned to volcanic action in the production of the sedimentary rocks of the earth's crust. He supposed that in the beginning the globe was completely surrounded with water, beneath which the solid earth lay as a smooth ball. On the third day of creation, however, vast fires were kindled inside the globe, whereby the smooth surface of stone was broken up, and portions of it, appearing above the water, formed the earliest land. From that time onward, volcanic eruptions succeeded each other, not only on the emerged land, but on the sea-floor, over which the ejected material spread in an ever augmenting thickness of sedimentary strata. In this way Moro carried the history of the stratified rocks beyond the time of the Flood back to the Creation, which was supposed to have been some 1600 years earlier; and he brought it down to the present day, when fresh sedimentary deposits are continually accumulating. He thus incurred no censure from the ecclesiastical guardians of the faith, and he succeeded in attracting increased public attention to the problems of geology. The influence of his teaching, however, was subsequently in great part due to the Carmelite friar Genesini, who published an eloquent exposition of Moro's views.

The Cosmogonists and Theories of the Earth.—While in Italy substantial progress was made in collecting information regarding the fossiliferous formations of that country, and in forming conclusions concerning them based upon more or less accurate observations, the tendency to mere fanciful speculation, which could not be wholly repressed in any country, reached a remarkable extravagance in England. In proportion as materials were yet lacking from which to construct a history of the evolution of our planet in accordance with the teaching of the church, imagination supplied the place of ascertained fact, and there appeared during the last twenty years of the 18th century a group of English cosmogonists, who, by the sensational character of their speculations, aroused general attention both in Britain and on the continent. It may be doubted, however, whether the effect of their writings was not to hinder the advance of true science by diverting men from the observation of nature into barren controversy over unrealities. It is not needful here to do more than mention the names of Thomas Burnet, whose *Sacred Theory of the Earth* appeared in 1681, and William Whiston, whose *New Theory of the Earth* was published in 1696. Hardly less fanciful than these writers, though his practical acquaintance with rocks and fossils was infinitely greater, was John Woodward, whose *Essay towards a Natural History of the Earth* dates from 1695. More important as a contribution to science was the catalogue of the large collection of fossils, which he had made from the rocks of England and which he bequeathed to the university of Cambridge. This catalogue appeared in 1728-1729 with the title of *An attempt towards a Natural History of the Fossils of England*.

A striking contrast to these cosmogonists is furnished by another group, which arose in France and Germany, and gave to the world the first rational ideas concerning the probable primeval evolution of our globe. The earliest of these pioneers was the illustrious philosopher René Descartes (1596-1650). He propounded a scheme of cosmical development in which he represented the earth, like the other planets, to have been originally a mass of glowing material like the sun, and to have gradually cooled on the outside, while still retaining in its incandescent, self-luminous nucleus. Yet with this noble conception, which modern science has accepted, Descartes could not shake himself free from the time-honoured error in regard to the origin of volcanic action. He thought that certain exhalations within the earth condense into oil, which, when in violent motion, enters into the subterranean cavities, where it passes into a kind of smoke. This smoke in from time to time ignited by a spark of fire and, pressing violently against its containing walls, gives rise to earthquakes. If the flame breaks through to the surface at the top of a mountain, it may escape with enormous energy, hurling forth much earth mingled with sulphur or bitumen, and thus producing a volcano. The mountain might burn for a long time until at last its store of fuel in the shape of sulphur or bitumen would be exhausted. Not only did the philosopher refrain from availing himself of the high internal temperature of the globe as the source of volcanic energy, he even did not make use of it as the cause of the ignition of his supposed internal fuel, but speculated on the kindling of the subterranean fires by the spirits or gases setting fire to the exhalations, or by the fall of masses of rock and the sparks produced by their friction or percussion.

The ideas of Descartes regarding planetary evolution were enlarged and made more definite by Wilhelm Gottfried Leibnitz (1646-1716), whose teaching has largely influenced all subsequent speculation.

on the subject. In his great tract, the *Protogæa* (published in 1749, thirty-three years after his death), he traced the probable passage of our earth from an original condition of incandescent vapour into that of a smooth molten globe, which, by continuous cooling, acquired an external solid crust and rugose surface. He thought that the more ancient rocks, such as granite and gneiss, might be portions of the earliest outer crust; and that as the external solidification advanced, immense subterranean cavities were left which were filled with air and water. By the collapse of the roofs of these caverns, valleys might be originated at the surface, while the solid intervening walls would remain in place and form mountains. By the disruption of the crust, enormous bodies of water were launched over the surface of the earth, which swept vast quantities of sediment together, and thus gave rise to sedimentary deposits. After many vicissitudes of this kind, the terrestrial forces calmed down, and a more stable condition of things was established.

An important feature in the cosmogony of Leibnitz is the prominent place which he assigned to organic remains in the stratified rocks of the crust. Ridiculing the foolish attempts to account for the presence of these objects by calling them "sports of nature," he showed that they are to be regarded as historical monuments; and he adduced a number of instances wherein successive platforms of strata, containing organic remains, bear witness to a series of advances and retreats of the sea. He recognized that some of the fossils appeared to have nothing like them in the living world of to-day, but some analogous forms might yet be found, he thought, in still unexplored parts of the earth; and even if no living representatives should ever be discovered, many types of animals might have undergone transformation during the great changes which had affected the surface of the earth. In spite of his clear realization of the vast store of potential energy residing within the highly heated interior of the earth, Leibnitz continued to regard volcanic action as due to the combustion of inflammable substances enclosed within the terrestrial crust, such as stone-coal, naphtha and sulphur.

Appealing to a much wider public than Descartes or Leibnitz, and basing his speculations on a wider acquaintance with the organic and inorganic realms of nature, G. L. de Buffon (1707-1788) was undoubtedly one of the most influential forces that in Europe guided the growth of geological ideas during the 18th century. He published in 1749 a *Theory of the Earth*, in which he adopted views similar to those of Descartes and Leibnitz as to planetary evolution; but though he realized the importance of fossils as records of former conditions of the earth's surface, he accounted for them by supposing that they had been deposited from a universal ocean, a large part of which had subsequently been engulfed into caverns in the interior of the globe. Thirty years later, after having laboured with skill and enthusiasm in all branches of natural history, he published another work, his famous *Epoques de la nature* (1778), which is specially remarkable as the first attempt to deal with the history of the earth in a chronological manner, and to compute, on a basis of experiment, the antiquity of the several stages of this history. His experiments were made with globes of cast iron, and could not have yielded results of any value for his purpose; but in so far as his calculations were not mere random guesses but had some kind of foundation on experiment, they deserve respectful recognition. He divided the history of our earth into six periods of unequal duration, the whole comprising a period of some 70,000 or 75,000 years. He supposed that the stage of incandescence, before the globe had consolidated to the centre, lasted 2936 years, and that about 35,000 years elapsed before the surface had cooled sufficiently to be touched, and therefore to be capable of supporting living things. Terrestrial animal life, however, was not introduced until 55,000 or 60,000 years after the beginning of the world or about 15,000 years before our time. Looking into the future, he foresaw that, by continued refrigeration, our globe will eventually become colder than ice, and this fair face of nature, with its manifold varieties of plant and animal life, will perish after having existed for 132,000 years.

Buffon's conception of the operation of the geological agents did not become broader or more accurate in the interval between the appearance of his two treatises. He still continued to believe in the lowering of the ocean by subsidence into vast subterranean cavities, with a consequent emergence of land. He still looked on volcanoes as due to the burning of "pyritous and combustible stones," though he now called in the co-operation of electricity. He calculated that the first volcanoes could not arise until some 50,000 years after the beginning of the world, by which time a sufficient extent of dense vegetation had been buried in the earth to supply them with fuel. He appears to have had but an imperfect acquaintance with the literature of his own time. At least there can be little doubt that had he availed himself of the labours of his own countryman, Jean Etienne Guettard (1715-1786), of Giovanni Arduino (1714-1795) in Italy, and of Johann Gottlob Lehmann (d. 1767) and George Christian Fuchs (1722-1773) in Germany, he would have been able to give to his "epochs" a more definite succession of events and a greater correspondence with the facts of nature.

Among the writers of the 18th century, who formed philosophical conceptions of the system of processes by which the life of our earth as a habitable globe is carried on, a foremost place must be assigned to James Hutton (1726-1797). Educated for the medical profession,

he studied at Edinburgh and at Paris, and took his doctor's degree at Leiden. But having inherited a small landed property in Berwickshire, he took to agriculture, and after putting his land into excellent order, let his farm and betook himself to Edinburgh, there to gratify the scientific tastes which he had developed early in life. He had been more especially led to study minerals and rocks, and to meditate on the problems which they suggest as to the constitution and history of the earth. His journeys in Britain and on the continent of Europe had furnished him with material for reflection; and he had gradually evolved a system or theory in which all the scattered facts could be arranged so as to show their mutual dependence and their place in the orderly mechanism of the world. He used to discuss his views with one or two of his friends, but refrained from publishing them to the world until, on the foundation of the Royal Society of Edinburgh, he communicated an outline of his doctrine to that learned body in 1785. Some years later he expanded this first essay into a larger work in two volumes, which were published in 1795 with the title of *Theory of the Earth, with Proofs and Illustrations*.

Hutton's teaching has exercised a profound influence on modern geology. This influence, however, has arisen less from his own writings than from the account of his doctrines given by his friend John Playfair in the classic work entitled *Illustrations of the Huttonian Theory*, published in 1802.

Hutton wrote in so prolix and obscure a style as rather to repel than attract readers. Playfair, on the other hand, expressed himself in such clear and graceful language as to command general attention, and to gain wide acceptance for his master's views. Unlike the older cosmogonists, Hutton refrained from trying to explain the origin of things, and from speculations as to what might possibly have been the early history of our globe. He determined from the outset to interpret the past by what can be seen to be the present order of nature; and he refused to admit the operation of causes which cannot be shown to be part of the actual terrestrial system. Like other observers who had preceded him, he recognized in the various rocks composing the dry and evidence of former geographical conditions very different from those which now prevail. He saw that the vast majority of rocks consist of hardened sediments and must have been deposited in the sea. He could distinguish among them an older or Primary series, and a younger or Secondary series; and did not dispute the existence of a Tertiary series claimed by Peter Simon Pallas (1741-1811). He believed that these various aqueous accumulations had been consolidated by subterranean heat, that the oldest and lowest rocks had suffered most from this action, that into these more deep-seated masses subsequent veins and larger bodies of molten matter were injected from below, and thus that what was originally loose detritus eventually became changed in such crystalline schists as are now found in mountain-chains. In the course of these terrestrial revolutions sedimentary strata, originally more or less nearly horizontal, have been pushed upward, dislocated, crumpled, placed on end, and even elevated to form ranges of lofty mountains. Hutton looked upon these disturbances as due to the expansive power of subterranean heat; but he did not attempt to sketch the mechanism of the process, and he expressly declined to offer any conjecture as to how the land so elevated remained in that position. He thought that the interior of our planet may "be a fluid mass, melted, but unchanged by the action of heat"; and, far from connecting volcanoes with the combustion of inflammable substances, as had been the prevalent belief for so many centuries, he looked upon them as a beneficent provision of "spiracles to the subterranean furnace, in order to prevent the unnecessary elevation of land and fatal effects of earthquakes."

A distinguishing feature of the Huttonian philosophy is to be seen in the breadth of its conceptions regarding the geological operations continually in progress on the surface of the globe. Hutton saw that the land is undergoing a ceaseless process of degradation, through the influence of the air, frost, rain, rivers and the sea, and that in course of time, if no countervailing agency should intervene, the whole of the dry land will be washed away into the sea. But he also perceived that this universal erosion is not everywhere carried on at the same rate; that it is specially active along the channels of torrents and rivers, and that, owing to this difference these channels are gradually deepened and widened, until the complicated valley-system of a country is carved out. He recognized that the detritus worn away from the land must be spread out over the floor of the sea, so as to form there strata similar to those that compose most of the dry land. As he could detect in the structure of land convincing evidence that former sea floors had been elevated to form the continents and islands of to-day, he could look forward to future ages, when the same subterranean agency which had raised up the present land would again be employed to uplift the bed of the existing ocean, thus to renew the surface of our earth as a habitable globe, and to start a fresh cycle of erosion and deposition.

Though Hutton was not unaware that organic remains abound in many of the stratified rocks, he left them out of consideration in the elaboration of his theory. It was otherwise with Lamarck, one of his French contemporaries, the illustrious J. B. Lamarck (1744-1829), who, after having attained great eminence as a botanist, turned to zoology when he was nearly fifty years of age, and before long rose to even greater distinction in that department

of science. His share in the classification and description of the mollusca and in founding invertebrate palaeontology, his theory of organic evolution and his philosophical treatment of many biological questions have been tardily recognized, but his contributions to geology have been generally acknowledged. When he accepted the "professorship of zoology: of insects, of worms and of microscopic animals" at the Museum of Natural History, Paris, in 1793, he at once entered with characteristic ardour and capacity into the new field of research then opened to him. In dealing with the mollusca he considered not merely the living but also the extinct forms, especially the abundant, varied and well-preserved genera and species furnished by the Tertiary deposits of the Paris basin, of which he published descriptions and plates that proved of essential service in the stratigraphical work of Cuvier and Alexandre Brongniart (1770-1847). His labours among these relics of ancient seas and lakes led him to ponder over the past history of the globe, and as he was seldom dilatory in making known the opinions he had formed, he communicated some of his conclusions to the National Institute in 1799. These, including a further elaboration of his views, he published in 1802 in a small volume entitled *Hydrogéologie*.

This treatise, though it did not reach a second edition and has never been reprinted, deserves an honourable place in geological literature. Its object, the author states, was to present some important and novel considerations, which he thought should form the basis of a true theory of the earth. He entirely agreed with the doctrine of the subaerial degradation of the land and the erosion of valleys by running water. Not even Playfair could have stated this doctrine more emphatically, and it is worthy of notice that Playfair's *Illustrations of the Huttonian Theory* appeared in the same year with Lamarck's book. The French naturalist, however, carried his conclusions so far as to take no account of any great movements of the terrestrial crust, which might have produced or modified the main physical features of the surface of the globe. He thought that all mountains, except such as were thrown up by volcanic agency or local accidents, have been cut out of plains, the original surfaces of which are indicated by the crests and summits of these elevations.

Lamarck, in reflecting upon the wide diffusion of fossil shells and the great height above the sea at which they are found, conceived the extraordinary idea that the ocean basin has been scoured out by the sea, and that, by an impulse communicated to the waters through the influence chiefly of the moon, the sea is slowly eating away the eastern margins of the continents, and throwing up detritus on their western coasts, and is thus gradually shifting its basin round the globe. He would not admit the operation of cataclysms; but insisted as strongly as Hutton on the continuity of natural processes, and on the necessity of explaining former changes of the earth's surface by causes which can still be seen to be in operation. As might be anticipated from his previous studies, he brought living things and their remains into the forefront of his theory of the earth. He looked upon fossils as one of the chief means of comprehending the revolutions which the surface of the earth has undergone; and in his little volume he again and again dwells on the vast antiquity to which these revolutions bear witness. He acutely argues, from the condition of fossil shells, that they must have lived and died where their remains are now found.

In the last part of his treatise Lamarck advances some peculiar opinions in physics and chemistry, which he had broached eighteen years before, but which had met with no acceptance among the scientific men of his time. He believed that the tendency of all compound substances is to decay, and thereby to be resolved into their component constituents. Yet he saw that the visible crust of the earth consists almost wholly of compound bodies. He therefore set himself to solve the problem thus presented. Perceiving that the biological action of living organisms is constantly forming combinations of matter, which would never have otherwise come into existence, he proceeded to draw the extraordinary conclusion that the action of plant and animal life (the *Pouvoir de la vie*) upon the inorganic world is so universal and so potent, that the rocks and minerals which form the outer part of the earth's crust are all, without exception, the result of the operations of once living bodies. Though this sweeping deduction must be allowed to detract from the value of Lamarck's work, there can be no doubt that he realized, more fully than any one had done before him, the efficacy of plants and animals as agents of geological change.

The last notable contributor to the cosmological literature of geology was another illustrious Frenchman, the comparative anatomist Cuvier (1769-1832). He was contemporary with Lamarck, but of a very different type of mind. The brilliance of his speculations, and the charm with which he expounded them, early gained for him a prominent place in the society of Paris. He too was drawn by his zoological studies to investigate fossil organic remains, and to consider the former conditions of the earth's surface, of which they are memorials. It was among the vertebrate organisms of the Paris basin that he found his chief material, and from them that he prepared the memoirs which led to him being regarded as the founder of vertebrate palaeontology. But beyond their biological interest, they awakened in him a keen desire to ascertain the character and sequence of the geographical revolutions to which they bear witness. He approached the subject from an opposite and less philosophical point of view than that of Lamarck,

coming to it with certain preconceived notions, which affected all his subsequent writings. While Lamarck was by instinct an evolutionist, who sought to trace in the history of the past the operation of the same natural processes as are still at work, Cuvier, on the other hand, was a catastrophist, who invoked a succession of vast cataclysms to account for the interruptions in the continuity of the geological record.

In a preliminary *Discourse* prefixed to his *Recherches sur les ossements fossiles* (1821) Cuvier gave an outline of what he conceived to have been the past history of our globe, so far as he had been able to comprehend it from his investigations of the Tertiary formations of France. He believed that in that history evidence can be recognized of the occurrence of many sudden and disastrous revolutions, which, to judge from their effects on the animal life of the time, must have exceeded in violence anything we can conceive at the present day, and must have been brought about by other agencies than those which are now in operation. Yet, in spite of these catastrophes, he saw that there has been an upward progress in the animal forms inhabiting the globe, until the series ended in the advent of man. He could not, however, find any evidence that one species has been developed from another, for in that case there should have been traces of intermediate forms among the stratified formations, where he affirmed that they had never been found. A prominent position in the *Discourse* is given to a strenuous argument to disprove the alleged antiquity of some nations, and to show that the last great catastrophe occurred not more than some 5000 or 6000 years ago. Cuvier thus linked himself with those who in previous generations had contended for the efficacy of the Deluge. But his researches among fossil animals had given him a far wider outlook into the geological past, and had opened up to him a succession of deeply interesting problems in the history of life upon the earth, which, though he had not himself material for their solution, he could foresee would be cleared up in the future.

Gradual Shaping of Geology into a Distinct Branch of Science.—It will be seen from the foregoing historical sketch that it was only after the lapse of long centuries, and from the labours of many successive generations of observers and writers, that what we now know as the science of geology came to be recognized as a distinct department of natural knowledge, founded upon careful and extended study of the structure of the earth, and upon observation of the natural processes, which are now at work in changing the earth's surface. The term "geology," a descriptive of this branch of the investigation of nature, was not proposed until the last quarter of the 18th century by Jean André De Luc (1727-1817) and Horace Benedict De Saussure (1740-1799). But the science was then in a markedly half-formed condition, theoretical speculation still in large part supplying the place of deductions from a detailed examination of actual fact. In 1807 a few enterprising spirits founded the Geological Society of London for the special purpose of counteracting the prevalent tendency and confining their intention "to investigate the mineral structure of the earth." The cosmogonists and framers of Theories of the Earth were succeeded by other schools of thought. The Catastrophists saw in the composition of the crust of the earth distinct evidence that the forces of nature were once much more stupendous in their operation than they now are, and that they had from time to time devastated the earth's surface; extirpating the races of plants and animals, and preparing the ground for new creations of organized life. Then came the Uniformitarians, who, pushing the doctrines of Hutton to an extreme which he did not propose, saw no evidence that the activity of the various geological causes has ever seriously differed from what it is at present. They were inclined to disbelieve that the stratified formations of the earth's crust furnish conclusive evidence of a gradual progression, from simple types of life in the oldest strata to the most highly developed forms in the youngest; and saw no reason why remains of the higher vertebrates should not be met with among the Palaeozoic formations. Sir Charles Lyell (1797-1875) was the great leader of this school. His admirably clear and philosophical presentations of geological facts which, with unwearied industry, he collected from the writings of observers in all parts of the world, impressed his views upon the whole English-speaking world, and gave to geological science a coherence and interest which largely accelerated its progress. In his later years, however, he frankly accepted the views of Darwin in regard to the progressive character of the geological record.

The youngest of the schools of geological thought is that of the Evolutionists. Pointing to the whole body of evidence from inorganic and organic nature, they maintain that the history of our planet has been one of continual and unbroken development from the earliest cosmical beginnings down to the present time, and that the crust of the earth contains an abundant, though incomplete, record of the successive stages through which the plant and animal

¹ In De Luc's *Lettres physiques et morales sur les montagnes* (1778), the word "cosmology" is used for our science, the author stating that "geology" is more appropriate, but it "was not a word in use." In a completed edition, published in 1779, the same statement is made, but "geology" occurs in the text; in the same year De Saussure used the word without any explanation, as if it were well known.

kingdoms have reached their existing organization. The publication of Darwin's *Origin of Species* in 1859, in which evolution was made the key to the history of the animal and vegetable kingdoms, produced an extraordinary revolution in geological opinion. The older schools of thought rapidly died out, and evolution became the recognized creed of geologists all over the world.

Development of Opinion regarding Igneous Rocks.—So long as the idea prevailed that volcanoes are caused by the combustion of inflammable substances underground, there could be no rational conception of volcanic action and its products. Even so late as the middle of the 18th century, as above remarked, such a good observer as Lazzaro Moro drew so little distinction between volcanic and other rocks that he could believe the fossiliferous formations to have been mainly formed of materials ejected from eruptive vents. After his time the notion continued to prevail that all the rocks which form the dry land were laid down under water. Even streams of lava, which were seen to flow from an active crater, were regarded only as portions of sedimentary or other rocks, which had been melted by the fervent heat of the burning inflammable materials that had been kindled underground. In spite of the speculations of Descartes and Leibnitz, it was not yet generally comprehended that there exists beneath the terrestrial crust, a molten magma, which, from time to time, has been injected into that crust, and has pierced through it, so as to escape at the surface with all the energy of an active volcano. What we now recognize to be memorials of these former injections and propulsions were all confounded with the rocks of unquestionably aqueous origin. The last great teacher by whom these antiquated doctrines were formulated into a system

and promulgated to the world was Abraham Gottlob Werner (1749-1815), the most illustrious German mineralogist and geognost of the second half of the 18th century. While still under twenty-six years of age, he was appointed teacher of mining and mineralogy at the Mining Academy of Freiberg in Saxony—a post which he continued to fill up to the end of his life. Possessed of great enthusiasm for his subject, clear, methodical and eloquent in his exposition of it, he soon drew around him men from all parts of the world, who repaired to study under the great oracle of what he called geognosy (Gr. γῆ, the earth, γνῶσις, knowledge) or earth-knowledge. Reviving doctrines that had been current long before his time, he taught that the globe was once completely surrounded with an ocean, from which the rocks of the earth's crust were deposited as chemical precipitates, in a certain definite order over the whole planet. Among these "universal formations" of aqueous origin were included many rocks, which have long been recognized to have been once molten, and to have risen from below into the upper parts of the terrestrial crust. Werner, following the old tradition, looked upon volcanoes as modern features in the history of the planet, which could not have come into existence until a sufficient amount of vegetation had been buried to furnish fuel for their maintenance. Hence he attached but little importance to them, and did not include in his system of rocks any division of volcanic or igneous materials. From the predominant part assigned by him to the sea in the accumulation of the materials of the visible part of the earth, Werner and his school were known as "Neptunists."

But many years before the Saxon professor began to teach, clear evidence had been produced from central France that basalt, one of the rocks claimed by him as a chemical precipitate and a universal formation, is a lava which has been poured out in a molten state at various widely separated periods of time and at many different places. So far back as 1752 J. E. Guettard (1715-1786) had shown that the basaltic rocks of Auvergne are true lavas, which have flowed out in streams from groups of once active cones. Eleven years later the observation was confirmed and greatly extended by Nicholas Desmarest (1725-1815), who, during a long course of years, worked out and mapped the complicated volcanic records of that interesting region, and demonstrated to all who were willing impartially to examine the evidence the true volcanic nature of basalt. These views found acceptance from some observers, but they were vehemently opposed by the followers of Werner, who, by the force of his genius, made his theoretical conceptions predominate all over Europe. The controversy as to the origin of basalt was waged with great vigour during the later decades of the 18th century. Desmarest took no part in it. He had accumulated such conclusive proof of the correctness of his deductions, and had so fully expounded the clearness of the evidence in their favour furnished by the region of Auvergne, that, when any one came to consult him on the subject, he contended himself with giving the advice to "go and see." While the debate was in progress on the continent, the subject was approached from a new and independent point of view by Hutton in Scotland. This illustrious philosopher, as already stated, realized the importance of the internal heat of the globe in consolidating the sedimentary rocks, and believed that molten material from the earth's interior has been protruded from below into the overlying crust. Some of the material thus injected could be recognized, he thought, in granite and in the various dark massive rocks which, known in Scotland under the name of "whinstone," were afterwards called "Trap," and are now grouped under various names, such as basalt, dolerite and diorite. So important a share did Hutton thus assign to the internal heat in the geological evolution of the planet, that he and those who adopted

the same opinions were styled "Plutonists," or, especially where they concerned themselves with the volcanic origin of basalt, "Vulcanists." The geological world was thus divided into two hostile camps, that of the Neptunists or Wernerians, and that of the Plutonists, Vulcanists or Huttonians.

After many years of futile controversy the first serious weakening of the position of the dominant Neptunist school arose from the defection of some of the most prominent of Werner's pupils. In particular Jean François D'Aubuisson de Voisins (1760-1819), who had written a treatise on the aqueous origin of the basalts of Saxony, went afterwards to Auvergne, where he was speedily a convert to the views expounded by Desmarest as to the volcanic nature of basalt. Having thus to relinquish one of the fundamental articles of the Freiberg faith, he was subsequently led to modify his adherence to others until, as he himself confessed, his views came almost wholly to agree with those of Hutton. Not less complete, and even more important, was the conversion of the great Leopold von Buch (1774-1853). He, too, was trained by Werner himself, and proved to be the most illustrious pupil of the Saxon professor. Full of admiration for the Neptunism in which he had been reared, he, in his earliest separate work, maintained the aqueous origin of basalt, and contrasted the wide field opened up to the spirit of observation by his master's teaching with the narrower outlook offered by "the volcanic theory." But a little further acquaintance with the facts of nature led Von Buch also to abandon his earlier prepossessions. It was a personal visit to the volcanic region of Auvergne that first opened his eyes, and led him to recant what he had believed and written about basalt. But the abandonment of so essential a portion of the Wernerian creed prepared the way for further relinquishments. When a few years later he went to Norway and found to his astonishment that granite, which he had been taught to regard as the oldest chemical precipitate from the universal ocean, could there be seen to have broken through and metamorphosed fossiliferous limestones, and to have sent veins into them, his faith in Werner's order of the succession of the rocks in the earth's crust received a further momentous shock. While one after another of the Freiberg doctrines crumbled away before him, he was now able to interrogate nature on a wider field than the narrow limits of Saxony, and he was thus gradually led to embrace the tenets of the opposite school. His commanding position, as the most accomplished geologist on the continent, gave great importance to his recantation of the Neptunist creed. His defection indeed was the severest blow that this creed had yet sustained. It may be said to have rung the knell of Wernerianism, which thereafter rapidly declined in influence, while Plutonism came steadily to the front, where it has ever since remained.

Although Desmarest had traced in Auvergne a long succession of volcanic eruptions, of which the oldest went back to a remote period of time, and although he had shown that this succession, coupled with the records of contemporaneous denudation, might be used in defining epochs of geological history, it was not until many years after his day that volcanic action came to be recognized as a normal part of the mechanism of our globe, which had been in operation from the remotest past, and which had left numerous records among the rocks of the terrestrial crust. During the progress of the controversy between the two great opposing factions in the later portion of the 18th and the first three decades of the 19th century, those who espoused the Vulcanist cause were intent on proving that certain rocks, which are intercalated among the stratified formations and which were claimed by the Neptunists as obviously formed by water, are nevertheless truly igneous origin. These observers fixed their eyes on the evidence that the material of such rocks, instead of having been deposited from aqueous solution, had once been actually molten, and had in that condition been thrust between the strata, had enveloped portions of them, and had intruded or otherwise altered them. They spoke of these masses as "unrupted lavas," and undoubtedly in innumerable instances were right. But their zeal to establish an intrusive origin led them to overlook the proofs that some intercalated sheets of igneous material had not been injected into the strata, but had been poured out at the surface as truly volcanic discharges, and therefore belonged to the ancient periods represented by the strata between which they are interposed. It may readily be supposed that any proofs of the contemporaneous intercalation of such sheets would be eagerly seized upon by the Neptunists in favour of their aqueous theory. The influence of the ancient belief that "burning mountains" could only rise from the combustion of subterranean inflammable materials extended even into the ranks of the Vulcanists, so far at least as to lead to a general acquiescence in the assumption that volcanoes appeared to belong to a late phase in the history of the planet. It was not until after considerable progress had been made in determining the palaeontological distinctions and order of succession of the stratified formations of the earth's crust that it became possible to trace among these formations a succession of volcanic episodes which were contemporaneous with them. In no part of the world has an ampler record of such episodes been preserved than in the British Isles. It was natural, therefore, that the subject should there receive most attention. As far back as 1820 Ami Boué (1794-1881) showed that the Old Red Sandstone of Scotland includes a great series of volcanic rocks, and that other rocks of volcanic origin are associated with the Carboniferous formations. H. T.

de la Beche (1796-1855) afterwards traced proof of contemporaneous eruptions among the Devonian rocks of the south-west of England. Adam Sedgwick (1785-1873) showed, first in the Lake District, and afterwards in North Wales, the presence of abundant volcanic sheets among the oldest divisions of the Palaeozoic series; while Roderick Impey Murchison (1792-1871) made similar discoveries among the Lower Silurian rocks. From the time of these pioneers the volcanic history of the country has been worked out by many observers until it is now known with a fulness as yet unattained in any other region.

Growth of Opinion regarding Earthquakes.—We have seen how crude were the conceptions of the ancients regarding the causes of volcanic action, and that they connected volcanoes and earthquakes as results of the commotion of wind imprisoned within subterranean caverns and passages. One of the earliest treatises, in which the phenomena of terrestrial movements were discussed in the spirit of modern science, was the posthumous collection of papers by Robert Hooke (1635-1703), entitled *Lectures and Discoveries of Earthquakes and Subterranean Eruptions*, where the probable agency of earthquakes in upheaving and depressing land is fully considered, but without any definite pronouncement as to the author's conception of its origin. Hooke still associated earthquakes with volcanic action, and connected both with what he called "the general congregation of sulphurous subterranean vapours." He conceived that some kind of "fermentation" takes place within the earth, and that the materials which catch fire and give rise to eruptions or earthquakes are analogous to those that constitute gunpowder. The first essay wherein earthquakes are treated from the modern point of view as the results of a shock that sends waves through the crust of the earth was written by the Rev. John Michell, and communicated to the Royal Society in the year 1760. Still under the old misconception that volcanoes are due to the combustion of inflammable materials, which he thought might be set on fire by the spontaneous combustion of pyritous strata, he supposed that, by the sudden access of large bodies of water to these subterranean fires, vapour is produced in such quantity and with such force as to give rise to the shock. From the centre of origin of this shock waves, he thought, are propagated through the earth, which are largest at the start and gradually diminish as they travel outward. By drawing lines at different places in the direction of the track of these waves, he believed that the place of common intersection of these lines would be nearly the centre of the disturbance. In this way he showed that the great Lisbon earthquake of 1755 had its focus under the Atlantic, somewhere between the latitudes of Lisbon and Oporto, and he estimated that the depth at which it originated could not be much less than 1 m., and probably did not exceed 3 m. Michell, however, misconceived the character of the waves which he described, seeing that he believed them to be due to the actual propagation of the vapour itself underneath the surface of the earth. A century had almost passed after the date of his essay before modern scientific methods of observation and the use of recording instruments began to be applied to the study of earthquake phenomena. In 1846 Robert Mallet (1810-1881) published an important paper "On the Dynamics of Earthquakes" in the *Transactions of the Royal Irish Academy*. From that time onward he continued to devote his energies to the investigation, studying the effects of the Calabrian earthquake of 1857, experimenting on the transmission of waves of shock through various materials, caused by exploding charges of gunpowder, and collecting all the information to be obtained on the subject. His writings, and especially his work in two volumes on *The First Principles of Observational Seismology*, must be regarded as having laid the foundations of this branch of modern geology (see EARTHQUAKE; SEISMOLOGY).

History of the Evolution of Stratigraphical Geology.—Men had long been familiar with the evidence that the present dry land once lay under the sea, before they began to realize that the rocks, of which the land consists, contain a record of many alternations of land and sea, and relics of a long succession of plants and animals from early and simple types up to the manifold and complex forms of to-day. In countries where coal-mining had been prosecuted for generations, it had been recognized that the rocks consist of strata superposed on each other in a definite order, which was found to extend over the whole of a district. As far back as 1719 John Strachey drew attention to this fact in a communication published in the *Philosophical Transactions*. John Michell (1760), in the paper on earthquakes already cited, showed that he had acquired a clear understanding of the order of succession among stratified formations, and perceived that to disturbances of the terrestrial crust must be ascribed the fact that the lower or older and more inclined strata form the mountains, while the younger and more horizontal strata are spread over the plains.

In Italy G. Arduino (1713-1795) classified the rocks in the north of the peninsula as Primitive, Secondary, Tertiary and Volcanic. A similar threefold order was announced for the Harz and Erzgebirge by J. G. Lehmann in 1756. He recognized in that region an ancient series of rocks in inclined or vertical strata, which rise to the tops of the hills and descend to an unknown depth into the interior. These masses, he thought, were contemporaneous with the making of the world. Next came the Flitzgebirge, consisting of younger sediments, disposed in flat or gently inclined sheets which overlaid

the first and more disturbed series, and are full of petrified remains of plants and animals. Lastly he included the mountains which have from time to time been formed by local accidents. Still more advanced were the conceptions of G. C. Fuchs, who in the year 1762 published in Latin *A History of the Earth and the Sea, based on a History of the Mountains of Thuringia*; and in 1773, in German, *A Sketch of the most Ancient History of the Earth and Man*. In these works he described the stratigraphical relations and general characters of the various geological formations in his little principality; and taking them as indicative of a general order of succession, he traced what he believed to have been a series of revolutions through which the earth has passed. In interpreting this geological history, he laid great stress on the evidence of the fossils contained in the rocks. He recognized that the various formations differ from each other in their enclosed organic remains, and that from these differences the existence of former sea-bottoms and land surfaces can be determined.

The labours of these pioneers paved the way for the advent of Werner. Though the system evolved by this teacher claimed to discard theory and to be established on a basis of observed facts, it rested on a succession of hypotheses, for which no better foundation could be shown than the belief of their author in their validity. Starting from the extremely limited stratigraphical range displayed in the geological structure of Saxony, he took it as a type for the rest of the globe, persuading himself and impressing upon his followers that the rocks of that small kingdom were to be taken as examples of his "universal formations." The oldest portion of the series, classed by him as "Primitive," consisted of rocks which he maintained had been deposited from chemical solution. Yet they included granite, gneiss, basalt, porphyry and serpentine, which, even in his own day, were by many observers correctly regarded as of igneous origin. A later group of rocks, to which he gave the name of "Transition," comprised, in his belief, partly chemical, partly mechanical sediments, and contained the earliest fossil organic remains. A third group, for which he reserved Lehmann's name "Flötz," was made up chiefly of mechanical detritus, while youngest of all came the "Alluvial" series of loams, clays, sands, gravels and peat. It was by the gradual subsidence of the ocean that, as he believed, the general mass of the dry land emerged, the first-formed rocks being left standing up, sometimes on end, to form the mountains, while those of later date, less steeply inclined, occupied successively lower levels down to the flat alluvial accumulations of the plains. Neither Werner, nor any of his followers, ventured to account for what became of the water as the sea-level subsided, though, in despite of their antipathy to anything like speculation, they could not help suggesting, as an answer to the cogent arguments of their opponents, that "one of the celestial bodies which sometimes approach near to the earth may have been able to withdraw a portion of our atmosphere and of our ocean." Nor was any attempt made to explain the extraordinary nature of the supposed chemical precipitates of the universal ocean. The progress of inquiry even in Werner's lifetime disproved some of the fundamental portions of his system. Many of the chemical precipitates were shown to be masses that had been erupted in a molten state from below. His order of succession was found not to hold good; and though he tried to readjust his sequence and to introduce into it modifications to suit new facts, its inherent artificiality led to its speedy decline after his death. It must be conceded, however, that the stress which he laid upon the fact that the rocks of the earth's crust were deposited in a definite order, had an important influence in directing attention to this subject, and in preparing the way for a more natural system, based not on mere mineralogical characters, but having regard to the organic remains, which were now being gathered in ever-increasing numbers and variety from stratified formations of many different ages and from all parts of the globe.

It was in France and in England that the foundations of stratigraphy, based upon a knowledge of organic remains, were first successfully laid. Abbé J. L. Giraud-Soulavie (1752-1813), in his *Histoire naturelle de la France méridionale*, which appeared in seven volumes, subdivided the limestones of Vivarais into five ages, each marked by a distinct assemblage of shells. In the lowest strata, representing the first age, none of the fossils were believed by him to have any living representatives, and he called these rocks "Primordial." In the next group a mingling of living with extinct forms was observable. The third age was marked by the presence of shells of still existing species. The strata of the fourth series were characterized by carbonaceous shales or slates, containing remains of primordial vegetation, and perhaps equivalents of the first three calcareous series. The fifth age was marked by recent deposits containing remains of terrestrial vegetation and of land animals. It is remarkable that these sagacious conclusions should have been formed and published at a time when the geologists of the Continent were engaged in the controversy about the origin of basalt, or in disputes about the character and stratigraphical position of the supposed universal formations, and when the interest and importance of fossil organic remains still remained unrecognized by the vast majority of the combatants.

The rocks of the Paris basin display so clearly an orderly arrangement, and are so distinguished for the variety and order

preservation of their enclosed organic remains, that they could not fail to attract the early notice of observers. J. E. Guettard, G. F. Rouelle (1703-1770), N. Desmarest, A. L. Lavoisier (1743-1794) and others made observations in this interesting district. But it was reserved for Cuvier (1769-1832) and A. Brongniart (1770-1847) to work out the detailed succession of the Tertiary formations, and to show how each of these is characterized by its own peculiar assemblage of organic remains. The later progress of investigation has slightly corrected and greatly amplified the tabular arrangement established by these authors in 1808, but the broad outlines of the Tertiary stratigraphy of the Paris basin remain still as Cuvier and Brongniart left them. The most important subsequent change in the classification of the Tertiary formations was made by Sir Charles Lyell, who, conceiving in 1828 the idea of a classification of these rocks by reference to their relative proportions of living and extinct species of shells, established, in collaboration with G. P. Deshayes, the now universally accepted divisions Eocene, Miocene and Pliocene.

Long before Cuvier and Brongniart published an account of their researches, another observer had been at work among the Secondary formations of the west of England, and had independently discovered that the component members of these formations were each distinguished by a peculiar group of organic remains; and that this distinction could be used to discriminate them over all the region through which he had traced them. The remarkable man who arrived at this far-reaching generalization was William Smith (1769-1839), a land surveyor who, in the prosecution of his professional business, found opportunities of traversing a great part of England, and of putting his deductions to the test. As the result of these journeys he accumulated materials enough to enable him to produce a geological map of the country, on which the distribution and succession of the rocks were for the first time delineated. Smith's labours laid the foundation of stratigraphical geology in England and he was styled even in his lifetime the "Father of English geology." From his day onward the significance of fossil organic remains gained rapidly increasing recognition. Thus in England the outlines traced by him among the Secondary and Tertiary formations were admirably filled in by Thomas Webster (1773-1844); while the Cretaceous series was worked out in still greater detail in the classic memoirs of William Henry Fitton (1780-1861).

There was one stratigraphical domain, however, into which William Smith did not enter. He traced his sequence of rocks down into the Coal Measures, but contented himself with only a vague reference to what lay underneath that formation. Though some of these underlying rocks had in various countries yielded abundant fossils, they had generally suffered so much from terrestrial disturbances, and their order of succession was consequently often so much obscured throughout western Europe, that they remained but little known for many years after the stratigraphy of the Secondary and Tertiary series had been established. At last in 1831 Murchison began to attack this *terra incognita* on the borders of South Wales, working into it from the Old Red Sandstone, the stratigraphical position of which was well known. In a few years he succeeded in demonstrating the existence of a succession of formations, each distinguished by its own peculiar assemblage of organic remains which were distinct from those in any of the overlying strata. To these formations he gave the name of Silurian (*q.v.*). From the key which his researches supplied, it was possible to recognize in other countries the same order of formations and the same sequence of fossils, so that, in the course of a few years, representatives of the Silurian system were found far and wide over the globe. While Murchison was thus engaged, Sedgwick devoted himself to the more difficult task of unravelling the complicated structure of North Wales. He eventually made out the order of the several formations there, with their vast intercalations of volcanic material. He named them the Cambrian system (*q.v.*), and found them to contain fossils, which, however, lay for some time unexamined by him. He at first believed, as Murchison also did, that his rocks were all older than any part of the Silurian series. It was eventually discovered that a portion of them was equivalent to the lower part of that series. The oldest of Sedgwick's groups, containing distinctive fossils, retain the name Cambrian, and are of high interest, as they enclose the remains of the earliest faunas which are yet well known. Sedgwick and Murchison rendered yet another signal service to stratigraphical geology by establishing, in 1839, on a basis of palaeontological evidence supplied by W. Lonsdale, the independence of the Devonian system (*q.v.*).

For many years the rocks below the oldest fossiliferous deposits received comparatively little attention. They were vaguely described as the "crystalline schists" and were often referred to as parts of the primeval crust in which no chronology was to be looked for. W. E. Logan (1798-1875) led the way, in Canada, by establishing there several vast series of rocks, partly of crystalline schists and gneisses (Laurentian) and partly of slates and conglomerates (Huronian). Later observers, both in Canada and the United States, have greatly increased our knowledge of these rocks, and have shown their structure to be much more complex than was at first supposed (see ARCHEAN SYSTEM).

During the latter half of the 19th century the most important development of stratigraphical geology was the detailed working

out and application of the principle of zonal classification to the fossiliferous formations—that is, the determination of the sequence and distribution of organic remains in these formations, and the arrangement of the strata into zones, each of which is distinguished by a peculiar assemblage of fossil species (see under Part VI.). The zones are usually named after one especially characteristic species. This system of classification was begun in Germany with reference to the members of the Jurassic system (*q.v.*) by A. Oppel (1856-1858) and F. A. von Quenstedt (1858), and it has since been extended through the other Mesozoic formations. It has even been found to be applicable to the Palaeozoic rocks, which are now subdivided into palaeontological zones. In the Silurian system, for example, the graptolites have been shown by C. Lapworth to furnish a useful basis for zonal subdivisions. The lowest fossiliferous horizon in the Cambrian rocks of Europe and North America is known as the *Olenellus* zone, from the prominence in it of that genus of trilobite.

Another conspicuous feature in the progress of stratigraphy during the second half of the 19th century was displayed by the rise and rapid development of what is known as Glacial geology. The various deposits of "drift" spread over northern Europe, and the boulders scattered across the surface of the plains had long attracted notice, and had even found a place in popular legend and superstition. When men began to examine them with a view to ascertain their origin, they were naturally regarded as evidences of the Noachian deluge. The first observer who drew attention to the smoothed and striated surfaces of rock that underlie the Drifts was Hutton's friend, Sir James Hall, who studied them in the lowlands of Scotland and referred them to the action of great detached blocks of water, which, in the course of some ancient terrestrial convulsion, had been launched across the face of the country. Playfair, however, pointed out that the most potent geological agents for the transportation of large blocks of stone are the glaciers. But no one was then bold enough to connect the travelled boulders with glaciers on the plains of Germany and of Britain. Yet the transporting agency of ice was invoked in explanation of their diffusion. It came to be the prevalent belief among the geologists of the first half of the 19th century, that the fall of temperature, indicated by the gradual increase in the number of northern species of shells in the English Crag deposits, reached its climax during the time of the Drift, and that much of the north and centre of Europe was then submerged beneath a sea, across which floating icebergs and floes transported the materials of the Drift and dropped the scattered boulders. As the phenomena are well developed around the Alps, it was necessary to suppose that the submergence involved the lowlands of the Continent up to the foot of that mountain chain—a geographical change so stupendous as to demand much more evidence than was adduced in its support. At last Louis Agassiz (1807-1873), who had varied his palaeontological studies at Neuchâtel by excursions into the Alps, was so much struck by the proofs of the former far greater extension of the Swiss glaciers, that he pursued the investigation and satisfied himself that the ice had formerly extended from the Alpine valleys right across the great plain of Switzerland, and had transported huge boulders from the central mountains to the flanks of the Jura. In the year 1840 he visited Britain and soon found evidence of similar conditions there. He showed that it was not by submergence in a sea cumbered with floating ice, but by the former presence of vast glaciers or sheets of ice that the Drift and erratic blocks had been distributed. The idea thus propounded by him did not at once command complete approval, though traces of ancient glaciers in Scotland and Wales were soon detected by native geologists, particularly by W. Buckland, Lyell, J. D. Forbes and Charles Maclaren. Robert Chambers (1802-1871) did good service in gathering additional evidence from Scotland and Norway in favour of Agassiz's views, which steadily gained adherents until, after some quarter of a century, they were adopted by the great majority of geologists in Britain, and subsequently in other countries. Since that time the literature of geology has been swollen by a vast number of contributions in which the history of the Glacial period, and its records both in the Old and New World, have been fully discussed.

Rise and Progress of Palaeontological Geology.—As this branch of the science deals with the evidence furnished by fossil organic remains as to former geographical conditions, it early attracted observers who, in the superficial beds of marine shells found at some distance from the coast, saw proofs of the former submergence of the land under the sea. But the occurrence of fossils embedded in the heart of the solid rocks of the mountains offered much greater difficulties of explanation, and further progress was consequently slow. Especially baneful was the belief that these objects were mere sports of nature, and had no connexion with any once living organisms. So long as the true organic origin of the fossil plants and animals contained in the rocks was in dispute, it was hardly possible that much advance could be made in their systematic study, or in the geological deductions to be drawn from them. One good result of the controversy, however, was to be seen in the large collections of these "formed stones" that were gathered together in the cabinets and museums of the 17th and 18th centuries. The accumulation and comparison of these objects naturally led to the production of treatises in which they were described and not infrequently illustrated by good engravings. Switzerland was more particularly

noted for the number and merit of its works of this kind, such as that of K. N. Lang (*Historia lapidum figuratorum Helvetiae*, 1708) and those of Johann Jacob Scheuchzer (1672-1733). In England, also, illustrated treatises were published both by men who looked on fossils as mere freaks of nature, and by those who regarded them as proofs of Noah's flood. Of the former type were the works of Martin Lister (1638-1712) and Robert Plot (*Natural History of Oxfordshire*, 1677). The Celtic scholar Edward Lhwyd (1660-1709) wrote a Latin treatise containing good plates of a thousand fossils in the Ashmolean Museum, Oxford, and J. Woodward, in 1728-1729, published his *Natural History of the Fossils of England*, already mentioned, wherein he described his own extensive collection, which he bequeathed to the University of Cambridge, where it is still carefully preserved. The most voluminous and important of all these works, however, appeared at a later date at Nuremberg. It was begun by G. W. Knorr (1705-1761), who himself engraved for it a series of plates, which for beauty and accuracy have seldom been surpassed. After his death the work was continued by J. E. I. Walch (1725-1778), and ultimately consisted of four massive folio volumes and nearly 300 plates under the title of *Lapides diluvii universalis testes*. Although the authors supposed their fossils to be relics of Noah's flood, their work must be acknowledged to mark a distinct onward stage in the palaeontological department of geology.

It was in France that palaeontological geology began to be cultivated in a scientific spirit. The potter Bernard Palissy, as far back as 1580, had dwelt on the importance of fossil shells as monuments of revolutions of the earth's surface; but the observer who first undertook the detailed study of the subject was Jean Etienne Guettard, who began in 1751 to publish his descriptions of fossils in the form of memoirs presented to the Academy of Sciences of Paris. To him they were not only of deep interest as monuments of former types of existence, but they had an especial value as records of the changes which the country had undergone from sea to land and from land to sea. More especially noteworthy was a monograph by him which appeared in 1765 bearing the title "On the accidents that have befallen Fossil Shells compared with those which are found to happen to shells now living in the Sea." In this treatise he showed that the fossils have been encrusted with barnacles and serpulæ, have been bored into by other organisms, and have often been rounded or broken before final entombment; and he inferred that these fossils must have lived and died on the sea-floor under similar conditions to those which obtain on the sea-floor to-day. His argument was the most triumphant that had ever been brought against the doctrine of *lusus naturee*, and that of the efficacy of Noah's flood—doctrines which still held their ground in Guettard's day. When Soulvie, Cuvier and Brongniart in France, and William Smith in England, showed that the rock formations of the earth's crust could be arranged in chronological order, and could be recognized far and wide by means of their enclosed organic remains, the vast significance of these remains in geological research was speedily realized, and palaeontological geology at once entered on a new and enlarged phase of development. But apart from their value as chronological monuments, and as witnesses of former conditions of geography, fossils presented in themselves a wide field of investigation as types of life that had formerly existed, but had now passed away. It was in France that this subject first took definite shape as an important branch of science. The mollusca of the Tertiary deposits of the Paris basin became, in the hands of Lamarck, the basis on which invertebrate palaeontology was founded. The same series of strata furnished to Cuvier the remains of extinct land animals, of which, by critical study of their fragmentary bones and skeletons, he worked out restorations that may be looked on as the starting-point of vertebrate palaeontology. These brilliant researches, rousing widespread interest in such studies, showed how great a flood of light could be thrown on the past history of the earth and its inhabitants. But the full significance of these extinct types of life could not be understood so long as the doctrine of the immutability of species, so strenuously upheld by Cuvier, maintained its sway among naturalists. Lamarck, as far back as the year 1800, had begun to propound his theory of evolution and the transformation of species; but his views, strongly opposed by Cuvier and the great body of naturalists of the day, fell into neglect. Not until after the publication in 1859 of the *Origin of Species* by Charles Darwin were the barriers of old prejudice in this matter finally broken down. The possibility of tracing the ancestry of living forms back into the remotest ages was then perceived; the time-honoured fiction that the stratified formations record a series of catastrophes and re-creations was finally dissipated; and the earth's crust was seen to contain a noble, though imperfect, record of the grand evolution of organic types of which our planet has been the theatre.

Development of Petrographical Geology.—Theophrastus, the favourite pupil of Aristotle, wrote a treatise *On Stones*, which has come down to our own day, and may be regarded as the earliest work on petrography. At a subsequent period Pliny, in his *Natural History*, collected all that was known in his day regarding the occurrence and uses of minerals and rocks. But neither of these works is of great scientific importance, though containing much interesting information. Minerals from their beauty and value attracted notice before much attention was paid to rocks, and their study gave rise to the science of mineralogy long before geology came

into existence. When rocks began to be more particularly scrutinized, it was chiefly from the side of their usefulness for building and other economic purposes. The occurrence of marine shells in many of them had early attracted attention to them. But their varieties of composition and origin did not become the subject of serious study until after Linnæus and J. G. Wallerius in the 18th century had made a beginning. The first important contribution to this department of the science was that of Werner, who in 1786 published a classification and description of rocks in which he arranged them in two divisions, simple and compound, and further distinguished them by various external characters and by their relative age. The publication of this scheme may be said to mark the beginning of scientific petrography. Werner's system, however, had the serious defect that the chronological order in which he grouped the rocks, and the hypothesis by which he accounted for them as chemical precipitates from the original ocean, were both alike contrary to nature. It was hardly possible indeed that much progress could be made in this branch of geology until chemistry and mineralogy had made greater advances; and especially until it was possible to ascertain the intimate chemical and mineralogical composition, and the minute structure of rocks. The study, however, continued to be pursued in Germany, where the influence of Werner's enthusiasm still led men to enter the petrographical rather than the palaeontological domain. The resources of modern chemistry were pressed into the service, and analyses were made and multiplied to such a degree that it seemed as if the ultimate chemical constitution of every type of rock had now been thoroughly revealed. The condition of the science in the middle of the 19th century was well shown by J. L. A. Roth, who in 1861 collected about 1000 trustworthy analyses which up to that time had been made. But though the chemical elements of the rocks had been fairly well determined, the manner in which they were combined in the compound rocks could for the most part be only more or less plausibly conjectured. As far back as 1831 an account was published of a process devised by William Nicol of Edinburgh, whereby sections of fossil wood could be cut, mounted on glass, and reduced to such a degree of transparency as to be easily examined under a microscope. Henry Sorby, of Sheffield, having seen Nicol's preparations, perceived how admirably adapted the process was for the study of the minute structure and composition of rocks. In 1858 he published in the *Quarterly Journal of the Geological Society* a paper "On the Microscopical Structure of Crystals." This essay led to a complete revolution of petrographical methods and gave a vast impetus to the study of rocks. Petrology entered upon a new and wider field of investigation. Not only were the mineralogical constituents of the rocks detected, but minute structures were revealed which shed new light on the origin and history of these mineral masses, and opened up new paths in theoretical geology. In the hands of H. Vogelsang, F. Zirkel, H. Rosenbusch, and a host of other workers in all civilized countries, the literature of this department of the science has grown to a remarkable extent. Armed with the powerful aid of modern optical instruments, geologists are now able with far more prospect of success to resume the experiments begun a century before by de Saussure and Hall. G. A. Daubrée, C. Friedel, E. Sarasin, F. Fouqué and A. Michel Lévy in France, C. Doelter y Cisterich and E. Hussak of Graz, J. Morozewicz of Warsaw and others, have greatly advanced our knowledge by their synthetical analyses, and there is every reason to hope that further advances will be made in this field of research.

Rise of Physiographical Geology.—Until stratigraphical geology had advanced so far as to show of what a vast succession of rocks the crust of the earth is built up, by what a long and complicated series of revolutions these rocks have come to assume their present positions, and how enormous has been the lapse of time which all these changes represent, it was not possible to make a scientific study of the surface features of our globe. From ancient times it had been known that many parts of the land had once been under the sea; but down even to the beginning of the 19th century the vaguest conceptions continued to prevail as to the operations concerned in the submergence and elevation of land, and as to the processes whereby the present outlines of terrestrial topography were determined. We have seen, for instance, that according to the teaching of Werner the oldest rocks were first precipitated from solution in the universal ocean to form the mountains, that the vertical position of their strata was original, that as the waters subsided successive formations were deposited and laid bare, and that finally the superfluous portion of the ocean was whisked away into space by some unexplained co-operation of another planetary body. Desmarest, in his investigation of the volcanic history of Auvergne, was the first observer to perceive by what a long process of sculpture the present configuration of the land has been brought about. He showed conclusively that the valleys have been carved out by the streams that flow in them, and that while they have sunk deeper and deeper into the framework of the land, the spaces of ground between them have been left as intervening ridges and hills. De Saussure learnt a similar lesson from his studies of the Alps, and Hutton and Playfair made it a cardinal feature in their theory of the earth. Nevertheless the idea encountered so much opposition that it made but little way until after the middle of the 19th century. Geologists preferred to believe in creations of nature, whereby valleys were opened and mountains were

upheaved. That the main features of the land, such as the great mountain-chains, had been produced by gigantic plication of the terrestrial crust was now generally admitted, and also that minor fractures and folds had probably initiated many of the valleys. But those who realised most vividly the momentous results achieved by ages of subaerial denudation perceived that, as Hutton showed, even without the aid of underground agency, the mere flow of water in streams across a mass of land must in course of time carve out just such a system of valleys as may anywhere be seen. It was J. B. Jukes who, in 1862, first revived the Huttonian doctrine, and showed how completely it explained the drainage-lines in the south of Ireland. Other writers followed in quick succession until, in a few years, the doctrine came to be widely recognized as one of the established principles of modern geology. Much help was derived from the admirable illustrations of land-sculpture and river-erosion supplied from the Western Territories and States of the American Union.

Another branch of physiographical geology which could only come into existence after most of the other departments of the science had made large progress, deals with the evolution of the framework of each country and of the several continents and oceans of the globe. It is now possible, with more or less confidence, to trace backward the history of every terrestrial area, to see how sea and land have there succeeded each other, how rivers and lakes have come and gone, how the crust of the earth has been ridged up at widely separated intervals, each movement determining some line of mountains or plains, how the boundaries of the oceans have shifted again and again in the past, and thus how, after so prolonged a series of revolutions, the present topography of each country, and of the globe as a whole, has been produced. In the prosecution of this subject maps have been constructed to show what is conjectured to have been the distribution of sea and land during the various geological periods in different parts of the world, and thus to indicate the successive stages through which the architecture of the land has been gradually evolved. The most noteworthy contribution to this department of the science is the *Annals der Erde* of Professor Suess of Vienna. This important and suggestive work has been translated into French and English.

PART II.—COSMICAL ASPECTS

Before geology had attained to the position of an inductive science, it was customary to begin investigations into the history of the earth by propounding or adopting some more or less fanciful hypothesis in explanation of the origin of our planet, or even of the universe. Such preliminary notions were looked upon as essential to a right understanding of the manner in which the materials of the globe had been put together. One of the distinguishing features of Hutton's Theory of the Earth consisted in his protest that it is no part of the province of geology to discuss the origin of things. He taught that in the materials from which geological evidence is to be compiled there can be found "no traces of a beginning, no prospect of an end." In England, mainly to the influence of the school which he founded, and to the subsequent rise of the Geological Society of London, which resolved to collect facts instead of fighting over hypotheses, is due the disappearance of the crude and unscientific cosmologies by which the writings of the earlier geologists were distinguished.

But there can now be little doubt that in the reaction against those visionary and often grotesque speculations, geologists were carried too far in an opposite direction. In allowing themselves to believe that geology had nothing to do with questions of cosmogony, they gradually grew up in the conviction that such questions could never be other than mere speculation, interesting or amusing as a theme for the employment of the fancy, but hardly coming within the domain of sober and inductive science. Nor would they soon have been awakened out of this belief by anything in their own science. It is still true that in the data with which they are accustomed to deal, as comprising the sum of geological evidence, there can be found no trace of a beginning, though the evidence furnished by the terrestrial crust shows a general evolution of organic forms from some starting-point which cannot be seen. The oldest rocks which have been discovered on any part of the globe have probably been derived from other rocks older than themselves. Geology by itself has not yet revealed, and is little likely ever to reveal, a trace of the first solid crust of our globe. If, then, geological history is to be compiled from direct evidence furnished by the rocks of the earth, it cannot begin at the

beginning of things, but must be content to date its first chapter from the earliest period of which any record has been preserved among the rocks.

Nevertheless, though geology in its usual restricted sense has been, and must ever be, unable to reveal the earliest history of our planet, it no longer ignores, as mere speculation, what is attempted in this subject by its sister sciences. Astronomy, physics and chemistry have in late years all contributed to cast light on the earlier stages of the earth's existence, previous to the beginning of what is commonly regarded as geological history. But whatever extends our knowledge of the former conditions of our globe may be legitimately claimed as part of the domain of geology. If this branch of inquiry, therefore, is to continue worthy of its name as the science of the earth, it must take cognizance of these recent contributions from other sciences. It must no longer be content to begin its annals with the records of the oldest rocks, but must endeavour to grope its way through the ages which preceded the formation of any rocks. Thanks to the results achieved with the telescope, the spectroscope and the chemical laboratory, the story of these earliest ages of our earth is every year becoming more definite and intelligible.

Up to the present time no definite light has been thrown by physics on the origin and earliest condition of our globe. The famous nebular theory (*q.v.*) of Kant and Laplace sketched the supposed evolution of the solar system from a gaseous nebula, slowly rotating round a more condensed central portion of its mass, which eventually became the sun. As a consequence of increased rapidity of rotation resulting from cooling and contraction, the nebula acquired a more and more lenticular form, until at last it threw off from its equatorial protuberance a ring of matter. Subsequently the same process was repeated, and other similar rings successively separated from the parent mass. Each ring went through a corresponding series of changes until it ultimately became a planet, with or without one or more attendant satellites. The intimate relationship of our earth to the sun and the other planets was, in this way, shown. But there are some serious physical difficulties in the way of the acceptance of the nebular hypothesis. Another explanation is given by the meteoritic hypothesis, according to which, out of the swarms of meteorites with which the regions of space are crowded, the sun and planets have been formed by gradual accretion.

According to these theoretical views we should expect to find a general uniformity of composition in the constituent matter of the solar system. For many years the only available evidence on this point was derived from the meteorites (*q.v.*) which so constantly fall from outer space upon the surface of the earth. These bodies were found to consist of elements all of which had been recognized as entering into the constitution of the earth. But the discoveries of spectroscopic research have made known a far more widely serviceable method of investigation, which can be applied even to the luminous stars and nebulae that lie far beyond the bounds of the solar system. By this method information has been obtained regarding the constitution of the sun, and many of our terrestrial metals, such as iron, nickel and magnesium, have been ascertained to exist in the form of incandescent vapour in the solar atmosphere. The present condition of the sun probably represents one of the phases through which stars and planets pass in their progress towards becoming cool and dark bodies in space. If our globe was at first, like its parent sun, an incandescent mass of probably gaseous matter, occupying much more space than it now fills, we can conceive that it has ever since been cooling and contracting until it has reached its present form and dimensions, and that it still retains a high internal temperature. Its oblately spheroidal form is such as would be assumed by a rotating mass of matter in the transition from a vaporous and self-luminous or liquid condition to one of cool and dark solidity. But it has been claimed that even a solid spherical globe might develop, under the influence of protracted rotation, such a shape as the earth at present possesses.

The observed increase of temperature downwards in our

planet has hitherto been generally accepted as a relic and proof of an original high temperature and mobility of substance. Recently, however, the validity of this proof has been challenged on the ground that the ascertained amount of radium in the rocks of the outer crust is more than sufficient to account for the observed downward increase of temperature. Too little, however, is known of the history and properties of what is called radium to afford a satisfactory ground on which to discard what has been, and still remains, the prevalent belief on this subject.

An important epoch in the geological history of the earth was marked by the separation of the moon from its mass (see TIDE). Whether the severance arose from the rupture of a surrounding ring or the gradual condensation of matter in such a ring, or from the ejection of a single mass of matter from the rapidly rotating planet, it has been shown that our satellite was only a few thousand miles from the earth's surface, since when it has retreated to its present distance of 240,000 m. Hence the influence of the moon's attraction, and all the geological effects to which it gives rise, attained their maximum far back in the development of the globe, and have been slowly diminishing throughout geological history.

The sun by virtue of its vast size has not yet passed out of the condition of glowing gas, and still continues to radiate heat beyond the farthest planet of the solar system. The earth, however, being so small a body in comparison, would cool down much more quickly. Underneath its hot atmosphere a crust would conceivably begin to form over its molten surface, though the interior might still possess a high temperature and, owing to the feeble conducting power of rocks, would remain intensely hot for a protracted series of ages.

Full information regarding the form and size of the earth, and its relations to the other planetary members of the solar system, will be found in the articles PLANET and SOLAR SYSTEM. For the purposes of geological inquiry the reader will bear in mind that the equatorial diameter of our globe is estimated to be about 7925 m., and the polar diameter about 7890 m.; the difference between these two sums representing the amount of flattening at the poles (about 261m.). The planet has been compared in shape to an orange, but it resembles an orange which has been somewhat squeezed, for its equatorial circumference is not a regular circle but an ellipse, of which the major axis lies in long. 8° 15' W.—on a meridian which cuts the north-west corner of America, passing through Portugal and Ireland, and the north-east corner of Asia in the opposite hemisphere.

The rotation of the earth on its axis exerts an important influence on the movements of the atmosphere, and thereby affects the geological operations connected with these movements. The influence of rotation is most marked in the great aerial circulation between the poles and the equator. Currents of air, which set out in a meridional direction from high latitudes towards the equator, come from regions where the velocity due to rotation is small to where it is greater, and they consequently fall behind. Thus, in the northern hemisphere a north wind, as it moves away from its northern source of origin, is gradually deflected more and more towards the west and becomes a north-east current; while in the opposite hemisphere a wind making from high southern latitudes towards the equator becomes, from the same cause, a south-east current. Where, on the other hand, the air moves from the equatorial to the polar regions its higher velocity of rotation carries it eastward, so that on the south side of the equator it becomes a north-west current and on the north side a south-west current. It is to this cause that the easting and westing of the great atmospheric currents are to be attributed, as is familiarly exemplified in the trade winds.

The atmospheric circulation thus deflected influences the circulation of the ocean. The winds which persistently blow from the north-east on the north side of the equator, and from the south-east on the south side, drive the superficial waters onwards, and give rise to converging oceanic currents which unite to form the great westerly equatorial current.

A more direct effect of terrestrial rotation has been claimed

in the case of rivers which flow in a meridional direction. It has been asserted that those, which in the northern hemisphere flow from north to south, like the Volga, by continually passing into regions where the velocity of rotation is increasingly greater, are thrown more against their western than their eastern banks, while those whose general course is in an opposite direction, like the Irtisch and Yenesei, press more upon their eastern sides. There cannot be any doubt that the tendency of the streams must be in the directions indicated. But when the comparatively slow current and constantly meandering course of most rivers are taken into consideration, it may be doubted whether the influence of rotation is of much practical account so far as river-erosion is concerned.

One of the cosmical relations of our planet which has been more especially prominent in geological speculations relates to the position of the earth's axis of rotation. Abundant evidence has now been obtained to prove that at a comparatively late geological period a rich flora, resembling that of warm climates at the present day, existed in high latitudes even within less than 9° of the north pole, where, with an extremely low temperature and darkness lasting for half of the year, no such vegetation could possibly now exist. It has accordingly been maintained by many geologists that the axis of rotation must have shifted, and that when the remarkable Arctic assemblage of fossil plants lived the region of their growth must have lain in latitudes much nearer to the equator of the time.

The possibility of any serious displacement of the rotational axis since a very early period in the earth's history has been strenuously denied by astronomers, and their arguments have been generally, but somewhat reluctantly, accepted by geologists, who find themselves confronted with a problem which has hitherto seemed insoluble. That the axis is not rigidly stable, however, has been postulated by some physicists, and has now been demonstrated by actual observation and measurement. It is admitted that by the movement of large bodies of water the air over the surface of the globe, and more particularly by the accumulation of vast masses of snow and ice in different regions, the position of the axis might be to some extent shifted; more serious effects might follow from widespread upheavals or depressions of the surface of the lithosphere. On the assumption of the extreme rigidity of the earth's interior, however, the general result of mathematical calculation is to negative the supposition that in any of these ways within the period represented by what is known as the "geological record," that is, since the time of the oldest known sedimentary formations, the rotational axis has ever been so seriously displaced as to account for such stupendous geological events as the spread of a luxuriant vegetation far up into polar latitudes. If, however, the inside of the globe possesses a great plasticity than has been allowed, the shifting of the axis might not be impossible, even to such an extent as would satisfy the geological requirements. This question is one on which the last word has not been said, and regarding which judgment must remain in suspense.

In recent years fresh information bearing on the minor deviations of the pole has been obtained from a series of several thousand careful observations made in Europe and North America. It has thus been ascertained that the pole wanders with a curiously irregular but somewhat spiral movement, within an amplitude of between 40 and 50 ft., and completes its erratic circuit in about 428 days. It was not supposed that its movement had any geological interest, but Dr John Milne has recently pointed out that the times of sharpest curvature in the path of the pole coincide with the occurrence of large earthquakes, and has suggested that, although it can hardly be assumed that this coincidence shows any direct connexion between earthquake frequency and changes in the position of the earth's axis, both effects may not improbably arise from the same redistribution of surface material by ocean currents and meteorological causes.

If for any reason the earth's centre of gravity were sensibly displaced, momentous geological changes would necessarily ensue. That the centre of gravity does not coincide with the

centre of figure of the globe, but lies to the south of it, has long been known. This greater aggregation of dense material in the southern hemisphere probably dates from the early ages of the earth's consolidation, and it is difficult to believe that any readjustment of the distribution of this material in the earth's interior is now possible. But certain rearrangements of the hydrosphere on the surface of the globe may, from time to time, cause a shifting of the centre of gravity, which will affect the level of the ocean. The accumulation of enormous masses of ice around the pole will give rise to such a displacement, and will thus increase the body of oceanic water in the glaciated hemisphere. Various calculations have been made of the effect of the transference of the ice-cap from one pole to the other, a revolution which may possibly have occurred more than once in the past history of the globe. James Croll estimated that if the mass of ice in the southern hemisphere be assumed to be 1000 ft. thick down to lat. 60°, its removal to the opposite hemisphere would raise the level of the sea 80 ft. at the north pole, while the Rev. Osmond Fisher made the rise as much as 400 ft. The melting of the ice would still further raise the sea-level by the addition of so large a volume of water to the ocean. To what extent superficial changes of this kind have operated in geological history remains an unsolved problem, but their probable occurrence in the past has to be recognized as one of the factors that must be considered in tracing the revolutions of the earth's surface.

The Age of the Earth.—Intimately connected with the relations of our globe to the sun and the other members of the solar system is the question of the planet's antiquity—a subject of great geological importance, regarding which much discussion has taken place since the middle of the 19th century. Though an account of this discussion necessarily involves allusion to departments of geology which are more appropriately referred to in later parts of this article, it may perhaps be most conveniently included here.

Geologists were for many years in the habit of believing that no limit could be assigned to the antiquity of the planet, and that they were at liberty to make unlimited drafts on the ages of the past. In 1862 and subsequent years, however, Lord Kelvin (then Sir William Thomson) pointed out that these demands were opposed to known physical facts, and that the amount of time required for geological history was not only limited, but must have been comprised within a comparatively narrow compass. His argument rested on three kinds of evidence: (1) the internal heat and rate of cooling of the earth; (2) the tidal retardation of the earth's rotation; and (3) the origin and age of the sun's heat.

1. Applying Fourier's theory of thermal conductivity, Lord Kelvin contended that in the known rate of increase of temperature downward and beneath the surface, and the rate of loss of heat from the earth, we have a limit to the antiquity of the planet. He showed, from the data available at the time, that the superficial consolidation of the globe could not have occurred less than 20 million years ago, or the underground heat would have been greater than it is; nor more than 400 million years ago, otherwise the underground temperature would have shown no sensible increase downwards. He admitted that very wide limits were necessary. In subsequently discussing the subject, he inclined rather towards the lower than the higher antiquity, but concluded that the limit, from a consideration of all the evidence, must be placed within some such period of past time as 100 millions of years.

2. The argument from tidal retardation proceeds on the admitted fact that, owing to the friction of the tide-wave, the rotation of the earth is retarded, and is, therefore, much slower now than it must have been at one time. Lord Kelvin affirmed that had the globe become solid some 10,000 million years ago, or indeed any high antiquity beyond 100 million years, the centrifugal force due to the more rapid rotation must have given the planet a very much greater polar flattening than it actually possesses. He admitted, however, that, though 100 million years ago that force must have been about 3% greater than now,

yet "nothing we know regarding the figure of the earth, and the disposition of land and water, would justify us in saying that a body consolidated when there was more centrifugal force by 3% than now, might not now be in all respects like the earth, so far as we know it at present."

3. The third argument, based upon the age of the sun's heat, is confessedly less to be relied on than the two previous ones. It proceeds upon calculations as to the amount of heat which would be available by the falling together of masses from space, which gave rise by their impact to our sun. The vagueness of the data on which this argument rests may be inferred from the fact that in one passage P. G. Tait placed the limit of time during which the sun has been illuminating the earth as, "on the very highest computation, not more than about 15 or 20 millions of years"; while, in another sentence of the same volume, he admitted that, "by calculations in which there is no possibility of large error, this hypothesis [of the origin of the sun's heat by the falling together of masses of matter] is thoroughly competent to explain 100 millions of years' solar radiation at the present rate, perhaps more." In more recently reviewing his argument, Lord Kelvin expressed himself in favour of more strictly limiting geological time than he had at first been disposed to do. He insists that the time "was more than 20 and less than 40 millions of years and probably much nearer 20 than 40." Geologists appear to have reluctantly brought themselves to believe that perhaps, after all, 100 millions of years might suffice for the evolution of geological history. But when the time was cut down to 15 or 20 millions they protested that such a restricted period was insufficient for that evolution, and though they did not offer any effective criticism of the arguments of the physicists they felt convinced that there must be some flaw in the premises on which these arguments were based.

By degrees, however, there have arisen among the physicists themselves grave doubts as to the validity of the physical evidence on which the limitation of the earth's age has been founded, and at the same time greater appreciation has been shown of the signification and stength of the geological proofs of the high antiquity of our planet. In an address from the chair of the Mathematical Section of the British Association in 1886, Professor (afterwards Sir) George Darwin reviewed the controversy, and pronounced the following deliberate judgment in regard to it: "In considering these three arguments I have adduced some reasons against the validity of the first [tidal friction], and have endeavoured to show that there are elements of uncertainty surrounding the second [secular cooling of the earth]; nevertheless, they undoubtedly constitute a contribution of the first importance to physical geology. Whilst, then, we may protest against the precision with which Professor Tait seeks to deduce results from them, we are fully justified in following Sir William Thomson, who says that 'the existing state of things on the earth, life on the earth—all geological history showing continuity of life—must be limited within some such period of past time as 100 million years.'" Lord Kelvin has never dealt with the geological and palaeontological objections against the limitation of geological time to a few millions of years. But Professor Darwin, in the address just cited, uttered the memorable warning: "At present our knowledge of a definite limit to geological time has so little precision that we should do wrong summarily to reject theories which appear to demand longer periods of time than those which now appear allowable." In his presidential address to the British Association at Cape Town in 1905 he returned to the subject, remarking that the argument derived from the increase of underground temperature "seems to be entirely destroyed" by the discovery of the properties of radium. He thinks that "it does not seem extravagant to suppose that 500 to 1000 million years may have elapsed since the birth of the moon." He has "always believed that the geologists were more nearly correct than the physicists, notwithstanding the fact that appearances were so strongly against them," and he concludes thus: "It appears, then, that the physical argument is not susceptible of a greater degree of

certainty than that of the geologists, and the scale of geological time remains in great measure unknown" (see also *TIDE*, chap. viii.).

In an address to the mathematical section of the American Association for the Advancement of Science in 1889, the vice-president of the section, R. S. Woodward, thus expressed himself with regard to the physical arguments brought forward by Lord Kelvin and Professor Tait in limitation of geological time: "Having been at some pains to look into this matter, I feel bound to state that, although the hypothesis appears to be the best which can be formulated at present, the odds are against its correctness. Its weak links are the unverified assumptions of an initial uniform temperature and a constant diffusivity. Very likely these are approximations, but of what order we cannot decide. Furthermore, if we accept the hypothesis, the odds appear to be against the present attainment of trustworthy numerical results, since the data for calculation, obtained mostly from observations on continental areas, are far too meagre to give satisfactory average values for the entire mass of the earth."

Still more emphatic is the protest made from the physical side by Professor John Perry. He has attacked each of the three lines of argument of Lord Kelvin, and has impugned the validity of the conclusions drawn from them. The argument from tidal retardation he dismisses as fallacious, following in this contention the previous criticism of the Rev. Maxwell Close and Sir George Darwin. In dealing with the argument based on the secular cooling of the earth, he holds it to be perfectly allowable to assume a much higher conductivity for the interior of the globe, and that such a reasonable assumption would enable us greatly to increase our estimate of the earth's antiquity. As for the third argument, from the age of the sun's heat, he points out that the sun may have been repeatedly fed by a supply of meteorites from outside, while the earth may have been protected from radiation, and been able to retain much of its heat by being enveloped in a dense atmosphere. Remarking that "almost anything is possible as to the present internal state of the earth," he concludes thus: "To sum up, we can find no published record of any lower maximum age of life on the earth, as calculated by physicists, than 400 millions of years. From the three physical arguments Lord Kelvin's higher limits are 1000, 400 and 500 million years. I have shown that we have reasons for believing that the age, from all these, may be very considerably underestimated. It is to be observed that if we exclude everything but the arguments from mere physics, the probable age of life on the earth is much less than any of the above estimates; but if the palaeontologists have good reasons for demanding much greater times, I see nothing from the physicists' point of view which denies them four times the greatest of these estimates."

A fresh line of argument against Lord Kelvin's limitation of the antiquity of our globe has recently been started by the remarkable discoveries in radio-activity. From the ascertained properties of radium it appears to be possible that our estimates of solar heat, as derived from the theory of gravitation, may have to be augmented ten or twenty times; that stores of radium and similar bodies within the earth may have indefinitely deferred the establishment of the present temperature gradient from the surface inward; that consequently the earth may have remained for long ages at a temperature not greatly different from that which it now possesses, and hence that the times during which our globe has supported animal and vegetable life may be very much longer than that allowed in the estimates previously made by physicists from other data (see *RADIO-ACTIVITY*).

The arguments from the geological side against the physical contention that would limit the age of our globe to some 10 or 20 millions of years are mainly based on the observed rates of geological and biological changes at the present time upon land and sea, and on the nature, physical history and organic contents of the stratified crust of the earth. Unfortunately, actual numerical data are not obtainable in many departments of

geological activity, and even where they can be procured they do not yet rest on a sufficiently wide collection of accurate and co-ordinated observations. But in some branches of dynamical geology, material exists for, at least, a preliminary computation of the rate of change. This is more especially the case in respect of the wide domain of denudation. The observational records of the action of the sea, of springs, rivers and glaciers are becoming gradually fuller and more trustworthy. A method of making use of these records for estimating the rate of denudation of the land has been devised. Taking the Mississippi as a general type of river action, it has been shown that the amount of material conveyed by this stream into the sea in one year is equivalent to the lowering of the general surface of the drainage basin of the river by $\frac{1}{1000}$ of a foot. This would amount to one foot in 6000 years and 1000 ft. in 6 million years. So that at the present rate of waste in the Mississippi basin a whole continent might be worn away in a few millions of years.

It is evident that as deposition and denudation are simultaneous processes, the ascertainment of the rate at which solid material is removed from the surface of the land supplies some necessary information for estimating the rate at which new sedimentary formations are being accumulated on the floor of the sea, and for a computation of the length of time that would be required at the present rate of change for the deposition of all the stratified rocks that enter into the composition of the crust of our globe. If the thickness of these rocks be assumed to be 100,000 ft., and if we could suppose them to have been laid down over as wide an area as that of the drainage basins from the waste of which they were derived, then at the present rate of denudation their accumulation would require some 600 millions of years. But, as Dr A. R. Wallace has justly pointed out, the tract of sea-floor over which the material derived from the waste of the terrestrial surface is laid down is at present much less than that from which this material is worn away. We have no means, however, of determining what may have been the ratio between the two areas in past time. Certainly ancient marine sedimentary rocks cover at the present day a much more extensive area than that in which they are now being elaborated. If we take the ratio postulated by Dr Wallace—1 to 10—the 100,000 ft. of sedimentary strata would require 31 millions of years for their accumulation. It is quite possible, however, that this ratio may be much too high. There are reasons for believing that the proportion of coast-line to land area has been diminishing during geological time; in other words, that in early times the land was more insular and is now more continental. So that the 31 millions of years may be much less than the period that would be required, even on the supposition of continuous uninterrupted denudation and sedimentation, during the whole of the time represented by the stratified formations.

But no one who has made himself familiar with the actual composition of these formations and the detailed structure of the terrestrial crust can fail to recognize how vague, imperfect and misleading are the data on which such computations are founded. It requires no prolonged acquaintance with the earth's crust to impress upon the mind that one all-important element is omitted, and indeed can hardly be allowed for from want of sufficiently precise data, but the neglect of which must needs seriously impair the value of all numerical calculations made without it. The assumption that the stratified formations can be treated as if they consisted of a continuous unbroken sequence of sediments, indicating a vast and uninterrupted process of waste and deposition, is one that is belied on every hand by the actual structure of these formations. It can only give us a minimum of the time required; for, instead of an unbroken series, the sedimentary formations are full of "unconformabilities"—gaps in the sequence of the chronological records—as if whole chapters and groups of chapters had been torn out of a historical work. It can often be shown that these breaks of continuity must have been of vast duration, and actually exceeded in chronological importance thick groups of strata lying below and above them (see Part VI.). Moreover, even among the uninterrupted strata, where no such unconformabilities exist, but where the sediments

follow each other in apparently uninterrupted sequence, and might be thought to have been deposited continuously at the same general rate, and without the intervention of any pause; it can be demonstrated that sometimes an inch or two of sediment much, on certain horizons, represent the deposit of an enormously longer period than a hundred or a thousand times the same amount of sediment on other horizons. A prolonged study of these questions leads to a profound conviction that in many parts of the geological record the time represented by sedimentary deposits may be vastly less than the time which is not so represented.

It has often been objected that the present rate of geological change ought not to be taken as a measure of the rate in past time, because the total sum of terrestrial energy has been steadily diminishing, and geological processes must consequently have been more vigorous in former ages than they are now. Geologists do not pretend to assert that there has been no variation or diminution in the activities of the various processes which they have to study. What they do insist on is that the present rate of change is the only one which we can watch and measure, and which will thus supply a statistical basis for any computations on the subject. But it has been dogmatically affirmed that because terrestrial energy has been diminishing therefore all kinds of geological work must have been more vigorously and more rapidly carried on in former times than now; that there were far more abundant and more stupendous volcanoes, more frequent and more destructive earthquakes, more gigantic upheavals and subsidences, more powerful oceanic waves and tides, more violent atmospheric disturbances with heavier rainfall and more active denudation.

It is easy to make these assertions, and they look plausible; but, after all, they rest on nothing stronger than assumption. They can be tested by an appeal to the crust of the earth, in which the geological history of our planet has been so fully recorded. Had such portentous manifestations of geological activity ever been the normal condition of things since the beginning of that history, there ought to be a record of them in the rocks. But no evidence for them has been found there, though it has been diligently sought for in all quarters of the globe. We may confidently assert that while geological changes may quite possibly have taken place on a gigantic scale in the earliest ages of the earth's existence, of which no geological record remains, there is no proof that they have ever done so since the time when the very oldest of the stratified formations were deposited. There is no need to maintain that they have always been conducted precisely on the same scale as now, or to deny that they may have gradually become less vigorous as the general sum of terrestrial energy has diminished. But we may unhesitatingly affirm that no actual evidence of any such progressive diminution of activity has been adduced from the geological record in the crust of the earth: that, on the contrary, no appearances have been detected there which necessarily demand the assumption of those more powerful operations postulated by physicists, or which are not satisfactorily explicable by reference to the existing scale of nature's processes.

That this conclusion is warranted even with regard to the innate energy of the globe itself will be seen if we institute a comparison between the more ancient and the more recent manifestations of that energy. Take, for example, the proofs of gigantic plication, fracture and displacement within the terrestrial crust. These, as they have affected the most ancient rocks of Europe, have been worked out in great detail in the north-west of Scotland. But they are not essentially different from or on a greater scale than those which have been proved to have affected the Alps, and to have involved strata of so recent a date as the older Tertiary formations. On the contrary, it may be doubted whether any denuded core of an ancient mountain-chain reveals traces of such stupendous disturbances of the crust as those which have given rise to the younger mountain-chains of the globe. It may, indeed, quite well have been the rule that instead of diminishing in intensity of effect, the consequences of terrestrial contraction have increased in magnitude, the augmenting

thickness of the crust offering greater resistance to the stresses, and giving rise to vaster plications, faults, thrust-planes and metamorphism, as this growing resistance had to be overcome.

The assertion that volcanic action must have been more violent and more persistent in ancient times than it is now has assuredly no geological evidence in its support. It is quite true that there are vastly more remains of former volcanoes scattered over the surface of the globe than there are active craters now, and that traces of copious eruptions of volcanic material can be followed back into some of the oldest parts of the geological record. But we have no proof that ever at any one time in geological history there have been more or larger or more vigorous volcanoes than those of recent periods. It may be said that the absence of such proof ought not to invalidate the assertion until a far wider area of the earth's surface has been geologically studied. But most assuredly, as far as geological investigation has yet gone, there is an overwhelming body of evidence to show that from the earliest epochs in geological history, as registered in the stratified rocks, volcanic action has manifested itself very much as it does now, but on a less rather than on a greater scale. Nowhere can this subject be more exhaustively studied than in the British Isles, where a remarkably complete series of volcanic eruptions has been chronicled ranging from the earliest Palaeozoic down to older Tertiary time. The result of a prolonged study of British volcanic geology has demonstrated that, even to minute points of detail, there has been a singular uniformity in the phenomena from beginning to end. The oldest lavas and ashes differ in no essential respect from the youngest. Nor have they been erupted more copiously or more frequently. Many successive volcanic periods have followed each other after prolonged intervals of repose, each displaying the same general sequence of phenomena and similar evidence of gradual diminution and extinction. The youngest, instead of being the feeblest, were the most extensive outbursts in the whole of this prolonged series.

If now we turn for evidence of the alleged greater activity of all the epigene or superficial forces, and especially for proofs of more rapid denudation and deposition on the earth's surface, we search for it in vain among the stratified formations of the terrestrial crust. Had the oldest of these rocks been accumulated in a time of great atmospheric perturbation, of torrential rains, colossal tides and violent storms, we might surely expect to find among the sediments some proof of such disturbed meteorological and geographical conditions. We should look, on the one hand, for tumultuous accumulations of coarse unworn detritus, rapidly swept by rains, floods and waves from land to sea, and on the other hand, for an absence of any evidence of the tranquil and continuous deposit of such fine laminated silt as could only settle in quiet water. But an appeal to the geological record is made in vain for any such proofs. The oldest sediments, like the youngest, reveal the operation only of such agents and such rates of activity as are still to be witnessed in the accumulation of the same kind of deposits. If, for instance, we search the most ancient thick sedimentary formation in Britain—the Torridon Sandstone of north-west Scotland, which is older than the oldest fossiliferous deposits—we meet with nothing which might not be found in any Palaeozoic, Mesozoic or Cainozoic group of similar sediments. We see an accumulation, at least 8000 or 10,000 ft. thick, of consolidated sand, gravel and mud, such as may be gathering now on the floor of any large mountain-girdled lake. The conglomerates of this ancient series are not pell-mell heaps of angular detritus, violently swept away from the land and huddled promiscuously on the sea-floor. They are, in general, built up of pebbles that have been worn smooth, rounded and polished by prolonged attrition in running water, and they follow each other on successive platforms with intervening layers of finer sediment. The sandstones are composed of well water-worn sand, some of which has been laid down so tranquilly that its component grains have been separated out in layers according to their specific gravity, in such manner that they now present dark laminae in which particles of magnetic iron, sircon and other heavy minerals have been sifted out

together, just as iron-sand may be seen gathered into thin sheets on sandy beaches at the present day. Again, the same series of primeval sediments includes intercalations of fine silt, which has been deposited as regularly and intermittently there as it has been among the most recent formations. These bands of shale have been diligently searched for fossils, as yet without success; but they may eventually disclose organic remains older than any hitherto found in Europe.

We now come to the consideration of the palaeontological evidence as to the value of geological time. Here the conclusions derived from a study of the structure of the sedimentary formations are vastly strengthened and extended. In the first place, the organization of the most ancient plants and animals furnishes no indication that they had to contend with any greater violence of storm, flood, wave or ocean-current than is familiar to their modern descendants. The oldest trees, shrubs, ferns and club-mosses display no special structures that suggest a difference in the general conditions of their environment. The most ancient crinoids, sponges, crustaceans, arachnids and molluscs were as delicately constructed as those of to-day, and their remains are often found in such perfect preservation as to show that neither during their lifetime nor after their death were they subject to any greater violence of the elements than their living representatives now experience. Of much more cogency, however, is the evidence supplied by the grand upward succession of organic forms, from the most ancient stratified rocks up to the present day. No biologist now doubts for a moment that this marvellous succession is the result of a gradual process of evolution from lower to higher types of organization. There may be differences of opinion as to the causes which have governed this process and the order of the steps through which it has advanced, but no one who is conversant with the facts will now venture to deny that it has taken place, and that, on any possible explanation of its progress, it must have demanded an enormous lapse of time. In the Cambrian or oldest fossiliferous formations there is already a large and varied fauna, in which the leading groups of invertebrate life are represented. On no tenable hypothesis can these be regarded as the first organisms that came into being on our planet. They must have had a long ancestry, and as Darwin first maintained, the time required for their evolution may have been "as long as, or probably far longer than, the whole interval from the Silurian [Cambrian] age to the present day." The records of these earliest eras of organic development have unfortunately not survived the geological revolutions of the past; at least, they have not yet been recovered. But it cannot be doubted that they once existed and registered their testimony to the prodigious lapse of time prior to the deposition of the most ancient fossiliferous formations which have escaped destruction.

The impressive character of the evidence furnished by the sequence of organic forms throughout the great series of fossiliferous strata can hardly be fully realized without a detailed and careful study of the subject. Professor E. B. Poulton, in an address to the zoological section of the British Association at the Liverpool Meeting in 1896, showed how overwhelming are the demands which this evidence makes for long periods of time, and how impossible it is of comprehension unless these demands be conceded. The history of life upon the earth, though it will probably always be surrounded with great and even insuperable difficulties, becomes broadly comprehensible in its general progress when sufficient time is granted for the evolution which it records; but it remains unintelligible on any other conditions.

Taken then as a whole, the body of evidence, geological and palaeontological, in favour of the high antiquity of our globe is so great, so manifold, and based on such an ever-increasing breadth of observation and reflection, that it may be confidently appealed to in answer to the physical arguments which would seek to limit that antiquity to ten or twenty millions of years. In the present state of science it is out of our power to state positively what must be the lowest limit of the age of the earth. But we cannot assume it to be much less, and it may possibly

have been much more, than the 100 millions of years which Lord Kelvin was at one time willing to concede.¹

PART III.—GEOGNOSY. THE INVESTIGATION OF THE NATURE AND COMPOSITION OF THE MATERIALS OF WHICH THE EARTH CONSISTS

This division of the science is devoted to a description of the parts of the earth—of the atmosphere and ocean that surround the planet, and more especially of the solid materials that underlie these envelopes and extend downwards to an unknown distance into the interior. These various constituents of the globe are here considered as forms of matter capable of being analysed, and arranged according to their composition and the place they take in the general composition of the globe.

Viewed in the simplest way the earth may be regarded as made up of three distinct parts, each of which ever since an early period of planetary history has been the theatre of important geological operations. (1) An envelope of air, termed the *atmosphere*, which surrounds the whole globe; (2) A lower and less extensive envelope of water, known as the *hydrosphere* (Gr. *hōōp*, water) which, constituting the oceans and seas, covers nearly three-fourths of the underlying solid surface of the planet; (3) A globe, called the *lithosphere* (Gr. *lithos*, stone), the external part of which, consisting of solid stone, forms the *crust*, while underneath, and forming the vast mass of the interior, lies the *nucleus*, regarding the true constitution of which we are still ignorant.

1. *The Atmosphere.*—The general characters of the atmosphere are described in separate articles (see especially *ATMOSPHERE; METEOROLOGY*). Only its relations to geology have here to be considered. As this gaseous envelope encircles the whole globe it is the most universally present and active of all the agents of geological change. Its efficacy in this respect arises partly from its composition, and the chemical reactions which it effects upon the surface of the land, partly from its great variations in temperature and moisture, and partly from its movements.

Many speculations have been made regarding the chemical composition of the atmosphere during former geological periods. There can indeed be little doubt that it must originally have differed greatly from its present condition. If the whole mass of the planet originally existed in a gaseous state, there would be practically no atmosphere. The present outer envelope of air may be considered to be the surviving relic of this condition, after all the other constituents have been incorporated into the hydrosphere and lithosphere. The oxygen, which now forms fully a half of the outer crust of the earth, was doubtless originally, whether free or in combination, part of the atmosphere. So, too, the vast beds of coal found all over the world, in geological formations of many different ages, represent so much carbonic acid once present in the air. The chlorides and other salts in the sea may likewise partly represent materials carried down out of the atmosphere in the primitive condensation of the aqueous vapour, though they have been continually increased ever since by contributions from the drainage of the land. It has often been suggested that, during the Carboniferous period, the atmosphere must have been warmer and more charged with aqueous vapour and carbon dioxide than at the present day, so admit of so luxuriant a flora as that from which the coal-seams were formed. There seems, however, to be at present no method of arriving at any certainty on this subject. Lastly, the amount of carbonic acid absorbed in the weathering of rocks at the surface, and the consequent production of carbonates, represents an enormous abstraction of this gas.

As at present constituted, the atmosphere is regarded as a

¹ The subject of the age of the earth has also been discussed by Professor J. Joly and Professor W. J. Sollas. The former geologist, approaching the question from a novel point of view, has estimated the total quantity of sodium in the water of the ocean and the quantity of that element received annually by the ocean from the denudation of the land. Dividing the one sum by the other, he arrives at the result that the probable age of the earth is between 90 and 100 millions of years (*Trans. Roy. Dublin Soc. ser. ii. vol. vii. 1899, p. 23; Geol. Mag., 1900, p. 320*). Professor Sollas believes that this limit exceeds what is required for the evolution of geological history, that the lower limit assigned by Lord Kelvin falls short of what the facts demand, and that geological time will probably be found to have been comprised within some indeterminate period between these limits. (*Address to Section C, Brit. Assoc. Report, 1900; Age of the Earth, London, 1905.*)

mechanical mixture of nearly four volumes of nitrogen and one of oxygen, together with an average of 3.5 parts of carbon dioxide in every 10,000 parts of air, and minute quantities of various other gases and solid particles. Of the vapours contained in it by far the most important is that of water which, although always present, varies greatly in amount according to variations in temperature. By condensation the water vapour appears in visible form as dew, mist, cloud, rain, hail, snow and ice, and in these forms includes and carries down some of the other vapours, gases and solid particles present in the air. The circulation of water from the atmosphere to the land, from the land to the sea, and again from the sea to the land, forms the great geological process whereby the habitable condition of the planet is maintained and the surface of the land is sculptured (Part IV.).

2. *The Hydrosphere.*—The water envelope covers nearly three-fourths of the surface of the earth, and forms the various oceans and seas which, though for convenience of reference distinguished by separate names, are all linked together in one great body. The physical characters of this vast envelope are discussed in separate articles (see OCEAN AND OCEANOGRAPHY). Viewed from the geological standpoint, the features of the sea that specially deserve attention are first the composition of its waters, and secondly its movements.

Sea-water is distinguished from that of ordinary lakes and rivers by its greater specific gravity and its saline taste. Its average density is about 1.026, but it varies even within the same ocean, being least where large quantities of fresh water are added from rain or melting snow and ice, and greatest where evaporation is most active. That sea-water is heavier than fresh arises from the greater proportion of salts which it contains in solution. These salts constitute about three and a half parts in every hundred of water. They consist mainly of chlorides of sodium and magnesium, the sulphates of magnesium, calcium and potassium, with minute quantities of magnesium bromide and calcium carbonate. Still smaller proportions of other substances have been detected, gold for example having been found in the proportion of 1 part in 15,130,000. That many of the salts have existed in the sea from the time of its first condensation out of the primeval atmosphere appears to be probable. It is manifest, however, that whatever may have been the original composition of the oceans, they have for a vast section of geological time been constantly receiving mineral matter in solution from the land. Every spring, brook and river removes various salts from the rocks over which it moves, and these substances, thus dissolved, eventually find their way into the sea. Consequently sea-water ought to contain more or less traceable proportions of every substance which the terrestrial waters can remove from the land, in short, of probably every element present in the outer shell of the globe, for there seems to be no constituent of this earth which may not, under certain circumstances, be held in solution in water. Moreover, unless there be some counteracting process to remove these mineral ingredients, the ocean water ought to be growing, insensibly perhaps, but still assuredly, saltier, for the supply of saline matter from the land is incessant.

To the geologist the presence of mineral solutions in sea-water is a fact of much importance, for it explains the origin of a considerable part of the stratified rocks of the earth's crust. By evaporation the water has given rise to deposits of rock-salt, gypsum and other materials. The lime contained in solution, whether as sulphate or carbonate, has been extracted by many tribes of marine animals, which have thus built up out of their remains vast masses of solid limestone, of which many mountain-chains largely consist.

Another important geological feature of the sea is to be seen in the fact that its basins form the great receptacles for the detritus worn away from the land. Besides the limestones, the visible parts of the terrestrial crust are, in large measure, composed of sedimentary rocks which were originally laid down on the sea-bottom. Moreover, by its various movements, the sea occupies a prominent place among the epigene or superficial agents which produce geological changes on the surface of the globe.

3. *The Lithosphere.*—Beneath the gaseous and liquid envelopes lies the solid part of the planet, which is conveniently regarded as consisting of two parts,—(a) the crust, and (b) the interior or nucleus.

It was for a long time a prevalent belief that the interior of the globe is a molten mass round which an outer shell has gradually formed through cooling. Hence the term "crust" was applied to this external solid envelope, which was variously computed to be 10, 20, or more miles in thickness. The portion of this crust accessible to human observation was seen to afford abundant evidence of vast plications and corrugations of its substance, which were regarded as only explicable on the supposition of a thin solid collapsible shell floating on a denser liquid interior. When, however, physical arguments

were adduced to show the great rigidity of the earth as a whole, the idea of a thin crust enclosing a molten nucleus was reluctantly abandoned by geologists, who found the problem of the earth's interior to be incapable of solution by any evidence which their science could produce. They continued, however, to use the term "crust" as a convenient word to denote the cool outer layer of the earth's mass, the structure and history of which form the main subjects of geological investigation. More recently, however, various lines of research have concurred in suggesting that, whatever may be the condition of the interior, its substance must differ greatly from that of the outer shell, and that there may be more reason than appeared for the retention of the name of crust. Observations on earthquake motion by Dr John Milne and others, show that the rate and character of the waves transmitted through the interior of the earth differ in a marked degree from those propagated along the crust. This difference indicates that rocky material, such as we know at the surface, may extend inwards for some 30 m., below which the earth's interior rapidly becomes fairly homogeneous and possesses a high rigidity. From measurements of the force of gravity in India by Colonel S. G. Burrard, it has been inferred that the variations in density of the outer parts of the earth do not descend farther than 30 or 40 m., which might be assumed to be the limit of the thickness of the crust. Recent researches in regard to the radio-active substances present in rocks suggest that the crust is not more than 50 m. thick, and that the interior differs from it in possessing little or no radio-active material.

Though we cannot hope ever to have direct acquaintance with more than the mere outside skin of our planet, we may be led to infer the irregular distribution of materials within the crust from the present distribution of land and water, and the observed differences in the amount of deflection of the plumb-line near the sea and near mountain-chains. The fact that the southern hemisphere is almost wholly covered with water appears explicable only on the assumption of an excess of density in the mass of that portion of the planet. The existence of such a vast sheet of water as that of the Pacific Ocean is to be accounted for, as Archdeacon J. H. Pratt pointed out, by the presence of "some excess of matter in the solid parts of the earth between the Pacific Ocean and the earth's centre, which retains the water in its place, otherwise the ocean would flow away to the other parts of the earth." A deflection of the plumb-line towards the sea, which has in a number of cases been observed, indicates that "the density of the crust beneath the mountains must be less than that below the plains, and still less than that below the ocean-bed." Apart therefore from the depression of the earth's surface in which the oceans lie, we must regard the internal density, whether of crust or nucleus, to be somewhat irregularly arranged, there being an excess of heavy materials in the water hemisphere, and beneath the ocean-beds, as compared with the continental masses.

In our ignorance regarding the chemical constitution of the nucleus of our planet, an argument has sometimes been based upon the known fact that the specific gravity of the globe as a whole is about double that of the crust. This has been held by some writers to prove that the interior must consist of much heavier material and is therefore probably metallic. But the effect of pressure ought to make the density of the nucleus much higher, even if the interior consisted of matter no heavier than the crust. That the total density of the planet does not greatly exceed its observed amount seems only explicable on the supposition that some antagonistic force counteracts the effects of pressure. The only force we can suppose capable of so acting is heat. But comparatively little is yet known regarding the compression of gases, liquids and solids under such vast pressures as must exist within the nucleus.

That the interior of the earth possesses a high temperature is inferred from the evidence of various sources. (1) Volcanoes, which are openings that constantly, or intermittently, give out hot vapours and molten lava from reservoirs beneath the crust. Besides active volcanoes, it is known that former eruptive vents

have been abundantly and widely distributed over the globe from the earliest geological periods down to our own day. (2) Hot springs are found in many parts of the globe, with temperatures varying up to the boiling point of water. (3) From mines, tunnels and deep borings into the earth it has been ascertained that in all quarters of the globe below the superficial zone of invariable temperature, there is a progressive increase of heat towards the interior. The rate of this increase varies, being influenced, among other causes, by the varying conductivity of the rocks. But the average appears to be about 1° Fahr. for every 50 or 60 ft. of descent, as far down as observations have extended. Though the increase may not advance in the same proportion at great depths, the inference has been confidently drawn that the temperature of the nucleus must be exceedingly high.

The probable condition of the earth's interior has been a fruitful source of speculation ever since geology came into existence; but no general agreement has been arrived at on the subject. Three chief hypotheses have been propounded: (1) that the nucleus is a molten mass enclosed within a solid shell; (2) that, save in local vesicular spaces which may be filled with molten or gaseous material, the globe is solid and rigid to the centre; (3) that the great body of the nucleus consists of incandescent vapours and gases, especially vaporous iron, which under the gigantic pressure within the earth are so compressed as to confer practical rigidity on the globe as a whole, and that outside this main part of the nucleus the gases pass into a shell of molten magma, which, in turn, shades off outwards into the comparatively thin, cool solidified crust. Recent seismological observations have led to the inference that the outer crust, some 30 to 45 m. thick, must rapidly merge into a fairly homogeneous nucleus which, whatever be its constitution, transmits undulatory movements through its substance with uniform velocity and is believed to possess a high rigidity.

The origin of the earth's high internal temperature has been variously accounted for. Most usually it has been assumed to be the residue of the original "tracts of fluent heat" out of which the planet shaped itself into a globe. According to another supposition the effects of the gradual gravitational compression of the earth's mass have been the main source of the high temperature. Recent researches in radio-activity, to which reference has already been made, have indicated another possible source of the internal heat in the presence of radium in the rocks of the crust. This substance has been detected in all igneous rocks, especially among the granites, in quantity sufficient, according to the Hon. R. J. Strutt, to account for the observed temperature-gradient in the crust, and to indicate that this crust cannot be more than 45 m. thick, otherwise the outflow of heat would be greater than the amount actually ascertained. Inside this external crust containing radio-active substances, it is supposed, as already stated, that the nucleus consists of some totally different matter containing little or no radium.

Constitution of the Earth's Crust.—As the crust of the earth contains the "geological record," or stony chronicle from which geology interprets the history of our globe, it forms the main subject of study to the geologist. The materials of which this crust consists are known as minerals and rocks. From many chemical analyses, which have been made of these materials, the general chemical constitution of, at least, the accessible portion of the crust has been satisfactorily ascertained. This information becomes of much importance in speculations regarding the early history of the globe. Of the elements known to the chemist the great majority form but a small proportion of the composition of the crust, which is mainly built up of about twenty of them. Of these by far the most important are the non-metallic elements oxygen and silicon. The former forms about 47% and the latter rather more than 28% of the original crust, so that these two elements make up about three-fourths of the whole. Next after them come the metals aluminium (8.16%), iron (4.64), calcium (3.50), magnesium (2.62), sodium (2.63), and potassium (2.35). The other twelve elements included in the twenty vary in amount from a proportion of 0.41% in the case of titanium, to not more than 0.01% of chlorine, fluorine, chromium, nickel and lithium. The other fifty or more elements exist in such minute proportions in the crust that, probably, not one of them amounts to as much as 0.01%, though they include the useful metals, except iron. Taking the crust, and the external

envelopes of the ocean and the air, we thus perceive that these outer parts of our planet consist of more than three-fourths of non-metals and less than one-fourth of metals.

The combinations of the elements which are of most importance in the constitution of the terrestrial crust consist of oxides. From the mean of a large number of analyses of the rocks of the lower or primitive portion of the crust, it has been ascertained that silica (SiO_2) forms almost 60% and alumina (Al_2O_3) upwards of 15% of the whole. The other combinations in order of importance are lime (CaO) 4.90%, magnesia (MgO) 4.36%, soda (Na_2O) 3.53%, ferrous oxide (FeO) 3.52, potash (K_2O) 2.80, ferric oxide (Fe_2O_3) 2.82, water (H_2O) 1.52, titanium oxide (TiO_2) 0.60, phosphoric acid (P_2O_5) 0.22; the other combinations of elements thus form less than 1% of the crust.

These different combinations of the elements enter into further combinations with each other so as to produce the wide assortment of simple minerals (see MINERALOGY). Thus, silica and alumina are combined to form the aluminous silicates, which enter so largely into the composition of the crust of the earth. The silicates of magnesia, potash and soda constitute other important families of minerals. A mass of material composed of one, but more usually of more than one mineral, is known as a *rock*. Under this term geologists are accustomed to class not only solid stone, such as granite and limestone, but also less coherent materials such as clay, peat and even loose sand. The accessible portion of the earth's crust consists of various kinds of rocks, which differ from each other in structure, composition and origin, and are therefore susceptible of diverse classifications according to the point of view from which they are considered. The details of this subject will be found in the article PETROLOGY.

Classification of Rocks.—Various systems of classification of rocks have been proposed, but none of them is wholly satisfactory. The most useful arrangement for most purposes of the geologist is one based on the broad differences between them in regard to their mode of origin. From this point of view they may be ranged in three divisions:

1. In the first place, a large number of rocks may be described as original or undervived, for it is not possible to trace them back to any earlier source. They belong to the primitive constitution of the planet, and, as they have all come up from below through the crust, they serve to show the nature of the material which lies immediately below the outer parts of that crust. They include the numerous varieties of lava, which have been poured out in a molten state from volcanic vents, also a great series of other rocks which, though they may never have been erupted to the surface, have been forced upward in a melted condition into the other rocks of the crust and have solidified there. From their mode of origin this great class of rocks has been called "igneous" or "eruptive." As they generally show no definite internal structure save such as may result from joints, they have been termed "massive" or "unstratified," to distinguish them from those of the second division which are strongly marked out by the presence of a stratified structure. The igneous rocks present a considerable range of composition. For the most part they consist mainly of aluminous silicates, some of them being highly acid compounds with 75% or more of silica. But they also include highly basic varieties wherein the proportion of silica sinks to 40%, and where magnesia greatly predominates over alumina. The textures of igneous rocks likewise comprise a wide series of varieties. On the one hand, some are completely vitreous, like obsidian, which is a natural glass. From this extreme every gradation may be traced through gradual increase of the products of devitrification, until the mass may become completely crystalline. Again, some crystalline igneous rocks are so fine in grain as not to show their component crystals save under the microscope, while in others the texture is so coarse as to present the component minerals in separate crystals an inch or more in length. These differences indicate that, at first, the materials of the rock may have been as completely molten as artificial glass, and that the crystalline condition has been subsequently developed by cooling, and the separation of the chemical constituents into definite crystalline minerals. Many of the characters of igneous rocks have been reproduced experimentally by fusing together their minerals, or the constituents of their minerals, in the proper proportion. But it has not yet been found possible to imitate the structure of such rocks as granite. Doubtless these rocks consolidated with extreme slowness at great depths below the surface, under vast pressures and probably in the presence of water or water-vapour—conditions which cannot be adequately imitated in a laboratory.

Though the igneous rocks occupy extensive areas in some countries, they nevertheless cover a much smaller part of the whole surface of the land than is taken up by the second division or stratified rocks. But they increase in quantity downwards and probably extend continuously round the globe below the other rocks. This important series brings before us the relations of the molten magma within the earth to the overlying crust and to the outer surface. On the one hand, it includes the oldest and most deep-seated extravasations of that magma, which have been brought to light by ruptures and upheavals of the crust and prolonged denudation. On the other, it presents to our study the varied outpourings of molten and fragmentary materials in the discharges of modern and ancient

volcanoes. Between these two extremes of position and age, we find that the crust has been, as it were, riddled with injections of the magma from below. These features will be further noticed in Part V. of this article.

2. The "sedimentary" or "stratified rocks" form by much the larger part of the dry land of the globe, and they are prolonged to an unknown distance from the shores under the bed of the sea. They include those masses of mineral matter which, unlike the igneous rocks, can be traced back to a definite origin on the surface of the earth. Three distinct types may be recognized among them: (a) By far the largest proportion of them consists of different kinds of sediment derived from the disintegration of pre-existing rocks. In this "fragmental" group are placed all the varieties of shingle, gravel, sand, clay and mud, whether these materials remain in a loose incoherent condition, or have been compacted into solid stone. (b) Another group consists of materials that have been deposited by chemical precipitation from solution in water. The white sinter laid down by calcareous springs is a familiar example on a small scale. Beds of rock-salt, gypsum and dolomite have, in some regions, been accumulated to a thickness of many thousand feet, by successive precipitations of the salt contained in the water of inland seas. (c) An abundant and highly important series of sedimentary formations has been formed from the remains of plants and animals. Such accumulations may arise either from the transport and deposit of these remains, as in the case of sheets of drift-wood, and banks of drifted sea-shells, or from the growth and decay of the organisms on the spot, as happens in peat bogs and in coral-reefs.

As the sedimentary rocks have for the most part been laid down under water, and more especially on the sea-floor, they are often spoken of as "aqueous," in contradistinction to the igneous rocks. Some of them, however, are accumulated by the drifting action of wind upon loose materials, and are known as "aeolian" formations. Familiar instances of such wind-formed deposits are the sand-dunes along many parts of the sea coast. Much more extensive in area are the sands of the great deserts in the arid regions of the globe.

It is from the sedimentary rocks that the main portion of geological history is derived. They have been deposited one over another in successive strata from a remote period in the development of the globe down to the present time. From this arrangement they have been termed "stratified," in contrast to the unstratified or igneous series. They have preserved memorials of the geographical revolutions which the surface of the earth has undergone; and above all, in the abundant fossils which they have enclosed, they furnish a momentous record of the various tribes of plants and animals which have successively flourished on-land and sea. Their investigation is thus the most important task which devolves upon the geologist.

3. In the third place comes a series of rocks which are not new in their original condition, but have undergone such alteration as to have acquired new characters that more or less conceal their first structures. Some of them can be readily recognized as altered igneous masses; others are as manifestly of sedimentary origin; while of many it is difficult to decide what may have been their pristine character. To this series the term "metamorphic" has been applied. Its members are specially distinguished by a prevailing fissile, or schistose, structure which they did not at first possess, and which differs from anything found in unaltered igneous or sedimentary rocks. This fissility is combined with a more or less pronounced crystalline structure. These changes are believed to be the result of movements within the crust of the earth, whereby the most solid rocks were crushed and sheared, while, at the same time, under the influence of a high temperature and the presence of water, they underwent internal chemical reactions, which led to a rearrangement and recombination of their mineral constituents and the production of a crystalline structure (see METAMORPHOSIS).

Among the less altered metamorphic rocks of the original sediment can be easily observed; but they are also traversed by a new set of divisional planes, along which they split across the original bedding. Together with this superinduced cleavage there have been developed in them minute hairs, scales and rudimentary crystals. Further stages of alteration are marked by the increase of micaceous scales, garnets and other minerals, especially along the planes of cleavage, until the whole rock becomes crystalline, and displays its chief component minerals in successive discontinuous folia which merge into each other, and are often crumpled and puckered. Massive igneous rocks can be observed to have undergone intense crushing and cleavage, and to have ultimately assumed a crystalline foliated character. Rocks which present this aspect are known as schists (*g.*). They range from the finest silky slates, or phyllites, up to the coarsest gneisses, which in hand-specimens can hardly be distinguished from granites. There is indeed every reason to believe that such gneisses were probably originally true granites, and that their foliation and recrystallization have been the result of metamorphism.

The schists are more especially to be found in the heart of mountain-chains, and in regions where the lowest and oldest parts of the earth's crust have, in the course of geological revolutions, been exposed to the light of day. They have been claimed by some

writers to be part of the original or primitive surface of our globe that first consolidated on the molten nucleus. But the progress of investigation all over the world has shown that this supposition cannot be sustained. The oldest known rocks present none of the characters of molten material that has cooled and hardened in the air, like the various forms of recent lava. On the contrary, they possess many of the features characteristic of bodies of eruptive material that have been injected into the crust at some depth underground, and are now visible at the surface, owing to the removal by denudation of the rocks under which they consolidated. In their less foliated portions they can be recognized as true eruptive rocks. In many places gneisses that possess a thoroughly typical foliation have been found to pierce ancient sedimentary formations as intrusive bosses and veins.

PART IV.—DYNAMICAL GEOLOGY

This section of the science includes the investigation of those processes of change which are at present in progress upon the earth, whereby modifications are made on the structure and composition of the crust, on the relations between the interior and the surface, as shown by volcanoes, earthquakes and other terrestrial disturbances, on the distribution of oceans and continents, on the outlines of the land, on the form and depth of the sea-bottom, on climate, and on the races of plants and animals by which the earth is tenanted. It brings before us, in short, the whole range of activities which it is the province of geology to study, and leads us to precise notions regarding their relations to each other and the results which they achieve. A knowledge of this branch of the subject is thus the essential groundwork of a true and fruitful acquaintance with the principles of geology, seeing that it necessitates a study of the present order of nature, and thus provides a key for the interpretation of the past.

The whole range of operations included within the scope of inquiry in this branch of the science may be regarded as a vast cycle of change, into which we may break at any point, and round which we may travel, only to find ourselves brought back to our starting-point. It is a matter of comparatively small moment at what part of the cycle we begin our inquiries. We shall always find that the changes we see in action have resulted from some that preceded, and give place to others which follow them.

At an early time in the earth's history, anterior to any of the periods of which a record remains in the visible rocks, the chief sources of geological action probably lay within the earth itself. If, as is generally supposed, the planet still retained a great store of its initial heat, it was doubtless the theatre of great chemical changes, giving rise, perhaps, to manifestations of volcanic energy somewhat like those which have so marvellously roughened the surface of the moon. As the outer layers of the globe cooled, and the disturbances due to internal heat and chemical action became less marked, the conditions would arise in which the materials for geological history were accumulated. The influence of the sun, which must always have operated, would then stand out more clearly, giving rise to that wide circle of superficial changes wherein variations of temperature and the circulation of air and water over the surface of the earth come into play.

In the pursuit of his inquiries into the past history and into the present *régime* of the earth, the geologist must needs keep his mind ever open to the reception of evidence for kinds and especially for degrees of action which he had not before imagined. Human experience has been too short to allow him to assume that all the causes and modes of geological change have been definitively ascertained. On the earth itself there may remain for future discovery evidence of former operations by heat, magnetism, chemical change or otherwise, which may explain many of the phenomena with which geology has to deal. Of the influences, so many and profound, which the sun exerts upon our planet, we can as yet only perceive a little. Nor can we tell what other cosmic influences may have lent their aid in the evolution of geological changes.

Much useful information regarding many geological processes has been obtained from experimental research in laboratories and elsewhere, and much more may be confidently looked for

from future extensions of this method of inquiry. The early experiments of Sir James Hall, already noticed, formed the starting-point for numerous subsequent researches, which have elucidated many points in the origin and history of rocks. It is true that we cannot hope to imitate those operations of nature which demand enormous pressures and excessively high temperatures combined with a long lapse of time. But experience has shown that in regard to a large number of processes, it is possible to imitate nature's working with sufficient accuracy to enable us to understand them, and so to modify and control the results as to obtain a satisfactory solution of some geological problems.

In the present state of our knowledge, all the geological energy upon and within the earth must ultimately be traced back to the primeval energy of the parent nebula or sun. There is, however, a certain propriety and convenience in distinguishing between that part of it which is due to the survival of some of the original energy of the planet and that part which arises from the present supply of energy received day by day from the sun. In the former case we have to deal with the interior of the earth, and its reaction upon the surface; in the latter, we deal with the surface of the earth and to some extent with its reaction on the interior. This distinction allows of a broad treatment of the subject under two divisions:

I. Hypogene or Plutonic Action: The changes within the earth caused by internal heat, mechanical movement and chemical rearrangements.

II. Epigene or Surface Action: The changes produced on the superficial parts of the earth, chiefly by the circulation of air and water set in motion by the sun's heat.

DIVISION I.—HYPOGENE OR PLUTONIC ACTION

In the discussion of this branch of the subject we must carry in our minds the conception of a globe still possessing a high internal temperature, radiating heat into space and consequently contracting in bulk. Portions of molten rocks from inside are from time to time poured out at the surface. Sudden shocks are generated by which destructive earthquakes are propagated through the diameter of the globe as well as to and along its surface. Wide geographical areas are pushed up or sink down. In the midst of these movements remarkable changes are produced upon the rocks of the crust; they are plicated, fractured, crushed, rendered crystalline and even fused.

(A) Volcanoes and Volcanic Action.

This subject is discussed in the article VOLCANO, and only a general view of its main features will be given here. Under the term volcanic action (vulcanism, vulcanicity) are embraced all the phenomena connected with the expulsion of heated materials from the interior of the earth to the surface. A volcano may be defined as a conical hill or mountain, built up wholly or mainly of materials which have been ejected from below, and which have accumulated around the central vent of eruption. As a rule its truncated summit presents a cup-shaped cavity, termed the crater, at the bottom of which is the opening of the main funnel or pipe whereby communication is maintained with the heated interior. From time to time, however, in large volcanoes rents are formed on the sides of the cone, whence steam and other hot vapours and also streams of molten lava are poured forth. On such rents smaller or parasitic cones are often formed, which imitate the operations of the parent cone and, after repeated eruptions, may rise to hills hundreds of feet in height. In course of centuries the result of the constant outpouring of volcanic materials may be to build up a large mountain like Etna, which towers above the sea to a height of 10,840 feet, and has some 200 minor cones along its flanks.

But all volcanic eruptions do not proceed from central orifices. In Iceland it has been observed that, from fissures opened in the ground and extending for long distances, molten material has issued in such abundance as to be spread over the surrounding country for many miles, while along the lines of fissure small cones or hillocks of fragmentary material have accumulated round more active parts of the rent. There is reason to believe that in the geological past this fissure-type of eruption has repeatedly been developed, as well as the more common form of central cones like Vesuvius or Etna.

In the operations of existing volcanoes only the superficial manifestations of volcanic action are observable. But when the rocks of the earth's crust are studied, they are found to enclose the relics of former volcanic eruptions. The roots of ancient volcanoes have thus been laid bare by geological revolutions; and some of the

subterranean phases of volcanic action are thereby revealed which are wholly concealed in an active volcano. Hence to obtain as complete a conception as possible of the nature and history of volcanic action, regard must be had, not merely to modern volcanoes, but to the records of ancient eruptions which have been preserved within the crust.

The substances discharged from volcanic vents consist of—(1) Gases and vapours: which, dissolved in the molten magma of the interior, take the chief share in volcanic activity. They include in greatest abundance water-gas, which condenses into the clouds of steam so conspicuous in volcanic eruptions. Hydrochloric acid and sulphuretted hydrogen are likewise plentiful, together with many other substances which, sublimed by the high internal temperature, take a solid form on cooling at the surface. (2) Molten rock or lava: which ranges from the extremely acid type of the obsidians and rhyolites with 70% or more of silica, to the more basic and heavy varieties such as basalts and leucite-lavas with much iron, and sometimes no more than 45% of silica. The specific gravity of lavas varies between 2.37 and 3.22, and the texture ranges from nearly pure glass, like obsidian, to a coarse granitoid compound, as in some rhyolites. (3) Fragmentary materials, which are sometimes discharged in enormous quantity and dispersed over a wide extent of country, the finer particles being transported by upper air-currents for hundreds of miles. These materials arise either from the explosion of lava by the sudden expansion of the dissolved vapours and gases, as the molten rock rises to the surface, or from the breaking up and expulsion of portions of the walls of the vent, or of the lava, which happens to have solidified within these walls. They vary from the finest impalpable dust and ashes, through increasing stages of coarseness up to huge "bombs" torn from the upper surface of the molten rock in the vent, and large blocks of already solidified lava, or of non-volcanic rock detached from the sides of the pipe up which the eruptions take place.

Nothing is yet known as to the determining cause of any particular volcanic eruption. Some vents, like that of Stromboli, in the Mediterranean, are continually active, and have been so ever since man has observed them. Others again have been only intermittently in eruption, with intervals of centuries between their periods of activity. We are equally in the dark as to what has determined the sites on which volcanic action has manifested itself. There is reason, indeed, to believe that extensive fractures of the terrestrial crust have often provided passages up which the vapours, imprisoned in the internal magma, have been able to make their way, accompanied by other products. Where chains of volcanoes rise along definite lines, like those of Sumatra, Java, and many other tracts both in the Old and the New World, there appears to be little doubt that their linear distribution should be attributed to this cause. But where a volcano has appeared by itself, in a region previously exempt from volcanic action, the existence of a contributing fissure cannot be so confidently presumed. The study of certain ancient volcanoes, the roots of which have been exposed by long denudation, has shown an absence of any visible trace of their having availed themselves of fractures in the crust. The inference has been drawn that volcanic energy is capable of itself drilling an orifice through the crust, probably at some weaker part, and ejecting its products at the surface. The source of this energy is to be sought in the enormous expansive force of the vapours and gases dissolved in the magma. They are kept in solution by the enormous pressure within the earth; but as the lava approaches the surface and this pressure is relieved these dissolved vapours and gases rush out with explosive violence, blowing the upper part of the lava column into dust, and allowing portions of the liquid mass below to rise and escape, either from the crater or from some fissure which the vigour of explosion has opened on the side of the cone. So gigantic is the energy of these pent-up vapours, that, after a long period of volcanic quiescence, they sometimes burst forth with such violence as to blow off the whole of the upper part or even one side of a large cone. The history of Vesuvius, and the great eruptions of Krakatoa in 1883 and of Bandaizan in 1888 furnish memorable examples of great volcanic convulsions. It has been observed that such stupendous discharges of aeriform and fragmentary matter may be attended with the emission of little or no lava. On the other hand, some of the largest outflows of lava have been accompanied by comparatively little fragmentary material. Thus, the great lava-floods of Iceland in 1783 spread for 40 m. away from their parent fissure, which was marked only by a line of little cones of slag.

The temperature of lava as it issues from underground has been measured more or less satisfactorily, and affords an indication of that existing within the earth. At Vesuvius it has been ascertained to be more than 2000° Fahr. At first the molten rock glows with a white light, which rapidly reddens, and disappears under the rugged brown and black crust that forms on the surface. Underneath this badly conducting crust, the lava cools so slowly that columns of steam have been noticed rising from its surface more than 80 years after its eruption.

Considerable alteration in the topography of volcanic regions may be produced by successive eruptions. The fragmentary materials are sometimes discharged in such abundance as to cover the ground for many miles around with a deposit of loose ashes, cinders and slag. Such a deposit accumulating to a depth of many

feet may completely bury valleys and water-courses, and thus greatly affect the drainage. The coarsest materials accumulate nearest to the vent that emits them. The finer dust is not infrequently hurled forth with such an impetus as to be carried for thousands of feet into the tracks of upper air-currents, whereby it may be borne for hundreds of miles away from the vent so as ultimately to fall to the ground in countries far removed from any active volcano. Outflows of lava, from their greater solidity and durability, produce still more serious and lasting changes in the external features of the ground over which they flow. As they naturally seek the lowest levels, they find their way into the channels of streams. If they keep along the channels, they seal them up under a mass of compact stone which the running water, if not wholly diverted elsewhere, will take many long centuries to cut through. If, on the other hand, the lava crosses a stream, it forms a massive dam, above which the water is ponded back so as to form a lake.

As the result of prolonged activity a volcanic cone is gradually built up by successive outflows of lava and showers of dust and stones. These materials are arranged in beds, or sheets, inclining outwards from the central vent. On surrounding level ground the alternating beds are flat. In course of time deep gullies are cut on the outer slopes of the cone by rain, and by the heavy showers that arise from the condensation of the copious discharges of steam during eruptions. Along the sides of these ravines instructive sections may be studied of the volcanic strata. The larger rivers of some volcanic regions have likewise eroded vast gorges in the more horizontal lavas and ashes of the flatter country, and have thus laid bare stupendous cliffs, along which the successive volcanic sheets can be seen piled above each other for many hundred feet. On a small scale, some of these features are well displayed among the rivers that drain the volcanic tracts of central France; on a great scale, they are presented in the course of the Snake river, and other streams that traverse the great volcanic country of western North America. Similar volcanic scenery has been produced in western Europe by the action of denudation in dissecting the flat Tertiary lavas of Scotland, the Faeroe Isles and Iceland.

Of special interest to the geologist are those volcanoes which have taken their rise on the sea-bottom; for the volcanic intercalations among the stratified formations of the earth's crust are almost entirely of submarine origin. Many active volcanoes situated on islands have begun their eruptions below sea-level. Both Vesuvius and Etna sprang up on the floor of the Mediterranean sea, and have gradually built up their cones into conspicuous parts of the dry land. Examples of a similar history can be found among the volcanic islands of the Pacific Ocean. In some of these cases a movement of elevation has carried the submarine lavas, tuffs and agglomerates above sea-level, and has furnished opportunities of comparing these materials with those of recent subaerial origin, and also with the ancient records of submarine eruptions which have been preserved among the stratified formations. From the evidence thus supplied, it can be shown that the materials ejected from modern submarine volcanic vents closely resemble those accumulated by subaerial volcanoes; that the dust, ashes and stones become intermingled or interstratified with coral-mud, or other non-volcanic deposit of the sea-bottom, that vesicular lavas may be intercalated among them as on land, and that between the successive sheets of volcanic origin, layers of limestone may be laid down which are composed chiefly, or wholly, of the remains of calcareous marine organisms.

Though active volcanoes are widely distributed over the globe, and are especially abundant around the vast basin of the Pacific Ocean, they afford an incomplete picture of the extent to which volcanic action has displayed itself on the surface of our planet. When the rocks of the land are attentively studied they disclose proofs of that action in many districts where there is now no outward sign of it. Not only so, but they reveal that volcanoes have been in eruption in some of these districts during many different periods of the past, back to the beginnings of geological history. The British Islands furnish a remarkable example of such a series of ancient eruptions. From the Cambrian period all through Palaeozoic times there rose at intervals in that country a succession of volcanic centres from some of which thousands of feet of lavas and tuffs were discharged. Again in older Tertiary times the same region witnessed a stupendous outpouring of basalt, the surviving relics of which are more than 3000 ft. thick, and cover many hundreds of square miles. Similar evidence is supplied in other countries both in the Old and the New world. Hence it is proved that, in the geological past, volcanic action has been vigorous at long intervals on the same sites during a vast series of ages, though no active vents are to be seen there now. The volcanoes now active form but a small proportion of the total number which has appeared on the surface of the earth.

With regard to the cause of volcanic action much has been speculated, but little can be confidently affirmed. That water in the form of occluded gas plays the chief part in forcing the lava column up a volcanic chimney, and in the violent explosions that accompany the rise of the molten material, is generally admitted. But opinions differ as to the source of this water. According to some investigators, it should be regarded as in large measure of meteoric origin, derived from the descent of rain into the earth, and its absorption by the molten magma in the interior. Others, con-

tending that the supply so furnished, even if it could reach and be dissolved in the magma, would yet be insufficient to furnish the prodigious quantity of aqueous vapour discharged during an eruption, maintain that the water belongs to the magma itself. They point to the admitted fact that many substances, particularly metals in a state of fusion, can absorb large quantities of vapours and gases without chemical combination, and on cooling discharge them with eruptive phenomena somewhat like those of volcanoes. This question must be regarded as one of the still unsolved problems of geology.

(B) *Movements of the Earth's Crust.*

Among the hypogene forces in geological dynamics an important place must be assigned to movements of the terrestrial crust. Though the expression "the solid earth" has become proverbial, it appears singularly inappropriate in the light of the results obtained in recent years by the use of delicate instruments of observation. With the facilities supplied by these instruments (see SEISMOMETER), it has been ascertained that the ground beneath our feet is subject to continual slight tremors, and feeble pulsations of longer duration, some of which may be due to daily or seasonal variations of temperature, atmospheric pressure, or other meteorological causes. The establishment of self-recording seismometers all over the world has led to the detection of many otherwise imperceptible shocks, over and above the appreciable earth-waves propagated from earthquake centres of disturbance. Moreover, it has been ascertained that some parts of the surface of the land are slowly rising, while others are falling with reference to the sea-level. From time to time the surface suffers calamitous devastation from earthquakes, when portions of the crust under great strain suddenly give way. Lastly, at intervals, probably separated from each other by vast periods of time, the terrestrial crust undergoes intense plication and fracture, and is consequently ridged up into mountain-chains. No event of this kind has been witnessed since man began to record his experiences. But from the structure of mountains, as laid open by prolonged denudation, it is possible to form a vivid conception of the nature and effects of these most stupendous of all geological revolutions.

In considering this department of geological inquiry it will be convenient to treat it under the following heads: (1) Slow depression and upheaval; (2) Earthquakes; (3) Mountain-making; (4) Metamorphism of rocks.

1. *Slow Depression and Upheaval.*—On the west side of Japan the land is believed to be sinking below the sea, for fields are replaced by beaches of sand or shingle, while the depth of the sea off shore has perceptibly increased. A subsidence of the south of Sweden has taken place in comparatively recent times, for streets and foundations of houses at successive levels are found below high-water mark. The west coast of Greenland over an extent of more than 600 m. is sinking, and old settlements are now submerged. Proofs of submergence of land are furnished by "submerged forests," and beds of terrestrial peat now lying at various depths below the level of the sea, of which many examples have been collected along the shores of the British Isles, Holland and France. Interesting evidence that the west of Europe now stands at a lower level than it did at a late geological period is supplied in the charts of the North Sea and Atlantic, which show that the valleys of the land are prolonged under the sea. These valleys have been eroded out of the rocks by the streams which flow in them, and the depth of their submerged portions below the sea level affords an indication of the extent of the subsidence.

The uprise of land has been detected in various parts of the world. One of the most celebrated instances is that of the shores of the Gulf of Bothnia, where, at Stockholm, the elevation, between the years 1774 and 1875, appears to have been 48 centimetres (18½ in.) in a century. But on the west side of Sweden, fronting the Skagerak, the coast, between the years 1820 and 1870, rose 30 centimetres, which is at the rate of 60 centimetres, or nearly 2 ft., in a century. In the region of the Great Lakes in the interior of Canada and the United States it has been ascertained that the land is undergoing a slow tilt towards the south-west, of which the mean rate appears to be rather less than 6 in. in a century. If this rate of change should continue the waters of Lake Michigan, owing to the progress of the tilt, will, in some 500 or 600 years, submerge the city of Chicago, and eventually the drainage of the lakes will be diverted into the basin of the Mississippi. Proof of recent emergence of land is supplied by what are called "raised beaches" or "strand-lines," that is, lines of former shores marked by sheets of littoral deposits, or platforms cut by shore-waves in rock and flanked by old sea-cliffs and lines of sea-worn caves. Admirable examples of these features are to be seen along the west coast of Europe from the south of England to the north of Norway. These lines of old shores become fainter in proportion to their antiquity. In Britain they occur at various heights, the platforms at 25, 50 and 100 ft. being well marked.

The cause of these slow upward and downward movements of the crust of the earth is still imperfectly understood. Upheaval might conceivably be produced by an ascent of the internal magma, and the consequent expansion of the overlying crust by heat; while depression might follow any subsidence of the magma, or its displacement

to another district. If, as is generally believed, the globe is still contracting, the shrinkage of the surface may cause both these movements. Subsidence will be in excess, but between subsiding tracts lateral thrust may suffice to push upward intervening more solid and stable ground; but no solution of the problem yet proposed is wholly satisfactory.

2. *Earthquakes.*—As this subject is discussed in a separate article it will be sufficient here to take note of its more important geological bearings. It was for many centuries taken for granted that earthquakes and volcanoes are due to a common cause. We have seen that in classical antiquity they were looked on as the results of the movements of wind imprisoned within the earth. Long after this notion was discarded, and a more scientific appreciation of volcanic action was reached, it was still thought that earthquakes should be regarded as manifestations of the same source of energy as that which displays itself in volcanic eruptions. It is true that earthquakes are frequent in districts of active volcanoes, and they may undoubtedly be often due there to the explosions of the magma, or to the rupture of rocks caused by its ascent towards the surface. But such shocks are comparatively local in their range and feeble in their effects. There is now a general agreement that between the great world-shaking earthquakes and volcanic phenomena, no immediate and intimate relationship can be traced, though they may be connected in ways which are not yet perceived. Some of the more recent great earthquakes on land have proved that the waves of shock are produced by the sudden rupture or collapse of rocks under great strain, either along lines of previous fracture or of new rents in the terrestrial crust; and that such ruptures may occur at a remote distance from any volcano. Thus the recent disastrous San Francisco earthquake has been recognised to have resulted from a slipping of ground along the line of an old fault, which has been traced for a long distance in California generally parallel to the coast. The position of this fault at the surface has long been clearly followed by its characteristic topography. After the earthquake these superficial features were found to have been removed by the same cause that had originated them. For some 300 m. on the track of this old fault-line a renewed slipping was seen to have taken place along one or both sides, and the ground at the surface was ruptured as well as displaced horizontally. Obviously, the jar occasioned by the sudden and simultaneous subsidence of a portion of the earth's crust several hundred miles long, must be far more serious than could be produced by an earthquake radiating from a single local volcanic focus.

From their disastrous effects on buildings and human lives, an exaggerated importance has been imputed to earthquakes as agents of geological change. Experience shows that even after a severe shock which may have destroyed numerous towns and villages, together with thousands of their inhabitants, the face of the country has suffered scarcely any perceptible change, and that, in the course of a year or two, when the ruined houses and prostrate trees have been cleared away, little or no obvious trace of the catastrophe may remain. Among the more enduring records of a great earthquake may be enumerated (a) landslips, which lay bare hillsides, and sometimes pond back the drainage of valleys so as to give rise to lakes; (b) alterations of the topography, as in fissuring of the ground, or in the production of inequalities whereby the drainage is affected; new valleys and new lakes may thus be formed, while previously existing lakes may be emptied; (c) permanent changes of level, either in an upward or downward direction.

3. *Mountain-making.*—This subject may be referred to here for the striking evidence which it supplies of the importance of movements of the earth's crust among geological processes. The structure of a great mountain-chain such as the Alps proves that the crust of the earth has been intensely plicated, crumpled and fractured. Vast piles of sedimentary strata have been folded to such an extent as to occupy now only half of their original horizontal extent. This compression in the case of the Alps has been computed to amount to as much as 120,000 metres or 74 English miles, so that two points on the opposite sides of that chain have been brought by so much nearer to each other than they were originally before the movements. Besides such intense plication, extensive rupturing of the crust has taken place in the same range of mountains. Not only have the most ancient rocks been squeezed up into the central axis of the chain, but huge slices of them have been torn away from the main body, and thrust forward for many miles, so as now actually to form the summits of mountains, which are almost entirely composed of much younger formations. If these colossal disturbances occurred rapidly, they would give rise to cataclysms of inconceivable magnitude over the surface of the globe. No record has been discovered of such accompanying devastation. But whether sudden and violent, or prolonged and gradual, such stupendous upturnings of the crust did undoubtedly take place, as is clearly revealed in innumerable natural sections, which have been laid open by the denudation of the crests and sides of the mountains.

4. *Metamorphism of Rocks (see METAMORPHISM).*—During the movements to which the crust of the earth has been subject, not only have the rocks been folded and fractured, but they have likewise, in many regions, acquired new internal structures, and have thus undergone a process of "regional metamorphism." This rearrangement of their substance has been governed by conditions

which are probably not yet all recognized, but among them we should doubtless include a high temperature, intense pressure, mechanical movement resulting in crushing, shearing and foliation, and the presence of water in their pores. It is among igneous rocks that the progressive stages of metamorphism can be most easily traced. Their definite original structure and mineral composition afford a starting-point from which the investigation may be begun and pursued. Where an igneous rock has been invaded by metamorphic changes, it may be observed to have been first broken down into separate lentilles, the cores of which may still retain, with little or no alteration, the original characteristic minerals and crystalline structure of the rock. Between these lentilles, the intervening portions have been crushed down into a powder or paste, which seems to have been squeezed round and past them, and shows a laminated arrangement that resembles the flow-structure in lavas. As the degree of metamorphism increases, the lentilles diminish in size, and the intervening crushed and foliated matrix increases in amount, until at last it may form the entire mass of the rock. While the original minerals are thus broken down, new varieties make their appearance. Of these, among the earliest to present themselves are usually the micas, that impart their characteristic silvery sheen to the surfaces of the folia along which they spread. Younger feldspars, as well as mica, are developed, and there arise also sillimanite, garnet, andalusite and many others. The texture becomes more coarsely crystalline, and the segregation of the constituent minerals more definite along the lines of foliation. From the finest silky phyllites a gradation may be traced through successively coarser mica-schists, until we reach the almost granitic texture of the coarsest gneisses.

Regional metamorphism has arisen in the heart of mountain-chains, and in any other district where the deformation of the crust has been sufficiently intense. There is another type of alteration termed "contact-metamorphism," which is developed around masses of igneous rock, especially where these have been intruded in large bosses among stratified formations. It is particularly displayed around masses of granite, where sandstones are found altered into quartzite, shales and grits into schistose compounds, and where sometimes fossils are still recognizable among the metamorphic minerals.

DIVISION II.—EPIGENE OR SUPERFICIAL ACTION.

It is on the surface of the globe, and by the operation of agents working there, that at present the chief amount of visible geological change is effected. In considering this branch of inquiry, we are not involved in a preliminary difficulty regarding the very nature of the agencies as is the case in the investigation of plutonic action. On the contrary, the surface agents are carrying on their work under our very eyes. We can watch it in all its stages, measure its progress, and mark in many ways how accurately it represents similar changes which, for long ages previously, must have been effected by the same means. But in the systematic treatment of this subject we encounter a difficulty of another kind. We discover that while the operations to be discussed are numerous and readily observable, they are so interwoven into one great network that any separation of them under different subdivisions is sure to be more or less artificial and to convey an erroneous impression. While, therefore, under the unavoidable necessity of making use of such a classification of subjects, we must always bear in mind that it is employed merely for convenience, and that in nature superficial geological action must be continually viewed as a whole, since the work of each agent has constant reference to that of the others, and is not properly intelligible unless that connexion be kept in view.

The movements of the air; the evaporation from land and sea; the fall of rain, hail and snow; the flow of rivers and glaciers; the tides, currents and waves of the ocean; the growth and decay of organized existence, alike on land and in the depths of the sea;—in short, the whole circle of movement, which is continually in progress upon the surface of our planet, are the subjects now to be examined. It is desirable to adopt some general term to embrace the whole of this range of inquiry. For this end the word *epigene* (Gr. *ἐπί*, upon) has been suggested as a convenient term, and antithetical to *hypogene* (Gr. *ὑπό*, under), or subterranean action.

A simple arrangement of this part of Geological Dynamics is in three sections:

- A. *Air.*—The influence of the atmosphere in destroying and forming rocks.
- B. *Water.*—The geological functions of the circulation of water through the air and between sea and land, and the action of the sea.

C. Life.—The part taken by plants and animals in preserving, destroying or reproducing geological formations.

The words destructive, reproductive and conservative, employed in describing the operations of the epigene agents, do not necessarily imply that anything useful to man is destroyed, reproduced or preserved. On the contrary, the destructive action of the atmosphere may turn barren rock into rich soil, while its reproductive effects sometimes turn rich land into barren desert. Again, the conservative influence of vegetation has sometimes for centuries retained as barren morass what might otherwise have become rich meadow or luxuriant woodland. The terms, therefore, are used in a strictly geological sense, to denote the removal and re-deposition of material, and its agency in preserving what lies beneath it.

(A) The Air.

As a geological agent, the air brings about changes partly by its component gases and partly by its movements. Its destructive action is both chemical and mechanical. The chemical changes are probably mainly, if not entirely, due to the moisture of the air, and particularly to the gases, vapours and organic matter which the moisture contains. Dry air seems to have little or no appreciable influence in promoting these reactions. As the changes in question are similar to those much more abundantly brought about by rain they are described in the following section under the division on rain.

Among the more recognizable mechanical changes effected in the atmosphere, one of considerable importance is to be seen in the result of great and rapid changes of temperature. Heat expands rocks, while cold contracts them. In countries with a great annual range of temperature, considerable difficulty is sometimes experienced in selecting building materials liable to be little affected by the alternate expansion and contraction, which prevents the joints of masonry from remaining close and tight. In dry tropical climates, where the days are intensely hot and the nights extremely cold, the rapid nocturnal contraction produces a strain so great as to rival frost in its influence upon the surface of exposed rocks, disintegrating them into sand, or causing them to crack or peel off in shalis or irregular pieces. Dr Livingstone found in Africa (12° S. lat., 34° E. long.) that surfaces of rock which during the day were heated up to 137° Fahr., cooled so rapidly by radiation at night that, unable to sustain the strain of contraction, they split and threw off sharp angular fragments from a few ounces to 100 or 200 lb in weight. In temperate regions this action, though much less pronounced, still makes itself felt. In these climates, however, and still more in high latitudes, somewhat similar results are brought about by frost.

By its motion in wind the air drives loose sand over rocks, and in course of time abrades and smoothes them. "Desert polish" is the name given to the characteristic lustrous surface thus imparted. Holes are said to be drilled in window glass at Cape Cod by the same agency. Cavities are now and then hollowed out of rocks by the gyration in them of little fragments of stone or grains of sand kept in motion by the wind. Hurricanes form important geological agents upon land in uprooting trees, and thus sometimes impeding the drainage of a country and giving rise to the formation of peat mosses.

The reproductive action of the air arises partly from the effect of the chemical and mechanical disintegration involved in the process of "weathering," and partly from the transporting power of wind and of aerial currents. The layer of soil, which covers so much of the surface of the land, is the result of the decay of the underlying rocks, mingled with mineral matter blown over the ground by wind, or washed thither by rain, and with the mouldering remains of plants and animals. The extent to which fine dust may be transported over the surface of the land can hardly be realized in countries clothed with a covering of vegetation, though even there, in dry weather during spring, clouds of dust may often be seen blown away by wind from bare ploughed fields. Intercepted by the leaves of plants and washed down to their roots by rain, this dust goes to increase the soil below. In arid climates, where dust clouds are dense and frequent, enormous quantities of fine mineral particles are thus borne along and accumulated. The remarkable deposit of "Loess," which is sometimes more than 1500 ft. thick and covers extensive areas in China and other countries, is regarded as due to the drifting of dust by wind. Again the dunes of sand so abundant along the inner side of sandy sea-beaches in many different parts of the world are attributable to the same action.

(B) Water.

In treating of the epigene action of water in geological processes it will be convenient to deal first with its operations in traversing the land, and then with those which it performs in the sea. The circulation of water from land to sea and again from sea to land constitutes the fundamental cause of most of the daily changes by which the surface of the land is affected.

1. Rain.—Rain effects two kinds of changes upon the surface of the land. It acts chemically upon soils and stones, and sinking under

ground continues a great series of similar reactions there. It acts mechanically, by washing away loose materials, and thus powerfully affecting the contours of the land. Its chemical action depends mainly upon the nature and proportion of the substances which, in descending to the earth, it abstracts from the atmosphere. Rain always absorbs a little air, which, in addition to its nitrogen and oxygen, contains carbonic acid, and in minute proportions, sodium chloride, sulphuric acid and other ingredients, especially inorganic dust, organic particles and living germs. Probably the most generally efficient of these constituents are oxygen, carbonic acid and organic matter. Armed with these reagents, rain effects a chemical decomposition of the rocks on which it falls, and through which it sinks underground. The principal changes thus produced are as follows:

(a) Oxidation.—Owing to the prominence of oxygen in rain-water, and its readiness to unite with any substance which can contain more of it, a thin oxidized pellicle is formed on the surface of many rocks on which rain falls, and this oxidized layer, if not at once washed off, sinks deeper until a crust is formed over the stone. A familiar illustration of this action is afforded by the rust, or oxide, which forms on iron when exposed to moisture, though this iron may be kept long bright if allowed to remain screened from moist air and rain. (b) Deoxidation.—Organic matter having an affinity for more oxygen decomposes peroxides by depriving them of some part of their share of that element and reducing them to protoxides. These changes are especially noticeable among the iron oxides so abundantly diffused among rocks. Hence rain-water, in sinking through soil and obtaining such organic matter, becomes thereby a reducing agent. (c) Solution.—This may take place either by the simple action of the water, as in the solution of rock-salt, or by the influence of the carbonic acid present in the rain. (d) Formation of Carbonates.—A familiar example of the action of carbonic acid in rain is to be seen in the corrosion of exposed marble slabs. The carbonic acid dissolves some of the lime, which, as a bicarbonate, is held in solution in the carbonated water, but is deposited again when the water loses its carbonic acid or evaporates. It is not merely carbonates, however, which are liable to this kind of destruction. Even silicates of lime, potash and soda, combinations existing abundantly as constituents of rocks, are attacked; their silica is liberated, and their alkalis or alkaline earths, becoming carbonates, are removed in solution. (e) Hydration.—Some minerals, containing little or no water, and therefore called anhydrous, when exposed to the action of the atmosphere, absorb water, or become hydrous, and are then usually more prone to further change. Hence the rocks of which they form part become disintegrated.

Besides the reactions here enumerated, a considerable amount of decay may be observed as the result of the presence of sulphuric and nitric acid in the air, especially in that of large towns and manufacturing districts, where much coal is consumed. Metallic surfaces, as well as various kinds of stone, are there corroded, while the mortar of walls may often be observed to be slowly swelling out and dropping off, owing to the conversion of the lime into sulphate. Great injury is likewise done from a similar cause to marble monuments in exposed graveyards.

The general result of the disintegrating action of the air and of rain, including also that of plants and animals, to be noticed in the sequel, is denoted by the term "weathering." The amount of decay depends partly on conditions of climate, especially the range of temperature, the abundance of moisture, height above the sea and exposure to prevalent winds. Many rocks liable to be saturated with rain and rapidly dried under a warm sun are apt to disintegrate at the surface with comparative rapidity. The nature and progress of the weathering are mainly governed by the composition and texture of the rocks exposed to it. Rocks composed of particles liable to little chemical change from the influence of moisture are best fitted to resist weathering, provided they possess sufficient cohesion to withstand the mechanical processes of disintegration. Siliceous sandstones are excellent examples of this permanence. Consisting wholly or mainly of the durable mineral quartz, they are sometimes able so to withstand decay that buildings made of them still retain, after the lapse of centuries, the chisel-marks of the builders. Some rocks, which yield with comparative rapidity to the chemical attacks of moisture, may show little or no mark of disintegration on their surface. This is particularly the case with certain calcareous rocks. Limestone when pure is wholly soluble in acidulated water. Rain falling on such a rock removes some of it in solution, and will continue to do so until the whole is dissolved away. But where a limestone is full of impurities, a weathered crust of more or less insoluble particles remains after the solution of the calcareous part of the stone. Hence the relative purity of limestones may be roughly determined by examining their weathered surfaces, where, if they contain much sand, the grains will be seen projecting from the calcareous matrix, and where, should the rock be very ferruginous, the yellow hydrous peroxide, or ochre, will be found as a powdery crust. In limestones containing abundant encrinurals, shells, or other organic remains, the weathered surface commonly presents the fossils standing out in relief. The crystalline arrangement of the lime in the organic structures enables them to resist disintegration better than the general mechanically aggregated matrix of the rock. An experienced fossil collector will always search well such weathered surfaces, for he often finds there, dedicated

picked out by the weather, minute and frail fossils which are wholly invisible on a freshly broken surface of the stone. Many rocks weather with a thick crust, or even decay inwards for many feet or yards. Basalt, for example, often shows a yellowish-brown ferruginous layer on its surface, formed by the conversion of its felspar into kaolin, and the removal of its calcium silicate as carbonate, by the hydration of its olivine and augite and their conversion into serpentine, or some other hydrous magnesian silicate, and by the conversion of its magnetite into limonite. Granite sometimes shows in a most remarkable way the distance to which weathering can reach. It may occasionally be dug into for a depth of 20 or 30 ft., the quartz crystals and veins retaining their original positions, while the felspar is completely kaolinized. It is to the endlessly varied effects of weathering that the abundant fantastic shapes assumed by crags and other rocky masses are due. Most varieties of rock have their own characteristic modes of weathering, whereby they may be recognized even from a distance. To some of these features reference will be made in Part VIII.

The mechanical action of rain, which is intimately bound up with its chemical action, consists in washing off the fine superficial particles of rocks which have been corroded and loosened by the process of weathering, and in thus laying open fresh portions to the same influences of decay. The detritus so removed is partly carried down into the soil which is thereby enriched, partly held in suspension in the little runnels into which the rain-drops gather as they begin to flow over the land, partly pushed downwards along the surface of sloping ground. A good deal of it finds its way into the nearest brooks and rivers, which are consequently made muddy by heavy rain.

It is natural that a casual consideration of the subject should lead to an impression that, though the general result of the fall of rain upon a land-surface must lead to some amount of disintegration and lowering of that surface, the process must be so slow and slight as hardly to be considered of much importance among geological operations. But further attention will show such an impression to be singularly erroneous. It loses sight of the fact that a change which may be hardly appreciable within a human lifetime, or even within the comparatively brief span of geological time embraced in the compass of human history, may nevertheless become gigantic in its results in the course of immensely protracted periods. An instructive lesson in the erosive action of rain may be found in the pitted and channelled surface of ground lying under the drip of the eaves of a cottage. The fragments of stone and pebbles of gravel that form part of the soil can there be seen sticking out of the ground, because being hard they resist the impetus of the falling drops, protecting for a time the earth beneath them, while that which surrounded and covered them is washed away. From this familiar illustration the observer may advance through every stage in the disappearance of material which once covered the surface, until he comes to examples where once continuous and thick sheets of solid rock have been reduced to a few fragments or have been entirely removed. Since the whole land surface over which rain falls is exposed to this waste, the superficial covering of decayed rock or soil, as Hutton insisted, is constantly, though imperceptibly, travelling outward and downward to the sea. In this process of transport rain is an important carrying agent, while at the same time it serves to connect the work of the other disintegrating forces, and to make it conducive to the general degradation of the land. Though this decay is general and constant, it is obviously not uniform. In some places where, from the nature of the rock, from the flatness of the ground, or from other causes, rain works under great difficulties, the rate of waste may be extremely slow. In other places it may be rapid enough to be appreciable from year to year. A survey of this department of geological activity shows how unequal wasting by rain, combined with the operations of brooks and rivers, has produced the details of the present relief of the land, those tracts where the destruction has been greatest forming hollows and valleys, others, where it has been less, rising into ridges and hills (Part VIII.).

Rain-action is not merely destructive, but is accompanied with reproductive effects, chief of which is the formation of soil. In favourable situations it has gathered together accumulations of loam and earth from neighbouring higher ground, such as the "brick-earth," "head," and "rain-wash" of the south of England—earthy deposits, sometimes full of angular stones, derived from the subaerial waste of the rocks of the neighbourhood.

2. *Underground Water.*—Of the rain which falls upon the land one portion flows off into brooks and rivers by which the water is conducted back to the ocean; the larger part, however, sinks into the ground and disappears. It is this latter part which has now to be considered. Over and above the proportion of the rainfall which is absorbed by living vegetation and by the soil, there is a continual filtering down of the water from the surface into the rocks that lie below, where it partly lodges in pores and interstices, and partly finds its way into subterranean joints and fissures, in which it performs an underground circulation, and ultimately issues once more at the surface in the form of springs (q.v.). In the course of this circulation the water performs an important geological task. Not only carrying down with it the substances which the rain has abstracted from the air, but obtaining more acids and organic matter from the soil, it is enabled to effect chemical changes in the

rocks underneath, and especially to dissolve limestone and other calcareous formations. So considerable is the extent of this solution in some places that the springs which come to the surface, and begin there to evaporate and lose some of their carbonic acid, contain more dissolved lime than they can hold. They consequently deposit it in the form of calcareous tuff or sinter (q.v.). Other subterranean waters issue with a large proportion of iron-salts in solution which form deposits of ochre. The various mineral springs so largely made use of for the mitigation or cure of diseases owe their properties to the various salts which they have dissolved out of rocks underground. As the result of prolonged subterranean solution in limestone districts, passages and caves (q.v.), sometimes of great width and length, are formed. When these lie near the surface their roofs sometimes fall in and engulf brooks and rivers, which then flow for some way underground until the tunnels conduct them back again to daylight on some lower ground.

Besides its chemical activity water exerts among subterranean rocks a mechanical influence which leads to important changes in the topography of the surface. In removing the mineral matter, either in solution or as fine sediment, it sometimes loosens the support of overlying masses of rock which may ultimately give way on sloping ground, and rush down the declivities in the form of landslips. These destructive effects are specially frequent on the sides of valleys in mountainous countries and on lines of sea-cliff.

3. *Brooks and Rivers.*—As geological agents the running waters on the face of the land play an important part in epigene changes. Like rain and springs they have both a chemical and a mechanical action. The latter receives most attention, as it undoubtedly is the more important; but the former ought not to be omitted in any survey of the general waste of the earth's surface. The water of rivers must possess the powers of a chemical solvent like rain and springs, though its actual work in this respect can be less easily measured, seeing that river water is directly derived from rain and springs, and necessarily contains in solution mineral substances supplied to it by them and not by its own operation. Nevertheless, it is sometimes easy to prove that streams dissolve chemically the rocks of their channels. Thus, in limestone districts the base of the cliffs of river ravines may be found eaten away into tunnels, arches, and overhanging projections, presenting in their smooth surfaces a great contrast to the angular jointed faces of the same rock, where now exposed to the influence only of the weather on the higher parts of the cliff.

The mechanical action of rivers consists (a) in transporting mud, sand, gravel and blocks of stone from higher to lower levels; (b) in using these loose materials to widen and deepen their channels by erosion; (c) in depositing their load of detritus wherever possible and thus to make new geological formations.

(a) *Transporting Power.*—River-water is distinguished from that of springs by being less transparent, because it contains more or less mineral matter in suspension, derived mainly from what is washed down by rain, or carried in by brooks, but partly also from the abrasion of the water-channels by the erosive action of the rivers themselves. The progress of this burden of detritus may be instructively followed from the mountain-tributaries of a river down to the mouth of the main stream. In the high grounds the water-courses may be observed to be choked with large fragments of rock disengaged from the cliffs and crags on either side. Traced downwards the blocks are seen to become gradually smaller and more rounded. They are ground against each other, and upon the rocky sides and bottom of the channel, getting more and more reduced as they descend, and at the same time abrading the rocks over or against which they are driven. Hence a great deal of debris is produced, and is swept along by the onward and downward movement of the water. The finer portions, such as mud and fine sand, are carried in suspension, and impart the characteristic turbidity to river-water; the coarser sand and gravel are driven along the river-bottom. The proportion of suspended mineral matter has been ascertained with more or less precision for a number of rivers. As an illustrative example of a river draining a vast area with different climates, forms of surface and geological structure the Mississippi may be cited. The average proportion of sediment in its water was ascertained by Humphreys and Albot to be $\frac{1}{200}$ by weight or $\frac{1}{175}$ by volume. These engineers found that, in addition to this suspended material, coarse detritus is constantly being pushed forward along the bed of the river into the Gulf of Mexico, to an amount which they estimated at about 750,000,000 cubic ft. of sand, earth and gravel; they concluded that the Mississippi carries into the gulf every year an amount of mechanically transported sediment sufficient to make a prism one square mile in area and 268 ft. in height.

(b) *Escaping Power.*—It is by means of the sand, gravel and stones which they drive against the sides and bottoms of their channels that streams have hollowed out the beds in which they flow. Not only is the coarse detritus reduced in size by the friction of the stones against each other, but, at the same time, these materials abrade the rocks against which they are driven by the current. Where, owing to the shape of the bottom of the channel, the stones are caught in eddies, and are kept whirling round there, they become more and more worn down themselves, and at the same time scour out basin-shaped cavities, or "pot-holes," in the solid rock beneath.

consideration first. They possess a number of structures which belong to the original conditions in which they were accumulated. They present in addition other structures which have been superinduced upon them, and which they share with the unstratified or igneous rocks.

I. ORIGINAL STRUCTURES

(a) *Stratified Rocks*.—This extensive and important series is above all distinguished by possessing a prevailing stratified arrangement. Their materials have been laid down in laminae, layers and strata, or beds, pointing generally to the intermittent deposition of the sediments of which they consist. As this stratification was, as a rule, originally nearly or quite horizontal, it serves as a base from which to measure any subsequent disturbance which the rocks have undergone. The occurrence of false-bedding, i.e. bands of inclined layers between the normal planes of stratification, does not form any real exception; but indicates the action of shifting currents whereby the sediment was transported and thrown down. Other important records of the original conditions of deposit are supplied by ripple-marks, sun-cracks, rain-prints and concretions.

From the nature of the material further light is cast on the geographical conditions in which the strata were accumulated. Thus, conglomerates indicate the proximity of old shore-lines, sandstones mark deposits in comparatively shallow water, clays and shales point to the tranquil accumulation of fine silt at a greater depth and further from land, while fossiliferous limestones bear witness to clearer water in which organisms flourished at some distance from deposits of sand and mud. Again, the alternation of different kinds of sediment suggests a variability in the conditions of deposition, such as a shifting of the sediment-bearing currents and of the areas of muddy and clear water. A thick group of conformable strata, that is, a series of deposits which show no discordance in their stratification, may usually be regarded as having been laid down on a sea-floor that was gently sinking. Here and there evidence is obtainable of the limits or of the progress of the subsidence by what is called "overlap." Of the absolute length of time represented by any strata or groups of strata no satisfactory estimates can yet be formed. Certain general conclusions may indeed be drawn, and comparisons may be made between different series of rocks. Sandstones full of false-bedding were probably accumulated more rapidly than finely-laminated shales or clays. It is not uncommon in certain Carboniferous formations to find coniferous and other trunks embedded in sandstone. Some of these trees seem to have been carried along and to have sunk, their heavier or root end touching the bottom and their upper end slanting upward in the direction of the current, exactly as in the case of the snags of the Mississippi. In other cases the trees have been submerged while still in their positions of growth. The continuous deposit of sand at last rose above the level of the trunks and buried them. It is clear then that the rate of deposit must have been sometimes sufficiently rapid to allow sand to accumulate to a depth of 30 ft. or more before the decay of the wood. Modern instances are known where, under certain circumstances, submerged trees may last for some centuries, but even the most durable must decay in what, after all, is a brief space of geological time. Since continuous layers of the same kind of deposit suggest a persistence of geological conditions, while numerous alternations of different kinds of sedimentary matter point to vicissitudes or alternations of conditions, it may be supposed that the time represented by a given thickness of similar strata was less than that shown by the same thickness of dissimilar strata, because the changes needed to bring new varieties of sediment into the area of deposit would usually require the lapse of some time for their completion. But this conclusion may often be erroneous. It will be best supported when, from the very nature of the rocks, wide variations in the character of the water-bottom can be established. Thus a group of shales followed by a fossiliferous limestone would almost always mark the lapse of a much longer period than an equal depth of sandy strata. A thick mass of limestone, made up of organic remains which lived and died upon the spot, and whose remains are crowded together generation above generation, must have demanded many years or centuries for its formation.

But in all speculations of this kind we must bear in mind that the length of time represented by a given depth of strata is not to be estimated merely from their thickness or lithological character. The interval between the deposit of two successive laminae of shale may have been as long as, or even longer than, that required for the formation of one of the laminae. In like manner the interval needed for the transition from one stratum or kind of strata to another may often have been more than equal to the time required for the formation of the strata on either side. But the relative *chronological importance* of the bars or lines in the geological record can seldom be satisfactorily discussed merely on lithological grounds. This must mainly be decided on the evidence of organic

remains, as shown in Part VI., where the grouping of the stratified rocks into formations and systems is described.

(b) *Igneous Rocks*.—As part of the earth's crust these rocks present characters by which they are strongly differentiated from the stratified series. While the broad petrographical distinctions of their several varieties remain persistent, they present sufficient local variations of type to point to the existence of what have been called petrographic provinces, in each of which the eruptive masses are connected by a general family relationship, differing more or less from that of a neighbouring province. In each region presenting a long chronological series of eruptive rocks a petrographical sequence can be traced, which is observed to be not absolutely the same everywhere, though its general features may be persistent. The earliest manifestations of eruptive material in any district appear to have been most frequently of an intermediate type between acid and basic, passing thence into a thoroughly acid series and concluding with an effusion of basic material.

Considered as part of the architecture of the crust of the earth, igneous rocks are conveniently divisible into two great series: (1) those bodies of material which have been injected into the crust and have solidified there, and (2) those which have reached the surface and have been ejected there, either in a molten state as lava or in a fragmental form as dust, ashes and scoriae. The first of these divisions represents the plutonic, intrusive or subsequent phase of eruptivity; the second marks the volcanic, interstratified or contemporaneous phase.

1. The plutonic or intrusive rocks, which have been forced into the crust and have consolidated there, present a wide range of texture from the most coarse-grained granites to the most perfect natural glass. Seeing that they have usually cooled with extreme slowness underground, they are as a general rule more largely crystalline than the volcanic series. The form assumed by each individual body of intrusive material has depended upon the shape of the space into which it has been injected, and where it has cooled and become solid. This shape has been determined by the local structure of the earth's crust on the one hand and by the energy of the eruptive force on the other. It offers a convenient basis for the classification of the intrusive rocks, which, as part of the framework of the crust, may thus be grouped according to the shape of the cavity which received them, as bosses, sills, dikes and necks.

Bosses, or stocks, are the largest and most shapeless extravasations of erupted material. They include the great bodies of granite which, in most countries of the world, have risen for many miles through the stratified formations and have altered the rocks around them by contact-metamorphism. Sills, or intrusive sheets, are bed-like masses which have been thrust between the planes of sedimentary or even of igneous rocks. The term *laccolite* has been applied to sills which are connected with bosses. Intrusive sheets are distinguishable from true contemporaneously intercalated lavas by not keeping always to the same platform, but breaking across and altering the contiguous strata, and by the closeness of their texture where they come in contact with the contiguous rocks, which, being cold, chilled the molten material and caused it to consolidate on its outer margins more rapidly than in its interior. Dikes or veins are vertical walls or ramifying branches of intrusive material which has consolidated in fissures or irregular clefts of the crust. Necks are volcanic chimneys which have been filled up with erupted material, and have now been exposed at the surface after prolonged denudation has removed not only the superficial volcanic masses originally associated with them, but also more or less of the upper part of the vents. Plutonic rocks do not present evidence of their precise geological age. All that can be certainly affirmed from them is that they must be younger than the rocks into which they have been intruded. From their internal structure, however, and from the evidence of the rocks associated with them, some more or less definite conjectures may be made as to the limits of time within which they were probably injected.

2. The interstratified or volcanic series is of special importance in geology, inasmuch as it contains the records of volcanic action during the past history of the globe. It was pointed out in Part I. that while towards the end of the 18th and in the beginning of the 19th century much attention was paid by Hutton and his followers to the proofs of intrusion afforded by what they called the "un-erupted lavas" within the earth's crust, these observers lost sight of the possibility that some of these rocks might have been erupted at the surface, and might thus be chronicles of volcanic action in former geological periods. It is not always possible to satisfactorily discriminate between the two types of contemporaneously intercalated and subsequently injected material. But rocks of the former type have not broken into or involved the overlying strata, and they are usually marked by the characteristic structures of superficial lavas and by their association with volcanic tuffs. By

means of the evidence which they supply, it has been ascertained that volcanic action has been manifested in the globe since the earliest geological periods. In the British Isles, for example, the volcanic record is remarkably full for the long series of ages from Cambrian to Permian time, and again for the older Tertiary period.

2. SUBSEQUENTLY INDUCED STRUCTURES

After their accumulation, whether as stratified or eruptive masses, all kinds of rocks have been subject to various changes, and have acquired in consequence a variety of superinduced structures. It has been pointed out in the part of this article dealing with dynamical geology that one of the most important forms of energy in the evolution of geological processes is to be found in the movements that take place within the crust of the earth. Some of these movements are so slight as to be only recognizable by means of delicate instruments; but from this inferior limit they range up to gigantic convulsions by which mountain-chains are upheaved. The crust must be regarded as in a perpetual state of strain, and its component materials are therefore subject to all the effects which flow from that condition. It is the one great object of the geotectonic division of geology to study the structures which have been developed in consequence of earth-movements, and to discover from this investigation the nature of the processes whereby the rocks of the crust have been brought into the condition and the positions in which we now find them. The details of this subject will be found in separate articles descriptive of each of the technical terms applied to the several kinds of superinduced structures. All that need be offered here is a general outline connecting the several portions of the subject together.

One of the most universal of these later structures is to be seen in the divisional planes, usually vertical or highly inclined, by which rocks are split into quadrangular or irregularly shaped blocks. To these planes the name of joints has been given. They are of prime importance from an industrial point of view, seeing that the art of quarrying consists mainly in detecting and making proper use of them. Their abundance in all kinds of rocks, from those of recent date up to those of the highest antiquity, affords a remarkable testimony to the strains which the terrestrial crust has suffered. They have arisen sometimes from tension, such as that caused by contraction from the drying and consolidation of an aqueous sediment or from the cooling of a molten mass; sometimes from torsion during movements of the crust.

Although the stratified rocks were originally deposited in a more or less nearly horizontal position on the floor of the sea, where now visible on the dry land they are seldom found to have retained their flatness. On the contrary, they are seen to have been generally tilted up at various angles, sometimes even placed on end (crop, dip, strike). When a sufficiently large area of ground is examined, the inclination into which the strata have been thrown may be observed not to continue far in the same direction, but to turn over to the opposite or another quarter. It can then be seen that in reality the rocks have been thrown into undulations. From the lowest and flattest arches where the departure from horizontality may be only trifling, every step may be followed up to intense curvature, where the strata have been compressed and plicated as if they had been piles of soft carpets (anticline, syncline, monocline, geo-anticline, geo-syncline, isoclinal, plication, curvature, qua-quaversal). It has further happened abundantly all over the surface of the globe that relief from internal strain in the crust has been obtained by fracture, and the consequent subsidence or elevation of one or both sides of the fissure. The differential movement between the two sides may be scarcely perceptible in the feeblest dislocation, but in the extreme cases it may amount to many thousand feet (fault, fissure, dislocation, hade, slickensides). The great faults in a country are among its most important structural features, and as they not infrequently continue to be lines of weakness in the crust along which sudden slipping may from time to time take place, they become the lines of origin of earthquakes. The San Francisco earthquake of 1906, already cited, affords a memorable illustration of this connexion.

It is in a great mountain-chain that the extraordinary complication of plicated and faulted structures in the crust of the earth can be most impressively beheld. The combination of overturned folds with rupture has been already referred to as a characteristic feature in the Alps (Part IV.). The gigantic folds have in many places been pushed over each other so as to lie almost flat, while the upper limb has not infrequently been driven for many miles beyond the lower by a rupture along the axis. In this way successive slices of a thick series of formations have been carried northwards on the northern slope of the Alps, and have been piled so abnormally above each other that some of their oldest members recur several times on different thrust-planes, the whole being underlain by Tertiary

strata (see ALPS). Further proof of the colossal compression to which the rocks have been subjected is afforded by their intense crumpling and corrugation, and by the abundantly faulted and crushed condition to which they have been reduced. Similar evidence as to stresses in the terrestrial crust and the important changes which they produce among the rocks may also be obtained on a smaller scale in many non-mountainous countries.

Another marked result of the compression of the terrestrial crust has been induced in some rocks by the production of the fissile structure which is typically shown in roofing-slate (cleavage). Closely connected with this internal rearrangement has been the development of microscopic microfolies or crystals (rutile, mica, &c.) in argillaceous slates which were undoubtedly originally fine marine mud and silt. From this incipient form of metamorphism successive stages may be traced through the various kinds of argillite and phyllite into mica-schist, and thence into more crystalline gneissoid varieties (foliation, slate, mica-schist, gneiss). The Alps afford excellent illustrations of these transformations.

The fissures produced in the crust are sometimes clean, sharply defined divisional planes, like cracks across a pane of glass. Much more usually, however, the rocks on either side have been broken up by the friction of movement, and the fault is marked by a variable breadth of this broken material. Sometimes the walls have separated and molten rock has risen from below and solidified between them as a dike. Occasionally the fissures have opened to the surface, and have been filled in from above with detritus, as in the sandstone-dikes of Colorado and California. In mineral districts the fissures have been filled with various spars and ores, forming what are known as mineral veins.

Where one series of rocks is covered by another without any break or discordance in the stratification they are said to be conformable. But where the older series has been tilted up or visibly denuded before being overlain by the younger, the latter is termed unconformable. This relation is one of the greatest value in structural geology, for it marks a gap in the geological record, which may represent a vast lapse of time not there recorded by strata.

PART VI.—PALAEOLOGICAL GEOLOGY

This division of the science deals with fossils, or the traces of plants and animals preserved in the rocks of the earth's crust, and endeavours to gather from them information as to the history of the globe and its inhabitants. The term "fossil" (Lat. *fossilis*, from *fodere*, to dig up), meaning literally anything "dug up," was formerly applied indiscriminately to any mineral substance taken out of the earth's crust, whether organized or not. Since the time of Lamarck, however, the meaning of the word has been restricted, so as to include only the remains or traces of plants and animals preserved in any natural formation whether hard rock or superficial deposit. It includes not merely the petrified structures of organisms, but whatever was directly connected with or produced by these organisms. Thus the resin which was exuded from trees of long-perished forests is as much a fossil as any portion of the stem, leaves, flowers or fruit, and in some respects is even more valuable to the geologist than more determinable remains of its parent trees, because it has often preserved in admirable perfection the insects which flitted about in the woodlands. The burrows and trails of a worm preserved in sandstone and shale claim recognition as fossils, and indeed are commonly the only indications to be met with of the existence of aneolid life among old geological formations. The droppings of fishes and reptiles, called coprolites, are excellent fossils, and tell their tale as to the presence and food of vertebrate life in ancient waters. The little agglutinated cases of the caddis-worm remain as fossils in formations from which, perchance, most other traces of life may have passed away. Nay, the very handiwork of man, when preserved in any natural manner, is entitled to rank among fossils; as where his flint-implements have been dropped into the prehistoric gravels of river-valleys or where his canoes have been buried in the silt of lake-bottoms.

A study of the land-surfaces and sea-floors of the present time shows that there are so many chances against the conservation of the remains of either terrestrial or marine animals and plants that if, as is probable, the same conditions existed in former geological periods, we should regard the occurrence of organic remains among the stratified formations of the earth's crust as generally the result of various fortunate accidents.

Let us consider, in the first place, the chances for the preservation of remains of the present fauna and flora of a country. The surface of the land may be densely clothed with forest and abundantly peopled with animal life. But the trees die and moulder into soil.

The animals, too, disappear, generation after generation, and leave few or no perceptible traces of their existence. If we were not aware from authentic records that central and northern Europe were covered with vast forests at the beginning of our era, how could we know this fact? What has become of the herds of wild oxen, the bears, wolves and other denizens of primeval Europe? How could we prove from the examination of the surface soil of any country that those creatures had once abounded there? The conditions for the preservation of any relics of the plant and animal life of a terrestrial surface must obviously be always exceptional. They are supplied only where the organic remains can be protected from the air and superficial decay. Hence they may be observed in (1) the deposits on the floors of lakes; (2) in peat-mosses; (3) in deltas at river-mouths; and (4) under the stalagmite of caverns in limestone districts. But in these and other favourable places a mere infinitesimal fraction of the fauna or flora of a land-surface is likely to be entombed or preserved.

In the second place, although in the sea the conditions for the preservation of organic remains are in many respects more favourable than on land, they are apt to be frustrated by many adverse circumstances. While the level of the land remains stationary, there can be but little effective entombment of marine organisms in littoral deposits; for only a limited accumulation of sediment will be formed until subsidence of the sea-floor takes place. In the trifling beds of sand or gravel thrown up on a stationary shore, only the harder and more durable forms of life, such as gastropods and lamellibranchs, which can withstand the triturating effects of the beach waves, are likely to remain unscathed.

Below tide-marks, along the margin of the land where sediment is gradually deposited, the conditions are more favourable for the preservation of marine organisms. In the sheets of sand and mud there laid down the harder parts of many forms of life may be entombed and protected from decay. But only a small proportion of the total marine fauna may be expected to appear in such deposits. At the best, merely littoral and shallow-water forms will occur, and, even under the most favourable conditions, they will represent but a fraction of the whole assemblage of life in these juxta-terrestrial parts of the ocean. As we recede from the land the rate of deposition of sediment on the sea-floor must become feebler, until, in the remote central abysses, it reaches a hardly appreciable minimum. Except, therefore, where some kind of ooze or other deposit is accumulating in these more pelagic regions, the conditions must be on the whole unfavourable for the preservation of any adequate representation of the deep-sea fauna. Hard durable objects, such as teeth and bones, may slowly accumulate, and be protected by a coating of peroxide of manganese, or of some of the silicates now forming here and there over the deep-sea bottom; or the rate of growth of the abyssal deposit may be so tardy that most of the remains of at least the larger animals will disappear, owing to decay, before they can be covered up and preserved. Any such deep-sea formation, if raised into land, would supply but a meagre picture of the whole life of the sea.

It would thus appear that the portion of the sea-floor best suited for receiving and preserving the most varied assemblage of marine organic remains is the area in front of the land, to which rivers and currents bring continual supplies of sediment. The most favourable conditions for the accumulation of a thick mass of marine fossiliferous strata will arise when the area of deposit is undergoing a gradual subsidence. If the rate of depression and that of deposit were equal, or nearly so, the movement might proceed for a vast period without producing any great apparent change in marine geography, and even without seriously affecting the distribution of life over the sea-floor within the area of subsidence. Hundreds or thousands of feet of sedimentary strata might in this way be heaped up round the continents, containing a fragmentary series of organic remains belonging to those forms of comparatively shallow-water life which had hard parts capable of preservation. There can be little doubt that such has, in fact, been the history of the main mass of stratified formations in the earth's crust. By far the largest proportion of these piles of marine strata has unquestionably been laid down in water of no great depth within the area of deposit of terrestrial sediment. The enormous thickness to which they attain seems only explicable by prolonged and repeated movements of subsidence, interrupted, however, as we know, by other movements of a contrary kind.

Since the conditions for the preservation of organic remains exist more favourably under the sea than on land, marine organisms must be far more abundantly conserved than those of the land. This is true to-day, and has, as far as known, been true in all past geological time. Hence for the purposes of the geologist the fossil remains of marine forms of life far surpass all others in value. Among them there will necessarily be a gradation of importance, regulated chiefly by their relative abundance. Now, of all the marine tribes which live within the juxta-terrestrial belt of sedimentation, unquestionably the Mollusca stand in the place of pre-eminence as regards their aptitude for becoming fossils. They almost all possess a hard, durable shell, capable of resisting considerable abrasion and readily passing into a mineralized condition. They are extremely abundant both as to individuals and genera. They occur on the shore within tide mark, and range thence down into the abysses. Moreover, they appear to have possessed these qualifications from early geological

times. In the marine Mollusca, therefore, we have a common ground of comparison between the stratified formations of different periods. They have been styled the alphabet of palaeontological inquiry.

There are two main purposes to which fossils may be put in geological research. (1) to throw light upon former conditions of physical geography, such as the presence of land, rivers, lakes and seas, in places where they do not now exist, changes of climate, and the former distribution of plants and animals; and (2) to furnish a guide in geological chronology whereby rocks may be classified according to relative date, and the facts of geological history may be arranged and interpreted as a connected record of the earth's progress.

1. As examples of the first of these two directions of inquiry reference may be made to (a) former land-surfaces revealed by the occurrence of layers of soil with tree-stumps and roots still in the position of growth (see PURBECKIAN); (b) ancient lakes proved by beds of marl or limestone full of lacustrine shells; (c) old sea-bottoms marked by the occurrence of marine organisms; (d) variations in the quality of the water, such as freshness or saltiness, indicated by changes in the size and shape of the fossils; (e) proximity to former land, suggested by the occurrence of abundant drift-wood in the strata; (f) former conditions of climate, different from the present, as evidenced by such organisms as tropical types of plants and animals intercalated among the strata of temperate or northern countries.

2. In applying fossils to the determination of geological chronology it is first necessary to ascertain the order of superposition of the rocks. Obviously, in a continuous series of undisturbed sedimentary deposits the lowest must necessarily be the oldest, and the plants or animals which they contain must have lived and died before any of the organisms that occur in the overlying strata. This order of superposition having been settled in a series of formations, it is found that the fossils at the bottom are not quite the same as those at the top of the series. Tracing the beds upward, we discover that species after species of the lowest platforms disappears, until perhaps not one of them is found. With the cessation of these older species others make their entrance. These, in turn, are found to die out, and to be replaced by newer forms. After patient examination of the rocks, it has been ascertained that every well-marked "formation," or group of strata, is characterized by its own species or genera, or by a general assemblage, or *facies*, of organic forms. Such a generalization can only, of course, be determined by actual practical experience over an area of some size. When the typical fossils of a formation are known, they serve to identify that formation in its progress across a country. Thus, in tracts where the true order of superposition cannot be determined, owing to the want of sections or to the disturbed condition of the rocks, fossils serve as a means of identification and furnish a guide to the succession of the rocks. They even demonstrate that in some mountainous ground the beds have been turned completely upside down, where it can be shown that the fossils in what are now the uppermost strata ought properly to lie underneath those in the beds below them.

It is by their characteristic fossils that the stratified rocks of the earth's crust can be most satisfactorily subdivided into convenient groups of strata and classed in chronological order. Each "formation" is distinguished by its own peculiar assemblage of organic remains, by means of which it can be followed and recognized, even amid the crumplings and dislocations of a disturbed region. The same general succession of organic types can be observed over a large part of the world, though, of course, with important modifications in different countries. This similarity of succession has been termed *homotaxis*, a term which expresses the fact that the order in which the leading types of organized existence have appeared upon the earth has been similar even in widely separated regions. It is evident that, in this way, a reliable method of comparison is furnished, whereby the stratified formations of different parts of the earth's crust can be brought into relation with each other. Had the geologist continued to remain, as in the days of Werner, hampered by the limitations imposed by a reliance on mere lithological characters, he would have made little or no progress in deciphering the record of the successive phases of the history of the globe chronicled in the crust. Just as, at the present time, sheets of gravel in one place are contemporaneous with sheets of mud at another, so in the past all kinds of sedimentation have been in progress simultaneously, and those of one period may not be distinguishable in themselves from those of another. Little or no reliance can be placed upon lithological resemblances or differences in comparing the sedimentary formations of different countries.

In making use of fossil evidence for the purpose of subdividing the stratified rocks of the earth's crust, it is found to be applicable to the smaller details of stratigraphy as well as to the definition of large groups of strata. Thus a particular stratum may be marked by the occurrence in it of various fossils, one or more of which may be distinctive, either from occurring in no other bed above and below or from special abundance in that stratum. One or more of these species is therefore used as a guide to the occurrence of the bed

in question, which is called by the name of the most abundant species. In this way what is called a "geological horizon," or "zone," is marked off, and its exact position in the series of formations is fixed.

Perhaps the most distinctive feature in the progress of palaeontological geology during the last half century has been the recognition and wide application of this method of zonal stratigraphy, which, in itself, was only a further development of William Smith's famous idea, "Strata identified by Organized Fossils." It was first carried out in detail by various palaeontologists in reference to the Jurassic formations, notably by F. A. von Quenstedt and C. A. Oppel in Germany and A. D. d'Orbigny in France. The publication of Oppel's classic work *Die Juraformation Englands, Frankreichs und des südwestlichen Deutschlands* (1856-1858) marked an epoch in the development of stratigraphical geology. Combining what had been done by various observers with his own laborious researches in France, England, Württemberg and Bavaria, he drew up a classification of the Jurassic system, grouping its several formations into zones, each characterized by some distinctly predominant fossil after which it was named (see LIAS). The same method of classification was afterwards extended to the Cretaceous series by A. D. d'Orbigny, E. Hébert and others, until the whole Mesozoic rocks from the Trias to the top of the Chalk has now been partitioned into zones, each named after some characteristic species or genus of fossils. More recently the principle has been extended to the Palaeozoic formations, though as yet less fully than to the younger parts of the geological record. It has been successfully applied by Professor C. Lapworth to the investigation of the Silurian series (see SILURIAN; ORDOVICIAN SYSTEM). He found that the species of graptolites have each a comparatively narrow vertical range, and they may consequently be used for stratigraphical purposes. Applying the method, in the first instance, to the highly plicated Silurian rocks of the south of Scotland, he found that by means of graptolites he was able to work out the structure of the ground. Each great group of strata was seen to possess its own graptolitic zones, and by their means could be identified not only in the original complex Scottish area, but in England and Wales and in Ireland. It was eventually ascertained that the succession of zones in Great Britain could be recognized on the Continent, in North America and even in Australia. The brachiopods and trilobites have likewise been made use of for zonal purposes among the oldest sedimentary formations. The most ancient of the Palaeozoic systems has as its fitting base the *Olendulus* zone.

Within undefined and no doubt variable geographical limits palaeontological zones have been found to be remarkably persistent. They follow each other in the same general order, but not always with equal definiteness. The type fossil may appear in some districts on a higher or a lower platform than it does in others. Only to a limited degree is there any coincidence between lithological variations in the strata and the sequence of the zones. In the Jurassic formations, indeed, where frequent alternations of different sedimentary materials are to be met with, it is in some cases possible to trace a definite upward or downward limit for a zone by some abrupt change in the sedimentation, such as from limestone to shale. But such a precise demarcation is impossible where no distinct bands of different sediments are to be seen. The zones can then only be vaguely determined by finding their characteristic fossils, and noting where these begin to appear in the strata and where they cease. It would seem, therefore, that the sequence of palaeontological zones, or life-horizons, has not depended merely upon changes in the nature of the conditions under which the organisms lived. We should naturally expect that these changes would have had a marked influence: that, for instance, a difference should be perceptible between the character of the fossils in a limestone and that of those in a shale or a sandstone. The environment, when a limestone was in course of deposition, would generally be one of clear water, favourable for a more vigorous and more varied fauna than where a shale series was accumulating, when the water would be discoloured, and only such animals would continue to live in it, or on the bottom, as could maintain themselves in the midst of mud. But no such lithological reason, betokening geographical changes that would affect living creatures, can be adduced as a universally applicable explanation of the occurrence and limitation of palaeontological zones. One of these zones may be only a few inches, or feet or yards in vertical extent, and no obvious lithological or other cause can be seen why its specially characteristic fossils should not be found just as frequently in the similar strata above and below. There is often little or no evidence of any serious change in the conditions of sedimentation, still less of any widespread physical disturbance, such as the catastrophes by which the older geologists explained the extinction of successive types of life.

It has been suggested that, where the life-zones are well defined, sedimentation has been extremely slow, and that though these zones follow each other with no break in the sedimentation, they were really separated by prolonged intervals of time during which organic evolution could come effectively into play. But it is not easy to explain how, for example in the Lower Lias, there could have been a succession of prodigious intervals, when practically no sediment was laid down, and yet that the strata should show no sign of con-

temporaneous disturbance or denudation, but succeed each other as if they had been accumulated by one continuous process of deposit. It must be admitted that the problem of life-zones in stratigraphical geology has not yet been solved.

As Darwin first cogently showed, the history of life has been very imperfectly registered in the stratified parts of the earth's crust. Apart from the fact that, even under the most favourable conditions, only a small proportion of the total flora and fauna of any period would be preserved in the fossil state, enormous gaps occur where no record has survived at all. It is as if whole chapters and books were missing from a historical work. Some of these lacunae are sufficiently obvious. Thus, in some cases, powerful dislocations have thrown considerable portions of the rocks out of sight. Sometimes extensive metamorphism has so affected them that their original characters, including their organic contents, have been destroyed. Oftenest of all, denudation has come into play, and vast masses of fossiliferous rock have been entirely worn away, as is demonstrated by the abundant unconformabilities in the structure of the earth's crust.

While the mere fact that one series of rocks lies unconformably on another proves the lapse of a considerable interval between their respective dates, the relative length of this interval may sometimes be proved by means of fossil evidence, and by this alone. Let us suppose, for example, that a certain group of formations has been disturbed, upraised, denuded and covered unconformably by a second group. In lithological characters the two may closely resemble each other, and there may be nothing to show that the gap represented by their unconformability is of an important character. In many cases, indeed, it would be quite impossible to pronounce any well-grounded judgment as to the amount of interval, even measured by the vague relative standards of geological chronology. But if each group contains a well-preserved suite of organic remains, it may not only be possible, but easy, to say exactly how much of the geological record has been left out between the two sets of formations. By comparing the fossils with those obtained from regions where the geological record is more complete, it may be ascertained, perhaps, that the lower rocks belong to a certain platform or stage in geological history which for our present purpose we may call D, and that the upper rocks can in like manner be paralleled with stage H. It would be then apparent that at this locality the chronicles of three great geological periods E, F, and G were wanting, which are elsewhere found to be intercalated between D and H. The lapse of time represented by this unconformability would thus be equivalent to that required for the accumulation of the three missing formations in those regions where sedimentation was more continuous.

Fossil evidence may be made to prove the existence of gaps which are not otherwise apparent. As has been already remarked, changes in organic forms must, on the whole, have been extremely slow in the geological past. The whole species of a sea-floor could not pass entirely away, and be replaced by other forms, without the lapse of long periods of time. If then among the conformable stratified formations of former ages we encounter sudden and abrupt changes in the *facies* of the fossils, we may be certain that these must mark omissions in the record, which we may hope to fill in from a more perfect series elsewhere. The complete biological contrasts between the fossil contents of unconformable strata are sufficiently explicable. It is not so easy to give a satisfactory account of those which occur where the beds are strictly conformable, and where no evidence can be observed of any considerable change of physical conditions at the time of deposit. A group of strata having the same general lithological characters throughout may be marked by a great discrepancy between the fossils above and below a certain line. A few species may pass from the one into the other, or perhaps every species may be different. In cases of this kind, when proved to be not merely local but persistent over wide areas, we must admit, notwithstanding the apparently undisturbed and continuous character of the original deposition of the strata, that the abrupt transition from the one *facies* of fossils to the other represents a long interval of time which has not been recorded by the deposit of strata. A. C. Ramsay, who called attention to these gaps, termed them "breaks in the succession of organic remains." He showed that they occur abundantly among the Palaeozoic and Secondary rocks of England. It is obvious, of course, that such breaks, even though traceable over wide regions, were not general over the whole globe. There have never been any universal interruptions in the continuity of the chain of being, so far as geological evidence can show. But the physical changes which caused the breaks may have been general over a zoological district or minor region. They no doubt often caused the complete extinction of genera and species which had a small geographical range.

From all these facts it is clear that the geological record, as it now exists, is at the best but an imperfect chronicle of geological history. In no country is it complete. The lacunae of one region must be supplied from another. Yet in proportion to the geographical distance between the localities where the gaps occur and those whence the missing intervals are supplied, the element of uncertainty in our reading of the record is increased. The most desirable method of research is to exhaust the evidence for each area or province, and to compare the general order of its succession as a whole with that which can be established for other provinces.

PART VII.—STRATIGRAPHICAL GEOLOGY

This branch of the science arranges the rocks of the earth's crust in the order of their appearance, and interprets the sequence of events of which they form the records. Its province is to cull from the other departments of geology the facts which may be needed to show what has been the progress of our planet, and of each continent and country, from the earliest times of which the rocks have preserved any memorial. Thus from mineralogy and petrography it contains information regarding the origin and subsequent mutations of minerals and rocks. From dynamical geology it learns by what agencies the materials of the earth's crust have been formed, altered, broken, upheaved and melted. From geotectonic geology it understands the various processes whereby these materials were put together so as to build up the complicated crust of the earth. From palaeontological geology it receives in well-determined fossil remains a clue by which to discriminate the different stratified formations, and to trace the grand onward march of organized existence upon this planet. Stratigraphical geology thus gathers up the sum of all that is made known by the other departments of the science, and makes it subservient to the interpretation of the geological history of the earth.

The leading principles of stratigraphy may be summed up as follows:

1. In every stratigraphical research the fundamental requisite is to establish the order of superposition of the strata. Until this is accomplished it is impossible to arrange the dates, and make out the sequence of geological history.

2. The stratified portion of the earth's crust, or what has been called the "geological record," can be subdivided into natural groups, or series of strata, characterized by distinctive organic remains and recognizable by these remains, in spite of great changes in lithological character from place to place. A bed, or a number of beds, linked together by containing one or more distinctive species or genera of fossils is termed a *zone* or *horizon*, and usually bears the name of one of its more characteristic fossils, as the *Planorbis*-zone of the Lower Lias, which is so called from the prevalence in it of the ammonite *Psiloceras planorbis*. Two or more such zones related to each other by the possession of a number of the same characteristic species or genera have been designated *beds* or an *assise*. Two or more sets of beds or assises similarly related form a *group* or *stage*; a number of groups or stages make a *series*, *formation* or *section*, and a succession of formations may be united into a *system*.

3. Some living species of plants and animals can be traced downwards through the more recent geological formations; but the number which can be so followed grows smaller as the examination is pursued into more ancient deposits. With their disappearance other species or genera present themselves which are no longer living. These in turn may be traced backward into earlier formations, till they too cease and their places are taken by yet older forms. It is thus shown that the stratified rocks contain the records of a gradual progression of organic forms. A species which has once died out does not seem ever to have reappeared.

4. When the order of succession of organic remains among the stratified rocks has been determined, they become an invaluable guide in the investigation of the relative age of rocks and the structure of the land. Each zone and formation, being characterized by its own species or genera, may be recognized by their means, and the true succession of strata may thus be confidently established even in a country wherein the rocks have been shattered by dislocation, folded, inverted or metamorphosed.

5. Though local differences exist in regard to the precise zone in which a given species of organism may make its first appearance, the general order of succession of the organic forms found in the rocks is never inverted. The record is nowhere complete in any region, but the portions represented, even though extremely imperfect, always follow each other in their proper chronological order, unless where disturbance of the crust has intervened to destroy the original sequence.

6. The relative chronological value of the divisions of the

geological record is not to be measured by mere depth of strata. While it may be reasonably assumed that, in general, a great thickness of stratified rock must mark the passage of a long period of time, it cannot safely be affirmed that a much less thickness elsewhere must represent a correspondingly diminished period. The need for this caution may sometimes be made evident by an unconformability between two sets of rocks, as has already been explained. The total depth of both groups together may be, say 1000 ft. Elsewhere we may find a single unbroken formation reaching a depth of 10,000 ft.; but it would be unwarrantable to assume that the latter represents ten times the length of time indicated by the former two. So far from this being the case, it might not be difficult to show that the minor thickness of rock really denotes by far the longer geological interval. If, for instance, it could be proved that the upper part of both the sections lies on one and the same geological platform, but that the lower unconformable series in the one locality belongs to a far lower and older system of rocks than the base of the thick conformable series in the other, then it would be clear that the gap marked by the unconformability really indicates a longer period than the massive succession of deposits.

7. Fossil evidence furnishes the chief means of comparing the relative value of formations and groups of rock. A "break in the succession of organic remains," as already explained, marks an interval of time often unrepresented by strata at the place where the break is found. The relative importance of these breaks, and therefore, probably, the comparative intervals of time which they mark, may be estimated by the difference of the *facies* or general character of the fossils on each side. If, for example, in one case we find every species to be dissimilar above and below a certain horizon, while in another locality only half of the species on each side are peculiar, we naturally infer, if the total number of species seems large enough to warrant the inference, that the interval marked by the former break was much longer than that marked by the second. But we may go further and compare by means of fossil evidence the relation between breaks in the succession of organic remains and the depth of strata between them.

Three formations of fossiliferous strata, A, C, and H, may occur conformably above each other. By a comparison of the fossil contents of all parts of A, it may be ascertained that, while some species are peculiar to its lower, others to its higher portions, yet the majority extend throughout the formation. If now it is found that of the total number of species in the upper portion of A only one-third passes up into C, it may be inferred with some plausibility that the time represented by the break between A and C was really longer than that required for the accumulation of the whole of the formation A. It might even be possible to discover elsewhere a thick intermediate formation B filling up the gap between A and C. In like manner were it to be discovered that, while the whole of the formation C is characterized by a common suite of fossils, not one of the species and only one half of the genera pass up into H, the inference could hardly be resisted that the gap between the two formations marks the passage of a far longer interval than was needed for the deposition of the whole of C. And thus we reach the remarkable conclusion that, thick though the stratified formations of a country may be, in some cases they may not represent so long a total period of time as do the gaps in their succession,—in other words, that non-deposition was more frequent and prolonged than deposition, or that the intervals of time which have been recorded by strata have not been so long as those which have not been so recorded.

In all speculations of this nature, however, it is necessary to reason from as wide a basis of observation as possible, seeing that so much of the evidence is negative. Especially needful is it to bear in mind that the cessation of one or more species at a certain line among the rocks of a particular district may mean nothing more than that, onward from the time marked by that line, these species, owing to some change in the conditions of life, were compelled to migrate or became locally extinct or, from some alteration in the conditions of fossilization, were no longer imbedded and preserved as fossils. They may have continued to flourish abundantly in neighbouring districts for a long period afterward. Many examples of this obvious truth might be cited. Thus in a great succession of mingled marine, brackish-water and terrestrial strata, like that of the Carboniferous Limestone series of Scotland, corals, crinoids

and brachiopods abound in the limestones and accompanying shales, but disappear as the sandstones, ironstones, clays, coals and bituminous shales supervene. An observer meeting for the first time with an instance of this disappearance, and remembering what he had read about breaks in succession, might be tempted to speculate about the extinction of these organisms, and their replacement by other and later forms of life, such as the ferns, lycopods, estuarine or fresh-water shells, ganoid fishes and other fossils so abundant in the overlying strata. But further research would show him that high above the plant-bearing sandstones and coals other limestones and shales might be observed, once more charged with the same marine fossils as before, and still farther overlying groups of sandstones, coals and carbonaceous beds followed by yet higher marine limestones. He would thus learn that the same organisms, after being locally exterminated, returned again and again to the same area. After such a lesson he would probably pause before too confidently asserting that the highest bed in which we can detect certain fossils marks their final appearance in the history of life. Some breaks in the succession may thus be extremely local, one set of organisms having been driven to a different part of the same region, while another set occupied their place until the first was enabled to return.

8. The geological record is at the best but an imperfect chronicle of the geological history of the earth. It abounds in gaps, some of which have been caused by the destruction of strata owing to metamorphism, denudation or otherwise, others by original non-deposition, as above explained. Nevertheless from this record alone can the progress of the earth be traced. It contains the registers of the appearance and disappearance of tribes of plants and animals which have from time to time flourished on the earth. Only a small proportion of the total number of species which have lived in past time have been thus chronicled, yet by collecting the broken fragments of the record an outline at least of the history of life upon the earth can be deciphered.

It cannot be too frequently stated, nor too prominently kept in view, that, although gaps occur in the succession of organic remains as recorded in the rocks, they do not warrant the conclusion that any such blank intervals ever interrupted the progress of plant and animal life upon the globe. There is every reason to believe that the march of life has been unbroken, onward and upward. Geological history, therefore, if its records in the stratified formations were perfect, ought to show a blending and gradation of epoch with epoch. But the progress has been constantly interrupted, now by upheaval, now by volcanic outbursts, now by depression. These interruptions serve as natural divisions in the chronicle, and enable the geologist to arrange his history into periods. As the order of succession among stratified rocks was first made out in Europe, and as many of the gaps in that succession were found to be widespread over the European area, the divisions which experience established for that portion of the globe came to be regarded as typical, and the names adopted for them were applied to the rocks of other and far distant regions. This application has brought out the fact that some of the most marked breaks in the European series do not exist elsewhere, and, on the other hand, that some portions of that series are much more complete than the corresponding sections in other regions. Hence, while the general similarity of succession may remain, different subdivisions and nomenclature are required as we pass from continent to continent.

The nomenclature adopted for the subdivisions of the geological record bears witness to the rapid growth of geology. It is a patch-work in which no system nor language has been adhered to, but where the influences by which the progress of the science has been moulded may be distinctly traced. Some of the earliest names are lithological, and remind us of the fact that mineralogy and petrography preceded geology in the order of birth—Chalk, Oolite, Greensand, Millstone Grit. Others are topographical, and often recall the labours of the early geologists of England—London Clay, Oxford Clay, Purbeck, Portland, Kimmeridge beds. Others are taken from local English provincial names; and

remind us of the debt we owe to William Smith, by whom so many of them were first used—Lias, Gault, Crag, Cornbrash. Others of later date recognize an order of superposition as already established among formations—Old Red Sandstone, New Red Sandstone. By common consent it is admitted that names taken from the region where a formation or group of rocks is typically developed are best adapted for general use. Cambrian, Silurian, Devonian, Permian, Jurassic are of this class, and have been adopted all over the globe.

But whatever be the name chosen to designate a particular group of strata, it soon comes to be used as a chronological or homotaxial term, apart altogether from the stratigraphical character of the strata to which it is applied. Thus we speak of the Chalk or Cretaceous system, and embrace under that term formations which may contain no chalk; and we may describe as Silurian a series of strata utterly unlike in lithological characters to the formations in the typical Silurian country. In using these terms we unconsciously allow the idea of relative date to arise prominently before us. Hence such a word as "chalk" or "cretaceous" does not suggest so much to us the group of strata so called as the interval of geological history which these strata represent. We speak of the Cretaceous, Jurassic, and Cambrian periods, and of the Cretaceous fauna, the Jurassic flora, the Cambrian trilobites, as if these adjectives denoted simply epochs of geological time.

The stratified formations of the earth's crust, or geological record, are classified into five main divisions, which in their order of antiquity are as follows: (1) Archean or Pre-Cambrian, called also sometimes Azoic (lifeless) or Eozoic (dawn of life); (2) Palaeozoic (ancient life) or Primary; (3) Mesozoic (middle life) or Secondary; (4) Cainozoic (recent life) or Tertiary; (5) Quaternary or Post-Tertiary. These divisions are further ranged into systems, formations, groups or stages, assises and zones. Accounts of the various subdivisions named are given in separate articles under their own headings. In order, however, that the sequence of the formations and their parallelism in Europe and North America may be presented together a stratigraphical table is given on next page.

PART VIII.—PHYSIOGRAPHICAL GEOLOGY

This department of geological inquiry investigates the origin and history of the present topographical features of the land. As these features must obviously be related to those of earlier time which are recorded in the rocks of the earth's crust, they cannot be satisfactorily studied until at least the main outlines of the history of these rocks have been traced. Hence physio-graphical research comes appropriately after the other branches of the science have been considered.

From the stratigraphy of the terrestrial crust we learn that by far the largest part of the area of dry land is built up of marine formations; and therefore that the present land is not an aboriginal portion of the earth's surface, but has been overspread by the sea in which its rocks were mainly accumulated. We further discover that this submergence of the land did not happen once only, but again and again in past ages and in all parts of the world. Yet although the terrestrial areas varied much from age to age in their extent and in their distribution, being at one time more continental, at another more insular, there is reason to believe that these successive diminutions and expansions have on the whole been effected within, or not far outside, the limits of the existing continents. There is no evidence that any portion of the present land ever lay under the deeper parts of the ocean. The abyssal deposits of the ocean-floor have no true representatives among the sedimentary formations anywhere visible on the land. Nor, on the other hand, can it be shown that any part of the existing ocean abysses ever rose above sea-level into dry land. Hence geologists have drawn the inference that the ocean basins have probably been always where they now are; and that although the continental areas have often been narrowed by submergence and by denudation, there has probably seldom or never been a complete

The Geological Record or Order of Succession of the Stratified Formations of the Earth's Crust.

	Europe.	North America.
Recent, Quaternary or Post-Tertiary.	Historic, up to the present time. Pleistocene, comprising deposits of the Iron, Bronze, and later Stone Ages. Neolithic—aluminum, peat, lake-deposits, loess, &c. Palaeolithic—river-gravels, cave-deposits, &c.	Similar to the European development, but with scantier traces of the presence of man.
Quaternary or Post-Tertiary.	Older Loess and valley-gravels; cave-deposits. Strand-lines or raised beaches; youngest moraines. Upper Boulder-clays; eskers; marine sands and clays. Interglacial deposits. Lower boulder-clay or Till, with striated rock-surfaces below.	As in Europe, it is hardly possible to assign a definite chronological place to each of the various deposits of this period, terrestrial and marine. They generally resemble the European series. The characteristic marine, fluviatile and lacustrine terraces, which overlie the older drifts, have been classed as the Champlain Group.
Pliocene.	Newer—English Forest-Bed Group; Red and Norwich Crags; Amstelien and Scaevanien groups of Belgium and Holland; Sicilian and Asian of France and Italy. Older—English Coralline Crags; Diestian of Belgium; Flaminian of southern France and Italy.	On the Atlantic border represented by the marine Floridan series; in the interior by a subarctic and lacustrine series; and on the Pacific border by the thick marine series of San Francisco.
Miocene.	Wanting in Britain, well developed in France, S. E. Europe and Italy; divisible into the following groups in descending order: (1) Pannonian, (2) Sarmatian; (3) Tortonian; (4) Helvetian; (5) Langhian (Burdigalian).	Represented in the Eastern States by a marine series (Yorktown or Chesapeake, Chipola and Chattahoochee groups), and in the interior by the lacustrine Lower York (Nebraska), Deep River, and John Day groups.
Cainozoic or Tertiary.	In Britain the "fluvi-marine series" of the Isle of Wight; also the volcanic plateaus of Antrim and Inver Hebrides and those of the Faeroe Isles and Iceland. In continental Europe the following subdivisions have been established in descending order: (1) Aquitanian, (2) Stampian (Rupelian), (3) Tourain (Sannoisian).	On the Atlantic border no equivalents have been satisfactorily recognised, but on the Pacific side there are marine deposits in N. W. Oregon, which may represent this division. In the interior the equivalent is believed to be the fresh-water White River series, including (1) Pteroceras beds, (2) Orondro beds, and (3) Tansiterian beds.
Eocene.	Barton sands and clays; Ludian series of France. Bracklesham Beds; Lutetian (Calcaire grossier and Ligassien) of Paris basin. London clay, Woolwich and Reading Beds; Thuret sands; Ypresian or Londinian of N. France and Belgium; Sparnacian and Thanetian groups.	Woodstock and Aquia Creek groups of Potomac River; Vicksburg, Jackson, Claiborne, Bullrunstone, and Lignite groups of Mississippi. In the interior a thick series of fresh-water formations, comprising in descending order the Uinta, Bridger, Wind River, Wasatch, Torrejon, and Puerco groups. On the Pacific side the marine Tertiary series of Oregon and California.
Upper.	Danian—wanting in Britain; uppermost limestone of Denmark. Senonian—Upper Chalk with Flints of England; Atrian and Emscherian stages on the European continent. Turonian—Middle Chalk with few flints, and comprising the Angouman and Ligurian stages. Cenomanian—Lower Chalk and Chalk Marl. Albian—Upper Greensand and Gault. Aptian—Lower Greensand; Marls and limestones of Provence, &c. Urgonian (Barremian)—Atherfield clay; massive Hippurite limestones of southern France. Neocomian—Weald clay and Hastings sand; Hauterivian and Valanginian sub-stages of Switzerland and France.	On the Atlantic border both marine strata and others containing a terrestrial flora represent the Cretaceous series of formations. In the interior there is also a commingling of marine with lacustrine deposits. At the top lies the Laramie or Lignitic series with an abundant terrestrial flora, passing down into the lacustrine and brackish-water Montana series. Of older date, the Colorado series contains an abundant marine fauna, yet includes also some coal-seams. The Niobrara marls and limestones are likewise of marine origin, but the lower members of the series (Neuton and Dakota) show another great representation of fresh-water sedimentation with lignites and coals. In California a vast succession of marine deposits (Stasatic) represents the Cretaceous system; and in western British N. America coal-seams also occur.
Lower.	Furberian—Furber beds; Munder Mergel; largely present in Westphalia. Portlandian—Portland group of England, represented in S. France by the thick Tithonian limestones. Kimmeridgian—Kimmeridge Clay of England; Virgulfan and Purocervian groups of N. France; represented by thick limestones in the Mediterranean basin.	Representatives of the Middle and lower Jurassic formations have been found in California and Oregon, and farther north among the Arctic islands. Strata containing Lower Jurassic marine fossils appear in Wyoming and Dakota; and above them come the <i>Altonian</i> series and <i>Bejstadesen</i> beds.
Mesozoic or Secondary.		

	Europe.	North America.
Archaean, Pre-Cambrian, Eozoic.	Corallian—Coral Rag, Coralline Oolite; Sequanian stages of the Continent, comprising the sub-stages of Arturian and Rauracian. Oxfordian—Oxford Clay; Argovian and Nouvagian stages of the Alps. Calliovan—Keltways Rock, Divisian sub-stage of N. France. Balboian—series of English strata from Corallian down to Fuller's Earth. Bajocian—Inferior Oolite of England. Liasic—divisible into (1) Upper Lias or Toarcian, (2) Middle Lias, Marlstone or Charmouthian, (3) Lower Lias of Sineaurian and Hettangian.	which have yielded no large variety of stenosauria and other vertebrates, and especially the remains of a number of genera of small mammals.
Mesozoic or Secondary—continued.		
Jurassic—continued.		
Triassic.	In Germany and western Europe this division represents the deposits of inland seas or lagoons, and is divisible into the following stages in descending order: (1) Rhetic, (2) Keuper, (3) Muschelkalk, (4) Bunter. In the eastern Alps and the Mediterranean basin the contemporaneous sedimentary formations are those of open clear sea, in which a thickness of many thousand feet of strata was accumulated.	In New York, Connecticut, New Brunswick, and Nova Scotia a series of red sandstone (Newark series) contains lund-formations, and labyrinthine basins like the lagoon type of central and western Europe. On the Pacific slope, however, such equivalents occur, representing the pelagic type of south-eastern Europe.
Permian.	Thuringian—Zechstein, Magnesian Limestone, named from its development in Thuringia; well represented also in Saxony, Bavaria and Bohemia. Saxonian—Rochlitzes Group; Red Sandstones, &c. Arturian—where the strata present the lagoon facies, well displayed at Artun in France, where the marine type is predominant; in Russia, the group has been termed Artinskian.	To this division of the geological record the Upper Barnes Measures of the coal-fields of Pennsylvania, Prince Edward Island, Nova Scotia and New Brunswick have been assigned. Farther south in Kansas, Texas, and Nebraska the representatives of this division have an abundant marine fauna.
Carboniferous.	Stephanian or Uralian—represented in Russia by marine formations, and in central and western Europe by numerous small basins containing a peculiar flora and in some places a great variety of insects. Westphalian or Moscovian—Coal-measures, Malsste Grit. Calm or Dinorthis—Carboniferous Limestone and Califerous Sandstone series.	Upper productive Coal-measures. Lower barren measures. Lower productive Coal-measures. Potsville conglomerate. Mauch Chunk shales; limestones of Chester, St Louis, &c. Pocahontas series; Kinderhook limestone.
Devonian and Old Red Sandstone.	Devonian type. Old Red Sandstone type. Upper { Frasnian. Yellow and red sandstone with <i>Holoptychus</i> , <i>Bolotidopsis</i> , &c. Middle { Givetian. Caithness Flagstones with <i>Onitolepis</i> , <i>Diplopterus</i> , <i>Homonotus</i> , &c. Eifelian. Red and purple sandstones and conglomerates with <i>Cephalospira</i> , <i>Pterospira</i> , &c. Lower { Coblenzian. Red and purple sandstones and conglomerates with <i>Cephalospira</i> , <i>Pterospira</i> , &c. Gerdanian.	{ Catskill red sandstone; Old Red Sandstone type; the strata below show the Devonian type. Chemung Group, Genesee. { Hamilton Group. { Marcellus. { Corniferous Limestone. { Onondaga Limestone. { Oriskany Sandstone. { Upper Heiderberg Group.
Silurian.	Upper { Ludlow Group. { Wenlock. { Llandovery. Lower { Caradoc or Bala Group. { Llandello. { Arenig.	{ Lower Heiderberg Group. { Water-Lime. { Niagara Shale and Limestone. { Clinton Group. { Medina. { Cincinnati Group. { Utica. { Trenton. { Chazy. { Califerous.
Cambrian.	Upper or <i>Olenus</i> series—Tremadoc slates and <i>Lingula</i> flags. Middle or <i>Paradoxides</i> series—Menavian Group. Lower or <i>Olenoides</i> series—Llanberis and Harlech Group, and <i>Olenella</i> zone.	Upper or Potsdam series with <i>Olenus</i> and <i>Discoscaphus</i> fauna. Middle or Acadian series with <i>Paradoxides</i> fauna. Lower or Georgian series with <i>Olenoides</i> fauna.
Archaean, Pre-Cambrian, Eozoic.	In Scotland, underneath the Cambrian <i>Olenoides</i> group, lies unconformably a mass of red sandstone and conglomerate (Torridonian) 5000 or 50,000 ft. thick, which rests with a strong unconformability on a series of coarse gneisses and schists (Lewisian). A thick series of slates and phyllites lies below the oldest Palaeozoic rocks in central Europe, with coarse gneisses below.	In Canada and the Lake Superior region of the United States a vast succession of rocks of Pre-Cambrian age has been grouped into the following subdivisions in descending order: (1) Keweenaw, lying unconformably on (2) Anticline, separated by a strong unconformability from (3) Upper Huronian, (4) Lower Huronian with an unconformable base, (5) Gortchiching, (6) Laurentian. In the eastern part of Canada, Newfoundland, &c., and also in Missouri, sedimentary formations of great thickness below the lowest Cambrian zone have been found to contain some obscure organisms.

disappearance of land. The fact that the sedimentary formations of each successive geological period consist to so large an extent of mechanically formed terrigenous detritus, affords good evidence of the coexistence of tracts of land as well as of extensive denudation.

From these general considerations we proceed to inquire how the existing topographical features of the land arose. Obviously the co-operation of the two great geological agencies of hypogene and epigene energy, which have been at work from the beginning of our globe's decipherable history, must have been the cause to which these features are to be assigned; and the task of the geologist is to ascertain, if possible, the part that has been taken by each. There is a natural tendency to see in a stupendous piece of scenery, such as a deep ravine, a range of hills, a line of precipice or a chain of mountains, evidence only of subterranean convulsion; and before the subject was taken up as a matter of strict scientific induction, an appeal to former cataclysms was considered a sufficient solution of the problems presented by such features of landscape. The rise of the modern Huttonian school, however, led to a more careful examination of these problems. The important share taken by erosion in the determination of the present features of landscape was then recognized, while a fuller appreciation of the relative parts played by the hypogene and epigene causes has gradually been reached.

1. The study of the progress of denudation at the present time has led to the conclusion that even if the rate of waste were not more rapid than it is to-day, it would yet suffice in a comparatively brief geological period to reduce the dry land to below the sea-level. But not only would the area of the land be diminished by denudation, it could hardly fail to be more or less involved in those widespread movements of subsidence, during which the thick sedimentary formations of the crust appear to have been accumulated. It is thus manifest that there must have been from time to time during the history of our globe upward movements of the crust, whereby the balance between land and sea was redressed. Proofs of such movements have been abundantly preserved among the stratified formations. We there learn that the uplifts have usually followed each other at long intervals between which subsidence prevailed, and thus that there has been a prolonged oscillation of the crust over the great continental areas of the earth's surface.

An examination of that surface leads to the recognition of two great types of upheaval. In the one, the sea-floor, with all its thick accumulations of sediment, has been carried upwards, sometimes for several thousand feet, so equably that the strata retain their original flatness with hardly any sensible disturbance for hundreds of square miles. In the other type the solid crust has been plicated, corrugated and dislocated, especially along particular lines, and has attained its most stupendous disruption in lofty chains of mountains. Between these two phases of uplift many intermediate stages have been developed, according to the direction and intensity of the subterranean force and the varying nature and disposition of the rocks of the crust.

(a) Where the uplift has extended over wide spaces, without appreciable deformation of the crust, the flat strata have given rise to low plains, or if the amount of uprise has been great enough, to high plains, plateaux or tablelands. The plains of Russia, for example, lie for the most part on such tracts of equably uplifted strata. The great plains of the western interior of the United States form a great plateau or tableland, 5000 or 6000 ft. above the sea, and many thousands of square miles in extent, on which the Rocky Mountains have been ridged up.

(b) It is in a great mountain-chain that the complicated structures developed during disturbances of the earth's crust can best be studied (see Parts IV. and V. of this article), and where the influence of these structures on the topography of the surface is most effectively displayed. Such a chain may be the result of one colossal disturbance; but those of high geological antiquity usually furnish proofs of successive uplifts with more or less intervening denudation. Formed along lines of continental displacement in the crust, they have again and again given

relief from the strain of compression by fresh crumpling, fracture and uprise. The chief guide in tracing these successive stages of growth is supplied by unconformability. If, for example, a mountain-range consists of upraised Silurian rocks, upon the upturned and denuded edges of which the Carboniferous Limestone lies transgressively, it is clear that its original upheaval must have taken place in the period of geological time represented by the interval between the Silurian and the Carboniferous Limestone formations. If, as the range is followed along its course, the Carboniferous Limestone is found to be also highly inclined and covered unconformably by the Upper Coal-measures, a second uplift of that portion of the ground can be proved to have taken place between the time of the Limestone and that of the Upper Coal-measures. By this simple and obvious kind of evidence the relative ages of different mountain-chains may be compared. In most great chains, however, the rocks have been so intensely crumpled, and even inverted, that much labour may be required before their true relations can be determined.

The Alps furnish an instructive example of the long series of revolutions through which a great mountain-system may have passed before reaching its present development. The first beginnings of the chain may have been upraised before the oldest Palaeozoic formations were laid down. There are at least traces of land and shore-lines in the Carboniferous period. Subsequent submergences and uplifts appear to have occurred during the Mesozoic periods. There is evidence that thereafter the whole region sank deep under the sea, in which the older Tertiary sediments were accumulated, and which seems to have spread right across the heart of the Old World. But after the deposition of the Eocene formations came the gigantic disruptions whereby all the rocks of the Alpine region were folded over each other, crushed, corrugated, fractured and displaced, some of their older portions, including the fundamental gneisses and schists, being squeezed up, torn off, and pushed horizontally for many miles over the younger rocks. But this upheaval, though the most momentous, was not the last which the chain has undergone, for at a later epoch in Tertiary time renewed disturbance gave rise to a further series of ruptures and plications. The chain thus successively upheaved has been continuously exposed to denudation and has consequently lost much of its original height. That it has been left in a state of instability is indicated by the frequent earthquakes of the Alpine region, which doubtless arise from the sudden snapping of rocks under intense strain.

A distinct type of mountain due to direct hypogene action is to be seen in a volcano. It has been already pointed out (Part IV. sect. 1) that at the vents which maintain a communication between the molten magma of the earth's interior and the surface, eruptions take place whereby quantities of lava and fragmentary materials are heaped round each orifice of discharge. A typical volcanic mountain takes the form of a perfect cone, but as it grows in size and its main vent is choked, while the sides of the cone are unable to withstand the force of the explosions or the pressure of the ascending column of lava, eruptions take place laterally, and numerous parasitic cones arise on the flanks of the parent mountain. Where lava flows out from long fissures, it may pile up vast sheets of rock, and bury the surrounding country under several thousand feet of solid stone, covering many hundreds of square miles. In this way volcanic tablelands have been formed which, attacked by the denuding forces, are gradually trenced by valleys and ravines, until the original level surface of the lava-field may be almost or wholly lost. As striking examples of this physiographical type reference may be made to the plateau of Abyssinia, the Ghats of India, the plateaux of Antrim, the Inner Hebrides and Iceland, and the great lava-plains of the western territories of the United States.

2. But while the subterranean movements have upraised portions of the surface of the lithosphere above the level of the ocean, and have thus been instrumental in producing the existing tracts of land, the detailed topographical features of a landscape

are not solely, nor in general even chiefly, attributable to these movements. From the time that any portion of the sea-floor appears above sea-level, it undergoes erosion by the various epigene agents. Each climate and geological region has its own development of these agents, which include air, aridity, rapid and frequent alternations of wetness and dryness or of heat and cold, rain, springs, frosts, rivers, glaciers, the sea, plant and animal life. In a dry climate subject to great extremes of temperature the character and rate of decay will differ from those of a moist or an arctic climate. But it must be remembered that, however much they may vary in activity and in the results which they effect, the epigene forces work without intermission, while the hypogene forces bring about the upheaval of land only after long intervals. Hence, trifling as the results during a human life may appear, if we realize the multiplying influence of time we are led to perceive that the apparently feeble superficial agents can, in the course of ages, achieve stupendous transformations in the aspect of the land. If this efficacy may be deduced from what can be seen to be in progress now, it may not less convincingly be shown, from the nature of the sedimentary rocks of the earth's crust, to have been in progress from the early beginnings of geological history. Side by side with the various upheavals and subsidences, there has been a continuous removal of materials from the land, and an equally persistent deposit of these materials under water, with the consequent growth of new rocks. Denudation has been aptly compared to a process of sculpturing wherein, while each of the implements employed by nature, like a special kind of graving tool, produces its own characteristic impress on the land, they all combine harmoniously towards the achievement of their one common task. Hence the present contours of the land depend partly on the original configuration of the ground, and the influence it may have had in guiding the operations of the erosive agents, partly on the vigour with which these agents perform their work, and partly on the varying structure and powers of resistance possessed by the rocks on which the erosion is carried on.

Where a new tract of land has been raised out of the sea by such an energetic movement as broke up the crust and produced the complicated structure and tumultuous external forms of a great mountain chain, the influence of the hypogene forces on the topography attains its highest development. But even the youngest existing chain has suffered so greatly from denudation that the aspect which it presented at the time of its uplift can only be dimly perceived. No more striking illustration of this feature can be found than that supplied by the Alps, nor one where the geotectonic structures have been so fully studied in detail. On the outer flanks of these mountains the longitudinal ridges and valleys of the Jura correspond with lines of anticline and syncline. Yet though the dominant topographical elements of the region have obviously been produced by the plication of the stratified formations, each ridge has suffered so large an amount of erosion that the younger rocks have been removed from its crest where the older members of the series are now exposed to view, while on every slope proofs may be seen of extensive denudation. If from these long wave-like undulations of the ground, where the relations between the disposition of the rocks below and the forms of the surface are so clearly traceable, the observer proceeds inwards to the main chain, he finds that the plications and displacements of the various formations assume an increasingly complicated character; and that although proofs of great denudation continue to abound, it becomes increasingly difficult to form any satisfactory conjecture as to the shape of the ground when the upheaval ended or any reliable estimate of the amount of material which has since then been removed. Along the central heights the mountains lift themselves towards the sky like the storm-swept crests of vast earth-billows. The whole aspect of the ground suggests intense commotion, and the impression thus given is often much intensified by the twisted and crumpled strata, visible from a long distance, on the crags and crests. On this broken-up surface the various agents of

denudation have been ceaselessly engaged since it emerged from the sea. They have excavated valleys, sometimes along depressions provided for them by the subterranean disturbance, sometimes down the slopes of the disrupted blocks of ground. So powerful has been this erosion that valleys cut out along lines of anticline, which were natural ridges, have sometimes become more important than those in lines of syncline, which were structurally depressions. The same subaerial forces have eroded lake-basins, dug out corries or cirques, notched the ridges, splintered the crests and furrowed the slopes, leaving no part of the original surface of the uplifted chain unmodified.

It has often been noted with surprise that features of underground structure which, it might have been confidently anticipated, should have exercised a marked influence on the topography of the surface have not been able to resist the levelling action of the denuding agents, and do not now affect the surface at all. This result is conspicuously seen in coal-fields where the strata are abundantly traversed by faults. These dislocations, having sometimes a displacement of several hundred feet, might have been expected to break up the surface into a network of cliffs and plains; yet in general they do not modify the level character of the ground above. One of the most remarkable faults in Europe is the great thrust which bounds the southern edge of the Belgian coal-field and brings the Devonian rocks above the Coal-measures. It can be traced across Belgium into the Boulonnais, and may not improbably run beneath the Secondary and Tertiary rocks of the south of England. It is crossed by the valleys of the Meuse and other northerly-flowing streams. Yet so indistinctly is it marked in the Meuse valley that no one would suspect its existence from any peculiarity in the general form of the ground, and even an experienced geologist, until he had learned the structure of the district, would scarcely detect any fault at all.

Where faults have influenced the superficial topography, it is usually by giving rise to a hollow along which the subaerial agents and especially running water can act effectively. Such a hollow may be eventually widened and deepened into a valley. On bare crags and crests, lines of fault are apt to be marked by notches or clefts, and they thus help to produce the pinnacles and serrated outlines of these exposed uplands.

It was cogently enforced by Hutton and Playfair, and independently by Lamarck, that no co-operation of underground agency is needed to produce such topography as may be seen in a great part of the world, but that if a tract of sea-floor were upraised into a wide plain, the fall of rain and the circulation of water over its surface would in the end carve out such a system of hills and valleys as may be seen on the dry land now. No such plain would be a dead-level. It would have inequalities on its surface which would serve as channels to guide the drainage from the first showers of rain. And these channels would be slowly widened and deepened until they would become ravines and valleys, while the ground between them would be left projecting as ridges and hills. Nor would the erosion of such a system of water-courses require a long series of geological periods for its accomplishment. From measurements and estimates of the amount of erosion now taking place in the basin of the Mississippi river it has been computed that valleys 800 ft. deep might be carved out in less than a million years. In the vast tablelands of Colorado and other western regions of the United States an impressive picture is presented of the results of mere subaerial erosion on undisturbed and nearly level strata. Systems of stream-courses and valleys, river gorges unexampled elsewhere in the world for depth and length, vast winding lines of escarpment, like ranges of sea-cliffs, terraced slopes rising from plateau to plateau, huge buttresses and solitary stacks standing like islands out of the plains, great mountain-masses towering into picturesque peaks and pinnacles cleft by innumerable gullies, yet everywhere marked by the parallel bars of the horizontal strata out of which they have been carved—these are the orderly symmetrical characteristics of a country where the scenery is due entirely to the action of subaerial agents on the one hand, and

the varying resistance of perfectly regular stratified rocks on the other.

The details of the sculpture of the land have mainly depended on the nature of the materials on which nature's erosive tools have been employed. The joints by which all rocks are traversed have been especially serviceable as dominant lines down which the rain has filtered, up which the springs have risen and into which the frost wedges have been driven. On the high bare scarps of a lofty mountain the inner structure of the mass is laid open, and there the system of joints even more than faults is seen to have determined the lines of crest, the vertical walls of cliff and precipice, the forms of buttress and recess, the position of cleft and chasm, the outline of spire and pinnacle. On the lower slopes, even under the tapestry of verdure which nature delights to hang where she can over her naked rocks, we may detect the same pervading influence of the joints upon the forms assumed by ravines and crags. Each kind of stone, too, gives rise to its own characteristic form of scenery. Massive crystalline rocks, such as granite, break up along their joints and often decay into sand or earth along their exposed surfaces, giving rise to rugged crags with long talus slopes at their base. The stratified rocks besides splitting at their joints are especially distinguished by parallel ledges, cornices and recesses, produced by the irregular decay of their component strata, so that they often assume curiously architectural types of scenery. But besides this family feature they display many minor varieties of aspect according to their lithological composition. A range of sandstone hills, for example, presents a marked contrast to one of limestone, and a line of chalk downs to the escarpments formed by alternating bands of harder and softer clays and shales.

It may suffice here merely to allude to a few of the more important parts of the topography of the land in their relation to physiographical geology. A true mountain-chain, viewed from the geological side, is a mass of high ground which owes its prominence to a ridging-up of the earth's crust, and the intense plication and rupture of the rocks of which it is composed. But ranges of hills almost mountainous in their bulk may be formed by the gradual erosion-of valleys out of a mass of original high ground, such as a high plateau or tableland. Eminences which have been isolated by denudation from the main mass of the formations of which they originally formed part are known as "outliers" or "hills of circumdenudation."

Tablelands, as already pointed out, may be produced either by the upheaval of tracts of horizontal strata from the sea-floor into land; or by the uprise of plains of denudation, where rocks of various composition, structure and age have been levelled down to near or below the level of the sea by the co-operation of the various erosive agents. Most of the great tablelands of the globe are platforms of little-disturbed strata which have been upraised bodily to a considerable elevation. No sooner, however, are they placed in that position than they are attacked by running water, and begin to be hollowed out into systems of valleys. As the valleys sink, the platforms between them grow into narrower and more definite ridges, until eventually the level tableland is converted into a complicated network of hills and valleys, wherein, nevertheless, the key to the whole arrangement is furnished by a knowledge of the disposition and effects of the flow of water. The examples of this process brought to light in Colorado, Wyoming, Nevada and the other western regions by Newberry, King, Hayden, Powell and other explorers, are among the most striking monuments of geological operations in the world.

Examples of ancient and much decayed tablelands formed by the denudation of much disturbed rocks are furnished by the Highlands of Scotland and of Norway. Each of these tracts of high ground consists of some of the oldest and most dislocated formations of Europe, which at a remote period were worn down into a plain, and in that condition may have lain long submerged under the sea and may possibly have been overspread there with younger formations. Having at a much later time been raised several thousand feet above sea-level the ancient platforms

of Britain and Scandinavia have been since exposed to denudation, whereby each of them has been so deeply channelled into glens and fjords that it presents to-day a surface of rugged hills, either isolated or connected along the flanks, while only fragments of the general surface of the tableland can here and there be recognized amidst the general destruction.

Valleys have in general been hollowed out by the greater erosive action of running water along the channels of drainage. Their direction has been probably determined in the great majority of cases by irregularities of the surface along which the drainage flowed on the first emergence of the land. Sometimes these irregularities have been produced by folds of the terrestrial crust, sometimes by faults, sometimes by the irregularities on the surface of an uplifted platform of deposition or of denudation. Two dominant trends may be observed among them. Some are longitudinal and run along the line of flexures in the upraised tract of land, others are transverse where the drainage has flowed down the slopes of the ridges into the longitudinal valleys or into the sea. The forms of valleys have been governed partly by the structure and composition of the rocks, and partly by the relative potency of the different denuding agents. Where the influence of rain and frost has been slight, and the streams, supplied from distant sources, have had sufficient declivity, deep, narrow, precipitous ravines or gorges have been excavated. The canyons of the arid region of the Colorado are a magnificent example of this result. Where, on the other hand, ordinary atmospheric action has been more rapid, the sides of the river channels have been attacked, and open sloping glens and valleys have been hollowed out. A gorge or defile is usually due to the action of a waterfall, which, beginning with some abrupt declivity or precipice in the course of the river when it first commenced to flow, or caused by some hard rock crossing the channel, has eaten its way backward.

Lakes have been already referred to, and their modes of origin have been mentioned. As they are continually being filled up with the detritus washed into them from the surrounding regions they cannot be of any great geological antiquity, unless where by some unknown process their basins are from time to time widened and deepened.

In the general subaerial denudation of a country, innumerable minor features are worked out as the structure of the rocks controls the operations of the eroding agents. Thus, among comparatively undisturbed strata, a hard bed resting upon others of a softer kind is apt to form along its outcrop a line of cliff or escarpment. Though a long range of such cliffs resembles a coast that has been worn by the sea, it may be entirely due to mere atmospheric waste. Again, the more resisting portions of a rock may be seen projecting as crags or knolls. An igneous mass will stand out as a bold hill from amidst the more decomposable strata through which it has risen. These features often so marked on the lower grounds, attain their most conspicuous development among the higher and barer parts of the mountains, where subaerial disintegration is most rapid. The torrents tear out deep gullies from the sides of the declivities. Corries or cirques are scooped out on the one hand and naked precipices are left on the other. The harder bands of rock project as massive ribs down the slopes, shoot up into prominent *aiguilles*, or help to give to the summits the notched saw-like outlines they so often present.

The materials worn from the surface of the higher are spread out over the lower grounds. The streams as they descend begin to drop their freight of sediment when, by the lessening of their declivity, their carrying power is diminished. The great plains of the earth's surface are due to this deposit of gravel, sand and loam. They are thus monuments at once of the destructive and reproductive processes which have been in progress unceasingly since the first land rose above the sea and the first shower of rain fell. Every pebble and particle of their soil, once part of the distant mountains, has travelled slowly and fitfully to lower levels. Again and again have these materials been shifted, ever moving downward and sea-ward. For centuries, perhaps, they have taken their share in the fertility of the plains and

have ministered to the nurture of flower and tree, of the bird of the air, the beast of the field and of man himself. But their destiny is still the great ocean. In that bourne alone can they find undisturbed repose, and there, slowly accumulating in massive beds, they will remain until, in the course of ages, renewed upheaval shall raise them into future land, there once more to pass through the same cycle of change. (A. Gk.)

LITERATURE.—*Historical*: The standard work is Karl A. von Zittel's *Geschichte der Geologie und Paläontologie* (1899), of which there is an abbreviated, but still valuable, English translation; D'Archiac, *Histoire des progrès de la géologie*, deals especially with the period 1834-1890; Kefterstein, *Geschichte und Literatur der Geognosie*, gives a summary up to 1840; while Sir A. Geikie's *Founders of Geology* (1897; 2nd ed., 1906) deals more particularly with the period 1750-1820. General treatises: Sir Charles Lyell's *Principles of Geology* is a classic. Of modern English works, Sir A. Geikie's *Text Book of Geology* (4th ed., 1903) occupies the first place; the work of T. C. Chamberlin and R. D. Salisbury, *Geology; Earth History* (3 vols., 1905-1906), is especially valuable for American geology. A. de Lapparent's *Traité de géologie* (5th ed., 1906), is the standard French work. H. Credner's *Elemente der Geologie* has gone through several editions in Germany. Dynamical and physiological geology are elaborately treated by E. Suess, *Das Antlitz der Erde*, translated into English, with the title *The Face of the Earth*. The practical study of the science is treated of by F. von Richtshofen, *Führer für Forschungsreisende* (1886); G. A. Cole, *Aids in Practical Geology* (5th ed., 1906); A. Geikie, *Outlines of Field Geology* (5th ed., 1900). The practical applications of Geology are discussed by J. V. Elden, *Applied Geology* (1898-1899). The relations of Geology to scenery are dealt with by Sir A. Geikie, *Scenery of Scotland* (3rd ed., 1901); J. E. Marr, *The Scientific Study of Scenery* (1900); Lord Avebury, *The Scenery of Switzerland* (1896); *The Scenery of England* (1902); and J. Geikie, *Earth Sculpture* (1898). A detailed bibliography is given in Sir A. Geikie's *Text Book of Geology*. See also the separate articles on geological subjects for special references to authorities.

GEOMETRICAL CONTINUITY. In a report of the Institute prefixed to Jean Victor Poncelet's *Traité des propriétés projectives des figures* (Paris, 1822), it is said that he employed "ce qu'il appelle le principe de continuité." The law or principle thus named by him had, he tells us, been tacitly assumed as axiomatic by "les plus savans géomètres." It had in fact been enunciated as "lex continuationis," and "la loi de la continuité," by Gottfried Wilhelm Leibnitz (Oxf. N.E.D.), and previously under another name by Johann Kepler in cap. iv. 4 of his *Ad Vitellionem paralipomena quibus astronomiæ pars optica traditur* (Francofurti, 1604). Of sections of the cone, he says, there are five species from the "recta linea" or line-pair to the circle. From the line-pair we pass through an infinity of hyperbolas to the parabola, and thence through an infinity of ellipses to the circle. Related to the sections are certain remarkable points which have no name. Kepler calls them foci. The circle has one focus at the centre, an ellipse or hyperbola two foci equidistant from the centre. The parabola has one focus within it, and another, the "caecus focus," which may be imagined to be at infinity on the axis *within or without the curve*. The line from it to any point of the section is parallel to the axis. To carry out the analogy we must speak paradoxically, and say that the line-pair likewise has foci, which in this case coalesce as in the circle and fall upon the lines themselves; for our geometrical terms should be subject to analogy. Kepler dearly loves analogies, his most trusty teachers, acquainted with all the secrets of nature, "omnium naturæ arcanorum conscios." And they are to be especially regarded in geometry as, by the use of "however absurd expressions," classing extreme limiting forms with an infinity of intermediate cases, and placing the whole essence of a thing clearly before the eyes.

Here, then, we find formulated by Kepler the doctrine of the concurrence of parallels at a single point at infinity and the principle of continuity (under the name analogy) in relation to the infinitely great. Such conceptions so strikingly propounded in a famous work could not escape the notice of contemporary mathematicians. Henry Briggs, in a letter to Kepler from Merton College, Oxford, dated "10 Cal. Martiis 1625," suggests improvements in the *Ad Vitellionem paralipomena*, and gives the following construction: Draw a line CBADC, and let an *ellipse, a parabola, and a hyperbola* have B and A for focus and

vertex. Let CC be the other foci of the ellipse and the hyperbola. Make AD equal to AB, and with centres CC and radius in each case equal to CD describe circles. Then any point of the ellipse is equidistant from the focus B and one circle, and any point of the hyperbola from the focus B and the other circle. Any point P of the parabola, in which the second focus is missing or infinitely distant, is equidistant from the focus B and the line through D which we call the directrix, this taking the place of either circle when its centre C is at infinity, and every line CP being then parallel to the axis: Thus Briggs, and we know not how many "savans géomètres" who have left no record, had already taken up the new doctrine in geometry in its author's lifetime. Six years after Kepler's death in 1630 Girard Desargues, "the Monge of his age," brought out the first of his remarkable works founded on the same principles, a short tract entitled *Méthode universelle de mettre en perspective les objets donnés réellement ou en devis* (Paris, 1636); but "Le privilège étoit de 1630" (Poudra, *Œuvres de Des.*, i. 55). Kepler as a modern geometer is best known by his *New Stereometry of Wine Casks* (Lincolni, 1615), in which he replaces the circuitous Archimedeæ method of exhaustion by a direct "royal road" of infinitesimals, treating a vanishing arc as a straight line and regarding a curve as made up of a succession of short chords. Some 2000 years previously one Antipho, probably the well-known opponent of Socrates, has regarded a circle in like manner as the limiting form of a many-sided inscribed rectilinear figure. Antipho's notion was rejected by the men of his day as unsound, and when reproduced by Kepler it was again stoutly opposed as incapable of any sort of geometrical demonstration—not altogether without reason, for it rested on an assumed law of continuity rather than on palpable proof.

To complete the theory of continuity, the one thing needful was the idea of imaginary points implied in the algebraical geometry of René Descartes, in which equations between variables representing co-ordinates were found often to have imaginary roots. Newton, in his two sections on "Inventio orbium" (*Principia* i. 4, 5), shows in his brief way that he is familiar with the principles of modern geometry. In two propositions he uses an auxiliary line which is supposed to cut the conic in X and Y, but, as he remarks at the end of the second (prop. 24), it may not cut it at all. For the sake of brevity he passes on at once with the observation that the required constructions are evident from the case in which the line cuts the trajectory. In the scholium appended to prop. 27, after saying that an asymptote is a tangent at infinity, he gives an unexplained general construction for the axes of a conic, which seems to imply that it has asymptotes. In all such cases, having equations to his loci in the background, he may have thought of elements of the figure as passing into the imaginary state in such manner as not to vitiate conclusions arrived at on the hypothesis of their reality.

Roger Joseph Bosovich, a careful student of Newton's works, has a full and thorough discussion of geometrical continuity in the third and last volume of his *Elementa universæ matheseos* (ed. prim. Venet. 1757), which contains *Sectionum conicarum elementa nova quadam methodo concinnata et dissertationem de transformatione locorum geometricorum, ubi de continuitatis lege, et de quibusdam infiniti mysteriis*. His first principle is that all varieties of a defined locus have the same properties, so that what is demonstrable of one should be demonstrable in like manner of all, although some artifice may be required to bring out the underlying analogy between them. The opposite extremities of an infinite straight line, he says, are to be regarded as joined, as if the line were a circle having its centre at the infinity on either side of it. This leads up to the idea of a *solidi plus quam infinita extensio*, a line-circle containing, as we say, the line infinity. Change from the real to the imaginary state is contingent upon the passage of some element of a figure through zero or infinity and never takes place *per saltum*. Lines being some positive and some negative, there must be negative rectangles and negative squares, such as those of the exterior diameters of a hyperbola. Bosovich's first principle was that of Kepler, by whose *quantumvis absurdis locutionibus* the boldest

applications of it are covered, as when we say with Poncelet that all concentric circles in a plane touch one another in two imaginary fixed points at infinity. In G. K. Ch. von Staudt's *Geometrie der Lage und Beiträge zur G. der L.* (Nürnberg, 1847, 1856-1860) the geometry of position, including the extension of the field of pure geometry to the infinite and the imaginary, is presented as an independent science, "welche des Messens nicht bedarf." (See GEOMETRY: *Projectives*.)

Ocular illusions due to distance, such as Roger Bacon notices in the *Opus majus* (i. 126, ii. 108, 497; Oxford, 1897), lead up to or illustrate the mathematical uses of the infinite and its reciprocal the infinitesimal. Specious objections can, of course, be made to the anomalies of the law of continuity, but they are inherent in the higher geometry, which has taught us so much of the "secrets of nature." Kepler's excursus on the "analogy" between the conic sections hereinbefore referred to is given at length in an article on "The Geometry of Kepler and Newton" in vol. xviii. of the *Transactions of the Cambridge Philosophical Society* (1900). It had been generally overlooked, until attention was called to it by the present writer in a note read in 1880 (*Proc. C.P.S.* iv. 14-17), and shortly afterwards in *The Ancient and Modern Geometry of Conics, with Historical Notes and Prolegomena* (Cambridge 1881). (C. T.*)

GEOMETRY, the general term for the branch of mathematics which has for its province the study of the properties of space. From experience, or possibly intuitively, we characterize existent space by certain fundamental qualities, termed axioms, which are insusceptible of proof; and these axioms, in conjunction with the mathematical entities of the point, straight line, curve, surface and solid, appropriately defined, are the premises from which the geometer draws conclusions. The geometrical axioms are merely conventions; on the one hand, the system may be based upon inductions from experience, in which case the deduced geometry may be regarded as a branch of physical science; or, on the other hand, the system may be formed by purely logical methods, in which case the geometry is a phase of pure mathematics. Obviously the geometry with which we are most familiar is that of existent space—the three-dimensional space of experience; this geometry may be termed Euclidean, after its most famous expositor. But other geometries exist, for it is possible to frame systems of axioms which definitely characterize some other kind of space, and from these axioms to deduce a series of non-contradictory propositions; such geometries are called non-Euclidean.

It is convenient to discuss the subject-matter of geometry under the following headings:

I. *Euclidean Geometry*: a discussion of the axioms of existent space and of the geometrical entities, followed by a synoptical account of Euclid's *Elements*.

II. *Projective Geometry*: primarily Euclidean, but differing from I. in employing the notion of *geometrical continuity* (*q.v.*)—points and lines at infinity.

III. *Descriptive Geometry*: the methods for representing upon planes figures placed in space of three dimensions.

IV. *Analytical Geometry*: the representation of geometrical figures and their relations by algebraic equations.

V. *Line Geometry*: an analytical treatment of the line regarded as the space element.

VI. *Non-Euclidean Geometry*: a discussion of geometries other than that of the space of experience.

VII. *Axioms of Geometry*: a critical analysis of the foundations of geometry.

Special subjects are treated under their own headings: *e.g.* PROJECTION, PERSPECTIVE; CURVE, SURFACE; CIRCLE, CONIC SECTION; TRIANGLE, POLYGON, POLYHEDRON; there are also articles on special curves and figures, *e.g.* ELLIPSE, PARABOLA, HYPERBOLA; TETRAHEDRON, CUBE, OCTAHEDRON, DODECAHEDRON, ICOSAHEDRON; CARDIOID, CATENARY, CISSOID, CONCHOID, CYCLOID, EPICYCLOID, LIMAÇON, OVAL, QUADRATRIX, SPIRAL, &c.

History.—The origin of geometry (Gr. $\gamma\eta$, earth, $\mu\epsilon\tau\rho\omega\varsigma$, a measure) is, according to Herodotus, to be found in the etymology of the word. Its birthplace was Egypt, and it arose from the need of surveying the lands inundated by the Nile floods. In

its infancy it therefore consisted of a few rules, very rough and approximate, for computing the areas of triangles and quadrilaterals; and, with the Egyptians, it proceeded no further, the geometrical entities—the point, line, surface and solid—being only discussed in so far as they were involved in practical affairs. The point was realized as a mark or position, a straight line as a stretched string or the tracing of a pole, a surface as an area; but these units were not abstracted; and for the Egyptians geometry was only an art—an auxiliary to surveying.¹ The first step towards its elevation to the rank of a science was made by Thales (*q.v.*) of Miletus, who transplanted the elementary Egyptian mensuration to Greece. Thales clearly abstracted the notions of points and lines, founding the geometry of the latter unit, and discovering *per saltum* many propositions concerning areas, the circle, &c. The empirical rules of the Egyptians were corrected and developed by the Ionic School which he founded, especially by Anaximander and Anaxagoras, and in the 6th century B.C. passed into the care of the Pythagoreans. From this time geometry exercised a powerful influence on Greek thought. Pythagoras (*q.v.*), seeking the key of the universe in arithmetic and geometry, investigated logically the principles underlying the known propositions; and this resulted in the formulation of definitions, axioms and postulates which, in addition to founding a *science* of geometry, permitted a crystallization, fractional, it is true, of the amorphous collection of material at hand. Pythagorean geometry was essentially a geometry of areas and solids; its goal was the regular solids—the tetrahedron, cube, octahedron, dodecahedron and icosahedron—which symbolized the five elements of Greek cosmology. The geometry of the circle, previously studied in Egypt and much more seriously by Thales, was somewhat neglected, although this curve was regarded as the most perfect of all plane figures and the sphere the most perfect of all solids. The circle, however, was taken up by the Sophists, who made most of their discoveries in attempts to solve the classical problems of squaring the circle, doubling the cube and trisecting an angle. These problems, besides stimulating pure geometry, *i.e.* the geometry of constructions made by the ruler and compasses, exercised considerable influence in other directions. The first problem led to the discovery of the method of *exhaustion* for determining areas. Antiphon inscribed a square in a circle, and on each side an isosceles triangle having its vertex on the circle; on the sides of the octagon so obtained, isosceles triangles were again constructed, the process leading to inscribed polygons of 8, 16 and 32 sides; and the areas of these polygons, which are easily determined, are successive approximations to the area of the circle. Bryson of Heraclea took an important step when he circumscribed, in addition to inscribing, polygons to a circle, but he committed an error in treating the circle as the mean of the two polygons. The method of Antiphon, in assuming that by continued division a polygon can be constructed coincident with the circle, demanded that magnitudes are not infinitely divisible. Much controversy ranged about this point; Aristotle supported the doctrine of infinite divisibility; Zeno attempted to show its absurdity. The mechanical tracing of loci, a principle initiated by Archytas of Tarentum to solve the last two problems, was a frequent subject for study, and several mechanical curves were thus discovered at subsequent dates (cissoid, conchoid, quadratrix). Mention may be made of Hippocrates, who, besides developing the known methods, made a study of similar figures, and, as a consequence, of proportion. This step is important as bringing into line discontinuous number and continuous magnitude.

A fresh stimulus was given by the succeeding Platonists, who, accepting in part the Pythagorean cosmology, made the study of geometry preliminary to that of philosophy. The many discoveries made by this school were facilitated in no small measure by the clarification of the axioms and definitions, the logical sequence of propositions which was adopted, and, more especially, by the formulation of the analytic method, *i.e.* of assuming the truth of a proposition and then reasoning to a

¹ For Egyptian geometry see EATON, *A Science and Mathematics*.

known truth. The main strength of the Platonist geometers lies in stereometry or the geometry of solids. The Pythagoreans had dealt with the sphere and regular solids, but the pyramid, prism, cone and cylinder were but little known until the Platonists took them in hand. Eudoxus established their mensuration, proving the pyramid and cone to have one-third the content of a prism and cylinder on the same base and of the same height, and was probably the discoverer of a proof that the volumes of spheres are as the cubes of their radii. The discussion of sections of the cone and cylinder led to the discovery of the three curves named the parabola, ellipse and hyperbola (see CONIC SECTION); it is difficult to over-estimate the importance of this discovery; its investigation marks the crowning achievement of Greek geometry, and led in later years to the fundamental theorems and methods of modern geometry.

The presentation of the subject-matter of geometry as a connected and logical series of propositions, prefaced by *ὄροι* or foundations, had been attempted by many; but it is to Euclid that we owe a complete exposition. Little indeed in the *Elements* is probably original except the arrangement; but in this Euclid surpassed such predecessors as Hippocrates, Leon, pupil of Neocleides, and Theudius of Magnesia, devising an apt logical model, although when scrutinized in the light of modern mathematical conceptions the proofs are riddled with fallacies. According to the commentator Proclus, the *Elements* were written with a twofold object, first, to introduce the novice to geometry, and secondly, to lead him to the regular solids; conic sections found no place therein. What Euclid did for the line and circle, Apollonius did for the conic sections, but there we have a discoverer as well as editor. These two works, which contain the greatest contributions to ancient geometry, are treated in detail in Section I. *Euclidean Geometry* and the articles EUCLID; CONIC SECTION; APOLLONIUS. Between Euclid and Apollonius there flourished the illustrious Archimedes, whose geometrical discoveries are mainly concerned with the mensuration of the circle and conic sections, and of the sphere, cone and cylinder, and whose greatest contribution to geometrical method is the elevation of the method of exhaustion to the dignity of an instrument of research. Apollonius was followed by Nicomedes, the inventor of the conchoid; Diodes, the inventor of the cissoid; Zenodorus, the founder of the study of isoperimetrical figures; Hipparchus, the founder of trigonometry; and Heron the elder, who wrote after the manner of the Egyptians, and primarily directed attention to problems of practical surveying.

Of the many isolated discoveries made by the later Alexandrian mathematicians, those of Menelaus are of importance. He showed how to treat spherical triangles, establishing their properties and determining their congruence; his theorem on the products of the segments in which the sides of a triangle are cut by a line was the foundation on which Carnot erected his theory of transversals. These propositions, and also those of Hipparchus, were utilized and developed by Ptolemy (q.v.), the expositor of trigonometry and discoverer of many isolated propositions. Mention may be made of the commentator Pappus, whose *Mathematical Collections* is valuable for its wealth of historical matter; of Theon, an editor of Euclid's *Elements* and commentator of Ptolemy's *Almagest*; of Proclus, a commentator of Euclid; and of Eutocius, a commentator of Apollonius and Archimedes.

The Romans, essentially practical and having no inclination to study science *qua* science, only had a geometry which sufficed for surveying; and even here there were abundant inaccuracies, the empirical rules employed being akin to those of the Egyptians and Heron. The Hindus, likewise, gave more attention to computation, and their geometry was either of Greek origin or in the form presented in trigonometry, more particularly connected with arithmetic. It had no logical foundations; each proposition stood alone; and the results were empirical. The Arabs more closely followed the Greeks, a plan adopted as a sequel to the translation of the works of Euclid, Apollonius, Archimedes and many others into Arabic. Their chief contribution to geometry is exhibited in their solution of algebraic

equations by intersecting conics, a step already taken by the Greeks in isolated cases, but only elevated into a *method* by Omar al Hayyami, who flourished in the 11th century. During the middle ages little was added to Greek and Arabic geometry. Leonardo of Pisa wrote a *Practica geometriae* (1220), wherein Euclidean methods are employed; but it was not until the 14th century that geometry, generally Euclid's *Elements*, became an essential item in university curricula. There was, however, no sign of original development, other branches of mathematics, mainly algebra and trigonometry, exercising a greater fascination until the 16th century, when the subject again came into favour.

The extraordinary mathematical talent which came into being in the 16th and 17th centuries reacted on geometry and gave rise to all those characters which distinguish modern from ancient geometry. The first innovation of moment was the formulation of the principle of geometrical continuity by Kepler. The notion of infinity which it involved permitted generalizations and systematizations hitherto unthought of (see GEOMETRICAL CONTINUITY); and the method of indefinite division applied to rectification, and quadrature and cubature problems avoided the cumbersome method of exhaustion and provided more accurate results. Further progress was made by Bonaventura Cavalieri, who, in his *Geometria indivisibilibus continuorum* (1620), devised a method intermediate between that of exhaustion and the infinitesimal calculus of Leibnitz and Newton. The logical basis of his system was corrected by Roberval and Pascal; and their discoveries, taken in conjunction with those of Leibnitz, Newton, and many others in the fluxional calculus, culminated in the branch of our subject known as differential geometry (see INFINITESIMAL CALCULUS, CURVE; SURFACE).

A second important advance followed the recognition that conics could be regarded as projections of a circle, a conception which led at the hands of Desargues and Pascal to modern *projective geometry* and *perspective*. A third, and perhaps the most important, advance attended the application of algebra to geometry by Descartes, who thereby founded *analytical geometry*. The new fields thus opened up were diligently explored, but the calculus exercised the greatest attraction and relatively little progress was made in geometry until the beginning of the 19th century, when a new era opened.

Gaspard Monge was the first important contributor, stimulating analytical and differential geometry and founding *descriptive geometry* in a series of papers and especially in his lectures at the Ecole polytechnique. Projective geometry, founded by Desargues, Pascal, Monge and L. N. M. Carnot, was crystallized by J. V. Poncelet, the creator of the modern methods. In his *Traité des propriétés des figures* (1822) the line and circular points at infinity, imaginaries, polar reciprocation, homology, cross-ratio and projection are systematically employed. In Germany, A. F. Möbius, J. Plücker and J. Steiner were making far-reaching contributions. Möbius, in his *Barycentrische Calcul* (1827), introduced homogeneous co-ordinates, and also the powerful notion of geometrical transformation, including the special cases of collineation and duality; Plücker, in his *Analysisch-geometrische Entwicklungen* (1828-1831), and his *System der analytischen Geometrie* (1835), introduced the abridged notation, line and plane co-ordinates, and the conception of generalized space elements; while Steiner, besides enriching geometry in numerous directions, was the first to systematically generate figures by projective pencils. We may also notice M. Chasles, whose *Aperçu historique* (1837) is a classic. Synthetic geometry, characterized by its fruitfulness and beauty, attracted most attention, and it so happened that its originally weak logical foundations became replaced by a more substantial set of axioms. These were found in the anharmonic ratio, a device leading to the liberation of synthetic geometry from metrical relations, and in involution, which yielded rigorous definitions of imaginaries. These innovations were made by K. J. C. von Staudt. Analytical geometry was stimulated by the algebra of invariants, a subject much developed by A. Cayley, G. Salmon, S. H. Arohold, L. O. Hesse, and more particularly by R. F. A. Clebsch.

The introduction of the line as a space element, initiated by

H. Grassmann (1844) and Cayley (1859), yielded at the hands of Plücker a new geometry, termed *line geometry*, a subject developed more notably by F. Klein, Clebsch, C. T. Reyé and F. O. R. Sturm (see Section V., *Line Geometry*).

Non-euclidean geometries, having primarily their origin in the discussion of Euclidean parallels, and treated by Wallis, Saccheri and Lambert, have been especially developed during the 19th century. Four lines of investigation may be distinguished:—the naive-synthetic, associated with Lobatschewski, Bolyai, Gauss; the metric differential, studied by Riemann, Helmholtz, Beltrami; the projective, developed by Cayley, Klein, Clifford; and the critical-synthetic, promoted chiefly by the Italian mathematicians Peano, Veronese, Burali-Forte, Levi Cività, and the Germans Pasch and Hilbert. (C. E.)*

I. EUCLIDEAN GEOMETRY

This branch of the science of geometry is so named since its methods and arrangement are those laid down in Euclid's *Elements*.

§ 1. *Axioms*.—The object of geometry is to investigate the properties of space. The first step must consist in establishing those fundamental properties from which all others follow by processes of deductive reasoning. They are laid down in the Axioms, and these ought to form such a system that nothing need be added to them in order fully to characterize space, and that nothing may be omitted without making the system incomplete. They must, in fact, completely "define" space.

§ 2. *Definitions*.—The axioms of Euclidean Geometry are obtained from inspection of existent space and of solids in existent space,—hence from experience. The same source gives us the notions of the geometrical entities to which the axioms relate, viz. solids, surfaces, lines or curves, and points. A solid is directly given by experience; we have only to abstract all material from it in order to gain the notion of a geometrical solid. This has shape, size, position, and may be moved. Its boundary or boundaries are called surfaces. They separate one part of space from another, and are said to have no thickness. Their boundaries are curves or lines, and these have length only. Their boundaries, again, are points, which have no magnitude but only position. We thus come in three steps from solids to points which have no magnitude; in each step we lose one extension. Hence we say a solid has three dimensions, a surface two, a line one, and a point none. Space itself, of which a solid forms only a part, is also said to be of three dimensions. The same thing is intended to be expressed by saying that a solid has length, breadth and thickness, a surface length and breadth, a line length only, and a point no extension whatsoever.

Euclid gives the essence of these statements as definitions:—
Def. 1. *A point is that which has no parts, or which has no magnitude.*

Def. 2. *A line is length without breadth.*

Def. 3. *A superficies is that which has only length and breadth.*

Def. 4. *A solid is that which has length, breadth and thickness.*

It is to be noted that the synthetic method is adopted by Euclid; the analytical derivation of the successive ideas of "surface," "line," and "point" from the experimental realization of a "solid" does not find a place in his system, although possessing more advantages.

If we allow motion in geometry, we may generate these entities by moving a point, a line, or a surface, thus:—

The path of a moving point is a line.

The path of a moving line is, in general, a surface.

The path of a moving surface is, in general, a solid.

And we may then assume that the lines, surfaces and solids, as defined before, can all be generated in this manner. From this generation of the entities it follows again that the boundaries—the first and last position of the moving element—of a line are points, and so on; and thus we come back to the considerations with which we started.

Euclid points this out in his definitions.—Def. 3, I., Def. 6, I., and Def. 2, XI. He does not, however, show the connexion which these definitions have with those mentioned before. When points and lines have been defined, a statement like

Def. 3, I., "The extremities of a line are points," is a proposition which either has to be proved, and then it is a theorem, or which has to be taken for granted, in which case it is an axiom. And so with Def. 6, I., and Def. 2, XI.

§ 3. Euclid's definitions mentioned above are attempts to describe, in a few words, notions which we have obtained by inspection of and abstraction from solids. A few more notions have to be added to these, principally those of the simplest line—the straight line, and of the simplest surface—the flat surface or plane. These notions we possess, but to define them accurately is difficult. Euclid's Definition 4, I., "A straight line is that which lies evenly between its extreme points," must be meaningless to any one who has not the notion of straightness in his mind. Neither does it state a property of the straight line which can be used in any further investigation. Such a property is given in Axiom 10, I. It is really this axiom, together with Postulates 2 and 3, which characterizes the straight line.

Whilst for the straight line the verbal definition and axiom are kept apart, Euclid mixes them up in the case of the plane. Here the Definition 7, I., includes an axiom. It defines a plane as a surface which has the property that every straight line which joins any two points in it lies altogether in the surface. But if we take a straight line and a point in such a surface, and draw all straight lines which join the latter to all points in the first line, the surface will be fully determined. This construction is therefore sufficient as a definition. That every other straight line which joins any two points in this surface lies altogether in it is a further property, and to assume it gives another axiom.

Thus a number of Euclid's axioms are hidden among his first definitions. A still greater confusion exists in the present editions of Euclid between the postulates and axioms so called, but this is due to later editors and not to Euclid himself. The latter had the last three axioms put together with the postulates (*ἀξιώματα*), so that these were meant to include all assumptions relating to space. The remaining assumptions, which relate to magnitudes in general, viz. the first eight "axioms" in modern editions, were called "common notions" (*κοινὰ ἔννοιαι*). Of the latter a few may be said to be definitions. Thus the eighth might be taken as a definition of "equal," and the seventh of "halves." If we wish to collect the axioms used in Euclid's *Elements*, we have therefore to take the three postulates, the last three axioms as generally given, a few axioms hidden in the definitions, and an axiom used by Euclid in the proof of Prop. 4, I, and on a few other occasions, viz. that figures may be moved in space without change of shape or size.

§ 4. *Postulates*.—The assumptions actually made by Euclid may be stated as follows:—

(1) Straight lines exist which have the property that any one of them may be produced both ways without limit, that through any two points in space such a line may be drawn, and that any two of them coincide throughout their indefinite extensions as soon as two points in the one coincide with two points in the other. (This gives the contents of Def. 4, part of Def. 35, the first two Postulates, and Axiom 10.)

(2) Plane surfaces or planes exist having the property laid down in Def. 7, that every straight line joining any two points in such a surface lies altogether in it.

(3) Right angles, as defined in Def. 10, are possible, and all right angles are equal; that is to say, wherever in space we take a plane, and wherever in that plane we construct a right angle, all angles thus constructed will be equal, so that any one of them may be made to coincide with any other. (Axiom 11.)

(4) The 12th Axiom of Euclid. This we shall not state now, but only introduce it when we cannot proceed any further without it.

(5) Figures may be freely moved in space without change of shape or size. This is assumed by Euclid, but not stated as an axiom.

(6) In any plane a circle may be described, having any point in that plane as centre, and its distance from any other point in that plane as radius. (Postulate 3.)

The definitions which have not been mentioned are all

"nominal definitions," that is to say, they fix a name for a thing described. Many of them overdetermine a figure.

§ 5. Euclid's *Elements* (see EUCLID) are contained in thirteen books. Of these the first four and the sixth are devoted to "plane geometry," as the investigation of figures in a plane is generally called. The 5th book contains the theory of proportion

which is used in Book VI. The 7th, 8th and 9th books are purely arithmetical, whilst the 10th contains a most ingenious treatment of geometrical irrational quantities. These four books will be excluded from our survey. The remaining three books relate to figures in space, or, as it is generally called, to "solid geometry." The 7th, 8th, 9th, 10th, 11th and part of the 12th and 13th books are now generally omitted from the school editions of the *Elements*. In the first four and in the 6th book it is to be understood that all figures are drawn in a plane.

BOOK I. OF EUCLID'S "ELEMENTS."

§ 6. According to the third postulate it is possible to draw in any plane a circle which has its centre at any given point, and its radius equal to the distance of this point from any other point given in the plane. This makes it possible (Prop. 1) to construct on a given line AB an equilateral triangle, by drawing first a circle with A as centre and AB as radius, and then a circle with B as centre and BA as radius. The point where these circles intersect—that they intersect—Euclid quietly assumes—is the vertex of the required triangle. Euclid does not suppose, however, that a circle may be drawn which has its radius equal to the distance between any two points unless one of the points be the centre. This implies also that we are not supposed to be able to make any straight line equal to any other straight line, or to carry a distance about in space. Euclid therefore next solves the problem: It is required along a given straight line from a point in it to set off a distance equal to the length of another straight line given anywhere in the plane. This is done in two steps. It is shown in Prop. 2 how a straight line may be drawn from a given point equal in length to another given straight line not drawn from that point. And then the problem itself is solved in Prop. 3, by drawing first through the given point some straight line of the required length, and then about the same point as centre a circle having this length as radius. This circle will cut off from the given straight line a length equal to the required one. Nowadays, instead of going through this long process, we take a pair of compasses and set off the given length by its aid. This assumes that we may move a length about without changing it. But Euclid has not assumed it, and this proceeding would be fully justified by his desire not to take for granted more than was necessary, if he were not obliged at his very next step actually to make this assumption, though without stating it.

§ 7. We now come (in Prop. 4) to the first theorem. It is the fundamental theorem of Euclid's whole system, there being only a very few propositions (like Props. 13, 14, 15, I.), except those in the 5th book and the first half of the 11th, which do not depend upon it. It is stated very accurately, though somewhat clumsily, as follows:—

If two triangles have two sides of the one equal to two sides of the other, each to each, and have also the angles contained by those sides equal to one another, they shall also have their bases or third sides equal; and the two triangles shall be equal; and their other angles shall be equal, each to each, namely, those to which the equal sides are opposite.

That is to say, the triangles are "identically" equal, and one may be considered as a copy of the other. The proof is very simple. The first triangle is taken up and placed on the second, so that the parts of the triangles which are known to be equal fall upon each other. It is then easily seen that also the remaining parts of one coincide with those of the other, and that they are therefore equal. This process of applying one figure to another Euclid scarcely uses again, though many proofs would be simplified by doing so. The process introduces motion into geometry, and includes, as already stated, the axiom that figures may be moved without change of shape or size.

If the last proposition be applied to an isosceles triangle, which has two sides equal, we obtain the theorem (Prop. 5), *if two sides of a triangle are equal, then the angles opposite these sides are equal.*

Euclid's proof is somewhat complicated, and a stumbling-block to many schoolboys. The proof becomes much simpler if we consider the isosceles triangle ABC ($AB = AC$) twice over, once as a triangle BAC, and once as a triangle CAB; and now remember that AB, AC in the first are equal respectively to AC, AB in the second, and the angles included by these sides are equal. Hence the triangles are equal, and the angles in the one are equal to those in the other, viz. those which are opposite equal sides, i.e. angle ABC in the first equals angle ACB in the second, as they are opposite the equal sides AC and AB in the two triangles.

There follows the converse theorem (Prop. 6). *If two angles in a triangle are equal, then the sides opposite them are equal*—i.e. the triangle is isosceles. The proof given consists in what is called a *reductio ad absurdum*, a kind of proof often used by Euclid, and principally in proving the converse of a previous theorem. It assumes that the theorem to be proved is wrong, and then shows that this assumption leads to an absurdity, i.e. to a conclusion which is in contradiction to a proposition proved before—that therefore the assumption made cannot be true, and hence that the theorem is true. It is often stated that Euclid invented this kind of proof, but the method is most likely much older.

§ 8. It is next proved that *two triangles which have the three sides of the one equal respectively to those of the other are identically equal, hence that the angles of the one are equal respectively to those of the other, those being equal which are opposite equal sides.* This is Prop. 8. Prop. 7 containing only a first step towards its proof.

These theorems allow now of the solution of a number of problems, viz.:

To bisect a given angle (Prop. 9).

To bisect a given finite straight line (Prop. 10).

To draw a straight line perpendicular to a given straight line through a given point in it (Prop. 11), and also *through a given point not in it* (Prop. 12).

The solutions all depend upon properties of isosceles triangles.

§ 9. The next three theorems relate to angles only, and might have been proved before Prop. 4, or even at the very beginning. The first (Prop. 13) says, *The angles which one straight line makes with another straight line on one side of it either are two right angles or are together equal to two right angles.* This theorem would have been unnecessary if Euclid had admitted the notion of an angle such that its two limits are in the same straight line, and had besides defined the sum of two angles.

Its converse (Prop. 14) is of great use, inasmuch as it enables us in many cases to prove that two straight lines drawn from the same point are one the continuation of the other. So also is

Prop. 15. *If two straight lines cut one another, the vertical or opposite angles shall be equal.*

§ 10. Euclid returns now to properties of triangles. Of great importance for the next steps (though afterwards superseded by a more complete theorem) is

Prop. 16. *If one side of a triangle be produced, the exterior angle shall be greater than either of the interior opposite angles.*

Prop. 17. *Any two angles of a triangle are together less than two right angles*, is an immediate consequence of it: By the aid of these two, the following fundamental properties of triangles are easily proved:—

Prop. 18. *The greater side of every triangle has the greater angle opposite to it;*

Its converse, Prop. 19. *The greater angle of every triangle is subtended by the greater side, or has the greater side opposite to it;*

Prop. 20. *Any two sides of a triangle are together greater than the third side;*

And also Prop. 21. *If from the ends of the side of a triangle there be drawn two straight lines to a point within the triangle, these shall be less than the other two sides of the triangle, but shall contain a greater angle.*

§ 11. Having solved two problems (Props. 22, 23), he returns to two triangles which have two sides of the one equal respectively to two sides of the other. It is known (Prop. 4) that if the included angles are equal then the third sides are equal; and conversely (Prop. 8), if the third sides are equal, then the angles included by the first sides are equal. From this it follows that if the included angles are not equal, the third sides are not equal; and conversely, that if the third sides are not equal, the included angles are not equal. Euclid now completes this knowledge by proving, that "if the included angles are not equal, then the third side in that triangle is the greater which contains the greater angle"; and conversely, that "if the third sides are unequal, that triangle contains the greater angle which contains the greater side." These are Prop. 24 and Prop. 25.

§ 12. The next theorem (Prop. 26) says that *if two triangles have one side and two angles of the one equal respectively to one side and two angles of the other, viz. in both triangles either the angles adjacent to the equal side, or one angle adjacent and one angle opposite it, then the two triangles are identically equal.*

This theorem belongs to a group with Prop. 4 and Prop. 8. Its first case might have been given immediately after Prop. 4, but the second case requires Prop. 16 for its proof.

§ 13. We come now to the investigation of parallel straight lines, i.e. of straight lines which lie in the same plane, and cannot be made to meet however far they be produced either way. The investigation which starts from Prop. 16, will become clearer if a few names be explained which are not all used by Euclid. If two straight lines be cut by a third, the latter is now generally called a "transversal" of the figure. It forms at the two points where it cuts the given lines four angles with each. Those of the angles which lie between the given lines are called interior angles, and of these, again, any two which lie on opposite sides of the transversal but one at each of the two points are called "alternate angles."

We may now state Prop. 16 thus:—*If two straight lines which meet are cut by a transversal, their alternate angles are unequal.* For the lines will form a triangle, and one of the alternate angles will be an exterior angle to the triangle, the other interior and opposite to it.

From this follows at once the theorem contained in Prop. 27. *If two straight lines which are cut by a transversal make alternate angles equal, the lines cannot meet, however far they be produced, hence they are parallel.* This proves the existence of parallel lines.

Prop. 28 states the same fact in different forms. *If a straight line, falling on two other straight lines, make the exterior angle equal to the interior and opposite angle on the same side of the line, or make*

the interior angles on the same side together equal to two right angles, the two straight lines shall be parallel to one another.

Hence we know that, "if two straight lines which are cut by a transversal meet, their alternate angles are not equal"; and hence that, "if alternate angles are equal, then the lines are parallel."

The question now arises, Are the propositions converse to these true or not? That is to say, "If alternate angles are unequal, do the lines meet?" And "if the lines are parallel, are alternate angles necessarily equal?"

The answer to either of these two questions implies the answer to the other. But it has been found impossible to prove that the negation or the affirmation of either is true.

The difficulty which thus arises is overcome by Euclid assuming that the first question has to be answered in the affirmative. This gives his last axiom (12), which we quote in his own words.

Axiom 12.—*If a straight line meet two straight lines, so as to make the two interior angles on the same side of it taken together less than two right angles, these straight lines, being continually produced, shall at length meet on that side on which are the angles which are less than two right angles.*

The answer to the second of the above questions follows from this, and gives the theorem Prop. 29:—*If a straight line fall on two parallel straight lines, it makes the alternate angles equal to one another, and the exterior angle equal to the interior and opposite angle on the same side, and also the two interior angles on the same side together equal to two right angles.*

§ 14. With this a new part of elementary geometry begins. The earlier propositions are independent of this axiom, and would be true even if a wrong assumption had been made in it. They all relate to figures in a plane. But a plane is only one among an infinite number of conceivable surfaces. We may draw figures on any one of them and study their properties. We may, for instance, take a sphere instead of the plane, and obtain "spherical" in the place of "plane" geometry. If on one of these surfaces lines and figures could be drawn, answering to all the definitions of our plane figures, and if the axioms with the exception of the last all hold, then all propositions up to the 28th will be true for these figures. This is the case in spherical geometry if we substitute "shortest line" or "great circle" for "straight line," "small circle" for "circle," and if, besides, we limit all figures to a part of the sphere which is less than a hemisphere, so that two points on it cannot be opposite ends of a diameter, and therefore determine always one and only one great circle.

For spherical triangles, therefore, all the important propositions 4, 8, 26; 5 and 6; and 18, 19 and 20 will hold good.

This remark will be sufficient to show the impossibility of proving Euclid's last axiom, which would mean proving that this axiom is a consequence of the others, and hence that the theory of parallels would hold on a spherical surface, where the other axioms do hold, whilst parallels do not even exist.

It follows that the axiom in question states an inherent difference between the plane and other surfaces, and that the plane is only fully characterized when this axiom is added to the other assumptions.

§ 15. The introduction of the new axiom and of parallel lines leads to a new class of propositions.

After proving (Prop. 30) that "two lines which are each parallel to a third are parallel to each other," we obtain the new properties of triangles contained in Prop. 32. Of these the second part is the most important, viz. the theorem, *The three interior angles of every triangle are together equal to two right angles.*

As easy deductions not given by Euclid but added by Simson follow the propositions about the angles in polygons; they are given in English editions as corollaries to Prop. 32.

These theorems do not hold for spherical figures. The sum of the interior angles of a spherical triangle is always greater than two right angles, and increases with the area.

§ 16. The theory of parallels as such may be said to be finished with Props. 33 and 34, which state properties of the parallelogram, i.e. of a quadrilateral formed by two pairs of parallels. They are—

Prop. 33. *The straight lines which join the extremities of two equal and parallel straight lines towards the same parts are themselves equal and parallel; and*

Prop. 34. *The opposite sides and angles of a parallelogram are equal to one another, and the diameter (diagonal) bisects the parallelogram, that is, divides it into two equal parts.*

§ 17. The rest of the first book relates to areas of figures.

The theory is made to depend upon the theorems—

Prop. 35. *Parallelograms on the same base and between the same parallels are equal to one another; and*

Prop. 36. *Parallelograms on equal bases and between the same parallels are equal to one another.*

As each parallelogram is bisected by a diagonal, the last theorems hold also if the word parallelogram be replaced by "triangle," as is done in Props. 37 and 38.

It is to be remarked that Euclid proves these propositions only in the case when the parallelograms or triangles have their bases in the same straight line.

The theorems converse to the last form the contents of the next three propositions, viz.: Props. 40 and 41.—*Equal triangles, on*

the same or on equal bases, in the same straight line, and on the same side of it, are between the same parallels.

That the two cases here stated are given by Euclid in two separate propositions proved separately is characteristic of his method.

§ 18. To compare areas of other figures, Euclid shows first, in Prop. 42, how to draw a parallelogram which is equal in area to a given triangle, and has one of its angles equal to a given angle. If the given angle is right, then the problem is solved to draw a "rectangle" equal in area to a given triangle.

Next this parallelogram is transformed into another parallelogram, which has one of its sides equal to a given straight line, whilst its angles remain unaltered. This may be done by aid of the theorem in

Prop. 43. *The complements of the parallelograms which are about the diameter of any parallelogram are equal to one another.*

Thus the problem (Prop. 44) is solved to construct a parallelogram on a given line, which is equal in area to a given triangle, and which has one angle equal to a given angle (generally a right angle).

As every polygon can be divided into a number of triangles, we can now construct a parallelogram having a given angle, say a right angle, and being equal in area to a given polygon. For each of the triangles into which the polygon has been divided, a parallelogram may be constructed, having one side equal to a given straight line and one angle equal to a given angle. If these parallelograms be placed side by side, they may be added together to form a single parallelogram, having still one side of the given length. This is done in Prop. 45.

Herewith a means is found to compare areas of different polygons. We need only construct two rectangles equal in area to the given polygons, and having each one side of given length. By comparing the unequal sides we are enabled to judge whether the areas are equal, or which is the greater. Euclid does not state this consequence, but the problem is taken up again at the end of the second book, where it is shown how to construct a square equal in area to a given polygon.

Prop. 46 is: *To describe a square on a given straight line.*

§ 19. The first book concludes with one of the most important theorems in the whole of geometry, and one which has been celebrated since the earliest times. It is stated, but on doubtful authority, that Pythagoras discovered it, and it has been called by his name. If we call that side in a right-angled triangle which is opposite the right angle the hypotenuse, we may state it as follows:—

Theorem of Pythagoras (Prop. 47).—*In every right-angled triangle the square on the hypotenuse is equal to the sum of the squares of the other sides.*

And conversely—

Prop. 48. *If the square described on one of the sides of a triangle be equal to the squares described on the other sides, then the angle contained by these two sides is a right angle.*

On this theorem (Prop. 47) almost all geometrical measurement depends, which cannot be directly obtained.

BOOK II.

§ 20. The propositions in the second book are very different in character from those in the first; they all relate to areas of rectangles and squares. Their true significance is best seen by stating them in an algebraic form. This is often done by expressing the lengths of lines by aid of numbers, which tell how many times a chosen unit is contained in the lines. If there is a unit to be found which is contained an exact number of times in each side of a rectangle, it is easily seen, and generally shown in the teaching of arithmetic, that the rectangle contains a number of unit squares equal to the product of the numbers which measure the sides, a unit square being the square on the unit line. If, however, no such unit can be found, this process requires that connexion between lines and numbers which is only established by aid of ratios of lines, and which is therefore at this stage altogether inadmissible. But there exists another way of connecting these propositions with algebra, based on modern notions which seem destined greatly to change and to simplify mathematics. We shall introduce here as much of it as is required for our present purpose.

At the beginning of the second book we find a definition according to which "a rectangle is said to be 'contained' by the two sides which contain one of its right angles"; in the text this phraseology is extended by speaking of rectangles contained by any two straight lines, meaning the rectangle which has two adjacent sides equal to the two straight lines.

We shall denote a finite straight line by a single small letter, a, b, c, \dots , and the area of the rectangle contained by two lines a and b by ab , and this we shall call the product of the two lines a and b . It will be understood that this definition has nothing to do with the definition of a product of numbers.

We define as follows:—

The sum of two straight lines a and b means a straight line c which may be divided in two parts equal respectively to a and b . This sum is denoted by $a+b$.

The difference of two lines a and b (in symbols, $a-b$) means a line c which when added to b gives a ; that is,

$$a-b=c \text{ if } b+c=a.$$

The product of two lines a and b (in symbols, ab) means the area

of the rectangle contained by the lines a and b . For aa , which means the square on the line a , we write a^2 .

§ 21. The first ten of the fourteen propositions of the second book may then be written in the form of formulae as follows:—

- Prop. 1. $a(b+c+d+\dots) = ab+ac+ad+\dots$
- " 2. $ab+ac = a^2$ if $b+c=a$.
- " 3. $a(a+b) = a^2+ab$.
- " 4. $(a+b)^2 = a^2+2ab+b^2$.
- " 5. $(a+b)(a-b)+b^2 = a^2$.
- " 6. $(a+b)(a-b)+b^2 = a^2$.
- " 7. $a^2+(a-b)^2 = 2a(a-b)+b^2$.
- " 8. $4(a+b)a+b^2 = (2a+b)^2$.
- " 9. $(a+b)^2+(a-b)^2 = 2a^2+2b^2$.
- " 10. $(a+b)^2+(a-b)^2 = 2a^2+2b^2$.

It will be seen that 5 and 6, and also 9 and 10, are identical. In Euclid's statement they do not look the same, the figures being arranged differently.

If the letters a, b, c, \dots denoted numbers, it follows from algebra that each of these formulae is true. But this does not prove them in our case, where the letters denote lines, and their products areas without any reference to numbers. To prove them we have to discover the laws which rule the operations introduced, viz. addition and multiplication of segments. This we shall do now; and we shall find that these laws are the same with those which hold in algebraical addition and multiplication.

§ 22. In a sum of numbers we may change the order in which the numbers are added, and we may also add the numbers together in groups and then add these groups. But this also holds for the sum of segments and for the sum of rectangles, as a little consideration shows. That the sum of rectangles has always a meaning follows from the Props. 43-45 in the first book. These laws about addition are reducible to the two—

$$\begin{aligned} a+b &= b+a & \dots & \dots & (1), \\ a+(b+c) &= a+b+c & \dots & \dots & (2); \end{aligned}$$

or, when expressed for rectangles,

$$\begin{aligned} ab+ed &= ed+ab & \dots & \dots & (3), \\ ab+(cd+ef) &= ab+cd+ef & \dots & \dots & (4). \end{aligned}$$

The brackets mean that the terms in the bracket have been added together before they are added to another term. The more general cases for more terms may be deduced from the above.

For the product of two numbers we have the law that it remains unaltered if the factors be interchanged. This also holds for our geometrical product. For if ab denotes the area of the rectangle which has a as base and b as altitude, then ba will denote the area of the rectangle which has b as base and a as altitude. But in a rectangle we may take either of the two lines which contain it as base, and then the other will be the altitude. This gives

$$ab = ba \quad \dots \quad (5).$$

In order further to multiply a sum by a number, we have in algebra the rule:—Multiply each term of the sum, and add the products thus obtained. That this holds for our geometrical products is shown by Euclid in his first proposition of the second book, where he proves that the area of a rectangle whose base is the sum of a number of segments is equal to the sum of rectangles which have these segments separately as bases. In symbols this gives, in the simplest case,

$$\begin{aligned} a(b+c) &= ab+ac \\ (b+c)a &= ba+ca \end{aligned} \quad \dots \quad (6).$$

To these laws, which have been investigated by Sir William Hamilton and by Hermann Grassmann, the former has given special names. He calls the laws expressed in

- (1) and (3) the commutative law for addition;
- (2) and (4) the associative laws for addition;
- (5) multiplication;
- (6) the distributive law.

§ 23. Having proved that these six laws hold, we can at once prove every one of the above propositions in their algebraical form. The first is proved geometrically, it being one of the fundamental laws. The next two propositions are only special cases of the first. Of the others we shall prove one, viz. the fourth:—

$$\begin{aligned} \text{But } (a+b)^2 &= (a+b)(a+b) = (a+b)a + (a+b)b & \text{by (6).} \\ &= (a+b)a + aa + ba & \text{by (6).} \\ &= aa + ab & \text{by (5);} \\ \text{and } (a+b)^2 &= ab + bb & \text{by (6).} \\ \text{Therefore } (a+b)^2 &= aa + ab + (ab + bb) & \text{by (4).} \\ &= aa + (ab + ab) + bb \\ &= aa + 2ab + bb \end{aligned}$$

This gives the theorem in question. In the same manner every one of the first ten propositions is proved.

It will be seen that the operations performed are exactly the same as if the letters denoted numbers.

Props. 5 and 6 may also be written thus—

$$(a+b)(a-b) = a^2 - b^2.$$

Prop. 7, which is an easy consequence of Prop. 4, may be transformed. If we denote by c the line $a+b$, so that

$$c = a+b, \quad a = c-b,$$

we get

$$\begin{aligned} c^2 + (c-b)^2 &= 2c(c-b) + b^2 \\ &= 2c^2 - 2bc + b^2. \end{aligned}$$

Subtracting c^2 from both sides, and writing a for c , we get

$$(a-b)^2 = a^2 - 2ab + b^2.$$

In Euclid's *Elements* this form of the theorem does not appear, all propositions being so stated that the notion of subtraction does not enter into them.

§ 24. The remaining two theorems (Props. 12 and 13) connect the square on one side of a triangle with the sum of the squares on the other sides, in case that the angle between the latter is acute or obtuse. They are important theorems in trigonometry, where it is possible to include them in a single theorem.

§ 25. There are in the second book two problems, Props. 11 and 14.

If written in the above symbolic language, the former requires to find a line x such that $a(a-x) = x^2$. Prop. 11 contains, therefore, the solution of a quadratic equation, which we may write $x^2+ax = a^2$. The solution is required later on in the construction of a regular decagon.

More important is the problem in the last proposition (Prop. 14). It requires the construction of a square equal in area to a given rectangle, hence a solution of the equation

$$x^2 = ab.$$

In Book I., 42-45, it has been shown how a rectangle may be constructed equal in area to a given figure bounded by straight lines. By aid of the new proposition we may therefore now determine a line such that the square on that line is equal in area to any given rectilinear figure, or we can square any such figure.

As of two squares that is the greater which has the greater side, it follows that now the comparison of two areas has been reduced to the comparison of two lines.

The problem of reducing other areas to squares is frequently met with among Greek mathematicians. We need only mention the problem of squaring the circle (see CIRCLE).

In the present day the comparison of areas is performed in a simpler way by reducing all areas to rectangles having a common base. Their altitudes give then a measure of their areas.

The construction of a rectangle having the base a , and being equal in area to a given rectangle, depends upon Prop. 43, I. This therefore gives a solution of the equation

$$ab = ax,$$

where x denotes the unknown altitude.

BOOK III.

§ 26. The third book of the *Elements* relates exclusively to properties of the circle. A circle and its circumference have been defined in Book I., Def. 15. We restate it here in slightly different words:—

Definition.—The circumference of a circle is a plane curve such that all points in it have the same distance from a fixed point in the plane. This point is called the "centre" of the circle.

Of the new definitions, of which eleven are given at the beginning of the third book, a few only require special mention. The first, which says that circles with equal radii are equal, is in part a theorem, but easily proved by applying the one circle to the other. Or it may be considered proved by aid of Prop. 24, equal circles not being used till after this theorem.

In the second definition is explained what is meant by a line which "touches" a circle. Such a line is now generally called a tangent to the circle. The introduction of this name allows us to state many of Euclid's propositions in a much shorter form.

For the same reason we shall call a straight line joining two points on the circumference of a circle a "chord."

Definitions 4 and 5 may be replaced with a slight generalization by the following:—

Definition.—By the distance of a point from a line is meant the length of the perpendicular drawn from the point to the line.

§ 27. From the definition of a circle it follows that every circle has a centre. Prop. 1 requires to find it when the circle is given, i.e. when its circumference is drawn.

To solve this problem a chord is drawn (that is, any two points in the circumference are joined), and through the point where this is bisected a perpendicular to it is erected. Euclid then proves, first, that no point off this perpendicular can be the centre, hence that the centre must lie in this line; and, secondly, that of the points on the perpendicular one only can be the centre, viz. the one which bisects the parts of the perpendicular bounded by the circle. In the second part Euclid silently assumes that the perpendicular there used does cut the circumference in two, and only in two points. The proof therefore is incomplete. The proof of the first part, however, is exact. By drawing two non-parallel chords, and the perpendiculars which bisect them, the centre will be found as the point where these perpendiculars intersect.

§ 28. In Prop. 2 it is proved that a chord of a circle lies altogether within the circle.

What we have called the first part of Euclid's solution of Prop. 1 may be stated as a theorem:—

Every straight line which bisects a chord, and is at right angles to it, passes through the centre of the circle.

The converse to this gives Prop. 3, which may be stated thus:—

If a straight line through the centre of a circle bisect a chord, then it is perpendicular to the chord, and if it be perpendicular to the chord it bisects it.

An easy consequence of this is the following theorem, which is essentially the same as Prop. 4:—

Two chords of a circle, of which neither passes through the centre, cannot bisect each other.

These last three theorems are fundamental for the theory of the circle. It is to be remarked that Euclid never proves that a straight line cannot have more than two points in common with a circumference.

§ 29. The next two propositions (5 and 6) might be replaced by a single and a simpler theorem, viz:—

Two circles which have a common centre, and whose circumferences have one point in common, coincide.

Or, more in agreement with Euclid's form:—

Two different circles, whose circumferences have a point in common, cannot have the same centre.

That Euclid treats of two cases is characteristic of Greek mathematics.

The next two propositions (7 and 8) again belong together. They may be combined thus:—

If from a point in a plane of a circle, which is not the centre, straight lines be drawn to the different points of the circumference, then of all these lines one is the shortest, and one the longest, and these be both in that straight line which joins the given point to the centre. Of all the remaining lines each is equal to one and only one other, and these equal lines lie on opposite sides of the shortest or longest, and make equal angles with them.

Euclid distinguishes the two cases where the given point lies within or without the circle, omitting the case where it lies in the circumference.

From the last proposition it follows that if from a point more than two equal straight lines can be drawn to the circumference, this point must be the centre. This is Prop. 9.

As a consequence of this we get

If the circumferences of the two circles have three points in common they coincide.

For in this case the two circles have a common centre, because from the centre of the one three equal lines can be drawn to points on the circumference of the other. But two circles which have a common centre, and whose circumferences have a point in common, coincide. (Compare above statement of Props. 5 and 6.)

This theorem may also be stated thus:—

Through three points only one circumference may be drawn; or, Three points determine a circle.

Euclid does not give the theorem in this form. He proves, however, that the two circles cannot cut another in more than two points (Prop. 10), and that two circles cannot touch one another in more points than one (Prop. 13).

§ 30. Propositions 11 and 12 assert that if two circles touch, then the point of contact lies on the line joining their centres. This gives two propositions, because the circles may touch either internally or externally.

§ 31. Propositions 14 and 15 relate to the length of chords. The first says that equal chords are equidistant from the centre, and that chords which are equidistant from the centre are equal;

Whilst Prop. 15 compares unequal chords, viz. *Of all chords the diameter is the greatest, and of other chords that is the greater which is nearer to the centre; and conversely, the greater chord is nearer to the centre.*

§ 32. In Prop. 16 the tangent to a circle is for the first time introduced. The proposition is meant to show that the straight line at the end point of the diameter and at right angles to it is a tangent. The proposition itself does not state this. It runs thus:—

Prop. 16. *The straight line drawn at right angles to the diameter of a circle, from the extremity of it, falls without the circle; and no straight line can be drawn from the extremity, between that straight line and the circumference, so as not to cut the circle.*

Corollary.—The straight line at right angles to a diameter drawn through the end point of it touches the circle.

The statement of the proposition and its whole treatment show the difficulties which the tangents presented to Euclid.

Prop. 17 solves the problem through a given point, either in the circumference or without it, to draw a tangent to a given circle.

Closely connected with Prop. 16 are Props. 18 and 19, which state (Prop. 18), that the line joining the centre of a circle to the point of contact of a tangent is perpendicular to the tangent; and conversely (Prop. 19), that the straight line through the point of contact of, and perpendicular to, a tangent to a circle passes through the centre of the circle.

§ 33. The rest of the book relates to angles connected with a circle, viz. angles which have the vertex either at the centre or on the circumference, and which are called respectively angles at the centre and angles at the circumference. Between these

two kinds of angles exists the important relation expressed as follows:—

Prop. 20. *The angle at the centre of a circle is double of the angle at the circumference on the same base, that is, on the same arc.*

This is of great importance for its consequences, of which the two following are the principal:—

Prop. 21. *The angles in the same segment of a circle are equal to one another;*

Prop. 22. *The opposite angles of any quadrilateral figure inscribed in a circle are together equal to two right angles.*

Further consequences are:—

Prop. 23. *On the same straight line, and on the same side of it, there cannot be two similar segments of circles, not coinciding with one another;*

Prop. 24. *Similar segments of circles on equal straight lines are equal to one another.*

The problem Prop. 25. *A segment of a circle being given to describe the circle of which it is a segment, may be solved much more easily by aid of the construction described in relation to Prop. 1, III., in § 27.*

§ 34. There follow four theorems connecting the angles at the centre, the arcs into which they divide the circumference, and the chords subtending these arcs. They are expressed for angles, arcs and chords in equal circles, but they hold also for angles, arcs and chords in the same circle.

The theorems are:—

Prop. 26. *In equal circles equal angles stand on equal arcs, whether they be at the centres or circumferences;*

Prop. 27. (converse to Prop. 26). *In equal circles the angles which stand on equal arcs are equal to one another, whether they be at the centres or the circumferences;*

Prop. 28. *In equal circles equal straight lines (equal chords) cut off equal arcs, the greater equal to the greater, and the less equal to the less;*

Prop. 29 (converse to Prop. 28). *In equal circles equal arcs are subtended by equal straight lines.*

§ 35. Other important consequences of Props. 20-22 are:—

Prop. 31. *In a circle the angle in a semicircle is a right angle; but the angle in a segment greater than a semicircle is less than a right angle; and the angle in a segment less than a semicircle is greater than a right angle;*

Prop. 32. *If a straight line touch a circle, and from the point of contact a straight line be drawn cutting the circle, the angles which this line makes with the line touching the circle shall be equal to the angles which are in the alternate segments of the circle.*

§ 36. Propositions 30, 33, 34, contain problems which are solved by aid of the propositions preceding them:—

Prop. 30. *To bisect a given arc, that is, to divide it into two equal parts.*

Prop. 33. *On a given straight line to describe a segment of a circle containing an angle equal to a given rectilinear angle;*

Prop. 34. *From a given circle to cut off a segment containing an angle equal to a given rectilinear angle.*

§ 37. If we draw chords through a point A within a circle, they will each be divided by A into two segments. Between these segments the law holds that the rectangle contained by them has the same area on whatever chord through A the segments are taken. The value of this rectangle changes, of course, with the position of A.

A similar theorem holds if the point A be taken without the circle. On every straight line through A, which cuts the circle in two points B and C, we have two segments AB and AC, and the rectangles contained by them are again equal to one another, and equal to the square on a tangent drawn from A to the circle.

The first of these theorems gives Prop. 35, and the second Prop. 36, with its corollary, whilst Prop. 37, the last of Book III., gives the converse to Prop. 36. The first two theorems may be combined in one:—

If through a point A in the plane of a circle a straight line be drawn cutting the circle in B and C, then the rectangle AB.AC has a constant value so long as the point A be fixed; and if from A a tangent AD can be drawn to the circle, touching at D, then the above rectangle equals the square on AD.

Prop. 37 may be stated thus:—

If from a point A without a circle a line be drawn cutting the circle in B and C, and another line to a point D on the circle, and AB.AC = AD², then the line AD touches the circle at D.

It is not difficult to prove also the converse to the general proposition as above stated. This proposition and its converse may be expressed as follows:—

If four points ABCD be taken on the circumference of a circle, and if the lines AB, CD, produced if necessary, meet at E, then

$$EA.EB = EC.ED;$$

and conversely, if this relation holds then the four points lie on a circle, that is, the circle drawn through three of them passes through the fourth.

That a circle may always be drawn through three points, provided that they do not lie in a straight line, is proved only later on in Book IV

BOOK IV.

§ 38. The fourth book contains only problems, all relating to the construction of triangles and polygons inscribed in and circumscribed about circles, and of circles inscribed in or circumscribed about triangles and polygons. They are nearly all given for their own sake, and not for future use in the construction of figures, as are most of those in the former books. In seven definitions at the beginning of the book it is explained what is understood by figures inscribed in or described about other figures, with special reference to the case where one figure is a circle. Instead, however, of saying that one figure is described about another, it is now generally said that the one figure is circumscribed about the other. We may then state the definitions 3 or 4 thus:—

Definition.—A polygon is said to be inscribed in a circle, and the circle is said to be circumscribed about the polygon, if the vertices of the polygon lie in the circumference of the circle.

And definitions 5 and 6 thus:—

Definition.—A polygon is said to be circumscribed about a circle, and a circle is said to be inscribed in a polygon, if the sides of the polygon are tangents to the circle.

§ 39. The first problem is merely constructive. It requires to draw in a given circle a chord equal to a given straight line, which is not greater than the diameter of the circle. The problem is not a determinate one, inasmuch as the chord may be drawn from any point in the circumference. This may be said of almost all problems in this book, especially of the next two. They are:—

Prop. 2. *In a given circle to inscribe a triangle equiangular to a given triangle.*

Prop. 3. *About a given circle to circumscribe a triangle equiangular to a given triangle.*

§ 40. Of somewhat greater interest are the next problems, where the triangles are given and the circles to be found.

Prop. 4. *To inscribe a circle in a given triangle.*

The result is that the problem has always a solution, viz. the centre of the circle is the point where the bisectors of two of the interior angles of the triangle meet. The solution shows, though Euclid does not state this, that the problem has but one solution; and also,

The three bisectors of the interior angles of any triangle meet in a point, and this is the centre of the circle inscribed in the triangle.

The solutions of most of the other problems contain also theorems. Of these we shall state those which are of special interest; Euclid does not state any one of them.

§ 41. Prop. 5. *To circumscribe a circle about a given triangle.*

The one solution which always exists contains the following:—

The three straight lines which bisect the sides of a triangle at right angles meet in a point, and this point is the centre of the circle circumscribed about the triangle.

Euclid adds in a corollary the following property:—

The centre of the circle circumscribed about a triangle lies within, on a side of, or without the triangle, according as the triangle is acute-angled, right-angled or obtuse-angled.

§ 42. Whilst it is always possible to draw a circle which is inscribed in or circumscribed about a given triangle, this is not the case with quadrilaterals or polygons of more sides. Of those for which this is possible the regular polygons, i.e. polygons which have all their sides and angles equal, are the most interesting. In each of them a circle may be inscribed, and another may be circumscribed about it.

Euclid does not use the word regular, but he describes the polygons in question as *equiangular* and *equilateral*. We shall use the name regular polygon. The regular triangle is equilateral, the regular quadrilateral is the square.

Euclid considers the regular polygons of 4, 5, 6 and 15 sides. For each of the first three he solves the problems—(1) to inscribe such a polygon in a given circle; (2) to circumscribe it about a given circle; (3) to inscribe a circle in, and (4) to circumscribe a circle about, such a polygon.

For the regular triangle the problems are not repeated, because more general problems have been solved.

Props. 6, 7, 8 and 9 solve these problems for the square.

The general problem of inscribing in a given circle a regular polygon of n sides depends upon the problem of dividing the circumference of a circle into n equal parts, or what comes to the same thing, of drawing from the centre of the circle n radii such that the angles between consecutive radii are equal, that is, to divide the space about the centre into n equal angles. Thus, if it is required to inscribe a square in a circle, we have to draw four lines from the centre, making the four angles equal. This is done by drawing two diameters at right angles to one another. The ends of these diameters are the vertices of the required square. If, on the other hand, tangents be drawn at these ends, we obtain a square circumscribed about the circle.

§ 43. To construct a regular pentagon, we find it convenient first to construct a regular decagon. This requires to divide the space about the centre into ten equal angles. Each will be $\frac{1}{10}$ th of a right angle, or $\frac{1}{10}$ th of two right angles. If we suppose the decagon constructed, and if we join the centre to the end of one side, we get an *isosceles triangle*, where the angle at the centre equals $\frac{1}{10}$ th of two right angles; hence each of the angles at the base will be $\frac{1}{10}$ th of

two right angles, as all three angles together equal two right angles. Thus we have to construct an isosceles triangle, having the angle at the vertex equal to half an angle at the base. This is solved in Prop. 10, by aid of the problem in Prop. 11 of the second book. If we make the sides of this triangle equal to the radius of the given circle, then the base will be the side of the regular decagon inscribed in the circle. This side being known the decagon can be constructed, and if the vertices are joined alternately, leaving out half their number, we obtain the regular pentagon. (Prop. 11.)

Euclid does not proceed thus. He wants the pentagon before the decagon. This, however, does not change the real nature of his solution, nor does his solution become simpler by not mentioning the decagon.

Once the regular pentagon is inscribed, it is easy to circumscribe another by drawing tangents at the vertices of the inscribed pentagon. This is shown in Prop. 12.

Props. 13 and 14 teach how a circle may be inscribed in or circumscribed about any given regular pentagon.

§ 44. The regular hexagon is more easily constructed, as shown in Prop. 15. The result is that the side of the regular hexagon inscribed in a circle is equal to the radius of the circle.

For this polygon the other three problems mentioned are not solved.

§ 45. The book closes with Prop. 16. To inscribe a regular quidecagon in a given circle. If we inscribe a regular pentagon and a regular hexagon in the circle, having one vertex in common, then the arc from the common vertex to the next vertex of the pentagon is $\frac{1}{10}$ th of the circumference, and to the next vertex of the hexagon is $\frac{1}{6}$ th of the circumference. The difference between these arcs is, therefore, $\frac{1}{30}$ th of the circumference. The latter may, therefore, be divided into thirty, and hence also in fifteen equal parts, and the regular quidecagon be described.

§ 46. We conclude with a few theorems about regular polygons which are not given by Euclid.

The straight lines perpendicular to and bisecting the sides of any regular polygon meet in a point. The straight lines bisecting the angles in the regular polygon meet in the same point. This point is the centre of the circles circumscribed about and inscribed in the regular polygon.

We can bisect any given arc (Prop. 30, III.). Hence we can divide a circumference into $2n$ equal parts as soon as it has been divided into n equal parts, or as soon as a regular polygon of n sides has been constructed. Hence—

If a regular polygon of n sides has been constructed, then a regular polygon of $2n$ sides, of $4n$, of $8n$ sides, &c., may also be constructed. Euclid shows how to construct regular polygons of 3, 4, 5 and 15 sides. It follows that we can construct regular polygons of

3,	6,	12,	24...	sides
4,	8,	16,	32...	..
5,	10,	20,	40...	..
15,	30,	60,	120...	..

The construction of any new regular polygon not included in one of these series will give rise to a new series. Till the beginning of the 19th century nothing was added to the knowledge of regular polygons as given by Euclid. Then Gauss, in his celebrated *Arithmetik*, proved that every regular polygon of $2^n + 1$ sides may be constructed if this number $2^n + 1$ be prime, and that no others except those with $2^n(2^n + 1)$ sides can be constructed by elementary methods. This shows that regular polygons of 7, 9, 13 sides cannot thus be constructed, but that a regular polygon of 17 sides is possible; for $17 = 2^4 + 1$. The next polygon is one of 257 sides. The construction becomes already rather complicated for 17 sides.

BOOK V.

§ 47. The fifth book of the *Elements* is not exclusively geometrical. It contains the theory of ratios and proportion of quantities in general. The treatment, as here given, is admirable, and in every respect superior to the algebraical method by which Euclid's theory is now generally replaced. We shall treat the subject in order to show why the usual algebraical treatment of proportion is not really sound. We begin by quoting those definitions at the beginning of Book V. which are most important. These definitions have given rise to much discussion.

The only definitions which are essential for the fifth book are Defs. 1, 2, 4, 5, 6 and 7. Of the remainder 3, 8 and 9 are more than useless, and probably not Euclid's, but additions of later editors, of whom Theon of Alexandria was the most prominent. Defs. 10 and 11 belong rather to the sixth book, whilst all the others are merely nominal. The really important ones are 4, 5, 6 and 7.

§ 48. To define a magnitude is not attempted by Euclid. The first two definitions state what is meant by a "part," that is, a submultiple or measure, and by a "multiple" of a given magnitude. The meaning of Def. 4 is that two given quantities can have a ratio to one another only in case that they are comparable as to their magnitude, that is, if they are of the same kind.

Def. 3, which is probably due to Theon, professes to define a ratio, but is as meaningless as it is uncalled for, for all that is wanted is given in Defs. 5 and 7.

In Def. 5 it is explained what is meant by saying that two magnitudes have the same ratio to one another as two other magnitudes.

and in Def. 7 what we have to understand by a greater or a less ratio. The 6th definition is only nominal, explaining the meaning of the word *proportional*.

Euclid represents magnitudes by lines, and often denotes them either by single letters or, like lines, by two letters. We shall use only single letters for the purpose. If a and b denote two magnitudes of the same kind; their ratio will be denoted by $a : b$; if c and d are two other magnitudes of the same kind, but possibly of a different kind from a and b , then if c and d have the same ratio to one another as a and b , this will be expressed by writing—

$$a : b :: c : d.$$

Further, if m is a (whole) number, ma shall denote the multiple of a which is obtained by taking it m times.

§ 49. The whole theory of ratios is based on Def. 5.

Def. 5. *The first of four magnitudes is said to have the same ratio to the second that the third has to the fourth when, any equimultiples whatever of the first and the third being taken, and any equimultiples whatever of the second and the fourth, if the multiple of the first be less than that of the second, the multiple of the third is also less than that of the fourth; and if the multiple of the first is equal to that of the second, the multiple of the third is also equal to that of the fourth; and if the multiple of the first is greater than that of the second, the multiple of the third is also greater than that of the fourth.*

It will be well to show at once in an example how this definition can be used, by proving the first part of the first proposition in the sixth book. *Triangles of the same altitude are to one another as their bases, or if a and b are the bases, and α and β the areas, of two triangles which have the same altitude, then $a : b :: \alpha : \beta$.*

To prove this, we have, according to Definition 5, to show—

$$\begin{aligned} \text{if } ma > nb, & \text{ then } m\alpha > n\beta, \\ \text{if } ma = nb, & \text{ then } m\alpha = n\beta, \\ \text{if } ma < nb, & \text{ then } m\alpha < n\beta. \end{aligned}$$

That this is true is in our case easily seen. We may suppose that the triangles have a common vertex, and their bases in the same line. We set off the base a along the line containing the bases m times; we then join the different parts of division to the vertex, and get m triangles all equal to α . The triangle on nb as base equals, therefore, $m\alpha$. If we proceed in the same manner with the base b , setting it off n times, we find that the area of the triangle on the base nb equals $n\beta$, the vertex of all triangles being the same. But if two triangles have the same altitude, then their areas are equal if the bases are equal; hence $m\alpha = n\beta$ if $ma = nb$, and if their bases are unequal, then that has the greater area which is on the greater base; in other words, $m\alpha$ is greater than, equal to, or less than $n\beta$, according as ma is greater than, equal to, or less than nb , which was to be proved.

§ 50. It will be seen that even in this example it does not become evident what a ratio really is. It is still an open question whether ratios are magnitudes which we can compare. We do not know whether the ratio of two lines is a magnitude of the same kind as the ratio of two areas. Though we might say that Def. 5 defines equal ratios, still we do not know whether they are equal in the sense of the axiom, that two things which are equal to a third are equal to one another. That this is the case requires a proof, and until this proof is given we shall use the : instead of the sign =, which, however, we shall afterwards introduce.

As soon as it has been established that all ratios are like magnitudes, it becomes easy to show that, in some cases at least, they are numbers. This step was never made by Greek mathematicians. They distinguished always most carefully between continuous magnitudes and the discrete series of numbers. In modern times it has become the custom to ignore this difference.

If, in determining the ratio of two lines, a common measure can be found, which is contained m times in the first, and n times in the second, then the ratio of the two lines equals the ratio of the two numbers $m : n$. This is shown by Euclid in Prop. 5, X. But the ratio of two numbers is, as a rule, a fraction, and the Greeks did not, as we do, consider fractions as numbers. Far less had they any notion of introducing irrational numbers, which are neither whole nor fractional, as we are obliged to do if we wish to say that all ratios are numbers. The incommensurable numbers which are thus introduced as ratios of incommensurable quantities are nowadays as familiar to us as fractions; but a proof is generally omitted that we may apply to them the rules which have been established for rational numbers only. Euclid's treatment of ratios avoids this difficulty. His definitions hold for commensurable as well as for incommensurable quantities. Even the notion of incommensurable quantities is avoided in Book V. But he proves that the more elementary rules of algebra hold for ratios. We shall state all his propositions in that algebraical form to which we are now accustomed. This may, of course, be done without changing the character of Euclid's method.

§ 51. Using the notation explained above we express the first propositions as follows:—

Prop. 1. If $a = ma', b = mb', c = mc',$
then $a + b + c = m(a' + b' + c').$

Prop. 2. If $a = mb, \text{ and } c = md,$
 $e = nb, \text{ and } f = nd,$

then $a + e$ is the same multiple of b as $c + f$ is of d , viz.:

$$a + e = (m + n)b, \text{ and } c + f = (m + n)d.$$

Prop. 3. If $a = mb, c = md$, then is na the same multiple of b that nc is of d , viz. $na = nmb, nc = nmd$.

Prop. 4. If $a : b :: c : d,$
then $ma : mb :: mc : md.$

Prop. 5. If $a = mb, \text{ and } c = md,$
then $a - c = m(b - d).$

Prop. 6. If $a = mb, c = md,$
then are $a - nb$ and $c - nd$ either equal to, or equimultiples of, b and d , viz. $a - nb = (m - n)b$ and $c - nd = (m - n)d$, where $m - n$ may be unity.

All these propositions relate to *equimultiples*. Now follow propositions about ratios which are compared as to their magnitude.

§ 52. Prop. 7. If $a = b$, then $a : c :: b : c$ and $c : a :: c : b$.

The proof is simply this. As $a = b$ we know that $ma = mb$; therefore if $m\alpha > nc$, then $mb > nc$, $ma = nc$, then $mb = nc$, $ma < nc$, then $mb < nc$, if

therefore the first proportion holds by Definition 5.

Prop. 8. If $a > b$, then $a : c > b : c,$
and $c : a < c : b.$

The proof depends on Definition 7.

Prop. 9 (converse to Prop. 7). If

$$\begin{aligned} a : c :: b : c, \\ c : a :: c : b, \end{aligned} \text{ then } a = b.$$

Prop. 10 (converse to Prop. 8). If

$$\begin{aligned} a : c > b : c, \text{ then } a > b \\ c : a < c : b, \text{ then } a < b. \end{aligned}$$

Prop. 11. If $a : b :: c : d,$
and $b : e :: f : g,$
then $c : d :: e : f.$

In words, if two ratios are equal to a third, they are equal to one another. After these propositions have been proved, we have a right to consider a ratio as a *magnitude*, for only now can we consider a ratio as something for which the axiom about magnitudes holds: things which are equal to a third are equal to one another.

We shall indicate this by writing in future the sign = instead of : . . . The remaining propositions, which explain themselves, may then be stated as follows:

§ 53. Prop. 12. If $a : b = c : d = e : f,$
then $a + c + e : b + d + f = a : b.$

Prop. 13. If $a : b = c : d$ and $c : d > e : f,$
then $a : b > e : f.$

Prop. 14. If $a : b = c : d$, and $a > c$, then $b > d$.

Prop. 15. Magnitudes have the same ratio to one another that their equimultiples have—

$$ma : mb = a : b.$$

Prop. 16. If a, b, c, d are magnitudes of the same kind, and if

$$\begin{aligned} a : b = c : d, \\ a : c = b : d, \end{aligned}$$

Prop. 17. If $a + b : b = c + d : d,$
then $a : b = c : d.$

Prop. 18 (converse to 17). If

$$\begin{aligned} a : b = c : d \\ a + b : b = c + d : d. \end{aligned}$$

Prop. 19. If a, b, c, d are quantities of the same kind, and if

$$\begin{aligned} a : b = c : d, \\ a - c : b - d = a : b. \end{aligned}$$

§ 54. Prop. 20. If there be three magnitudes, and another three, which have the same ratio, taken two and two, then if the first be greater than the third, the fourth shall be greater than the sixth; and if equal, equal; and if less, less.

If we understand by

$$a : b : c : d : e : \dots = a' : b' : c' : d' : e' : \dots$$

that the ratio of any two consecutive magnitudes on the first side equals that of the corresponding magnitudes on the second side, we may write this theorem in symbols, thus:—

If a, b, c be quantities of one, and d, e, f magnitudes of the same or any other kind, such that

$$\begin{aligned} \text{and if } a : b = c : d = e : f, \\ \text{but if } a > c, \text{ then } d > f, \\ \text{and if } a = c, \text{ then } d = f, \\ \text{and if } a < c, \text{ then } d < f, \end{aligned}$$

Prop. 21. If $a : b = c : f$ and $b : c = d : e,$

or if $a : b : c = \frac{1}{2} : \frac{1}{3} : \frac{1}{6}$

and if $a > c$, then $d > f$,
but if $a = c$, then $d = f$,
and if $a < c$, then $d < f$.

By aid of these two propositions the following two are proved.
§ 53. Prop. 22. *If there be any number of magnitudes, and as many others, which have the same ratio, taken two and two in order, the first shall have to the last of the first magnitudes the same ratio which the first of the others has to the last.*

We may state it more generally, thus:—
If $a : b : c : d : e : \dots = a' : b' : c' : d' : e' : \dots$,

then not only have two consecutive, but any two magnitudes on the first side, the same ratio as the corresponding magnitudes on the other. For instance—

$$a : c = a' : c' ; b : e = b' : e' , \&c.$$

Prop. 23 we state only in symbols, viz. :—

$$\text{If } a : b : c : d : e : \dots = \frac{1}{a} : \frac{1}{b} : \frac{1}{c} : \frac{1}{d} : \frac{1}{e} : \dots,$$

then $a : c = c' : a'$,
 $b : e = e' : b'$,

and so on.

Prop. 24 comes to this :— If $a : b = c : d$ and $e : f = d : e$, then $a + e : b + c = f : d$.

Some of the proportions which are considered in the above propositions have special names. These we have omitted, as being of no use, since algebra has enabled us to bring the different operations contained in the propositions under a common point of view.

§ 56. The last proposition in the fifth book is of a different character.

Prop. 25. *If four magnitudes of the same kind be proportional, the greatest and least of them together shall be greater than the other two together.* In symbols—

If a, b, c, d be magnitudes of the same kind, and if $a : b = c : d$, and if a is the greatest, hence d the least, then $a + d > b + c$.

§ 57. We return once again to the question, What is a ratio? We have seen that we may treat ratios as magnitudes, and that all ratios are magnitudes of the same kind, for we may compare any two as to their magnitude. It will presently be shown that ratios of lines may be considered as *quotients* of lines, so that a ratio appears as answer to the question, How often is one line contained in another? But the answer to this question is given by a number, at least in some cases, and in all cases if we admit incommensurable numbers. Considered from this point of view, we may say the fifth book of the *Elements* shows that some of the simpler algebraical operations hold for incommensurable numbers. In the ordinary algebraical treatment of numbers this proof is altogether omitted, or given by a process of limits which does not seem to be natural to the subject.

BOOK VI.

§ 58. The sixth book contains the theory of similar figures. After a few definitions explaining terms, the first proposition gives the first application of the theory of proportion.

Prop. 1. *Triangles and parallelograms of the same altitude are to one another as their bases.*

The proof has already been considered in § 49.

From this follows easily the important theorem
Prop. 2. *If a straight line be drawn parallel to one of the sides of a triangle it shall cut the other sides, or those sides produced, proportionally; and if the sides or the sides produced be cut proportionally, the straight line which joins the points of section shall be parallel to the remaining side of the triangle.*

§ 59. The next proposition, together with one added by Simson as Prop. A, may be expressed more conveniently if we introduce a modern phraseology, viz. if in a line AB we assume a point C between A and B, we shall say that C divides AB internally in the ratio AC : CB; but if C be taken in the line AB produced, we shall say that AB is divided externally in the ratio AC : CB.

The two propositions then come to this:
Prop. 3. *The bisector of an angle in a triangle divides the opposite side internally in a ratio equal to the ratio of the two sides including that angle; and conversely, if a line through the vertex of a triangle divide the base internally in the ratio of the two other sides, then that line bisects the angle at the vertex.*

Simson's Prop. A. *The line which bisects an exterior angle of a triangle divides the opposite side externally in the ratio of the other sides; and conversely, if a line through the vertex of a triangle divide the base externally in the ratio of the sides, then it bisects an exterior angle at the vertex of the triangle.*

If we combine both we have—
The two lines which bisect the interior and exterior angles at one vertex of a triangle divide the opposite side internally and externally in the same ratio, viz. in the ratio of the other two sides.

§ 60. The next four propositions contain the theory of similar triangles, of which four cases are considered. They may be stated together.

Two triangles are similar,—
1. (Prop. 4.) *If the triangles are equiangular;*

2. (Prop. 5.) *If the sides of the one are proportional to those of the other;*

3. (Prop. 6.) *If two sides in one are proportional to two sides in the other, and if the angles contained by these sides are equal;*

4. (Prop. 7.) *If two sides in one are proportional to two sides in the other, if the angles opposite homologous sides are equal, and if the angles opposite the other homologous sides are both acute, both right or both obtuse; homologous sides being in each case those which are opposite equal angles.*

An important application of these theorems is at once made to a right-angled triangle, viz. :—

Prop. 8. *In a right-angled triangle, if a perpendicular be drawn from the right angle to the base, the triangles on each side of it are similar to the whole triangle, and to one another.*

Corollary.—From this it is manifest that the perpendicular drawn from the right angle of a right-angled triangle to the base is a mean proportional between the segments of the base, and also that each of the sides is a mean proportional between the base and the segment of the base adjacent to that side.

§ 61. There follow four propositions containing problems, in language slightly different from Euclid's, viz. :—

Prop. 9. *To divide a straight line into a given number of equal parts.*

Prop. 10. *To divide a straight line in a given ratio.*

Prop. 11. *To find a third proportional to two given straight lines.*

Prop. 12. *To find a fourth proportional to three given straight lines.*

Prop. 13. *To find a mean proportional between two given straight lines.*

The last three may be written as equations with one unknown quantity—viz. if we call the given straight lines a, b, c , and the required line x , we have to find a line x so that

$$\text{Prop. 11. } a : b = b : x ;$$

$$\text{Prop. 12. } a : b = c : x ;$$

$$\text{Prop. 13. } a : x = x : b.$$

We shall see presently how these may be written without the signs of ratios.

§ 62. Euclid considers next proportions connected with parallelograms and triangles which are equal in area.

Prop. 14. *Equal parallelograms which have one angle of the one equal to one angle of the other have their sides about the equal angles reciprocally proportional; and parallelograms which have one angle of the one equal to one angle of the other, and their sides about the equal angles reciprocally proportional, are equal to one another.*

Prop. 15. *Equal triangles which have one angle of the one equal to one angle of the other, have their sides about the equal angles reciprocally proportional; and triangles which have one angle of the one equal to one angle of the other, and their sides about the equal angles reciprocally proportional, are equal to one another.*

The latter proposition is really the same as the former, for if, as in the accompanying diagram,

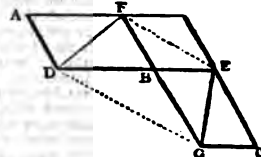

in the figure belonging to the former the two equal parallelograms AB and BC be bisected by the lines DF and EG, and if EF be drawn, we get the figure belonging to the latter.

It is worth noticing that the lines FB and DG are parallel. We may state therefore the theorem—

If two triangles are equal in area, and have one angle in the one vertically opposite to one angle in the other, then the two straight lines which join the remaining two vertices of the one to those of the other triangle are parallel.

§ 63. A most important theorem is

Prop. 16. *If four straight lines be proportionals, the rectangle contained by the extremes is equal to the rectangle contained by the means; and if the rectangle contained by the extremes be equal to the rectangle contained by the means, the four straight lines are proportionals.*

In symbols, if a, b, c, d are the four lines, and

$$\text{if } a : b = c : d,$$

$$\text{then } ad = bc,$$

$$\text{and conversely, if } ad = bc,$$

$$\text{then } a : b = c : d,$$

where ad and bc denote (as in § 20), the areas of the rectangles contained by a and d and by b and c respectively.

This allows us to transform every proportion between four lines into an equation between two products.

It shows further that the operation of forming a product of two lines, and the operation of forming their ratio are each the inverse of the other.

If we now define a quotient $\frac{a}{b}$ of two lines as the number which multiplied into b gives a , so that

$$\frac{a}{b} \cdot b = a.$$

we see that from the equality of two quotients

$$\frac{a}{b} = \frac{c}{d}$$

follows, if we multiply both sides by bd ,

$$\frac{a}{b} \cdot d = \frac{c}{d} \cdot b, \\ ad = cb.$$

But from this it follows, according to the last theorem, that

$$a : b = c : d$$

Hence we conclude that the quotient $\frac{a}{b}$ and the ratio $a : b$ are different forms of the same magnitude, only with this important difference that the quotient $\frac{a}{b}$ would have a meaning only if a and b have a common measure, until we introduce incommensurable numbers, while the ratio $a : b$ has always a meaning, and thus gives rise to the introduction of incommensurable numbers.

Thus it is really the theory of ratios in the fifth book which enables us to extend the geometrical calculus given before in connexion with Book II. It will also be seen that if we write the ratios in Book V. as quotients, or rather as fractions, then most of the theorems state properties of quotients or of fractions.

§ 64. Prop. 17. *If three straight lines are proportional the rectangle contained by the extremes is equal to the square on the mean; and conversely, is only a special case of 16. After the problem, Prop. 18, On a given straight line to describe a rectilinear figure similar and similarly situated to a given rectilinear figure, there follows another fundamental theorem:*

Prop. 19. *Similar triangles are to one another in the duplicate ratio of their homologous sides. In other words, the areas of similar triangles are to one another as the squares on homologous sides. This is generalized in:*

Prop. 20. *Similar polygons may be divided into the same number of similar triangles, having the same ratio to one another that the polygons have; and the polygons are to one another in the duplicate ratio of their homologous sides.*

§ 65. Prop. 21. *Rectilinear figures which are similar to the same rectilinear figure are also similar to each other, is an immediate consequence of the definition of similar figures. As similar figures may be said to be equal in "shape" but not in "size," we may state it also thus:*

"Figures which are equal in shape to a third are equal in shape to each other."

Prop. 22. *If four straight lines be proportionals, the similar rectilinear figures similarly described on them shall also be proportionals; and if the similar rectilinear figures similarly described on four straight lines be proportionals, those straight lines shall be proportionals.*

This is essentially the same as the following:—

If then $a : b = c : d,$
 $a^2 : b^2 = c^2 : d^2.$

§ 66. Now follows a proposition which has been much discussed with regard to Euclid's exact meaning in saying that a ratio is compounded of two other ratios, viz.:

Prop. 23. *Parallelograms which are equiangular to one another, have to one another the ratio which is compounded of the ratios of their sides.*

The proof of the proposition makes its meaning clear. In symbols the ratio $a : c$ is compounded of the two ratios $a : b$ and $b : c$, and if $a : b = a' : b'$, $b : c = b' : c'$, then $a : c$ is compounded of $a' : b'$ and $b' : c'$.

If we consider the ratios as numbers, we may say that the one ratio is the product of those of which it is compounded, or in symbols,

$$\frac{a}{c} = \frac{a}{b} \cdot \frac{b}{c} = \frac{a'}{b'} \cdot \frac{b'}{c'}, \text{ if } \frac{a}{b} = \frac{a'}{b'} \text{ and } \frac{b}{c} = \frac{b'}{c'}.$$

The theorem in Prop. 23 is the foundation of all mensuration of areas. From it we see at once that two rectangles have the ratio of their areas compounded of the ratios of their sides.

If A is the area of a rectangle contained by a and b , and B that of a rectangle contained by c and d , so that $A = ab$, $B = cd$, then $A : B = ab : cd$, and this is, the theorem says, compounded of the ratios $a : c$ and $b : d$. In forms of quotients,

$$\frac{a}{c} \cdot \frac{b}{d} = \frac{ab}{cd}$$

This shows how to multiply quotients in our geometrical calculus. Further, *Two triangles have the ratios of their areas compounded of the ratios of their bases and their altitudes.* For a triangle is equal in area to half a parallelogram which has the same base and the same altitude.

§ 67. To bring these theorems to the form in which they are usually given, we assume a straight line u as our unit of length (generally an inch, a foot, a mile, &c.), and determine the number a which expresses how often u is contained in a line a , so that a denotes the ratio $a : u$ whether commensurable or not, and that $a = au$. We

call this number a the numerical value of a . If in the same manner β be the numerical value of a line b we have

$$a : b = a : \beta;$$

in words: *The ratio of two lines (and of two like quantities in general) is equal to that of their numerical values.*

This is easily proved by observing that $a = au$, $b = \beta u$, therefore $a : b = au : \beta u$, and this may without difficulty be shown to equal $a : \beta$.

If now a , b be base and altitude of one, a' , b' those of another parallelogram, α , β and α' , β' their numerical values respectively, and A , A' their areas, then

$$\frac{A}{A'} = \frac{a}{a'} \cdot \frac{b}{b'} = \frac{\alpha}{\alpha'} \cdot \frac{\beta}{\beta'} = \frac{\alpha\beta}{\alpha'\beta'}.$$

In words: *The areas of two parallelograms are to each other as the products of the numerical values of their bases and altitudes.*

If especially the second parallelogram is the unit square, i.e. a square on the unit of length, then $\alpha' = \beta' = 1$, $A' = u^2$, and we have

$$\frac{A}{A'} = \alpha\beta \text{ or } A = \alpha\beta \cdot u^2.$$

This gives the theorem: The number of unit squares contained in a parallelogram equals the product of the numerical values of base and altitude, and similarly the number of unit squares contained in a triangle equals half the product of the numerical values of base and altitude.

This is often stated by saying that the area of a parallelogram is equal to the product of the base and the altitude, meaning by this product the product of the numerical values, and not the product as defined above in § 20.

§ 68. Propositions 24 and 26 relate to parallelograms about diagonals, such as are considered in Book I., 43. They are—

Prop. 24. *Parallelograms about the diameter of any parallelogram are similar to the whole parallelogram and to one another; and its converse (Prop. 26). If two similar parallelograms have a common angle, and be similarly situated, they are about the same diameter.*

Between these is inserted a problem.

Prop. 25. *To describe a rectilinear figure which shall be similar to one given rectilinear figure, and equal to another given rectilinear figure.*

§ 69. Prop. 27 contains a theorem relating to the theory of maxima and minima. We may state it thus:

Prop. 27. *If a parallelogram be divided into two by a straight line cutting the base, and if on half the base another parallelogram be constructed similar to one of those parts, then this third parallelogram is greater than the other part.*

Of far greater interest than this general theorem is a special case of it, where the parallelograms are changed into rectangles, and where one of the parts into which the parallelogram is divided is made a square; for then the theorem changes into one which is easily recognized to be identical with the following:—

Of all rectangles which have the same perimeter the square has the greatest area.

This may also be stated thus:—

Of all rectangles which have the same area the square has the least perimeter.

§ 70. The next three propositions contain problems which may be said to be solutions of quadratic equations. The first two are, like the last, involved in somewhat obscure language. We transcribe them as follows:

Problem.—To describe on a given base a parallelogram, and to divide it either internally (Prop. 28) or externally (Prop. 29) from a point on the base into two parallelograms, of which the one has a given size (is equal in area to a given figure), whilst the other has a given shape (is similar to a given parallelogram).

If we express this again in symbols, calling the given base a , the one part x , and the altitude y , we have to determine x and y in the first case from the equations

$$(a-x)y = h^2, \\ \frac{x}{y} = \frac{p}{q}$$

h^2 being the given size of the first, and p and q the base and altitude of the parallelogram which determine the shape of the second of the required parallelograms.

If we substitute the value of y , we get

$$(a-x)x = \frac{h^2}{q},$$

or,

$$ax - x^2 = b^2,$$

where a and b are known quantities, taking $b^2 = \frac{h^2}{q}$.

The second case (Prop. 29) gives rise, in the same manner, to the quadratic

$$ax + x^2 = b^2.$$

The next problem—

Prop. 30. *To cut a given straight line in extreme and mean ratio, leads to the equation*

$$ax + x^2 = \phi.$$

This is, therefore, only a special case of the last, and is, besides, an old acquaintance, being essentially the same problem as that proposed in II. 11.

Prop. 30 may therefore be solved in two ways, either by aid of Prop. 29 or by aid of II. 11. Euclid gives both solutions.

§ 71. Prop. 31 (Theorem). *In any right-angled triangle, any rectilineal figure described on the side subtending the right angle is equal to the similar and similarly-described figures on the sides containing the right angle,—is a pretty generalization of the theorem of Pythagoras (I. 47).*

Leaving out the next proposition, which is of little interest, we come to the last in this book.

Prop. 33. *In equal circles angles, whether at the centres or the circumferences, have the same ratio which the arcs on which they stand have to one another; so also have the sectors.*

Of this, the part relating to angles at the centre is of special importance; it enables us to measure angles by arcs.

With this closes that part of the *Elements* which is devoted to the study of figures in a plane.

BOOK XI.

§ 72. In this book figures are considered which are not confined to a plane, viz. first relations between lines and planes in space, and afterwards properties of solids.

Of new definitions we mention those which relate to the perpendicularity and the inclination of lines and planes.

Def. 3. *A straight line is perpendicular, or at right angles, to a plane when it makes right angles with every straight line meeting it in that plane.*

The definition of perpendicular planes (Def. 4) offers no difficulty. Euclid defines the inclination of lines to planes and of planes to planes (Defs. 5 and 6) by aid of plane angles, included by straight lines, with which we have been made familiar in the first books.

The other important definitions are those of parallel planes, which never meet (Def. 8), and of solid angles formed by three or more planes meeting in a point (Def. 9).

To these we add the definition of a line parallel to a plane as a line which does not meet the plane.

§ 73. Before we investigate the contents of Book XI., it will be well to recapitulate shortly what we know of planes and lines from the definitions and axioms of the first book. There a plane has been defined as a surface which has the property that every straight line which joins two points in it lies altogether in it. This is equivalent to saying that a straight line which has two points in a plane has all points in the plane. Hence, a straight line which does not lie in the plane cannot have more than one point in common with the plane. This is virtually the same as Euclid's Prop. I. viz. —

Prop. 1. *One part of a straight line cannot be in a plane and another part without it.*

It also follows, as was pointed out in § 3, in discussing the definitions of Book I., that a plane is determined already by one straight line and a point without it, viz. if all lines be drawn through the point, and cutting the line, they will form a plane.

This may be stated thus:—
A plane is determined—

- 1st, By a straight line and a point which does not lie on it;
- 2nd, By three points which do not lie in a straight line; for if two of these points be joined by a straight line we have case 1;
- 3rd, By two intersecting straight lines; for the point of intersection and two other points, one in each line, give case 2;
- 4th, By two parallel lines (Def. 35, 1).

The third case of this theorem is Euclid's Prop. 2. *Two straight lines which cut one another are in one plane, and three straight lines which meet one another are in one plane.*

And the fourth is Euclid's Prop. 7. *If two straight lines be parallel, the straight line drawn from any point in one to any point in the other is in the same plane with the parallels.* From the definition of a plane further follows—

Prop. 3. *If two planes cut one another, their common section is a straight line.*

§ 74. Whilst these propositions are virtually contained in the definition of a plane, the next gives us a new and fundamental property of space, showing at the same time that it is possible to have a straight line perpendicular to a plane, according to Def. 3. It states—

Prop. 4. *If a straight line is perpendicular to two straight lines in a plane which it meets, then it is perpendicular to all lines in the plane which it meets, and hence it is perpendicular to the plane.*

Def. 3 may be stated thus: If a straight line is perpendicular to a plane, then it is perpendicular to every line in the plane which it meets. The converse to this would be

All straight lines which meet a given straight line in the same point, and are perpendicular to it, lie in a plane which is perpendicular to that line.

This Euclid states thus:—
Prop. 5. *If three straight lines meet all at one point, and a straight line stands at right angles to each of them at that point, the three straight lines shall be in one and the same plane.*

§ 75. There follow theorems relating to the theory of parallel lines in space, viz. —

Prop. 6. *Any two lines which are perpendicular to the same plane are parallel to each other; and conversely*

Prop. 8. *If two parallel straight lines one is perpendicular to a plane, the other is so also.*

Prop. 7. *If two straight lines are parallel, the straight line which joins any point in one to any point in the other is in the same plane as the parallels.* (See above, § 73.)

Prop. 9. *Two straight lines which are each of them parallel to the same straight line, and not in the same plane with it, are parallel to one another; where the words, "and not in the same plane with it," may be omitted, for they exclude the case of three parallels in a plane, which has been proved before; and*

Prop. 10. *If two angles in different planes have the two limits of the one parallel to those of the other, then the angles are equal. That their planes are parallel is shown later on in Prop. 15.*

This theorem is not necessarily true, for the angles in question may be supplementary; but then the one angle will be equal to that which is adjacent and supplementary to the other, and this latter angle will also have its limits parallel to those of the first.

From this theorem it follows that if we take any two straight lines in space which do not meet, and if we draw through any point P in space two lines parallel to them, then the angle included by these lines will always be the same, whatever the position of the point P may be. This angle has in modern times been called the angle between the given lines:—

By the angles between two non intersecting lines we understand the angles which two intersecting lines include that are parallel respectively to the two given lines.

§ 76. It is now possible to solve the following two problems:—
To draw a straight line perpendicular to a given plane from a given point which lies—

1. Not in the plane (Prop. 11).
2. In the plane (Prop. 12).

The second case is easily reduced to the first—viz. if by aid of the first we have drawn any perpendicular to the plane from some point without it, we need only draw through the given point in the plane a line parallel to it, in order to have the required perpendicular given. The solution of the first part is of interest in itself. It depends upon a construction which may be expressed as a theorem.

If from a point A without a plane a perpendicular AB be drawn to the plane, and if from the foot B of this perpendicular another perpendicular BC be drawn to any straight line in the plane, then the straight line joining A to the foot C of this second perpendicular will also be perpendicular to the line in the plane.

The theory of perpendiculars to a plane is concluded by the theorem—

Prop. 13. *Through any point in space, whether in or without a plane, only one straight line can be drawn perpendicular to the plane.*

§ 77. The next four propositions treat of parallel planes. It is shown that planes which have a common perpendicular are parallel (Prop. 14); that two planes are parallel if two intersecting straight lines in the one are parallel respectively to two straight lines in the other plane (Prop. 15); that parallel planes are cut by any plane in parallel straight lines (Prop. 16); and lastly, that any two straight lines are cut proportionally by a series of parallel planes (Prop. 17).

This theory is made more complete by adding the following theorems, which are easy deductions from the last: *Two parallel planes have common perpendiculars* (converse to 14); and *Two planes which are parallel to a third plane are parallel to each other.*

It will be noted that Prop. 15 at once allows of the solution of the problem: "Through a given point to draw a plane parallel to a given plane." And it is also easily proved that this problem allows always of one, and only of one, solution.

§ 78. We come now to planes which are perpendicular to one another. Two theorems relate to them.

Prop. 18. *If a straight line be at right angles to a plane, every plane which passes through it shall be at right angles to that plane.*

Prop. 19. *If two planes which cut one another be each of them perpendicular to a third plane, their common section shall be perpendicular to the same plane.*

§ 79. If three planes pass through a common point, and if they bound each other, a solid angle of three faces, or a trihedral angle, is formed, and similarly by more planes a solid angle of more faces, or a polyhedral angle. These have many properties which are quite analogous to those of triangles and polygons in a plane. Euclid states some, viz. —

Prop. 20. *If a solid angle be contained by three plane angles, any two of them are together greater than the third.*

But the next—
Prop. 21. *Every solid angle is contained by plane angles, which are together less than four right angles—has no analogous theorem in the plane.*

We may mention, however, that the theorems about triangles contained in the propositions of Book I., which do not depend upon the theory of parallels (that is all up to Prop. 27), have their corresponding theorems about trihedral angles. The latter are formed, if for "side of a triangle" we write "plane angle" or "face" of trihedral angle, and for "angle of triangle" we substitute "angle between two faces" where the planes containing the solid angle are called its faces. We get, for instance, from I. 6, the

theorem, *If two trihedral angles have the angles of two faces in the one equal to the angles of two faces in the other, and have likewise the angles included by these faces equal, then the angles in the remaining faces are equal, and the angles between the other faces are equal each to each, viz. those which are opposite equal faces.* The solid angles themselves are not necessarily equal, for they may be only symmetrical like the right hand and the left.

The connexion indicated between triangles and trihedral angles will also be recognized in

Prop. 22. *If every two of three plane angles be greater than the third, and if the straight lines which contain them be all equal, a triangle may be made of the straight lines that join the extremities of those equal straight lines.*

And Prop. 23 solves the problem, *To construct a trihedral angle having the angles of its faces equal to three given plane angles, any two of them being greater than the third.* It is, of course, analogous to the problem of constructing a triangle having its sides of given length.

Two other theorems of this kind are added by Simson in his edition of Euclid's *Elements*.

§ 80. These are the principal properties of lines and planes in space, but before we go on to their applications it will be well to define the word *distance*. In geometry distance means always "shortest distance"; viz. the distance of a point from a straight line, or from a plane, is the length of the perpendicular from the point to the line or plane. The distance between two non-intersecting lines is the length of their common perpendicular, there being but one. The distance between two parallel lines or between two parallel planes is the length of the common perpendicular between the lines or the planes.

§ 81. *Parallelepipeds*.—The rest of the book is devoted to the study of the parallelepiped. In Prop. 24 the possibility of such a solid is proved, viz.:

Prop. 24. *If a solid be contained by six planes two and two of which are parallel, the opposite planes are similar and equal parallelograms.*

Euclid calls this solid henceforth a parallelepiped, though he never defines the word. Either face of it may be taken as *base*, and its distance from the opposite face as *altitude*.

Prop. 25. *If a solid parallelepiped be cut by a plane parallel to two of its opposite planes, it divides the whole into two solids, the base of one of which shall be to the base of the other as the one solid is to the other.*

This theorem corresponds to the theorem (VI. 1) that parallelograms between the same parallels are to one another as their bases. A similar analogy is to be observed among a number of the remaining propositions.

§ 82. After solving a few problems we come to
Prop. 28. *If a solid parallelepiped be cut by a plane passing through the diagonals of two of the opposite planes, it shall be cut in two equal parts.*

In the proof of this, as of several other propositions, Euclid neglects the difference between solids which are symmetrical like the right hand and the left.

Prop. 31. *Solid parallelepipeds, which are upon equal bases, and of the same altitude, are equal to one another.*

Props. 29 and 30 contain special cases of this theorem leading up to the proof of the general theorem.

As consequences of this fundamental theorem we get
Prop. 32. *Solid parallelepipeds, which have the same altitude, are to one another as their bases;* and

Prop. 33. *Similar solid parallelepipeds are to one another in the triplicate ratio of their homologous sides.*

If we consider, as in § 67, the ratios of lines as numbers, we may also say—

The ratio of the volumes of similar parallelepipeds is equal to the ratio of the third powers of homologous sides.

Parallelepipeds which are not similar but equal are compared by aid of the theorem

Prop. 34. *The bases and altitudes of equal solid parallelepipeds are reciprocally proportional; and if the bases and altitudes be reciprocally proportional, the solid parallelepipeds are equal.*

§ 83. Of the following propositions the 37th and 40th are of special interest.

Prop. 37. *If four straight lines be proportionals, the similar solid parallelepipeds, similarly described from them, shall also be proportionals; and if the similar parallelepipeds similarly described from four straight lines be proportionals, the straight lines shall be proportionals.*

In symbols it says—

$$\text{If } a:b=c:d, \text{ then } a^3:b^3=c^3:d^3.$$

Prop. 40 teaches how to compare the volumes of triangular prisms with those of parallelepipeds, by proving that a triangular prism is equal in volume to a parallelepiped, which has its altitude and its base equal to the altitude and the base of the triangular prism.

§ 84. From these propositions follow all results relating to the mensuration of volumes. We shall state these as we did in the case of areas. The starting-point is the "rectangular" parallelepiped, which has every edge perpendicular to the planes it meets, and

which takes the place of the rectangle in the plane. If this has all its edges equal we obtain the "cube."

If we take a certain line u as unit length, then the square on u is the unit of area, and the cube on u the unit of volume, that is to say, if we wish to measure a volume we have to determine how many unit cubes it contains.

A rectangular parallelepiped has, as a rule, the three edges unequal, which meet at a point. Every other edge is equal to one of them. If a, b, c be the three edges meeting at a point, then we may take the rectangle contained by two of them, say by b and c , as base and the third as altitude. Let V be its volume, V' that of another rectangular parallelepiped which has the edges a', b', c' , hence the same base as the first. It follows then easily, from Prop. 25 or 32, that $V:V'=a:a'$; or in words,

Rectangular parallelepipeds on equal bases are proportional to their altitudes.

If we have two rectangular parallelepipeds, of which the first has the volume V and the edges a, b, c , and the second, the volume V' and the edges a', b', c' , we may compare them by aid of two new ones which have respectively the edges a', b, c and a', b', c , and the volumes V_1 and V_2 . We then have

$$V:V_1=a:a'; V_1:V_2=b:b'; V_2:V'=c:c'.$$

Compounding these, we have

$$V:V'=(a:a')(b:b')(c:c'),$$

or

$$\frac{V}{V'} = \frac{a}{a'} \cdot \frac{b}{b'} \cdot \frac{c}{c'}.$$

Hence, as a special case, making V' equal to the unit cube U on u we get

$$\frac{V}{U} = \frac{a}{u} \cdot \frac{b}{u} \cdot \frac{c}{u} = a \cdot b \cdot c.$$

where a, b, c are the numerical values of a, b, c ; that is, *The number of unit cubes in a rectangular parallelepiped is equal to the product of the numerical values of its three edges.* This is generally expressed by saying the volume of a rectangular parallelepiped is measured by the product of its sides, or by the product of its base into its altitude, which in this case is the same.

Prop. 31 allows us to extend this to any parallelepipeds, and Props. 28 or 40, to triangular prisms.

The volume of any parallelepiped, or of any triangular prism, is measured by the product of base and altitude.

The consideration that any polygonal prism may be divided into a number of triangular prisms, which have the same altitude and the sum of their bases equal to the base of the polygonal prism, shows further that the same holds for any prism whatever.

BOOK XII.

§ 85. In the last part of Book XI. we have learnt how to compare the volumes of parallelepipeds and of prisms. In order to determine the volume of any solid bounded by plane faces we must determine the volume of pyramids, for every such solid may be decomposed into a number of pyramids.

As every pyramid may again be decomposed into triangular pyramids, it becomes only necessary to determine their volume. This is done by the

Theorem.—Every triangular pyramid is equal in volume to one third of a triangular prism having the same base and the same altitude as the pyramid.

This is an immediate consequence of Euclid's

Prop. 7. *Every prism having a triangular base may be divided into three pyramids that have triangular bases, and are equal to one another.*

The proof of this theorem is difficult, because the three triangular pyramids into which the prism is divided are by no means equal in shape, and cannot be made to coincide. It has first to be proved that two triangular pyramids have equal volumes, if they have equal bases and equal altitudes. This Euclid does in the following manner. He first shows (Prop. 3) that a triangular pyramid may be divided into four parts, of which two are equal triangular pyramids similar to the whole pyramid, whilst the other two are equal triangular prisms, and further, that these two prisms together are greater than the two pyramids, hence more than half the given pyramid. He next shows (Prop. 4) that if two triangular pyramids are given, having equal bases and equal altitudes, and if each be divided as above, then the two triangular prisms in the one are equal to those in the other, and each of the remaining pyramids in the one has its base and altitude equal to the base and altitude of the remaining pyramids in the other. Hence to these pyramids the same process is again applicable. We are thus enabled to cut out of the two given pyramids equal parts, each greater than half the original pyramid. Of the remainder we can again cut out equal parts greater than half these remainders, and so on as far as we like. This process may be continued till the last remainder is smaller than any assignable quantity, however small. It follows, so we should conclude at present, that the two volumes must be equal, for they cannot differ by any assignable quantity.

To Greek mathematicians this conclusion offers far greater

difficulties. They prove elaborately, by a *reductio ad absurdum*, that the volumes cannot be unequal. This proof must be read in the *Elements*. We must, however, state that we have in the above not proved Euclid's Prop. 5, but only a special case of it. Euclid does not suppose that the bases of the two pyramids to be compared are equal, and hence he proves that the volumes are as the bases. The reasoning of the proof becomes clearer in the special case, from which the general one may be easily deduced.

§ 86. Prop. 6 extends the result to pyramids with polygonal bases. From these results follow again the rules at present given for the mensuration of solids, viz. a pyramid is the third part of a triangular prism having the same base and the same altitude. But a triangular prism is equal in volume to a parallelepiped which has the same base and altitude. Hence if B is the base and h the altitude, we have

$$\begin{aligned}\text{Volume of prism} &= Bh, \\ \text{Volume of pyramid} &= \frac{1}{3}Bh,\end{aligned}$$

statements which have to be taken in the sense that B means the number of square units in the base, h the number of units of length in the altitude, or that B and h denote the numerical values of base and altitude.

§ 87. A method similar to that used in proving Prop. 5 leads to the following results relating to solids bounded by simple curved surfaces:—

Prop. 10. Every cone is the third part of a cylinder which has the same base, and is of an equal altitude with it.

Prop. 11. Cones or cylinders of the same altitude are to one another as their bases.

Prop. 12. Similar cones or cylinders have to one another the triplicate ratio of that which the diameters of their bases have.

Prop. 13. If a cylinder be cut by a plane parallel to its opposite planes or bases, it divides the cylinder into two cylinders, one of which is to the other as the axis of the first to the axis of the other; which may also be stated thus:—

Cylinders on the same base are proportional to their altitudes.

Prop. 14. Cones or cylinders upon equal bases are to one another as their altitudes.

Prop. 15. The bases and altitudes of equal cones or cylinders are reciprocally proportional, and if the bases and altitudes be reciprocally proportional, the cones or cylinders are equal to one another.

These theorems again lead to formulæ in mensuration, if we compare a cylinder with a prism having its base and altitude equal to the base and altitude of the cylinder. This may be done by the method of exhaustion. We get, then, the result that their bases are equal, and have, if B denotes the numerical value of the base, and h that of the altitude,

$$\begin{aligned}\text{Volume of cylinder} &= Bh, \\ \text{Volume of cone} &= \frac{1}{3}Bh.\end{aligned}$$

§ 88. The remaining propositions relate to circles and spheres. Of the sphere only one property is proved, viz.:

Prop. 18. Spheres have to one another the triplicate ratio of that which their diameters have. The mensuration of the sphere, like that of the circle, the cylinder and the cone, had not been settled in the time of Euclid. It was done by Archimedes.

BOOK XIII.

§ 89. The 13th and last book of Euclid's *Elements* is devoted to the regular solids (see POLYHEDRON). It is shown that there are five of them, viz.:

1. The regular tetrahedron, with 4 triangular faces and 4 vertices;
2. The cube, with 8 vertices and 6 square faces;
3. The octahedron, with 6 vertices and 8 triangular faces;
4. The dodecahedron, with 12 pentagonal faces, 3 at each of the 20 vertices;
5. The icosahedron, with 20 triangular faces, 5 at each of the 12 vertices.

It is shown how to inscribe these solids in a given sphere, and how to determine the lengths of their edges.

§ 90. The 13th book, and therefore the *Elements*, conclude with the scholium, "that no other regular solid exists besides the five ones enumerated."

The proof is very simple. Each face is a regular polygon, hence the angles of the faces at any vertex must be angles in equal regular polygons, must be together less than four right angles (XI. 21), and must be three or more in number. Each angle in a regular triangle equals two-thirds of one right angle. Hence it is possible to form a solid angle with three, four or five regular triangles or faces. These give the solid angles of the tetrahedron, the octahedron and the icosahedron. The angle in a square (the regular quadrilateral) equals one right angle. Hence three will form a solid angle, that of the cube, and four will not. The angle in the regular pentagon equals $\frac{3}{5}$ of a right angle. Hence three of them equal $\frac{9}{5}$ (*i.e.* less than 4) right angles, and form the solid angle of the dodecahedron. Three regular polygons of six or more sides cannot form a solid angle. Therefore no other regular solids are possible. (O. H.)

II. PROJECTIVE GEOMETRY

It is difficult, at the outset, to characterize projective geometry as compared with Euclidean. But a few examples will at least indicate the practical differences between the two.

In Euclid's *Elements* almost all propositions refer to the magnitude of lines, angles, areas or volumes, and therefore to measurement. The statement that an angle is right, or that two straight lines are parallel, refers to measurement. On the other hand, the fact that a straight line does or does not cut a circle is independent of measurement, it being dependent only upon the mutual "position" of the line and the circle. This difference becomes clearer if we project any figure from one plane to another (see PROJECTION). By this the length of lines, the magnitude of angles and areas, is altered, so that the projection, or shadow, of a square on a plane will not be a square; it will, however, be some quadrilateral. Again, the projection of a circle will not be a circle, but some other curve more or less resembling a circle. But one property may be stated at once—no straight line can cut the projection of a circle in more than two points, because no straight line can cut a circle in more than two points. There are, then, some properties of figures which do not alter by projection, whilst others do. To the latter belong nearly all properties relating to measurement, at least in the form in which they are generally given. The others are said to be projective properties, and their investigation forms the subject of projective geometry.

Different as are the kinds of properties investigated in the old and the new sciences, the methods followed differ in a still greater degree. In Euclid each proposition stands by itself; its connexion with others is never indicated; the leading ideas contained in its proof are not stated; general principles do not exist. In the modern methods, on the other hand, the greatest importance is attached to the leading thoughts which pervade the whole; and general principles, which bring whole groups of theorems under one aspect, are given rather than separate propositions. The whole tendency is towards generalization. A straight line is considered as given in its entirety, extending both ways to infinity, while Euclid never admits anything but finite quantities. The treatment of the infinite is in fact another fundamental difference between the two methods: Euclid avoids it; in modern geometry it is systematically introduced.

Of the different modern methods of geometry, we shall treat principally of the methods of projection and correspondence which have proved to be the most powerful. These have become independent of Euclidean Geometry, especially through the *Geometrie der Lage* of V. Staudt and the *Ausdehnungslehre* of Grassmann.

For the sake of brevity we shall presuppose a knowledge of Euclid's *Elements*, although we shall use only a few of his propositions.

§ 1. *Geometrical Elements.* We consider space as filled with points, lines and planes, and these we call the elements out of which our figures are to be formed, calling any combination of these elements a "figure."

By a line we mean a straight line in its entirety, extending both ways to infinity; and by a plane, a plane surface, extending in all directions to infinity.

We accept the three-dimensional space of experience—the space assumed by Euclid—which has for its properties (among others):—

Through any two points in space one and only one line may be drawn;

Through any three points which are not in a line, one and only one plane may be placed;

The intersection of two planes is a line;

A line which has two points in common with a plane lies in the plane, hence the intersection of a line and a plane is a single point; and

Three planes which do not meet in a line have one single point in common.

These results may be stated differently in the following form:—

- | | |
|--|--|
| I. A plane is determined— | A point is determined— |
| 1. By three points which do not lie in a line; | 1. By three planes which do not pass through a line; |
| 2. By two intersecting lines; | 2. By two intersecting lines; |
| 3. By a line and a point which does not lie in it. | 3. By a plane and a line which does not lie in it. |
| II. A line is determined— | |
| 1. By two points; | 2. By two planes. |

It will be observed that not only are planes determined by points, but also points by planes; that therefore the planes may be considered as elements, like points; and also that in any one of the above statements we may interchange the words point and plane, and we obtain again a correct statement, provided that these statements themselves are true. As they stand, we ought, in several cases, to add "if they are not parallel," or some such words, parallel lines and planes being evidently left altogether out of consideration. To correct this we have to reconsider the theory of parallels.

§ 2. *Parallels. Point at Infinity.*—Let us take in a plane a line p (fig. 1), a point S not in this line, and a line q drawn through S .

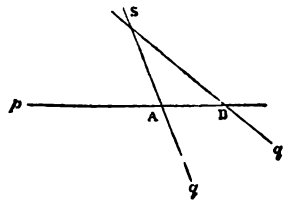

FIG. 1.

Then this line q will meet the line p in a point A . If we turn the line q about S towards q' , its point of intersection with p will move along p towards B , passing, on continued turning, to a greater and greater distance, until it is moved out of our reach. If we turn q still farther, its continuation will meet p , but now at the other side of A . The point of intersection has disappeared to the right and reappeared to the left. There is one intermediate position where q is parallel to p —that is where it does not cut p . In every other position it cuts p in some finite point. If, on the other hand, we move the point A to an infinite distance in p , then the line q which passes through A will be a line which does not cut p at any finite point. Thus we are led to say: Every line through S which joins it to any point at an infinite distance in p is parallel to p . But by Euclid's 12th axiom there is but one line parallel to p through S . The difficulty in which we are thus involved is due to the fact that we try to reason about infinity as if we, with our finite capabilities, could comprehend the infinite. To overcome this difficulty, we may say that all points at infinity in a line appear to us as one, and may be replaced by a single "ideal" point.

We may therefore now give the following definitions and axiom:—*Definition.*—Lines which meet at infinity are called parallel.
Axiom.—All points at an infinite distance in a line may be considered as one single point.

Definition.—This ideal point is called the *point at infinity* in the line.

The axiom is equivalent to Euclid's Axiom 12, for it follows from either that through any point only one line may be drawn parallel to a given line.

This point at infinity in a line is reached whether we move a point in the line or in the opposite direction of a line to infinity. A line thus appears closed by this point, and we speak as if we could move a point along the line from one position A to another B in two ways, either through the point at infinity or through finite points only.

It must never be forgotten that this point at infinity is ideal; in fact, the whole notion of "infinity" is only a mathematical conception, and owes its introduction (as a method of research) to the working generalizations which it permits.

§ 3. *Line and Plane at Infinity.*—Having arrived at the notion of replacing all points at infinity in a line by one ideal point, there is no difficulty in replacing all points at infinity in a plane by one ideal line.

To make this clear, let us suppose that a line p , which cuts two fixed lines a and b in the points A and B , moves parallel to itself to a greater and greater distance. It will at last cut both a and b at their points at infinity, so that a line which joins the two points at infinity in two intersecting lines lies altogether at infinity. Every other line in the plane will meet it therefore at infinity, and thus it contains all points at infinity in the plane.

All points at infinity in a plane lie in a line, which is called the line at infinity in the plane.

It follows that parallel planes must be considered as planes having a common line at infinity, for any other plane cuts them in parallel lines which have a point at infinity in common.

If we next take two intersecting planes, then the point at infinity in their line of intersection lies in both planes, so that their lines at infinity meet. Hence every line at infinity meets every other line at infinity, and they are therefore all in one plane.

All points at infinity in space may be considered as lying in one ideal plane, which is called the plane at infinity.

§ 4. *Parallelism.*—We have now the following definitions:—Parallel lines are lines which meet at infinity; Parallel planes are planes which meet at infinity; A line is parallel to a plane if it meets it at infinity. Theorems like this—Lines (or planes) which are parallel to a third are parallel to each other—follow at once.

This view of parallels leads therefore to no contradiction of Euclid's Elements.

XL 17

As immediate consequences we get the propositions:—

Every line meets a plane in one point, or it lies in it;

Every plane meets every other plane in a line;

Any two lines in the same plane meet.

§ 5. *Aggregates of Geometrical Elements.*—We have called points, lines and planes the elements of geometrical figures. We also say that an element of one kind contains one of the other if it lies in it or passes through it.

All the elements of one kind which are contained in one or two elements of a different kind form aggregates which have to be enumerated. They are the following:—

I. Of one dimension.

1. The row, or range, of points formed by all points in a line, which is called its base.

2. The flat pencil formed by all the lines through a point in a plane. Its base is the point in the plane.

3. The axial pencil formed by all planes through a line which is called its base or axis.

II. Of two dimensions.

1. The field of points and lines—that is, a plane with all its points and all its lines.

2. The pencil of lines and planes—that is, a point in space with all lines and all planes through it.

III. Of three dimensions.

The space of points—that is, all points in space.

The space of planes—that is, all planes in space.

IV. Of four dimensions.

The space of lines, or all lines in space.

§ 6. *Meaning of "Dimensions."*—The word *dimension* in the above needs explanation. If in a plane we take a row p and a pencil with centre Q , then through every point in p one line in the pencil will pass, and every ray in Q will cut p in one point, so that we are entitled to say a row contains as many points as a flat pencil line; and, we may add, as an axial pencil passes, because an axial pencil is cut by a plane in a flat pencil.

The number of elements in the row, in the flat pencil, and in the axial pencil is, of course, infinite and indefinite too, but the same in all. This number may be denoted by ∞ . Then a plane contains ∞^2 points and as many lines. To see this, take a flat pencil in a plane. It contains ∞ lines, and each line contains ∞ points, whilst each point in the plane lies on one of these lines. Similarly, in a plane each line cuts a fixed line in a point. But this line is cut at each point by ∞ lines and contains ∞ points; hence there are ∞^2 lines in a plane.

A pencil in space contains as many lines as a plane contains points and as many planes as a plane contains lines, for any plane cuts the pencil in a field of points and lines. Hence a pencil contains ∞^3 lines and ∞^3 planes. The field and the pencil are of two dimensions.

To count the number of points in space we observe that each point lies on some line in a pencil. But the pencil contains ∞^2 lines, and each line to points; hence space contains ∞^3 points. Each plane cuts any fixed plane in a line. But a plane contains ∞^2 lines, and through each pass ∞ planes; therefore space contains ∞^3 planes.

Hence space contains as many planes as points, but it contains an infinite number of times more lines than points or planes. To count them, notice that every line cuts a fixed plane in one point. But ∞^2 lines pass through each point, and there are ∞^3 points in the plane. Hence there are ∞^4 lines in space. The space of points and planes is of three dimensions, but the space of lines is of four dimensions.

A field of points or lines contains an infinite number of rows and flat pencils; a pencil contains an infinite number of flat pencils and of axial pencils; space contains a triple infinite number of pencils and of fields, ∞^4 rows and axial pencils and ∞^4 flat pencils—or, in other words, each point is a centre of ∞^4 flat pencils.

§ 7. The above enumeration allows a classification of figures. Figures in a row consist of groups of points only, and figures in the flat or axial pencil consist of groups of lines or planes. In the plane we may draw polygons; and in the pencil or in the point, solid angles, and so on.

We may also distinguish the different measurements We have—

In the row, length of segment;

In the flat pencil, angles;

In the axial pencil, dihedral angles between two planes;

In the plane, areas;

In the pencil, solid angles;

In the space of points or planes, volumes.

SEGMENTS OF A LINE

§ 8. Any two points A and B in space determine on the line through them a finite part, which may be considered as being described by a point moving from A to B . This we shall denote by AB , and distinguish it from BA , which is supposed as being described by a point moving from B to A , and hence in a direction or in a "sense" opposite to AB . Such a finite line, which has a definite sense, we shall call a "segment," so that AB and BA denote different segments, which are said to be equal in length but of opposite sense. The one sense is often called positive and the other negative.

28

In introducing the word "sense" for direction in a line, we have the word direction reserved for direction of the line itself, so that different lines have different directions, unless they be parallel, whilst in each line we have a positive and negative sense.

We may also say, with Clifford, that AB denotes the "step" of going from A to B.

§ 9. If we have three points A, B, C in a line (fig. 2), the step AB will bring us from A to B, and the step BC from B to C. Hence both steps are equivalent to the one step AC. This is expressed by saying that AC is the "sum" of AB and BC; in symbols—

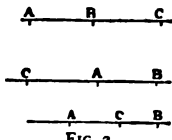

FIG. 2.

where account is to be taken of the sense.

This equation is true whatever be the position of the three points on the line. As a special case we have

$$AB + BA = 0, \tag{1}$$

and similarly

$$AB + BC + CA = 0, \tag{2}$$

which again is true for any three points in a line.

We further write

$$AB = -BA.$$

where - denotes negative sense.

We can then, just as in algebra, change subtraction of segments into addition by changing the sense, so that $AB - CB$ is the same as $AB + (-CB)$ or $AB + BC$. A figure will at once show the truth of this. The sense is, in fact, in every respect equivalent to the "sign" of a number in algebra.

§ 10. Of the many formulae which exist between points in a line we shall have to use only one more, which connects the segments between any four points A, B, C, D in a line. We have

$$BC = BD + DC, CA = CD + DA, AB = AD + DB;$$

or multiplying these by AD, BD, CD respectively, we get

$$\begin{aligned} BC \cdot AD &= BD \cdot AD + DC \cdot AD = BD \cdot AD - CD \cdot AD \\ CA \cdot BD &= CD \cdot BD + DA \cdot BD = CD \cdot BD - AD \cdot BD \\ AB \cdot CD &= AD \cdot CD + DB \cdot CD = CD \cdot AD - CD \cdot BD \cdot CD. \end{aligned}$$

It will be seen that the sum of the right-hand sides vanishes, hence that

$$BC \cdot AD + CA \cdot BD + AB \cdot CD = 0 \tag{3}$$

for any four points on a line.

§ 11. If C is any point in the line AB, then we say that C divides the segment AB in the ratio AC/CB, account being taken of the sense of the two segments AC and CB. If C lies between A and B the ratio is positive, as AC and CB have the same sense. But if C lies without the segment AB, i.e. if C divides AB externally, then the ratio is negative.

To see how the value of this ratio changes with C, we will move C along the whole line (fig. 3), whilst A and B remain fixed. If C lies at the point A, then $AC = 0$, hence the ratio $AC:CB$ vanishes. As C moves towards B, AC increases and CB decreases, so that our ratio increases. At the middle point M of AB it assumes the value +1, and then increases till it reaches an infinitely large value, when C arrives at B. On passing beyond B the ratio becomes negative. If C is at P we have $AC = AP = AB + BP$, hence

$$\frac{AC}{CB} = \frac{AB + BP}{PB} = -\frac{AB}{BP} - 1.$$

In the last expression the ratio $AB:BP$ is positive, has its greatest value 0 when C coincides with B, and vanishes when BC becomes infinite. Hence, as C moves from B to the right to the point at infinity, the ratio $AC:CB$ varies from $-\infty$ to -1 .

If, on the other hand, C is to the left of A, say at Q, we have $AC = AQ = AB + BQ = AB - QB$, hence $\frac{AC}{CB} = \frac{AB}{QB} - 1$.

Here $AB < QB$, hence the ratio $AB:QB$ is positive and always less than one, so that the whole is negative and < -1 . If C is at the point at infinity it is -1 , and then increases as C moves to the right, till for C at A we get the ratio = 0. Hence—

"As C moves along the line from an infinite distance to the left to an infinite distance at the right, the ratio always increases; it starts with the value -1 , reaches 0 at A, $+1$ at M, ∞ at B, now changes sign to $-\infty$, and increases till at an infinite distance it reaches again the value -1 . It assumes therefore all possible values from $-\infty$ to $+\infty$, and each value only once, so that not only does every position of C determine a definite value of the ratio $AC:CB$, but also, conversely, to every positive or negative value of this ratio belongs one single point in the line AB.

[Relations between segments of lines are interesting as showing an application of algebra to geometry. The genesis of such relations

from algebraic identities is very simple. For example, if a, b, c, x be any four quantities, then

$$\frac{a}{(a-b)(a-c)(x-a)} + \frac{b}{(b-c)(b-a)(x-b)} + \frac{c}{(c-a)(c-b)(x-c)} = \frac{x}{(x-a)(x-b)(x-c)}$$

this may be proved, cumbersomely, by multiplying up, or, simply, by decomposing the right-hand member of the identity into partial fractions. Now take a line ABCDX, and let $AB = a, AC = b, AD = c, AX = x$. Then obviously $(a-b) = AB - AC = -BC$, paying regard to signs; $(a-c) = AB - AD = DB$, and so on. Substituting these values in the identity we obtain the following relation connecting the segments formed by five points on a line:—

$$\frac{AB}{BC \cdot BD} \cdot \frac{AC}{BX} + \frac{AC}{CB} \cdot \frac{AD}{DX} + \frac{AD}{DB} \cdot \frac{DC}{CX} = \frac{AX}{BX \cdot CX \cdot DX}$$

Conversely, if a metrical relation be given, its validity may be tested by reducing to an algebraic equation, which is an identity if the relation be true. For example, if ABCDX be five collinear points, prove

$$\frac{AD \cdot AX}{AB \cdot AC} \cdot \frac{BD \cdot BX}{BC \cdot BA} + \frac{CD \cdot CX}{CA \cdot CB} = 1.$$

Clearing of fractions by multiplying throughout by $AB \cdot BC \cdot CA$, we have to prove

$$-AD \cdot AX \cdot BC - BD \cdot BX \cdot CA - CD \cdot CX \cdot AB = AB \cdot BC \cdot CA.$$

Take A as origin and let $AB = a, AC = b, AD = c, AX = x$. Substituting for the segments in terms of a, b, c, x, we obtain on simplification

$$a^2b - ab^2 = -ab^2 + a^2b, \text{ an obvious identity.}$$

An alternative method of testing a relation is illustrated in the following example:—If A, B, C, D, E, F be six collinear points, then

$$\frac{AE \cdot AF}{AB \cdot AC \cdot AD} + \frac{BE \cdot BF}{BC \cdot BD \cdot BA} + \frac{CE \cdot CF}{CD \cdot CA \cdot CB} + \frac{DE \cdot DF}{DB \cdot DC \cdot DA} = 0.$$

Clearing of fractions by multiplying throughout by $AB \cdot BC \cdot CD \cdot DA$, and reducing to a common origin O (calling $OA = a, OB = b, \&c.$), an equation containing the second and lower powers of $OA (=a)$, $\&c.$, is obtained. Calling $OQ = x$, it is found that $x = b, x = c, x = d$ are solutions. Hence the quadratic has three roots; consequently it is an identity.

The relations connecting five points which we have instanced above may be readily deduced from the six-point relation; the first by taking D at infinity, and the second by taking F at infinity, and then making the obvious permutations of the points.]

PROJECTION AND CROSS-RATIOS

§ 12. If we join a point A to a point S, then the point where the line SA cuts a fixed plane π is called the projection of A on the plane π from S as centre of projection. If we have two planes π and π' and a point S, we may project every point A in π to the other plane. If A' is the projection of A, then A is also the projection of A', so that the relations are reciprocal. To every figure in π we get as its projection a corresponding figure in π' .

We shall determine such properties of figures as remain true for the projection, and which are called projective properties. For this purpose it will be sufficient to consider at first only constructions in one plane.

Let us suppose we have given in a plane two lines p and p' and a centre S (fig. 4): we may then project the points in p from S to p' .

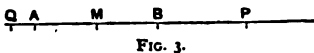

FIG. 3.

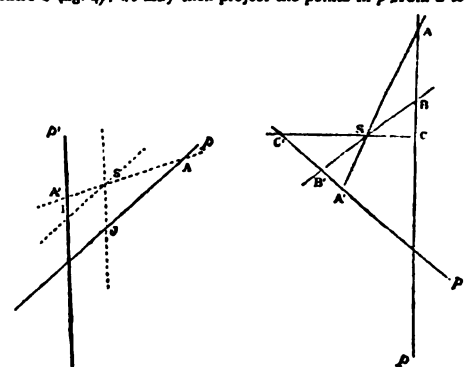

FIG. 4.

FIG. 5.

Let A', B' . . . be the projections of A, B . . ., the point at infinity in p which we shall denote by I will be projected into a finite point

I' in p' , viz. into the point where the parallel to p through S cuts p' . Similarly one point J in p will be projected into the point J' at infinity in p' . This point J is of course the point where the parallel to p' through S cuts p . We thus see that every point in p is projected into a single point in p' .

Fig. 5 shows that a segment AB will be projected into a segment $A'B'$ which is not equal to it, at least not as a rule; and also that the ratio $AC:CB$ is not equal to the ratio $A'C':C'B'$ formed by the projections. These ratios will become equal only if p and p' are parallel, for in this case the triangle SAB is similar to the triangle $SA'B'$. Between three points in a line and their projections there exists therefore in general no relation. But between four points a relation does exist.

§ 13. Let A, B, C, D be four points in p, A', B', C', D' their projections in p' , then the ratio of the two ratios $AC:CB$ and $AD:DB$ into which C and D divide the segment AB is equal to the corresponding expression between A', B', C', D' . In symbols we have

$$\frac{AC}{CB} \cdot \frac{AD}{DB} = \frac{A'C'}{C'B'} \cdot \frac{A'D'}{D'B'}$$

This is easily proved by aid of similar triangles.

Through the points A and B on p draw parallels to p' , which cut the projecting rays in

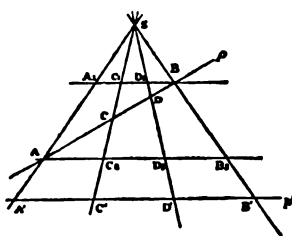

FIG. 6.

C_0, D_0, B_2 and A_1, C_1, D_1 , as indicated in fig. 6. The two triangles ACC_0 and BCC_0 will be similar, as will also be the triangles ADD_1 and BDD_1 .

The proof is left to the reader. This result is of fundamental importance.

The expression $AC/CB \cdot AD/DB$ has been called by Chasles the "anharmonic ratio of the four points A, B, C, D ."

Professor Clifford proposed the shorter name of "cross-ratio." We shall adopt the latter. We have then the

FUNDAMENTAL THEOREM.—The cross-ratio of four points in a line is equal to the cross-ratio of their projections on any other line which lies in the same plane with it.

§ 14. Before we draw conclusions from this result, we must investigate the meaning of a cross-ratio somewhat more fully.

If four points A, B, C, D are given, and we wish to form their cross-ratio, we have first to divide them into two groups of two, the points in each group being taken in a definite order. Thus, let A, B be the first, C, D the second pair, A and C being the first points in each pair. The cross-ratio is then the ratio $AC:CB$ divided by $AD:DB$. This will be denoted by (AB, CD) , so that

$$(AB, CD) = \frac{AC}{CB} \cdot \frac{AD}{DB}$$

This is easily remembered. In order to write it out, make first the two lines for the fractions, and put above and below these the letters A and B in their places, thus, $\frac{A}{B} : \frac{A}{B}$; and then fill up, crosswise, the first by C and the other by D .

§ 15. If we take the points in a different order, the value of the cross-ratio will change. We can do this in twenty-four different ways by forming all permutations of the letters. But of these twenty-four cross-ratio groups of four are equal, so that there are really only six different ones, and these six are reciprocals in pairs.

We have the following rules:—

I. If in a cross-ratio the two groups be interchanged, its value remains unaltered, i.e.

$$(AB, CD) = (CD, AB) = (BA, DC) = (DC, BA)$$

II. If in a cross-ratio the two points belonging to one of the two groups be interchanged, the cross-ratio changes into its reciprocal, i.e.

$$(AB, CD) = 1/(AB, DC) = 1/(BA, CD) = 1/(CD, BA) = 1/(DC, AB)$$

From I. and II. we see that eight cross-ratios are associated with (AB, CD) .

III. If in a cross-ratio the two middle letters be interchanged, the cross-ratio a changes into its complement $1-a$, i.e. $(AB, CD) = 1 - (AC, BD)$.

§ 16. If $\lambda = (AB, CD)$, $\mu = (AC, DB)$, $\nu = (AD, BC)$, then λ, μ, ν and their reciprocals $1/\lambda, 1/\mu, 1/\nu$ are the values of the total number of twenty-four cross-ratios. Moreover, λ, μ, ν are connected by the relations

$$\lambda + 1/\mu = \mu + 1/\nu = \nu + 1/\lambda = -\lambda\mu\nu = 1,$$

this proposition may be proved by substituting for λ, μ, ν and

reducing to a common origin. There are therefore four equations between three unknowns; hence if one cross-ratio be given, the remaining twenty-three are determinate. Moreover, two of the quantities λ, μ, ν are positive, and the remaining one negative.

The following scheme shows the twenty-four cross-ratios expressed in terms of λ, μ, ν .

(AB, CD)	λ	$1-\mu$	$1/(1-\nu)$	(AC, DB)	$1/(1-\lambda)$	$1/\mu$	$(\nu-1)/\nu$
(BA, DC)				(BD, CA)			
(CD, AB)				(CA, BD)			
(DC, BA)				(DB, AC)			
(AB, CD)	$1/\lambda$	$1/(1-\mu)$	$1-\nu$	(AD, BC)	$(\lambda-1)/\lambda$	$\mu/(\mu-1)$	ν
(BA, DC)				(CB, AD)			
(CD, AB)				(DB, AC)			
(DC, BA)				(AD, CB)			
(AC, BD)	$1-\lambda$	μ	$\nu/(\nu-1)$	(DC, AB)	$\lambda/(\lambda-1)$	$(\mu-1)/\mu$	$1/\nu$
(BD, AC)				(BC, DA)			
(CA, DB)				(CB, AD)			
(DB, CA)				(DA, BC)			

§ 17. If one of the points of which a cross-ratio is formed is the point at infinity in the line, the cross-ratio changes into a simple ratio. It is convenient to let the point at infinity occupy the last place in the symbolic expression for the cross-ratio. Thus if I is a point at infinity, we have $(AB, CI) = -AC/CB$, because $AI:IB = -1$.

Every common ratio of three points in a line may thus be expressed as a cross-ratio, by adding the point at infinity to the group of points.

HARMONIC RANGES

§ 18. If the points have special positions, the cross-ratios may have such a value that, of the six different ones, two and two become equal. If the first two shall be equal, we get $\lambda = 1/\lambda$, or $\lambda^2 = 1$, $\lambda = \pm 1$.

If we take $\lambda = +1$, we have $(AB, CD) = 1$, or $AC/CB = AD/DB$; that is, the points C and D coincide, provided that A and B are different.

If we take $\lambda = -1$, so that $(AB, CD) = -1$, we have $AC/CB = -AD/DB$. Hence C and D divide AB internally and externally in the same ratio.

The four points are in this case said to be harmonic points, and C and D are said to be harmonic conjugates with regard to A and B .

But we have also $(CD, AB) = -1$, so that A and B are harmonic conjugates with regard to C and D .

The principal property of harmonic points is that their cross-ratio remains unaltered if we interchange the two points belonging to one pair, viz.

$$(AB, CD) = (AB, DC) = (BA, CD)$$

For four harmonic points the six cross-ratios become equal two and two:

$$\lambda = -1, 1-\lambda = 2, \frac{\lambda}{\lambda-1} = \frac{1}{2}, \frac{1}{\lambda} = -1, \frac{1}{1-\lambda} = \frac{1}{2}, \frac{\lambda-1}{\lambda} = 2.$$

Hence if we get four points whose cross-ratio is 2 or $\frac{1}{2}$, then they are harmonic, but not arranged so that conjugates are paired. If this is the case the cross-ratio = -1 .

§ 19. If we equate any two of the above six values of the cross-ratios, we get either $\lambda = 1, \infty, \infty$, or $\lambda = -1, 2, \frac{1}{2}$, or else λ becomes a root of the equation $\lambda^3 - \lambda + 1 = 0$, that is, an imaginary cube root of -1 . In this case the six values become three and three equal, so that only two different values remain. This case, though important in the theory of cubic curves, is for our purposes of no interest, whilst harmonic points are all-important.

§ 20. From the definition of harmonic points, and by aid of § 11, the following properties are easily deduced.

If C and D are harmonic conjugates with regard to A and B , then one of them lies in the other without AB ; it is impossible to move from A to B without passing either through C or through D ; the one blocks the finite way, the other the way through infinity. This is expressed by saying A and B are "separated" by C and D .

For every position of C there will be one and only one point D which is its harmonic conjugate with regard to any point pair A, B .

If A and B are different points, and if C coincides with A or B, D does. But if A and B coincide, one of the points C or D, D lying between them, coincides with them, and the other may be anywhere in the line. It follows that, "if of four harmonic conjugates two coincide, then a third coincides with them, and the fourth may be any point in the line."

If C is the middle point between A and B , then D is the point at infinity; for $AC:CB = +1$, hence $AD:DB$ must be equal to -1 . The harmonic conjugate of the point at infinity in a line with regard to two points A, B is the middle point of AB .

This important property gives a first example how metric properties are connected with projective ones.

§ 21. Harmonic properties of the complete quadrilateral and quadrangle.

A figure formed by four lines in a plane is called a *complete quadrilateral*, or, shorter, a *four-side*. The four sides meet in six points, named the "vertices," which may be joined by three lines (other than the sides), named the "diagonals," or "harmonic lines." The diagonals enclose the "harmonic triangle of the quadrilateral." In fig. 7, $A'B'C$, $B'AC$, $C'AB$, CBA are the sides, AA' , BB' , CC'

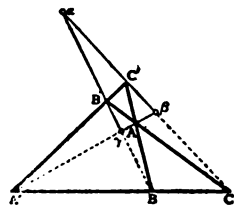

FIG. 7.

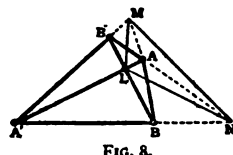

FIG. 8.

the vertices, AA' , BB' , CC' the harmonic lines, and ΔB the harmonic triangle of the quadrilateral. A figure formed by four coplanar points is named a *complete quadrangle*, or, shorter, a *four-point*. The four points may be joined by six lines, named the "sides," which intersect in three other points, termed the "diagonal or harmonic points." The harmonic points are the vertices of the "harmonic triangle of the complete quadrangle." In fig. 8, AA' , BB' are the points, AA' , BB' , $A'B'$, $B'A$, AB , BA' are the sides, L , M , N are the diagonal points, and LMN is the harmonic triangle of the quadrangle.

The harmonic property of the complete quadrilateral is: Any diagonal or harmonic line is harmonically divided by the other two; and of a complete quadrangle: The angle at any harmonic point is divided harmonically by the joins to the other harmonic points. To prove the first theorem, we have to prove $(AA', B\gamma)$, $(BB', \gamma\delta)$, $(CC', \delta\alpha)$ are harmonic. Consider the cross-ratio $(CC', \delta\beta) = A(BB', \delta\gamma)$. Then projecting from A on BB' , we have $A(CC', \delta\beta) = A(BB', \delta\gamma)$. Projecting from A' on BB' , $A'(CC', \delta\beta) = A'(BB', \delta\gamma)$. Hence $(B\beta, \delta\gamma) = (BB', \delta\gamma)$, i. e. the cross-ratio $(BB', \delta\gamma)$ equals that of its reciprocal; hence the range is harmonic.

The second theorem states that the pencils $L(BA, NM)$, $M(B'A, LN)$, $N(BA, LM)$ are harmonic. Deferring the subject of harmonic pencils to the next section, it will suffice to state here that any transversal intersects an harmonic pencil in an harmonic range. Consider the pencil $L(BA, NM)$, then it is sufficient to prove (BA', NM') is harmonic. This follows from the previous theorem by considering $A'B$ as a diagonal of the quadrilateral $ALB'M$.

This property of the complete quadrilateral allows the solution of the problem:

To construct the harmonic conjugate D to a point C with regard to two given points A and B .

Through A draw any two lines, and through C one cutting the former two in G and H . Join these points to B , cutting the former two lines in E and F . The point D where EF cuts AB will be the harmonic conjugate required.

This remarkable construction requires nothing but the drawing of lines, and is therefore independent of measurement. In a similar manner the harmonic conjugate of the line VA for two lines VC , VD is constructed with the aid of the property of the complete quadrangle.

§ 22. *Harmonic Pencils.*—The theory of cross-ratios may be extended from points in a row to lines in a flat pencil and to planes in an axial pencil. We have seen (§ 13) that if the lines which join four points A, B, C, D to any point S be cut by any other line in A', B', C', D' , then $(AB, CD) = (A'B', C'D')$. In other words, four lines in a flat pencil are cut by every other line in four points whose cross-ratio is constant.

Definition.—By the cross-ratio of four rays in a flat pencil is meant the cross-ratio of the four points in which the rays are cut by any line. If a, b, c, d be the lines, then this cross-ratio is denoted by (ab, cd) .

Definition.—By the cross-ratio of four planes in an axial pencil is understood the cross-ratio of the four points in which any line cuts the planes, or, what is the same thing, the cross-ratio of the four rays in which any plane cuts the four planes.

In order that this definition may have a meaning, it has to be proved that all lines cut the pencil in points which have the same cross-ratio. This is seen at once for two intersecting lines, as their plane cuts the axial pencil in a flat pencil, which is itself cut by the two lines. The cross-ratio of the four points on one line is therefore equal to that on the other, and equal to that of the four rays in the flat pencil.

If two non-intersecting lines ρ and q cut the four planes in A, B, C, D and A', B', C', D' , draw a line r to meet both ρ and q , and let this line cut the planes in A'', B'', C'', D'' . Then $(AB, CD) = (A'B', C'D') = (A''B'', C''D'')$.

§ 23. We may now also extend the notion of harmonic elements, viz.

Definition.—Four rays in a flat pencil and four planes in an axial pencil are said to be harmonic if their cross-ratio equals -1 , that is, if they are cut by a line in four harmonic points.

If we understand by a "median line" of a triangle a line which joins a vertex to the middle point of the opposite side, and by a "median line" of a parallelogram a line joining middle points of opposite sides, we get as special cases of the last theorem:

The diagonals and median lines of a parallelogram form an harmonic pencil; and

At a vertex of any triangle, the two sides, the median line, and the line parallel to the base form an harmonic pencil.

Taking the parallelogram a rectangle, or the triangle isosceles, we get:

Any two lines and the bisections of their angles form an harmonic pencil. Or:

In an harmonic pencil, if two conjugate rays are perpendicular, then the other two are equally inclined to them; and, conversely, if one ray bisects the angle between conjugate rays, it is perpendicular to its conjugate.

This connects perpendicularity and bisection of angles with projective properties.

§ 24. We add a few theorems and problems which are easily proved or solved by aid of harmonics.

An harmonic pencil is cut by a line parallel to one of its rays in three equidistant points.

Through a given point to draw a line such that the segment determined on it by a given angle is bisected at that point.

Having given two parallel lines, to bisect on either any given segment without using a pair of compasses.

Having given in a line a segment and its middle point, to draw through any given point in the plane a line parallel to the given line.

To draw a line which joins a given point to the intersection of two given lines which meet off the drawing paper (by aid of § 21).

CORRESPONDENCE. HOMOGRAPHIC AND PERSPECTIVE RANGES

§ 25. Two rows, ρ and ρ' , which are one the projection of the other (as in fig. 3), stand in a definite relation to each other, characterized by the following properties.

1. To each point in either corresponds one point in the other; that is, those points are said to correspond which are projections of one another.

2. The cross-ratio of any four points in one equals that of the corresponding points in the other.

3. The lines joining corresponding points all pass through the same point.

If we suppose corresponding points marked, and the rows brought into any other position, then the lines joining corresponding points will no longer meet in a common point, and hence the third of the above properties will not hold any longer; but we have still a correspondence between the points in the two rows possessing the first two properties. Such a correspondence has been called a *one-one correspondence*, whilst the two rows between which such correspondence has been established are said to be *projective* or *homographic*.

Two rows which are each the projection of the other are therefore *projective*. We shall presently see, also, that any two projective rows may always be placed in such a position that one appears as the projection of the other. If they are in such a position the rows are said to be in *perspective position*, or simply to be in *perspective*.

§ 26. The notion of a one-one correspondence between rows may be extended to flat and axial pencils, viz. a flat pencil will be said to be projective to a flat pencil if to each ray in the first corresponds one ray in the second, and if the cross-ratio of four rays in one equals that of the corresponding rays in the second.

Similarly an axial pencil may be projective to an axial pencil. But a flat pencil may also be projective to an axial pencil, or either pencil may be projective to a row. The definition is the same in each case: there is a one-one correspondence between the elements, and four elements have the same cross-ratio as the corresponding ones.

§ 27. There is also in each case a special position which is called *perspective*, viz.

1. Two projective rows are perspective if they lie in the same plane, and if the one row is a projection of the other.

2. Two projective flat pencils are perspective—(1) if they lie in the same plane, and have a row as a common section; (2) if they lie in the same pencil (in space), and are both sections of the same axial pencil; (3) if they are in space and have a row as common section, or are both sections of the same axial pencil, one of the conditions involving the other.

3. Two projective axial pencils, if their axes meet, and if they have a flat pencil as a common section.

4. A row and a projective flat pencil, if the row is a section of the pencil, each point lying in its corresponding line.

5. A row and a projective axial pencil, if the row is a section of the pencil, each point lying in its corresponding line.

6. A flat and a projective axial pencil, if the former is a section of the other, each ray lying in its corresponding plane.

That in each case the correspondence established by the position indicated is such as has been called projective follows at once from the definition. It is not so evident that the perspective position may always be obtained. We shall show in § 30 this for the first three

cases. First, however, we shall give a few theorems which relate to the general correspondence, not to the perspective position.

§ 28. *Two rows or pencils, flat or axial, which are projective to a third are projective to each other; this follows at once from the definitions.*

§ 29. *If two rows, or two pencils, either flat or axial, or a row and a pencil, be projective, we may assume to any three elements in the one the three corresponding elements in the other, and then the correspondence is uniquely determined.*

For if in two projective rows we assume that the points A, B, C in the first correspond to the given points A', B', C' in the second, then to any fourth point D in the first will correspond a point D' in the second, so that

$$(AB, CD) = (A'B', C'D').$$

But there is only one point, D' , which makes the cross-ratio $(A'B', C'D')$ equal to the given number (AB, CD) .

The same reasoning holds in the other cases.

§ 30. If two rows are perspective, then the lines joining corresponding points all meet in a point, the centre of projection; and the point in which the two bases of the rows intersect as a point in the first row coincides with its corresponding point in the second.

This follows from the definition. The converse also holds, viz.

If two projective rows have such a position that one point in the one coincides with its corresponding point in the other, then they are perspective, that is, the lines joining corresponding points all pass through a common point, and form a flat pencil.

For let A, B, C, D, \dots be points in the one, and A', B', C', D', \dots the corresponding points in the other row, and let A be made to coincide with its corresponding point A' . Let S be the point where the lines BB' and CC' meet, and let us join S to the point D in the first row. This line will cut the second row in a point D' , so that A, B, C, D are projected from S into the points A', B', C', D' . The cross-ratio (AB, CD) is therefore equal to $(A'B', C'D')$, and by hypothesis it is equal to $(A'B', C'D')$. Hence $(A'B', C'D') = (A'B', C'D')$, that is, D' is the same point as D .

§ 31. If two projected flat pencils in the same plane are in perspective, then the intersections of corresponding lines form a row, and the line joining the two centres as a line in the first pencil corresponds to the same line as a line in the second. And conversely,

If two projective pencils in the same plane, but with different centres, have one line in the one coincident with its corresponding line in the other, then the two pencils are perspective, that is, the intersection of corresponding lines lie in a line.

The proof is the same as in § 30.

§ 32. If two projective flat pencils in the same point (pencil in space), but not in the same plane, are perspective, then the planes joining corresponding rays all pass through a line (they form an axial pencil), and the line common to the two pencils (in which their planes intersect) corresponds to itself. And conversely:—

If two flat pencils which have a common centre, but do not lie in a common plane, are placed so that one ray in the one coincides with its corresponding ray in the other, then they are perspective, that is, the planes joining corresponding lines all pass through a line.

§ 33. If two projective axial pencils are perspective, then the intersection of corresponding planes lie in a plane, and the plane common to the two pencils (in which the two axes lie) corresponds to itself. And conversely:—

If two projective axial pencils are placed in such a position that a plane in the one coincides with its corresponding plane, then the two pencils are perspective, that is, corresponding planes meet in lines which lie in a plane.

The proof again is the same as in § 30.

§ 34. These theorems relating to perspective position become illusory if the projective rows or pencils have a common base. We then have:—

In two projective rows on the same line—and also in two projective and concentric flat pencils in the same plane, or in two projective axial pencils with a common axis—every element in the one coincides with its corresponding element in the other as soon as three elements in the one coincide with their corresponding elements in the other.

Proof (in case of two rows).—Between four elements A, B, C, D and their corresponding elements A', B', C', D' exists the relation $(ABCD) = (A'B'C'D')$. If now A', B', C' coincide respectively with A, B, C , we get $(AB, CD) = (AB, CD')$, hence D and D' coincide.

The last theorem may also be stated thus:—

In two projective rows or pencils, which have a common base but are not identical, not more than two elements in the one can coincide with their corresponding elements in the other.

Thus two projective rows on the same line cannot have more than two pairs of coincident points unless every point coincides with its corresponding point.

It is easy to construct two projective rows on the same line, which have two pairs of corresponding points coincident. Let the points A, B, C as points belonging to the one row correspond to $A,$

$B,$ and C' as points in the second. Then A and B coincide with their corresponding points, but C does not. It is, however, not necessary that two such rows have twice a point coincident with its corresponding point; it is possible that this happens only once or not at all. Of this we shall see examples later.

§ 35. If two projective rows or pencils are in perspective position, we know at once which element in one corresponds to any given element in the other. If p and q (fig. 9) are two projective rows, so that K corresponds to itself, and if we know that A and B in p correspond A' and B' in q , then the point S , where AA' meets BB' , is the centre of projection, and hence, in order to find the point C , corresponding to C' , we have only to join C' to S ; the point C , where this line cuts q , is the point required.

If two flat pencils, S_1 and S_2 , in a plane are perspective (fig. 10), we need only to know two pairs, a, a' and b, b' , of corresponding rays in order to find the axis s of projection. This being known, a ray c in S_2 , corresponding to a given ray c' in S_1 , is found by joining c' to the point where c cuts the axis s .

A similar construction holds in the other cases of perspective figures. On this depends the solution of the following general problem.

§ 36. Three pairs of corresponding elements in two projective rows or pencils being given, to determine for any element in one the corresponding element in the other.

We solve this in the two cases of two projective rows and of two projective flat pencils in a plane.

Problem I.—Let A, B, C be three points in a row s , A', B', C' the corresponding points in a projective row s' , both being in a plane; it is required to find for any point D in s the corresponding point D' in s' .

The solution is made to depend on the construction of an auxiliary row or pencil which is perspective to both the given ones. This is found as follows:—

Solution of Problem I.—On the line joining two corresponding points, say AA' (fig. 11), take any two points, S and S' , as centres of auxiliary pencils.

Join the intersection B_1 of SB and $S'B'$ to the intersection C_1 of SC and $S'C'$ by the line s_1 . Then a row on s_1 will be perspective to s with S as centre of projection, and to s' with S' as centre. To find now the point D' on s' corresponding to a point D on s we have only to determine the point D_1 , where the line SD cuts s_1 , and to draw $S'D_1$; the point where this line cuts s' will be the required point D' .

Proof.—The rows s and s' are both perspective to the row s_1 , hence they are projective to one another. To A, B, C, D on s correspond A_1, B_1, C_1, D_1 on s_1 , and to these correspond A', B', C', D' on s' ; so that D and D' are corresponding points as required.

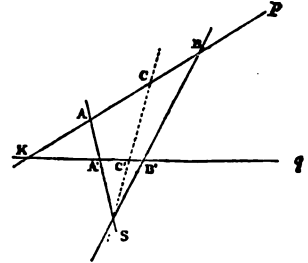

FIG. 9.

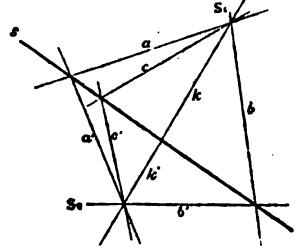

FIG. 10.

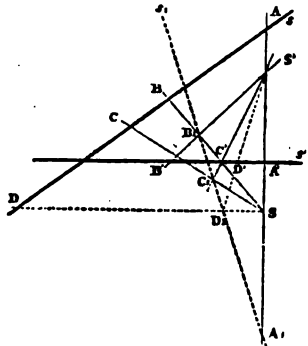

FIG. 11.

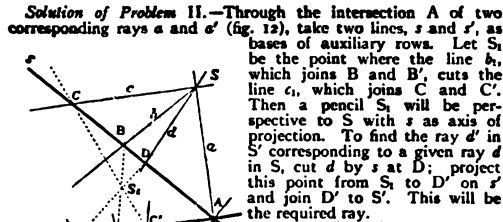

FIG. 12.

Solution of Problem II.—Through the intersection A of two corresponding rays a and a' (fig. 12), take two lines, s and s' , as bases of auxiliary rows. Let S_1 be the point where the line b_1 , which joins B and B' , cuts the line c_1 , which joins C and C' . Then a pencil S_1 will be perspective to S with s as axis of projection. To find the ray d' in S' corresponding to a given ray d in S , cut d by s at D ; project this point from S_1 to D' on s' and join D' to S' . This will be the required ray.

Proof.—That the pencil S_1 is perspective to S and also to S' follows from construction. To the lines a_1, b_1, c_1, d_1 in S_1 correspond the lines a, b, c, d in S and the lines a', b', c', d' in S' , so that d and d' are corresponding rays.

In the first solution the two centres, S, S' , are any two points on a line joining any two corresponding points, so that the solution of the problem allows of a great many different constructions.

But whatever construction be used, the point D' , corresponding to D , must be always the same, according to the theorem in § 29. This gives rise to a number of theorems, into which, however, we shall not enter. The same remarks hold for the second problem.

§ 37. *Homological Triangles.*—As a further application of the theorems about perspective rows and pencils we shall prove the following important theorem.

Theorem.—If ABC and $A'B'C'$ (fig. 13) be two triangles, such that the lines AA', BB', CC' meet in a point S , then the intersections of BC and $B'C'$, of CA and $C'A'$, and of AB and $A'B'$ will lie in a line. Such triangles are said to be homological, or in perspective. The triangles are "co-axial" in virtue of the property that the meets of corresponding sides are collinear and coplanar, since the lines joining corresponding vertices are concurrent.

Proof.—Let a, b, c denote the lines AA', BB', CC' , which meet at S . Then these may be taken as bases of projective rows, so that A, A', S on a correspond to B, B', S on b , and to C, C', S on c . As the point S is common to all, any two of these rows will be perspective.

If S_1 be the centre of projection of rows b and c ,
 S_1 " " " " " " c and a ,
 S_2 " " " " " " a and b ,

and if the line $S_1S_2S_3$ cuts a in A_1 , and b in B_1 , and c in C_1 , then A_1, B_1 will be corresponding points in a and b , both corresponding to C_1 in c . But a and b are perspective, therefore the line A_1B_1 , that is S_1S_2 , joining corresponding points must pass through the centre of projection S_3 of a and b . In other words, S_1, S_2, S_3 lie in a line. This is Desargues' celebrated theorem if we state it thus:—

Theorem of Desargues.—If each of two triangles has one vertex on each of three concurrent lines, then the intersections of corresponding sides lie in a line, those sides being called corresponding which are opposite to vertices on the same line.

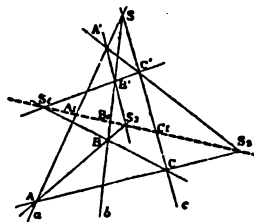

FIG. 13.

being called corresponding which are opposite to vertices on the same line.

The converse theorem holds also, viz.

Theorem.—If the sides of one triangle meet those of another in three points which lie in a line, then the vertices lie on three lines which meet in a point.

The proof is almost the same as before.

§ 38. *Metric Relations between Projective Rows.*—Every row contains one point which is distinguished from all others, viz. the point at infinity. In two projective rows, to the point I at infinity in one corresponds a point I' in the other, and to the point J' at infinity in the second corresponds a point J in the first. The points I' and J are in general finite. If now A and B are any two points in the one, A', B' the corresponding points in the other row, then

$$(AB, JI) = (A'B', J'I'),$$

or

$$AJ/JB : AI/IB = A'J'/J'B' : A'I'/I'B'.$$

But, by § 17,

$$AI/IB = A'J'/J'B' = -1;$$

therefore the last equation changes into

$$AJ \cdot A'I' = BJ \cdot B'I',$$

that is to say—

Theorem.—The product of the distances of any two corresponding points in two projective rows from the points which correspond to the points at infinity in the other is constant, viz. $AJ \cdot A'I' = k$. Steiner has called this number k the *Power of the correspondence*.

[The relation $AJ \cdot A'I' = k$ shows that if J, I' be given then the point A' corresponding to a specified point A is readily found; hence A, A' generate homographic ranges of which I and J' correspond to the points at infinity on the ranges. If we take any two origins O, O' , on the ranges and reduce the expression $AJ \cdot A'I' = k$ to its algebraic equivalent, we derive an equation of the form $axx' + bx + yz' + z = 0$. Conversely, if a relation of this nature holds, then points corresponding to solutions in x, x' form homographic ranges.]

§ 39. *Similar Rows.*—If the points at infinity in two projective rows correspond so that I' and J are at infinity, this result loses its meaning. But if A, B, C be any three points in one, A', B', C' the corresponding ones on the other row, we have

$$(AB, CI) = (A'B', C'I'),$$

which reduces to

$$AC/CB = A'C'/C'B' \text{ or } AC/A'C' = BC/B'C',$$

that is, corresponding segments are proportional. Conversely, if corresponding segments are proportional, then to the point at infinity in one corresponds the point at infinity in the other. If we call such rows *similar*, we may state the result thus—

Theorem.—Two projective rows are similar if to the point at infinity in one corresponds the point at infinity in the other, and conversely, if two rows are similar then they are projective, and the points at infinity are corresponding points.

From this the well-known propositions follow—

Two lines are cut proportionally (in similar rows) by a series of parallels. The rows are perspective, with centre of projection at infinity.

If two similar rows are placed parallel, then the lines joining homologous points pass through a common point.

§ 40. If two flat pencils be projective, then there exists in either, one single pair of lines at right angles to one another, such that the corresponding lines in the other pencil are again at right angles.

To prove this, we place the pencils in perspective position (fig. 14) by making one ray coincident with its corresponding ray. Corresponding rays meet then on a line p . And now we draw the circle which has its centre O on p , and which passes through the centres S and S' of the two pencils. This circle cuts p in two points H and K . The two pairs of rays, h, k , and h', k' , joining these points to S and S' will be pairs of corresponding rays at right angles. The construction gives in general but one circle, but if the line p is the perpendicular bisector of SS' , there exists an infinite number, and to every right angle in the one pencil corresponds a right angle in the other.

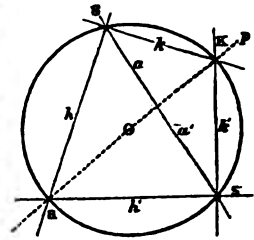

FIG. 14.

PRINCIPLE OF DUALITY

§ 41. It has been stated in § 1 that not only points, but also planes and lines, are taken as elements out of which figures are built up. We shall now see that the construction of one figure which possesses certain properties gives rise in many cases to the construction of another figure, by replacing, according to definite rules, elements of one kind by those of another. The new figure thus obtained will then possess properties which may be stated as soon as those of the original figure are known.

We obtain thus a principle, known as the *principle of duality* or of *reciprocity*, which enables us to construct to any figure not containing any measurement in its construction a *reciprocal figure*, as it is called, and to deduce from any theorem a *reciprocal theorem*, for which no further proof is needed.

It is convenient to print reciprocal propositions on opposite sides of a page broken into two columns, and this plan will occasionally be adopted.

We begin by repeating in this form a few of our former statements:—

- | | |
|---|--|
| Two points determine a line. | Two planes determine a line. |
| Three points which are not in a line determine a plane. | Three planes which do not pass through a line determine a point. |
| A line and a point without it determine a plane. | A line and a plane not through it determine a point. |
| Two lines in a plane determine a point. | Two lines through a point determine a plane. |

These propositions show that it will be possible, when any figure is given, to construct a second figure by taking planes instead of points, and points instead of planes, but lines where we had lines.

For instance, if in the first figure we take a plane and three points in it, we have to take in the second figure a point and three planes through it. The three points in the first, together with the three lines joining them two and two, form a triangle; the three planes in the second and their three lines of intersection form a trihedral angle. A triangle and a trihedral angle are therefore reciprocal figures.

Similarly, to any figure in a plane consisting of points and lines will correspond a figure consisting of planes and lines passing through a point *S*, and hence belonging to the pencil which has *S* as centre. The figure reciprocal to four points in space which do not lie in a plane will consist of four planes which do not meet in a point. In this case each figure forms a tetrahedron.

§ 42. As other examples we have the following:—

- To a row is reciprocal an axial pencil,
- „ a flat pencil „ a flat pencil,
- „ a field of points and lines „ a pencil of planes and lines,
- „ the space of points „ the space of planes.

For the row consists of a line and all the points in it, reciprocal to it therefore will be a line with all planes through it, that is, an axial pencil; and so for the other cases.

This correspondence of reciprocity breaks down, however, if we take figures which contain measurement in their construction. For instance, there is no figure reciprocal to two planes at right angles, because there is no segment in a row which has a magnitude as definite as a right angle.

We add a few examples of reciprocal propositions which are easily proved.

Theorem.—If *A, B, C, D* are any four points in space, and if the lines *AB* and *CD* meet, then all four points lie in a plane, hence also *AC* and *BD*, as well as *AD* and *BC*, meet.

Theorem.—If of any number of lines every one meets every other, whilst all do not

lie in a point, then all lie in a plane.

§ 43. Reciprocal figures as explained lie both in space of three dimensions. If the one is confined to a plane (is formed of elements which lie in a plane), then the reciprocal figure is confined to a pencil (is formed of elements which pass through a point).

But there is also a more special principle of duality, according to which figures are reciprocal which lie both in a plane or both in a pencil. In the plane we take points and lines as reciprocal elements, for they have this fundamental property in common, that two elements of one kind determine one of the other. In the pencil, on the other hand, lines and planes have to be taken as reciprocal, and here it holds again that two lines or planes determine one plane or line.

Thus, to one plane figure we can construct one reciprocal figure in the plane, and to each one reciprocal figure in a pencil. We mention a few of these. At first we explain a few names:—

A figure consisting of *n* points in a plane will be called an *n*-side. A figure consisting of *n* lines in a plane will be called an *n*-side.

A figure consisting of *n* planes in a pencil will be called an *n*-flat. A figure consisting of *n* lines in a pencil will be called an *n*-edge.

It will be understood that an *n*-side is different from a polygon of *n* sides. The latter has sides of finite length and *n* vertices, the former has sides all of infinite extension, and every point where two of the sides meet will be a vertex. A similar difference exists between a solid angle and an *n*-edge or an *n*-flat. We notice particularly—

A four-point has six sides, of which two and two are opposite; and three diagonal points, which are intersections of opposite sides.

A four-flat has six edges, of which two and two are opposite, and three diagonal planes, which pass through opposite edges.

A four-side is usually called a complete quadrilateral, and a four-point a complete quadrangle. The above notation, however, seems better adapted for the statement of reciprocal propositions.

§ 44.

If a point moves in a plane it describes a plane curve.

If a plane moves in a pencil it envelopes a cone.

A curve thus appears as generated either by points, and then we call it a "locus," or by lines, and then we call it an "envelope." In the same manner a cone, which means here a surface, appears either as the locus of lines passing through a fixed point, the "vertex" of the cone, or as the envelope of planes passing through the same point.

To a surface as locus of points corresponds, in the same manner, a surface as envelope of planes; and to a curve in space as locus of points corresponds a developable surface as envelope of planes.

It will be seen from the above that we may, by aid of the principle of duality, construct for every figure a reciprocal figure, and that to any property of the one a reciprocal property of the other will exist, as long as we consider only properties which depend upon nothing but the positions and intersections of the different elements and not upon measurement.

For such propositions it will therefore be unnecessary to prove more than one of two reciprocal theorems.

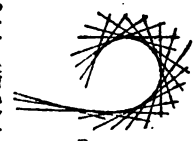

FIG. 15.

GENERATION OF CURVES AND CONES OF SECOND ORDER OR SECOND CLASS

§ 45. Conics.—If we have two projective pencils in a plane, corresponding rays will meet, and their point of intersection will constitute some locus which we have to investigate. Reciprocally, if two projective rows in a plane are given, then the lines which join corresponding points will envelope some curve. We prove first:—

Theorem.—If two projective flat pencils lie in a plane, but are neither in perspective nor concentric, then the locus of intersections of corresponding rays is a curve of the second order, that is, no line contains more than two points of the locus.

Proof.—We draw any line *l*. This cuts each of the pencils in a row, so that we have on *l* two rows, and these are projective because the pencils are projective. If corresponding rays of the two pencils meet on the line *l*, their intersection will be a point in the one row which coincides with its corresponding point in the other. But two projective rows on the same base cannot have more than two points of one coincident with their corresponding points in the other (§ 34).

It will be seen that the proofs are reciprocal, so that the one may be copied from the other by simply interchanging the words point and line, locus and envelope, row and pencil, and so on. We shall therefore in future prove seldom more than one of two reciprocal theorems, and often state one theorem only, the reader being recommended to go through the reciprocal proof by himself, and to supply the reciprocal theorems when not given.

§ 46. We state the theorems in the pencil reciprocal to the last, without proving them:—

Theorem.—If two projective flat pencils are concentric, but are neither perspective nor coplanar, then the envelope of the planes joining corresponding rays is a cone of the second class; that is, no line through the common centre contains more than two of the enveloping planes.

§ 47. Of theorems about cones of second order and cones of second class we shall state only very few. We point out, however, the following connexion between the curves and cones under consideration:

The lines which join any point in space to the points on a curve of the second order form a cone of the second order.

The planes which join any point in space to the lines enveloping a curve of the second class envelope themselves a cone of the second class.

By its aid, or by the principle of duality, it will be easy to obtain theorems about them from the theorems about the curves.

We prove the first. A curve of the second order is generated by two projective pencils. These pencils, when joined to the point in space, give rise to two projective axial pencils, which generate the cone in question as the locus of the lines where corresponding planes meet.

§ 48.

Theorem.—The curve of second order which is generated by two projective flat pencils passes through the centres of the two pencils.

Proof.—If S and S' are the two pencils, then to the ray SS' or p' in the pencil S' corresponds in the pencil S a ray p , which is different from p' , for the pencils are not perspective. But p and p' meet at S , so that S is a point on the curve, and similarly S' .

It follows that every line in one of the two pencils cuts the curve in two points, viz. once at the centre S of the pencil, and once where it cuts its corresponding ray in the other pencil. These two points, however, coincide, if the line is cut by its corresponding line at S itself. The line p in S , which corresponds to the line SS' in S' , is therefore the only line through S which has but one point in common with the curve, or which cuts the curve in two coincident points. Such a line is called a *tangent* to the curve, touching the latter at the point S , which is called the "point of contact".

In the same manner we get in the reciprocal investigation the result that through every point in one of the rows, say in s , two tangents may be drawn to the curve, the one being s , the other the line joining the point to its corresponding point in s' . There is, however, one point P in s for which these two lines coincide. Such a point in one of the tangents is called the "point of contact" of the tangent. We thus get—

Theorem.—To the line joining the centres of the projective pencils as a line in one pencil corresponds in the other the tangent at its centre.

§ 49. Two projective pencils are determined if three pairs of corresponding lines are given. Hence if a_1, b_1, c_1 are three lines in a pencil S_1 , and a_2, b_2, c_2 the corresponding lines in a projective pencil S_2 , the correspondence and therefore the curve of the second order generated by the points of intersection of corresponding rays is determined. Of this curve we know the two centres S_1 and S_2 , and the three points a_1a_2, b_1b_2, c_1c_2 , hence five points in all. This and the reciprocal considerations enable us to solve the following two problems:

Problem.—To construct a curve of the second order, of which five points S_1, S_2, A, B, C are given.

In order to solve the left-hand problem, we take two of the given points, say S_1 and S_2 , as centres of pencils. These we make projective by taking the rays a_1, b_1, c_1 , which join S_1 to A, B, C respectively, as corresponding to the rays a_2, b_2, c_2 , which join S_2 to A, B, C respectively, so that three rays meet their corresponding rays at the given points A, B, C . This determines the correspondence of the pencils which will generate a curve of the second order passing through A, B, C and through the centres S_1 and S_2 , hence through the five given points. To find more points on the curve we have to construct for any ray in S_1 the corresponding ray in S_2 . This has been done in § 36. But we repeat the construction in order to deduce further properties from it. We also solve the right-hand problem. Here we select two, viz. u_1, u_2 of the five given lines, a, b, c , as bases of two rows, and the points A_1, B_1, C_1 where a, b, c cut u_1 as corresponding to the points A_2, B_2, C_2 where a, b, c cut u_2 .

We get then the following solutions of the two problems:

Solution.—Through the point A draw any two lines, u_1 and u_2 (fig. 16), the first u_1 to cut the pencil S_1 in a row AB_1C_1 , the other u_2 to cut the pencil S_2 in a row AB_2C_2 . These two rows will be perspective, as the point A corresponds to itself, and the centre of projection will be the point S , where the lines B_1B_2 and C_1C_2 meet. To find now for any ray d_1 in S_1 its corresponding ray d_2 in S_2 , we determine the point D_1 where d_1 cuts u_1 , project this point from S to D_2 on u_2 and join S_2 to D_2 . This will be the required ray d_2 which cuts d_1 at some point D on the curve.

§ 50. These constructions prove, when rightly interpreted, very important properties of the curves in question.

Theorem.—The envelope of second class which is generated by two projective rows contains the bases of these rows as enveloping lines or tangents.

Proof.—If s and s' are the two rows, then to the point ss' or P' as a point in s' corresponds in s a point P , which is not coincident with P' , for the rows are not perspective. But P and P' are joined by s , so that s is one of the enveloping lines, and similarly s' .

Theorem.—To the point of intersection of the bases of two projective rows as a point in one row corresponds in the other the point of contact of its base.

If in fig. 16 we draw in the pencil S_1 the ray k_1 which passes

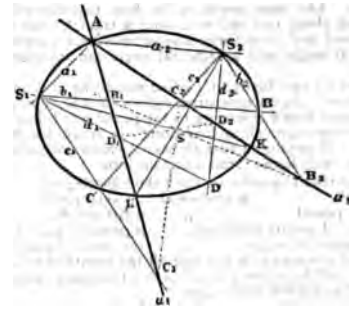

FIG. 16.

through the auxiliary centre S , it will be found that the corresponding ray k_2 cuts it on u_2 . Hence—

Theorem.—In the above construction the bases of the auxiliary rows u_1 and u_2 cut the curve from the centres of the where they cut the rays SS and S_2S respectively.

Theorem.—In the above construction the tangents to the curve from the centres of the auxiliary pencils S_1 and S_2 are the lines which pass through u_1A and u_2A respectively.

As A is any given point on the curve, and u_1 any line through it, we have solved the problems:

Problem.—To find the second point in which any line through a known point on the curve cuts the curve.

Problem.—To find the second tangent which can be drawn from any point in a given tangent to the curve.

If we determine in S_1 (fig. 16) the ray corresponding to the ray S_2S_1 in S_2 , we get the tangent at S_1 . Similarly, we can determine the point of contact of the tangents u_1 or u_2 in fig. 17.

§ 51. If five points are given, of which not three are in a line, then we can, as has just been shown, always draw a curve of the

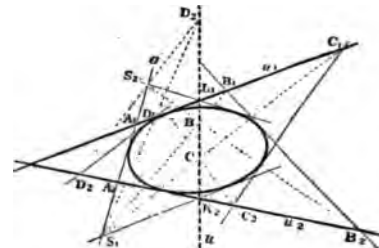

FIG. 17.

second order through them; we select two of the points as centres of projective pencils, and then one such curve is determined. It will be presently shown that we get always the same curve if two other points are taken as centres of pencils, that therefore five points determine one curve of the second order, and reciprocally, that five tangents determine one curve of the second class. Six points taken at random will therefore not lie on a curve of the second order. In order that this may be the case a certain condition has to be satisfied, and this condition is easily obtained from the construction in § 49, fig. 16. If we consider the conic determined by the five points A, S_1, S_2, K, L , then the point D will be on the curve if, and only if, the points on D_1, S_1, D_2 be in a line.

This may be stated differently if we take AKS_1DS_2L (figs. 16 and 18) as a hexagon inscribed in the conic, then AK and DS_2 will be opposite sides, so will be KS_1 and S_2L , as well as S_1D and LA . The first two meet in D_1 , the others in S and D_2 respectively.

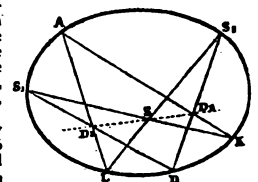

FIG. 18.

We may therefore state the required condition, together with the reciprocal one, as follows:—

Pascal's Theorem.—If a hexagon be inscribed in a curve of the second order, then the intersections of opposite sides are three points in a line.

These celebrated theorems, which are known by the names of their discoverers, are perhaps the most fruitful in the whole theory of conics. Before we go over to their applications we have to show that we obtain the same curve if we take, instead of S_1, S_2 , any two other points on the curve as centres of projective pencils.

§52. We know that the curve depends only upon the correspondence between the pencils S_1 and S_2 , and not upon the special construction used for finding new points on the curve. The point A (fig. 16 or 18), through which the two auxiliary rows w_1, w_2 were drawn, may therefore be changed to any other point on the curve. Let us now suppose the curve drawn, and keep the points S_1, S_2, K, L and D , and hence also the point S fixed, whilst we move A along the curve. Then the line AL will describe a pencil about L as centre, and the point D , a row on S_2D perspective to the pencil L . At the same time AK describes a pencil about K and D , a row perspective to it on S_1D . But by Pascal's theorem D , and D_2 will always lie in a line with S , so that the rows described by D , and D_2 are perspective. It follows that the pencils K and L will themselves be projective, corresponding rays meeting on the curve. This proves that we get the same curve whatever pair of the five given points we take as centres of projective pencils. Hence—

Only one curve of the second order can be drawn which passes through five given points. Only one curve of the second class can be drawn which touches five given lines.

We have seen that if on a curve of the second order two points coincide at A , the line joining them becomes the tangent at A . If, therefore, a point on the curve and its tangent are given, this will be equivalent to having given two points on the curve. Similarly, if on the curve of second class a tangent and its point of contact are given, this will be equivalent to two given tangents.

We may therefore extend the last theorem:
Only one curve of the second order can be drawn, of which four points and the tangent at one of them, or three points and the tangents at two of them, are given.
Only one curve of the second class can be drawn, of which four tangents and the point of contact at one of them, or three tangents and the points of contact at two of them, are given.

§53. At the same time it has been proved:
If all points on a curve of the second order be joined to any two of them, then the two pencils thus formed are projective, those rays being corresponding which meet on the curve. Hence—
All tangents to a curve of second class are cut by any two of them in projective rows, those being corresponding points which lie on the same tangent. Hence—

The cross-ratio of four rays joining a point S on a curve of second order to four fixed points A, B, C, D in the curve is independent of the position of S , and is called the cross-ratio of the four points A, B, C, D .
The cross-ratio of the four points in which any tangent u is cut by four fixed tangents a, b, c, d is independent of the position of u , and is called the cross-ratio of the four tangents a, b, c, d .

If this cross-ratio equals -1 the four points are said to be four harmonic points.
If this cross-ratio equals -1 the four tangents are said to be four harmonic tangents.

We have seen that a curve of second order, as generated by projective pencils, has at the centre of each pencil one tangent; and further, that any point on the curve may be taken as centre of such pencil. Hence—

A curve of second order has at every point one tangent. A curve of second class has on every tangent a point of contact.

§54. We return to Pascal's and Brianchon's theorems and their applications, and shall, as before, state the results both for curves of the second order and curves of the second class, but prove them only for the former.

Pascal's theorem may be used when five points are given to find more points on the curve, viz. it enables us to find the point where any line through one of the given points cuts the curve again. It is convenient, in making use of Pascal's theorem, to number the points, to indicate the order in which they are to be taken in forming a hexagon, which, by the way, may be done in 60 different ways. It will be seen that 1 2 (leaving out 3) 4 5 are opposite sides, so are 2 3 and (leaving out 4) 5 6, and also 3 4 and (leaving out 5) 6 1.

If the points 1 2 3 4 5 are given, and we want a 6th point on a line drawn through 1, we know all the sides of the hexagon with the exception of 5 6, and this is found by Pascal's theorem.

If this line should happen to pass through 1, then 6 and 1 coincide, or the line 6 1 is the tangent at 1. And always if two consecutive vertices of the hexagon approach nearer and nearer, then the side joining them will ultimately become a tangent.

We may therefore consider a pentagon inscribed in a curve of second order and the tangent at one of its vertices as a hexagon, and thus get the theorem:

Brianchon's Theorem.—If a hexagon be circumscribed about a curve of the second class, then the lines joining opposite vertices are three lines meeting in a point.

Every pentagon inscribed in a about a curve of the second order has the property that the intersections of two pairs of non-consecutive sides lie in a line with the point where the fifth side cuts the tangent at the opposite vertex.

Every pentagon circumscribed about a curve of the second class has the property that the lines which join two pairs of non-consecutive vertices meet on that line which joins the fifth vertex to the point of contact of the opposite side.

This enables us also to solve the following problems.

Given five points on a curve of second order to construct the tangent at any one of them.

Given five tangents to a curve of second class to construct the point of contact of any one of them.

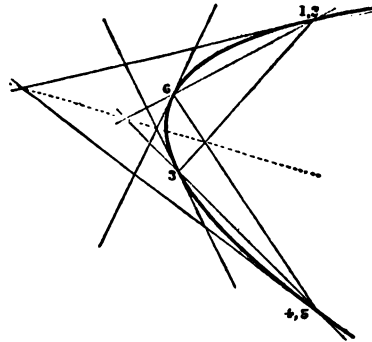

FIG. 19.

If two pairs of adjacent vertices coincide, the hexagon becomes a quadrilateral, with tangents at two vertices. These we take to be opposite, and get the following theorems:

If a quadrilateral be inscribed in a curve of second order, the intersections of opposite sides, and also the intersections of the tangents at opposite vertices, lie in a line (fig. 19).
If a quadrilateral be circumscribed about a curve of second class, the lines joining opposite vertices, and also the lines joining the points of contact of opposite sides, meet in a point.

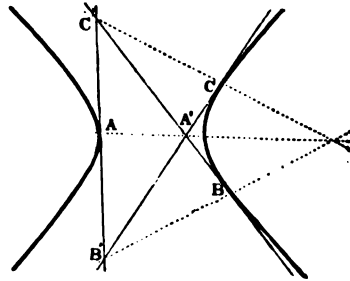

FIG. 20.

If we consider the hexagon made up of a triangle and the tangents at its vertices, we get—

If a triangle is inscribed in a curve of the second order, the points in which the sides are cut by the tangents at the opposite vertices meet in a point.
If a triangle be circumscribed about a curve of second class, the lines which join the vertices to the points of contact of the opposite sides meet in a point (fig. 20).

§55. Of these theorems, those about the quadrilateral give rise to a number of others. Four points A, B, C, D may in three different ways be formed into a quadrilateral, for we may take them in the order $ABCD$, or $ACBD$, or $ACDB$, so that either of the points B, C, D may be taken as the vertex opposite to A . Accordingly we may apply the theorem in three different ways.

Let A, B, C, D be four points on a curve of second order (fig. 21), and let us take them as forming a quadrilateral by taking the points in the order $ABCD$, so that A, C and also B, D are pairs of opposite vertices. Then P, Q will be the points where opposite sides meet,

four-point which is inscribed in both, and therefore one polar-triangle common to both.

Theorem.—Two conics which intersect in four points have always one and only one common polar-triangle; and reciprocally.
Two conics which have four common tangents have always one and only one common polar-triangle.

DIAMETERS AND AXES OF CONICS

§ 69. **Diameters.**—The theorems about the harmonic properties of poles and polars contain, as special cases, a number of important metrical properties of conics. These are obtained if either the pole or the polar is moved to infinity,—it being remembered that the harmonic conjugate to a point at infinity, with regard to two points A, B, is the middle point of the segment AB. The most important properties are stated in the following theorems.—

The middle points of parallel chords of a conic lie in a line—viz. on the polar to the point at infinity on the parallel chords.
This line is called a **diameter**.

The polar of every point at infinity is a diameter.
The tangents at the end points of a diameter are parallel, and are parallel to the chords bisected by the diameter.
All diameters pass through a common point, the **pole of the line at infinity**.

All diameters of a parabola are parallel, the pole to the line at infinity being the point where the curve touches the line at infinity.

In case of the ellipse and hyperbola, the pole to the line at infinity is a finite point called the **centre of the conic**.

A centre of a conic bisects every chord through it.
The centre of an ellipse is within the curve, for the line at infinity does not cut the ellipse.

The centre of a hyperbola is without the curve, because the line at infinity cuts the curve. Hence also—

From the centre of an hyperbola two tangents can be drawn to the curve which have their point of contact at infinity. These are called **Asymptotes** (§ 59).

To construct a diameter of a conic, draw two parallel chords and join their middle points.

To find the centre of a conic, draw two diameters; their intersection will be the centre.

§ 70. **Conjugate Diameters.**—A polar-triangle with one vertex at the centre will have the opposite side at infinity. The other two sides pass through the centre, and are called **conjugate diameters**, each being the polar of the point at infinity on the other.

Of two conjugate diameters each bisects the chords parallel to the other, and if one cuts the curve, the tangents at its ends are parallel to the other diameter.

Further—
Every parallelogram inscribed in a conic has its sides parallel to two conjugate diameters; and
Every parallelogram circumscribed about a conic has as diagonals two conjugate diameters.

This will be seen by considering the parallelogram in the first case as an inscribed four-point, in the other as a circumscribed four-side, and determining in each case the corresponding polar-triangle. The first may also be enunciated thus—

The lines which join any point on an ellipse or an hyperbola to the ends of a diameter are parallel to two conjugate diameters.

§ 71. *If every diameter is perpendicular to its conjugate the conic is a circle.*

For the lines which join the ends of a diameter to any point on the curve include a right angle.

A conic which has more than one pair of conjugate diameters at right angles to each other is a circle.

Let AA' and BB' (fig. 24) be one pair of conjugate diameters at right angles to each other, CC' and DD' a second pair. If we draw through the end point A of one diameter a chord AP parallel to DD', and join P to A', then PA and PA' are, according to § 70, parallel to two conjugate diameters. But PA is parallel to DD', hence PA' is parallel to CC', and therefore PA and PA' are perpendicular. If we further draw the tangents to the conic at A and A', these will be perpendicular to AA', they being parallel to the conjugate diameter BB'. We know thus five points on the conic, viz. the points A and A' with their tangents, and the point P. Through these a circle may be drawn having AA' as diameter; and as through five points



FIG. 24.

one conic only can be drawn, this circle must coincide with the given conic.

§ 72. **Axes.**—Conjugate diameters perpendicular to each other are called **axes**, and the points where they cut the curve **vertices** of the conic.

In a circle every diameter is an axis, every point on it is a vertex; and any two lines at right angles to each other may be taken as a pair of axes of any circle which has its centre at their intersection.

If we describe on a diameter AB of an ellipse or hyperbola a circle concentric to the conic, it will cut the latter in A and B (fig. 25). Each of the semicircles in which it is divided by AB will be partly within, partly without the curve, and must cut the latter therefore again in a point. The circle and the conic have thus four points

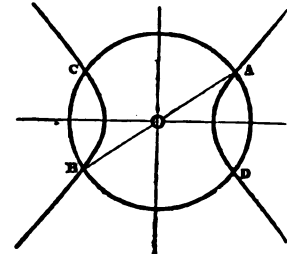

FIG. 25.

A, B, C, D, and therefore one polar-triangle, in common (§ 68). Of this the centre is one vertex, for the line at infinity is the polar to this point, both with regard to the circle and the other conic. The other two sides are conjugate diameters of both, hence perpendicular to each other. This gives—
An ellipse as well as an hyperbola has one pair of axes.

This reasoning shows at the same time how to construct the axis of an ellipse or of an hyperbola.

A parabola has one axis, if we define an axis as a diameter perpendicular to the chords which it bisects. It is easily constructed. The line which bisects any two parallel chords is a diameter. Chords perpendicular to it will be bisected by a parallel diameter, and this is the axis.

§ 73. The first part of the right-hand theorem in § 64 may be stated thus: any two conjugate lines through a point P without a conic are harmonic conjugates with regard to the two tangents that may be drawn from P to the conic.

If we take instead of P the centre C of an hyperbola, then the conjugate lines become conjugate diameters, and the tangents asymptotes. Hence—

Any two conjugate diameters of an hyperbola are harmonic conjugates with regard to the asymptotes.

As the axes are conjugate diameters at right angles to one another, it follows (§ 23)—

The axes of an hyperbola bisect the angles between the asymptotes.

Let O be the centre of the hyperbola (fig. 26), l any secant which cuts the hyperbola in C, D and the asymptotes in E, F, then the line OM which bisects the chord CD is a diameter conjugate to the

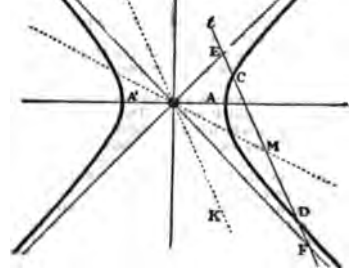

FIG. 26.

diameter OK which is parallel to the secant l, so that OK and OM are harmonic with regard to the asymptotes. The point M therefore bisects EF. But by construction, M bisects CD. It follows that DF = EC, and ED = CF; or

On any secant of an hyperbola the segments between the curve and the asymptotes are equal.

If the chord is changed into a tangent, this gives—
The segment between the asymptotes on any tangent to an hyperbola is bisected by the point of contact.

The first part allows a simple solution of the problem to find any number of points on an hyperbola, of which the asymptotes and one point are given. This is equivalent to three points and the tangents at two of them. This construction requires measurement.

§ 74. For the parabola, too, follow some metrical properties. A diameter PM (fig. 27) bisects every chord conjugate to it, and the pole P of such a chord BC lies on the diameter. But a diameter cuts the parabola once at infinity. Hence—

The segment PM which joins the middle point M of a chord of a parabola to the pole P of the chord is bisected by the parabola at A.

§ 75. Two asymptotes and any two tangents to an hyperbola may be considered as a quadrilateral circumscribed about the

hyperbola. But in such a quadrilateral the intersections of the diagonals and the points of contact of opposite sides lie in a line (§ 54). If therefore DEFG (fig. 28) is such a quadrilateral, then the diagonals DF and GE will meet on the line which joins the points of contact of the asymptotes, that is, on the line at infinity; hence they are parallel. From this the following theorem is a simple deduction:

All triangles formed by a tangent and the asymptotes of an hyperbola are equal in area.

If we draw at a point P (fig. 28) on an hyperbola a tangent, the part HK between the asymptotes is bisected at P. The parallelogram PQOQ' formed by the asymptotes and lines parallel to them through P will be half the triangle OHK, and will therefore be constant. If we now take the asymptotes OX and OY as oblique

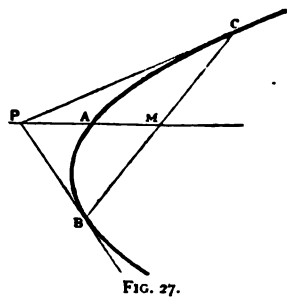

FIG. 27.

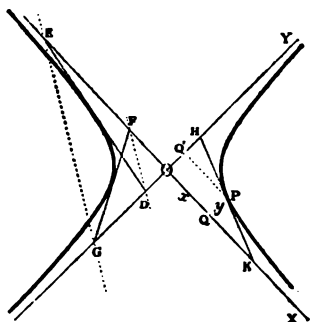

FIG. 28.

axes of co-ordinates, the lines OQ and QP will be the co-ordinates of P, and will satisfy the equation $xy = \text{const.} = a^2$.
For the asymptotes as axes of co-ordinates the equation of the hyperbola is $xy = \text{const.}$

INVOLUTION

§ 76. If we have two projective rows, ABC on w and $A'B'C'$ on w' , and place their bases on the same line, then each point in this line counts twice, once as a point in the row w and once as a point in the row w' . In fig. 29 we denote the points as points in the one row by letters above the line A, B, C, ... and as points in the second row by A', B', C', \dots below the line. Let now A and B' be the same point, then to A will correspond a point A' in the second, and to B' a point B in the first row. In general these points A' and B will be different. It may, however, happen that they coincide. Then the correspondence is a peculiar one, as the following theorem shows:

If two projective rows lie on the same base, and if it happens that to one point in the base the same point corresponds, whether we consider the point as belonging to the first or to the second row, then the same will happen for every point in the base—that is to say, to every point in the line corresponds the same point in the first as in the second row.

In order to determine the correspondence, we may assume three pairs of corresponding points in two projective rows. Let then A', B', C' , in fig. 30, correspond to A, B, C, so that A and B' , and also B and A' , denote the same point. Let us further denote the point C' when considered as a point in the first row by D; then it is to

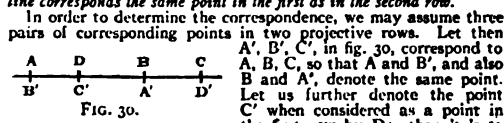

FIG. 30.

be proved that the point D' , which corresponds to D, is the same point as C. We know that the cross-ratio of four points is equal to that of the corresponding row. Hence

$$(AB, CD) = (A'B', C'D')$$

but replacing the dashed letters by those undashed ones which denote the same points, the second cross-ratio equals (BA, DD') ,

which, according to § 15, equals $(AB, D'D)$; so that the equation becomes

$$(AB, CD) = (AB, D'D).$$

This requires that C and D' coincide.
§ 77. Two projective rows on the same base, which have the above property, that to every point, whether it be considered as a point in the one or in the other row, corresponds the same point, are said to be in *involution*, or to form an *involution* of points on the line.

We mention, but without proving it, that any two projective rows may be placed so as to form an involution.

An involution may be said to consist of a row of pairs of points, to every point A corresponding a point A' , and to A' again the point A. These points are said to be *conjugate*, or, better, *one pair* is termed the "mate" of the other.

From the definition, according to which an involution may be considered as made up of two projective rows, follow at once the following important properties:

1. The cross-ratio of four points equals that of the four conjugate points.
2. If we call a point which coincides with its mate a "focus" or "double point" of the involution, we may say: An involution has either two foci, or one, or none, and is called respectively a hyperbolic, parabolic or elliptic involution (§ 34).
3. In a hyperbolic involution any two conjugate points are harmonic conjugates with regard to the two foci.
For if A, A' be two conjugate points, F_1, F_2 the two foci, then to the points F_1, F_2, A, A' in the one row correspond the points F_1, F_2, A', A in the other, each focus corresponding to itself. Hence $(F_1 F_2, AA') = (F_1 F_2, A'A)$ —that is, we may interchange the two points AA' without altering the value of the cross-ratio, which is the characteristic property of harmonic conjugates (§ 18).
4. The point conjugate to the point at infinity is called the "centre" of the involution. Every involution has a centre, unless the point at infinity be a focus, in which case we may say that the centre is at infinity.
In an hyperbolic involution the centre is the middle point between the foci.
5. The product of the distances of two conjugate points A, A' from the centre O is constant: $OA \cdot OA' = c$.

For let A, A' and B, B' be two pairs of conjugate points, O the centre, I the point at infinity, then

$$(AB, OI) = (A'B', IO),$$

or $OA \cdot OA' = OB \cdot OB'$.

In order to determine the distances of the foci from the centre, we write F for A and A' and get

$$OF^2 = c; \quad OF = \pm \sqrt{c}.$$

Hence if c is positive OF is real, and has two values, equal and opposite. The involution is hyperbolic.

If $c = 0$, $OF = 0$, and the two foci both coincide with the centre. If c is negative, \sqrt{c} becomes imaginary, and there are no foci. Hence we may write—

- In an hyperbolic involution, $OA \cdot OA' = k^2$,
- In a parabolic involution, $OA \cdot OA' = 0$,
- In an elliptic involution, $OA \cdot OA' = -k^2$.

From these expressions it follows that conjugate points A, A' in a hyperbolic involution lie on the same side of the centre, and in an elliptic involution on opposite sides of the centre, and that in a parabolic involution one coincides with the centre.

In the first case, for instance, $OA \cdot OA'$ is positive; hence OA and OA' have the same sign.

It also follows that two segments, AA' and BB' , between pairs of conjugate points have the following positions: in an hyperbolic involution they lie either one altogether within or altogether without each other; in a parabolic involution they have one point in common; and in an elliptic involution they overlap, each being partly within and partly without the other.

Proof.—We have $OA \cdot OA' = OB \cdot OB' = k^2$ in case of a hyperbolic involution. Let A and B be the points in each pair which are nearer to the centre O. If now A, A' and B, B' lie on the same side of O, and if B is nearer to O than A, so that $OB < OA$, then $OB' > OA'$; hence B' lies farther away from O than A' , or the segment AA' lies within BB' . And so on for the other cases.

6. An involution is determined—
 - (a) By two pairs of conjugate points. Hence also
 - (b) By one pair of conjugate points and the centre;
 - (c) By the two foci;
 - (d) By one focus and one pair of conjugate points;
 - (e) By one focus and the centre.

7. The condition that A, B, C and A', B', C' may form an involution may be written in one of the forms—

$$(AB, CC') = (A'B', C'C'),$$

$$(AB, CA') = (A'B', C'A'),$$

$$(AB, C'A') = (A'B', CA),$$

for each expresses that in the two projective rows in which A, B, C

and A', B', C' are conjugate points two conjugate elements may be interchanged.

8. Any three pairs, A, A', B, B', C, C' , of conjugate points are connected by the relations:

$$AB \cdot BC' \cdot CA' = AB' \cdot BC \cdot CA' = AB \cdot B'C \cdot CA' = AB \cdot B'C \cdot CA' = -1.$$

$A'B \cdot B'C \cdot CA' = A'B' \cdot B'C \cdot CA' = A'B \cdot B'C \cdot CA' = A'B' \cdot B'C \cdot CA' = -1.$

These relations readily follow by working out the relations in (7) (above).

§ 78. *Involution of a quadrangle.*—The sides of any four-point are cut by any line in six points in involution, opposite sides being cut in conjugate points.

Let $A_1B_1C_1D_1$ (fig. 31) be the four-point. If its sides be cut by the line p in the points A, A', B, B', C, C' ; if further, C_1D_1 cuts the line A_1B_1 in C_2 , and if we project the row $A_1B_1C_2C_1$ to p once from D_1 , and once from C_1 , we get $(A'B', C'C) = (BA, C'C)$.

Interchanging in the last cross-ratio the letters in each pair we get $(A'B', C'C) = (AB, CC')$. Hence by § 77 (7) the points are in involution.

The theorem may also be stated thus:
The three points in which any line cuts the sides of a triangle and the projections, from any point in the plane, of the vertices of the triangle on to the same line are six points in involution.

Or again—
The projections from any point on to any line of the six vertices

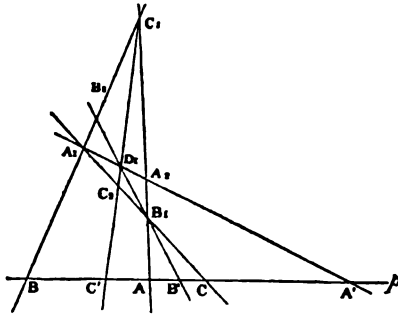

FIG. 31.

of a four-side are six points in involution, the projections of opposite vertices being conjugate points.

This property gives a simple means to construct, by aid of the straight edge only, in an involution of which two pairs of conjugate points are given, to any point its conjugate.

§ 79. *Pencils in Involution.*—The theory of involution may at once be extended from the row to the flat and the axial pencil—viz. we say that there is an involution in a flat or in an axial pencil if any line cuts the pencil in an involution of points. An involution in a pencil consists of pairs of conjugate rays or planes; it has two, one or no focal rays (double lines) or planes, but nothing corresponding to a centre.

An involution in a flat pencil contains always one, and in general only one, pair of conjugate rays which are perpendicular to one another. For in two projective flat pencils exist always two corresponding right angles (§ 40).

Each involution in an axial pencil contains in the same manner one pair of conjugate planes at right angles to one another.

As a rule, there exists but one pair of conjugate lines or planes at right angles to each other. But it is possible that there are more, and then there is an infinite number of such pairs. An involution in a flat pencil, in which every ray is perpendicular to its conjugate ray, is said to be *circular*. That such involution is possible is easily seen thus: if in two concentric flat pencils each ray on one is made to correspond to that ray on the other which is perpendicular to it, then the two pencils are projective, for if we turn the one pencil through a right angle each ray in one coincides with its corresponding ray in the other. But these two projective pencils are in involution.

A circular involution has no focal rays, because no ray in a pencil coincides with the ray perpendicular to it.

§ 80. *Every elliptical involution in a row may be considered as a section of a circular involution.*

In an elliptical involution any two segments AA' and BB' lie partly within and partly without each other (fig. 32). Hence two circles described on AA' and BB' as diameters will intersect in two points E and E' . The line EE' cuts the base of the involution at a point O , which has the property that $OA \cdot OA' = OB \cdot OB'$, for each is equal to $OE \cdot OE'$. The point O is therefore the centre of the involution. If we wish to construct to any point C the conjugate point C' , we may draw the circle through CEE' . This will cut the

base in the required point C' for $OC \cdot OC' = OA \cdot OA'$. But EC and EC' are at right angles. Hence the involution which is obtained by joining E or E' to the points in the given involution is circular. This may also be expressed thus:

Every elliptical involution has the property that there are two definite points in the plane from which any two conjugate points are seen under a right angle.

At the same time the following problem has been solved:

To determine the centre and also the point corresponding to any given point in an elliptical involution of which two pairs of conjugate points are given.

§ 81. *Involution Range on a Conic.*—By the aid of § 53, the points on a conic may be made to correspond to those on a line, so that the row of points on the conic is projective to a row of points on a line. And these may have two projective rows on the same conic, and these will be in involution as soon as one point on the conic has the same point corresponding to it all the same to whatever row it belongs. An involution of points on a conic will have the property (as follows from its definition, and from § 53) that the lines which join conjugate points of the involution to any point on the conic are conjugate lines of an involution in a pencil, and that a fixed tangent is cut by the tangents at conjugate points on the conic in points which are again conjugate points of an involution on the fixed tangent. For such involution on a conic the following theorem holds:

The lines which join corresponding points in an involution on a conic all pass through a fixed point; and reciprocally, the points of intersection of conjugate lines in an involution among tangents to a conic lie on a line.

We prove the first part only. The involution is determined by two pairs of conjugate points, say by A, A' and B, B' (fig. 33). Let

AA' and BB' meet in P . If we join the points in involution to any point on the conic, and the conjugate points to another point on the conic, we obtain two projective pencils. We take A and A' as centres of these pencils, so that the pencils $A(A'B'B)$ and $A'(A'B'B)$ are projective, and in perspective position, because AA' corresponds to $A'A$. Hence corresponding rays meet in a line, of which two points are found by joining AB' to $A'B$ and AB to $A'B'$. It follows that the axis of perspective is the polar of the point P , where AA' and BB' meet. If we now wish to construct to any other point C on the conic the corresponding point C' , we join C to A' and the point where this line cuts p to A . The latter line cuts the conic again in C' . But we know from the theory of pole and polar that the line CC' passes through P . The point of concurrence is called the "pole of the involution," and the line of collinearity of the meets is called the "axis of the involution."

INVOLUTION DETERMINED BY A CONIC ON A LINE.—FOCI

§ 82. The polars, with regard to a conic, of points in a row p form a pencil P projective to the row (§ 66). This pencil cuts the base of the row p in a projective row.

If A is a point in the given row, A' the point where the polar of A cuts p , then A and A' will be corresponding points. If we take A' a point in the first row, then the polar of A' will pass through A , so that A corresponds to A' —in other words, the rows are in involution. The conjugate points in this involution are conjugate points with regard to the conic. Conjugate points coincide only if the polar of a point A passes through A —that is, if A lies on the conic. Hence—

A conic determines on every line in its plane an involution, in which those points are conjugate which are also conjugate with regard to the conic.

If the line cuts the conic the involution is hyperbolic, the points of intersection being the foci.

If the line touches the conic the involution is parabolic, the two foci coinciding at the point of contact.

If the line does not cut the conic the involution is elliptic, having no foci.

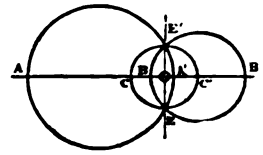

FIG. 32.

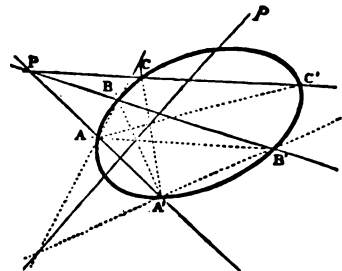

FIG. 33.

If, on the other hand, we take a point P in the plane of a conic, we get to each line a through P one conjugate line which joins P to the pole of a . These pairs of conjugate lines through P form an involution in the pencil at P . The focal rays of this involution are the tangents drawn from P to the conic. This gives the theorem reciprocal to the last, viz:—

A conic determines in every pencil in its plane an involution, corresponding lines being conjugate lines with regard to the conic.

If the point is without the conic the involution is hyperbolic, the tangents from the points being the focal rays.

If the point lies on the conic the involution is parabolic, the tangent at the point counting for coincident focal rays.

If the point is within the conic the involution is elliptic, having no focal rays.

It will further be seen that the involution determined by a conic on any line p is a section of the involution, which is determined by the conic at the pole P of p .

§ 83. *Foci.*—The centre of a pencil in which the conic determines a circular involution is called a "focus" of the conic.

In other words, a focus is such a point that every line through it is perpendicular to its conjugate line. The polar to a focus is called a *directrix* of the conic.

From the definition it follows that every focus lies on an axis, for the line joining a focus to the centre of the conic is a diameter to which the conjugate lines are perpendicular; and every line joining two foci is an axis, for the perpendiculars to this line through the foci are conjugate to it. These conjugate lines pass through the pole of the line, the pole lies therefore at infinity, and the line is a diameter, hence by the last property an axis.

It follows that all foci lie on one axis, for no line joining a point in one axis to a point in the other can be an axis.

As the conic determines in the pencil which has its centre at a focus a circular involution, no tangents can be drawn from the focus to the conic. Hence each focus lies within a conic; and a directrix does not cut the conic.

Further properties are found by the following considerations:

§ 84. Through a point P one line p can be drawn, which is with regard to a given conic conjugate to a given line q , viz. that line which joins the point P to the pole of the line q . If the line q is made to describe a pencil about a point Q , then the line p will describe a pencil about P . These two pencils will be projective, for the line p passes through the pole of q , and whilst q describes the pencil Q , its pole describes a projective row, and this row is perspective to the pencil P .

We now take the point P on an axis of the conic, draw any line p through it, and from the pole of p draw a perpendicular q to p . Let q cut the axis in Q . Then, in the pencils of conjugate lines, which have their centres at P and Q , the lines p and q are conjugate lines at right angles to one another. Besides, to the axis as a ray in either pencil will correspond in the other the perpendicular to the axis (§ 72). The conic generated by the intersection of corresponding lines in the two pencils is therefore the circle on PQ as diameter, so that every line in P is perpendicular to its corresponding line in Q .

To every point P on an axis of a conic corresponds thus a point Q , such that conjugate lines through P and Q are perpendicular.

We shall show that these point-pairs P, Q form an involution. To do this let us move P along the axis, and with it the line p , keeping the latter parallel to itself. Then P describes a row, p a perspective pencil (of parallels), and the pole of p a projective row. At the same time the line q describes a pencil of parallels perpendicular to p , and perspective to the row formed by the pole of p . The point Q , therefore, where q cuts the axis, describes a row projective to the row of points P . The two points P and Q describe thus two projective rows on the axis; and not only does P as a point in the first row correspond to Q , but also Q as a point in the first corresponds to P . The two rows therefore form an involution. The centre of this involution, it is easily seen, is the centre of the conic.

A focus of this involution has the property that any two conjugate lines through it are perpendicular; hence, it is a focus of the conic.

Such an involution exists on each axis. But only one of these can have foci, because all foci lie on the same axis. The involution on one of the axes is elliptic, and appears (§ 80) therefore as the section of two circular involutions in two pencils whose centres lie in the other axis. These centres are foci, hence the one axis contains two foci, the other axis none; or every central conic has two foci which lie on one axis equidistant from the centre.

The axis which contains the foci is called the *principal axis*; in case of an hyperbola it is the axis which cuts the curve, because the foci lie within the conic.

In case of the parabola there is but one axis. The involution on this axis has its centre at infinity. One focus is therefore at infinity, the one focus only is finite. A parabola has only one focus.

§ 85. If through any point P (fig. 34) on a conic the tangent PT and the normal PN (i.e. the perpendicular to the tangent through the point of contact) be drawn, these will be conjugate lines with regard to the conic, and at right angles to each other. They will therefore cut the principal axis in two points, which are conjugate in the involution considered in § 84; hence they are harmonic

conjugates with regard to the foci. If therefore the two foci F_1 and F_2 be joined to P , these lines will be harmonic with regard to the

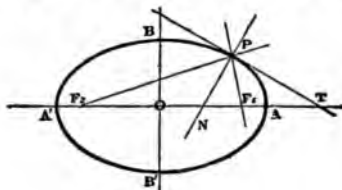

FIG. 34.

tangent and normal. As the latter are perpendicular, they will bisect the angles between the other pair. Hence—

The lines joining any point on a conic to the two foci are equally inclined to the tangent and normal at that point.

In case of the parabola this becomes—

The line joining any point on a parabola to the focus and the diameter through the point, are equally inclined to the tangent and normal at that point.

From the definition of a focus it follows that—

The segment of a tangent between the directrix and the point of contact is seen from the focus belonging to the directrix under a right angle, because the lines joining the focus to the ends of this segment are conjugate with regard to the conic, and therefore perpendicular.

With equal ease the following theorem is proved:

The two lines which join the points of contact of two tangents each to one focus, but not both to the same, are seen from the intersection of the tangents under equal angles.

§ 86. Other focal properties of a conic are obtained by the following considerations:

Let F (fig. 35) be a focus of a conic, f the corresponding directrix, A and B the points of contact of two tangents meeting at T , and P the point where the line AB cuts the directrix. Then TF will be the polar of P (because polars of F and T meet at P). Hence TF and PF are conjugate lines through a focus, and therefore perpendicular. They are further harmonic conjugates with regard to FA and FB (§§ 64 and 13), so that they bisect the angles formed by these lines. This is by the way proved—

The segments between the point of intersection of two tangents to a conic and their points of contact are seen from a focus under equal angles.

If we next draw through A and B lines parallel to TF , then the points A_1, B_1 where these cut the directrix will be harmonic conjugates with regard to P and the point where TF cuts the directrix. The lines FT and FP bisect therefore also the angles between FA_1 and FB_1 . From this it follows easily that the triangles FAA_1 and FBB_1 are equiangular, and therefore similar, so that $FA : AA_1 = FB : BB_1$.

The triangles AA_1A_2 and BB_1B_2 formed by drawing perpendiculars from A and B to the directrix are also similar, so that $AA_1 : AA_2 = BB_1 : BB_2$. This, combined with the above proportion, gives $FA : AA_2 = FB : BB_2$. Hence the theorem:

The ratio of the distances of any point on a conic from a focus and the corresponding directrix is constant.

To determine this ratio we consider its value for a vertex on the principal axis. In an ellipse the focus lies between the two vertices on this axis, hence the focus is nearer to a vertex than to the corresponding directrix. Similarly, in an hyperbola a vertex is nearer

FIG. 35.

to the focus than to the corresponding directrix. Similarly, in an hyperbola a vertex is nearer

to the focus than to the corresponding directrix. Similarly, in an hyperbola a vertex is nearer

to the focus than to the corresponding directrix. Similarly, in an hyperbola a vertex is nearer

to the directrix than to the focus. In a parabola the vertex lies halfway between directrix and focus.

It follows in an ellipse the ratio between the distance of a point from the focus to that from the directrix is less than unity, in the parabola it equals unity, and in the hyperbola it is greater than unity.

It is here the same which focus we take, because the two foci lie symmetrical to the axis of the conic. If now P is any point on the conic having the distances r_1 and r_2 from the foci and the distances d_1 and d_2 from the corresponding directrices, then $r_1/d_1 = r_2/d_2 = e$, where e is constant. Hence also $\frac{r_1 + r_2}{d_1 + d_2} = e$.

In the ellipse, which lies between the directrices, $d_1 + d_2$ is constant, therefore also $r_1 + r_2$. In the hyperbola on the other hand $d_1 - d_2$ is constant, equal to the distance between the directrices, therefore in this case $r_1 - r_2$ is constant.

If we call the distances of a point on a conic from the focus its focal distances we have the theorem:

In an ellipse the sum of the focal distances is constant; and in an hyperbola the difference of the focal distances is constant.

This constant sum or difference equals in both cases the length of the principal axis.

PENCIL OF CONICS

§ 87. Through four points A, B, C, D in a plane, of which no three lie in a line, an infinite number of conics may be drawn, viz. through these four points and any fifth one single conic. This system of conics is called a pencil of conics. Similarly, all conics touching four fixed lines form a system such that any fifth tangent determines one and only one conic. We have here the theorems:

The pairs of points in which any line is cut by a system of conics through four fixed points are in involution. The pairs of tangents which can be drawn from a point to a system of conics touching four fixed lines are in involution.

We prove the first theorem only. Let ABCD (fig. 36) be the four-point, then any line l will cut two opposite sides AC, BD in

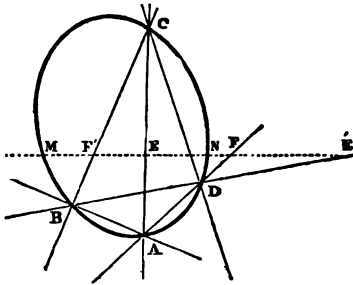

FIG. 36.

the points E, E', the pair AD, BC in points F, F', and any conic of the system in M, N, and we have $A(CD, MN) = B(CD, MN)$

If we cut these pencils by l we get
 $(EF, MN) = (F'E', MN)$
 $(EF, MN) = (E'F', NM)$

or
 But this is, according to § 77 (7), the condition that M, N are corresponding points in the involution determined by the point pairs E, E', F, F' in which the line l cuts pairs of opposite sides of the four-point ABCD. This involution is independent of the particular conic chosen.

§ 88. There follow several important theorems:
 Through four points two, one, or no conics may be drawn which touch any given line, according as the involution determined by the given four-point on the line has real, coincident or imaginary foci.

Two, one, or no conics may be drawn which touch four given lines and pass through a given point, according as the involution determined by the given four-side at the point has real, coincident or imaginary focal rays.

For the conic through four points which touches a given line has its point of contact at a focus of the involution determined by the four-point on the line.

As a special case we get, by taking the line at infinity:
 Through four points of which none is at infinity either two or no parabolas may be drawn.

The problem of drawing a conic through four points and touching a given line is solved by determining the points of contact on the line, that is, by determining the foci of the involution in which the line cuts the sides of the four-point. The corresponding remark holds for the problem of drawing the conics which touch four lines and pass through a given point.

RULED QUADRIC SURFACES

§ 89. We have considered hitherto projective rows which lie in the same plane, in which case lines joining corresponding points envelop a conic. We shall now consider projective rows whose bases do not meet. In this case, corresponding points will be joined by lines which do not lie in a plane, but on some surface, which like every surface generated by lines is called a ruled surface. This surface clearly contains the bases of the two rows.

If the points in either row be joined to the base of the other, we obtain two axial pencils which are also projective, those planes being corresponding which pass through corresponding points in the given rows. If A', A be two corresponding points, α, α' the planes in the axial pencils passing through them, then AA' will be the line of intersection of the corresponding planes α, α' and also the line joining corresponding points in the rows.

If we cut the whole figure by a plane this will cut the axial pencils in two projective flat pencils, and the curve of the second order generated by these will be the curve in which the plane cuts the surface. Hence

The locus of lines joining corresponding points in two projective rows which do not lie in the same plane is a surface which contains the bases of the rows, and which can also be generated by the lines of intersection of corresponding planes in two projective axial pencils. This surface is cut by every plane in a curve of the second order, hence either in a conic or in a line-pair. No line which does not lie altogether on the surface can have more than two points in common with the surface, which is therefore said to be of the second order or is called a ruled quadric surface.

That no line which does not lie on the surface can cut the surface in more than two points is seen at once if a plane be drawn through the line, for this will cut the surface in a conic. It follows also that a line which contains more than two points of the surface lies altogether on the surface.

§ 90. Through any point in space one line can always be drawn cutting two given lines which do not themselves meet.

If therefore three lines in space be given of which no two meet, then through every point in either one line may be drawn cutting the other two.

If a line moves so that it always cuts three given lines of which no two meet, then it generates a ruled quadric surface.

Let a, b, c be the given lines, and p, q, r, \dots lines cutting them in the points A, A', A'', ...; B, B', B'', ...; C, C', C'', ... respectively; then the planes through a containing p, q, r , and the planes through b containing the same lines, may be taken as corresponding planes in two axial pencils which are projective, because both pencils cut the line c in the same row, C, C', C'', ...; the surface can therefore be generated by projective axial pencils.

Of the lines p, q, r, \dots no two can meet, for otherwise the lines a, b, c which cut them would also lie in their plane. There is a single infinite number of them, for one passes through each point of a . These lines are said to form a set of lines on the surface.

If now three of the lines p, q, r be taken, then every line d cutting them will have three points in common with the surface, and will therefore lie altogether on it. This gives rise to a second set of lines on the surface. From what has been said the theorem follows:

A ruled quadric surface contains two sets of straight lines. Every line of one set cuts every line of the other, but no two lines of the same set meet.

Any two lines of the same set may be taken as bases of two projective rows, or of two projective pencils which generate the surface. They are cut by the lines of the other set in two projection rows.

The plane at infinity like every other plane cuts the surface either in a conic proper or in a line-pair. In the first case the surface is called an *Hyperboloid of one sheet*, in the second an *Hyperbolic Paraboloid*.

The latter may be generated by a line cutting three lines of which one lies at infinity, that is, cutting two lines and remaining parallel to a given plane.

QUADRIC SURFACES

§ 91. The conics, the cones of the second order, and the ruled quadric surfaces complete the figures which can be generated by projective rows or flat and axial pencils, that is, by those aggregates of elements which are of one dimension (§§ 5, 6). We shall now consider the simpler figures which are generated by aggregates of two dimensions. The space at our disposal will not, however, allow us to do more than indicate a few of the results.

§ 92. We establish a correspondence between the lines and planes in pencils in space, or reciprocally between the points and lines in two or more planes, but consider principally pencils.

In two pencils we may either make planes correspond to planes and lines to lines, or else planes to lines and lines to planes. If hereby the condition be satisfied that to a flat, or axial, pencil corresponds in the first case a projective flat, or axial, pencil, and in the second a projective axial, or flat, pencil, the pencils are said to be projective in the first case and reciprocal in the second.

For instance, two pencils which join two points S_1 and S_2 to the different points and lines in a given plane π are projective (and in perspective position), if those lines and planes be taken as

corresponding which meet the plane τ in the same point or in the same line. In this case every plane through both centres S_1 and S_2 of the two pencils will correspond to itself. If these pencils are brought into any other position they will be projective (but not perspective).

The correspondence between two projective pencils is uniquely determined, if to four rays (or planes) in the one the corresponding rays (or planes) in the other are given, provided that no three rays of either set lie in a plane.

Let a, b, c, d be four rays in the one, a', b', c', d' the corresponding rays in the other pencil. We shall show that we can find for every ray a in the first a single corresponding ray a' in the second. To the axial pencil $a (b, c, d \dots)$ formed by the planes which join a to $b, c, d \dots$, respectively corresponds the axial pencil $a' (b', c', d' \dots)$, and this correspondence is determined. Hence, the plane $a' a'$ which corresponds to the plane aa is determined. Similarly the plane $b'a'$ may be found and both together determine the ray a' .

Similarly the correspondence between two reciprocal pencils is determined if for four rays in the one the corresponding planes in the other are given.

§ 93. We may now combine—

1. Two reciprocal pencils.

Each ray cuts its corresponding plane in a point, the locus of these points is a quadric surface.

2. Two projective pencils.

Each plane cuts its corresponding plane in a line, but a ray as a rule does not cut its corresponding ray. The locus of points where a ray cuts its corresponding ray is a twisted cubic. The lines where a plane cuts its corresponding plane are secants.

3. Three projective pencils.

The locus of intersection of corresponding planes is a cubic surface.

Of these we consider only the first two cases.

§ 94. If two pencils are reciprocal, then to a plane in either corresponds a line in the other, to a flat pencil an axial pencil, and so on. Every line cuts its corresponding plane in a point. If S_1 and S_2 be the centres of the two pencils, and P be a point where a line a_1 in the first cuts its corresponding plane a_2 , then the line b_1 in the pencil S_2 which passes through P will meet its corresponding plane β_1 in P . For β_1 is a line in the plane a_2 . The corresponding plane β_2 must therefore pass through the line a_1 , hence through P .

The points in which the lines in S_1 cut the planes corresponding to them in S_2 are therefore the same as the points in which the lines in S_2 cut the planes corresponding to them in S_1 .

The locus of these points is a surface which is cut by a plane in a conic or in a line-pair and by a line in not more than two points unless it lies altogether on the surface. The surface itself is therefore called a quadric surface, or a surface of the second order.

To prove this we consider any line p in space.

The flat pencil in S_1 which lies in the plane drawn through p and the corresponding axial pencil in S_2 determine on p two projective rows, and those points in these which coincide with their corresponding points lie on the surface. But there exist only two, or one, or no such points, unless every point coincides with its corresponding point. In the latter case the line lies altogether on the surface.

This proves also that a plane cuts the surface in a curve of the second order, as no line can have more than two points in common with it. To show that this is a curve of the same kind as those considered before, we have to show that it can be generated by projective flat pencils. We prove first that this is true for any plane through the centre of one of the pencils, and afterwards that every point on the surface may be taken as the centre of such pencil. Let then a_1 be a plane through S_1 . To the flat pencil in S_1 which it contains corresponds in S_2 a projective axial pencil with axis a_2 and this cuts a_1 in a second flat pencil. These two flat pencils in a_1 are projective, and, in general, neither concentric nor perspective. They generate therefore a conic. But if the line a_1 passes through S_1 the pencils will have S_1 as common centre, and may therefore have two, or one, or no lines united with their corresponding lines. The section of the surface by the plane a_1 will be accordingly a line-pair or a single line, or else the plane a_1 will have only the point S_1 in common with the surface.

Every line l_1 through S_1 cuts the surface in two points, viz. first in S_1 and then at the point where it cuts its corresponding plane. If now the corresponding plane passes through S_1 , as in the case just considered, then the two points where l_1 cuts the surface coincide at S_1 , and the line is called a tangent to the surface with S_1 as point of contact. Hence if l_1 be a tangent, it lies in that plane τ_1 which corresponds to the line S_2S_1 as a line in the pencil S_1 . The section of this plane has just been considered. It follows that—

All tangents to quadric surface at the centre of one of the reciprocal pencils lie in a plane which is called the tangent plane to the surface at that point as point of contact.

To the line joining the centres of the two pencils as a line in one corresponds in the other the tangent plane at its centre.

The tangent plane to a quadric surface either cuts the surface in two lines, or it has only a single line, or else only a single point in common with the surface.

In the first case the point of contact is said to be hyperbolic, in the second parabolic, in the third elliptic.

§ 95. It remains to be proved that every point S on the surface may be taken as centre of one of the pencils which generate the surface. Let S be any point on the surface Φ' generated by the reciprocal pencils S_1 and S_2 . We have to establish a reciprocal correspondence between the pencils S_1 and S_2 , so that the surface generated by them is identical with Φ . To do this we draw two planes a_1 and β_1 through S , cutting the surface Φ in two conics which we also denote by a_1 and β_1 . These conics meet at S , and at some other point T where the line of intersection of a_1 and β_1 cuts the surface.

In the pencil S we draw some plane σ which passes through T , but not through S_1 or S_2 . It will cut the two conics first at T , and therefore each at some other point which we call A and B respectively. These we join to S by lines a and b , and now establish the required correspondence between the pencils S_1 and S_2 as follows:—To S_1T shall correspond the plane σ , to the plane a_1 the line a , and to β_1 the line b , hence to the flat pencil in a_1 the axial pencil a . These pencils are made projective by aid of the conic in a_1 .

In the same manner the flat pencil in β_1 is made projective to the axial pencil b by aid of the conic in β_1 , corresponding elements being those which meet on the conic. This determines the correspondence, for we know for more than four rays in S_1 the corresponding planes in S_2 . The two pencils S and S_1 thus made reciprocal generate a quadric surface Φ , which passes through the point S and through the two conics a_1 and β_1 .

The two surfaces Φ and Φ' have therefore the points S and S_2 and the conics a_1 and β_1 in common. To show that they are identical, we draw a plane through S and S_2 , cutting each of the conics a_1 and β_1 in two points, which will always be possible. This plane cuts Φ and Φ' in two conics which have the point S and the points where it cuts a_1 and β_1 in common, that is five points in all. The conics therefore coincide.

This proves that all those points P on Φ' lie on Φ which have the property that the plane SS_1P cuts the conics a_1, β_1 in two points each. If the plane SS_1P has not this property, then we draw a plane SS_2P . This cuts each surface in a conic, and these conics have in common the points S, S_2 , one point on each of the conics a_1, β_1 , and one point on one of the conics through S and S_2 which lie on both surfaces, hence five points. They are therefore coincident, and our theorem is proved.

§ 96. The following propositions follow:—

A quadric surface has at every point a tangent plane.

Every plane section of a quadric surface is a conic or a line-pair.

Every line which has three points in common with a quadric surface lies on the surface.

Every conic which has five points in common with a quadric surface lies on the surface.

Through two conics which lie in different planes, but have two points in common, and through one external point always one quadric surface may be drawn.

§ 97. Every plane which cuts a quadric surface in a line-pair is a tangent plane. For every line in this plane through the centre of the line-pair (the point of intersection of the two lines) cuts the surface in two coincident points and is therefore a tangent to the surface, the centre of the line-pair being the point of contact.

If a quadric surface contains a line, then every plane through this line cuts the surface in a line-pair (or in two coincident lines). For this plane cannot cut the surface in a conic. Hence

If a quadric surface contains one line p then it contains an infinite number of lines, and through every point Q on the surface, one line q can be drawn which cuts p . For the plane through the point Q and the line p cuts the surface in a line-pair which must pass through Q and of which p is one line.

No two such lines q on the surface can meet. For as both meet p their plane would contain p and therefore cut the surface in a triangle.

Every line which cuts three lines q will be on the surface; for it has three points in common with it.

Hence the quadric surfaces which contain lines are the same as the ruled quadric surfaces considered in §§ 89-93, but with one important exception. In the last investigation we have left out of consideration the possibility of a plane having only one line (two coincident lines) in common with a quadric surface.

§ 98. To investigate this case we suppose first that there is one point A on the surface through which two different lines a, b can be drawn, which lie altogether on the surface.

If P is any other point on the surface which lies neither on a nor b , then the plane through P and A will cut the surface in a second line a' which passes through P and which cuts a . Similarly there is a line b' through P which cuts b . These two lines a' and b' may coincide, but then they must coincide with PA .

If this happens for one point P , it happens for every other point Q . For if two different lines could be drawn through Q , then by the same reasoning the line PQ would be altogether on the surface, hence two lines would be drawn through P against the assumption. From this follows:—

If there is one point on a quadric surface through which one, but only one, line can be drawn on the surface, then through every point one line

can be drawn, and all these lines meet in a point. The surface is a cone of the second order.

If through one point on a quadric surface, two, and only two, lines can be drawn on the surface, then through every point two lines may be drawn, and the surface is a ruled quadric surface.

If through one point on a quadric surface no line on the surface can be drawn, then the surface contains no lines.

Using the definitions at the end of § 95, we may also say—

On a quadric surface the points are all hyperbolic, or all parabolic, or all elliptic.

As an example of a quadric surface with elliptical points, we mention the sphere which may be generated by two reciprocal pencils, where to each line in one corresponds the plane perpendicular to it in the other.

§ 99. *Poles and Polar Planes.*—The theory of poles and polars with regard to a conic is easily extended to quadric surfaces.

Let P be a point in space not on the surface, which we suppose not to be a cone. On every line through P which cuts the surface in two points we determine the harmonic conjugate Q of P with regard to the points of intersection. Through one of these lines we draw two planes α and β . The locus of the points Q in α is a line a , the polar of P with regard to the conic in which α cuts the surface. Similarly the locus of points Q in β is a line b . This cuts a , because the line of intersection of α and β contains but one point Q . The locus of all points Q therefore is a plane. This plane is called the polar plane of the point P , with regard to the quadric surface. If P lies on the surface we take the tangent plane of P as its polar.

The following propositions hold:—

1. Every point has a polar plane, which is constructed by drawing the polars of the point with regard to the conics in which two planes through the point cut the surface.

2. If Q is a point in the polar of P , then P is a point in the polar of Q , because this is true with regard to the conic in which a plane through PQ cuts the surface.

3. Every line is the polar plane of one point, which is called the Pole of the plane.

The pole to a plane is found by constructing the polar planes of three points in the plane. Their intersection will be the pole.

4. The points in which the polar plane of P cuts the surface are points of contact of tangents drawn from P to the surface, as is easily seen. Hence—

5. The tangents drawn from a point P to a quadric surface form a cone of the second order, for the polar plane of P cuts it in a conic.

6. If the pole describes a line a , its polar plane will turn about another line a' , as follows from 2. These lines a and a' are said to be conjugate with regard to the surface.

§ 100. The pole of the line at infinity is called the centre of the surface. If it lies at the infinity, the plane at infinity is a tangent plane, and the surface is called a paraboloid.

The polar plane to any point at infinity passes through the centre, and is called a diametrical plane.

A line through the centre is called a diameter. It is bisected at the centre. The line conjugate to it lies at infinity.

If a point moves along a diameter its polar plane turns about the conjugate line at infinity; that is, it moves parallel to itself, its centre moving on the first line.

The middle points of parallel chords lie in a plane, viz. in the polar plane of the point at infinity through which the chords are drawn.

The centres of parallel sections lie in a diameter which is a line conjugate to the line at infinity in which the planes meet.

TWISTED CURVES

§ 101. If two pencils with centres S_1 and S_2 are made projective, then to a ray in one corresponds a ray in the other, to a plane a plane, to a flat or axial pencil a projective flat or axial pencil, and so on.

There is a double infinite number of lines in a pencil. We shall see that a single infinite number of lines in one pencil meets its corresponding ray, and that the points of intersection form a curve in space.

Of the double infinite number of planes in the pencils each will meet its corresponding plane. This gives a system of a double infinite number of lines in space. We know (§ 5) that there is a quadruple infinite number of lines in space. From among these we may select those which satisfy one or more given conditions. The systems of lines thus obtained were first systematically investigated and classified by Flückler, in his *Geometrie des Raumes*. He uses the following names:—

A *triple infinite* number of lines, that is, all lines which satisfy one condition, are said to form a *complex of lines*; e.g. all lines cutting a given line, or all lines touching a surface.

A *double infinite* number of lines, that is, all lines which satisfy two conditions, or which are common to two complexes, are said to form a *congruence of lines*; e.g. all lines in a plane, or all lines cutting two curves, or all lines cutting a given curve twice.

A *single infinite* number of lines, that is, all lines which satisfy three conditions, or which belong to three complexes, form a *ruled surface*; e.g. one set of lines on a ruled quadric surface, or developable surfaces which are formed by the tangents to a curve.

It follows that all lines in which corresponding planes in two

projective pencils meet form a congruence. We shall see this congruence consists of all lines which cut a twisted cubic twice, or of all secants to a twisted cubic.

§ 102. Let l_1 be the line S_1S_2 as a line in the pencil S_1 . To it corresponds a line h_1 in S_2 . At each of the centres two corresponding lines meet. The two axial pencils with h_1 and l_1 as axes are projective, and, as their axes meet at S_2 , the intersections of corresponding planes form a cone of the second order (§ 58), with S_2 as centre. If π_1 and π_2 be corresponding planes, then their intersection will be a line p_1 which passes through S_2 . Corresponding to it in S_1 will be a line p_2 which lies in the plane π_1 , and which therefore meets p_1 at some point P . Conversely, if p_2 be any line in S_2 which meets its corresponding line p_1 at a point P , then to the plane $h_2 p_2$ will correspond the plane $h_1 p_1$, that is, the plane S_1S_2P . These planes intersect in p_2 , so that p_2 is a line on the quadric cone generated by the axial pencils l_1 and h_1 . Hence:—

All lines in one pencil which meet their corresponding lines in the other form a cone of the second order which has its centre at the centre of the first pencil, and passes through the centre of the second.

From this follows that the points in which corresponding rays meet lie on two cones of the second order which have the ray joining their centres in common, and form therefore, together with the line S_1S_2 or h_1 , the intersection of these cones. Any plane cuts each of the cones in a conic. These two conics have necessarily that point in common in which it cuts the line h_1 , and therefore besides either one or three other points. It follows that the curve is of the third order as a plane may cut it in three, but not in more than three, points. Hence:—

The locus of points in which corresponding lines on two projective pencils meet is a curve of the third order or a "twisted cubic" k , which passes through the centres of the pencils, and which appears as the intersection of two cones of the second order, which have one line in common.

A line belonging to the congruence determined by the pencils is a secant of the cubic; it has two, or one, or no points in common with this cubic, and is called accordingly a secant proper, a tangent, or a secant improper of the cubic. A secant improper may be considered, to use the language of coordinate geometry, as a secant with imaginary points of intersection.

§ 103. If a_1 and a_2 be any two corresponding lines in the two pencils, then corresponding planes in the axial pencils having a_1 and a_2 as axes generate a ruled quadric surface. Any plane cuts each of the cubic k , and if p_1, p_2 be the corresponding rays in S_1 and S_2 which meet at P , then to the plane $a_1 p_1$ in S_1 corresponds $a_2 p_2$ in S_2 . These therefore meet in a line through P .

This may be stated thus:—

Those secants of the cubic which cut a ray a_1 , drawn through the centre S_1 of one pencil, form a ruled quadric surface which passes through both centres, and which contains the twisted cubic k . Of such surfaces an infinite number exists. Every ray through S_1 or S_2 which is not a secant determines one of them.

If, however, the rays a_1 and a_2 are secants meeting at A , then the ruled quadric surface becomes a cone of the second order, having A as centre. Or all lines of the congruence which pass through a point on the twisted cubic k form a cone of the second order. In other words, the projection of a twisted cubic from any point in the curve on to any plane is a conic.

If a_1 is not a secant, but made to pass through any point Q in space, the ruled quadric surface determined by a_1 will pass through Q , and only one. For if two such lines pass through Q , then the lines S_1Q and S_2Q will be corresponding lines; hence Q will be a point on the cubic k , and an infinite number of secants will pass through it. Hence:—

Through every point in space not on the twisted cubic one and only one secant to the cubic can be drawn.

§ 104. The fact that all the secants through a point on the cubic form a quadric cone shows that the centres of the projective pencils generating the cubic are not distinguished from any other points on the cubic. If we take any two points S, S' on the cubic, and draw the secants through each of them, we obtain two quadric cones, which have the line SS' in common, and which intersect besides along the cubic. If we make these two pencils having S and S' as centres projective by taking four rays on the one cone as corresponding to the four rays on the other which meet the first on the cubic, the correspondence is determined. These two pencils will generate a cubic, and the two cones of secants having S and S' as centres will be identical with the above cones, for each has five rays in common with one of the first, viz. the line SS' and the four lines determined for the correspondence; therefore these two cones intersect in the original cubic. This gives the theorem:—

On a twisted cubic any two points may be taken as centres of projective pencils which generate the cubic, corresponding planes being those which meet on the same secant.

Of the two projective pencils at S and S' we may keep the first fixed, and move the centre of the other along the curve. The pencils will hereby remain projective, and a plane α in S will be cut by its corresponding plane α' always in the same secant a . Whilst S' moves along the curve the plane α' will turn about a , describing an axial pencil.

AUTHORITIES.—In this article we have given a purely geometrical theory of conics, cones of the second order, quadric surfaces, &c. In doing so we have followed, to a great extent, *Reye's Geometrie der Lage*, and to this excellent work those readers are referred who wish for a more exhaustive treatment of the subject. Other works especially valuable as showing the development of the subject are: Monge, *Geometrie descriptive*; Carnot, *Geometrie de position* (1803), containing a theory of transversals; Poncelet's great work *Traité des propriétés projectives des figures* (1822); Möbius, *Barycentrischer Calcul* (1826); Steiner, *Abhängigkeit geometrischer Gestalten* (1832), containing the first full discussion of the projective relations between rows, pencils, &c.; Von Staudt, *Geometrie der Lage* (1847) and *Beiträge zur Geometrie der Lage* (1856-1860), in which a system of geometry is built up from the beginning without any reference to number, so that ultimately a number itself gets a geometrical definition, and in which imaginary elements are systematically introduced into pure geometry; Chasles, *Aperçu historique* (1837), in which the author gives a brilliant account of the progress of modern geometrical methods, pointing out the advantages of the different purely geometrical methods as compared with the analytical ones, but without taking as much account of the German as the French authors; *Id., Rapport sur les progrès de la géométrie* (1870), a continuation of the *Aperçu*; *Id., Traité de géométrie supérieure* (1852); Cremona, *Introduzione ad una teoria geometrica delle curve piane* (1862) and its continuation *Preliminari di una teoria geometrica delle superficie* (German translations by Curtze). As more elementary books, we mention: Cremona, *Elements of Projective Geometry*, translated from the Italian by C. Leudesdorf (2nd ed., 1894); J. W. Russell, *Pure Geometry* (2nd ed., 1905).

III. DESCRIPTIVE GEOMETRY

This branch of geometry is concerned with the methods for representing solids and other figures in three dimensions by drawings in one plane. The most important method is that which was invented by Monge towards the end of the 18th century. It is based on parallel projections to a plane by rays perpendicular to the plane. Such a projection is called orthographic (see PROJECTION, § 18). If the plane is horizontal the projection is called the plan of the figure, and if the plane is vertical the elevation. In Monge's method a figure is represented by its plan and elevation, and sometimes simply orthographic projection.

§ 1. We suppose then that we have two planes, one horizontal, and the other vertical, and these we call the planes of plan and of elevation respectively, or the horizontal and the vertical plane, and denote them by the letters π_1 and π_2 . Their line of intersection is called the axis, and will be denoted by xy .

If the surface of the drawing paper is taken as the plane of the plan, then the vertical plane will be the plane perpendicular to it through the axis xy . To bring this also into the plane of the drawing paper we turn it about the axis till it coincides with the horizontal plane. This process of turning one plane down till it coincides with another is called *rabatting* one to the other. Of course there is no necessity to have one of the two planes horizontal, but even when this is not the case it is convenient to retain the above names.

The whole arrangement will be better understood by referring to fig. 37. A point A in space is there projected by the perpendicular

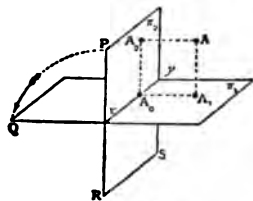

FIG. 37.

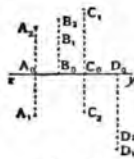

FIG. 38.

AA_1 and AA_2 to the planes π_1 and π_2 so that A_1 and A_2 are the horizontal and vertical projections of A.

If we remember that a line is perpendicular to a plane that is perpendicular to every line in the plane, if only it is perpendicular to any two intersecting lines in the plane, we see that the axis which is perpendicular both to AA_1 and to AA_2 is also perpendicular to AA_1A_2 and to AA_2A_1 because these four lines are all in the same plane. Hence, if the plane π_1 be turned about the axis till it coincides with the plane π_2 , then A_2A_1 will be the continuation of AA_1A_2 . This position of the planes is represented in fig. 38, in which the line A_1A_2 is perpendicular to the axis x .

Conversely any two points A_1, A_2 in a line perpendicular to the axis will be the projections of some point in space when the plane π_2 is turned about the axis till it is perpendicular to the plane π_1 because in this position the two perpendiculars to the planes π_1 and π_2 through the points A_1 and A_2 will be in a plane and therefore meet at some point A.

Representation of Points.—We have thus the following method of representing in a single plane the position of points in space:—we take in the plane a line xy as the axis, and then any pair of points A_1, A_2 in the plane on a line perpendicular to the axis represent a point A in space. If the line A_1A_2 cuts the axis at A_0 , and if at A_0 a perpendicular be erected to the plane, then the point A will be in it at a height $A_1A_0 = A_2A_0$ above the plane. This gives the position of the point A relative to the plane π_1 . In the same way, if in a perpendicular to π_2 through A_2 a point A be taken such that $A_2A_0 = A_0A_1$, then this will give the point A relative to the plane π_2 .

§ 2. The two planes π_1, π_2 in their original position divide space into four parts. These are called the four quadrants. We suppose that the plane π_2 is turned as indicated in fig. 37, so that the point P comes to Q and R to S, then the quadrant in which the point A lies is called the first quadrant, and any that in the first quadrant a point lies above the horizontal and in front of the vertical plane. Now we go round the axis in the sense in which the plane π_2 is turned and come in succession to the second, third and fourth quadrant. In the second a point lies above the plane of the plan and behind the plane of elevation, and so on. In fig. 39, which represents a side view of the planes in fig. 37 the quadrants are marked, and in each a point with its projection is taken. Fig. 38 shows how these are represented when the plane π_2 is turned down. We see that

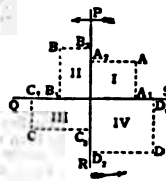

FIG. 39.

A point lies in the first quadrant if the plan lies below, the elevation above the axis; in the second if plan and elevation both lie above; in the third if the plan lies above, the elevation below; in the fourth if plan and elevation both lie below the axis.

If a point lies in the horizontal plane, its elevation lies in the axis and the plan coincides with the point itself. If a point lies in the vertical plane, its plan lies in the axis and the elevation coincides with the point itself. If a point lies in the axis, both its plan and elevation lie in the axis and coincide with it.

Of each of these propositions, which will easily be seen to be true, the converse holds also.

§ 3. **Representation of a Plane.**—As we are thus enabled to represent points in a plane, we can represent any finite figure by representing its separate points. It is, however, not possible to represent a plane in this way, for the projections of its points completely cover the planes π_1 and π_2 , and no plane would appear different from any other. But any plane α cuts each of the planes π_1, π_2 in a line. These are called the traces of the plane. They cut each other in the axis at the point where the latter cuts the plane α .

A plane is determined by its two traces, which are two lines that meet on the axis, and, conversely, any two lines which meet on the axis determine a plane.

If the plane is parallel to the axis its traces are parallel to the axis. Of these one may be at infinity; then the plane will cut one of the planes of projection at infinity and will be parallel to it. Thus a plane parallel to the horizontal plane of the plan has only one finite trace, viz. that with the plane of elevation.

If the plane passes through the axis both its traces coincide with the axis. This is the only case in which the representation of the plane by its two traces fails. A third plane of projection is therefore introduced, which is best taken perpendicular to the other two. We call it simply the third plane and denote it by π_3 . As it is perpendicular to π_1 , it may be taken as the plane of elevation, its line of intersection γ with π_1 being the axis, and be turned down to coincide with π_1 . This is represented in fig. 40. OC is the axis xy whilst OA and OB are the traces of the third plane. They lie in one line γ . The plane is rabatted about γ to the horizontal plane. A plane α through the axis xy will then show in it a trace α_3 . In fig. 40 the lines OC and OP will thus be the traces of a plane through the axis xy , which makes an angle POQ with the horizontal plane.

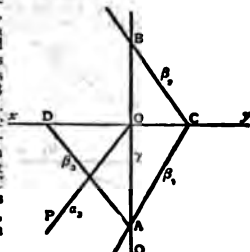

FIG. 40.

We can also find the trace which any other plane makes with π_3 . In rabatting the plane π_2 its trace OB with the plane π_1 will come to the position OD. Hence a plane β having the traces CA and CB will have with the third plane the trace β_3 , or AD if OD = OQ.

It also follows immediately that—

If a plane α is perpendicular to the horizontal plane, then every point in it has its horizontal projection in the horizontal trace of the plane, as all the rays projecting these points lie in the plane itself.

Any plane which is perpendicular to the horizontal plane has its vertical trace perpendicular to the axis.

Any plane which is perpendicular to the vertical plane has its horizontal trace perpendicular to the axis and the vertical projections of all points in the plane lie in this trace.

§ 4. Representation of a Line.—A line is determined either by two points in it or by two planes through it. We get accordingly two representations of it either by projections or by traces.

First.—A line a is represented by its projections a_1 and a_2 on the two planes π_1 and π_2 . These may be any two lines, for, bringing the planes π_1 , π_2 into their original position, the planes through these lines perpendicular to π_1 and π_2 respectively will intersect in some line a which has a_1 , a_2 as its projections.

Secondly.—A line a is represented by its traces—that is, by the points in which it cuts the two planes π_1 , π_2 . Any two points may be taken as the traces of a line in space, for it is determined when the planes are in their original position as the line joining the two traces. This representation becomes undetermined if the two traces coincide in the axis. In this case we again use a third plane, or else the projections of the line.

The fact that there are different methods of representing points and planes, and hence two methods of representing lines, suggests the principle of duality (section II., Projective Geometry, § 41). It is worth while to keep this in mind. It is also worth remembering that traces of planes or lines always lie in the planes or lines which they represent. Projections do not as a rule do this excepting when the point or line projected lies in one of the planes of projection.

Having now shown how to represent points, planes and lines, we have to state the conditions which must hold in order that these elements may lie one in the other, or else that the figure formed by them may possess certain metrical properties. It will be found that the former are very much simpler than the latter.

Before we do this, however, we shall explain the notation used; for it is of great importance to have a systematic notation. We shall denote points in space by capitals A, B, C; planes in space by Greek letters α , β , γ ; lines in space by small letters a , b , c ; horizontal projections by suffixes 1, like A_1 , a_1 ; vertical projections by suffixes 2, like A_2 , a_2 ; traces by single and double dashes a' , a'' , a''' . Hence P_1 will be the horizontal projection of a point P in space; a line a will have the projections a_1 , a_2 and the traces a' and a'' ; a plane α has the traces α' and α'' .

§ 5. If a point lies in a line, the projections of the point lie in the projections of the line.

If a line lies in a plane, the traces of the line lie in the traces of the plane.

These propositions follow at once from the definitions of the projections and of the traces.

If a point lies in two lines its projections must lie in the projections of both. Hence

If two lines, given by their projections, intersect, the intersection of their planes and the intersection of their elevations must lie in a line perpendicular to the axis, because they must be the projections of the point common to the two lines.

Similarly—If two lines given by their traces lie in the same plane or intersect, then the lines joining their horizontal and vertical traces respectively must meet on the axis, because they must be the traces of the plane through them.

§ 6. To find the projections of a line which joins two points A, B given by their projections A_1 , A_2 and B_1 , B_2 , we join A_1 , B_1 and A_2 , B_2 ; these will be the projections required. For example, the traces of a line are two points in the line whose projections are known or at all events easily found. They are the traces themselves and the feet of the perpendiculars from them to the axis.

Hence if a' , a'' (fig. 41) are the traces of a line a , and if the perpendiculars from them cut the axis in P and Q respectively, then the line a' Q will be the horizontal and a'' P the vertical projection of the line.

Conversely, if the projections a_1 , a_2 of a line are given, and if these cut the axis in Q and P respectively, then the perpendiculars Pa'' and Qa' to the axis drawn through these points cut the projections a_1 and a_2 in the traces a' and a'' .

To find the line of intersection of two planes, we observe that this line lies in both planes; its traces must therefore lie in the traces of both. Hence the points where the horizontal traces of the given planes meet will be the horizontal, and the point where the vertical traces meet the vertical trace of the line required.

§ 7. To decide whether a point A, given by its projections, lies in a plane α given by its traces, we draw a line p by joining A to some point in the plane α and determine its traces. If these lie in the

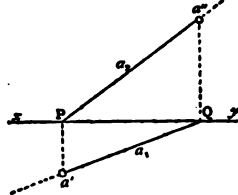

FIG. 41.

traces of the plane, then the line, and therefore the point A, lies in the plane; otherwise not. This is conveniently done by joining A to some point p' in the trace α' ; this gives p_1 ; and the point where the perpendicular from p' to the axis cuts the latter we join to A_2 ; this gives p_2 . If the vertical trace of this line lies in the vertical trace of the plane, then, and then only, does the line p , and with it the point A, lie in the plane α .

§ 8. Parallel planes have parallel traces, because parallel planes are cut by any plane, hence also by π_1 and by π_2 , in parallel lines.

Parallel lines have parallel traces, because points at infinity are projected to infinity.

If a line is parallel to a plane, then lines through the traces of the line and parallel to the traces of the plane must meet on the axis, because these lines are the traces of a plane parallel to the given plane.

§ 9. To draw a plane through two intersecting lines or through two parallel lines, we determine the traces of the lines; the lines joining their horizontal and vertical traces respectively will be the horizontal and vertical traces of the plane. They will meet, at a finite point or at infinity, on the axis if the lines do intersect.

To draw a plane through a line and a point without the line, we join the given point to any point in the line and determine the plane through this and the given line.

To draw a plane through three points which are not in a line, we draw two of the lines which each join two of the given points and draw the plane through them. If the traces of all three lines AB, BC, CA be found, these must lie in two lines which meet on the axis.

§ 10. We have in the last example got more points, or can easily get more points, than are necessary for the determination of the figure required—in this case the traces of the plane. This will happen in a great many constructions and is of considerable importance. It may happen that some of the points or lines obtained are not convenient in the actual construction. The horizontal traces of the lines AB and AC may, for instance, fall very near together, in which case the line joining them is not well defined. Or, one or both of them may fall beyond the drawing paper, so that they are practically non-existent for the construction. In this case the traces of the line BC may be used. Or, if the vertical traces of AB and AC are both in convenient position, so that the vertical trace of the required plane is found and one of the horizontal traces is got, then we may join the latter to the point where the vertical trace cuts the axis.

The draughtsman must remember that the lines which he draws are not mathematical lines without thickness, and therefore every drawing is affected by some errors. It is therefore very desirable to be able constantly to check the latter. Such checks always present themselves when the same result can be obtained by different constructions, or when, as in the above case, some lines must meet on the axis, or if three points must lie in a line. A careful draughtsman will always avail himself of these checks.

§ 11. To draw a plane through a given point parallel to a given plane α , we draw through the point two lines which are parallel to the plane α , and determine the plane through them; or, as we know that the traces of the required plane are parallel to those of the given one (§ 8), we need only draw one line l through the point parallel to the plane and find one of its traces, say the vertical trace l' ; a line through this parallel to the vertical trace of α will be the vertical trace β' of the required plane β , and a line parallel to the horizontal trace of α on the axis will be the horizontal trace β'' .

Let A_1 , A_2 (fig. 42) be the given point, a' , a'' the given plane, a line l through A_1 parallel to a' and a horizontal line l_2 through A_2 will be the projections of a line l through A parallel to the plane, because the horizontal plane through this line will cut the plane α in a line c which has its horizontal projection c_1 parallel to a' .

§ 12. We now come to the metrical properties of figures.

A line is perpendicular to a plane if the projections of the line are perpendicular to the traces of the plane. We prove it for the horizontal projection. If a line p is perpendicular to a plane α , every plane through p is perpendicular to α ; hence also the vertical plane which projects the line p to p_1 . As this plane is perpendicular both to the horizontal plane and to the plane α , it is also perpendicular to their intersection—that is, to the horizontal trace of α . It follows that every line in this projecting plane, therefore also p_1 , the plan of p , is perpendicular to the horizontal trace of α .

To draw a plane through a given point A perpendicular to a given line p , we first draw through some point O in the axis lines γ' , γ'' perpendicular respectively to the projections p_1 and p_2 of the given line. These will be the traces of a plane γ which is perpendicular to the given line. We next draw through the given point A a plane parallel to the plane γ ; this will be the plane required.

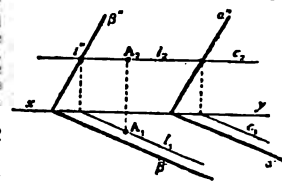

FIG. 42.

Other metrical properties depend on the determination of the real size or shape of a figure.

In general the projection of a figure differs both in size and shape from the figure itself. But figures in a plane parallel to a plane of projection will be identical with their projections, and will thus be given in their true dimensions. In other cases there is the problem, constantly recurring, either to find the true shape and size of a plane figure when plan and elevation are given, or, conversely, to find the latter from the known true shape of the figure itself. To do this, the plane is turned about one of its traces till it is laid down into that plane of projection to which the trace belongs. This is technically called *rabatting the plane* respectively into the plane of the plan or the elevation. As there is no difference in the treatment of the two cases, we shall consider only the case of rabatting a plane α into the plane of the plan. The plan of the figure is a parallel (orthographic) projection of the figure itself. The results of parallel projection (see PROJECTION, §§ 17 and 18) may therefore now be used. The trace a' will hereby take the place of what formerly was called the axis of projection. Hence we see that corresponding points in the plan and in the rabatted plane are joined by lines which are perpendicular to the trace a' and that corresponding lines meet on this trace. We also see that the correspondence is completely determined if we know for one point or one line in the plan the corresponding point or line in the rabatted plane.

Before, however, we treat of this we consider some special cases. § 13. To determine the distance between two points A, B given by their projections A_1, B_1 and A_2, B_2 , or, in other words, to determine the true length of a line the plan and elevation of which are given.

Solution.—The two points A, B in space lie vertically above their plans A_1, B_1 (fig. 43) and A_2A_1, B_2B_1 . The four points A, B, A_1, B_1 therefore form a plane quadrilateral on the base A_1B_1 and having right angles at the base. This plane we rabatt about A_1B_1 by drawing A_1A and B_1B perpendicular to A_1B_1 and making $A_1A = A_2A_1, B_1B = B_2B_1$. Then AB will give the length required.

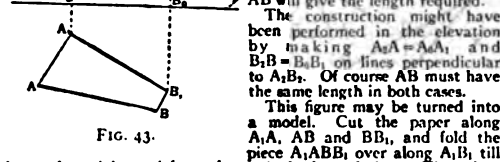

FIG. 43.

The construction might have been performed in the elevation by making $A_2A = A_1A_2$ and $B_2B = B_1B_2$ on lines perpendicular to A_2B_2 . Of course AB must have the same length in both cases. This figure may be turned into a model. Cut the paper along A_1A, AB and B_1B , and fold the piece A_1ABB_1 over along A_1B_1 till it stands upright at right angles to the horizontal plane. The points A, B will then be in their true position in space relative to x_1 . Similarly if $B_2B_2A_2$ be cut out and turned along A_2B_2 through a right angle we shall get AB in its true position relative to the plane x_2 . Lastly we fold the whole plane of the paper along the axis x till the plane x_2 is at right angles to x_1 . In this position the two sets of points AB will coincide if the drawing has been accurate.

Models of this kind can be made in many cases and their construction cannot be too highly recommended in order to realize orthographic projection.

§ 14. To find the angle between two given lines a, b of which the projections a_1, b_1 and a_2, b_2 are given.

Solution.—Let a_1, b_1 (fig. 44) meet in P_1, a_2, b_2 in T , then if the line P_1T is not perpendicular to the axis the two lines will not meet. In this case we draw a line parallel to b_2 to meet the line a_2 . This is easiest done by drawing first the line P_1P_2 perpendicular to the axis to meet a_2 in P_2 , and then drawing through P_2 a line c_2 parallel to b_2 ; then b_1, c_2 will be the projections of a line c which is parallel to b and meets a in P . The plane α which these two lines determine we rabatt to the plan. We determine the traces a' and c' of the lines a and c ; then $a'c'$ is the trace α' of their plane. On rabatting the point P comes to a point S on the line P_1Q perpendicular to $a'c'$, so that $QS = QP$. But QP is the hypotenuse of a triangle PP_1Q with a right angle P_1 . This we construct by making $QH = PP_1$; then $P_1R = PQ$. The lines $a'S$ and $c'S$ will therefore include angles equal to those made by the given lines. It is to be remembered that two lines include two angles which are supplementary. Which of these is to be taken in any special case depends upon the circumstances.

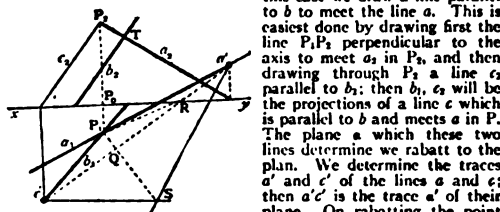

FIG. 44.

To determine the angle between a line and a plane, we draw through any point in the line a perpendicular to the plane (§ 12) and determine the angle between it and the given line. The complement of this angle is the required one.

To determine the angle between two planes, we draw through any

point two lines perpendicular to the two planes and determine the angle between the latter as above.

In special cases it is simpler to determine at once the angle between the two planes by taking a plane section perpendicular to the intersection of the two planes and rabatt this. This is especially the case if one of the planes is the horizontal or vertical plane of projection.

Thus in fig. 45 the angle P_1QR is the angle which the plane α makes with the horizontal plane.

§ 15. We return to the general case of rabatting a plane α of which the traces a, a' are given.

Here it will be convenient to determine first the position which the trace a'' —which is a line in α —assumes when rabatted. Points in this line coincide with their elevations. Hence it is given in its true dimension, and we can measure off along it the true distance between two points in it. If therefore, (fig. 45) P is any point in α' originally coincident with its elevation P_2 , and if O is the point where a' cuts the axis xy , so that O is also in a'' , then the point P will after rabatting the plane assume such a position that $OP = OP_2$. At the same time the plan is an orthographic projection of the plane α . Hence the line joining P to the plan P_1 will after rabatting be perpendicular to a' . But P_2 is known; it is the foot of the perpendicular from P_2 to the axis xy . We draw therefore, to find P , from P_2 a perpendicular P_2Q to a' and find on it a point P such that $OP = OP_2$. Then the line QP will be the position of a'' when rabatted. This line corresponds therefore to the plan of a'' —that is, to the axis xy , corresponding points on these lines being those which lie on a perpendicular to a' .

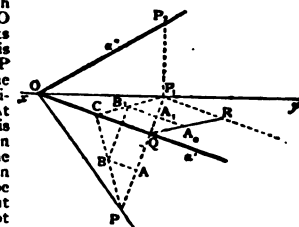

FIG. 45.

We have thus one pair of corresponding lines and can now find for any point B_1 in the plan the corresponding point B in the rabatted plane. We draw a line through B_1 , say B_1P_1 , cutting a' in C . To it corresponds the line CP , and the point where this is cut by the projecting ray through B_1 , perpendicular to a' , is the required point B .

Similarly any figure in the rabatted plane can be found when the plan is known; but this is usually found in a different manner without any reference to the general theory of parallel projection. As this method and the reasoning employed for it have their peculiar advantages, we give it also.

Supposing the planes α_1 and α_2 to be in their positions in space perpendicular to each other, we take a section of the whole figure by a plane perpendicular to the trace a' about which we are going to rabatt the plane α . Let this section pass through the point Q in a' . Its traces will then be the lines QP_1 and P_1P_2 (fig. 9). These will be at right angles, and will therefore, together with the section QP_2 of the plane α , form a right-angled triangle QP_1P_2 with the right angle at P_1 , and having the sides P_1Q and P_1P_2 which both are given in their true lengths. This triangle we rabatt about its base P_1Q , making $P_1R = P_1P_2$. The line QR will then give the true length of the line QP in space. If now the plane α be turned about a' the point P will describe a circle about Q as centre with radius $QP = QR$, in a plane perpendicular to the trace a' . Hence when the plane α has been rabatted into the horizontal plane the point P will lie in the perpendicular P_1Q to a' , so that $QP = QR$.

If A_1 is the plan of a point A in the plane α , and if A_1 lies in QP_1 , then the point A will lie vertically above A_1 in the line QP_1 . On turning down the triangle QP_1P_2 , the point A will come to A_2 , the line A_2A_1 being perpendicular to QP_1 . Hence A will be a point in QP such that $QA = QA_2$.

If B_1 is the plan of another point, but such that A_1B_1 is parallel to a' , then the corresponding line AB will also be parallel to a' . Hence, if through A a line AB be drawn parallel to a' , and B_1B perpendicular to a' , then their intersection gives the point B . Thus of any point given in plan the real position in the plane α , when rabatted, can be found by this second method. This is the one most generally given in books on geometrical drawing. The first method explained is, however, in most cases preferable as it gives the draughtsman a greater variety of constructions. It requires a somewhat greater amount of theoretical knowledge.

If instead of our knowing the plan of a figure the latter is itself given, then the process of finding the plan is the reverse of the above and needs little explanation. We give an example.

§ 16. It is required to draw the plan and elevation of a polygon of which the real shape and position in a given plane α are known.

We first rabatt the plane α (fig. 46) as before so that a' comes to P , hence OP_1 to QP . Let the given polygon in α be the figure $ABCDE$. We project, not the vertices, but the sides. To project the line AB , we produce it to cut a' in F and OP in G , and draw CG_1 perpendicular to a' ; then G_1C_1 corresponds to G , therefore FG_1 to FG . In the same manner we might project all the other sides, as BC .

those which cut OF and OP in convenient points. It will be best, however, first to produce all the sides to cut OP draw all the projecting rays through A, B, C . . .

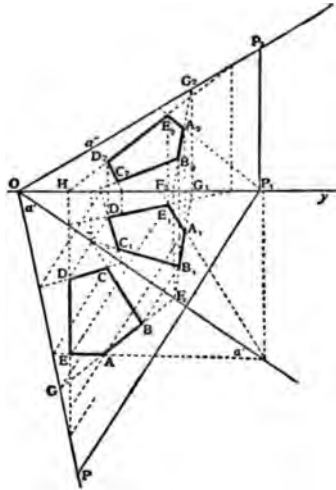

FIG. 46.

the drawing, for two corresponding diagonals must meet in the trace a' .

Having got the plan we easily find the elevation. The elevation of G is above G_1 in a' , and that of F is at F_1 in the axis. This gives the elevation F_1G_1 of FG and in it we get A_1B_1 in the verticals through A_1 and B_1 . As a check we have $OG_1 = OG_2$. Similarly the elevation of the other sides and vertices are found.

§ 17. We proceed to give some applications of the above principles to the representation of solids and of the solution of problems connected with them.

Of a pyramid are given its base, the length of the perpendicular from the vertex to the base, and the point where this perpendicular cuts the base; it is required first to develop the whole surface of the pyramid into one plane, and second to determine its section by a plane which cuts the plane of the base in a given line and makes a given angle with it.

1. As the planes of projection are not given we can take them as we like, and we select them in such a manner that the solution becomes as simple as possible. We take the plane of the base as the horizontal plane and the vertical plane perpendicular to the plane of the section. Let then (fig. 47) ABCD be the base of the pyramid, V_1 the plan of the vertex, then the elevations of A, B, C, D will be in the axis at A_1, B_1, C_1, D_1 , and the vertex at some point V_2 above V_1 at a known distance from it. The lines $V_1A, V_1B, \&c.$ will be the plans and the lines $V_1A_1, V_1B_1, \&c.$ the elevations of the edges of the pyramid, of which thus plan and elevation are known.

We develop the surface into the plane of the base by turning each lateral face about its lower edge into the horizontal plane by the method used in § 14. If one face has been turned down, say ABV to ABP, then the point Q to which the vertex of the next face BCV comes can be got more simply by finding on the line V_1Q perpendicular to BC the point Q such that $BQ = BP$, for these lines represent the same edge BV of the pyramid. Next R is found by making $CR = CQ$, and so on till we have got the last vertex—in this case S. The fact that AS must equal AP gives a convenient check.

2. The plane a whose section we have to determine has its horizontal trace given perpendicular to the axis, and its vertical trace makes the given angle with the axis. This determines it. To find the section of the pyramid by this plane there are two methods applicable: we find the sections of the plane either with the faces or with the edges of the pyramid. We use the latter.

As the plane a is perpendicular to the vertical plane, the trace a' contains the projection of every figure in it: the points E, F, G, H , where this trace cuts the elevations of the edges will therefore be the elevations of the points where the edges cut a . From these we find the plans E_1, F_1, G_1, H_1 , and by joining them the plan of the section. If from E_1, F_1 lines be drawn perpendicular to AB, these will determine the points E, F on the developed face in which the plane a cuts it; hence also the line EF. Similarly on the other faces. Of course BF must be the same length on BP and on BQ. If the plane a be rabatted to the plan, we get the real shape of the section as shown in the figure in EFGH. This is done easily by

making $F_1F = OF_1, \&c.$ If the figure representing the development of the pyramid, or better a copy of it, is cut out, and if the lateral faces be bent along the lines AB, BC, &c., we get a model of the pyramid with the section marked on its faces. This may be placed on its plan ABCD and the plane of elevation bent about the axis x . The pyramid stands then in front of its elevations. If next the plane a with a hole cut out representing the true section be bent along the trace a' till its edge coincides with a' , the edges of the hole ought to coincide with the lines EF, FG, &c., on the faces.

§ 18. Polyhedra like the pyramid in § 17 are represented by the projections of their edges and vertices. But solids bounded by curved surfaces, or surfaces themselves, cannot be thus represented. For a surface we may use, as in case of the plane, its traces—that is, the curves in which it cuts the planes of projection. We may also project points and curves on the surface. A ray cuts the surface generally in more than one point; hence it will happen that some of the rays touch the surface, if two of these points coincide. The points of contact of these rays will form some curve on the surface, and this will appear from the centre of projection as the boundary of the surface or of part of the surface. The outlines of all surfaces of solids which we see about us are formed by the points at which rays through our eye touch the surface. The projections of these contours are therefore best adapted to give an idea of the shape of a surface.

Thus the tangents drawn from any finite centre to a sphere form a right circular cone, and this will be cut by any plane in a conic.

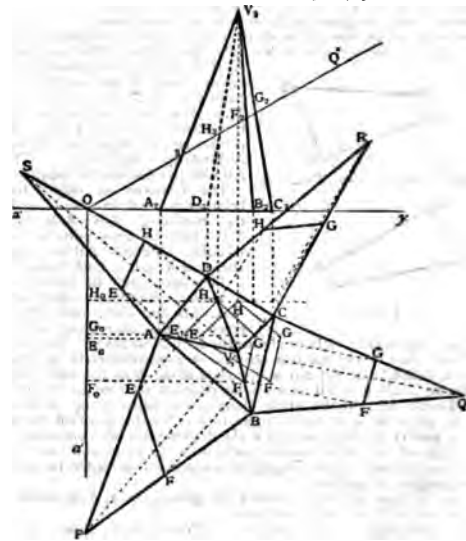

FIG. 47.

It is often called the projection of a sphere, but it is better called the contour-line of the sphere, as it is the boundary of the projections of all points on the sphere.

If the centre is at infinity the tangent cone becomes a right circular cylinder touching the sphere along a great circle, and if the projection is, as in our case, orthographic, then the section of this cone by a plane of projection will be a circle equal to the great circle of the sphere. We get such a circle in the plan and another in the elevation, their centres being plan and elevation of the centre of the sphere.

Similarly the rays touching a cone of the second order will be in two planes which pass through the vertex of the cone, the contour-line of the projection of the cone consists therefore of two lines meeting in the projection of the vertex. These may, however, be invisible if no real tangent rays can be drawn from the centre of projection; and this happens when the ray projecting the centre of the vertex lies within the cone. In this case the traces of the cone are of importance. Thus in representing a cone of revolution with a vertical axis we get in the plan a circular trace of the surface whose centre is the plan of the vertex of the cone, and in the elevation the contour, consisting of a pair of lines intersecting in the elevation of the vertex of the cone. The circle in the plan and the pair of lines in the elevation do not determine the surface, for an infinite number of surfaces might be conceived which pass through the circular trace and touch two planes through the contour lines in the vertical plane. The surface becomes only completely defined if we write down to the figure that it shall represent a cone. The same holds for all

surfaces. Even a plane is fully represented by its traces only under the silent understanding that the traces are those of a plane.

§ 19. Some of the simpler problems connected with the representation of surfaces are the determination of plane sections and of the curves of intersection of two such surfaces. The former is constantly used in nearly all problems concerning surfaces. Its solution depends of course on the nature of the surface.

To determine the curve of intersection of two surfaces, we take a plane and determine its section with each of the two surfaces, rabutting this plane if necessary. This gives two curves which lie in the same plane and whose intersections will give us points on both surfaces. It must here be remembered that two curves in space do not necessarily intersect, hence that the points in which their projections intersect are not necessarily the projections of points common to the two curves. This will, however, be the case if the two curves lie in a common plane. By taking then a number of plane sections of the surfaces we can get as many points on their curve of intersection as we like. These planes have, of course, to be selected in such a way that the sections are curves as simple as the case permits of, and such that they can be easily and accurately drawn. Thus when possible the sections should be straight lines or circles. This not only saves time in drawing but determines all points on the sections, and therefore also the points where the two curves meet, with equal accuracy.

§ 20. We give a few examples how these sections have to be selected. A cone is cut by every plane through the vertex in lines, and if it is a cone of revolution by planes perpendicular to the axis in circles.

A cylinder is cut by every plane parallel to the axis in lines, and if it is a cylinder of revolution by planes perpendicular to the axis in circles.

A sphere is cut by every plane in a circle. Hence in case of two cones situated anywhere in space we take sections through both vertices. These will cut both cones in lines. Similarly in case of two cylinders we may take sections parallel to the axis of both. In case of a sphere and a cone of revolution with vertical axis, horizontal sections will cut both surfaces in circles whose plans are circles and whose elevations are lines, whilst vertical sections through the vertex of the cone cut the latter in lines and the sphere in circles. To avoid drawing the projections of these circles, which would in general be ellipses, we rabutt the plane and then draw the circles in their real shape. And so on in other cases.

Special attention should in all cases be paid to those points in which the tangents to the projection of the curve of intersection are parallel or perpendicular to the axis x , or where these projections touch the contour of one of the surfaces. (O. H.)

IV. ANALYTICAL GEOMETRY

1. In the name *geometry* there is a lasting record that the science had its origin in the knowledge that two distances may be compared by measurement, and in the idea that measurement must be effectual in the dissociation of different directions as well as in the comparison of distances in the same direction. The distance from an observer's eye of an object seen would be specified as soon as it was ascertained that a rod, straight to the eye and of length taken as known, could be given the direction of the line of vision, and had to be moved along it a certain number of times through lengths equal to its own in order to reach the object from the eye. Moreover, if a field had for two of its boundaries lines straight to the eye, one running from south to north and the other from west to east, the position of a point in the field would be specified if the rod, when directed west, had to be shifted from the point one observed number of times westward to meet the former boundary, and also, when directed south, had to be shifted another observed number of times southward to meet the latter. Comparison by measurement, the beginning of geometry, involved counting, the basis of arithmetic; and the science of number was marked out from the first as of geometrical importance.

But the arithmetic of the ancients was inadequate as a science of number. Though a length might be recognized as known when measurement certified that it was so many times a standard length, it was not every length which could be thus specified in terms of the same standard length, even by an arithmetic enriched with the notion of fractional number. The idea of possible incommensurability of lengths was introduced into Europe by Pythagoras; and the corresponding idea of irrationality of number was absent from a crude arithmetic, while there were great practical difficulties in the way of its introduction. Hence perhaps it arose that, till comparatively modern times, appeal to arithmetical aid in geometrical reasoning was in all

possible ways restrained. Geometry figured rather as the helper of the more difficult science of arithmetic.

2. It was reserved for algebra to remove the disabilities of arithmetic, and to restore the earliest ideas of the land-measurer to the position of controlling ideas in geometrical investigation. This unified science of pure number made comparatively little headway in the hands of the ancients, but began to receive due attention shortly after the revival of learning. It expresses whole classes of arithmetical facts in single statements, gives to arithmetical laws the form of equations involving symbols which may mean any known or sought numbers, and provides processes which enable us to analyse the information given by an equation and derive from that equation other equations, which express laws that are in effect consequences or causes of a law started from, but differ greatly from it in form. Above all, for present purposes, it deals not only with integral and fractional number, but with number regarded as capable of continuous growth, just as distance is capable of continuous growth. The difficulty of the arithmetical expression of irrational number, a difficulty considered by the modern school of analysts to have been at length surmounted (see FUNCTION), is not vital to it. It can call the ratio of the diagonal of a square to a side, for instance, or that of the circumference of a circle to a diameter, a number, and let a or x denote that number, just as properly as it may allow either letter to denote any rational number which may be greater or less than the ratio in question by a difference less than any minute one ϵ choose to assign.

Counting only, and not the counting of objects, is of the essence of arithmetic, and of algebra. But it is lawful to count objects, and in particular to count equal lengths by measure. The widened idea is that even when a or x is an irrational number we may speak of a or x unit lengths by measure. We may give concrete interpretation to an algebraical equation by allowing its terms all to mean numbers of times the same unit length, or the same unit area, or &c. and in any equation lawfully derived from the first by algebraical processes we may do the same. Descartes in his *Geométrie* (1637) was the first to systematize the application of this principle to the inherent first notions of geometry; and the methods which he instituted have become the most potent methods of all in geometrical research. It is hardly too much to say that, when known facts as to a geometrical figure have once been expressed in algebraical terms, all strictly consequential facts as to the figure can be deduced by almost mechanical processes. Some may well be unexpected consequences; and in obtaining those of which there has been suggestion beforehand the often bewildering labour of constant attention to the figure is obviated. These are the methods of what is now called *analytical*, or sometimes *algebraical*, geometry.

3. The modern use of the term "analytical" in geometry has obscured, but not made obsolete, an earlier use, one as old as Plato. There is nothing algebraical in this analysis, as distinguished from synthesis, of the Greeks, and of the expositors of pure geometry. It has reference to an order of ideas in demonstration, or, more frequently, in discovering means to effect the geometrical construction of a figure with an assigned special property. We have to suppose hypothetically that the construction has been performed, drawing a rough figure which exhibits it as nearly as is practicable. We then analyse or critically examine the figure, treated as correct, and ascertain other properties which it can only possess in association with the one in question. Presently one of these properties will often be found which is of such a character that the construction of a figure possessing it is simple. The means of effecting synthetically a construction such as was desired is thus brought to light by what Plato called *analysis*. Or again, being asked to prove a theorem A, we ascertain that it must be true if another theorem B is, that B must be if C is, and so on, thus eventually finding that the theorem A is the consequence, through a chain of intermediaries, of a theorem Z of which the establishment is easy. This geometrical analysis is not the subject of the present article; but in the reasoning from form to form of an equation or system

of equations, with the object of basing the algebraical proof of a geometrical fact on other facts of a more obvious character, the same logic is utilized, and the name "analytical geometry" is thus in part explained.

4. In algebra real positive number was alone at first dealt with, and in geometry actual signless distance. But in algebra it became of importance to say that every equation of the first degree has a root, and the notion of negative number was introduced. The negative unit had to be defined as what can be added to the positive unit and produce the sum zero. The corresponding notion was readily at hand in geometry, where it was clear that a unit distance can be measured to the left or down from the farther end of a unit distance already measured to the right or up from a point O, with the result of reaching O again. Thus, to give full interpretation in geometry to the algebraically negative, it was only necessary to associate distinctness of sign with oppositeness of direction. Later it was discovered that algebraical reasoning would be much facilitated, and that conclusions as to the real would retain all their soundness, if a pair of imaginary units $\pm\sqrt{-1}$ of what might be called number were allowed to be contemplated, the pair being defined, though not separately, by the two properties of having the real sum 0 and the real product 1. Only in these two real combinations do they enter in conclusions as to the real. An advantage gained was that every quadratic equation, and not some quadratics only, could be spoken of as having two roots. These admissions of new units into algebra were final, as it admitted of proof that all equations of degrees higher than two have the full numbers of roots possible for their respective degrees in any case, and that every root has a value included in the form $a + b\sqrt{-1}$, with a, b , real. The corresponding enrichment could be given to geometry, with corresponding advantages and the same absence of danger, and this was done. On a line of measurement of distance we contemplate as existing, not only an infinite continuum of points at real distances from an origin of measurement O, but a doubly infinite continuum of points, all but the singly infinite continuum of real ones imaginary, and imaginary in conjugate pairs, a conjugate pair being at imaginary distances from O, which have a real arithmetic and a real geometric mean. To geometry enriched with this conception all algebra has its application.

5. Actual geometry is one, two or three-dimensional, i.e. lineal, plane or solid. In one-dimensional geometry positions and measurements in a single line only are admitted. Now descriptive constructions for points in a line are impossible without going out of the line. It has therefore been held that there is a sense in which no science of geometry strictly confined to one dimension exists. But an algebra of one variable can be applied to the study of distances along a line measured from a chosen point on it, so that the idea of construction as distinct from measurement is not essential to a one-dimensional geometry aided by algebra. In geometry of two dimensions, the flat of the land-measurer, the passage from one point O to any other point, can be effected by two successive marches, one east or west and one north or south, and, as will be seen, an algebra of two variables suffices for geometrical exploitation. In geometry of three dimensions, that of space, any point can be reached from a chosen one by three marches, one east or west, one north or south, and one up or down; and we shall see that an algebra of three variables is all that is necessary. With three dimensions actual geometry stops; but algebra can supply any number of variables. Four or more variables have been used in ways analogous to those in which one, two and three variables are used for the purposes of one, two and three-dimensional geometry, and the results have been expressed in quasi-geometrical language on the supposition that a higher space can be conceived of, though not realized, in which four independent directions exist, such that no succession of marches along three of them can effect the same displacement of a point as a march along the fourth; and similarly for higher numbers than four. Thus analytical, though not actual, geometries exist for four and more dimensions. They are in fact algebras furnished with nomenclature of a geometrical cast, suggested by convenient

forms of expression which actual geometry has, in return for benefits received, conferred on algebras of one, two and three variables.

We will confine ourselves to the dimensions of actual geometry, and will devote no space to the one-dimensional, except incidentally as existing within the two-dimensional. The analytical method will now be explained for the cases of two and three dimensions in succession. The form of it originated by Descartes, and thence known as Cartesian, will alone be considered in much detail.

I. Plane Analytical Geometry.

6. Coordinates.—It is assumed that the points, lines and figures considered lie in one and the same plane, which plane therefore need not be in any way referred to. In the plane a point O, and two lines $x'Ox, y'Oy$, intersecting in O, are taken once for all, and regarded as fixed. O is called the origin, and $x'Ox, y'Oy$ the axes of x and y respectively. Other positions in the plane are specified in relation to this fixed origin and these fixed axes. From any point P we

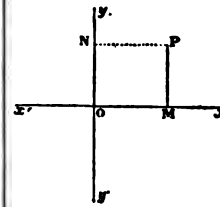

FIG. 48.

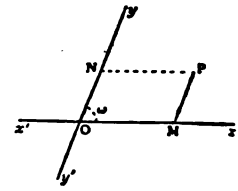

FIG. 49.

suppose PM drawn parallel to the axis of y to meet the axis of x in M, and may also suppose PN drawn parallel to the axis of x to meet the axis of y in N, so that OMPN is a parallelogram. The position of P is determined when we know OM (=NP) and MP (=ON). If OM is x times the unit of a scale of measurement chosen at pleasure, and MP is y times the unit, so that x and y have numerical values, we call x and y the (Cartesian) coordinates of P. To distinguish them we often speak of y as the ordinate, and of x as the abscissa.

It is necessary to attend to signs; x has one sign or the other according as the point P is on one side or the other of the axis of y , and y one sign or the other according as P is on one side or the other of the axis of x . Using the letters N, E, S, W, as in a map, and considering the plane as divided into four quadrants by the axes, the signs are usually taken to be:

x	y	For quadrant
+	+	N E
+	-	S E
-	+	N W
-	-	S W

A point is referred to as the point (a, b) , when its coordinates are $x=a, y=b$. A point may be fixed, or it may be variable, i.e. be regarded for the time being as free to move in the plane. The coordinates (x, y) of a variable point are algebraic variables, and are said to be "current coordinates."

The axes of x and y are usually (as in fig. 48) taken at right angles to one another, and we then speak of them as rectangular axes, and of x and y as "rectangular coordinates" of a point P; OMPN is then a rectangle. Sometimes, however, it is convenient to use axes which are oblique to one another, so that (as in fig. 49) the angle $x'Oy$ between their positive directions is some known angle ω distinct from a right angle, and OMPN is always an oblique parallelogram with given angles; and we then speak of x and y as "oblique coordinates." The coordinates are as a rule taken to be rectangular in what follows.

7. Equations and loci. If (x, y) is the point P, and if we are given that $x=a$, we are told that, in fig. 48 or fig. 49, the point M lies at O, whatever value y may have, i.e. we are told the one fact that P lies on the axis of y . Conversely, if P lies anywhere on the axis of y , we have always OM=0, i.e. $x=0$. Thus the equation $x=0$ is one satisfied by the coordinates (x, y) of every point in the axis of y , and not by those of any other point. We say that $x=0$ is the equation of the axis of y , and that the axis of y is the locus represented by the equation $x=0$. Similarly $y=0$ is the equation of the axis of x . An equation $x=a$, where a is a constant, expresses that P lies on a parallel to the axis of y through a point M on the axis of x such that OM= a . Every line parallel to the axis of y has an equation of this form. Similarly, every line parallel to the axis of x has an equation of the form $y=b$, where b is some definite constant.

These are simple cases of the fact that a single equation in the current coordinates of a variable point (x, y) imposes one limitation on the freedom of that point to vary. The coordinates of a point

taken at random in the plane will, as a rule, not satisfy the equation, but infinitely many points, and in most cases infinitely many real ones, have coordinates which do satisfy it, and these points are exactly those which lie upon some locus of one dimension, a straight line or more frequently a curve, which is said to be represented by the equation. Take, for instance, the equation $y=mx$, where m is a given constant. It is satisfied by the coordinates of every point P, which is such that, in fig. 48, the distance MP, with its proper sign, is m times the distance OM, with its proper sign, i.e. by the coordinates of every point in the straight line through O which we arrive at by making a line, originally coincident with $x'Ox$, revolve about O in the direction opposite to that of the hands of a watch through an angle of which m is the tangent, and by those of no other points. That line is the locus which it represents. Take, more generally, the equation $y=\phi(x)$, where $\phi(x)$ is any given non-ambiguous function of x . Choosing any point M on $x'Ox$ in fig. 49, and giving to x the value of the numerical measure of OM, the equation determines a single corresponding y , and so determines a single point P on the line through M parallel to $y'Oy$. This is one point whose coordinates satisfy the equation. Now let M move from the extreme left to the extreme right of the line $x'Ox$, regarded as extended both ways as far as we like, i.e. let x take all real values from $-\infty$ to ∞ . With every value goes a point P, as above, on the parallel to $y'Oy$ through the corresponding M; and we thus find that there is a path from the extreme left to the extreme right of the figure, all points P along which are distinguished from other points by the exceptional property of satisfying the equation by their coordinates. This path is a locus; and the equation $y=\phi(x)$ represents it. More generally still, take an equation $f(x, y)=0$ which involves both x and y under a functional form. Any particular value given to x in it produces from it an equation for the determination of a value or values of y , which go with that value of x in specifying a point or points (x, y) , of which the coordinates satisfy the equation $f(x, y)=0$. Here again, as x takes all values, the point or points describe a path or paths, which constitute a locus represented by the equation. Except when y enters to the first degree only in $f(x, y)$, it is not to be expected that all the values of y , determined as going with a chosen value of x , will be necessarily real; indeed it is not uncommon for all to be imaginary for some ranges of values of x . The locus may largely consist of continua of imaginary points; but the real parts of it constitute a real curve or real curves. Note that we have to allow x to admit of all imaginary, as well as of all real, values, in order to obtain all imaginary parts of the locus.

A locus or curve may be algebraically specified in another way; viz. we may be given two equations $x=f(\theta)$, $y=F(\theta)$, which express the coordinates of any point of it as two functions of the same variable parameter θ to which all values are open. As θ takes all values in turn, the point (x, y) traverses the curve.

It is a good exercise to trace a number of curves, taken as defined by the equations which represent them. This, in simple cases, can be done approximately by plotting the values of y given by the equation of a curve as going with a considerable number of values of x , and connecting the various points (x, y) thus obtained. But methods exist for diminishing the labour of this tentative process.

Another problem, which will be more attended to here, is that of determining the equations of curves of known interest, taken as defined by geometrical properties. It is not a matter for surprise that the curves which have been most and longest studied geometrically are among those represented by equations of the simplest character.

8. *The Straight Line.*—This is the simplest type of locus. Also the simplest type of equation in x and y is $Ax+By+C=0$, one of the first degree. Here the coefficients A, B, C are constants. They are, like the current coordinates, x, y , numerical. But, in giving interpretation to such an equation, we must of course refer to numbers Ax, By, C of unit magnitudes of the same kind, of units of counting for instance, or unit lengths or unit squares. It will now be seen that every straight line has an equation of the first degree, and that every equation of the first degree represents a straight line.

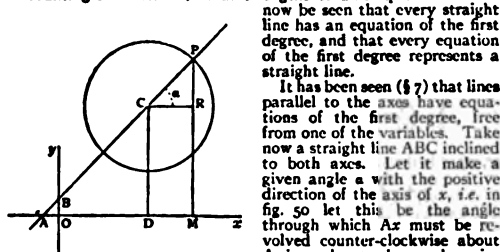

FIG. 50.

It has been seen (§ 7) that lines parallel to the axes have equations of the first degree, free from one of the variables. Take now a straight line ABC inclined to both axes. Let it make a given angle α with the positive direction of the axis of x , i.e. in fig. 50 let this be the angle through which Ax must be revolved counter-clockwise about A in order to be made coincident with the line. Let C, of coordinates (h, k) , be a fixed point on the line, and P (x, y) any other point upon it. Draw the ordinates CD, PM of C and P, and let the parallel to the axis of x through C meet PM, produced if necessary, in R. The right-angled triangle

CRP tells us that, with the signs appropriate to their directions attached to CR and RP, $RP=CR \tan \alpha$, i.e. $MP-DC=(OM-OD) \tan \alpha$, and this gives that

$$y-k=\tan \alpha(x-h),$$

an equation of the first degree satisfied by x and y . No point not on the line satisfies the same equation; for the line from C to any point off the line would make with CR some angle β different from α , and the point in question would satisfy an equation $y-k=\tan \beta(x-h)$, which is inconsistent with the above equation.

The equation of the line may also be written $y=mx+b$, where $m=\tan \alpha$, and $b=k-h \tan \alpha$. Here b is the value obtained for y from the equation when 0 is put for x , i.e. it is the numerical measure, with proper sign, of OB, the intercept made by the line on the axis of y , measured from the origin. For different straight lines, m and b may have any constant values we like.

Now the general equation of the first degree $Ax+By+C=0$ may be written $y=-\frac{A}{B}x-\frac{C}{B}$, unless $B=0$, in which case it represents a line parallel to the axis of y ; and $-A/B, -C/B$ are values which can be given to m and b , so that every equation of the first degree represents a straight line. It is important to notice that the general equation, which in appearance contains three constants A, B, C , in effect depends on two only, the ratios of two of them to the third. In virtue of this last remark, we see that two distinct conditions suffice to determine a straight line. For instance, it is easy from the above to see that

$$\frac{x}{a}+\frac{y}{b}=1$$

is the equation of a straight line determined by the two conditions that it makes intercepts OA, OB on the two axes, of which a and b are the numerical measures with proper signs. Note that in fig. 50 a is negative. Again,

$$y-y_1=\frac{y_2-y_1}{x_2-x_1}(x-x_1),$$

i.e.

$$(y_1-y_2)x-(x_1-x_2)y+x_1y_2-x_2y_1=0,$$

represents the line determined by the data that it passes through two given points (x_1, y_1) and (x_2, y_2) . To prove this find m in the equation $y-y_1=m(x-x_1)$ of a line through (x_1, y_1) , from the condition that (x_2, y_2) lies on the line.

In this paragraph the coordinates have been assumed rectangular. Had they been oblique, the doctrine of similar triangles would have given the same results, except that in the forms of equation $y-k=m(x-h)$, $y=mx+b$, we should not have had $m=\tan \alpha$.

9. *The Circle.*—It is easy to write down the equation of a given circle. Let (h, k) be its given centre C, and ρ the numerical measure of its given radius. Take P (x, y) any point on its circumference, and construct the triangle CRP, in fig. 50 as above. The fact that this is right-angled tells us that

$$CR^2+RP^2=CP^2,$$

and this at once gives the equation

$$(x-h)^2+(y-k)^2=\rho^2.$$

A point not upon the circumference of the particular circle is at some distance from (h, k) different from ρ , and satisfies an equation inconsistent with this one; which accordingly represents the circumference, or, as we say, the circle.

The equation is of the form

$$x^2+y^2+2Ax+2By+C=0.$$

Conversely every equation of this form represents a circle: we have only to take $-A, -B, A^2+B^2-C$ for h, k, ρ^2 respectively, to obtain its centre and radius. But this statement must appear too unrestricted. Ought we not to require A^2+B^2-C to be positive? Certainly, if by circle we are only to mean the visible round circumference of the geometrical definition. Yet, analytically, we contemplate altogether imaginary circles, for which ρ^2 is negative, and circles, for which $\rho=0$, with all their reality condensed into their centres. Even when ρ^2 is positive, so that a visible round circumference exists, we do not regard this as constituting the whole of the circle. Giving to x any value whatever in $(x-h)^2+(y-k)^2=\rho^2$, we obtain two values of y , real, coincident or imaginary, each of which goes with the abscissa x as the ordinate of a point, real or imaginary, on what is represented by the equation of the circle.

The doctrine of the imaginary on a circle, and in geometry generally, is of purely algebraical inception; but it has been in its entirety accepted by modern pure geometers, and signal success has attended the efforts of those who, like K. G. C. von Staudt, have striven to base its conclusions on principles not at all algebraical in form, though of course cognate to those adopted in introducing the imaginary into algebra.

A circle with its centre at the origin has an equation $x^2+y^2=\rho^2$. In oblique coordinates the general equation of a circle is $x^2+2xy \cos \omega+y^2+2Ax+2By+C=0$.

10. The conic sections are the next simplest loci; and it will be seen later that they are the loci represented by equations of the second degree. Circles are particular cases of conic sections, and

they have just been seen to have for their equations a particular class of equations of the second degree. Another particular class of such equations is that included in the form $(Ax+By+C)(A'x+B'y+C')=0$, which represents two straight lines, because the product on the left vanishes if, and only if, one of the two factors does, i.e. if, and only if, (x, y) lies on one or other of two straight lines. The condition that $ax^2+2hxy+by^2+2gx+2fy+c=0$, which is often written $(d, b, c, f, g, h)(x, y, 1)^2=0$, takes this form is $abc+2fgh-af^2-bg^2-ch^2=0$. Note that the two lines may, in particular cases, be parallel or coincident.

Any equation like $F_1(x, y) F_2(x, y) \dots F_n(x, y)=0$, of which the left-hand side breaks up into factors, represents all the loci separately represented by $F_1(x, y)=0, F_2(x, y)=0, \dots, F_n(x, y)=0$. In particular an equation of degree n which is free from x represents n straight lines parallel to the axis of x , and one of degree m which is homogeneous in x and y , i.e. one which upon division by x^m becomes an equation in the ratio y/x , represents m straight lines through the origin.

Curves represented by equations of the third degree are called cubic curves. The general equation of this degree will be written $(*) (x, y, 1)^3=0$.

11. *Descriptive Geometry*.—A geometrical proposition is either descriptive or metrical: in the former case the statement of it is independent of the idea of magnitude (length, inclination, &c.), and in the latter it has reference to this idea. The method of coordinates seems to be by its inception essentially metrical. Yet in dealing by this method with descriptive propositions we are eminently free from metrical considerations, because of our power to use general equations, and to avoid all assumption that measurements implied are any particular measurements.

12. It is worth while to illustrate this by the instance of the well-known theorem of the radical centre of three circles. The theorem is that, given any three circles A, B, C (fig. 51), the common chords $aa', bb', \gamma\gamma'$ of the three pairs of circles meet in a point.

The geometrical proof is metrical throughout:—

Take O the point of intersection of aa', bb' , and joining this with γ' , suppose that $\gamma'O$ does not pass through γ , but that it meets the circles A, B in two distinct points γ_1, γ_2 respectively. We have then the known metrical property of intersecting chords of a circle; viz. in circle C , where aa', bb' are chords meeting at a point O ,

$$Oa.Oa' = Ob.Ob',$$

where, as well as in what immediately follows, $Oa, \&c.$, denote, of course, lengths or distances.

Similarly in circle A ,

$$O\beta.O\beta' = O\gamma_1.O\gamma_1',$$

and in circle B ,

$$O\gamma_2.O\gamma_2' = O\gamma_1.O\gamma_1',$$

Consequently $O\gamma_1.O\gamma_1' = O\gamma_2.O\gamma_2'$, that is, $O\gamma_1 = O\gamma_2$, or the points γ_1 and γ_2 coincide; that is, they each coincide with γ .

We contrast this with the analytical method:—

Here it only requires to be known that an equation $Ax+By+C=0$ represents a line, and an equation $x^2+y^2+Ax+By+C=0$ represents a circle. A, B, C have, in the two cases respectively, metrical significations; but these we are not concerned with. Using S to denote the function $x^2+y^2+Ax+By+C$, the equation of a circle is $S=0$. Let the equation of any other circle be $S' = x^2+y^2+A'x+B'y+C'=0$; the equation $S-S'=0$ is a linear equation $(A-A')x+(B-B')y+(C-C')=0$, and it thus represents a line; this equation is satisfied by the coordinates of each of the points of intersection of the two circles (for at each of these points $S=0$ and $S'=0$, therefore also $S-S'=0$); hence the equation $S-S'=0$ is that of the line joining the two points of intersection of the two circles, or say it is the equation of the common chord of the two circles. Considering then a third circle $S'' = x^2+y^2+A''x+B''y+C''=0$, the equations of the common chords are $S-S'=0, S-S''=0, S'-S''=0$ (each of these a linear equation); at the intersection of the first and second of these lines $S=S'$ and $S=S''$, therefore also $S'=S''$, or the equation of the third line is satisfied by the coordinates of the point in question; that is, the three chords intersect in a point O , the coordinates of which are determined by the equations $S=S', S=S''$.

It further appears that if the two circles $S=0, S'=0$ do not intersect in any real points, they must be regarded as intersecting in two imaginary points, such that the line joining them is the real line represented by the equation $S-S'=0$; or that two circles, whether their intersections be real or imaginary, have always a real common chord (or radical axis), and that for any three circles the common chords intersect in a point (of course real) which is the radical centre. And by this very theorem, given two circles with imaginary inter-

sections, we can, by drawing circles which meet each of them in real points, construct the radical axis of the first-mentioned two circles.

13. The principle employed in showing that the equation of the common chord of two circles is $S-S'=0$ is one of very extensive application, and some more illustrations of it may be given.

Suppose $S=0, S'=0$ are lines (that is, let S, S' now denote linear functions $Ax+By+C, A'x+B'y+C'$), then $S-kS'=0$ (k an arbitrary constant) is the equation of any line passing through the point of intersection of the two given lines. Such a line may be made to pass through any given point, say the point (x_0, y_0) ; i.e. if S_0, S'_0 are what S, S' respectively become on writing for (x, y) the values (x_0, y_0) , then the value of k is $k=S_0/S'_0$. The equation in fact is $SS'_0-S_0S'=0$; and starting from this equation we at once verify it a posteriori; the equation is a linear equation satisfied by the values of (x, y) which make $S=0, S'=0$; and satisfied also by the values (x_0, y_0) ; and it is thus the equation of the line in question.

If, as before, $S=0, S'=0$ represent circles, then (k being arbitrary) $S-kS'=0$ is the equation of any circle passing through the two points of intersection of the two circles; and to make this pass through a given point (x_0, y_0) we have again $k=S_0/S'_0$. In the particular case $k=1$, the circle becomes the common chord (more accurately it becomes the common chord together with the line infinity; see § 23 below).

If S denote the general quadric function,

$$S = ax^2 + 2hxy + by^2 + 2gx + 2fy + c,$$

then the equation $S=0$ represents a conic; assuming this; then, if S' is another conic, the equation $S-kS'=0$ represents any conic through the four points of intersection of the two conics.

14. The object still being to illustrate the mode of working with coordinates for descriptive purposes, we consider the theorem of the polar of a point in regard to a circle. Given a circle and a point O (fig. 52), we draw through O any two lines meeting the circle in the points A, A' and B, B' respectively, and then taking Q as the intersection of the lines AB' and $A'B$, the theorem is that the locus of the point Q is a right line depending only upon O and the circle, but independent of the particular lines OAA' and OBB' .

14. The object still being to illustrate the mode of working with coordinates for descriptive purposes, we consider the theorem of the polar of a point in regard to a circle. Given a circle and a point O (fig. 52), we draw through O any two lines meeting the circle in the points A, A' and B, B' respectively, and then taking Q as the intersection of the lines AB' and $A'B$, the theorem is that the locus of the point Q is a right line depending only upon O and the circle, but independent of the particular lines OAA' and OBB' .

Taking O as the origin, and for the axes any two lines through O at right angles to each other, the equation of the circle will be

$$x^2 + y^2 + 2Ax + 2By + C = 0;$$

and if the equation of the line OAA' is taken to be $y=mx$, then the points A, A' are found as the intersections of the straight line with the circle; or to determine x we have

$$x^2(1+m^2) + 2x(A+Bm) + C = 0.$$

If (x_1, y_1) are the coordinates of A , and (x_2, y_2) of A' , then the roots of this equation are x_1, x_2 , whence easily

$$\frac{1}{x_1} + \frac{1}{x_2} = -2 \frac{A+Bm}{C}.$$

And similarly, if the equation of the line OBB' is taken to be $y=m'x$, and the coordinates of B, B' to be (x_3, y_3) and (x_4, y_4) respectively, then

$$\frac{1}{x_3} + \frac{1}{x_4} = -2 \frac{A+Bm'}{C}.$$

We have then by § 8

$$\begin{aligned} x(y_1 - y_2) - y(x_1 - x_2) + x_1y_2 - x_2y_1 &= 0, \\ x(y_3 - y_4) - y(x_3 - x_4) + x_3y_4 - x_4y_3 &= 0, \end{aligned}$$

as the equations of the lines AB' and $A'B$ respectively. Reducing by means of the relations $y_1 - mx_1 = 0, y_2 - mx_2 = 0, y_3 - m'x_3 = 0, y_4 - m'x_4 = 0$, the two equations become

$$\begin{aligned} x(mx_1 - m'x_2) - y(x_1 - x_2) + (m' - m)x_1x_2 &= 0, \\ x(mx_3 - m'x_4) - y(x_3 - x_4) + (m' - m)x_3x_4 &= 0, \end{aligned}$$

and if we divide the first of these equations by x_1x_2 , and the second by x_3x_4 , and then add, we obtain

$$x \left\{ m \left(\frac{1}{x_1} + \frac{1}{x_2} \right) - m' \left(\frac{1}{x_3} + \frac{1}{x_4} \right) \right\} - y \left\{ \frac{1}{x_1} + \frac{1}{x_2} - \left(\frac{1}{x_3} + \frac{1}{x_4} \right) \right\} + 2m' - 2m = 0,$$

or, what is the same thing,

$$\left(\frac{1}{x_1} + \frac{1}{x_2} \right) (y - m'x) - \left(\frac{1}{x_3} + \frac{1}{x_4} \right) (y - mx) + 2m' - 2m = 0,$$

which by what precedes is the equation of a line through the point Q .

Substituting herein for $\frac{1}{x_1} + \frac{1}{x_2}, \frac{1}{x_3} + \frac{1}{x_4}$ their foregoing values, the equation becomes

$$-(A+Bm)(y-m'x) + (A+Bm')(y-mx) + C(m'-m) = 0;$$

that is,

$$(m-m')(Ax+By+C) = 0;$$

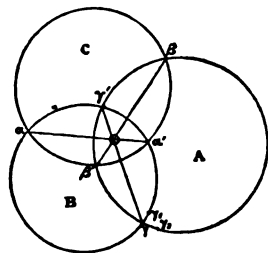

FIG. 51.

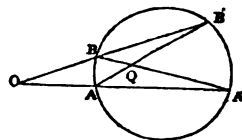

FIG. 52.

or finally it is $Ax + By + C = 0$, showing that the point Q lies in a line the position of which is independent of the particular lines OAA' , $OB'B'$ used in the construction. It is proper to notice that there is no correspondence to each other of the points A , A' and B , B' ; the grouping might as well have been A , A' and B' , B ; and it thence appears that the line $Ax + By + C = 0$ just obtained is in fact the line joining the point Q with the point R which is the intersection of AB and $A'B'$.

15. In § 8 it has been seen that two conditions determine the equation of a straight line, because in $Ax + By + C = 0$ one of the coefficients may be divided out, leaving only two parameters to be determined. Similarly five conditions instead of six determine an equation of the second degree (a, b, c, f, g, h) $(x, y, z)^2 = 0$, and nine instead of ten determine a cubic $(*) (x, y, z)^3 = 0$. It thus appears that a cubic can be made to pass through 9 given points, and that the cubic so passing through 9 given points is completely determined. There is, however, a remarkable exception. Considering two given cubic curves $S = 0$, $S' = 0$, these intersect in 9 points, and through these 9 points we have the whole series of cubics $S - kS' = 0$, where k is an arbitrary constant: k may be determined so that the cubic shall pass through a given tenth point ($k = S_0 - S'_0$, if the coordinates are (x_0, y_0)), and S_0, S'_0 denote the corresponding values of S, S'). The resulting curve $S - kS' = 0$ may be regarded as the cubic determined by the conditions of passing through 8 of the 9 points and through the given point (x_0, y_0) ; and from the equation it thence appears that the curve passes through the remaining one of the 9 points. In other words, we thus have the theorem, any cubic curve which passes through 8 of the 9 intersections of two given cubic curves passes through the 9th intersection.

The applications of this theorem are very numerous; for instance, we derive from it Pascal's theorem of the inscribed hexagon. Consider a hexagon inscribed in a conic. The three alternate sides constitute a cubic, and the other three alternate sides another cubic. The cubics intersect in 9 points, being the 6 vertices of the hexagon, and the 3 Pascalian points, or intersections of the pairs of opposite sides of the hexagon. Drawing a line through two of the Pascalian points, the conic and this line constitute a cubic passing through 8 of the 9 points of intersection, and it therefore passes through the remaining point of intersection—that is, the third Pascalian point; and since obviously this does not lie on the conic, it must lie on the line—that is, we have the theorem that the three Pascalian points (or points of intersection of the pairs of opposite sides) lie on a line.

16. *Metric Theory resumed. Projections and Perpendiculars.*—It is a metrical fact of fundamental importance, already used in § 8, that, if a finite line PQ be projected on any other line OO' by perpendiculars PP', QQ' to OO' , the length of the projection $P'Q'$ is equal to that of PQ multiplied by the cosine of the acute angle between the two lines. Also the algebraical sum of the projections of the sides of any closed polygon upon any line is zero, because as a point goes round the polygon, from any vertex A to A again, the point which is its projection on the line passes from A' the projection of A to A' again, i.e. traverses equal distances along the line in positive and negative senses. If we consider the polygon as consisting of two broken lines, each extending from the same initial to the same terminal point, the sum of the projections of the lines which compose the one is equal, in sign and magnitude, to the sum of the projections of the lines composing the other. Observe that the projection on a line of a length perpendicular to the line is zero.

Let us hence find the equation of a straight line such that the perpendicular OD on it from the origin is of length p taken as positive, and is inclined to the axis of x at an angle $xOD = \alpha$, measured counter-clockwise from Ox . Take any point $P(x, y)$ on the line, and construct OM and MP as in fig. 48. The sum of the projections of OM and MP on OD is OD itself; and this gives the equation of the line

$$x \cos \alpha + y \sin \alpha = p.$$

Observe that $\cos \alpha$ and $\sin \alpha$ here are the $\sin \alpha$ and $-\cos \alpha$, or the $-\sin \alpha$ and $\cos \alpha$ of § 8 according to circumstances.

We can write down an expression for the perpendicular distance from this line of any point (x', y') which does not lie upon it. If the parallel through (x', y') to the line meet OD in E , we have $x' \cos \alpha + y' \sin \alpha = OE$, and the perpendicular distance required is $OD - OE$, i.e. $p - x' \cos \alpha - y' \sin \alpha$; it is the perpendicular distance taken positively or negatively according as (x', y') lies on the same side of the line as the origin or not.

The general equation $Ax + By + C = 0$ may be given the form $x \cos \alpha + y \sin \alpha - p = 0$ by dividing it by $\sqrt{A^2 + B^2}$. Thus $(Ax + By + C) / \sqrt{A^2 + B^2}$ is in absolute value the perpendicular distance of (x', y') from the line $Ax + By + C = 0$. Remember, however, that there is an essential ambiguity of sign attached to a square root. The expression found gives the distance taken positively when (x', y') is on the origin side of the line, if the sign of C is given to $\sqrt{A^2 + B^2}$.

17. *Transformation of Coordinates.*—We often need to adopt new axes of reference in place of old ones; and the above principle of projections readily expresses the old coordinates of any point in terms of the new.

Suppose, for instance, that we want to take for new origin the point O' of old coordinates $OA = h$, $AO' = k$, and for new axes of X and Y lines through O' obtained by rotating parallels to the old axes of x and y through an angle θ counter-clockwise. Construct

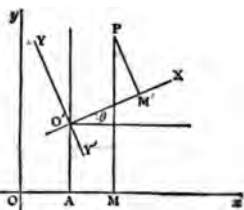

FIG. 53.

and

$$y = k + X \cos(\frac{1}{2}\pi - \theta) + Y \cos \theta = k + X \sin \theta - Y \sin \theta,$$

and

$$x = h + X \cos \theta + Y \cos(\theta + \frac{1}{2}\pi) = h + X \cos \theta - Y \sin \theta,$$

and

$$y = k + X \cos(\frac{1}{2}\pi - \theta) + Y \cos \theta = k + X \sin \theta - Y \sin \theta.$$

Be careful to observe that these

formulae do not apply to every conceivable change of reference from one set of rectangular axes to another. It might have been required to take $O'X, O'Y'$ for the positive directions of the new axes, so that the change of directions of the axes could not be effected by rotation. We must then write $-Y$ for Y in the above.

Were the new axes oblique, making angles α, β respectively with the old axis of x , and so inclined at the angle $\beta - \alpha$, the same method would give the formulae

$$x = h + X \cos \alpha + Y \cos \beta, \quad y = k + X \sin \alpha + Y \sin \beta.$$

18. *The Conic Sections.*—The conics, as they are now called, were at first defined as curves of intersection of planes and a cone; but Apollonius substituted a definition free from reference to space of three dimensions. This, in effect, is that a conic is the locus of a point the distance of which from a given point, called the focus, has a given ratio to its distance from a given line, called the directrix (see CONIC SECTION). If $e : 1$ is the ratio, e is called the eccentricity. The distances are considered signless.

Take (h, k) for the focus, and $x \cos \alpha + y \sin \alpha - p = 0$ for the directrix. The absolute values of $\sqrt{(x-h)^2 + (y-k)^2}$ and $p - x \cos \alpha - y \sin \alpha$ are to have the ratio $e : 1$; and this gives

$$(x-h)^2 + (y-k)^2 = e^2(p - x \cos \alpha - y \sin \alpha)^2$$

as the general equation, in rectangular coordinates, of a conic.

It is of the second degree, and is the general equation of that degree. If, in fact, we multiply it by an unknown λ , we can, by solving six simultaneous equations in the six unknowns $\lambda, h, k, e, p, \alpha$, so choose values for these as to make the coefficients in the equation equal to those in any equation of the second degree which may be given. There is no failure of this statement in the special case when the given equation represents two straight lines, as in § 10, but there is speciality: if the two lines intersect, the intersection and either bisector of the angle between them are a focus and directrix; if they are united in one line, any point on the line and a perpendicular to it through the point are; if they are parallel, the case is a limiting one in which e and $M^2 + K^2$ have become infinite while $e^2(M^2 + K^2)$ remains finite. In the case (§ 9) of an equation such as represents a circle there is another instance of proceeding to a limit: e has to become 0, while ep remains finite: moreover α is indeterminate. The centre of a circle is its focus, and its directrix has gone to infinity, having no special direction. This last fact illustrates the necessity, which is also forced on plane geometry by three-dimensional considerations, of treating all points at infinity in a plane as lying on a single straight line.

Sometimes, in reducing an equation to the above focus and directrix form, we find for $h, k, e, p, \tan \alpha$, or some of them, only imaginary values, as quadratic equations have to be solved; and we have in fact to contemplate the existence of entirely imaginary conics. For instance, no real values of x and y satisfy $x^2 + 2y^2 + 3 = 0$. Even when the locus represented is real, we obtain, as a rule, four sets of values of h, k, e, p, α , of which two sets are imaginary; a real conic has, besides two real foci and corresponding directrices, two others that are imaginary.

In oblique as well as rectangular coordinates equations of the second degree represent conics.

19. *The three Species of Conics.*—A real conic, which does not degenerate into straight lines, is called an ellipse, parabola or hyperbola according as $e < 1$, $e = 1$, or $e > 1$. To trace the three forms it is best so to choose the axes of reference as to simplify their equations.

In the case of a parabola, let $2c$ be the distance between the given focus and directrix, and take axes referred to which these are the point $(c, 0)$ and the line $x = -c$. The equation becomes $(x-c)^2 + y^2 = (x+c)^2$, i.e. $y^2 = 4cx$.

In the other cases, take a such that $a(e - e^{-1})$ is the distance of focus from directrix, and so choose axes that these are $(ae, 0)$ and $x = ae^{-1}$, thus getting the equation $(x-ae)^2 + y^2 = e^2(x-ae^{-1})^2$, i.e. $(1-e^2)x^2 + y^2 = a^2(1-e^2)$. When $e < 1$, i.e. in the case of an ellipse, this may be written $x^2/a^2 + y^2/b^2 = 1$, where $b^2 = a^2(1-e^2)$; and when $e > 1$, i.e. in the case of a hyperbola, $x^2/a^2 - y^2/b^2 = 1$, where $b^2 = a^2(e^2 - 1)$.

The axes thus chosen for the ellipse and hyperbola are called the principal axes.

In figs. 54, 55, 56 in order, conics of the three species, thus referred, are depicted.

The oblique straight lines in fig. 56 are the asymptotes $x/a = \pm y/b$ of the hyperbola, lines to which the curve tends with unlimited

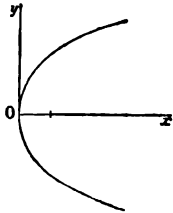

FIG. 54.

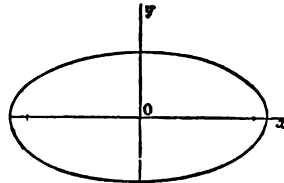

FIG. 55.

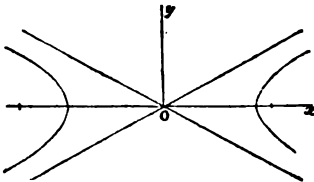

FIG. 56.

closeness as it goes to infinity. The hyperbola would have an equation of the form $xy = c$ if referred to its asymptotes as axes, the coordinates being then oblique, unless $a = b$, in which case the hyperbola is called rectangular. An ellipse has two imaginary asymptotes. In particular a circle $x^2 + y^2 = a^2$, a particular ellipse, has for asymptotes the imaginary lines $x = \pm y\sqrt{-1}$. These run from the centre to the so-called circular points in infinity.

20. *Tangents and Curvature.*—Let (x, y) and $(x+h, y+k)$ be two neighbouring points P, P' on a curve. The equation of the line on which both lie is $h(y-y') = k(x-x')$. Now keep P fixed, and let P' move towards coincidence with it along the curve. The connecting line will tend towards a limiting position, to which it can never attain as long as P and P' are distinct. The line which occupies this limiting position is the *tangent* at P . Now if we subtract the equation of the curve, with (x', y') for the coordinates in it, from the like equation in $(x+h, y+k)$, we obtain a relation in h and k , which will, as a rule, be of the form $Ah + Bk +$ terms of higher degrees in h and k , where A, B and the other coefficients involve x' and y' . This gives $k/h = -A/B +$ terms which tend to vanish as h and k do, so that $-A/B$ is the limiting value tended to by k/h . Hence the equation of the tangent is $B(y-y') + A(x-x') = 0$.

The *normal* at (x', y') is the line through it at right angles to the tangent, and its equation is $A(y-y') - B(x-x') = 0$.

In the case of the conic (a, b, c, f, g, h, k) $(x, y, 1)^2 = 0$ we find that $A/B = (ax' + by' + c)/(hx' + ky' + f)$.

We can obtain the coordinates of Q , the intersection of the normals QP, QP' at (x', y') and $(x'+h, y'+k)$, and then, using the limiting value of k/h , deduce those of its limiting position as P' moves up to P . This is the *centre of curvature* of the curve at $P(x', y')$, and is so called because it is the centre of the circle of closest contact with the curve at that point. That it is so follows from the facts that the closest circle is the limit tended to by the circle which touches the curve at P and passes through P' , and that the arc from P to P' of this circle lies between the circles of centre Q and radii QP, QP' , which circles tend, not to different limits as P' moves up to P , but to one. The distance from P to the centre of curvature is the *radius of curvature*.

21. *Differential Plane Geometry.*—The language and notation of the differential calculus are very useful in the study of tangents and curvature. Denoting by (ξ, η) the current coordinates, we find, as above, that the tangent at a point (x, y) of a curve is $\eta - y = (\xi - x)dy/dx$, where dy/dx is found from the equation of the curve. If this be $f(x, y) = 0$ the tangent is $(\xi - x)(\partial f/\partial x) + (\eta - y)(\partial f/\partial y) = 0$. If ρ and (a, β) are the radius and centre of curvature at (x, y) , we find that $\rho(a-x) = -(1+p^2).q(\beta-y) = 1+p^2.q^2/(1+p^2)^{3/2}$, where p, q denote $dy/dx, d^2y/dx^2$ respectively. (See INFINITESIMAL CALCULUS.)

In any given case we can, at all events in theory, eliminate x, y between the above equations for $a-x$ and $\beta-y$, and the equation of the curve. The resulting equation in (a, β) represents the locus of the centre of curvature. This is the *evolute* of the curve.

22. *Polar Coordinates.*—In plane geometry the distance of any point P from a fixed origin (or pole) O , and the inclination θ of OP

to a fixed line Ox , determine the point: r , the numerical measure of OP , the *radius vector*, and θ , the circular measure of $\angle xOP$, the *inclination*, are called polar coordinates of P . The formulae $x = r \cos \theta, y = r \sin \theta$ connect Cartesian and polar coordinates, and make transition from either system to the other easy. In polar coordinates the equations of a circle through O , and of a conic with O as focus, take the simple forms $r = 2a \cos(\theta - \alpha), r(1 - e \cos(\theta - \alpha)) = l$. The use of polar coordinates is very convenient in discussing curves which have properties of symmetry akin to that of a regular polygon, such curves for instance as $r = a \cos m\theta$, with m integral, and also the curves called spirals, which have equations giving r as functions of θ itself, and not merely of $\sin \theta$ and $\cos \theta$. In the geometry of motion under central forces the advantage of working with polar coordinates is great.

23. *Trilinear and Areal Coordinates.*—Consider a fixed triangle ABC , and regard its sides as produced without limit. Denote, as in trigonometry, by a, b, c the positive numbers of units of a chosen scale contained in the lengths BC, CA, AB , by A, B, C the angles, and by Δ the area, of the triangle. We might, as in § 6, take CA, CB as axes of x and y , inclined at an angle C . Any point $P(x, y)$ in the plane is at perpendicular distances $y \sin C$ and $x \sin C$ from CA and CB . Call these β and α respectively. The signs of β and α are those of y and x , i.e. β is positive or negative according as P lies on the same side of CA as B does or the opposite, and similarly for α . An equation in (x, y) of any degree may, upon replacing in it x and y by $\alpha \csc C$ and $\beta \csc C$, be written as one of the same degree in (α, β) . Now let γ be the perpendicular distance of P from the third side AB , taken as positive or negative as P is on the C side of AB or not. The geometry of the figure tells us that $a\alpha + b\beta + c\gamma = 2\Delta$. By means of this relation in α, β, γ we can give an equation considered countless other forms, involving two or all of α, β, γ . In particular we may make it *homogeneous* in α, β, γ : to do this we have only to multiply the terms of every degree less than the highest present in the equation by a power of $(a\alpha + b\beta + c\gamma)/2\Delta$ just sufficient to raise them, in each case, to the highest degree.

We call (α, β, γ) *trilinear coordinates*, and an equation in them the *trilinear equation* of the locus represented. Trilinear equations are, as a rule, dealt with in their homogeneous forms. An advantage thus gained is that we need not mean by (α, β, γ) the actual measures of the perpendicular distances, but any properly signed numbers which have the same ratio two and two as these distances.

In place of α, β, γ it is lawful to use, as coordinates specifying the position of a point in the plane of a triangle of reference ABC , any three multiples of these. For instance, we may use $x = a\alpha/2\Delta, y = b\beta/2\Delta, z = c\gamma/2\Delta$, the properly signed ratios of the triangular areas PBC, PCA, PAB to the triangular area ABC . These are called the *areal coordinates* of P . In areal coordinates the relation which enables us to make any equation homogeneous takes the simple form $x+y+z=1$; and, as before, we need mean by x, y, z , in a homogeneous equation, only signed numbers in the right ratios.

Straight lines and conics are represented in trilinear and in areal, because in Cartesian, coordinates by equations of the first and second degrees respectively, and these degrees are preserved when the equations are made homogeneous. What must be said about points infinitely far off in order to make universal the statement, to which there is no exception as long as finite distances alone are considered, that every homogeneous equation of the first degree represents a straight line? Let the point of areal coordinates (x', y', z') move infinitely far off, and mean by x, y, z finite quantities in the ratios which x', y', z' tend to assume as they become infinite. The relation $x'+y'+z'=1$ gives that the limiting state of things tended to is expressed by $x+y+z=0$. This particular equation of the first degree is satisfied by no point at a finite distance; but we see the propriety of saying that it has to be taken as satisfied by all the points conceived of as actually at infinity. Accordingly the special property of these points is expressed by saying that they lie on a special straight line, of which the areal equation is $x+y+z=0$. In trilinear coordinates this line at infinity has for equation $a\alpha + b\beta + c\gamma = 0$.

On the one special line at infinity parallel lines are treated as meeting. There are on it two special (imaginary) points, the circular points at infinity of § 19, through which all circles pass in the same sense. In fact if $S=0$ be one circle, in areal coordinates, $S+(x+y+z)(lx+my+nz)=0$ may, by proper choice of l, m, n , be made any other; since the added terms are once $lx+my+nz$, and have the generality of any expression like $a^2x+bb^2y+c^2z$ in Cartesian coordinates. Now these two circles intersect in the two points where either meets $x+y+z=0$ as well as in two points on the radical axis $lx+my+nz=0$.

24. Let us consider the perpendicular distance of a point $(\alpha', \beta', \gamma')$ from a line $l\alpha + m\beta + n\gamma = 0$. We can take rectangular axes of Cartesian coordinates (for clearness as to equalities of angle it is best to choose an origin inside ABC), and refer to them, by putting expressions $p-x \cos \theta - y \sin \theta$, &c., for a, b, c ; we can then apply § 16 to get the perpendicular distance; and finally revert to the trilinear notation. The result is to find that the required distance is

$(l\alpha' + m\beta' + n\gamma')/\sqrt{l^2 + m^2 + n^2}$, where l, m, n are $a^2 + b^2 + c^2 - 2bc \cos A - 2ca \cos B - 2ab \cos C$. In areal coordinates the perpendicular distance from (x', y', z')

to $lx+my+nz=0$ is $2\Delta(lx'+my'+nz')/|al, bm, cn|$. In both cases the coordinates are of course actual values.

Now let ξ, η, ζ be the perpendiculars on the line from the vertices A, B, C , i.e. the points $(1, 0, 0)$, $(0, 1, 0)$, $(0, 0, 1)$, with signs in accord with a convention that oppositeness of sign implies distinction between one side of the line and the other. Three applications of the result above give

$$\xi/l = 2\Delta/|al, bm, cn| = \eta/m = \zeta/n;$$

and we thus have the important fact that $\xi x' + \eta y' + \zeta z'$ is the perpendicular distance between a point of areal coordinates $(x'y'z')$ and a line on which the perpendiculars from A, B, C are ξ, η, ζ respectively. We have also that $\xi x' + \eta y' + \zeta z' = 0$ is the areal equation of the line on which the perpendiculars are ξ, η, ζ ; and, by equating the two expressions for the perpendiculars from (x', y', z') on the line, that in all cases $|\xi, \eta, \zeta|^2 = 4\Delta^2$.

25. *Line-coordinates. Duality.*—A quite different order of ideas may be followed in applying analysis to geometry. The notion of a straight line specified may precede that of a point, and points may be dealt with as the intersections of lines. The specification of a line may be by means of coordinates, and that of a point by an equation, satisfied by the coordinates of lines which pass through it. Systems of *line-coordinates* will here be only briefly considered. Every such system is allied to some system of point-coordinates; and space will be saved by giving prominence to this fact, and not recommencing *ab initio*.

Suppose that any particular system of point-coordinates, in which $lx+my+nz=0$ may represent any straight line, is before us; notice that not only are trilinear and areal coordinates such systems, but Cartesian coordinates also, since we may write $x/s, y/s$ for the Cartesian x, y , and multiply through by s . The line is exactly assigned if l, m, n , or their mutual ratios, are known. Call (l, m, n) the *coordinates* of the line. Now keep x, y, z constant, and let the coordinates of the line vary, but always so as to satisfy the equation. This equation, which we now write $xl+ym+zn=0$, is satisfied by the coordinates of every line through a certain fixed point, and by those of no other line; it is the equation of that point in the line-coordinates l, m, n .

Line-coordinates are also called *tangential* coordinates. A curve is the envelope of lines which touch it, as well as the locus of points which lie on it. A homogeneous equation of degree above the first in l, m, n is a relation connecting the coordinates of every line which touches some curve, and represents that curve, regarded as an envelope. For instance, the condition that the line of coordinates (l, m, n) , i.e. the line of which the allied point-coordinate equation is $lx+my+nz=0$, may touch a conic $(a, b, c, f, g, h)(x, y, z)^2=0$, is readily found to be of the form $(A, B, C, F, G, H)(l, m, n)^2=0$, i.e. to be of the second degree in the line-coordinates. It is not hard to show that the *general* equation of the second degree in l, m, n thus represents a conic; but the degenerate conics of line-coordinates are not line-pairs, as in point-coordinates, but point-pairs.

The degree of the point-coordinate equation of a curve is the *order* of the curve, the number of points in which it cuts a straight line. That of the line-coordinate equation is its *class*, the number of tangents to it from a point. The order and class of a curve are generally different when either exceeds two.

26. The system of line-coordinates allied to the areal system of point-coordinates has special interest.

The l, m, n of this system are the perpendiculars ξ, η, ζ of § 24; and $\xi x' + \eta y' + \zeta z' = 0$ is the equation of the point of areal coordinates (x', y', z') , i.e. is a relation which the perpendiculars from the vertices of the triangle of reference on every line through the point, but no other line, satisfy. Notice that a non-homogeneous equation of the first degree in ξ, η, ζ does not, as a homogeneous one does, represent a point, but a circle. In fact $\xi x' + \eta y' + \zeta z' = R$ expresses the constancy of the perpendicular distance of the fixed point $x'x'+y'y'+z'z'=0$ from the variable line (ξ, η, ζ) , i.e. the fact that (ξ, η, ζ) touches a circle with the fixed point for centre. The relation in any ξ, η, ζ which enables us to make an equation homogeneous is not linear, as in point-coordinates, but quadratic, viz. it is the relation $|\xi, \eta, \zeta|^2 = 4\Delta^2$ of § 24. Accordingly the homogeneous equation of the above circle is

$$4\Delta^2(\xi^2 + \eta^2 + \zeta^2) = R^2|\xi, \eta, \zeta|^2.$$

Every circle has an equation of this form in the present system of line-coordinates. Notice that the equation of any circle is satisfied by those coordinates of lines which satisfy both $\xi x' + \eta y' + \zeta z' = 0$, the equation of its centre, and $|\xi, \eta, \zeta|^2 = 0$. This last equation, of which the left-hand side satisfies the condition for breaking up into two factors, represents the two imaginary circular points at infinity, through which all circles and their asymptotes pass.

There is strict duality in descriptive geometry between point-line-locus and line-point-envelope theorems. But in metrical geometry duality is encumbered by the fact that there is in a plane one special line only, associated with distance, while of special points, associated with direction, there are two: moreover the line is real, and the points both imaginary.

II. Solid Analytical Geometry.

27. Any point in space may be specified by three coordinates. We consider three fixed planes of reference, and generally, as in all

that follows, three which are at right angles two and two. They intersect, two and two, in lines $x'Ox, y'Oy, z'Oz$, called the axes of x, y, z respectively, and divide all space into eight parts called octants. If from any point P in space we draw PN parallel to $z'Oz$ to meet the plane $x'Oy$ in N , and then from N draw NM parallel

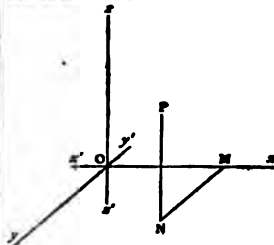

FIG. 57.

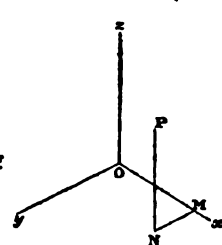

FIG. 58.

to $y'Oy$ to meet $x'Ox$ in M , the coordinates (x, y, z) of P are the numerical measures of OM, MN, NP ; in the case of rectangular coordinates these are the perpendicular distances of P from the three planes of reference. The sign of each coordinate is positive or negative as P lies on one side or the other of the corresponding plane. In the octant delineated the signs are taken all positive.

In fig. 57 the delineation is on a plane of the paper taken parallel to the plane $x'Oz$, the points of a solid figure being projected on that plane by parallels to some chosen line through O in the positive octant. Sometimes it is clearer to delineate, as in fig. 58, by projection parallel to that line in the octant which is equally inclined to Ox, Oy, Oz upon a plane of the paper perpendicular to it. It is possible by parallel projection to delineate equal scales along Ox, Oy, Oz by scales having any ratios we like along lines in a plane having any mutual inclinations we like.

For the delineation of a surface of simple form it frequently suffices to delineate the sections by the coordinate planes; and, in particular, when the surface has symmetry about each coordinate

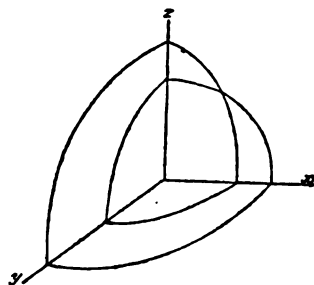

FIG. 59.

plane, each accompanied by its ordinate PN , which serves to refer it to the plane of xy . The employment of stereographic projection is also interesting.

28. In plane geometry, reckoning the line as a curve of the first order, we have only the point and the curve. In solid geometry, reckoning a line as a curve of the first order, and the plane as a surface of the first order, we have the point, the curve and the surface; but the increase of complexity is far greater than would hence at first sight appear. In plane geometry a curve is considered in connexion with lines (its tangents); but in solid geometry the curve is considered in connexion with lines and planes (its tangents and osculating planes), and the surface also in connexion with lines and planes (its tangent lines and tangent planes); there are surfaces arising out of the line—cones, skew surfaces, developables, doubly and triply infinite systems of lines, and whole classes of theories which have nothing analogous to them in plane geometry: it is thus a very small part indeed of the subject which can be even referred to in the present article.

In the case of a surface we have between the coordinates (x, y, z) a single, or say a onefold relation, which can be represented by a single relation $f(x, y, z)=0$; or we may consider the coordinates expressed each of them as a given function of two variable parameters p, q ; the form $s=f(x, y)$ is a particular case of each of these modes of representation; in other words, we have in the first mode $f(x, y, z)=s=f(x, y)$, and in the second mode $x=p, y=q$ for the expression of two of the coordinates in terms of the parameters.

In the case of a curve we have between the coordinates (x, y, z) a twofold relation: the two equations $f(x, y, z) = 0$, $\phi(x, y, z) = 0$ give such a relation; i.e. the curve is here considered as the intersection of two surfaces (but the curve is not always the complete intersection of two surfaces, and there are hence difficulties); or, again, the coordinates may be given each of them as a function of a single variable parameter. The form $y = \phi(x)$, $z = \psi(x)$, where two of the coordinates are given in terms of the third, is a particular case of each of these modes of representation.

29. The remarks under plane geometry as to descriptive and metrical propositions, and as to the non-metrical character of the method of coordinates when used for the proof of a descriptive proposition, apply also to solid geometry; and they might be illustrated in like manner by the instance of the theorem of the radical centre of four spheres. The proof is obtained from the consideration that S and S' being each of them a function of the form $x^2 + y^2 + z^2 + ax + by + cz + d$, the difference $S - S'$ is a mere linear function of the coordinates, and consequently that $S - S' = 0$ is the equation of the plane containing the circle of intersection of the two spheres $S = 0$ and $S' = 0$.

30. *Metrical Theory.*—The foundation in solid geometry of the metrical theory is in fact the before-mentioned theorem that if a finite right line PQ be projected upon any other line OO' by lines perpendicular to OO' , then the length of the projection $P'Q'$ is equal to the length of PQ into the cosine of its inclination to $P'Q'$ —or (in the form in which it is now convenient to state the theorem) the perpendicular distance $P'Q'$ of two parallel planes is equal to the inclined distance PQ into the cosine of the inclination. The principle of § 16, that the algebraical sum of the projections of the sides of any closed polygon on any line is zero, or that the two sets of sides of the polygon which connect a vertex A and a vertex B have the same sum of projections on the line, in sign and magnitude, as we pass from A to B , is applicable when the sides do not all lie in one plane.

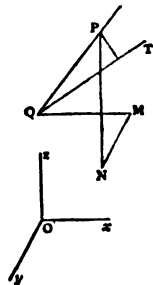

FIG. 60.

let the cosines of the ρ to the three axes be α, β, γ , and let the cosines of the ρ to the three sides and on QP we have

$$\xi, \eta, \zeta = \rho\alpha, \rho\beta, \rho\gamma,$$

and whence $\rho^2 = \xi^2 + \eta^2 + \zeta^2$, which is the relation between a distance ρ and its projections ξ, η, ζ upon three rectangular axes. And from the same equations we obtain $\alpha^2 + \beta^2 + \gamma^2 = 1$, which is a relation connecting the cosine-inclinations of a line to three rectangular axes.

Suppose we have through Q any other line QT , and let the cosine-inclinations of this to the axes be α', β', γ' , and δ be its cosine-inclination to QP ; also let ρ' be the length of the projection of QP upon QT ; then projecting on QT we have

$$\rho = \rho' \delta + \beta' \eta + \gamma' \zeta = \rho\delta.$$

And in the last equation substituting for ξ, η, ζ their values $\rho\alpha, \rho\beta, \rho\gamma$ we find

$$\delta = \alpha\alpha' + \beta\beta' + \gamma\gamma',$$

which is an expression for the mutual cosine-inclination of two lines, the cosine-inclinations of which to the axes are α, β, γ and α', β', γ' respectively. We have of course $\alpha^2 + \beta^2 + \gamma^2 = 1$ and $\alpha'^2 + \beta'^2 + \gamma'^2 = 1$; and hence also

$$1 - \delta^2 = (\alpha^2 + \beta^2 + \gamma^2)(\alpha'^2 + \beta'^2 + \gamma'^2) - (\alpha\alpha' + \beta\beta' + \gamma\gamma')^2, \\ = (\beta\gamma' - \beta'\gamma)^2 + (\gamma\alpha' - \gamma'\alpha)^2 + (\alpha\beta' - \alpha'\beta)^2;$$

so that the sine of the inclination can only be expressed as a square root. These formulae are the foundation of spherical trigonometry.

32. *Straight Lines, Planes and Spheres.*—The foregoing formulae give at once the equations of these loci. For first, taking Q to be a fixed point, coordinates (a, b, c) , and the cosine-inclinations (α, β, γ) to be constant, then P will be a point in the line through Q in the direction thus determined; or, taking (x, y, z) for its coordinates, these will be the current coordinates of a point in the line. The values of ξ, η, ζ then are $x - a, y - b, z - c$, and we thus have

$$\frac{x - a}{\alpha} = \frac{y - b}{\beta} = \frac{z - c}{\gamma} (= \rho),$$

which (omitting the last equation, $= \rho$) are the equations of the line through the point (a, b, c) , the cosine-inclinations to the axes being α, β, γ , and these quantities being connected by the relation $\alpha^2 + \beta^2 + \gamma^2 = 1$. This equation may be omitted, and then α, β, γ , instead of being equal, will only be proportional, to the cosine-inclinations.

Using the last equation, and writing

$$x, y, z = a + \alpha\rho, b + \beta\rho, c + \gamma\rho,$$

these are expressions for the current coordinates in terms of a parameter ρ , which is in fact the distance from the fixed point (a, b, c) .

It is easy to see that, if the coordinates (x, y, z) are connected by any two linear equations, these equations can always be brought into the foregoing form, and hence that the two linear equations represent a line.

Secondly, taking for greater simplicity the point Q to be coincident with the origin, and $\alpha, \beta', \gamma', \rho$ to be constant, then ρ is the perpendicular distance of a plane from the origin, and α', β', γ' are the cosine-inclinations of this distance to the axes ($\alpha'^2 + \beta'^2 + \gamma'^2 = 1$). P is any point in this plane, and taking its coordinates to be (x, y, z) then (ξ, η, ζ) are (x, y, z) , and the foregoing equation $\rho = \alpha'\xi + \beta'\eta + \gamma'\zeta$ becomes

$$\alpha'x + \beta'y + \gamma'z = \rho,$$

which is the equation of the plane in question.

If, more generally, Q is not coincident with the origin, then, taking its coordinates to be (a, b, c) , and writing ρ_1 instead of ρ , the equation is

$$\alpha'(x - a) + \beta'(y - b) + \gamma'(z - c) = \rho_1;$$

and we hence have $\rho_1 = \rho - (\alpha a' + \beta b' + \gamma c')$, which is an expression for the perpendicular distance of the point (a, b, c) from the plane in question.

It is obvious that any linear equation $Ax + By + Cz + D = 0$ between the coordinates can always be brought into the foregoing form, and hence that such an equation represents a plane.

Thirdly, supposing Q to be a fixed point, coordinates (a, b, c) , and the distance $QP = \rho$, and to be constant, say this is $= d$, then, as before, the values of ξ, η, ζ are $x - a, y - b, z - c$, and the equation $\xi^2 + \eta^2 + \zeta^2 = \rho^2$ becomes

$$(x - a)^2 + (y - b)^2 + (z - c)^2 = d^2,$$

which is the equation of the sphere, coordinates of the centre $= (a, b, c)$, and radius $= d$.

A quadric equation wherein the terms of the second order are $x^2 + y^2 + z^2$, viz. an equation

$$x^2 + y^2 + z^2 + Ax + By + Cz + D = 0,$$

can always, it is clear, be brought into the foregoing form; and it thus appears that this is the equation of a sphere, coordinates of the centre $= \frac{1}{2}A, \frac{1}{2}B, \frac{1}{2}C$, and squared radius $= \frac{1}{4}(A^2 + B^2 + C^2) - D$.

33. *Cylinders, Cones, ruled Surfaces.*—If the two equations of a straight line involve a parameter to which any value may be given, we have a singly infinite system of lines. They cover a surface, and the equation of the surface is obtained by eliminating the parameter between the two equations.

If the lines all pass through a given point, then the surface is a cone; and, in particular, if the lines are all parallel to a given line, then the surface is a cylinder.

Beginning with this last case, suppose the lines are parallel to the line $x = ms, y = ns$, the equations of a line of the system are $x = ms + a, y = ns + b$, where a, b are supposed to be functions of the variable parameter, or, what is the same thing, there is between them a relation $f(a, b) = 0$: we have $a = x - ms, b = y - ns$, and the result of the elimination of the parameter therefore is $f(x - ms, y - ns) = 0$, which is thus the general equation of the cylinder the generating lines whereof are parallel to the line $x = ms, y = ns$. The equation of the section by the plane $s = 0$ is $f(x, y) = 0$, and conversely if the cylinder be determined by means of its curve of intersection with the plane $s = 0$, then, taking the equation of this curve to be $f(x, y) = 0$, the equation of the cylinder is $f(x - ms, y - ns) = 0$. Thus, if the curve of intersection be the circle $(x - a)^2 + (y - b)^2 = r^2$, we have $(x - ms - a)^2 + (y - ns - b)^2 = r^2$ as the equation of an oblique cylinder on this base, and thus also $(x - a)^2 + (y - b)^2 = r^2$ as the equation of the right cylinder.

If the lines all pass through a given point (a, b, c) , then the equations of a line are $x - a = a(s - c), y - b = \beta(s - c)$, where α, β are functions of the variable parameter, or, what is the same thing, there exists between them an equation $f(\alpha, \beta) = 0$: the elimination

of the parameter gives, therefore, $f\left(\frac{x - a}{s - c}, \frac{y - b}{s - c}\right) = 0$; and this equation, or, what is the same thing, any homogeneous equation $f(x - a, y - b, s - c) = 0$, or, taking f to be a rational and integral function of the order n , say $(*) (x - a, y - b, s - c)^n = 0$, is the general equation of the cone having the point (a, b, c) for its vertex. Taking the vertex to be at the origin, the equation is $(*) (x, y, z)^n = 0$; and, in particular, $(*) (x, y, z)^2 = 0$ is the equation of a cone of the second order, or quadric cone, having the origin for its vertex.

34. In the general case of a singly infinite system of lines, the locus is a ruled surface (or *regulus*). Now, when a line is changing its position in space, it may be looked upon as in a state of turning about some point in itself, while that point is, as a rule, in a state of moving out of the plane in which the turning takes place. If instantaneously it is only in a state of turning, it is usual, though not strictly accurate, to say that it intersects its consecutive position. A regulus such that consecutive lines on it do not intersect, in this sense, is called a skew surface, or *scroll*; one on which they do is called a developable surface or *torse*.

Suppose, for instance, that the equations of a line (depending on

the variable parameter θ) are $\frac{x}{a} + \frac{y}{b} = \theta(1 + \frac{z}{c})$, $\frac{x}{a} - \frac{y}{b} = \frac{1}{\theta}(1 - \frac{z}{c})$; then, eliminating θ , we have $\frac{x^2}{a^2} - \frac{y^2}{b^2} = 1 - \frac{z^2}{c^2}$ or say $\frac{x^2}{a^2} + \frac{y^2}{b^2} - \frac{z^2}{c^2} = 1$, the equation of a quadric surface, afterwards called the hyperboloid of one sheet; this surface is consequently a scroll. It is to be remarked that we have upon the surface a second singly infinite series of lines; the equations of a line of this second system (depending on the variable parameter ϕ) are

$$\frac{x}{a} + \frac{y}{c} = \phi(1 - \frac{z}{b}), \quad \frac{x}{a} - \frac{y}{c} = \frac{1}{\phi}(1 + \frac{z}{b}).$$

It is easily shown that any line of the one system intersects every line of the other system.

Considering any curve (of double curvature) whatever, the tangent lines of the curve form a singly infinite system of lines, each line intersecting the consecutive line of the system, — that is, they form a developable, or torse; the curve and torse are thus inseparably connected together, forming a single geometrical figure. An osculating plane of the curve (see § 38 below) is a tangent plane of the torse all along a generating line.

35. Transformation of Coordinates.—There is no difficulty in changing the origin, and it is for brevity assumed that the origin remains unaltered. We have, then, two sets of rectangular axes, Ox, Oy, Oz , and Ox_1, Oy_1, Oz_1 , the mutual cosine-inclinations being shown by the diagram—

	x	y	z
x_1	α	β	γ
y_1	α'	β'	γ'
z_1	α''	β''	γ''

that is, α, β, γ are the cosine-inclinations of Ox_1 to Ox, Oy, Oz ; α', β', γ' those of Oy_1 , &c.

And this diagram gives also the linear expressions of the coordinates (x_1, y_1, z_1) or (x, y, z) of either set in terms of those of the other set; we thus have

$$\begin{aligned} x_1 &= \alpha x + \beta y + \gamma z, & x &= \alpha x_1 + \alpha' y_1 + \alpha'' z_1, \\ y_1 &= \alpha' x + \beta' y + \gamma' z, & y &= \beta x_1 + \beta' y_1 + \beta'' z_1, \\ z_1 &= \alpha'' x + \beta'' y + \gamma'' z, & z &= \gamma x_1 + \gamma' y_1 + \gamma'' z_1, \end{aligned}$$

which are obtained by projection, as above explained. Each of these equations is, in fact, nothing else than the before-mentioned equation $p = \alpha'x + \beta'y + \gamma'z$, adapted to the problem in hand.

But we have to consider the relations between the nine coefficients. By what precedes, or by the consideration that we must have identically $x^2 + y^2 + z^2 = x_1^2 + y_1^2 + z_1^2$, it appears that these satisfy the relations—

$$\begin{aligned} \alpha^2 + \beta^2 + \gamma^2 &= 1, & \alpha^2 + \alpha'^2 + \alpha''^2 &= 1, \\ \alpha'^2 + \beta'^2 + \gamma'^2 &= 1, & \beta^2 + \beta'^2 + \beta''^2 &= 1, \\ \alpha''^2 + \beta''^2 + \gamma''^2 &= 1, & \gamma^2 + \gamma'^2 + \gamma''^2 &= 1, \\ \alpha\alpha' + \beta\beta' + \gamma\gamma' &= 0, & \beta\gamma + \beta'\gamma' + \beta''\gamma'' &= 0, \\ \alpha\alpha'' + \beta\beta'' + \gamma\gamma'' &= 0, & \gamma\alpha + \gamma'\alpha' + \gamma''\alpha'' &= 0, \\ \alpha\alpha' + \beta\beta'' + \gamma\gamma'' &= 0, & \alpha\beta + \alpha'\beta' + \alpha''\beta'' &= 0, \end{aligned}$$

either set of six equations being implied in the other set.

It follows that the square of the determinant

$$\begin{vmatrix} \alpha & \beta & \gamma \\ \alpha' & \beta' & \gamma' \\ \alpha'' & \beta'' & \gamma'' \end{vmatrix}$$

is = 1; and hence that the determinant itself is = +1. The distinction of the two cases is an important one: if the determinant is = +1, then the axes Ox_1, Oy_1, Oz_1 are such that they can by a rotation about O be brought to coincide with Ox, Oy, Oz respectively; if it is = -1, then they cannot. But in the latter case, by measuring x_1, y_1, z_1 in the opposite directions we change the signs of all the coefficients and so make the determinant to be = +1, hence the former case need alone be considered, and it is accordingly assumed that the determinant is = +1. This being so, it is found that we have the equality $\alpha = \beta'\gamma' - \beta''\gamma''$, and eight like ones, obtained from this by cyclical interchanges of the letters α, β, γ , and of unaccented, singly and doubly accented letters.

36. The nine cosine-inclinations above are, as has been seen, connected by six equations. It ought then to be possible to express them all in terms of three parameters. An elegant means of doing this has been given by Rodrigues, who has shown that the tabular expression of the formulæ of transformation may be written

	x	y	z
x_1	$1 + \lambda^2 - \mu^2 - \nu^2$	$2(\lambda\mu - \nu)$	$2(\nu\lambda + \mu)$
y_1	$2(\lambda\mu + \nu)$	$1 - \lambda^2 + \mu^2 - \nu^2$	$2(\mu\nu + \lambda)$
z_1	$2(\nu\lambda - \mu)$	$2(\mu\nu + \lambda)$	$1 - \lambda^2 - \mu^2 + \nu^2$

+ $(1 + \lambda^2 + \mu^2 + \nu^2)$,

the meaning being that the coefficients in the transformation are fractions, with numerators expressed as in the table, and the common denominator.

37. The Species of Quadric Surfaces.—Surfaces represented by equations of the second degree are called quadric surfaces. Quadric surfaces are either proper or special. The special ones arise when the coefficients in the general equation are limited to satisfy certain special equations; they comprise (1) plane-pairs, including in particular one plane twice repeated, and (2) cones, including in particular cylindrical; there is but one form of cone, but cylinders may be elliptic, parabolic or hyperbolic.

A discussion of the general equation of the second degree shows that the proper quadric surfaces are of five kinds, represented respectively, when referred to the most convenient axes of reference, by equations of the five types (a and b positive):

- (1) $s = \frac{x^2}{2a} + \frac{y^2}{2b}$, elliptic paraboloid.
- (2) $s = \frac{x^2}{2a} - \frac{y^2}{2b}$, hyperbolic paraboloid.
- (3) $\frac{x^2}{a^2} + \frac{y^2}{b^2} + \frac{z^2}{c^2} = 1$, ellipsoid.
- (4) $\frac{x^2}{a^2} + \frac{y^2}{b^2} - \frac{z^2}{c^2} = 1$, hyperboloid of one sheet.
- (5) $\frac{x^2}{a^2} + \frac{y^2}{b^2} - \frac{z^2}{c^2} = -1$, hyperboloid of two sheets.

It is at once seen that these are distinct surfaces; and the equations also show very readily the general form and mode of generation of the several surfaces.

In the elliptic paraboloid (fig. 61) the sections by the planes of sx and sy are the parabolas

$$s = \frac{x^2}{2a}, s = \frac{y^2}{2b},$$

having the common axes Oz ; and the section by any plane $s = \gamma$ parallel to that of xy is the ellipse

$$\gamma = \frac{x^2}{2a} + \frac{y^2}{2b};$$

so that the surface is generated by a variable ellipse moving parallel to itself along the parabolas as directrices.

In the hyperbolic paraboloid (figs. 62 and 63) the sections by the planes of sx, sy are the parabolas $s = \frac{x^2}{2a}, s = -\frac{y^2}{2b}$, having the opposite axes Ox, Ox' , and the section by a plane $s = \gamma$ parallel to that of xy is the hyperbola $\gamma = \frac{x^2}{2a} - \frac{y^2}{2b}$, which has its transverse axis parallel to Ox or Oy according as γ is positive or negative. The surface is thus

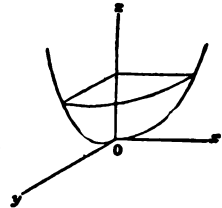

FIG. 61.

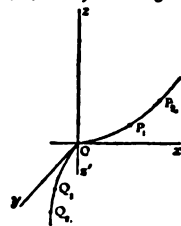

FIG. 62.

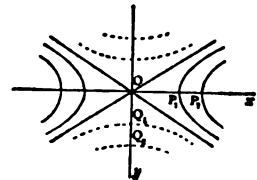

FIG. 63.

generated by a variable hyperbola moving parallel to itself along the parabolas as directrices. The form is best seen from fig. 63, which represents the sections by planes parallel to the plane of xy , or say the contour lines; the continuous lines are the sections above the plane of xy , and the dotted lines the sections below this plane. The form is, in fact, that of a saddle.

In the ellipsoid (fig. 64) the sections by the planes of sx, sy , and sz are each of them an ellipse, and the section by any parallel plane is also an ellipse. The surface may be considered as generated by an ellipse moving parallel to itself along two ellipses as directrices.

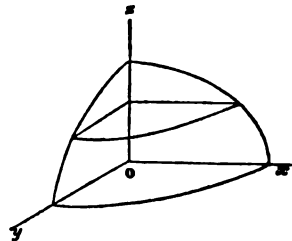

FIG. 64.

In the hyperboloid of one sheet (fig. 65), the sections by the planes of zx , xy are the hyperbolas

$$\frac{x^2}{a^2} - \frac{z^2}{c^2} = 1, \quad \frac{y^2}{b^2} - \frac{z^2}{c^2} = 1,$$

having a common conjugate axis zOz' ; the section by the plane of x, y , and that by any parallel plane, is an ellipse; and the surface may be considered as generated by a variable ellipse moving parallel to itself along the two hyperbolas as directrices. If we imagine two equal and parallel circular disks, their points connected by strings of equal lengths, so that these are the generators of a right circular cylinder, and if we turn one of the disks about its centre through an angle in its plane, the strings in their new positions will be one system of generators of a hyperboloid of one sheet, for which $a=b$; and if we turn it through the same angle in the opposite direction,

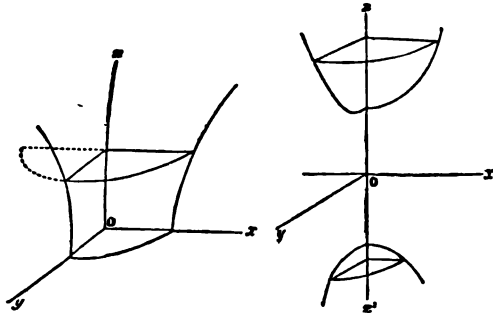

FIG. 65.

FIG. 66.

we get in like manner the generators of the other system; there will be the same general configuration when $a \neq b$. The hyperbolic paraboloid is also covered by two systems of rectilinear generators as a method like that used in § 34 establishes without difficulty. The figures should be studied to see how they can lie.

In the hyperboloid of two sheets (fig. 66) the sections by the planes of zx and xy are the hyperbolas

$$\frac{x^2}{a^2} - \frac{z^2}{c^2} = 1, \quad \frac{y^2}{b^2} - \frac{z^2}{c^2} = 1,$$

having a common transverse axis along zOz' ; the section by any plane $z = \pm \gamma$ parallel to that of xy is the ellipse

$$\frac{x^2}{a^2} + \frac{y^2}{b^2} - \frac{\gamma^2}{c^2} = 1,$$

provided $\gamma^2 > c^2$, and the surface, consisting of two distinct portions or sheets, may be considered as generated by a variable ellipse moving parallel to itself along the hyperbolas as directrices.

38. *Differential Geometry of Curves*.—For convenience consider the coordinates (x, y, z) of a point on a curve in space to be given as functions of a variable parameter θ , which may in particular be one of themselves. Use the notation x', x'' for $dx/d\theta, d^2x/d\theta^2$, and similarly as to y and z . Only a few formulae will be given. Call the current coordinates (ξ, η, ζ) .

The *tangent* at (x, y, z) is the line tended to as a limit by the connector of (x, y, z) and a neighbouring point of the curve when the latter moves up to the former: its equations are

$$(\xi - x)/x' = (\eta - y)/y' = (\zeta - z)/z'.$$

The *osculating plane* at (x, y, z) is the plane tended to as a limit by that through (x, y, z) and two neighbouring points of the curve as these, remaining distinct, both move up to (x, y, z) : its one equation is

$$(\xi - x)(y'z'' - y''z') + (\eta - y)(z'x'' - z''x') + (\zeta - z)(x'y'' - x''y') = 0.$$

The *normal plane* is the plane through (x, y, z) at right angles to the tangent line, i.e. the plane

$$x'(\xi - x) + y'(\eta - y) + z'(\zeta - z) = 0.$$

It cuts the osculating plane in a line called the *principal normal*. Every line through (x, y, z) in the normal plane is a normal. The normal perpendicular to the osculating plane is called the *binormal*. A tangent, principal normal, and binormal are a convenient set of rectangular axes to use as those of reference, when the nature of a curve near a point on it is to be discussed.

Through (x, y, z) and three neighbouring points, all on the curve, passes a single sphere; and as the three points all move up to (x, y, z) continuing distinct, the sphere tends to a limiting size and position. The limit tended to is the sphere of closest contact with the curve at (x, y, z) : its centre and radius are called the *centre* and *radius of spherical curvature*. It cuts the osculating plane in a circle, called the *circle of absolute curvature*; and the centre and radius of this circle are the *centre* and *radius of absolute curvature*. The centre of

absolute curvature is the limiting position of the point where the principal normal at (x, y, z) is cut by the normal plane at a neighbouring point, as that point moves up to (x, y, z) .

39. *Differential Geometry of Surfaces*.—Let (x, y, z) be any chosen point on a surface $f(x, y, z) = 0$. As a second point of the surface moves up to (x, y, z) , its connector with (x, y, z) tends to a limiting position, a tangent line to the surface at (x, y, z) . All these tangent lines at (x, y, z) , obtained by approaching (x, y, z) from different directions on a surface, lie in one plane

$$\frac{\partial f}{\partial x}(\xi - x) + \frac{\partial f}{\partial y}(\eta - y) + \frac{\partial f}{\partial z}(\zeta - z) = 0.$$

This plane is called the *tangent plane* at (x, y, z) . One line through (x, y, z) is at right angles to the tangent plane. This is the *normal*

$$(\xi - x) \frac{\partial f}{\partial x} = (\eta - y) \frac{\partial f}{\partial y} = (\zeta - z) \frac{\partial f}{\partial z}$$

The tangent plane is cut by the surface in a curve, real or imaginary, with a node or double point at (x, y, z) . Two of the tangent lines touch this curve at the node. They are called the "*chief tangents*" (*Haupt-tangenten*) at (x, y, z) ; they have closer contact with the surface than any other tangents.

In the case of a quadric surface the curve of intersection of a tangent and the surface is of the second order and has a node, it must therefore consist of two straight lines. Consequently a quadric surface is covered by two sets of straight lines, a pair through every point on it; these are imaginary for the ellipsoid, hyperboloid of two sheets, and elliptic paraboloid.

A surface of any order is covered by two singly infinite systems of curves, a pair through every point, the tangents to which are all chief tangents at their respective points of contact. These are called *chief-tangent curves*; on a quadric surface they are the above straight lines.

40. The tangents at a point of a surface which bisect the angles between the chief tangents are called the *principal tangents* at the point. They are at right angles, and together with the normal constitute a convenient set of rectangular axes to which to refer the surface when its properties near the point are under discussion. At a special point which is such that the chief tangents there run to the circular points at infinity in the tangent plane, the principal tangents are indeterminate; such a special point is called an *umbilic* of the surface.

There are two singly infinite systems of curves on a surface, a pair cutting one another at right angles through every point upon it, all tangents to which are principal tangents of the surface at their respective points of contact. These are called *lines of curvature*, because of a property next to be mentioned.

As a point Q moves in an arbitrary direction on a surface from coincidence with a chosen point P , the normal at it, as a rule, at once fails to meet the normal at P ; but, if it takes the direction of a line of curvature through P , this is instantaneously not the case.

We have thus on the normal two centres of curvature, and the distances of these from the point on the surface are the two *principal radii of curvature* of the surface at that point; these are also the radii of curvature of the sections of the surface by planes through the normal and the two principal tangents respectively; or say they are the radii of curvature of the normal sections through the two principal tangents respectively. Take at the point the axis of s in the direction of the normal, and those of x and y in the directions of the principal tangents respectively, then, if the radii of curvature be a, b (the signs being such that the coordinates of the two centres of curvature are $s = a$ and $s = b$ respectively), the surface has in the neighbourhood of the point the form of the paraboloid

$$s = \frac{a^2}{2a} + \frac{y^2}{2b},$$

and the chief-tangents are determined by the equation $0 = \frac{x^2}{2a} + \frac{y^2}{2b}$

The two centres of curvature may be on the same side of the point or on opposite sides, in the former case a and b have the same sign, the paraboloid is elliptic, and the chief-tangents are imaginary; in the latter case a and b have opposite signs, the paraboloid is hyperbolic, and the chief-tangents are real.

The normal sections of the surface and the paraboloid by the same plane have the same radius of curvature; and it thence readily follows that the radius of curvature of a normal section of the surface by a plane inclined at an angle θ to that of zx is given by the equation

$$\frac{1}{\rho} = \frac{\cos^2 \theta}{a} + \frac{\sin^2 \theta}{b}.$$

The section in question is that by a plane through the normal and a line in the tangent plane inclined at an angle θ to the principal tangent along the axis of x . To complete the theory, consider the section by a plane having the same trace upon the tangent plane, but inclined to the normal at an angle ϕ ; then it is shown without difficulty (Meunier's theorem) that the radius of curvature of this inclined section of the surface is $\rho \cos \phi$.

AUTHORITIES.—The above article is largely based on that by Arthur Cayley in the 9th edition of this work. Of early and important recent publications on analytical geometry, special mention

is to be made of R. Descartes, *Geométrie* (Leyden, 1637); John Wallis, *Tractatus de sectionibus conicis nova methodo expositis* (1655, *Opera mathematica*, i., Oxford, 1695); de l'Hospital, *Traité analytique des sections coniques* (Paris, 1720); Leonhard Euler, *Introductio in analysin infinitorum*, ii. (Lausanne, 1748); Gaspard Monge, "Application d'algèbre à la géométrie" (*Journ. Ecole Polytech.*, 1801); Julius Plücker, *Analytisch-geometrische Entwicklungen*, 3 Bde. (Essen, 1828-1831); *System der analytischen Geometrie* (Berlin, 1835); G. Salmon, *A Treatise on Conic Sections* (Dublin, 1848; 6th ed., London, 1879); Ch. Briot and J. Bouquet, *Leçons de géométrie analytique* (Paris, 1851; 10th ed., 1897); M. Chasles, *Traité de géométrie supérieure* (Paris, 1852); Wilhelm Fiedler, *Analytische Geometrie der Kegelschnitte nach G. Salmon frei bearbeitet* (Leipzig, 5th Aufl., 1887-1888); N. M. Ferrers, *An Elementary Treatise on Trilinear Coordinates* (London, 1861); Otto Hesse, *Vorlesungen aus der analytischen Geometrie* (Leipzig, 1865, 1881); W. A. Whitworth, *Trilinear Coordinates and other Methods of Modern Analytical Geometry* (Cambridge, 1866); J. Booth, *A Treatise on Some New Geometrical Methods* (London, i., 1873; ii., 1877); A. Clebsch-F. Lindemann, *Vorlesungen über Geometrie*, Bd. i. (Leipzig, 1876, 2te Aufl., 1891); R. Baltzer, *Analytische Geometrie* (Leipzig, 1882); Charlotte A. Scott, *Modern Methods of Analytical Geometry* (London, 1894); G. Salmon, *A Treatise on the Analytical-Geometry of three Dimensions* (Dublin, 3rd ed., 1852; Salmon-Fiedler, *Analytische Geometrie des Raumes* (Leipzig, 1863; 4te Aufl., 1898). P. Front, *Solid Geometry* (London, 3rd ed., 1886; 1st ed., Frost and J. Wolstenholme). See also E. Pascal, *Reperorio di matematiche superiori*, II. *Geometria* (Milan, 1900), and articles now appearing in the *Encyclopædie der mathematischen Wissenschaften*, Bd. iii. 1, 2. (E. B. EL.)

V. LINE GEOMETRY

Line geometry is the name applied to those geometrical investigations in which the straight line replaces the point as element. Just as ordinary geometry deals primarily with points and systems of points, this theory deals in the first instance with straight lines and systems of straight lines. In two dimensions there is no necessity for a special line geometry, inasmuch as the straight line and the point are interchangeable by the principle of duality; but in three dimensions the straight line is its own reciprocal, and for the better discussion of systems of lines we require some new apparatus, e.g., a system of coordinates applicable to straight lines rather than to points. The essential features of the subject are most easily elucidated by analytical methods: we shall therefore begin with the notion of line coordinates, and in order to emphasize the merits of the system of coordinates ultimately adopted, we first notice a system without these advantages, but often useful in special investigations.

In ordinary Cartesian coordinates the two equations of a straight line may be reduced to the form $y = rx + s$, $z = ix + u$, and r, s, i, u may be regarded as the four coordinates of the line. These coordinates lack symmetry: moreover, in changing from one base of reference to another the transformation is not linear, so that the degree of an equation is deprived of real significance. For purposes of the general theory we employ homogeneous coordinates: if x_1, y_1, z_1, w_1 and x_2, y_2, z_2, w_2 are two points on the line, it is easily verified that the six determinants of the array

$$\begin{vmatrix} x_1 & y_1 & z_1 & w_1 \\ x_2 & y_2 & z_2 & w_2 \end{vmatrix}$$

are in the same ratios for all point-pairs on the line, and further, that when the point coordinates undergo a linear transformation so also do these six determinants. We therefore adopt these six determinants for the coordinates of the line, and express them by the symbols $l, \lambda, m, \mu, n, \nu$ where $l = x_1 y_2 - x_2 y_1$, $\lambda = y_1 z_2 - y_2 z_1$, &c. There is the further advantage that if $a_1 b_1 c_1 d_1$ and $a_2 b_2 c_2 d_2$ be two planes through the line, the six determinants

$$\begin{vmatrix} a_1 & b_1 & c_1 & d_1 \\ a_2 & b_2 & c_2 & d_2 \end{vmatrix}$$

are in the same ratios as the foregoing, so that except as regards a factor of proportionality we have $\lambda = b_2 c_1 - b_1 c_2$, $l = c_1 d_2 - c_2 d_1$, &c. The identical relation $\lambda l + m\mu + n\nu = 0$ reduces the number of independent constants in the six coordinates to four, for we are only concerned with their mutual ratios; and the quadratic character of this relation marks an essential difference between point geometry and line geometry. The condition of intersection of two lines is

$$D' + l'\lambda + m'\mu + n'\nu = 0$$

where the accented letters refer to the second line. If the coordinates are Cartesian and l, m, n are direction cosines, the quantity on the left is the mutual moment of the two lines.

Since a line depends on four constants, there are three distinct types of configurations arising in line geometry—those containing a triply-infinite, a doubly-infinite and a singly-infinite number of lines; they

are called Complexes, Congruences, and Ruled Surfaces or Skews respectively. A Complex is thus a system of lines satisfying one condition—that is, the coordinates are connected by a single relation; and the degree of the complex is the degree of this equation supposing it to be algebraic. The lines of a complex of the n th degree which pass through any point lie on a cone of the n th degree, those which lie in any plane envelop a curve of the n th class and there are n lines of the complex in any plane pencil; the last statement combines the former two, for it shows that the cone is of the n th degree and the curve is of the n th class. To find the lines common to four complexes of degrees n_1, n_2, n_3, n_4 , we have to solve five equations, viz. the four complex equations together with the quadratic equation connecting the line coordinates, therefore the number of common lines is $2n_1 n_2 n_3 n_4$. As an example of complexes we have the lines meeting a twisted curve of the n th degree, which form a complex of the n th degree.

A Congruence is the set of lines satisfying two conditions: thus a finite number m of the lines pass through any point, and a finite number n lie in any plane; these numbers are called the degree and class respectively, and the congruence is symbolically written (m, n) .

The simplest example of a congruence is the system of lines constituted by all those that pass through m points and those that lie in n planes; through any other point there pass m of these lines, and in any other plane there lie n , therefore the congruence is of degree m and class n . It has been shown by G. H. Halphen that the number of lines common to two congruences is $mm'n'n'$, which may be verified by taking one of them to be of this simple type. The lines meeting two fixed lines form the general $(1, 1)$ congruence; and the chords of a twisted cubic form the general type of $(2, 3)$ congruence; Halphen's result shows that two twisted cubics have in general ten common chords. As regards the analytical treatment, the difficulty is of the same nature as that arising in the theory of curves in space, for a congruence is not in general the complete intersection of two complexes.

A Ruled Surface, *Regulus* or *Skew* is a configuration of lines which satisfy three conditions, and therefore depend on only one parameter. Such lines all lie on a surface, for we cannot draw one through an arbitrary point; only one line passes through a point of the surface; the simplest example, that of a quadric surface, is really two skews on the same surface.

The degree of a ruled surface *qua* line geometry is the number of its generating lines contained in a linear complex. Now the number which meets a given line is the degree of the surface *qua* point geometry, and as the lines meeting a given line form a particular case of linear complex, it follows that the degree is the same from whichever point of view we regard it. The lines common to three complexes of degrees, m_1, m_2, m_3 , form a ruled surface of degree $2m_1 m_2 m_3$; but not every ruled surface is the complete intersection of three complexes.

In the case of a complex of the first degree (or linear complex) the lines through a fixed point lie in a plane called the polar plane or nul-plane of that point, and those lying in a fixed plane pass through a point called the nul-point or pole of the plane. If the nul-plane of A pass through B, then the nul-plane of B will pass through A; the nul-planes of all points on one line l_1 pass through another line l_2 . The relation between l_1 and l_2 is reciprocal; any line of the complex that meets one will also meet the other, and every line meeting both belongs to the complex. They are called conjugate or polar lines with respect to the complex. On these principles can be founded a theory of reciprocation with respect to a linear complex.

This may be aptly illustrated by an elegant example due to A. Voss. Since a twisted cubic can be made to satisfy twelve conditions, it might be supposed that a finite number could be drawn to touch four given lines, but this is not the case. For, suppose one such can be drawn, then its reciprocal with respect to any linear complex containing the four lines is a curve of the third class, i.e. another twisted cubic, touching the same four lines, which are unaltered in the process of reciprocation; as there is an infinite number of complexes containing the four lines, there is an infinite number of cubics touching the four lines, and the problem is poristic.

The following are some geometrical constructions relating to the unique linear complex that can be drawn to contain five arbitrary lines:

To construct the nul-plane of any point O, we observe that the two lines which meet any four of the given five are conjugate lines of the complex, and the line drawn through O to meet them is therefore a ray of the complex; similarly, by choosing another four we can find another ray through O: these rays lie in the nul-plane, and there is clearly a result involved that the five lines so obtained all lie in one plane. A reciprocal construction will enable us to find the nul-point of any plane. Proceeding now to the metrical properties and the statical and dynamical applications, we remark that there is just one line such that the nul-plane of any point on it is perpendicular to it. This is called the central axis; if d be the shortest distance, θ the angle between it and a ray of the complex, then $d \tan \theta = p$, where p is a constant called the pitch or parameter. Any system of forces can be reduced to a force R along a certain line, and a couple G perpendicular to that line; the lines of equilibrium

for the system form a linear complex of which the given line is the central axis and the quotient G/R is the pitch. Any motion of a rigid body can be reduced to a screw motion about a certain line, i.e. to an angular velocity ω about that line combined with a linear velocity s along the line. The plane drawn through any point perpendicular to the direction of its motion is its nul-plane with respect to a linear complex having this line for central axis, and the quotient s/ω for pitch (cf. Sir R. S. Ball, *Theory of Screws*).

The following are some properties of a configuration of two linear complexes:

The lines common to the two-complexes also belong to an infinite number of linear complexes, of which two reduce to single straight lines. These two lines are conjugate lines with respect to each of the complexes, but they may coincide, and then some simple modifications are required. The locus of the central axis of this system of complexes is a surface of the third degree called the cylindroid, which plays a leading part in the theory of screws as developed synthetically by Ball. Since a linear complex has an invariant of the second degree in its coefficients, it follows that two linear complexes have a lineo-linear invariant. This invariant is fundamental: if the complexes be both straight lines, its vanishing is the condition of their intersection as given above; if only one of them be a straight line, its vanishing is the condition that this line should belong to the other complex. When it vanishes for any two complexes they are said to be in *involution* or *apolar*; the nul-points P, Q of any plane then divide harmonically the points in which the plane meets the common conjugate lines, and each complex is its own reciprocal with respect to the other. As regards a configuration of these linear complexes, the common lines from one system of generators of a quadric, and the doubly infinite system of complexes containing the common lines, include an infinite number of straight lines which form the other system of generators of the same quadric.

If the equation of a linear complex is $Al + Bm + Cn + Dp + Ew + Fv = 0$, then for a line not belonging to the complex we may regard the expression on the left-hand side as a multiple of the moment of the line with respect to the complex, the word moment being used in the statical sense; and we infer that when the coordinates are replaced by linear functions of themselves the new coordinates are multiples of the moments of the line with respect to six fixed complexes. The essential features of this coordinate system are the same as those of the original one, viz. there are six coordinates connected by a quadratic equation, but this relation has in general a different form. By suitable choice of the six fundamental complexes, as they may be called, this connecting relation may be brought into other simple forms of which we mention two: (i.) When the six are mutually in involution it can be reduced to $x_1^2 + x_2^2 + x_3^2 + x_4^2 + x_5^2 = 0$; (ii.) When the first four are in involution and the other two are the lines common to the first four it is $x_1^2 + x_2^2 + x_3^2 + x_4^2 - 2x_5x_6 = 0$. These generalized coordinates might be explained without reference to actual magnitude, just as homogeneous point coordinates can be; the essential remark is that the equation of any coordinate to zero represents a linear complex, a point of view which includes our original system, for the equation of a coordinate to zero represents all the lines meeting an edge of the fundamental tetrahedron.

The system of coordinates referred to six complexes mutually in involution was introduced by Felix Klein, and in many cases is more useful than that derived directly from point coordinates; e.g. in the discussion of quadratic complexes: by means of it Klein has developed an analogy between line geometry and the geometry of spheres as treated by G. Darboux and others. In fact, in that geometry a point is represented by *six* coordinates, connected by a relation of the same type as the one just mentioned when the five fundamental spheres are mutually at right angles and the equation of a sphere is of the first degree. Extending this to four dimensions of space, we obtain an exact analogue of line geometry, in which (i.) a point corresponds to a line; (ii.) a linear complex to a hypersphere; (iii.) two linear complexes in involution to two orthogonal hyperspheres; (iv.) a linear complex and two conjugate lines to a hypersphere and two inverse points. Many results may be obtained by this principle, and more still are suggested by trying to extend the properties of circles to spheres in three and four dimensions. Thus the elementary theorem, that, given four lines, the circles circumscribed to the four triangles formed by them are concurrent, may be extended to six hyperplanes in four dimensions; and then we can derive a result in line geometry by translating the inverse of this theorem. Again, just as there is an infinite number of spheres touching a surface at a given point, two of them having contact of a closer nature, so there is an infinite number of linear complexes touching a non-linear complex at a given line, and *three* of these have contact of a closer nature (cf. Klein, *Math. Ann.* v.).

Sophus Lie has pointed out a different analogy with sphere geometry. Suppose, in fact, that the equation of a sphere of radius r is

$$x^2 + y^2 + z^2 + 2ax + 2by + 2cz + d = 0,$$

so that $r^2 = a^2 + b^2 + c^2 - d$; then introducing the quantity e to make this equation homogeneous, we may regard the sphere as given by the six coordinates a, b, c, d, e, r connected by the equation $a^2 + b^2 + c^2 - d - de = 0$, and it is easy to see that two spheres touch if

the polar form $2aa_1 + 2bb_1 + 2cc_1 - 2r_1r - de_1 - a_1e$ vanishes. Comparing this with the equation $x_1^2 + x_2^2 + x_3^2 + x_4^2 - 2x_5x_6 = 0$ given above, it appears that this sphere geometry and line geometry are identical, for we may write $a = x_1, b = x_2, c = x_3, r = x_4, d = x_5, e = x_6$; but it is to be noticed that a sphere is really replaced by two lines whose coordinates only differ in the sign of x_4 , so that they are polar lines with respect to the complex $x_4 = 0$. Two spheres which touch correspond to two lines which intersect, or more accurately to two pairs of lines (p, p') and (q, q') , of which the pairs (p, q) and (p', q') both intersect. By this means the problem of describing a sphere to touch four given spheres is reduced to that of drawing a pair of lines (p, p') of which p intersects one line of the four pairs $(pp'), (qq'), (rr'), (ss')$, and p' intersects the remaining four. We may, however, ignore the accented letters in translating theorems, for a configuration of lines and its polar with respect to a linear complex have the same projective properties. In Lie's transformation a linear complex corresponds to the totality of spheres cutting a given sphere at a given angle. A most remarkable result is that lines of curvature in the sphere geometry become asymptotic lines in the line geometry.

Some of the principles of line geometry may be brought into clearer light by admitting the ideas of space of four and five dimensions.

Thus, regarding the coordinates of a line as homogeneous coordinates in five dimensions, we may say that line geometry is equivalent to geometry on a quadric surface in five dimensions. A linear complex is represented by a hyperplane section; and if two such complexes are in involution, the corresponding hyperplanes are conjugate with respect to the fundamental quadric. By projecting this quadric stereographically into space of four dimensions we obtain Klein's analogy. In the same way, geometry in a linear complex is equivalent to geometry on a quadric in four dimensions; when two lines intersect the representative points are on the same generator of this quadric. Stereographic projection, therefore, converts a curve in a linear complex, i.e. one whose tangents all belong to the complex, into one whose tangents intersect a fixed conic; when this conic is the imaginary circle at infinity the curve is what Lie calls a minimal curve. Curves in a linear complex have been extensively studied. The osculating plane at any point of such a curve is the nul-plane of the point with respect to the complex, and points of superosculation always coincide in pairs at the points of contact of stationary tangents. When a point of such a curve is given, the osculating plane is determined, hence all the curves through a given point with the same tangent have the same torsion.

The lines through a given point that belong to a complex of the n th degree lie on a cone of the n th degree; if this cone has a double line the point is said to be a singular point. Similarly, a plane is said to be singular when the envelope of the lines in it has a double tangent. It is very remarkable that the same surface is the locus of the singular points and the envelope of the singular planes: this surface is called the singular surface, and both its degree and class are in general $2n(n-1)^2$, which is equal to four for the quadratic complex.

The singular lines of a complex $F=0$ are the lines common to F and the complex

$$\frac{\delta F}{\delta l} \frac{\delta F}{\delta \lambda} + \frac{\delta F}{\delta m} \frac{\delta F}{\delta \mu} + \frac{\delta F}{\delta n} \frac{\delta F}{\delta \nu} = 0.$$

As already mentioned, at each line l of a complex there is an infinite number of tangent linear complexes, and they all contain the lines adjacent to l . If now l be a singular line, these complexes all reduce to straight lines which form a plane pencil containing the line l . Suppose the vertex of the pencil is A , its plane α , and one of its lines ξ , then P being a complex line near l , meets ξ , or more accurately the mutual moment of P , and is of the second order of small quantities. If P be a point on l , a line through P quite near l in the plane α will meet ξ and is therefore a line of the complex; hence the complex-cones of all points on l touch α and the complex-curves of all planes through l touch α at A . It follows that l is a double line of the complex-cone of A , and a double tangent of the complex-curve of α . Conversely, a double line of a cone or curve is a singular line, and a singular line clearly touches the curves of all planes through it in the same point. Suppose now that the consecutive line l' is also a singular line, A' being the allied singular point, α' the singular plane and ξ' any line of the pencil (A', α') so that ξ' is a tangent line at l' to the complex: the mutual moments of the pairs P, ξ and l, ξ' are each of the second order; hence the plane α' meets the lines l and ξ' in two points very near A . This being true for all singular planes, near A the point of contact of α with its envelope is in A , i.e. the locus of singular points is the same as the envelope of singular planes. Further, when a line touches a complex it touches the singular surface, for it belongs to a plane pencil line (A_2) , and thus in Klein's analogy the analogue of a locus of a hypersurface being a bitangent line of the complex is also a bitangent line of the singular surface. The theory of cosingular complexes is thus brought into line with that of confocal surfaces in four dimensions, and guided by these principles the existence of cosingular quadratic complexes can easily be established, the analysis required being almost the same as that invented for confocal cyclides by Darboux

and others. Of cosingular complexes of higher degree nothing is known.

Following J. Plücker, we give an account of the lines of a quadratic complex that meet a given line.

The cones whose vertices are on the given line all pass through eight fixed points and envelop a surface of the fourth degree; the cones whose planes contain the given line all lie on a surface of the fourth class and touch eight fixed planes. It is easy to see by elementary geometry that these two surfaces are identical. Further, the given line contains four singular points A_1, A_2, A_3, A_4 , and the planes into which their cones degenerate are the eight common tangent planes mentioned above; similarly, there are four singular planes, a_1, a_2, a_3, a_4 , through the line, and the eight points into which their cones degenerate are the eight common points above. The locus of the pole of the line with respect to all the conics in planes through it is a straight line called the *polar line* of the given one; and through this line passes the polar plane of the given line with respect to each of the cones. The name polar is applied in the ordinary analytical sense; any line has an infinite number of polar complexes with respect to the given complex, for the equation of the latter can be written in an infinite number of ways; one of these polars is a straight line, and is the polar line already introduced. The surface on which lie all the conics through a line l is called the Plücker surface of that line: from the known properties of $(2, 2)$ correspondences it can be shown that the Plücker surface of l cuts l_1 in a range of the same cross ratio as that of the range in which the Plücker surface of l_1 cuts l . Applying this to the case in which l_1 is the polar of l , we find that the cross ratios of (A_1, A_2, A_3, A_4) and (a_1, a_2, a_3, a_4) are equal. The identity of the locus of the A 's with the envelope of the a 's follows at once; moreover, a line meets the singular surface in four points having the same cross ratio as that of the four tangent planes drawn through the line to touch the surface. The Plücker surface has eight nodes, eight singular tangent planes, and is a double line. The relation between a line and its polar line is not a reciprocal one with respect to the complex; but W. Stahl has pointed out that the relation is reciprocal as far as the singular surface is concerned.

To facilitate the discussion of the general quadratic complex we introduce Klein's canonical form. We have, in fact, to deal with two quadratic equations in six variables; and by suitable linear transformations these can be reduced to the form

$$a_1x_1^2 + a_2x_2^2 + a_3x_3^2 + a_4x_4^2 + a_5x_5^2 + a_6x_6^2 = 0$$

$$x_1^2 + x_2^2 + x_3^2 + x_4^2 + x_5^2 + x_6^2 = 0$$

subject to certain exceptions, which will be mentioned later.

Taking the first equation to be that of the complex, we remark that both equations are unaltered by changing the sign of any coordinate; the geometrical meaning of this is, that the quadratic complex is its own reciprocal with respect to each of the six fundamental complexes, for changing the sign of a coordinate is equivalent to taking the polar of a line with respect to the corresponding fundamental complex. It is easy to establish the existence of six systems of bitangent lines of the complex, for the complex $l_1x_1 + l_2x_2 + l_3x_3 + l_4x_4 + l_5x_5 + l_6x_6 = 0$ is a bitangent when

$$l_1 = 0, \text{ and } \frac{l_2^2}{a_2 - a_1} + \frac{l_3^2}{a_3 - a_1} + \frac{l_4^2}{a_4 - a_1} + \frac{l_5^2}{a_5 - a_1} + \frac{l_6^2}{a_6 - a_1} = 0,$$

and its lines of contact are conjugate lines with respect to the first fundamental complex. We therefore infer the existence of six systems of bitangent lines of the complex, of which the first is given by

$$x_1 = 0, \frac{x_2^2}{a_2 - a_1} + \frac{x_3^2}{a_3 - a_1} + \frac{x_4^2}{a_4 - a_1} + \frac{x_5^2}{a_5 - a_1} + \frac{x_6^2}{a_6 - a_1} = 0.$$

Each of these lines is a bitangent of the singular surface, which is therefore completely determined as being the focal surface of the $(2, 2)$ congruence above. It is thence easy to verify that the two complexes $\Sigma ax^2 = 0$ and $\Sigma bx^2 = 0$ are cosingular if $b = a_1\lambda + \mu(a_2, \dots, a_6)$.

The singular surface of the general quadratic complex is the famous quartic, with sixteen nodes and sixteen singular tangent planes, first discovered by E. E. Kummer.

We cannot give a full account of its properties here, but we deduce at once from the above that its bitangents break up into six $(2, 2)$ congruences, and the six linear complexes containing these are mutually in involution. The nodes of the singular surface are points whose complex cones are coincident planes, and the complex conic in a singular tangent plane consists of two coincident points. This configuration of sixteen points and planes has many interesting properties; thus each plane contains six points which lie on a conic, while through each point there pass six planes which touch a quadric cone. In many respects the Kummer quartic plays a part in three dimensions analogous to the general quartic curve in two; it further gives a natural representation of certain relations between hyper-elliptic functions (cf. R. W. H. T. Hudson, *Kummer's Quartic*, 1905).

As might be expected from the magnitude of a form in six variables, the number of projectively distinct varieties of quadratic complexes is very great; and in fact Adolf Weiler, by whom the question was first systematically studied on lines indicated by Klein, enumerated no fewer than forty-nine different types. But the principle of the classification is so important, and withal so simple, that we give a brief sketch which indicates its essential features.

Classification of quadratic complexes.

The question was first systematically studied on lines indicated by Klein, enumerated no fewer than forty-nine different types. But the principle of the classification is so important, and withal so simple, that we give a brief sketch which indicates its essential features.

We have practically to study the intersection of two quadrics F and F' in six variables, and to classify the different cases arising we make use of the results of Karl Weierstrass on the equivalence conditions of two pairs of quadrics. As far as at present required, they are as follows: Suppose that the factorized form of the determinantal equation $\text{Diact}(F + \lambda F') = 0$ is

$$(\lambda - \alpha)^{s_1} (\lambda - \beta)^{s_2} (\lambda - \gamma)^{s_3} (\lambda - \delta)^{s_4} \dots$$

where the root α occurs $s_1 + s_2 + s_3 + \dots$ times in the determinant, $s_1 + s_2 + \dots$ times in every first minor, $s_2 + s_3 + \dots$ times in every second minor, and so on; the meaning of each exponent is then perfectly definite. Every factor of the type $(\lambda - \alpha)^{s_1}$ is called an *elementartheil* (elementary divisor) of the determinant, and the condition of equivalence of two pairs of quadrics is simply that their determinants have the same elementary divisors. We write the pair of forms symbolically thus $(\alpha_1 \alpha_2 \dots \alpha_n) (\beta_1 \beta_2 \dots \beta_n)$, letters in the inner brackets referring to the same factor. Returning now to the two quadrics representing the complex, the sum of the exponents will be six, and two complexes are put in the same class if they have the same symbolical expression; i. e. the actual values of the roots of the determinantal equation need not be the same for both, but their manner of occurrence, as far as here indicated, must be identical in the two. The enumeration of all possible cases is thus reduced to a simple question in combinatorial analysis, and the actual study of any particular case is much facilitated by a useful rule of Klein's for writing down in a simple form two quadrics belonging to a given class—one of which, of course, represents the equation connecting line coordinates, and the other the equation of the complex. The general complex is naturally $\{111111\}$; the complex of tangents to a quadric is $\{(111), (111)\}$ and that of lines meeting a conic is $\{(222)\}$. Full information will be found in Weiler's memoir, *Math. Ann.* vol. vii.

The detailed study of each variety of complex opens up a vast subject; we only mention two special cases, the harmonic complex and the tetrahedral complex.

The harmonic complex, first studied by Battaglini, is generated in an infinite number of ways by the lines cutting two quadrics harmonically. Taking the most general case, and referring the quadrics to their common self-conjugate tetrahedron, we can find its equation in a simple form, and verify that this complex really depends only on seventeen constants, so that it is not the most general quadratic complex. It belongs to the general type in so far as it is discussed above, but the roots of the determinant are in involution. The singular surface is the "tetrahedron" discussed by Cayley. As a particular case, from a metrical point of view, we have L. F. Painvin's complex generated by the lines of intersection of perpendicular tangent planes of a quadric, the singular surface now being Fresnel's wave surface. The tetrahedral or Reye complex is the simplest and best known of proper quadratic complexes. It is generated by the lines which cut the faces of a tetrahedron in a constant cross ratio, and therefore by those subtending the same cross ratio at the four vertices. The singular surface is made up of the faces or the vertices of the fundamental tetrahedron, and each edge of this tetrahedron is a double line of the complex. The complex was first discussed by K. T. Reye as the assemblage of lines joining corresponding points in a homographic transformation of space, and this point of view leads to many important and elegant properties. A (metrical) particular case of great interest is the complex generated by the normals to a family of confocal quadrics, and for many investigations it is convenient to deal with this complex referred to the principal axes. For example, Lie has developed the theory of curves in a Reye complex (i. e. curves whose tangents belong to the complex) as solutions of a differential equation of the form $(b-c)xdydz + (c-a)ydzdx + (a-b)zdx dy = 0$, and we can simplify this equation by a logarithmic transformation. Many theorems connecting complexes with differential equations have been given by Lie and his school. A line complex, in fact, corresponds to a Mongian equation having ∞^2 line integrals.

As the coordinates of a line belonging to a congruence are functions of two independent parameters, the theory of congruences is analogous to that of surfaces, and we may regard it as a fundamental inquiry to find the simplest form of surface into which a given congruence can be transformed. Most of those whose properties have been extensively discussed can be represented on a plane by a birational transformation. But in addition to the difficulties of the theory of algebraic surfaces, a subject still in its infancy, the theory of congruences has other difficulties in that a congruence is seldom completely represented, even by two equations.

A fundamental theorem is that the lines of a congruence are in general bitangents of a surface; in fact, since the condition of intersection of two consecutive straight lines is $ld\lambda + d\mu ds + d\nu ds = 0$, a line l of the congruence meets two adjacent lines, say l_1 and l_2 . Suppose l, l_1 lie in the plane pencil $(A_1 \alpha_1)$ and l, l_2 in the plane pencil $(A_2 \alpha_2)$, then the locus of the A 's in the same as the envelope of the α 's, but α_1 is the tangent plane at A_1 , and α_2 at A_2 . This surface is called the focal surface of the congruence, and to it all the lines l are bitangent. The distinctive property of the points A is that two of the congruence lines through them coincide, and in like manner the planes α each contain two coincident lines. The focal surface consists of two sheets, but one or both may degenerate into curves.

thus, for example, the normals to a surface are bitangents of the surface of centres, and in the case of Dupin's cyclide this surface degenerates into two conics.

In the discussion of congruences it soon becomes necessary to introduce another number r , called the rank, which expresses the number of plane pencils each of which contains an arbitrary line and two lines of the congruence. The order of the focal surface is $2m(m-1)-2r$, and its class is $m(m-1)-2r$. Our knowledge of congruences is almost exclusively confined to those in which either m or n does not exceed two. We give a brief account of those of the second order without singular lines, those of order unity not being especially interesting. A congruence generally has singular points through which an infinite number of lines pass; a singular point is said to be of order r when the lines through it lie on a cone of the r th degree. By means of formulae connecting the number of singular points and their orders with the class m of quadratic congruence Kümmer proved that the class cannot exceed seven. The focal surface is of degree four and class $2m$; this kind of quartic surface has been extensively studied by Kümmer, Cayley, Rohn and others. The varieties (2, 2), (2, 3), (2, 4), (2, 5) all belong to at least one Reye complex; and so also does the most important class of (2, 6) congruences which includes all the above as special cases. The congruence (2, 2) belongs to a linear complex and forty different Reye complexes; as above remarked, the singular surface is Kümmer's six-nodal quartic, and the same surface is focal for six different congruences of this variety. The theory of (2, 2) congruences is completely analogous to that of the surfaces called cyclides in three dimensions. Further particulars regarding quadratic congruences will be found in Kümmer's memoir of 1866, and the second volume of Sturm's treatise. The properties of quadratic congruences having singular lines, i.e. degenerate focal surfaces, are not so interesting as those of the above class; they have been discussed by Kümmer, Sturm and others.

Since a ruled surface contains only ∞^1 elements, this theory is practically the same as that of curves. If a linear complex contains more than n generators of a ruled surface of the n th degree, it contains all the generators, hence for $n=2$ there are three linearly independent complexes, containing all the generators, and this is a well-known property of quadric surfaces. In ruled cubics the generators all meet two lines which may or may not coincide; these two cases correspond to the two main classes of cubics discussed by Cayley and Cremona. As regards ruled quartics, the generators must lie in one and may lie in two linear complexes. The first class is equivalent to a quartic in four dimensions and is always rational, but the latter class has to be subdivided into the elliptic and the rational, just like twisted quartic curves. A quintic skew may not lie in a linear complex, and then it is unicursal, while of sextics we have two classes not in a linear complex, viz. the elliptic variety, having thirty-six places where a linear complex contains six consecutive generators, and the rational, having six such places.

The general theory of skewness in two linear complexes is identical with that of curves on a quadric in three dimensions and is known. But for skewness lying in only one linear complex there are difficulties; the curve now lies in four dimensions, and we represent it in three by stereographic projection as a curve meeting a given plane in n points on a conic. To find the maximum deficiency for a given degree would probably be difficult, but as far as degree eight the space-curve theory of Halphen and Nöther can be translated into line geometry at once. When the skew does not lie in a linear complex at all the theory is more difficult still, and the general theory clearly cannot advance until further progress is made in the study of twisted curves.

REFERENCES.—The earliest works of a general nature are Plücker, *Neue Geometrie des Raumes* (Leipzig, 1868); and Kümmer, "Über die algebraischen Strahlensysteme," *Berlin Academy* (1866). Systematic development on purely synthetic lines will be found in the three volumes of Sturm, *Liniengeometrie* (Leipzig, 1892, 1893, 1896); vol. i. deals with the linear and Reye complexes, vols. ii. and iii. with quadratic congruences and complexes respectively. For a highly suggestive review by Gino Loria see *Bulletin des sciences mathématiques* (1893, 1897). A shorter treatise, giving a very interesting account of Klein's coordinates, is the work of Koenigs, *La Géométrie réglée et ses applications* (Paris, 1898). English treatises are C. M. Jesop, *Treatise on the Line Complex* (1903); R. W. H. T. Hudson, *Kümmer's Quartic* (1905). Many references to memoirs on line geometry will be found in Hagen, *Synopsis der höheren Mathematik*, ii. (Berlin, 1894); Loria, *Il passato ed il presente delle principali teorie geometriche* (Milan, 1897); a clear résumé of the principal results is contained in the very elegant volume of Pascal, *Repertorio di matematiche superiori*, ii. (Milan, 1900). Another treatise dealing extensively with line geometry is Lie, *Geometrie der Berührungstransformationen* (Leipzig, 1896). Many memoirs on the subject have appeared in the *Mathematische Annalen*; a full list of these will be found in the index to the first fifty volumes, p. 115. Perhaps the two memoirs which have left most impression on the subsequent development of the subject are Klein, "Zur Theorie der Linien-complexe des ersten und zweiten Grades," *Math. Ann.* ii.; and Lie, "Über Complexe, insbesondere Linien- und Kugelcomplexe," *Math. Ann.* v. (J. H. GR.)

VI. NON-EUCLIDEAN GEOMETRY

The various metrical geometries are concerned with the properties of the various types of congruence-groups, which are defined in the study of the *axioms of geometry* and of their immediate consequences. But this point of view of the subject is the outcome of recent research, and historically the subject has a different origin. Non-Euclidean geometry arose from the discussion, extending from the Greek period to the present day, of the various assumptions which are implicit in the traditional Euclidean system of geometry. In the course of these investigations it became evident that metrical geometries, each internally consistent but inconsistent in many respects with each other and with the Euclidean system, could be developed. A short historical sketch will explain this origin of the subject, and describe the famous and interesting progress of thought on the subject. But previously a description of the chief characteristic properties of elliptic and of hyperbolic geometries will be given, assuming the standpoint arrived at below under VII. *Axioms of Geometry*.

First assume the equation to the absolute (cf. *loc. cit.*) to be $w^2 - x^2 - y^2 - z^2 = 0$. The absolute is then real, and the geometry is hyperbolic.

The distance (d_{12}) between the two points (x_1, y_1, z_1, w_1) and (x_2, y_2, z_2, w_2) is given by
$$\cosh (d_{12}/\gamma) = (w_1w_2 - x_1x_2 - y_1y_2 - z_1z_2) / \{ (w_1^2 - x_1^2 - y_1^2 - z_1^2)(w_2^2 - x_2^2 - y_2^2 - z_2^2) \} \quad (1)$$

The only points to which the metrical geometry applies are those within the region enclosed by the quadric; the other points are "improper ideal points." The angle (θ_{12}) between two planes, $lx + my + nz + r = 0$ and $l'x + m'y + n'z + r' = 0$, is given by
$$\cos \theta_{12} = (ll' + mm' + nn' - rr') / \{ (l^2 + m^2 + n^2 - r^2)(l'^2 + m'^2 + n'^2 - r'^2) \} \quad (2)$$

These planes only have a real angle of inclination if they possess a line of intersection within the actual space, i.e. if they intersect. Planes which do not intersect possess a shortest distance along a line which is perpendicular to both of them. If this shortest distance is δ_{12} , we have

$$\cosh (\delta_{12}/\gamma) = (ll' + mm' + nn' - rr') / \{ (l^2 + m^2 + n^2 - r^2)(l'^2 + m'^2 + n'^2 - r'^2) \} \quad (3)$$

Thus in the case of the two planes one and only one of the two, θ_{12} and δ_{12} , is real. The same considerations hold for coplanar straight lines (see VII. *Axioms of Geometry*). Let O (fig. 67) be the point

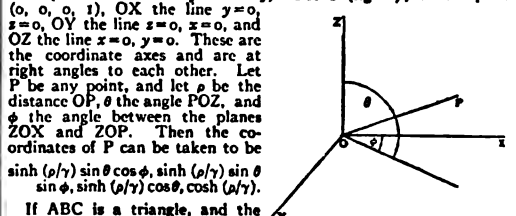

FIG. 67.

be the sides and angles are named according to the usual convention, we have

$$\sinh (a/\gamma) / \sin A = \sinh (b/\gamma) / \sin B = \sinh (c/\gamma) / \sin C, \quad (4)$$

and also

$$\cosh (a/\gamma) = \cosh (b/\gamma) \cosh (c/\gamma) - \sinh (b/\gamma) \sinh (c/\gamma) \cos A, \quad (5)$$

with two similar equations. The sum of the three angles of a triangle is always less than two right angles. The area of the triangle ABC is $\lambda^2(\pi - A - B - C)$. If the base BC of a triangle is kept fixed and the vertex A moves in the fixed plane ABC so that the area ABC is constant, then the locus of A is a line of equal distance from BC. This locus is not a straight line. The whole theory of similarity is inapplicable; two triangles are either congruent, or their angles are not equal two by two. Thus the elements of a triangle are determined when its three angles are given. By keeping A and B and the line BC fixed, but by making C move off to infinity along BC, the lines BC and AC become parallel, and the sides a and b become infinite. Hence from equation (5) above, it follows that two parallel lines (cf. Section VII. *Axioms of Geometry*) must be considered as making a zero angle with each other. Also if B be a right angle, from the equation (5), remembering that, in the limit,

$$\cosh (a/\gamma) / \cosh (b/\gamma) = \cosh (c/\gamma) / \sinh (b/\gamma) = \tau,$$

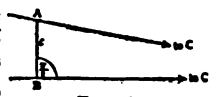

FIG. 68.

we have $\cos A = \tanh(c/\tau r)$ (6).
The angle A is called by N. I. Lobatchewsky the "angle of parallelism."

The whole theory of lines and planes at right angles to each other is simply the theory of conjugate elements with respect to the absolute, where ideal lines and planes are introduced.

Thus if l and l' be any two conjugate lines with respect to the absolute (of which one of the two must be improper, say l'), then any plane through l' and containing proper points is perpendicular to l . Also if ρ is any plane containing proper points, and P is its pole, which is necessarily improper, then the lines through P are the normals to ρ . The equation of the sphere, centre (x_1, y_1, z_1, w_1) and radius ρ , is

$$(w_1^2 - x_1^2 - y_1^2 - z_1^2)(w^2 - x^2 - y^2 - z^2) \cosh^2(\rho/\tau) = (w_1 w - x_1 x - y_1 y - z_1 z)^2 \quad (7).$$

The equation of the surface of equal distance (δ) from the plane $lx + my + nz + rw = 0$ is $(\delta^2 + m^2 + n^2 - r^2)(w^2 - x^2 - y^2 - z^2) \sinh^2(\delta/\tau) = (rw + lx + my + nz)^2$ (8).

A surface of equal distance is a sphere whose centre is improper; and both types of surface are included in the family

$$k^2(w^2 - x^2 - y^2 - z^2) = (ax + by + cz + dw)^2 \quad (9).$$

But this family also includes a third type of surfaces, which can be looked on either as the limits of spheres whose centres have approached the absolute, or as the limits of surfaces of equal distance whose central planes have approached a position tangential to the absolute. These surfaces are called limit-surfaces. Thus (9) denotes a limit-surface, if $\delta^2 - x^2 - y^2 - z^2 = 0$. Two limit-surfaces only differ in position. Thus the two limit-surfaces which touch the plane YOZ at O, but have their concavities turned in opposite directions, have as their equations

$$w^2 - x^2 - y^2 - z^2 = (w \pm x)^2.$$

The geodesic geometry of a sphere is elliptic, that of a surface of equal distance is hyperbolic, and that of a limit-surface is parabolic (*i.e. Euclidean*). The equation of the surface (cylinder) of equal distance (δ) from the line OX is

$$(w^2 - x^2) \tanh^2(\delta/\tau) - y^2 - z^2 = 0.$$

This is not a ruled surface. Hence in this geometry it is not possible for two straight lines to be at a constant distance from each other.

Secondly, let the equation of the absolute be $x^2 + y^2 + z^2 + w^2 = 0$. The absolute is now imaginary and the geometry is elliptic.

The distance (d_{12}) between the two points (x_1, y_1, z_1, w_1) and (x_2, y_2, z_2, w_2) is given by $\cos(d_{12}/\tau) = \frac{(x_1 x_2 + y_1 y_2 + z_1 z_2 + w_1 w_2) / \sqrt{(x_1^2 + y_1^2 + z_1^2 + w_1^2)(x_2^2 + y_2^2 + z_2^2 + w_2^2)}}{1}$ (10).

Thus there are two distances between the points, and if one is d_{12} , the other is $\tau\pi - d_{12}$. Every straight line returns into itself, forming a closed series. Thus there are two segments between any two points, together forming the whole line which contains them; one distance is associated with one segment, and the other distance with the other segment. The complete length of every straight line is $\tau\pi$.

The angle between the two planes $l_1 x + m_1 y + n_1 z + r_1 w = 0$ and $l_2 x + m_2 y + n_2 z + r_2 w = 0$ is $\cos \theta_{12} = \frac{(l_1 l_2 + m_1 m_2 + n_1 n_2 + r_1 r_2) / \sqrt{(l_1^2 + m_1^2 + n_1^2 + r_1^2)(l_2^2 + m_2^2 + n_2^2 + r_2^2)}}{1}$ (11).

The polar plane with respect to the absolute of the point (x_1, y_1, z_1, w_1) is the real plane $x_1 x + y_1 y + z_1 z + w_1 w = 0$, and the pole of the plane $l_1 x + m_1 y + n_1 z + r_1 w = 0$ is the point (l_1, m_1, n_1, r_1) . Thus (from equations 10 and 11) it follows that the angle between the polar planes of the points (x_1, \dots) and (x_2, \dots) is d_{12}/τ , and that the distance between the poles of the planes (l_1, \dots) and (l_2, \dots) is $\tau\theta_{12}$. Thus there is complete reciprocity between points and planes in respect to all properties. This complete reign of the principle of duality is one of the great beauties of this geometry. The theory of lines and planes at right angles is simply the theory of conjugate elements with respect to the absolute. A tetrahedron self-conjugate with respect to the absolute has all its intersecting elements (edges and planes) at right angles. If l and l' are two conjugate lines, the planes through one are the planes perpendicular to the other. If P is the pole of the plane ρ , the lines through P are the normals to the plane ρ . The distance from P to ρ is $1/\tau$. Thus every sphere is also a surface of equal distance from the polar of its centre, and conversely. A plane does not divide space; for the line joining any two points P and Q only cuts the plane once, in L say, then it is always possible to go from P to Q by the segment of the line PQ which does not contain L. But P and Q may be said to be separated by a plane ρ , if the point in which PQ cuts ρ lies on the shortest segment between P and Q. With this sense of "separation," it is possible to find three points P, Q, R such that P and Q are separated

by the plane ρ , but P and R are not separated by ρ , nor are Q and R.

Let A, B, C be any three non-collinear points, then four triangles are defined by these points. Thus if a, b, c and A, B, C are the elements of any one triangle, then the four triangles have as their elements:

- (1) $a, b, c, A, B, C.$
- (2) $a, \tau\pi - b, \tau\pi - c, A, \tau - B, \tau - C.$
- (3) $\tau\pi - a, b, \tau\pi - c, \tau - A, B, \tau - C.$
- (4) $\tau\pi - a, \tau\pi - b, c, \tau - A, \tau - B, C.$

The formulae connecting the elements are

$$\sin A/\sin(a/\tau) = \sin B/\sin(b/\tau) = \sin C/\sin(c/\tau), \quad (12)$$

and

$$\cos(a/\tau) = \cos(b/\tau) \cos(c/\tau) + \sin(b/\tau) \sin(c/\tau) \cos A, \quad (13)$$

with two similar equations.

Two cases arise, namely (I.) according as one of the four triangles has as its sides the shortest segments between the angular points, or (II.) according as this is not the case. When case I. holds there is said to be a "principal triangle."² If all the figures considered lie within a sphere of radius $1/\tau$ only case I. can hold, and the principal triangle is the triangle wholly within this sphere, also the peculiarities in respect to the separation of points by a plane cannot then arise. The sum of the three angles of a triangle ABC is always greater than two right angles, and the area of the triangle is $\tau^2(A+B+C-\tau)$. Thus as in hyperbolic geometry the theory of similarity does not hold, and the elements of a triangle are determined when its three angles are given. The coordinates of a point can be written in the form

$$\sin(\rho/\tau) \sin \theta \cos \phi, \sin(\rho/\tau) \sin \theta \sin \phi, \sin(\rho/\tau) \cos \theta, \cos(\rho/\tau),$$

where ρ, θ and ϕ have the same meanings as in the corresponding formulae in hyperbolic geometry. Again, suppose a watch is laid on the plane OXY, face upwards with its centre at O, and the line 12 to 6 (as marked on dial) along the line YOY. Let the watch be continually pushed along the plane along the line OX, that is, in the direction 9 to 3. Then the line XOX being of finite length, the watch will return to O, but at its first return it will be found to be watch downwards on the other side of the plane, with the line 12 to 6 reversed in direction along the line YOY. This peculiarity was first pointed out by Felix Klein. The theory of parallels as it exists in hyperbolic space has no application in elliptic geometry. But another property of Euclidean parallel lines holds in elliptic geometry, and by the use of it parallel lines are defined. For the equation of the surface (cylinder) of equal distance (δ) from the line XOX is

$$(x^2 + w^2) \tan^2(\delta/\tau) - (y^2 + z^2) = 0.$$

This is also the surface of equal distance, $1/2\tau - \delta$, from the line conjugate to XOX. Now from the form of the above equation this is a ruled surface, and through every point of it two generators pass. But these generators are lines of equal distance from XOX. Thus throughout every point of space two lines can be drawn which are lines of equal distance from a given line l . This property was discovered by W. K. Clifford. The two lines are called Clifford's right and left parallels to l through the point. This property of parallelism is reciprocal, so that if m is a left parallel to l , then l is a left parallel to m . Note also that two parallel lines l and m are not coplanar. Many of those properties of Euclidean parallels, which do not hold for Lobatchewsky's parallels in hyperbolic geometry, do hold for Clifford's parallels in elliptic geometry. The geodesic geometry of spheres is elliptic, the geodesic geometry of surfaces of equal distance from lines (cylinders) is Euclidean, and surfaces of revolution can be found³ of which the geodesic geometry is hyperbolic. But it is to be noticed that the connectivity of these surfaces is different to that of a Euclidean plane. For instance there are only ∞^2 congruence transformations of the cylindrical surfaces of equal distance into themselves, instead of the ∞^3 for the ordinary plane. It would obviously be possible to state "axioms" which these geodesics satisfy, and thus to define independently, and not as loci, quasi-spaces of these peculiar types. The existence of such Euclidean quasi-geometries was first pointed out by Clifford.⁴

In both elliptic and hyperbolic geometry the spherical geometry, *i.e.* the relations between the angles formed by lines and planes passing through the same point, is the same as the "spherical trigonometry" in Euclidean geometry. The constant γ , which appears in the formulae both of hyperbolic and elliptic geometry, does not by its variation produce different types of geometry. There is only one type of elliptic geometry and one type of hyperbolic geometry; and the magnitude of the constant γ in each case simply depends upon the magnitude of the arbitrary unit of length in comparison with the natural unit of length

² Cf. A. N. Whitehead, *loc. cit.*
³ Cf. A. N. Whitehead, "The Geodesic Geometry of Surfaces in non-Euclidean Space," *Proc. Lond. Math. Soc.* vol. xxix.
⁴ Cf. Klein, "Zur nicht-Euklidischen Geometrie," *Math. Annal.* vol. xxviii.

¹ Cf. A. N. Whitehead, *Universal Algebra*, Bk. vi. (Cambridge, 1898).

which each particular instance of either geometry presents. The existence of a natural unit of length is a peculiarity common both to hyperbolic and elliptic geometries, and differentiates them from Euclidean geometry. It is the reason for the failure of the theory of similarity in them. If γ is very large, that is, if the natural unit is very large compared to the arbitrary unit, and if the lengths involved in the figures considered are not large compared to the arbitrary unit, then both the elliptic and hyperbolic geometries approximate to the Euclidean. For from formulae (4) and (5) and also from (12) and (13) we find, after retaining only the lowest powers of small quantities, as the formulae for any triangle ABC,

$$a/\sin A = b/\sin B = c/\sin C,$$

and

$$a^2 = b^2 + c^2 - 2bc \cos A,$$

with two similar equations. Thus the geometries of small figures are in both types Euclidean.

History.—"In pulcherrimo Geometriac corpore," wrote Sir Henry Savile in 1621, "duo sunt naevi, duae labe nec quod sciam plures, in quibus huicendi et emaculandis cum veterum tum recentiorum . . . vigilavit industria."

Theory of parallels before Gauss. These two blemishes are the theory of parallels and the theory of proportion. The "industry of the moderns," in both respects, has given rise to important branches of mathematics, while at the same time showing that Euclid is in these respects more free from blemish than had been previously credible. It was from endeavours to improve the theory of parallels that non-Euclidean geometry arose; and though it has now acquired a far wider scope, its historical origin remains instructive and interesting. Euclid's "axiom of parallels" appears as Postulate V. to the first book of his *Elements*, and is stated thus, "And that, if a straight line falling on two straight lines make the angles, internal and on the same side, less than two right angles, the two straight lines, being produced indefinitely, meet on the side on which are the angles less than two right angles." The original Greek is *καὶ ἐὰν εἰς δύο εὐθείας εὐθεία ὑπερτίττωσα τὰς ἐνθὸς καὶ ἐπὶ τὰ αὐτὰ μέρη γωνίας δύο ὀρθῶν ἐλάσσονας ποιῆ, ἐκβαλλόμεναι τὰς δύο εὐθείαι ἐπ' ἀπειρον συνιπτέω, ἐφ' ἃ μέρη εἰσὶν αἱ τῶν δύο ὀρθῶν ἐλάσσοναι.*

To Euclid's successors this axiom had signally failed to appear self-evident, and had failed equally to appear indemonstrable. Without the use of the postulate its converse is proved in Euclid's 28th proposition, and it was hoped that by further efforts the postulate itself could be also proved. The first step consisted in the discovery of equivalent axioms. Christoph Clavius in 1574 deduced the axiom from the assumption that a line whose points are all equidistant from a straight line is itself straight. John Wallis in 1663 showed that the postulate follows from the possibility of similar triangles on different scales. Girolamo Saccheri (1733) showed that it is sufficient to have a single triangle, the sum of whose angles is two right angles. Other equivalent forms may be obtained, but none shows any essential superiority to Euclid's. Indeed plausibility, which is chiefly aimed at, becomes a positive demerit where it conceals a real assumption.

A new method, which, though it failed to lead to the desired goal, proved in the end immensely fruitful, was invented by Saccheri, in a work entitled *Euclides ab omni naevo Saccheri vindicatus* (Milan, 1733). If the postulate of parallels is involved in Euclid's other assumptions, contradictions must emerge when it is denied while the others are maintained. This led Saccheri to attempt a *reductio ad absurdum*, in which he mistakenly believed himself to have succeeded. What is interesting, however, is not his fallacious conclusion, but the non-Euclidean results which he obtains in the process. Saccheri distinguishes three hypotheses (corresponding to what are now known as Euclidean or parabolic, elliptic and hyperbolic geometry), and proves that some one of the three must be universally true. His three hypotheses are thus obtained: equal perpendiculars AC, BD are drawn from a straight line AB, and CD are joined. It is shown that the angles ACD, BDC are

equal. The first hypothesis is that these are both right angles; the second, that they are both obtuse; and the third, that they are both acute. Many of the results afterwards obtained by Lobatchewsky and Bolyai are here developed. Saccheri fails to be the founder of non-Euclidean geometry only because he does not perceive the possible truth of his non-Euclidean hypotheses.

Some advance is made by Johann Heinrich Lambert in his *Theorie der Parallelinien* (written 1766; posthumously published 1786). Though he still believed in the necessary truth of Euclidean geometry, he confessed that, in all his attempted proofs, something remained undemonstrated. He deals with the same three hypotheses as Saccheri, showing that the second holds on a sphere, while the third would hold on a sphere of purely imaginary radius. The second hypothesis he succeeds in condemning, since, like all who preceded Bernhard Riemann, he is unable to conceive of the straight line as finite and closed. But the third hypothesis, which is the same as Lobatchewsky's, is not even professedly refuted.¹

Non-Euclidean geometry proper begins with Karl Friedrich Gauss. The advance which he made was rather philosophical than mathematical: it was he (probably) who first recognized that the postulate of parallels is possibly false, and should be empirically tested by measuring the angles of large triangles. The history of non-Euclidean geometry has been aptly divided by Felix Klein into three very distinct periods. The first—which contains only Gauss, Lobatchewsky and Bolyai—is characterized by its synthetic method and by its close relation to Euclid. The attempt at indirect proof of the disputed postulate would seem to have been the source of these three men's discoveries; but when the postulate had been denied, they found that the results, so far from showing contradictions, were just as self-consistent as Euclid. They inferred that the postulate, if true at all, can only be proved by observations and measurements. Only one kind of non-Euclidean space is known to them, namely, that which is now called hyperbolic. The second period is analytical, and is characterized by a close relation to the theory of surfaces. It begins with Riemann's inaugural dissertation, which regards space as a particular case of a manifold; but the characteristic standpoint of the period is chiefly emphasized by Eugenio Beltrami. The conception of measure of curvature is extended by Riemann from surfaces to spaces, and a new kind of space, finite but unbounded (corresponding to the second hypothesis of Saccheri and Lambert), is shown to be possible. As opposed to the second period, which is purely metrical, the third period is essentially projective in its method. It begins with Arthur Cayley, who showed that metrical properties are projective properties relative to a certain fundamental quadric, and that different geometries arise according as this quadric is real, imaginary or degenerate. Klein, to whom the development of Cayley's work is due, showed further that there are two forms of Riemann's space, called by him the elliptic and the spherical. Finally, it has been shown by Sophus Lie, that if figures are to be freely movable throughout all space in ∞^6 ways, no other three-dimensional spaces than the above four are possible.

Gauss published nothing on the theory of parallels, and it was not generally known until after his death that he had interested himself in that theory from a very early date. In 1799 he announces that Euclidean geometry would follow from the assumption that a triangle can be drawn greater than any given triangle. Though unwilling to assume this, we find him in 1804 still hoping to prove the postulate of parallels. In 1830 he announces his conviction that geometry is not an a priori science; in the following year he explains that non-Euclidean geometry is free from contradictions, and that, in this system, the angles of a triangle diminish without limit when all the sides are increased. He also gives for the

¹ On the theory of parallels before Lobatchewsky, see Stäckel and Engel, *Theorie der Parallelinien von Euclid bis auf Gauss* (Leipzig, 1895). The foregoing remarks are based upon the materials collected in this work.

Three periods of non-Euclidean geometry.

circumference of a circle of radius r the formula $\pi k(e^{1/r} - e^{-1/r})$, where k is a constant depending upon the nature of the space. In 1832, in reply to the receipt of Bolyai's *Appendix*, he gives an elegant proof that the amount by which the sum of the angles of a triangle falls short of two right angles is proportional to the area of the triangle. From these and a few other remarks it appears that Gauss possessed the foundations of hyperbolic geometry, which he was probably the first to regard as perhaps true. It is not known with certainty whether he influenced Lobatchewsky and Bolyai, but the evidence we possess is against such a view.¹

The first to publish a non-Euclidean geometry was Nicholas Lobatchewsky, professor of mathematics in the new university of Kazan.² In the place of the disputed postulate he puts the following: "All straight lines which, in a plane, radiate from a given point, can, with respect to any other straight line in the same plane, be divided into two classes, the *intersecting* and the *non-intersecting*. The *boundary line* of the one and the other class is called *parallel to the given line*." It follows that there are two parallels to the given line through any point, each meeting the line at infinity, like a Euclidean parallel. (Hence a line has two distinct points at infinity, and not one only as in ordinary geometry.) The two parallels to a line through a point make equal acute angles with the perpendicular to the line through the point. If ρ be the length of the perpendicular, either of these angles is denoted by $\Pi(\rho)$. The determination of $\Pi(\rho)$ is the chief problem (cf. equation (6) above); it appears finally that, with a suitable choice of the unit of length,

$$\tan \frac{1}{2} \Pi(\rho) = e^{-\rho}.$$

Before obtaining this result it is shown that spherical trigonometry is unchanged, and that the normals to a circle or a sphere still pass through its centre. When the radius of the circle or sphere becomes infinite all these normals become parallel, but the circle or sphere does not become a straight line or plane. It becomes what Lobatchewsky calls a *limit-line* or *limit-surface*. The geometry on such a surface is shown to be Euclidean, limit-lines replacing Euclidean straight lines. (It is, in fact, a surface of zero measure of curvature.) By the help of these propositions Lobatchewsky obtains the above value of $\Pi(\rho)$, and thence the solution of triangles. He points out that his formulæ result from those of spherical trigonometry by substituting ia, ib, ic , for the sides a, b, c .

John Bolyai, a Hungarian, obtained results closely corresponding to those of Lobatchewsky. These he published in an appendix to a work by his father, entitled *Appendix Scientiam Bolyai spatii absolute veram exhibens: a veritate aut falsitate Axiomatis XI. Euclidæ (a priori haud unquam decidenda) independentem: adjecta ad casum falsitatis, quadratura circuli geometrica*.³ This work was published in 1831, but its conception dates from 1823. It reveals a profounder appreciation of the importance of the new ideas, but otherwise differs little from Lobatchewsky's. Both men point out that Euclidean geometry as a limiting case of their own more general system, that the geometry of very small spaces is always approximately Euclidean, that no a priori grounds exist for a decision, and that observation can only give an approximate answer. Bolyai gives also, as his title indicates, a geometrical construction, in hyperbolic space, for the quadrature of the circle, and shows that the area of the greatest possible triangle, which has all its sides parallel and all its angles zero, is πr^2 , where r is what we should now call the space-constant.

¹ See Stäckel and Engel, *op. cit.*, and "Gauss, die beiden Bolyai, und die nicht-Euklidische Geometrie," *Math. Annalen*, Bd. xlix.; also Engel's translation of Lobatchewsky (Leipzig, 1898), pp. 378 ff.

² Lobatchewsky's works on the subject are the following:—"On the Foundations of Geometry," *Kazan Messenger*, 1829-1830; "New Foundations of Geometry, with a complete Theory of Parallels," *Proceedings of the University of Kazan*, 1835 (both in Russian, but translated into German by Engel, Leipzig, 1898); "Géométrie imaginaire," *Crelle's Journal*, 1837; *Theorie der Parallellinien* (Berlin, 1840; 2nd ed., 1887; translated by Halsted, Austin, Texas, 1891). His results appear to have been set forth in a paper (now lost) which he read at Kazan in 1826.

³ Translated by Halsted (Austin, Texas, 4th ed., 1896).

The works of Lobatchewsky and Bolyai, though known and valued by Gauss, remained obscure and ineffective until, in 1866, they were translated into French by J. Hoüel. But at this time Riemann's dissertation, *Über die Hypothesen, welche der Geometrie zu Grunde liegen*,⁴ was already about to be published. In this work Riemann, without any knowledge of his predecessors in the same field, inaugurated a far more profound discussion, based on a far more general standpoint; and by its publication in 1867 the attention of mathematicians and philosophers was at last secured. (The dissertation dates from 1854, but owing to changes which Riemann wished to make in it, it remained unpublished until after his death.)

Riemann's work contains two fundamental conceptions, that of a manifold and that of the *measure of curvature* of a continuous manifold possessed of what he calls flatness in the smallest parts. By means of these conceptions space is made to appear at the end of a gradual series of more and more specialized conceptions. Conceptions of magnitude, he explains, are only possible where we have a general conception capable of determination in various ways. The manifold consists of all these various determinations, each of which is an element of the manifold. The passage from one element to another may be discrete or continuous; the manifold is called discrete or continuous accordingly. Where it is discrete two portions of it can be compared, as to magnitude, by counting; where continuous, by measurement. But measurement demands superposition, and consequently some magnitude independent of its place in the manifold. In passing, in a continuous manifold, from one element to another in a determinate way, we pass through a series of intermediate terms, which form a one-dimensional manifold. If this whole manifold be similarly caused to pass over into another, each of its elements passes through a one-dimensional manifold, and thus on the whole a two-dimensional manifold is generated. In this way we can proceed to n dimensions. Conversely, a manifold of n dimensions can be analysed into one of one dimension and one of $(n-1)$ dimensions. By repetitions of this process the position of an element may be at last determined by n magnitudes. We may here stop to observe that the above conception of a manifold is akin to that due to Hermann Grassmann in the first edition (1847) of his *Ausdehnungslehre*.⁵

Both concepts have been elaborated and superseded by the modern procedure in respect to the axioms of geometry, and by the conception of abstract geometry involved therein. Riemann proceeds to specialize the manifold by considerations as to measurement. If measurement is to be possible, some magnitude, we saw, must be independent of position; let us consider manifolds in which lengths of lines are such magnitudes, so that every line is measurable by every other. The coordinates of a point being x_1, x_2, \dots, x_n , let us confine ourselves to lines along which the ratios $dx_1:dx_2:\dots:dx_n$ alter continuously. Let us also assume that the element of length, ds , is unchanged (to the first order) when all its points undergo the same infinitesimal motion. Then if all the increments dx be altered in the same ratio, ds is also altered in this ratio. Hence ds is a homogeneous function of the first degree of the increments dx . Moreover, ds must be unchanged when all the dx change sign. The simplest possible case is, therefore, that in which ds is the square root of a quadratic function of the dx . This case includes space, and is alone considered in what follows. It is called the case of flatness in the smallest parts. Its further discussion depends upon the measure of curvature, the second of Riemann's fundamental conceptions. This conception, derived from the theory of surfaces, is applied as follows. Any one of the shortest lines which issue from a given point (say the origin) is completely determined by the initial ratios of the dx . Two such lines, defined by dx and δx say, determine a pencil, or one-dimensional series, of shortest lines, any one of which is defined

⁴ *Abhandlungen d. Königl. Ges. d. Wiss. zu Göttingen*, Bd. xiii.; *Ges. math. Werke*, pp. 254-269; translated by Clifford, *Collected Mathematical Papers*.

⁵ *Cf. Gesamm. math. und phys. Werke*, vol. I. (Leipzig, 1894).

Definition of a manifold.

Measure of curvature.

by $\lambda dx + \mu dy$, where the parameter $\lambda : \mu$ may have any value. This pencil generates a two-dimensional series of points, which may be regarded as a surface, and for which we may apply Gauss's formula for the measure of curvature at any point. Thus at every point of our manifold there is a measure of curvature corresponding to every such pencil; but all these can be found when $n \cdot n - 1/2$ of them are known. If figures are to be freely movable, it is necessary and sufficient that the measure of curvature should be the same for all points and all directions at each point. Where this is the case, it a be the measure of curvature, the linear element can be put into the form

$$ds = \sqrt{(\Sigma dx^2)/(1 + \frac{1}{2} a \Sigma x^2)}.$$

If a be positive, space is finite, though still unbounded, and every straight line is closed—a possibility first recognized by Riemann. It is pointed out that, since the possible values of a form a continuous series, observations cannot prove that our space is strictly Euclidean. It is also regarded as possible that, in the infinitesimal, the measure of curvature of our space should be variable.

There are four points in which this profound and epoch-making work is open to criticism or development—(1) the idea of a manifold requires more precise determination; (2) the introduction of coordinates is entirely unexplained and the requisite pre-suppositions are unanalysed; (3) the assumption that ds is the square root of a quadratic function of dx_1, dx_2, \dots is arbitrary, (4) the idea of superposition, or congruence, is not adequately analysed. The modern solution of these difficulties is properly considered in connexion with the general subject of the axioms of geometry.

The publication of Riemann's dissertation was closely followed by two works of Hermann von Helmholtz,¹ again undertaken in ignorance of the work of predecessors. In these a proof is attempted that ds must be a rational integral quadratic function of the increments of the coordinates. This proof has since been shown by Lie to stand in need of correction (see VII. *Axioms of Geometry*). Helmholtz's remaining works on the subject² are of almost exclusively philosophical interest. We shall return to them later.

The only other writer of importance in the second period is Eugenio Beltrami, by whom Riemann's work was brought into connexion with that of Lobatchewsky and Bolyai.

Beltrami. As he gave, by an elegant method, a convenient Euclidean interpretation of hyperbolic plane geometry, his results will be stated at some length.³ The *Saggio* shows that Lobatchewsky's plane geometry holds in Euclidean geometry on surfaces of constant negative curvature, straight lines being replaced by geodesics. Such surfaces are capable of a conformal representation on a plane, by which geodesics are represented by straight lines. Hence if we take, as coordinates on the surface, the Cartesian coordinates of corresponding points on the plane, the geodesics must have linear equations.

Hence it follows that

$$ds^2 = R^2 w^{-2} \{ (a^2 - v^2) du^2 + 2uv du dv + (a^2 - u^2) dv^2 \}$$

where $w^2 = a^2 - u^2 - v^2$, and $-1/R^2$ is the measure of curvature of our surface (note that $k = \gamma$ as used above). The angle between two geodesics $u = \text{const.}, v = \text{const.}$ is, where

$$\cos \theta = uv / \sqrt{ \{ (a^2 - u^2)(a^2 - v^2) \} }, \sin \theta = aw / \sqrt{ \{ (a^2 - u^2)(a^2 - v^2) \} }.$$

Thus $u = 0$ is orthogonal to all geodesics $v = \text{const.}$ and vice versa. In order that $\sin \theta$ may be real, w must be positive; thus geodesics have no real intersection when the corresponding straight lines intersect outside the circle $u^2 + v^2 = a^2$. When they intersect on this circle, $\theta = 0$. Thus Lobatchewsky's parallels are represented by straight lines intersecting on the circle. Again, transforming to polar coordinates $u = r \cos \mu, v = r \sin \mu$, and calling ρ the geodesic

distance of u, v from the origin, we have, for a geodesic through the origin,

$$d\rho = Radr / (a^2 - r^2), \rho = \frac{1}{2} R \log \frac{a+r}{a-r}, r = a \tanh \frac{\rho}{R}.$$

Thus points on the surface corresponding to points in the plane on the limiting circle $r = a$, are all at an infinite distance from the origin. Again, considering R constant, the arc of a geodesic circle subtending an angle μ at the origin is

$$s = R\rho / \sqrt{ (a^2 - r^2) } = \mu R \sinh (\rho/R),$$

whence the circumference of a circle of radius ρ is $2\pi R \sinh (\rho/R)$.

Again, if a be the angle between any two geodesics

$$V - v = m(U - u), V - v = n(U - u),$$

then $\tan a = a(n - m)w / \{ (1 + mn)a^2 - (v - nu)(v - mu) \}$.

Thus a is imaginary when u, v is outside the limiting circle, and is zero when, and only when, u, v is on the limiting circle. All these results agree with those of Lobatchewsky and Bolyai. The maximum triangle, whose angles are all zero, is represented in the auxiliary plane by a triangle inscribed in the limiting circle. The angle of parallelism is also easily obtained. The perpendicular to $v = 0$ at a distance δ from the origin is $u = a \tanh (\delta/R)$, and the parallel to this through the origin is $u = v \sinh (\delta/R)$. Hence $\Pi(\delta)$, the angle which this parallel makes with $v = 0$, is given by

$$\tan \Pi(\delta) \cdot \sinh (\delta/R) = 1, \text{ or } \tan \frac{1}{2} \Pi(\delta) = e^{-\delta/R}$$

which is Lobatchewsky's formula. We also obtain easily for the area of a triangle the formula $R^2(\pi - A - B - C)$.

Beltrami's treatment connects two curves which, in the earlier treatment, had no connexion. These are limit-lines and curves of constant distance from a straight line. Both may be regarded as circles, the first having an infinite, the second an imaginary radius. The equation to a circle of radius ρ and centre u_0, v_0 is

$$(u^2 - uu_0 - vv_0)^2 = \cosh^2 (\rho/R), w_0^2 v^2 = C^2 w^2 \quad (\text{say}).$$

This equation remains real when ρ is a pure imaginary, and remains finite when $u_0 = 0$, provided ρ becomes infinite in such a way that $w_0 \cosh (\rho/R)$ remains finite. In the latter case the equation represents a limit-line. In the former case, by giving different values to C , we obtain concentric circles with the imaginary centre u_0, v_0 . One of these, obtained by putting $C = 0$, is the straight line $u^2 - uu_0 - vv_0 = 0$. Hence the others are each throughout at a constant distance from this line. (It may be shown that all motions in a hyperbolic plane consist, in a general sense, of rotations; but three types must be distinguished according as the centre is real, imaginary or at infinity. All points describe, accordingly, one of the three types of circles.)

The above Euclidean interpretation fails for three or more dimensions. In the *Teoria fondamentale*, accordingly, where n dimensions are considered, Beltrami treats hyperbolic space in a purely analytical spirit. The paper shows that Lobatchewsky's space of any number of dimensions has, in Riemann's sense, a constant negative measure of curvature. Beltrami starts with the formula (analogous to that of the *Saggio*)

$$ds^2 = R^2 x^{-2} (dx_1^2 + dx_2^2 + dx_3^2 + \dots + dx_n^2),$$

where

$$x^2 = x_1^2 + x_2^2 + x_3^2 + \dots + x_n^2 = a^2.$$

He shows that geodesics are represented by linear equations between x_1, x_2, \dots, x_n , and that the geodesic distance ρ between two points x and x' is given by

$$\cosh \frac{\rho}{R} = \frac{a^2 - x_1 x'_1 - x_2 x'_2 - \dots - x_n x'_n}{\{ (a^2 - x_1^2 - x_2^2 - \dots - x_n^2)(a^2 - x_1'^2 - x_2'^2 - \dots - x_n'^2) \}^{1/2}}$$

(a formula practically identical with Cayley's, though obtained by a very different method). In order to show that the measure of curvature is constant, we make the substitutions

$$x_1 = r\lambda_1, x_2 = r\lambda_2, \dots, x_n = r\lambda_n, \text{ where } \Sigma \lambda^2 = 1.$$

Hence

$$ds^2 = (Radr / \sqrt{a^2 - r^2})^2 + R^2 r^2 d\Lambda^2 / (a^2 - r^2).$$

where

$$d\Lambda^2 = \Sigma d\lambda^2.$$

Also calling ρ the geodesic distance from the origin, we have

$$\cosh (\rho/R) = \frac{a}{\sqrt{ (a^2 - r^2) }}, \sinh (\rho/R) = \frac{r}{\sqrt{ (a^2 - r^2) }}.$$

Hence

$$ds^2 = d\rho^2 + (R \sinh (\rho/R))^2 d\Lambda^2.$$

Putting,

$$z_1 = \rho\lambda_1, z_2 = \rho\lambda_2, \dots, z_n = \rho\lambda_n,$$

we obtain

$$ds^2 = \Sigma dz_i^2 + \frac{1}{\rho^2} \left\{ \frac{R}{\rho} \sinh \frac{\rho}{R} \right\}^2 - 1 \left\{ \Sigma (z_1 dz_2 - z_2 dz_1) \right\}^2.$$

Hence when ρ is small, we have approximately

$$ds^2 = \Sigma dz_i^2 + \frac{1}{3R^2} \Sigma (z_1 dz_2 - z_2 dz_1)^2 \dots \dots (1).$$

Considering a surface element through the origin, we may choose our axes so that, for this element,

$$z_1 = z_4 = \dots = z_n = 0.$$

Thus

$$ds^2 = dz_2^2 + dz_3^2 + \frac{1}{3R^2} (z_2 dz_3 - z_3 dz_2)^2 \dots \dots (2).$$

Now the area of the triangle (whose vertices are $(0, 0), (z_1, z_2), (z_1, z_3)$ (dz_1, dz_2) is $\frac{1}{2}(z_1, dz_2 - z_2 dz_1)$. Hence the quotient when the terms of the fourth order in (2) are divided by the square of this triangle is

¹ *Wiss. Abh.* vol. ii. pp. 610, 618 (1866, 1868).

² *Mind*; O.S., vols. i. and iii.; *Vorlesung und Reden*, vol. ii. pp. 1, 256.

³ His papers are "Saggio di interpretazione della geometria non-Euclidea," *Giornale di matematica*, vol. vi. (1868); "Teoria fondamentale degli spazii di curvatura costante," *Annali di matematica*, vol. ii. (1868-1869). Both were translated into French by J. Hoüel, *Annales scientifiques de l'École Normale supérieure*, vol. vi. (1866).

$4/3R^2$; hence, returning to general axes, the same is the quotient when the terms of the fourth order in (1) are divided by the square of the triangle whose vertices are $(0, 0, \dots, 0)$, $(a_1, a_2, a_3, \dots, a_n)$, $(d_1, d_2, d_3, \dots, d_n)$. But $-\frac{1}{2}$ of this quotient is defined by Riemann as the measure of curvature.¹ Hence the measure of curvature is $-1/R^2$, i. e. is constant and negative. The properties of parallels, triangles, &c., are as in the *Saggio*. It is also shown that the analogues of limit surfaces have zero curvature; and that spheres of radius ρ have constant positive curvature $1/R^2 \sinh^2(\rho/R)$, so that spherical geometry may be regarded as contained in the pseudo-spherical (as Beltrami calls Lobatchewsky's system).

The *Saggio*, as we saw, gives a Euclidean interpretation confined to two dimensions. But a consideration of the auxiliary plane suggests a different interpretation, which may be extended to any number of dimensions. If, instead of referring to the pseudosphere, we merely define distance and angle, in the Euclidean plane, as those functions of the coordinates which gave us distance and angle on the pseudosphere, we find that the geometry of our plane has become Lobatchewsky's. All the points of the limiting circle are now at infinity, and points beyond it are imaginary. If we give our circle an imaginary radius the geometry on the plane becomes elliptic. Replacing the circle by a sphere, we obtain an analogous representation for three dimensions. Instead of a circle or sphere we may take any conic or quadric. With this definition, if the fundamental quadric be $\Sigma_{xx} = 0$, and if Σ_{xx}' be the polar form of Σ_{xx} , the distance ρ between x and x' is given by the projective formula

$$\cos(\rho/k) = \Sigma_{xx}' / \{\Sigma_{xx} \Sigma_{xx}'\}^{1/2}$$

That this formula is projective is rendered evident by observing that $\epsilon^{2\rho/k}$ is the anharmonic ratio of the range consisting of the two points and the intersections of the line joining them with the fundamental quadric. With this we are brought to the third or projective period. The method of this period is due to Cayley; its application to previous non-Euclidean geometry is due to Klein. The projective method contains a generalization of discoveries already made by Laguerre² in 1853 as regards Euclidean geometry. The arbitrariness of this procedure of deriving metrical geometry from the properties of conics is removed by Lie's theory of congruence. We then arrive at the stage of thought which finds its expression in the modern treatment of the axioms of geometry.

The projective method leads to a discrimination, first made by Klein,³ of two varieties of Riemann's space; Klein calls these elliptic and spherical. They are also called the polar and antipodal forms of elliptic space. The latter names will here be used. The difference is strictly analogous to that between the diameters and the points of a sphere. In the polar form two straight lines in a plane always intersect in one and only one point; in the antipodal form they intersect always in two points, which are antipodes. According to the definition of geometry adopted in section VII. (*Axioms of Geometry*), the antipodal form is not to be termed "geometry," since any pair of coplanar straight lines intersect each other in two points. It may be called a "quasi-geometry." Similarly in the antipodal form two diameters always determine a plane, but two points on a sphere do not determine a great circle when they are antipodes, and two great circles always intersect in two points. Again, a plane does not form a boundary among lines through a point: we can pass from any one such line to any other without passing through the plane. But a great circle does divide the surface of a sphere. So, in the polar form, a complete straight line does not divide a plane, and a plane does not divide space, and does not, like a Euclidean plane, have two sides.⁴ But, in the antipodal form, a plane is, in these respects, like a Euclidean plane.

It is explained in section VII. in what sense the metrical geometry of the material world can be considered to be determinate and not a matter of arbitrary choice. The scientific

question as to the best available evidence concerning the nature of this geometry is one beset with difficulties of a peculiar kind. We are obstructed by the fact that all existing physical science assumes the Euclidean hypothesis. This hypothesis has been involved in all actual measurements of large distances, and in all the laws of astronomy and physics. The principle of simplicity would therefore lead us, in general, where an observation conflicted with one or more of those laws, to ascribe this anomaly, not to the falsity of Euclidean geometry, but to the falsity of the laws in question. This applies especially to astronomy. On the earth our means of measurement are many and direct, and so long as no great accuracy is sought they involve few scientific laws. Thus we acquire, from such direct measurements, a very high degree of probability that the space-constant, if not infinite, is yet large as compared with terrestrial distances. But astronomical distances and triangles can only be measured by means of the received laws of astronomy and optics, all of which have been established by assuming the truth of the Euclidean hypothesis. It therefore remains possible (until a detailed proof of the contrary is forthcoming) that a large but finite space-constant, with different laws of astronomy and optics, would have equally explained the phenomena. We cannot, therefore, accept the measurements of stellar parallaxes, &c., as conclusive evidence that the space-constant is large as compared with stellar distances. For the present, on grounds of simplicity, we may rightly adopt this view; but it must remain possible that, in view of some hitherto undiscovered discrepancy, a slight correction of the sort suggested might prove the simplest alternative. But conversely, a finite parallax for very distant stars, or a negative parallax for any star, could not be accepted as conclusive evidence that our geometry is non-Euclidean, unless it were shown—and this seems scarcely possible—that no modification of astronomy or optics could account for the phenomenon. Thus although we may admit a probability that the space-constant is large in comparison with stellar distances, a conclusive proof or disproof seems scarcely possible.

Finally, it is of interest to note that, though it is theoretically possible to prove, by scientific methods, that our geometry is non-Euclidean, it is wholly impossible to prove by such methods that it is accurately Euclidean. For the unavoidable errors of observation must always leave a slight margin in our measurements. A triangle might be found whose angles were certainly greater, or certainly less, than two right angles; but to prove them exactly equal to two right angles must always be beyond our powers. If, therefore, any man cherishes a hope of proving the exact truth of Euclid, such a hope must be based, not upon scientific, but upon philosophical considerations.

BIBLIOGRAPHY.—The bibliography appended to section VII. should be consulted in this connexion. Also, in addition to the citations already made, the following works may be mentioned.

For Lobatchewsky's writings, cf. *Urkunden zur Geschichte der nicht-euklidischen Geometrie*, by Nikolaj Iwanowitsch Lobatschewsky, by F. Engel and P. Stäckel (Leipzig, 1898). For John Bolyai's *Appendix*, cf. *Absolute Geometrie nach Johann Bolyai*, by J. Frischauf (Leipzig, 1872), and also the new edition of his father's large work, *Teutamen*, published by the Mathematical Society of Budapest; the second volume contains the appendix. Cf. also J. Frischauf, *Elemente der absoluten Geometrie* (Leipzig, 1876); M. L. Gérard, *Sur la géométrie non-Euclidienne* (thesis for doctorate) (Paris, 1862); de Tilly, *Essai sur les principes fondamentales de la géométrie et de la mécanique* (Bordeaux, 1870); Sir R. S. Ball, "On the Theory of Content," *Trans. Roy. Irish Acad.*, vol. xxix, (1889); F. Lindemann, "Mechanik bei projectiver Maassbestimmung," *Math. Ann.*, vol. vii.; W. K. Clifford, "Preliminary Sketch of Biquaternions," *Proc. of Lond. Math. Soc.* (1873), and *Coll. Works*; A. Buchheim, "On the Theory of Screws in Elliptic Space," *Proc. Lond. Math. Soc.*, vols. xv, xvii, xviii.; H. Cox, "On the Application of Quaternions and Grassmann's Algebra to different Kinds of Uniform Space," *Trans. Camb. Phil. Soc.* (1882); M. Dehn, "Die Legendrischen Sätze über die Winkelsumme im Dreieck," *Math. Ann.*, vol. 53 (1900), and "Über den Rauminhalt," *Math. Ann.*, vol. 55 (1902).

For expositions of the whole subject, cf. F. Klein, *Nicht-Euklidische Geometrie* (Göttingen, 1893); R. Bonola, *La Geometria non-Euclidea* (Bologna, 1906); P. Barbarin, *La Geometrie non-Euclidienne* (Paris, 1902); W. Killing, *Die nicht-Euklidischen Raumformen in analytischer Behandlung* (Leipzig, 1885). The last-named work also deals with geometry of more than three dimensions; in this connexion cf. also G. Veronese, *Fondamenti di geometria a più dimensioni ed a più spazii*

¹ Beltrami shows also that this definition agrees with that of Gauss.

² "Sur la théorie des foyers," *Nov. Ann.* vol. xii.

³ *Math. Annalen*, iv. vi., 1871-1872.

⁴ For an investigation of these and similar properties, see Whitehead, *Universal Algebra* (Cambridge, 1898), bk. vi. ch. ii. The polar form was independently discovered by Simoa Newcomb in 1877.

di unid rettilinee . . . (Padua, 1891, German translation, Leipzig, 1894); C. Fontené, *L'Hyperespace à (n-1) dimensions* (Paris, 1892); and A. N. Whitehead, *loc. cit.* Cf. also E. Study, "Über nicht-Euklidische und Liniengeometrie," *Jahr. d. Deutsch. Math. Ver.* vol. xv. (1906); W. Burnside, "On the Kinematics of non-Euclidean Space," *Proc. Lond. Math. Soc.* vol. xxvi. (1894). A bibliography on the subject up to 1878, has been published by G. B. Halsted, *Amer. Journ. of Math.* vols. i. and ii.; and one up to 1900 by R. Bonola, *Index operum ad geometriam absolutam spectantium* (1902, and Leipzig, 1903). (B. A. W. R.; A. N. W.)

VII. AXIOMS OF GEOMETRY

Until the discovery of the non-Euclidean geometries (Lobatchewsky, 1826 and 1829; J. Bolyai, 1832; B. Riemann, 1854),

geometry was universally considered as being exclusively the science of existent space. (See section *Theories of space*.)

VI. *Non-Euclidean Geometry.* In respect to the science, as thus conceived, two controversies may be noticed. First, there is the controversy respecting the absolute and relational theories of space. According to the absolute theory, which is the traditional view (held explicitly by Newton), space has an existence, in some sense whatever it may be, independent of the bodies which it contains. The bodies occupy space, and it is not intrinsically unmeaning to say that any definite body occupies *this* part of space, and not *that* part of space, without reference to other bodies occupying space. According to the relational theory of space, of which the chief exponent was Leibnitz,¹ space is nothing but a certain assemblage of the relations between the various particular bodies in space. The idea of space with no bodies in it is absurd. Accordingly there can be no meaning in saying that a body is *here* and not *there*, apart from a reference to the other bodies in the universe. Thus, on this theory, absolute motion is intrinsically unmeaning. It is admitted on all hands that in practice only relative motion is directly measurable. Newton, however, maintains in the *Principia* (scholium to the 8th definition) that it is indirectly measurable by means of the effects of "centrifugal force" as it occurs in the phenomena of rotation. This irrelevance of absolute motion (if there be such a thing) to science has led to the general adoption of the relational theory by modern men of science. But no decisive argument for either view has at present been elaborated.² Kant's view of space as being a form of perception at first sight appears to cut across this controversy. But he, saturated as he was with the spirit of the Newtonian physics, must (at least in both editions of the *Critique*) be classed with the upholders of the absolute theory. The form of perception has a type of existence proper to itself independently of the particular bodies which it contains. For example he writes:³ "Space does not represent any quality of objects by themselves, or objects in their relation to one another, *i.e.* space does not represent any determination which is inherent in the objects themselves, and would remain, even if all subjective conditions of intuition were removed."

The second controversy is that between the view that the axioms applicable to space are known only from experience, and the view that in some sense these axioms are given *a priori*. Both these views, thus broadly stated, are capable of various subtle modifications, and a discussion of them would merge into a general treatise on epistemology. The cruder forms of the *a priori* view have been made quite untenable by the modern mathematical discoveries. Geometers now profess ignorance in many respects of the exact axioms which apply to existent space, and it seems unlikely that a profound study of the question should thus obliterate *a priori* intuitions.

Another question irrelevant to this article, but with some relevance to the above controversy, is that of the derivation

¹ For an analysis of Leibnitz's ideas on space, cf. B. Russell, *The Philosophy of Leibnitz*, chs. viii.-x.

² Cf. Hon. Bertrand Russell, "Is Position in Time and Space Absolute or Relative?" *Mind*, n.s. vol. 10 (1901), and A. N. Whitehead, "Mathematical Concepts of the Material World," *Phil. Trans.* (1906), p. 205.

³ Cf. *Critique of Pure Reason*, 1st section: "Of Space," conclusion A, Max Müller's translation.

of our perception of existent space from our various types of sensation. This is a question for psychology.⁴

Definition of Abstract Geometry.—Existent space is the subject matter of only one of the applications of the modern science of abstract geometry, viewed as a branch of pure mathematics. Geometry has been defined⁵ as "the study of series of two or more dimensions." It has also been defined⁶ as "the science of cross classification." These definitions are founded upon the actual practice of mathematicians in respect to their use of the term "Geometry." Either of them brings out the fact that geometry is not a science with a determinate subject matter. It is concerned with any subject matter to which the formal axioms may apply. Geometry is not peculiar in this respect. All branches of pure mathematics deal merely with types of relations. Thus the fundamental ideas of geometry (*e.g.* those of *points* and *straight lines*) are not ideas of determinate entities, but of any entities for which the axioms are true. And a set of formal geometrical axioms cannot in themselves be true or false, since they are not determinate propositions, in that they do not refer to a determinate subject matter. The axioms are propositional functions.⁷ When a set of axioms is given, we can ask (1) whether they are consistent, (2) whether their "existence theorem" is proved, (3) whether they are independent. Axioms are consistent when the contradictory of any axiom cannot be deduced from the remaining axioms. Their existence theorem is the proof that they are true when the fundamental ideas are considered as denoting some determinate subject matter, so that the axioms are developed into determinate propositions. It follows from the logical law of contradiction that the proof of the existence theorem proves also the consistency of the axioms. This is the only method of proof of consistency. The axioms of a set are independent of each other when no axiom can be deduced from the remaining axioms of the set. The independence of a given axiom is proved by establishing the consistency of the remaining axioms of the set, together with the contradictory of the given axiom. The enumeration of the axioms is simply the enumeration of the hypotheses⁸ (with respect to the undetermined subject matter) of which some at least occur in each of the subsequent propositions.

Any science is called a "geometry" if it investigates the theory of the classification of a set of entities (the *points*) into classes (the *straight lines*), such that (1) there is one and only one class which contains any given pair of the entities, and (2) every such class contains more than two members. In the two geometries, important from their relevance to existent space, axioms which secure an order of the points on any line also occur. These geometries will be called "Projective Geometry" and "Descriptive Geometry." In projective geometry any two straight lines in a plane intersect, and the straight lines are closed series which return into themselves, like the circumference of a circle. In descriptive geometry two straight lines in a plane do not necessarily intersect, and a straight line is an open series without beginning or end. Ordinary Euclidean geometry is a descriptive geometry; it becomes a projective geometry when the so-called "points at infinity" are added.

Projective Geometry.

Projective geometry may be developed from two undefined fundamental ideas, namely, that of a "point" and that of a "straight line." These undetermined ideas take different specific meanings for the various specific subject matters to which projective geometry can be applied. The number of the axioms is always to some extent arbitrary, being dependent upon the verbal forms of statement which are adopted. They will

⁴ Cf. Ernst Mach, *Erkenntnis und Irrtum* (Leipzig); the relevant chapters are translated by T. J. McCormack, *Space and Geometry* (London, 1906); also A. Meinong, *Über die Stellung der Gegenstandstheorie im System der Wissenschaften* (Leipzig, 1907).

⁵ Cf. Russell, *Principles of Mathematics*, § 352 (Cambridge, 1903).

⁶ Cf. A. N. Whitehead, *The Axioms of Projective Geometry*, § 3 (Cambridge, 1906).

⁷ Cf. Russell, *Princ. of Math.*, ch. i.

⁸ Cf. Russell, *loc. cit.*, and G. Frege, "Über die Grundlagen der Geometrie," *Jahrbuch der Deutsch. Math. Ver.* (1906).

be presented¹ here as twelve in number, eight being "axioms of classification," and four being "axioms of order."

Axioms of Classification.—The eight axioms of classification are as follows:

1. Points form a class of entities with at least two members.
2. Any straight line is a class of points containing at least three members.
3. Any two distinct points lie in one and only one straight line.
4. There is at least one straight line which does not contain all the points.
5. If A, B, C are non-collinear points, and A' is on the straight line BC, and B' is on the straight line CA, then the straight lines AA' and BB' possess a point in common.

Definition.—If A, B, C are any three non-collinear points, the plane ABC is the class of points lying on the straight lines joining A with the various points on the straight line BC.

6. There is at least one plane which does not contain all the points.
7. There exists a plane α , and a point A not incident in α , such that any point lies in some straight line which contains both A and a point in α .

Definition.—Harm. (ABCD) symbolizes the following conjoint statements: (1) that the points A, B, C, D are collinear, and (2) that a quadrilateral can be found with one pair of opposite sides intersecting at A, with the other pair intersecting at C, and with its diagonals passing through B and D respectively. Then B and D are said to be "harmonic conjugates" with respect to A and C.

8. Harm. (ABCD) implies that B and D are distinct points.

In the above axioms 4 secures at least two dimensions, axiom 5 is the fundamental axiom of the plane, axiom 6 secures at least three dimensions, and axiom 7 secures at most three dimensions. From axioms 1-5 it can be proved that any two distinct points in a straight line determine that line, that any three non-collinear points in a plane determine that plane, that the straight line containing any two points in a plane lies wholly in that plane, and that any two straight lines in a plane intersect. From axioms 1-6 Desargues's well-known theorem on triangles in perspective can be proved.

The enunciation of this theorem is as follows: If ABC and A'B'C' are two coplanar triangles such that the lines AA', BB', CC' are concurrent, then the three points of intersection of BC and B'C' of CA and C'A', and of AB and A'B' are collinear; and conversely if the three points of intersection are collinear, the three lines are concurrent. The proof which can be applied is the usual projective proof by which a third triangle A"B"C" is constructed not coplanar with the other two, but in perspective with each of them.

It has been proved² that Desargues's theorem cannot be deduced from axioms 1-5, that is, if the geometry be confined to two dimensions. All the proofs proceed by the method of producing a specification of "points" and "straight lines" which satisfies axioms 1-5, and such that Desargues's theorem does not hold.

It follows from axioms 1-5 that Harm. (ABCD) implies Harm. (ADCB) and Harm. (CBAD), and that, if A, B, C be any three distinct collinear points, there exists at least one point D such that Harm. (ABCD). But it requires Desargues's theorem, and hence axiom 6, to prove that Harm. (ABCD) and Harm. (ABCD') imply the identity of D and D'.

The necessity for axiom 8 has been proved by G. Fano,³ who has produced a three dimensional geometry of fifteen points, i.e. a method of cross classification of fifteen entities, in which each straight line contains three points, and each plane contains seven straight lines. In this geometry axiom 8 does not hold. Also from axioms 1-6 and 8 it follows that Harm. (ABCD) implies Harm. (BCDA).

Definitions.—When two plane figures can be derived from one another by a single projection, they are said to be in perspective. When two plane figures can be derived one from the other by a finite series of perspective relations between intermediate figures, they

are said to be projectively related. Any property of a plane figure which necessarily also belongs to any projectively related figure, is called a projective property.

The following theorem, known from its importance as "the fundamental theorem of projective geometry," cannot be proved⁴ from axioms 1-8. The enunciation is: "A projective correspondence between the points on two straight lines is completely determined when the correspondents of three distinct points on one line are determined on the other." This theorem is equivalent⁵ (assuming axioms 1-8) to another theorem, known as Pappus's Theorem, namely: "If I and I' are two distinct coplanar lines, and A, B, C are three distinct points on I, and A', B', C' are three distinct points on I', then the three points of intersection of AA' and B'C', of A'B and CC', of BB' and C'A, are collinear." This theorem is obviously Pascal's well-known theorem respecting a hexagon inscribed in a conic, for the special case when the conic has degenerated into the two lines I and I'. Another theorem also equivalent (assuming axioms 1-8) to the fundamental theorem is the following:⁶ "If the three collinear pairs of points, A and A', B and B', C and C', are such that the three pairs of opposite sides of a complete quadrangle pass respectively through them, i.e. one pair through A and A' respectively, and so on, and if also the three sides of the quadrangle which pass through A, B, and C, are concurrent in one of the corners of the quadrangle, then another quadrangle can be found with the same relation to the three pairs of points, except that its three sides which pass through A, B, and C, are not concurrent."

Thus, if we choose to take any one of these three theorems as an axiom, all the theorems of projective geometry which do not require ordinal or metrical ideas for their enunciation can be proved. Also a conic can be defined as the locus of the points found by the usual construction, based upon Pascal's theorem, for points on the conic through five given points. But it is unnecessary to assume here any one of the suggested axioms; for the fundamental theorem can be deduced from the axioms of order together with axioms 1-8.

Axioms of Order.—It is possible to define (cf. Pieri, *loc. cit.*) the property upon which the order of points on a straight line depends. But to secure that this property does in fact range the points in a serial order, some axioms are required. A straight line is to be a closed series; thus, when the points are in order, it requires two points on the line to divide it into two distinct complementary segments, which do not overlap, and together form the whole line. Accordingly the problem of the definition of order reduces itself to the definition of these two segments formed by any two points on the line; and the axioms are stated relatively to these segments.

Definition.—If A, B, C are three collinear points, the points on the segment ABC are defined to be those points such as X, for which there exist two points Y and Y' with the property that Harm. (AYCY') and Harm. (BYXY') both hold. The supplementary segment ABC is defined to be the rest of the points on the line. This definition is elucidated by noticing that with our ordinary geometrical ideas, if B and X are any two points between A and C, then the two pairs of points, A and C, B and X, define an involution with real double points, namely, the Y and Y' of the above definition. The property of belonging to a segment ABC is projective, since the harmonic relation is projective.

The first three axioms of order (cf. Pieri, *loc. cit.*) are:

9. If A, B, C are three distinct collinear points, the supplementary segment ABC is contained within the segment BCA.
10. If A, B, C are three distinct collinear points, the common part of the segments BCA and CAB is contained in the supplementary segment ABC.
11. If A, B, C are three distinct collinear points, and D lies in the segment ABC, then the segment ADC is contained within the segment ABC.

From these axioms all the usual properties of a closed order follow. It will be noticed that, if A, B, C are any three collinear points, C is necessarily traversed in passing from A to B by one route along the line, and is not traversed in passing from A to B along the other route. Thus there is no meaning, as referred to closed straight lines, in the simple statement that C lies between A and B. But there may be a relation of separation between two pairs of collinear points, such as A and C, and B and D. The couple B and D is said to separate A and C, if

¹ This formulation—though not in respect to number—is in all essentials that of M. Pieri, cf. "I principi della Geometria di Posizione," *Accad. R. di Torino* (1898); also cf. Whitehead, *loc. cit.*

² Cf. G. Peano, "Sui fondamenti della Geometria," p. 73; *Rivista di matematica*, vol. iv. (1894), and D. Hilbert, *Grundlagen der Geometrie* (Leipzig, 1899); and R. F. Moulton, "A Simple non-Desarguesian Plane Geometry," *Trans. Amer. Math. Soc.*, vol. iii. (1902).

³ Cf. "Sui postulati fondamentali della geometria proiettiva," *Giorn. di matematica*, vol. xxx. (1891); also of Pieri, *loc. cit.*, and Whitehead, *loc. cit.*

⁴ Cf. Hilbert, *loc. cit.*; for a fuller exposition of Hilbert's proof cf. K. T. Vahlen, *Abstrakte Geometrie* (Leipzig, 1905), also Whitehead, *loc. cit.*

⁵ Cf. H. Wiener, *Jahresber. der Deutsch. Math. Ver.* vol. i. (1890); and F. Schur, "Über den Fundamentalsatz der projectiven Geometrie," *Math. Ann.* vol. li. (1899).

⁶ Cf. Hilbert, *loc. cit.*, and Whitehead, *loc. cit.*

the four points are collinear and D lies in the segment complementary to the segment ABC. The property of the separation of pairs of points by pairs of points is projective. Also it can be proved that Harm. (ABCD) implies that B and D separate A and C.

Definitions.—A series of entities arranged in a serial order, open or closed, is said to be *compact*, if the series contains no immediately consecutive entities, so that in traversing the series from any one entity to any other entity it is necessary to pass through entities distinct from either. It was the merit of R. Dedekind and of G. Cantor explicitly to formulate another fundamental property of series. The Dedekind property¹ as applied to an open series can be defined thus: An open series possesses the Dedekind property, if, however, it be divided into two mutually exclusive classes μ and ν , which (1) contain between them the whole series, and (2) are such that every member of μ precedes in the serial order every member of ν , there is always a member of the series, belonging to one of the two, μ or ν , which precedes every member of ν (other than itself if it belong to ν), and also succeeds every member of μ (other than itself if it belong to μ). Accordingly in an open series with the Dedekind property there is always a member of the series marking the junction of two classes such as μ and ν . An open series is *continuous* if it is compact and possesses the Dedekind property. A closed series can always be transformed into an open series by taking any arbitrary member as the first term and by taking one of the two ways round as the ascending order of the series. Thus the definitions of compactness and of the Dedekind property can be at once transferred to a closed series.

12. The last axiom of order is that there exists at least one straight line for which the point order possesses the Dedekind property.

It follows from axioms 1-12 by projection that the Dedekind property is true for all lines. Again the *harmonic system* ABC, where A, B, C are collinear points, is defined² thus: take the harmonic conjugates A', B', C' of each point with respect to the other two, again take the harmonic conjugates of each of the six points A, B, C, A', B', C' with respect to each pair of the remaining five, and proceed in this way by an unending series of steps. The set of points thus obtained is called the harmonic system ABC. It can be proved that a harmonic system is compact, and that every segment of the line containing it possesses members of it. Furthermore, it is easy to prove that the fundamental theorem holds for harmonic systems, in the sense that, if A, B, C are three points on a line l , and A', B', C' are three points on a line l' , and if by any two distinct series of projections A, B, C are projected into A', B', C', then any point of the harmonic system ABC corresponds to the same point of the harmonic system A'B'C' according to both the projective relations which are thus established between l and l' . It now follows immediately that the fundamental theorem must hold for all the points on the lines l and l' , since (as has been pointed out) harmonic systems are "everywhere dense" on their containing lines. Thus the fundamental theorem follows from the axioms of order.

A system of numerical coordinates can now be introduced, possessing the property that linear equations represent planes and straight lines. The outline of the argument by which this remarkable problem (in that "distance" is as yet undefined) is solved, will now be given. It is first proved that the points on any line can in a certain way be definitely associated with all the positive and negative real numbers, so as to form with them a one-one correspondence. The arbitrary elements in the establishment of this relation are the points on the line associated with 0, 1 and ∞ .

This association³ is most easily effected by considering a class of projective relations of the line with itself, called by F. Schur (*loc. cit.*) *prospectivities*.

Let l (fig. 69) be the given line, m and n any two lines intersecting at U on l , S and S' two points on n . Then a projective relation between l and itself is formed by projecting l from S on to m , and then by projecting m from S' back on to l . All such projective

relations, however m , n , S and S' be varied, are called "prospectivities," and U is the double point of the prospectivity. If a point O on l is related to A by a prospectivity, then all prospectivities,

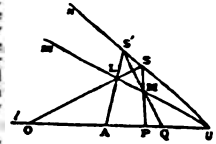

FIG. 69.

written $(OAU)^+(OBU)^+$, is defined to be that transformation of the line l into itself which is obtained by first applying the prospectivity $(OAU)^+$ and then applying the prospectivity $(OBU)^+$. Such a transformation, when the two summands have the same double point, is itself a prospectivity with that double point.

With this definition of addition it can be proved that prospectivities with the same double point satisfy all the axioms of magnitude. Accordingly they can be associated in a one-one correspondence with the positive and negative real numbers. Let E (fig. 70) be any point on l , distinct from O and U. Then the prospectivity $(OEU)^+$ is associated with unity, the prospectivity $(OOU)^+$ is associated with zero, and $(OUU)^+$ with ∞ . The prospectivities of the type $(OPU)^+$, where P is any point on the segment OEU, correspond to the positive numbers; also if P' is the harmonic conjugate of P with respect to O and U, the prospectivity $(OP'U)^+$ is associated with the corresponding negative number.

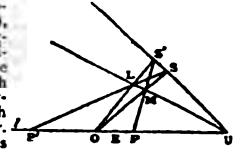

FIG. 70.

(The subjoined figure explains this relation of the positive and negative prospectivities.) Then any point P on l is associated with the same number as is the prospectivity $(OPU)^+$.

It can be proved that the order of the numbers in algebraic order of magnitude agrees with the order on the line of the associated points. Let the numbers, assigned according to the preceding specification, be said to be associated with the points according to the "numeration-system (OEU)."

The introduction of a coordinate system for a plane is now managed as follows: Take any triangle OUV in the plane, and on the lines OU and OV establish the numeration systems (OE_1U) and (OE_2V) , where E_1 and E_2 are arbitrarily chosen. Then (cf. fig. 71) if M and N are associated with the numbers x and y according to these systems, the coordinates of P are x and y . It then follows that the equation of a straight line is of the form $ax+by+c=0$. Both coordinates of any point on the line UV are infinite. This can be avoided by introducing homogeneous coordinates X, Y, Z, where $x=X/Z$, and $y=Y/Z$, and $Z=0$ is the equation of UV.

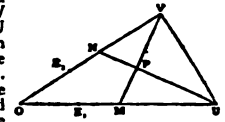

FIG. 71.

The procedure for three dimensions is similar. Let OUVW (fig. 72) be any tetrahedron, and associate points on OU, OV, OW with numbers according to the numeration systems (OE_1U) , (OE_2V) , and (OE_3W) . Let the planes VWP, WUP, UVP cut OU, OV, OW in L, M, N respectively; and let x, y, z be the numbers associated with L, M, N respectively. Then P is the point (x, y, z) . Also homogeneous coordinates can be introduced as before, thus avoiding the infinities on the plane UVW.

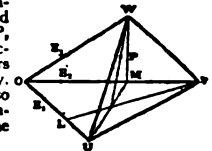

FIG. 72.

The cross ratio of a range of four collinear points can now be defined as a number characteristic of that range. Let the coordinates of any point P_r of the range P₁ P₂ P₃ P₄ be

$$\frac{\lambda_1 a + \mu_1 b + \sigma}{\lambda_r + \mu_r}, \quad \frac{\lambda_2 b + \mu_2 c}{\lambda_r + \mu_r}, \quad \frac{\lambda_3 c + \mu_3 d}{\lambda_r + \mu_r}, \quad (r = 1, 2, 3, 4)$$

and let $(\lambda_{\mu\sigma})$ be written for $\lambda_{\mu\sigma} - \lambda_{\mu\sigma}$. Then the cross ratio $[P_1 P_2 P_3 P_4]$ is defined to be the number $(\lambda_1 \mu_2)(\lambda_2 \mu_1) / (\lambda_3 \mu_4)(\lambda_4 \mu_3)$. The equality of the cross ratios of the ranges $(P_1 P_2 P_3 P_4)$ and $(Q_1 Q_2 Q_3 Q_4)$ is proved to be the necessary and sufficient condition for their mutual projectivity. The cross ratios of all harmonic ranges are then easily seen to be all equal to -1, by comparing with the range $(OE_1 UE_1')$ on the axis of x .

Thus all the ordinary propositions of geometry in which distance and angular measure do not enter otherwise than in cross ratios can now be enunciated and proved. Accordingly the greater part of the analytical theory of conics and quadrics belongs to geometry

¹ Cf. Dedekind, *Stetigkeit und irrationale Zahlen* (1872).

² Cf. v. Staudt, *Geometrie der Lage* (1847).

³ Cf. Pasch, *Vorlesungen über neuere Geometrie* (Leipzig, 1882), a classic work; also Fiedler, *Die darstellende Geometrie* (1st ed., 1871, 3rd ed., 1888); Clebsch, *Vorlesungen über Geometrie*, vol. iii.; Hilbert, *loc. cit.*; F. Schur, *Math. Ann.* Bd. lv. (1902); Vahlen, *loc. cit.*; Whitehead, *loc. cit.*

at this stage. The theory of distance will be considered after the principles of descriptive geometry have been developed.

Descriptive Geometry.

Descriptive geometry is essentially the science of multiple order for open series. The first satisfactory system of axioms was given by M. Pasch.¹ An improved version is due to G. Peano.² Both these authors treat the idea of the class of points constituting the segment lying between two points as an undefined fundamental idea. Thus in fact there are in this system two fundamental ideas, namely, of points and of segments. It is then easy enough to define the prolongations of the segments, so as to form the complete straight lines. D. Hilbert's³ formulation of the axioms is in this respect practically based on the same fundamental ideas. His work is justly famous for some of the mathematical investigations contained in it, but his exposition of the axioms is distinctly inferior to that of Peano. Descriptive geometry can also be considered⁴ as the science of a class of relations, each relation being a two-termed serial relation, as considered in the logic of relations, ranging the points between which it holds into a linear open order. Thus the relations are the straight lines, and the terms between which they hold are the points. But a combination of these two points of view yields⁵ the simplest statement of all. Descriptive geometry is then conceived as the investigation of an undefined fundamental relation between three terms (points); and when the relation holds between three points A, B, C, the points are said to be "in the [linear] order ABC."

O. Veblen's axioms and definitions, slightly modified, are as follows:—

1. If the points A, B, C are in the order ABC, they are in the order CBA.
2. If the points A, B, C are in the order ABC, they are not in the order BCA.
3. If the points A, B, C are in the order ABC, A is distinct from C.
4. If A and B are any two distinct points, there exists a point C such that A, B, C are in the order ABC.

Definition.—The line AB ($A \neq B$) consists of A and B, and of all points X in one of the possible orders, ABX, AXB, XAB. The points X in the order AXB constitute the *segment* AB.

5. If points C and D ($C \neq D$) lie on the line AB, then A lies on the line CD.
6. There exist three distinct points A, B, C not in any of the orders ABC, BCA, CAB.

7. If three distinct points A, B, C (fig. 73) do not lie on the same line, and D and E are two distinct points in the orders BCD and CEA, then a point F exists in the order AFB, and such that D, E, F are collinear.

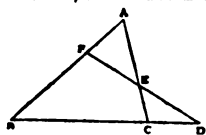

FIG. 73.

AB. The interior of the triangle ABC is formed by the points in segments such as PQ, where P and Q are points respectively on two of the segments BC, CA, AB.

8. There exists a plane ABC, which does not contain all the points.

Definition.—If A, B, C, D are four non-coplanar points, the space ABCD is the class of points which lie on any of the lines containing two points on the surface of the tetrahedron ABCD, the surface being formed by the interiors of the triangles ABC, BCD, DCA, DAB.

9. There exists a space ABCD which contains all the points.

¹ Cf. *loc. cit.*
² Cf. *I Principii di geometria* (Turin, 1889) and "Sui fondamenti della geometria," *Rivista di mat.* vol. iv. (1894).

³ Cf. *loc. cit.*
⁴ Cf. Vailanti, *Rivista di mat.* vol. iv. and Russell, *loc. cit.* § 376.
⁵ Cf. O. Veblen, "On the Projective Axioms of Geometry," *Trans. Amer. Math. Soc.* vol. iii. (1902).

10. The Dedekind property holds for the order of the points on any straight line.

It follows from axioms 1-9 that the points on any straight line are arranged in an open serial order. Also all the ordinary theorems respecting a point dividing a straight line into two parts, a straight line dividing a plane into two parts, and a plane dividing space into two parts, follow.

Again, in any plane α consider a line l and a point A (fig. 74). Let any point B divide l into two half-lines l_1 and l_2 . Then it can be proved that the set of half-lines, emanating from A and intersecting l_1 (such as m), are bounded by two half-lines, of which ABC is one. Let r be the other. Then it can be proved that r does not intersect l_1 . Similarly for the half-line, such as n , intersecting l_2 . Let s be its bounding half-line. Then two cases are possible. (1) The half-lines r and s are collinear, and together form one complete line. In this case, there is one and only one line (viz. $r+s$) through A and lying in α which does not intersect l . This is the Euclidean case, and the assumption that this case holds is the *Euclidean parallel axiom*. But (2) the half-lines r and s may not be collinear. In this case there will be an infinite number of lines, such as k for instance, containing A and lying in α , which do not intersect l . Then the lines through A in α are divided into two classes by reference to l , namely, the *secant* lines which intersect l , and the *non-secant* lines which do not intersect l . The two boundary non-secant lines, of which r and s are respectively halves, may be called the two parallels to l through A.

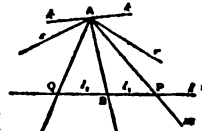

FIG. 74.

The perception of the possibility of case 2 constituted the starting-point from which Lobatschewsky constructed the first explicit coherent theory of non-Euclidean geometry, and thus created a revolution in the philosophy of the subject. For many centuries the speculations of mathematicians on the foundations of geometry were almost confined to hopeless attempts to prove the "parallel axiom" without the introduction of some equivalent axiom.⁶

Associated Projective and Descriptive Spaces.—A region of a projective space, such that one, and only one, of the two supplementary segments between any pair of points within it lies entirely within it, satisfies the above axioms (1-10) of descriptive geometry, where the points of the region are the descriptive points, and the portions of straight lines within the region are the descriptive lines. If the excluded part of the original projective space is a single plane, the Euclidean parallel axiom also holds, otherwise it does not hold for the descriptive space of the limited region. Again, conversely, starting from an original descriptive space an associated projective space can be constructed by means of the concept of *ideal points*.⁷ These are also called *projective points*, where it is understood that the simple points are the points of the original descriptive space. An *ideal point* is the class of straight lines which is composed of two coplanar lines a and b , together with the lines of intersection of all pairs of intersecting planes which respectively contain a and b , together with the lines of intersection with the plane ab of all planes containing any one of the lines (other than a or b) already specified as belonging to the ideal point. It is evident that, if the two original lines a and b intersect, the corresponding ideal point is nothing else than the whole class of lines which are concurrent at the point ab . But the essence of the definition is that an ideal point has an existence when the lines a and b do not intersect, so long as they are coplanar. An ideal point is termed *proper*, if the lines composing it intersect; otherwise it is *improper*.

A theorem essential to the whole theory is the following: if any two of the three lines a, b, c are coplanar, but the three lines are not all coplanar, and similarly for the lines a, b, d , then c and d are coplanar. It follows that any two lines belonging to an ideal point can be used as the pair of guiding lines in the definition. An ideal point is said to be *coherent* with a plane, if any of the lines composing it lie in the plane. An *ideal line* is the class of ideal points each of which is coherent with two given planes.

⁶ Cf. P. Stäckel and F. Engel, *Die Theorie der Parallellinien von Euklid bis auf Gauss* (Leipzig, 1895).

⁷ Cf. Pasch, *loc. cit.*, and R. Bonola, "Sulla introduzione degli enti impropri in geometria proiettiva," *Giorn. di mat.* vol. xxxviii. (1900); and Whitehead, *Axioms of Descriptive Geometry* (Cambridge, 1907).

If the planes intersect, the ideal line is termed *proper*, otherwise it is *improper*. It can be proved that any two planes, with which any two of the ideal points are both coherent, will serve as the guiding planes used in the definition. The ideal planes are defined as in projective geometry, and all the other definitions (for segments, order, &c.) of projective geometry are applied to the ideal elements. If an ideal plane contains some proper ideal points, it is called *proper*, otherwise it is *improper*. Every ideal plane contains some improper ideal points.

It can now be proved that all the axioms of projective geometry hold of the ideal elements as thus obtained; and also that the order of the ideal points as obtained by the projective method agrees with the order of the proper ideal points as obtained from that of the associated points of the descriptive geometry. Thus a projective space has been constructed out of the ideal elements, and the proper ideal elements correspond element by element with the associated descriptive elements. Thus the proper ideal elements form a region in the projective space within which the descriptive axioms hold. Accordingly, by substituting ideal elements, a descriptive space can always be considered as a region within a projective space. This is the justification for the ordinary use of the "points at infinity" in the ordinary Euclidean geometry; the reasoning has been transferred from the original descriptive space to the associated projective space of ideal elements; and with the Euclidean parallel axiom the improper ideal elements reduce to the ideal points on a single improper ideal plane, namely, the plane at infinity.¹

Congruence and Measurement.—The property of physical space which is expressed by the term "measurability" has now to be considered. This property has often been considered as essential to the very idea of space. For example, Kant writes,² "Space is represented as an infinite given quantity." This quantitative aspect of space arises from the measurability of distances, of angles, of surfaces and of volumes. These four types of quantity depend upon the two first among them as fundamental. The measurability of space is essentially connected with the idea of *congruence*, of which the simplest examples are to be found in the proofs of equality by the method of superposition, as used in elementary plane geometry. The mere concepts of "part" and of "whole" must of necessity be inadequate as the foundation of measurement, since we require the comparison as to quantity of regions of space which have no portions in common. The idea of congruence, as exemplified by the method of superposition in geometrical reasoning, appears to be founded upon that of the "rigid body," which moves from one position to another with its internal spatial relations unchanged. But unless there is a previous concept of the metrical relations between the parts of the body, there can be no basis from which to deduce that they are unchanged.

It would therefore appear as if the idea of the congruence, or metrical equality, of two portions of space (as empirically suggested by the motion of rigid bodies) must be considered as a fundamental idea incapable of definition in terms of those geometrical concepts which have already been enumerated. This was in effect the point of view of Pasch.³ It has, however, been proved by Sophus Lie⁴ that congruence is capable of definition without recourse to a new fundamental idea. This he does by means of his theory of finite continuous groups (see GROUPS, THEORY OF), of which the definition is possible in terms of our established geometrical ideas, remembering that co-ordinates have already been introduced. The displacement of a rigid body is simply a mode of defining to the senses a one-one transformation of all space into itself. For at any point of space a particle may be conceived to be placed, and to be rigidly connected with the rigid body; and thus there is a definite correspondence of any point of space with the new point occupied by the associated particle after displacement. Again two suc-

¹ The original idea (confined to this particular case) of ideal points is due to von Staudt (*loc. cit.*).

² Cf. *Critique*, "Trans. Aesth." Sect. 1.

³ Cf. *loc. cit.*

⁴ Cf. *Über die Grundlagen der Geometrie* (Leipzig, Ber., 1890); and *Theorie der Transformationsgruppen* (Leipzig, 1893), vol. iii.

cessive displacements of a rigid body from position A to position B, and from position B to position C, are the same in effect as one displacement from A to C. But this is the characteristic "group" property. Thus the transformations of space into itself defined by displacements of rigid bodies form a group.

Call this group of transformations a congruence-group. Now according to Lie a congruence-group is defined by the following characteristics:—

1. A congruence-group is a finite continuous group of one-one transformations, containing the identical transformation.

2. It is a sub-group of the general projective group, *i.e.* of the group of which any transformation converts planes into planes, and straight lines into straight lines.

3. An infinitesimal transformation can always be found satisfying the condition that, at least throughout a certain enclosed region, any definite line and any definite point on the line are latent, *i.e.* correspond to themselves.

4. No infinitesimal transformation of the group exists, such that, at least in the region for which (3) holds, a straight line, a point on it, and a plane through it, shall all be latent.

The property enunciated by conditions (3) and (4), taken together, is named by Lie "Free mobility in the infinitesimal." Lie proves the following theorems for a projective space:—

1. If the above four conditions are only satisfied by a group throughout part of projective space, this part either (a) must be the region enclosed by a real closed quadric, or (β) must be the whole of the projective space with the exception of a single plane. In case (a) the corresponding congruence group is the continuous group for which the enclosing quadric is latent; and in case (β) an imaginary conic (with a real equation) lying in the latent plane is also latent, and the congruence group is the continuous group for which the plane and conic are latent.

2. If the above four conditions are satisfied by a group throughout the whole of projective space, the congruence group is the continuous group for which some imaginary quadric (with a real equation) is latent.

By a proper choice of non-homogeneous co-ordinates the equation of any quadrics of the types considered, either in theorem 1 (a), or is theorem 2, can be written in the form $1 + c(x^2 + y^2 + z^2) = 0$, where c is negative for a real closed quadric, and positive for an imaginary quadric. Then the general infinitesimal transformation is defined by the three equations:

$$\left. \begin{aligned} dx/dt &= u - uy + uz + cx(ux + vy + wz), \\ dy/dt &= v - vx + vx + cy(ux + vy + wz), \\ dz/dt &= w - wx + wy + cz(ux + vy + wz). \end{aligned} \right\} (A)$$

In the case considered in theorem 1 (β), with the proper choice of co-ordinates the three equations defining the general infinitesimal transformation are:

$$\left. \begin{aligned} dx/dt &= u - uy + uz, \\ dy/dt &= v - vx + vx, \\ dz/dt &= w - wx + wy. \end{aligned} \right\} (B)$$

In this case the latent plane is the plane for which at least one of x, y, z are infinite, that is, the plane $0.x + 0.y + 0.z + 1 = 0$; and the latent conic is the conic in which the cone $x^2 + y^2 + z^2 = 0$ intersects the latent plane.

It follows from theorems 1 and 2 that there is not one unique congruence-group, but an indefinite number of them. There is one congruence-group corresponding to each closed real quadric, one to each imaginary quadric with a real equation, and one to each imaginary conic in a real plane and with a real equation. The quadric thus associated with each congruence-group is called the *absolute* for that group, and in the degenerate case of 1 (β) the absolute is the latent plane together with the latent imaginary conic. If the absolute is real, the congruence-group is *hyperbolic*; if imaginary, it is *elliptic*; if the absolute is a plane and imaginary conic, the group is parabolic. Metrical geometry is simply the theory of the properties of some particular congruence-group selected for study.

The definition of distance is connected with the corresponding congruence-group by two considerations in respect to a range of five points $(A_1, A_2, P_1, P_2, P_3)$, of which A_1 and A_2 are on the absolute.

Let $\{A_1P_1A_2P_3\}$ stand for the cross-ratio (as defined above) of the range $(A_1P_1A_2P_3)$, with a similar notation for the other ranges. Then

$$\log\{A_1P_1A_2P_3\} + \log\{A_1P_2A_3P_1\} = \log\{A_1P_1A_2P_3\},$$

and

(2), if the points A_1, A_2, P_1, P_2 are transformed into A'_1, A'_2, P'_1, P'_2 by any transformation of the congruence-group, (a) $\{A_1P_1A_2P_3\} = \{A'_1P'_1A'_2P'_3\}$, since the transformation is projective, and (β) A'_1, A'_2 are on the absolute since A_1 and A_2 are on it. Thus if we define

the distance P_1P_2 to be $\frac{1}{2}k \log [A_1P_1A_2P_2]$, where A_1 and A_2 are the points in which the line P_1P_2 cuts the absolute, and k is some constant, the two characteristic properties of distance, namely, (1) the addition of consecutive lengths on a straight line, and (2) the invariability of distances during a transformation of the congruence-group, are satisfied. This is the well-known Cayley-Klein projective definition¹ of distance, which was elaborated in view of the addition property alone, previously to Lie's discovery of the theory of congruence-groups. For a hyperbolic group when P_1 and P_2 are in the region enclosed by the absolute, $\log[A_1P_1A_2P_2]$ is real, and therefore k must be real. For an elliptic group A_1 and A_2 are conjugate imaginaries, and $\log[A_1P_1A_2P_2]$ is a pure imaginary, and k is chosen to be $\pm i$, where i is real and $i^2 = -1$.

Similarly the angle between two planes, p_1 and p_2 , is defined to be $(1/2k) \log (h_1p_1h_2p_2)$, where h_1 and h_2 are tangent planes to the absolute through the line p_1p_2 . The planes h_1 and h_2 are imaginary for an elliptic group, and also for a hyperbolic group when the planes p_1 and p_2 intersect at points within the region enclosed by the absolute. The development of the consequences of these metrical definitions is the subject of non-Euclidean geometry.

The definitions for the parabolic case can be arrived at as limits of those obtained in either of the other two cases by making k ultimately to vanish. It is also obvious that, if P_1 and P_2 be the points (x_1, y_1, z_1) and (x_2, y_2, z_2) , it follows from equations (B) above that $[(x_1 - x_2)^2 + (y_1 - y_2)^2 + (z_1 - z_2)^2]^{1/2}$ is unaltered by a congruence transformation and also satisfies the addition property for collinear distances. Also the previous definition of an angle can be adapted to this case, by making h_1 and h_2 to be the tangent planes through the line p_1p_2 to the imaginary conic. Similarly if p_1 and p_2 are intersecting lines, the same definition of an angle holds, where h_1 and h_2 are now the lines from the point p_1p_2 to the two points where the plane p_1p_2 cuts the imaginary conic. These points are in fact the "circular points at infinity" on the plane. The development of the consequences of these definitions for the parabolic case gives the ordinary Euclidean metrical geometry.

Thus the only metrical geometry for the whole of projective space is of the elliptic type. But the actual measure-relations (though not their general properties) differ according to the elliptic congruence-group selected for study. In a descriptive space a congruence-group should possess the four characteristics of such a group throughout the whole of the space. Then form the associated ideal projective space. The associated congruence-group for this ideal space must satisfy the four conditions throughout the region of the proper ideal points. Thus the boundary of this region is the absolute. Accordingly there can be no metrical geometry for the whole of a descriptive space unless its boundary (in the associated ideal space) is a closed quadric or a plane. If the boundary is a closed quadric, there is one possible congruence-group of the hyperbolic type. If the boundary is a plane (the plane at infinity), the possible congruence-groups are parabolic; and there is a congruence-group corresponding to each imaginary conic in this plane, together with a Euclidean metrical geometry corresponding to each such group. Owing to these alternative possibilities, it would appear to be more accurate to say that systems of quantities can be found in a space, rather than that space is a quantity.

Lie has also deduced² the same results with respect to congruence-groups from another set of defining properties, which explicitly assume the existence of a quantitative relation (the distance) between any two points, which is invariant for any transformation of the congruence-group.³

The above results, in respect to congruence and metrical geometry, considered in relation to existent space, have led to the doctrine⁴ that it is intrinsically unmeaning to ask which system of metrical geometry is true of the physical world. Any one of these systems can be applied, and in an indefinite number of ways. The only question before us is one of convenience in respect to simplicity of statement of the physical laws. This point of view seems to neglect the consideration that science is to be relevant to the definite perceiving minds of men; and that (neglecting the ambiguity introduced by the invariable slight inexactness of observation which is not relevant to this special doctrine)

¹ Cf. A. Cayley, "A Sixth Memoir on Quantics," *Trans. Roy. Soc.*, 1859, and *Coll. Papers*, vol. ii.; and F. Klein, *Math. Ann.* vol. iv., 1871.

² Cf. *loc. cit.*

³ For similar deductions from a third set of axioms, suggested in essence by Peano, *Riv. mat.* vol. iv. *loc. cit.* cf. Whitehead, *Desc. Geom.* *loc. cit.*

⁴ Cf. H. Poincaré, *La Science et l'Hypothèse*, ch. iii.

we have, in fact, presented to our senses a definite set of transformations forming a congruence-group, resulting in a set of measure relations which are in no respect arbitrary. Accordingly our scientific laws are to be stated relevantly to that particular congruence-group. Thus the investigation of the type (elliptic, hyperbolic or parabolic) of this special congruence-group is a perfectly definite problem, to be decided by experiment. The consideration of experiments adapted to this object requires some development of non-Euclidean geometry (see section VI., *Non-Euclidean Geometry*). But if the doctrine means that, assuming some sort of objective reality for the material universe, beings can be imagined, to whom either all congruence-groups are equally important, or some other congruence-group is specially important, the doctrine appears to be an immediate deduction from the mathematical facts. Assuming a definite congruence-group, the investigation of surfaces (or three-dimensional loci in space of four dimensions) with geodesic geometries of the form of metrical geometries of other types of congruence-groups forms an important chapter of non-Euclidean geometry. Arising from this investigation there is a widely-spread fallacy, which has found its way into many philosophic writings, namely, that the possibility of the geometry of existent three-dimensional space being other than Euclidean depends on the physical existence of Euclidean space of four or more dimensions. The foregoing exposition shows the baselessness of this idea.

BIBLIOGRAPHY.—For an account of the investigations on the axioms of geometry during the Greek period, see M. Cantor, *Vorlesungen über die Geschichte der Mathematik*, Bd. I. and iii.; T. L. Heath, *The Thirteen Books of Euclid's Elements, a New Translation from the Greek, with Introductory Essays and Commentary, Historical, Critical, and Explanatory* (Cambridge, 1908)—this work is the standard source of information; W. B. Frankland, *Euclid, Book I, with a Commentary* (Cambridge, 1905)—the commentary contains copious extracts from the ancient commentators. The next period of really substantive importance is that of the 18th century. The leading authors are: G. Saccheri, S. J., *Euclides ab omni nœvo vindicatus* (Milan, 1733). Saccheri was an Italian Jesuit who unconsciously discovered non-Euclidean geometry in the course of his efforts to prove its impossibility. J. H. Lambert, *Theorie der Parallellinien* (1766); A. M. Legendre, *Éléments de géométrie* (1794). An adequate account of the above authors is given by P. Stäckel and F. Engel, *Die Theorie der Parallellinien von Euklid bis auf Gauss* (Leipzig, 1895). The next period of time (roughly from 1800 to 1870) contains two streams of thought, both of which are essential to the modern analysis of the subject. The first stream is that which produced the discovery and investigation of non-Euclidean geometries, the second stream is that which has produced the geometry of position, comprising both projective and descriptive geometry not very accurately discriminated. The leading authors on non-Euclidean geometry are K. F. Gauss, in private letters to Schumacher, cf. Stäckel and Engel, *loc. cit.*; N. Lobatchewsky, rector of the university of Kazan, to whom the honour of the effective discovery of non-Euclidean geometry must be assigned. His first publication was at Kazan in 1826. His various memoirs have been re-edited by Engel; cf. *Urkunden zur Geschichte der nichteuklidischen Geometrie* by Stäckel and Engel, vol. i. "Lobatchewsky." J. Bolyai discovered non-Euclidean geometry apparently in independence of Lobatchewsky. His memoir was published in 1831 as an appendix to a work by his father W. Bolyai, *Tentamen juventutem. . .* This memoir has been separately edited by J. Frißchauf, *Absolute Geometrie nach J. Bolyai* (Leipzig, 1872); B. Riemann, *Über die Hypothesen, welche der Geometrie zu Grunde liegen* (1854); cf. *Gesamte Werke*, a translation in *The Collected Papers of W. K. Clifford*. This is a fundamental memoir on the subject and must rank with the work of Lobatchewsky. Riemann discovered elliptic metrical geometry, and Lobatchewsky hyperbolic geometry. A full account of Riemann's ideas, with the subsequent developments due to Clifford, F. Klein and W. Killing, will be found in *The Boston Colloquium for 1903* (New York, 1905), article "Forms of Non-Euclidean Space," by F. S. Woods, A. Cayley, *loc. cit.* (1859), and F. Klein, "Über die sogenannte nichteuklidische Geometrie," *Math. Ann.* vols. iv. and vi. (1871 and 1872) and when he elaborated the projective theory of distance; H. Helmholtz, "Über die tatsächlichen Grundlagen der Geometrie" (1866), and "Über die Thatachen, die der Geometrie zu Grunde liegen" (1868), both in his *Wissenschaftliche Abhandlungen*, vol. ii., and S. Lie, *loc. cit.* (1890 and 1893), between them elaborated the group theory of congruence.

The numberless works which have been written to suggest equivalent alternatives to Euclid's parallel axioms may be neglected as being of trivial importance, though many of them are marvels of geometric ingenuity.

The second stream of thought confined itself within the circle of ideas of Euclidean geometry. Its origin was really due to a

succession of great French mathematicians, for example, G. Monge, *Giométrie descriptive* (1800); J. V. Poncelet, *Traité des propriétés projectives des figures* (1822); M. Chasles, *Aperçu historique sur l'origine et le développement des méthodes en géométrie* (Bruxelles, 1837), and *Traité de géométrie supérieure* (Paris, 1837); and many others. But the works which have been, and are still, of decisive influence on thought as a store-house of ideas relevant to the foundations of geometry are K. G. C. von Staudt's two works, *Geometrie der Lage* (Nürnberg, 1847), and *Beiträge zur Geometrie der Lage* (Nürnberg, 1856, 3rd ed. 1860).

The final period is characterized by the successful production of exact systems of axioms, and by the final solution of problems which have occupied mathematicians for two thousand years. The successful analysis of the ideas involved in serial continuity is due to R. Dedekind, *Stetigkeit und irrationale Zahlen* (1872), and to G. Cantor, *Grundlagen einer allgemeinen Mannigfaltigkeitslehre* (Leipzig, 1883), and *Acta math.* vol. 2.

Complete systems of axioms have been stated by M. Pasch, *loc. cit.*; G. Peano, *loc. cit.*; M. Pieri, *loc. cit.*; B. Russell, *Principles of Mathematics*; O. Veblen, *loc. cit.*; and by G. Veronese in his treatise, *Fondamenti di geometria* (Padua, 1891; German transl. by A. Scheppe, *Grundzüge der Geometrie*, Leipzig, 1894). Most of the leading memoirs on special questions involved have been cited in the text; in addition there may be mentioned M. Pieri, "Nuovi principii di geometria proiettiva complessa," *Trans. Accad. R. d. Sci.* (Turin, 1905); E. H. Moore, "On the Projective Axioms of Geometry," *Trans. Amer. Math. Soc.*, 1902; O. Veblen and W. H. Bussey, "Finite Projective Geometries," *Trans. Amer. Math. Soc.*, 1905; A. B. Kempe, "On the Relation between the Logical Theory of Classes and the Geometrical Theory of Points," *Proc. Lond. Math. Soc.*, 1890; J. Royce, "The Relation of the Principles of Logic to the Foundations of Geometry," *Trans. of Amer. Math. Soc.*, 1905; A. Schoenflies, "Über die Möglichkeit einer projectiven Geometrie bei transfiniten (nichtarchimedischen) Massbestimmung," *Deutsch. M. V. Jahresh.*, 1906.

For general expositions of the bearings of the above investigations, cf. Hon. Bertrand Russell, *loc. cit.*; L. Couturat, *Les Principes des mathématiques* (Paris, 1905); H. Poincaré, *loc. cit.*; Russell and Whitehead, *Principia mathematica* (Cambridge, Univ. Press). The philosophers whose views on space and geometric truth deserve especial study are Descartes, Leibnitz, Hume, Kant and J. S. Mill. (A. N. W.)

GEOPONICI,¹ or *Scriptores rei rusticae*, the Greek and Roman writers on husbandry and agriculture. On the whole the Greeks paid less attention than the Romans to the scientific study of these subjects, which in classical times they regarded as a branch of economics. Thus Xenophon's *Oeconomicus* (see also *Memorabilia*, ii. 4) contains a eulogy of agriculture and its beneficial ethical effects, and much information is to be found in the writings of Aristotle and his pupil Theophrastus. About the same time as Xenophon, the philosopher Democritus of Abdera wrote a treatise *Περὶ Τεωπυλίας*, frequently quoted and much used by the later compilers of *Geoponica* (agricultural treatises). Greater attention was given to the subject in the Alexandrian period; a long list of names is given by Varro and Columella, amongst them Hiero II. and Attalus III. Philometor. Later, Cassius Dionysius of Utica translated and abridged the great work of the Carthaginian Mago, which was still further condensed by Diophanes of Nicaea in Bithynia for the use of King Deiotarus. From these and similar works Cassianus Bassus (q.v.) compiled his *Geoponica*. Mention may also be made of a little work *Περὶ Τεωπυλίων* by Michael Psellus (printed in Boissonade, *Anecdota Græca*, i.).

The Romans, aware of the necessity of maintaining a numerous and thriving order of agriculturists, from very early times endeavoured to instil into their countrymen both a theoretical and a practical knowledge of the subject. The occupation of the farmer was regarded as next in importance to that of the soldier, and distinguished Romans did not disdain to practise it. In furtherance of this object, the great work of Mago was translated into Latin by order of the senate, and the elder Cato wrote his *De agri cultura* (extant in a very corrupt state), a simple record in homely language of the rules observed by the old Roman landed proprietors rather than a theoretical treatise. He was followed by the two *Saserna* (father and son) and Gnaeus Tremellius Scrofa, whose works are lost. The learned Marcus Terentius Varro of Reate, when eighty years of age, composed his *Rerum rusticarum, libri tres*, dealing with agriculture, the

rearing of cattle, and the breeding of fishes. He was the first to systematize what had been written on the subject, and supplemented the labours of others by practical experience gained during his travels. In the Augustan age Julius Hyginus wrote on farming and bee-keeping, Sabinus Tiro on horticulture, and during the early empire Julius Graecinus and Julius Atticus on the culture of vines, and Cornelius Celsus (best known for his *De medicina*) on farming. The chief work of the kind, however, is that of Lucius Junius Moderatus Columella (q.v.). About the middle of the 2nd century the two Quintilii, natives of Troje, wrote on the subject in Greek. It is remarkable that Columella's work exercised less influence in Rome and Italy than in southern Gaul and Spain, where agriculture became one of the principal subjects of instruction in the superior educational establishments that were springing up in those countries. One result of this was the preparation of manuals of a popular kind for use in the schools. In the 3rd century Gargilius Martialis of Mauretania compiled a *Geoponica* in which medical botany and the veterinary art were included. The *De re rustica* of Palladius (4th century), in fourteen books, which is almost entirely borrowed from Columella, is greatly inferior in style and knowledge of the subject. It is a kind of farmer's calendar, in which the different rural occupations are arranged in order of the months. The fourteenth book (on forestry) is written in elegiacs (85 distichs). The whole of Palladius and considerable fragments of Martialis are extant.

The best edition of the *Scriptores rei rusticae* is by J. G. Schneider (1794-1797), and the whole subject is exhaustively treated by A. Magerstedt, *Bilder aus der römischen Landwirtschaft* (1858-1863); see also Teuffel-Schwabe, *Hist. of Roman Literature*, 54; C. F. Bähr in Ersch and Gruber's *Allgemeine Encyclopädie*.

GEORGE, SAINT (d. 303), the patron saint of England, Aragoa and Portugal. According to the legend given by Metaphrastes the Byzantine hagiologist, and substantially repeated in the Roman *Acta sanctorum* and in the Spanish breviary, he was born in Cappadocia of noble Christian parents, from whom he received a careful religious training. Other accounts place his birth at Lydda, but preserve his Cappadocian parentage. Having embraced the profession of a soldier, he rapidly rose under Diocletian to high military rank. In Persian Armenia he organized and energized the Christian community at Urmi (Urumiab), and even visited Britain on an imperial expedition. When Diocletian had begun to manifest a pronounced hostility towards Christianity, George sought a personal interview with him, in which he made deliberate profession of his faith, and earnestly remonstrating against the persecution which had begun, resigned his commission. He was immediately laid under arrest, and after various tortures, finally put to death at Nicomedia (his body being afterwards taken to Lydda) on the 23rd of April 303. His festival is observed on that anniversary by the entire Roman Catholic Church as a semi-duplex, and by the Spanish Catholics as a duplex of the first class with an octave. The day is also celebrated as a principal feast in the Orthodox Eastern Church, where the saint is distinguished by the titles *μεγαλόμεγαλον* and *τροπαιοφόρος*.

The historical basis of the tradition is particularly unsound, there being two claimants to the name and honour. Eusebius, *Hist. eccl.* viii. 5, writes: "Immediately on the promulgation of the edict (of Diocletian) a certain man of no mean origin, but highly esteemed for his temporal dignities, as soon as the decree was published against the churches in Nicomedia, stimulated by a divine zeal and excited by an ardent faith, took it as it was openly placed and posted up for public inspection, and tore it to shreds as a most profane and wicked act. This, too, was done when the two Caesars were in the city, the first of whom was the eldest and chief of all and the other held fourth grade of the imperial dignity after him. But this man, as the first that was distinguished there in this manner, after enduring what was likely to follow an act so daring, preserved his mind, calm and serene, until the moment when his spirit fled." Rivalling this anonymous martyr, who is often supposed to have been St George, is an earlier martyr briefly mentioned in the *Chronicon Pascale*: "In the year 225 of the Ascension of our Lord a persecution of the Christians took place, and many

¹The latinized form of a non-existent *Γεωπονισμὸς*, used for convenience.

suffered martyrdom, among whom also the Holy George was martyred."

Two Syrian church inscriptions bearing the name, one at Esra and the other at Shaka, found by Burckhardt and Porter, and discussed by J. Hogg in the *Transactions of the Royal Literary Society*, may with some probability be assigned to the middle of the 4th century. Calvin impugned the saint's existence altogether, and Edward Reynolds (1599-1676), bishop of Norwich, like Edward Gibbon a century later, made him one with George of Laodicea, called "the Cappadocian," the Arian bishop of Alexandria (see GEORGE OF LAODICEA).

Modern criticism, while rejecting this identification, is not unwilling to accept the main fact that an officer named Georgios, of high rank in the army, suffered martyrdom probably under Diocletian. In the canon of Pope Gelasius (494) George is mentioned in a list of those "whose names are justly revered among men, but whose acts are known only to God," a statement which implies that legends had already grown up around his name. The caution of Gelasius was not long preserved; Gregory of Tours, for example, asserts that the saint's relics actually existed in the French village of Le Maine, where many miracles were wrought by means of them; and Bede, while still explaining that the *Gesta Georgii* are reckoned apocryphal, commits himself to the statement that the martyr was beheaded under Dacian, king of Persia, whose wife Alexandra, however, adhered to the Christian faith. The great fame of George, who is revered alike by Eastern and Western Christendom and by Mahomedans, is due to many causes. He was martyred on the eve of the triumph of Christianity, his shrine was reared near the scene of a great Greek legend (Perseus and Andromeda), and his relics when removed from Lydda, where many pilgrims had visited them, to Zorava in the Hauran served to impress his fame not only on the Syrian population, but on their Moslem conquerors, and again on the Crusaders, who in grateful memory of the saint's intervention on their behalf at Antioch built a new cathedral at Lydda to take the place of the church destroyed by the Saracens. This cathedral was in turn destroyed by Saladin.

The connexion of St George with a dragon, familiar since the *Golden Legend* of Jacobus de Voragine, can be traced to the close of the 6th century. At Arsuf or Joppa—neither of them far from Lydda—Perseus had slain the sea-monster that threatened the virgin Andromeda, and George, like many another Christian saint, entered into the inheritance of veneration previously enjoyed by a pagan hero.¹ The exploit thus attaches itself to the very common Aryan myth of the sun-god as the conqueror of the powers of darkness.

The popularity of St George in England has never reached the height attained by St Andrew in Scotland, St David in Wales or St Patrick in Ireland. The council of Oxford in 1222 ordered that his feast should be kept as a national festival; but it was not until the time of Edward III. that he was made patron of the kingdom. The republics of Genoa and Venice were also under his protection.

See P. Heylin, *The History of . . . S. George of Cappadocia* (1637); S. Baring-Gould, *Curious Myths of the Middle Ages*; Fr. Gorres, "Der Ritter St George in der Geschichte, Legende und Kunst" (*Zeitschrift für wissenschaftliche Theologie*, xxx., 1887, Hft. i.); E. A. W. Budge, *The Martyrdom and Miracles of St George of Cappadocia*: the Coptic texts edited with an English translation (1888); Bolland, *Acta Sanctorum*, iii. 101; E. O. Gordon, *Saint George* (1907); M. H. Bulley, *St George for Merrie England* (1908).

¹G. A. Smith (*Hist. Geog. of Holy Land*, p. 164) points out another coincidence. "The Mahomedans who usually identify St George with the prophet Elijah, at Lydda confound his legend with one about Christ himself. Their name for Antichrist is Dajjal, and they have a tradition that Jesus will slay Antichrist by the gate of Lydda. The notion sprang from an ancient bas-relief of George and the Dragon on the Lydda church. But Dajjal may be derived by a very common confusion between *n* and *l*, from Dagon, whose name two neighbouring villages bear to this day, while one of the gates of Lydda used to be called the Gate of Dagon. It is a curious process by which the monster that symbolized heathenism conquered by Christianity has been evolved out of the first great rival of the God of Israel.

GEORGE I. [George Louis] (1660-1727), king of Great Britain and Ireland, born in 1660, was heir through his father Ernest Augustus to the hereditary lay bishopric of Osnabrück, and to the duchy of Calenberg, which formed one portion of the Hanoverian possessions of the house of Brunswick, whilst he secured the reversion of the other portion, the duchy of Celle or Zell, by his marriage (1682) with the heiress, his cousin Sophia Dorothea. The marriage was not a happy one. The morals of German courts in the end of the 17th century took their tone from the splendid profligacy of Versailles. It became the fashion for a prince to amuse himself with a mistress or more frequently with many mistresses simultaneously, and he was often content that the mistresses whom he favoured should be neither beautiful nor witty. George Louis followed the usual course. Count Königsmark—a handsome adventurer—seized the opportunity of paying court to the deserted wife. Conjugal infidelity was held at Hanover to be a privilege of the male sex. Count Königsmark was assassinated. Sophia Dorothea was divorced in 1694, and remained in seclusion till her death in 1726. When George IV., her descendant in the fourth generation, attempted in England to call his wife to account for sins of which he was himself notoriously guilty, free-spoken public opinion reprobated the offence in no measured terms. But in the Germany of the 17th century all free-spoken public opinion had been crushed out by the misery of the Thirty Years' War, and it was understood that princes were to arrange their domestic life according to their own pleasure.

The prince's father did much to raise the dignity of his family. By sending help to the emperor when he was struggling against the French and the Turks, he obtained the grant of a ninth electorate in 1692. His marriage with Sophia, the youngest daughter of Elizabeth the daughter of James I. of England, was not one which at first seemed likely to confer any prospect of advancement to his family. But though there were many persons whose birth gave them better claims than she had to the English crown, she found herself, upon the death of the duke of Gloucester, the next Protestant heir after Anne. The Act of Settlement in 1701 secured the inheritance to herself and her descendants. Being old and unambitious she rather permitted herself to be burthened with the honour than thrust herself forward to meet it. Her son George took a deeper interest in the matter. In his youth he had fought with determined courage in the wars of William III. Succeeding to the electorate on his father's death in 1698, he had sent a welcome reinforcement of Hanoverians to fight under Marlborough at Blenheim. With prudent persistence he attached himself closely to the Whigs and to Marlborough, refusing Tory offers of an independent command, and receiving in return for his fidelity a guarantee by the Dutch of his succession to England in the Barrier treaty of 1709. In 1714 when Anne was growing old, and Bolingbroke and the more reckless Tories were coquetting with the son of James II., the Whigs invited George's eldest son, who was duke of Cambridge, to visit England in order to be on the spot in case of need. Neither the elector nor his mother approved of a step which was likely to alienate the queen, and which was specially distasteful to himself, as he was on very bad terms with his son. Yet they did not set themselves against the strong wish of the party to which they looked for support, and it is possible that troubles would have arisen from any attempt to carry out the plan, if the deaths, first of the electress (May 28) and then of the queen (August 1, 1714), had not laid open George's way to the succession without further effort of his own.

In some respects the position of the new king was not unlike that of William III. a quarter of a century before. Both sovereigns were foreigners, with little knowledge of English politics and little interest in English legislation. Both sovereigns arrived at a time when party spirit had been running high, and when the task before the ruler was to still the waves of contention. In spite of the difference between an intellectually great man and an intellectually small one, in spite too of the difference between the king who began by choosing his ministers from both parties and the king who persisted in choosing his ministers.

from only one, the work of pacification was accomplished by George even more thoroughly than by William.

George I. was fortunate in arriving in England when a great military struggle had come to an end. He had therefore no reason to call upon the nation to make great sacrifices. All that he wanted was to secure for himself and his family a high position which he hardly knew how to occupy, to fill the pockets of his German attendants and his German mistresses, to get away as often as possible from the uncongenial islanders whose language he was unable to speak, and to use the strength of England to obtain petty advantages for his German principality. In order to do this he attached himself entirely to the Whig party, though he refused to place himself at the disposal of its leaders. He gave his confidence, not to Somers and Wharton and Marlborough, but to Stanhope and Townshend, the statesmen of the second rank. At first he seemed to be playing a dangerous game. The Tories, whom he rejected, were numerically superior to their adversaries, and were strong in the support of the country gentlemen and the country clergy. The strength of the Whigs lay in the towns and in the higher aristocracy. Below both parties lay the mass of the nation, which cared nothing for politics except in special seasons of excitement, and which asked only to be let alone. In 1715 a Jacobite insurrection in the north, supported by the appearance of the Pretender, the son of James II., in Scotland, was suppressed, and its suppression not only gave to the government a character of stability, but displayed its adversaries in an unfavourable light as the disturbers of the peace.

Even this advantage, however, would have been thrown away if the Whigs in power had continued to be animated by violent party spirit. What really happened was that the Tory leaders were excluded from office, but that the principles and prejudices of the Tories were admitted to their full weight in the policy of the government. The natural result followed. The leaders to whom no regard was paid continued in opposition. The rank and file, who would personally have gained nothing by a party victory, were conciliated into quiescence.

This mingling of two policies was conspicuous both in the foreign and the domestic actions of the reign. In the days of Queen Anne the Whig party had advocated the continuance of war with a view to the complete humiliation of the king of France, whom they feared as the protector of the Pretender, and in whose family connexion with the king of Spain they saw a danger for England. The Tory party, on the other hand, had been the authors of the peace of Utrecht, and held that France was sufficiently depressed. A fortunate concurrence of circumstances enabled George's ministers, by an alliance with the regent of France, the duke of Orleans, to pursue at the same time the Whig policy of separating France from Spain and from the cause of the Pretender, and the Tory policy of the maintenance of a good understanding with their neighbour across the Channel. The same eclecticism was discernible in the proceedings of the home government. The Whigs were conciliated by the repeal of the Schism Act and the Occasional Conformity Act, whilst the Tories were conciliated by the maintenance of the Test Act in all its vigour. The satisfaction of the masses was increased by the general well-being of the nation.

Very little of all that was thus accomplished was directly owing to George I. The policy of the reign is the policy of his ministers. Stanhope and Townshend from 1714 to 1717 were mainly occupied with the defence of the Hanoverian settlement. After the dismissal of the latter in 1717, Stanhope in conjunction with Sunderland took up a more decided Whig policy. The Occasional Conformity Act and the Schism Act were repealed in 1719. But the wish of the liberal Whigs to modify if not to repeal the Test Act remained unsatisfied. In the following year the bursting of the South Sea bubble, and the subsequent deaths of Stanhope in 1721 and of Sunderland in 1722, cleared the way for the accession to power of Sir Robert Walpole, to whom and not to the king was due the conciliatory policy which quieted Tory opposition by abstaining from pushing Whig principles to their legitimate consequences.

Nevertheless something of the honour due to Walpole must be reckoned to the king's credit. It is evident that at his accession his decisions were by no means unimportant. The royal authority was still able within certain limits to make its own terms. This support was so necessary to the Whigs that they made no resistance when he threw aside their leaders on his arrival in England. When by his personal intervention he dismissed Townshend and appointed Sunderland, he had no such social and parliamentary combination to fear as that which almost mastered his great-grandson in his struggle for power. If such a combination arose before the end of his reign it was owing more to his omitting to fulfil the duties of his station than from the necessity of the case. As he could talk no English, and his ministers could talk no German, he absented himself from the meetings of the cabinet, and his frequent absences from England and his want of interest in English politics strengthened the cabinet in its tendency to assert an independent position. Walpole at last by his skill in the management of parliament rose as a subject into the almost royal position denoted by the name of prime minister. In connexion with Walpole the force of wealth and station established the Whig aristocracy in a point of vantage from which it was afterwards difficult to dislodge them. Yet, though George had allowed the power which had been exercised by William and Anne to slip through his hands, it was understood to the last that if he chose to exert himself he might cease to be a mere cipher in the conduct of affairs. As late as 1727 Bolingbroke gained over one of the king's mistresses, the duchess of Kendal; and though her support of the fallen Jacobite took no effect, Walpole was not without fear that her reiterated entreaties would lead to his dismissal. The king's death in a carriage on his way to Hanover, in the night between 10th and 11th June in the same year, put an end to these apprehensions.

His only children were his successor George II. and Sophia Dorothea (1687-1757), who married in 1706 Frederick William, crown prince (afterwards king) of Prussia. She was the mother of Frederick the Great. (S. R. G.)

See the standard English histories. A recent popular work is L. Melville's *The First George in Hanover and England* (1908).

GEORGE II. [George Augustus] (1683-1760), king of Great Britain and Ireland, the only son of George I., was born in 1683. In 1705 he married Wilhelmina Caroline of Anspach. In 1706 he was created earl of Cambridge. In 1708 he fought bravely at Oudenarde. At his father's accession to the English throne he was thirty-one years of age. He was already on bad terms with his father. The position of an heir-apparent is in no case an easy one to fill with dignity, and the ill-treatment of the prince's mother by his father was not likely to strengthen in him a reverence for paternal authority. It was most unwillingly that, on his first journey to Hanover in 1716, George I. appointed the prince of Wales guardian of the realm during his absence. In 1717 the existing ill-feeling ripened into an open breach. At the baptism of one of his children, the prince selected one godfather whilst the king persisted in selecting another. The young man spoke angrily, was ordered into arrest, and was subsequently commanded to leave St James's and to be excluded from all court ceremonies. The prince took up his residence at Leicester House, and did everything in his power to support the opposition against his father's ministers.

When therefore George I. died in 1727, it was generally supposed that Walpole would be at once dismissed. The first direction of the new king was that Sir Spencer Compton would draw up the speech in which he was to announce to the privy council his accession. Compton, not knowing how to set about his task, applied to Walpole for aid. Queen Caroline took advantage of this evidence of incapacity, advocated Walpole's cause with her husband and procured his continuance in office. This curious scene was indicative of the course likely to be taken by the new sovereign. His own mind was incapable of rising above the merest details of business. He made war in the spirit of a drill-sergeant, and he economized his income with the minute regularity of a clerk. A blunder of a master of the ceremonies

in marshalling the attendants on a levee put him out of temper. He took the greatest pleasure in counting his money piece by piece, and he never forgot a date. He was above all things methodical and regular. "He seems," said one who knew him well, "to think his having done a thing to-day an unanswerable reason for his doing it to-morrow."

Most men so utterly immersed in details would be very impracticable to deal with. They would obstinately refuse to listen to a wisdom and prudence which meant nothing in their ears, and which brought home to them a sense of their own inferiority. It was the happy peculiarity of George II. that he was exempt from this failing. He seemed to have an instinctive understanding that such and such persons were either wiser or even stronger than himself, and when he had once discovered that, he gave way with scarcely a struggle. Thus it was that, though in his domestic relations he was as loose a liver as his father had been, he allowed himself to be guided by the wise but unobtrusive counsels of his wife until her death in 1737, and that when once he had recognized Walpole's superiority he allowed himself to be guided by the political sagacity of the great minister. It is difficult to exaggerate the importance of such a temper upon the development of the constitution. The apathy of the nation in all but the most exciting political questions, fostered by the calculated conservatism of Walpole, had thrown power into the hands of the great landowners. They maintained their authority by supporting a minister who was ready to make use of corruption, wherever corruption was likely to be useful, and who could veil over the baseness of the means which he employed by his talents in debate and in finance. To shake off a combination so strong would not have been easy. George II. submitted to it without a struggle.

So strong indeed had the Whig aristocracy grown that it began to lose its cohesion. Walpole was determined to monopolize power, and he dismissed from office all who ventured to oppose him. An opposition formidable in talents was gradually formed. In its composite ranks were to be found Tories and discontented Whigs, discarded official hacks who were hungry for the emoluments of office, and youthful purists who fancied that if Walpole were removed, bribes and pensions would cease to be attractive to a corrupt generation. Behind them was Bolingbroke, excluded from parliament but suggesting every party move. In 1737 the opposition acquired the support of Frederick, prince of Wales. The young man, weak and headstrong, rebelled against the strict discipline exacted by his father. His marriage in 1736 to Augusta of Saxony brought on an open quarrel. In 1737, just as the princess of Wales was about to give birth to her first child, she was hurried away by her husband from Hampton Court to St James's Palace at the imminent risk of her life, simply in order that the prince might show his spite to his father who had provided all necessary attendance at the former place. George ordered his son to quit St James's, and to absent himself from court. Frederick in disgrace gave the support of his name, and he had nothing else to give, to the opposition. Later in the year 1737, on the 20th of November, Queen Caroline died. In 1742 Walpole, weighed down by the unpopularity both of his reluctance to engage in a war with Spain and of his supposed remissness in conducting the operations of that war, was driven from office. His successors formed a composite ministry in which Walpole's old colleagues and Walpole's old opponents were alike to be found.

The years which followed settled conclusively, at least for this reign, the constitutional question of the power of appointing ministers. The war between Spain and England had broken out in 1739. In 1741 the death of the emperor Charles VI. brought on the war of the Austrian succession. The position of George II. as a Hanoverian prince drew him to the side of Maria Theresa through jealousy of the rising Prussian monarchy. Jealousy of France led England in the same direction, and in 1741 a subsidy of £300,000 was voted to Maria Theresa. The king himself went to Germany and attempted to carry on the war according to his own notions. Those notions led him to regard the safety of Hanover as of far more importance than

the wishes of England. Finding that a French army was about to march upon his German states, he concluded with France a treaty of neutrality for a year without consulting a single English minister. In England the news was received with feelings of disgust. The expenditure of English money and troops was to be thrown uselessly away as soon as it appeared that Hanover was in the slightest danger. In 1742 Walpole was no longer in office. Lord Wilmington, the nominal head of the ministry, was a mere cipher. The ablest and most energetic of his colleagues, Lord Carteret (afterwards Granville), attached himself specially to the king, and sought to maintain himself in power by his special favour and by brilliant achievements in diplomacy.

In part at least by Carteret's mediation the peace of Breslau was signed, by which Maria Theresa ceded Silesia to Frederick (July 28, 1742). Thus relieved on her northern frontier, she struck out vigorously towards the west. Bavaria was overrun by her troops. In the beginning of 1743 one French army was driven across the Rhine. On June 27th another French army was defeated by George II. in person at Dettingen. Victory brought elation to Maria Theresa. Her war of defence was turned into a war of vengeance. Bavaria was to be annexed. The French frontier was to be driven back. George II. and Carteret after some hesitation placed themselves on her side. Of the public opinion of the political classes in England they took no thought. Hanoverian troops were indeed to be employed in the war, but they were to be taken into British pay. Collisions between British and Hanoverian officers were frequent. A storm arose against the preference shown to Hanoverian interests. After a brief struggle Carteret, having become Lord Granville by his mother's death, was driven from office in November 1744.

Henry Pelham, who had become prime minister in the preceding year, thus saw himself established in power. By the acceptance of this ministry, the king acknowledged that the function of choosing a ministry and directing a policy had passed from his hands. In 1745 indeed he recalled Granville, but a few days were sufficient to convince him of the futility of his attempt, and the effort to exclude Pitt at a later time proved equally fruitless.

Important as were the events of the remainder of the reign, therefore, they can hardly be grouped round the name of George II. The resistance to the invasion of the Young Pretender in 1745, the peace of Aix-la-Chapelle in 1748, the great war ministry of Pitt at the close of the reign, did not receive their impulse from him. He had indeed done his best to exclude Pitt from office. He disliked him on account of his opposition in former years to the sacrifices demanded by the Hanoverian connexion. When in 1756 Pitt became secretary of state in the Devonshire administration, the king bore the yoke with difficulty. Early in the next year he complained of Pitt's long speeches as being above his comprehension, and on April 5, 1757, he dismissed him, only to take him back shortly after, when Pitt, coalescing with Newcastle, became master of the situation. Before Pitt's dismissal George II. had for once an opportunity of placing himself on the popular side, though, as was the case of his grandson during the American war, it was when the popular side happened to be in the wrong. In the true spirit of a martinet, he wished to see Admiral Byng executed. Pitt urged the wish of the House of Commons to have him pardoned. "Sir," replied the king, "you have taught me to look for the sense of my subjects in another place than in the House of Commons." When George II. died in 1760, he left behind him a settled understanding that the monarchy was one of the least of the forces by which the policy of the country was directed. To this end he had contributed much by his disregard of English opinion in 1743; but it may fairly be added that, but for his readiness to give way to irresistible adversaries, the struggle might have been far more bitter and severe than it was.

Of the connexion between Hanover and England in this reign two memorials remain more pleasant to contemplate than the records of parliamentary and ministerial intrigues. With the support of George II., amidst the derision of the English fashionable world, the Hanoverian Handel produced in England those

masterpieces which have given delight to millions, whilst the foundation of the university of Göttingen by the same king opened a door through which English political ideas afterwards penetrated into Germany.

George II. had three sons,—Frederick Louis (1707-1751); George William (1717-1718); and William Augustus, duke of Cumberland (1721-1765); and five daughters, Anne (1709-1759), married to William, prince of Orange, 1734; Amelia Sophia Eleonora (1711-1786); Elizabeth Caroline (1713-1757); Mary (1723-1772), married to Frederick, landgrave of Hesse-Cassel, 1740; Louisa (1724-1751), married to Frederick V., king of Denmark, 1743. (S. R. G.)

See Lord Hervey, *Memoirs of the Reign of George II.*, ed. by J. W. Croker (3 vols., London, 1884); Horace Walpole, *Memoirs of the Reign of George II.*, with notes by Lord Holland (3 vols., 2nd ed., 1847).

GEORGE III. [George William Frederick] (1738-1820), king of Great Britain and Ireland, son of Frederick, prince of Wales, and grandson of George II., whom he succeeded in 1760, was born on the 4th of June 1738. After his father's death in 1751 he had been educated in seclusion from the fashionable world under the care of his mother and of her favourite counsellor the earl of Bute. He had been taught to revere the maxims of Bolingbroke's "Patriot King," and to believe that it was his appointed task in life to break the power of the Whig houses resting upon extensive property and the influence of patronage and corruption. That power had already been gravely shaken. The Whigs from their incompetency were obliged when the Seven Years' War broke out to leave its management in the hands of William Pitt. The nation learned to applaud the great war minister who succeeded where others had failed, and whose immaculate purity put to shame the ruck of barterers of votes for places and pensions.

In some sort the work of the new king was the continuation of the work of Pitt. But his methods were very different. He did not appeal to any widely spread feeling or prejudice; nor did he disdain the use of the arts which had maintained his opponents in power. The patronage of the crown was to be really as well as nominally his own; and he calculated, not without reason, that men would feel more flattered in accepting a place from a king than from a minister. The new Toryism of which he was the founder was no recurrence to the Toryism of the days of Charles II. or even of Anne. The question of the amount of toleration to be accorded to Dissenters had been entirely laid aside. The point at issue was whether the crown should be replaced in the position which George I. might have occupied at the beginning of his reign, selecting the ministers and influencing the deliberations of the cabinet. For this struggle George III. possessed no inconsiderable advantages. With an inflexible tenacity of purpose, he was always ready to give way when resistance was really hopeless. As the first English-born sovereign of his house, speaking from his birth the language of his subjects, he found a way to the hearts of many who never regarded his predecessors as other than foreign intruders. The contrast, too, between the pure domestic life which he led with his wife Charlotte, whom he married in 1761, and the habits of three generations of his house, told in his favour with the vast majority of his subjects. Even his marriage had been a sacrifice to duty. Soon after his accession he had fallen in love with Lady Sarah Lennox, and had been observed to ride morning by morning along the Kensington Road, from which the object of his affections was to be seen from the lawn of Holland House making hay, or engaged in some other ostensible employment. Before the year was over Lady Sarah appeared as one of the queen's bridesmaids, and she was herself married to Sir Charles Bunbury in 1762.

At first everything seemed easy to him. Pitt had come to be regarded by his own colleagues as a minister who would pursue war at any price, and in getting rid of Pitt in 1761 and in carrying on the negotiations which led to the peace of Paris in 1762, the king was able to gather round him many persons who would not be willing to acquiesce in any permanent change in the system of government. With the signature of the peace his real diffi-

culties began. The Whig houses, indeed, were divided amongst themselves by personal rivalries. But they were none of them inclined to let power and the advantages of power slip from their hands without a struggle. For some years a contest of influence was carried on without dignity and without any worthy aim. The king was not strong enough to impose upon parliament a ministry of his own choice. But he gathered round himself a body of dependants known as the king's friends, who were secure of his favour, and who voted one way or the other according to his wishes. Under these circumstances no ministry could possibly be stable; and yet every ministry was strong enough to impose some conditions on the king. Lord Bute, the king's first choice, resigned from a sense of his own incompetency in 1763. George Grenville was in office till 1765; the marquis of Rockingham till 1766; Pitt, becoming earl of Chatham, till illness compelled him to retire from the conduct of affairs in 1767, when he was succeeded by the duke of Grafton. But a struggle of interests could gain no real strength for any government, and the only chance the king had of effecting a permanent change in the balance of power lay in the possibility of his associating himself with some phase of strong national feeling, as Pitt had associated himself with the war feeling caused by the dissatisfaction spread by the weakness and ineptitude of his predecessors.

Such a chance was offered by the question of the right to tax America. The notion that England was justified in throwing on America part of the expenses caused in the late war was popular in the country, and no one adopted it more pertinaciously than George III. At the bottom the position which he assumed was as contrary to the principles of parliamentary government as the encroachments of Charles I. had been. But it was veiled in the eyes of Englishmen by the prominence given to the power of the British parliament rather than to the power of the British king. In fact the theory of parliamentary government, like most theories after their truth has long been universally acknowledged, had become a superstition. Parliaments were held to be properly vested with authority, not because they adequately represented the national will, but simply because they were parliaments. There were thousands of people in England to whom it never occurred that there was any good reason why a British parliament should be allowed to levy a duty on tea in the London docks and should not be allowed to levy a duty on tea at the wharves of Boston. Undoubtedly George III. derived great strength from his honest participation in this mistake. Contending under parliamentary forms, he did not wound the susceptibilities of members of parliament, and when at last in 1770 he appointed Lord North—a minister of his own selection—prime minister, the object of his ambition was achieved with the concurrence of a large body of politicians who had nothing in common with the servile band of the king's friends.

As long as the struggle with America was carried on with any hope of success they gained that kind of support which is always forthcoming to a government which shares in the errors and prejudices of its subjects. The expulsion of Wilkes from the House of Commons in 1769, and the refusal of the House to accept him as a member after his re-election, raised a grave constitutional question in which the king was wholly in the wrong; and Wilkes was popular in London and Middlesex. But his case roused no national indignation, and when in 1774 those sharp measures were taken with Boston which led to the commencement of the American rebellion in 1775, the opposition to the course taken by the king made little way either in parliament or in the country. Burke might point out the folly and inexpediency of the proceedings of the government. Chatham might point out that the true spirit of English government was to be representative, and that that spirit was being violated at home and abroad. George III., who thought that the first duty of the Americans was to obey himself, had on his side the mass of unreflecting Englishmen who thought that the first duty of all colonists was to be useful and submissive to the mother-country. The natural dislike of every country engaged in war to see itself defeated was on his side, and when the news of Burgoyne's surrender at Saratoga arrived

in 1777, subscriptions of money to raise new regiments poured freely in.

In March 1778 the French ambassador in London announced that a treaty of friendship and commerce had been concluded between France and the new United States of America. Lord North was anxious to resign power into stronger hands, and begged the king to receive Chatham as his prime minister. The king would not hear of it. He would have nothing to say to "that perfidious man" unless he would humble himself to enter the ministry as North's subordinate. Chatham naturally refused to do anything of the kind, and his death in the course of the year relieved the king of the danger of being again overruled by too overbearing a minister. England was now at war with France, and in 1779 she was also at war with Spain.

George III. was still able to control the disposition of office. He could not control the course of events. His very ministers gave up the struggle as hopeless long before he would acknowledge the true state of the case. Before the end of 1779, two of the leading members of the cabinet, Lords Gower and Weymouth, resigned rather than bear the responsibility of so ruinous an enterprise as the attempt to overpower America and France together. Lord North retained office, but he acknowledged to the king that his own opinion was precisely the same as that of his late colleagues.

The year 1780 saw an agitation rising in the country for economical reform, an agitation very closely though indirectly connected with the war policy of the king. The public meetings held in the country on this subject have no unimportant place in the development of the constitution. Since the presentation of the Kentish petition in the reign of William III. there had been from time to time upheavings of popular feeling against the doings of the legislature, which kept up the tradition that parliament existed in order to represent the nation. But these upheavings had all been so associated with ignorance and violence as to make it very difficult for men of sense to look with displeasure upon the existing emancipation of the House of Commons from popular control. The Sacheverell riots, the violent attacks upon the Excise Bill, the no less violent advocacy of the Spanish War, the declamations of the supporters of Wilkes at a more recent time, and even in this very year the Gordon riots, were not likely to make thoughtful men anxious to place real power in the hands of the classes from whom such exhibitions of folly proceeded. But the movement for economical reform was of a very different kind. It was carried on soberly in manner, and with a definite practical object. It asked for no more than the king ought to have been willing to concede. It attacked useless expenditure upon sinecures and unnecessary offices in the household, the only use of which was to spread abroad corruption amongst the upper classes. George III. could not bear to be interfered with at all, or to surrender any element of power which had served him in his long struggle with the Whigs. He held out for more than another year. The news of the capitulation of Yorktown reached London on the 25th of November 1781. On the 20th of March 1782 Lord North resigned.

George III. accepted the consequences of defeat. He called the marquis of Rockingham to office at the head of a ministry composed of pure Whigs and of the disciples of the late earl of Chatham, and he authorized the new ministry to open negotiations for peace. Their hands were greatly strengthened by Rodney's victory over the French fleet, and the failure of the combined French and Spanish attack upon Gibraltar; and before the end of 1782 a provisional treaty was signed with America, preliminaries of peace with France and Spain being signed early in the following year. On the 3rd of September 1783 the definitive treaties with the three countries were simultaneously concluded. "Sir," said the king to John Adams, the first minister of the United States of America accredited to him, "I wish you to believe, and that it may be understood in America, that I have done nothing in the late contest but what I thought myself indispensably bound to do by the duty which I owed to my people. I will be very frank with you. I was the last to consent to the separation: but the separation having been made

and having become inevitable, I have always said, as I say now, that I would be the first to meet the friendship of the United States as an independent power."

Long before the signature of the treaties Rockingham died (July 1, 1782). The king chose Lord Shelburne, the head of the Chatham section of the government, to be prime minister. Fox and the followers of Rockingham refused to serve except under the duke of Portland, a minister of their own selection, and resigned office. The old constitutional struggle of the reign was now to be fought out once more. Fox, too weak to obtain a majority alone, coalesced with Lord North, and defeated Shelburne in the House of Commons on the 27th of February 1783. On the 2nd of April the coalition took office, with Portland as nominal prime minister, and Fox and North the secretaries of state as its real heads.

This attempt to impose upon him a ministry which he disliked made the king very angry. But the new cabinet had a large majority in the House of Commons, and the only chance of resisting it lay in an appeal to the country against the House of Commons. Such an appeal was not likely to be responded to unless the ministers discredited themselves with the nation. George III. therefore waited his time. Though a coalition between men bitterly opposed to one another in all political principles and drawn together by nothing but love of office was in itself discreditable, it needed some more positive cause of dissatisfaction to arouse the constituencies, which were by no means so ready to interfere in political disputes at that time as they are now. Such dissatisfaction was given by the India Bill, drawn up by Burke. As soon as it had passed through the Commons the king hastened to procure its rejection in the House of Lords by his personal intervention with the peers. He authorized Lord Temple to declare in his name that he would count any peer who voted for the bill as his enemy. On the 17th of December 1783 the bill was thrown out. The next day ministers were dismissed. William Pitt became prime minister. After some weeks' struggle with a constantly decreasing majority in the Commons, the king dissolved parliament on the 25th of March 1784. The country rallied round the crown and the young minister, and Pitt was firmly established in office.

There can be no reasonable doubt¹ that Pitt not only took advantage of the king's intervention in the Lords, but was cognizant of the intrigue before it was actually carried out. It was upon him, too, that the weight of reconciling the country to an administration formed under such circumstances lay. The general result, so far as George III. was concerned, was that to all outward appearance he had won the great battle of his life. It was he who was to appoint the prime minister, not any clique resting on a parliamentary support. But the circumstances under which the victory was won were such as to place the constitution in a position very different from that in which it would have been if the victory had been gained earlier in the reign. Intrigue there was indeed in 1783 and 1784 as there had been twenty years before. Parliamentary support was conciliated by Pitt by the grant of royal favours as it had been in the days of Bute. The actual blow was struck by a most questionable message to individual peers. But the main result of the whole political situation was that George III. had gone a long way towards disentangling the reality of parliamentary government from its accidents. His ministry finally stood because it had appealed to the constituencies against their representatives. Since then it has properly become a constitutional axiom that no such appeal should be made by the crown itself. But it may reasonably be doubted whether any one but the king was at that time capable of making the appeal. Lord Shelburne, the leader of the ministry expelled by the coalition, was unpopular in the country, and the younger Pitt had not had time to make his great abilities known beyond a limited circle. The real question for the constitutional historian to settle is not whether under ordinary circumstances a king is the proper person to place himself really as well as nominally at the head of the government; but whether under the special circumstances

¹See Lord Fitzmaurice's *Life of Shelburne*, iii. 393.

which existed in 1783 it was not better that the king should call upon the people to support him, than that government should be left in the hands of men who rested their power on close boroughs and the dispensation of patronage, without looking beyond the walls of the House of Commons for support.

That the king gained credit far beyond his own deserts by the glories of Pitt's ministry is beyond a doubt. Nor can there be any reasonable doubt that his own example of domestic propriety did much to strengthen the position of his minister. It is true that that life was insufferably dull. No gleams of literary or artistic taste lightened it up. The dependants of the court became inured to dull routine unchequered by loving sympathy. The sons of the household were driven by the sheer weariness of such an existence into the coarsest profligacy. But all this was not visible from a distance. The tide of moral and religious improvement which had set in in England since the days of Wesley brought popularity to a king who was faithful to his wife, in the same way that the tide of manufacturing industry and scientific progress brought popularity to the minister who in some measure translated into practice the principles of the *Wealth of Nations*.

Nor were there wanting subjects of importance beyond the circle of politics in which George III. showed a lively interest. The voyages of discovery which made known so large a part of the islands and coasts of the Pacific Ocean received from him a warm support. In the early days of the Royal Academy, its finances were strengthened by liberal grants from the privy purse. His favourite pursuit, however, was farming. When Arthur Young was issuing his *Annals of Agriculture*, he was supplied with information by the king, under the assumed name of Mr Ralph Robinson, relating to a farm at Petersham.

The life of the king was suddenly clouded over. Early in his reign, in 1765, he had been out of health, and—though the fact was studiously concealed at the time—symptoms of mental aberration were even then to be perceived. In October 1788 he was again out of health, and in the beginning of the following month his insanity was beyond a doubt. Whilst Pitt and Fox were contending in the House of Commons over the terms on which the regency should be committed to the prince of Wales, the king was a helpless victim to the ignorance of physicians and the brutalities of his servants. At last Dr Willis, who had made himself a name by prescribing gentleness instead of rigour in the treatment of the insane, was called in. Under his more humane management the king rapidly recovered. Before the end of February 1789 he was able to write to Pitt thanking him for his warm support of his interests during his illness. On the 23rd of April he went in person to St Paul's to return thanks for his recovery.

The popular enthusiasm which burst forth around St Paul's was but a foretaste of a popularity far more universal. The French Revolution frightened the great Whig landowners till they made their peace with the king. Those who thought that the true basis of government was aristocratical were now of one mind with those who thought that the true basis of government was monarchical; and these two classes were joined by a far larger multitude which had no political ideas whatever, but which had a moral horror of the guillotine. As Elizabeth had once been the symbol of resistance to Spain, George was now the symbol of resistance to France. He was not, however, more than the symbol. He allowed Pitt to levy taxes and incur debt, to launch armies to defeat, and to prosecute the English imitators of French revolutionary courses. At last, however, after the Union with Ireland was accomplished, he learned that Pitt was planning a scheme to relieve the Catholics from the disabilities under which they laboured. The plan was revealed to him by the chancellor, Lord Loughborough, a selfish and intriguing politician who had served all parties in turn, and who sought to forward his own interests by falling in with the king's prejudices. George III. at once took up the position from which he never swerved. He declared that to grant concessions to the Catholics involved a breach of his coronation oath. No one has ever doubted that the king was absolutely convinced of the serious

nature of the objection. Nor can there be any doubt that he had the English people behind him. Both in his peace ministry and in his war ministry Pitt had taken his stand on royal favour and on popular support. Both failed him alike now, and he resigned office at once. The shock to the king's mind was so great that it brought on a fresh attack of insanity. This time, however, the recovery was rapid. On the 14th of March 1801 Pitt's resignation was formally accepted, and the late speaker, Mr Addington, was installed in office as prime minister.

The king was well pleased with the change. He was never capable of appreciating high merit in any one; and he was unable to perceive that the question on which Pitt had resigned was more than an improper question, with which he ought never to have meddled. "Tell him," he said, in directing his physician to inform Pitt of his restoration to health, "I am now quite well, quite recovered from my illness; but what has he not to answer for, who has been the cause of my having been ill at all?" Addington was a minister after his own mind. Thoroughly honest and respectable, with about the same share of abilities as was possessed by the king himself, he was certainly not likely to startle the world by any flights of genius. But for one circumstance Addington's ministry would have lasted long. So strong was the reaction against the Revolution that the bulk of the nation was almost as suspicious of genius as the king himself. Not only was there no outcry for legislative reforms, but the very idea of reform was unpopular. The country gentlemen were predominant in parliament, and the country gentlemen as a body looked upon Addington with respect and affection. Such a minister was therefore admirably suited to preside over affairs at home in the existing state of opinion. But those who were content with inaction at home would not be content with inaction abroad. In time of peace Addington would have been popular for a season. In time of war even his warmest admirers could not say that he was the man to direct armies in the most terrible struggle which had ever been conducted by an English government.

For the moment this difficulty was not felt. On the 1st of October 1801, preliminaries of peace were signed between England and France, to be converted into the definitive peace of Amiens on the 27th of March 1802. The ruler of France was now Napoleon Bonaparte, and few persons in England believed that he had any real purpose of bringing his aggressive violence to an end. "Do you know what I call this peace?" said the king; "an experimental peace, for it is nothing else. But it was unavoidable."

The king was right. On the 18th of May 1803 the declaration of war was laid before parliament. The war was accepted by all classes as inevitable, and the French preparations for an invasion of England roused the whole nation to a glow of enthusiasm only equalled by that felt when the Armada threatened its shores. On the 26th of October the king reviewed the London volunteers in Hyde Park. He found himself the centre of a great national movement with which he heartily sympathized, and which heartily sympathized with him.

On the 12th of February 1804 the king's mind was again affected. When he recovered, he found himself in the midst of a ministerial crisis. Public feeling allowed but one opinion to prevail in the country—that Pitt, not Addington, was the proper man to conduct the administration in time of war. Pitt was anxious to form an administration on a broad basis, including Fox and all prominent leaders of both parties. The king would not hear of the admission of Fox. His dislike of him was personal as well as political, as he knew that Fox had had a great share in drawing the prince of Wales into a life of profligacy. Pitt accepted the king's terms, and formed an administration in which he was the only man of real ability. Eminent men, such as Lord Grenville, refused to join a ministry from which the king had excluded a great statesman on purely personal grounds.

The whole question was reopened on Pitt's death on the 23rd of January 1806. This time the king gave way. The ministry of All the Talents, as it was called, included Fox amongst its members. At first the king was observed to appear depressed at the necessity of surrender. But Fox's charm of manner soon

gained upon him. "Mr Fox," said the king, "I little thought that you and I should ever meet again in this place; but I have no desire to look back upon old grievances, and you may rest assured I never shall remind you of them." On the 13th of September Fox died, and it was not long before the king and the ministry were openly in collision. The ministry proposed a measure enabling all subjects of the crown to serve in the army and navy in spite of religious disqualifications. The king objected even to so slight a modification of the laws against the Catholics and Dissenters, and the ministers consented to drop the bill. The king asked more than this. He demanded a written and positive engagement that this ministry would never, under any circumstances, propose to him "any measure of concession to the Catholics, or even connected with the question." The ministers very properly refused to bind themselves for the future. They were consequently turned out of office, and a new ministry was formed with the duke of Portland as first lord of the treasury and Mr Perceval as its real leader. The spirit of the new ministry was distinct hostility to the Catholic claims. On the 27th of April 1807 a dissolution of parliament was announced, and a majority in favour of the king's ministry was returned in the elections which speedily followed.

The elections of 1807, like the elections of 1784, gave the king the mastery of the situation. In other respects they were the counterpart of one another. In 1784 the country declared, though perhaps without any clear conception of what it was doing, for a wise and progressive policy. In 1807 it declared for an unwise and retrogressive policy, with a very clear understanding of what it meant. It is in his reliance upon the prejudices and ignorance of the country that the constitutional significance of the reign of George III. appears. Every strong government derives its power from its representative character. At a time when the House of Commons was less really representative than at any other, a king was on the throne who represented the country in its good and bad qualities alike, in its hatred of revolutionary violence, its moral sturdiness, its contempt of foreigners, and its defiance of all ideas which were in any way strange. Therefore it was that his success was not permanently injurious to the working of the constitution as the success of Charles I. would have been. If he were followed by a king less English than himself, the strength of representative power would pass into other hands than those which held the sceptre.

The overthrow of the ministry of All the Talents was the last political act of constitutional importance in which George III. took part. The substitution of Perceval for Portland as the nominal head of the ministry in 1809 was not an event of any real significance, and in 1811 the reign practically came to an end. The king's reason finally broke down after the death of the princess Amelia, his favourite child; and the prince of Wales (see GEORGE IV.) became prince regent. The remaining nine years of George III.'s life were passed in insanity and blindness, and he died on the 29th of January 1820.

His wife, Charlotte Sophia (1744-1818), was a daughter of Charles Louis of Mecklenburg-Strelitz (d. 1810), and was married to the king in London on the 8th of September 1761. After a peaceful and happy married life the queen died at Kew on the 17th of November 1818.

George III. had nine sons. After his successor came Frederick, duke of York and Albany (1763-1827); William Henry, duke of Clarence, afterwards King William IV. (1765-1837); Edward Augustus, duke of Kent (1767-1825), father of Queen Victoria; Ernest Augustus, duke of Cumberland, afterwards king of Hanover (1771-1851); Augustus Frederick, duke of Sussex (1773-1843); Adolphus Frederick, duke of Cambridge (1774-1850); Octavius (1779-1783); Alfred (1780-1782). He had also six daughters—Charlotte Augusta (1766-1828), married in 1797 to Frederick, afterwards king of Württemberg; Augusta Sophia (1768-1840); Elizabeth (1770-1840), married Frederick, landgrave of Hesse-Homburg, 1818; Mary (1776-1857), married to William Frederick, duke of Gloucester, 1816; Sophia (1777-1848); Amelia (1783-1810). (S. R. G.)

The numerous contemporary memoirs and diaries are full of the best material for a picture of George III.'s reign, apart from the standard histories. Thackeray's *Four Georges* must not be trusted so far as historical judgment is concerned; Jesse's *Memoirs of the Life and Reign of George III.* (2nd ed., 1867) is chiefly concerned with personalities. See also Beckles Willson, *George III., as Man, Monarch and Statesman* (1907).

GEORGE IV. [George Augustus Frederick] (1762-1830), king of Great Britain and Ireland, eldest son of George III., was born at St James's Palace, London, on the 12th of August 1762. He was naturally gifted, was well taught in the classics, learnt to speak French, Italian and German fluently, and had considerable taste for music and the arts; and in person he was remarkably handsome. His tutor, Bishop Richard Hurd, said of him when fifteen years old that he would be "either the most polished gentleman or the most accomplished blackguard in Europe—possibly both"; and the latter prediction was only too fully justified. Reaction from the strict and parsimonious style of his parents' domestic life, which was quite out of touch with the gaiety and extravagance of London "society," had its natural effect in plunging the young prince of Wales, flattered and courted as he was, into a whirl of pleasure-seeking. At the outset his disposition was brilliant and generous, but it was essentially unstable, and he started even before he came of age on a career of dissipation which in later years became wholly profligate. He had an early amour with the actress Mary ("Perdita") Robinson, and in the choice of his friends he opposed and annoyed the king, with whom he soon became (and always remained) on the worst of terms, by associating himself with Fox and Sheridan and the Whig party. When in 1783 he came of age, a compromise between the coalition ministry and the king secured him an income of £50,000 from the Civil List, and £60,000 was voted by parliament to pay his debts and start his separate establishment at Carlton House. There, under the auspices of C. J. Fox and Georgiana, duchess of Devonshire, he posed as a patron of Whig politics and a leader in all the licence and luxury of gay society—the "First gentleman in Europe," as his flatterers described him as years went on. And at this early age he fell seriously in love with the famous Mrs Fitzherbert.

His long connexion with this lady may most conveniently be summarized here. It was indeed for some time the one redeeming and restraining factor in his life, though her devotion and self-sacrificing conduct were in marked contrast with his unscrupulousness and selfishness. Mary Anne (or as she always called herself, Maria) Fitzherbert (1756-1837) was the daughter of Walter Smythe, the second son of Sir John Smythe, Bart., of Acton Burnell Park, Shropshire, and came of an old Roman Catholic family. Educated at a French convent, she married first in 1775 Edward Weld, who died within the year, and secondly in 1778 Thomas Fitzherbert, who died in 1781, leaving his widow with a comfortable fortune. A couple of years later she became a prominent figure in London society, and her beauty and charm at once attracted the young prince, who wooed her with all the ardour of a violent passion. She herself was distracted between her desire to return his love, her refusal to contemplate becoming his mistress, and her knowledge that state reasons made a regular marriage impossible. The Act of Settlement (1689) entailed his forfeiture of the succession if he married a Roman Catholic, apart from the fact that the Royal Marriage Act of 1772 made any marriage illegal without the king's consent, which was out of the question. But after trying for a while to escape his attentions, her scruples were overcome. In Mrs Fitzherbert's eyes the state law was, after all, not everything. To a Roman Catholic, and equally to any member of the Christian church, a formal marriage ceremony would be ecclesiastically and sacramentally binding; and after a period of passionate importunacy on his part they were secretly married by the Rev. R. Burt, a clergyman of the Church of England, on the 15th of December 1785.¹ There is no doubt as to Mrs Fitzherbert's belief, supported by ecclesiastical considerations, in her correct

¹ For a discussion of the ecclesiastical validity of the marriage see W. H. Wilkins, *Mrs Fitzherbert and George IV.* (1905), chs. vi. and vii.

and binding, though admittedly illegal, relationship to the prince as his canonical wife; and though that relationship was not, and for political reasons could not be, publicly admitted, it was in fact treated by their intimates on the footing of amorganatic marriage. The position nevertheless was inevitably a false one; Mrs Fitzherbert had promised not to publish the evidence of the marriage (which, according to a strict interpretation of the Act of Settlement might have barred succession to the crown), and the rumours which soon got about led the prince to allow it to be disavowed by his political friends. He lived in the most extravagant way, became heavily involved in debt, and as the king would not assist him, shut up Carlton House, and went to live with Mrs Fitzherbert at Brighton. In 1787 a proposal was brought before the House of Commons by Alderman Newnham for a grant in relief of his embarrassments. It was on this occasion that Fox publicly declared in the House of Commons, as on the prince's own authority, in answer to allusions to the marriage, that the story was a malicious falsehood. A little later Sheridan, in deference to Mrs Fitzherbert's pressure and to the prince's own compunction, made a speech guardedly modifying Fox's statement; but though in private the denial was understood, it effected its object, the House voting a grant of £221,000 to the prince and the king adding £10,000 to his income; and Mrs Fitzherbert, who at first thought of severing her connexion with the prince, forgave him. Their union—there was no child of the marriage—was brutally broken off in June 1794 by the prince, when further pressure of debts (and the influence of a new Egeria in Lady Jersey) made him contemplate his official marriage with princess Caroline; in 1800, however, it was renewed, after urgent pleading on the prince's part, and after Mrs Fitzherbert had obtained a formal decision from the pope pronouncing her to be his wife, and sanctioning her taking him back; her influence over him continued till shortly before the prince became regent, when his relations with Lady Hertford brought about a final separation. For the best years of his life he had at least had in Mrs Fitzherbert the nearest approach to a real wife, and this was fully recognized by the royal family.¹ But his dissolute nature was entirely selfish, and his various liaisons ended in the dominance of Lady Conyngham, the "Lady Steward" of his household, from 1821 till his death.

Notorious as the prince of Wales had become by 1788, it was in that year that his father's first attack of insanity made his position in the state one of peculiar importance. Fox maintained and Pitt denied that the prince of Wales, as the heir-apparent, had a right to assume the regency independently of any parliamentary vote. Pitt, with the support of both Houses, proposed to confer upon him the regency with certain restrictions. The recovery of the king in February 1789 put an end, however, to the prince's hopes. In 1794 the prince con-

¹ Mrs Fitzherbert herself, after her final separation from the prince, with an annuity of £6000 a year, lived an honoured and more or less retired life mainly at Brighton, a town which owed its rapid development in fashionable popularity and material wealth to its selection by the prince and herself as a residence from the earliest years of their union; and there she died, seven years after the death of George IV., in 1837. William IV. on his accession offered to create her a duchess, but she declined; she accepted, however, his permission to put her servants in royal livery. William IV. in fact did all he could, short of a public acknowledgment (which the duke of Wellington opposed on state grounds), to recognize her position as his brother's widow. Charles Greville, writing of her after her death, says in his *Diary*, "She was not a clever woman, but of a very noble spirit, disinterested, generous, honest and affectionate." The actual existence of a marriage tie and the documentary evidence of her rights were not definitely established for many years; but in 1905 a sealed packet, deposited at Coutts's bank in 1833, was at length opened by royal permission, and the marriage certificate and other conclusive proofs therein contained were published in Mr W. H. Wilkins's *Mrs Fitzherbert and George IV.* In 1796 the prince had made a remarkable will in Mrs Fitzherbert's favour, which he gave her in 1799, and it is included among these documents (now in the private archives at Windsor). In this he speaks of her emphatically throughout as "my wife." It also contained directions that at his death a locket with her miniature, which he always wore, should be interred with him; and Mrs Fitzherbert was privately assured, on the duke of Wellington's authority, that when the king was buried at Windsor the miniature was on his breast.

sented to a marriage with a German Protestant princess, because his father would not pay his debts on any other terms, and his cousin, Princess Caroline of Brunswick, was brought over from Germany and married to him in 1795. Her behaviour was light and flippant, and he was brutal and unloving. The ill-assorted pair soon parted, and soon after the birth of their only child, the princess Charlotte, they were formally separated. With great unwillingness the House of Commons voted fresh sums of money to pay the prince's debts.

In 1811 he at last became prince regent in consequence of his father's definite insanity. No one doubted at that time that it was in his power to change the ministry at his pleasure. He had always lived in close connexion with the Whig opposition, and he now empowered Lord Grenville to form a ministry. There soon arose differences of opinion between them on the answer to be returned to the address of the Houses, and the prince regent then informed the prime minister, Mr Perceval, that he should continue the existing ministry in office. The ground alleged by him for this desertion of his friends was the fear lest his father's recovery might be rendered impossible if he should come to hear of the advent of the opposition to power. Lord Wellesley's resignation in February 1812 made the reconstruction of the ministry inevitable. As there was no longer any hope of the king's recovery, the former objection to a Whig administration no longer existed. Instead of taking the course of inviting the Whigs to take office, he asked them to join the existing administration. The Whig leaders, however, refused to join, on the ground that the question of the Catholic disabilities was too important to be shelved, and that their difference of opinion with Mr Perceval was too glaring to be ignored. The prince regent was excessively angry, and continued Perceval in office till that minister's assassination on the 11th of May, when he was succeeded by Lord Liverpool, after a negotiation in which the proposition of entering the cabinet was again made to the Whigs and rejected by them. In the military glories of the following years the prince regent had no share. When the allied sovereigns visited England in 1814, he played the part of host to perfection. So great was his unpopularity at home that hisses were heard in the streets as he accompanied his guests into the city. The disgust which his profligate and luxurious life caused amongst a people suffering from almost universal distress after the conclusion of the war rapidly increased. In 1817 the windows of the prince regent's carriage were broken as he was on his way to open parliament.

The death of George III. on the 29th of January 1820, gave to his son the title of king without in any way altering the position which he had now held for nine years. Indirectly, however, this change brought out a manifestation of popular feeling such as his father had never been subjected to even in the early days of his reign, when mobs were burning jack-boots and petticoats. The relations between the new king and his wife unavoidably became the subject of public discussion. In 1806 a charge against the princess of having given birth to an illegitimate child had been conclusively disproved, and the old king had consequently refused to withdraw her daughter, the princess Charlotte, from her custody. When in the regency the prince was able to interfere, and prohibited his wife from seeing her daughter more than once a fortnight. On this, in 1813, the princess addressed to her husband a letter setting forth her complaints, and receiving no answer published it in the *Morning Chronicle*. The prince regent then referred the letter, together with all papers relating to the inquiry of 1806, to a body of twenty-three privy councillors for an opinion whether it was fit that the restrictions on the intercourse between the princess Charlotte and her mother should continue in force. All except two answered as the regent wished them to answer. But if the official leaning was towards the husband, the leaning of the general public was towards the wife of a man whose own life had not been such as to justify him in complaining of her whom he had thrust from him without a charge of any kind. Addresses of sympathy were sent up to the princess from the city of London and other public bodies. The discord again broke out in 1814 in

consequence of the exclusion of the princess from court during the visit of the allied sovereigns. In August in that year she left England, and after a little time took up her abode in Italy. The accession of George IV. brought matters to a crisis. He ordered that no prayer for his wife as queen should be admitted into the Prayer Book. She at once challenged the accusation which was implied in this omission by returning to England. On the 7th of June she arrived in London. Before she left the continent she had been informed that proceedings would be taken against her for adultery if she landed in England. Two years before, in 1818, commissioners had been sent to Milan to investigate charges against her, and their report, laid before the cabinet in 1819, was made the basis of the prosecution. On the day on which she arrived in London a message was laid before both Houses recommending the criminal evidence to parliament. A secret committee in the House of Lords after considering this evidence brought in a report on which the prime minister founded a Bill of Pains and Penalties to divorce the queen and to deprive her of her royal title. The bill passed the three readings with diminished majorities, and when on the third reading it obtained only a majority of nine, it was abandoned by the Government. The king's unpopularity, great as it had been before, was now greater than ever. Public opinion, without troubling itself to ask whether the queen was guilty or not, was roused to indignation by the spectacle of such a charge being brought by a husband who had thrust away his wife to fight the battle of life alone, without protection or support, and who, whilst surrounding her with spies to detect, perhaps to invent, her acts of infidelity, was himself notorious for his adulterous life. In the following year (1821) she attempted to force her way into Westminster Abbey to take her place at the coronation. On this occasion the popular support failed her; and her death in August relieved the king from further annoyance.

Immediately after the death of the queen, the king set out for Ireland. He remained there but a short time, and his effusive declaration that rank, station, honours were nothing compared with the exalted happiness of living in the hearts of his Irish subjects gained him a momentary popularity which was beyond his attainment in a country where he was better known. His reception in Dublin encouraged him to attempt a visit to Edinburgh in the following year (August 1822). Since Charles II. had come to play the sorry part of a covenanting king in 1650 no sovereign of the country had set foot on Scottish soil. Sir Walter Scott took the leading part in organizing his reception. The enthusiasm with which he was received equalled, if it did not surpass, the enthusiasm with which he had been received in Dublin. But the qualities which enabled him to fix the fleeting sympathies of the moment were not such as would enable him to exercise the influence in the government which had been indubitably possessed by his father. He returned from Edinburgh to face the question of the appointment of a secretary of state which had been raised by the death of Lord Londonderry (Castlereagh). It was upon the question of the appointment of ministers that the battle between the Whigs and the king had been fought in the reign of George III. George IV. had neither the firmness nor the moral weight to hold the reins which his father had grasped. He disliked Canning for having taken his wife's side very much as his father had disliked Fox for taking his own. But Lord Liverpool insisted on Canning's admission to office, and the king gave way. Tacitly and without a struggle the constitutional victory of the last reign was surrendered. But it was not surrendered to the same foe as that from which it had been won. The coalition ministry in 1784 rested on the great landowners and the proprietors of rotten boroughs. Lord Liverpool's ministry had hitherto not been very enlightened, and it supported itself to a great extent upon a narrow constituency. But it did appeal to public opinion in a way that the coalition did not, and what it wanted itself in popular support would be supplied by its successors. What one king had gained from a clique another gave up to the nation. Once more, on Lord Liverpool's death in 1827, the same question was tried with the same result. The king not only disliked Canning

personally, but he was opposed to Canning's policy. Yet after some hesitation he accepted Canning as prime minister; and when, after Canning's death and the short ministry of Lord Goderich, the king in 1828 authorized the duke of Wellington to form a ministry, he was content to lay down the principle that the members of it were not expected to be unanimous on the Catholic question. When in 1829 the Wellington ministry unexpectedly proposed to introduce a Bill to remove the disabilities of the Catholics, he feebly strove against the proposal and quickly withdrew his opposition. The worn-out debauchee had neither the merit of acquiescing in the change nor the courage to resist it.

George IV. died on the 26th of June 1830, and was succeeded by his brother, the duke of Clarence, as William IV. His only child by Queen Caroline, the princess Charlotte Augusta, was married in 1816 to Leopold of Saxe-Coburg, afterwards king of the Belgians, and died in childbirth on the 6th of November 1817.

George IV. was a bad king, and his reign did much to disgust the country with the Georgian type of monarchy; but libertine and profligate as he became, the abuse which has been lavished on his personal character has hardly taken into sufficient consideration the loose morals of contemporary society, the political position of the Whig party, and his own brilliant temperament. Thackeray, in his *Four Georges*, is frequently unfair in this respect. The just condemnation of the moralist and satirist requires some qualification in the light of the picture of the period handed down in the memoirs and diaries of the time, such as Greville's, Croker's, Creevey's, Lord Holland's, Lord Malmesbury's, &c. Among later works see *The First Gentleman of Europe*, by Lewis Melville (1906), a book for the general reader. (S. K. G.; H. Ch.)

GEORGE V. (GEORGE FREDERICK ERNEST ALBERT), king of Great Britain and Ireland and of the British Dominions beyond the Seas, emperor of India (1865-), second son of King Edward VII., was born at Marlborough House, London, on the 3rd of June 1865. When four years old, he and his elder brother, Prince Albert Victor, two years his senior, were placed under the tutorship of John Neale Dalton, then curate of Sandringham. In 1877 the two princes became naval cadets on the "Britannia" at Spithead, where they passed through the ordinary curriculum, and in 1879 they joined H.M.S. "Bacchante" under the command of Captain Lord Charles Scott, making a voyage to the West Indies, in the course of which they were rated midshipmen. After a month at home in 1880 they returned to the ship to make another prolonged cruise in H.M.S. "Bacchante," in the course of which they visited South America, South Africa, Australia, the Fiji Islands, Japan, Ceylon, Egypt, Palestine and Greece. A narrative of this voyage, *The Cruise of H.M.S. "Bacchante,"* compiled from the letters, diaries and notebooks of the princes, was published in 1886. At the close of this tour in 1882 the brothers separated. Prince George, who remained in the naval service, was appointed to H.M.S. "Canada," commanded by Captain Durrant, on the North American and West Indian station, and was promoted sub-lieutenant. On his return home he passed through the Royal Naval College at Greenwich and the gunnery and torpedo schools, being promoted lieutenant in 1885. A year later he was appointed to H.M.S. "Thunderer" of the Mediterranean squadron, and was subsequently transferred to H.M.S. "Dreadnought" and H.M.S. "Alexandra." In 1889 he joined the flagship of the Channel squadron, H.M.S. "Northumberland," and in that year was in command of torpedo boat No. 79 for the naval manoeuvres. In 1890 he was put in command of the gunboat H.M.S. "Thrush" for service on the North American and West Indian station. After his promotion as commander in 1891 he commissioned H.M.S. "Melampus," the command of which he relinquished on the death of his brother, Albert Victor, the duke of Clarence, in January 1892, since his duties as eventual heir to the crown precluded him from devoting himself exclusively to the navy. He was promoted captain in 1893, rear-admiral in 1901, and vice-admiral in 1903. He was created duke of York, earl of Inverness, and Baron Killarney in 1892, and on the 6th of July 1893 he married Princess Victoria Mary (b. 26th May 1867), daughter of Francis, duke of Teck,

and Princess Mary Adelaide, duchess of Teck, daughter of Adolphus Frederick, duke of Cambridge. Their eldest son, Prince Edward Albert, was born at White Lodge, Richmond, on the 23rd of June 1894; Prince Albert Frederick George was born at Sandringham on the 14th of December 1895; Princess Victoria Alexandra on the 25th of April 1897; Prince Henry William Frederick Albert on the 31st of March 1900; Prince George Edward Alexander Edmund on the 20th of December 1902; and Prince John Charles Francis on the 12th of July 1905. The duke and duchess of York visited Ireland in 1899, and it had been arranged before the death of Queen Victoria that they should make a tour in the colonies. On the accession of King Edward VII. (1901) this plan was confirmed. They sailed in the "Ophir" on the 16th of March 1901, travelling by the ordinary route, and landed at Melbourne in May, when they opened the first parliament of the Commonwealth. They then proceeded to New Zealand, returning by way of South Africa and Canada. An official account of the tour was published by Sir Donald Mackenzie Wallace as *The Web of Empire* (1902). In November 1901 the duke was created prince of Wales. On the death of Edward VII. (May 6, 1910) he succeeded to the Crown as George V., his consort taking the style of Queen Mary.

GEORGE V., king of Hanover (1819-1878), was the only son of Ernest Augustus, king of Hanover and duke of Cumberland, and consequently a grandson of the English king George III. Born in Berlin on the 27th of May 1819, his youth was passed in England and in Berlin until 1837, when his father became king of Hanover and he took up his residence in that country. He lost the sight of one eye during a childish illness, and the other by an accident in 1833. Being thus totally blind there were doubts whether he was qualified to succeed to the government of Hanover; but his father decided that he should do so, as the law of the dissolved empire only excluded princes who were born blind. This decision was a fatal one to the dynasty. Both from his father and from his maternal uncle, Charles Frederick, prince of Mecklenburg-Strelitz (1785-1837), one of the most influential men at the Prussian court, George had learned to take a very high and autocratic view of royal authority. His blindness prevented him from acquiring the shrewdness and knowledge of the world which had assisted his father, and he easily fell into the hands of unwise, and perhaps dishonest and disloyal, advisers. A man of deep religious feeling, he formed a fantastic conception of the place assigned to the house of Guelph in the divine economy, and had ideas of founding a great Guelph state in Europe. It is, therefore, not surprising that from the time of his accession in November 1851 he was constantly engaged in disputes with his *Landtag* or parliament, and was consequently in a weak and perilous position when the crisis in the affairs of Germany came in 1866. Having supported Austria in the diet of the German confederation in June 1866, he refused, contrary to the wishes of his parliament, to assent to the Prussian demand that Hanover should observe an unarmed neutrality during the war. As a result his country and his capital were at once occupied by the Prussians, to whom his army surrendered on the 29th of June 1866, and in the following September Hanover was formally annexed by Prussia. From his retreat at Hietzing near Vienna, George appealed in vain to the powers of Europe; and supported by a large number of his subjects, an agitation was carried on which for a time caused some embarrassment to Prussia. All these efforts, however, to bring about a restoration were unavailing, and the king passed the remainder of his life at Gmünden in Austria, or in France, refusing to the last to be reconciled with the Prussian government. Whilst visiting Paris for medical advice he died in that city on the 12th of June 1878, and was buried in St George's chapel, Windsor. In February 1843 he had married Marie, daughter of Joseph, duke of Saxe-Altenburg, by whom he left a son and two daughters. His son, Ernest Augustus, duke of Cumberland (b. 1845), continued to maintain the claim of his house to the kingdom of Hanover.

By the capitulation of 1866 the king was allowed to retain his personal property, which included money and securities

equal to nearly £1,500,000, which had been sent to England before the Prussian invasion of Hanover. The crown jewels had also been secretly conveyed to England. His valuable plate, which had been hidden at Herrenhausen, near Hanover, was restored to him in 1867; his palace at Herrenhausen, near Hanover, was reserved as his property; and in 1867 the Prussian government agreed to compensate him for the loss of his landed estates, but owing to his continued hostility the payment of the interest on this sum was suspended in the following year (see HANOVER).

See O. Klopp, *König Georg V.* (Hanover, 1878); O. Theodor, *Erinnerungen an Georg V.* (Bremerhaven, 1878); and O. Meding, *Memoiren sur Zeitgeschichte* (Leipzig, 1881-1884).

GEORGE I., king of the Hellenes (1845-), second son of King Christian IX. of Denmark, was born at Copenhagen on the 24th of December 1845. After the expulsion of King Otto in 1862, the Greek nation, by a plebiscite, elected the British prince, Alfred, duke of Edinburgh (subsequently duke of Coburg), to the vacant throne, and on his refusal the national assembly requested Great Britain to nominate a candidate. The choice of the British government fell on Prince Christian William Ferdinand Adolphus George of Schleswig-Holstein-Sonderburg-Glücksburg, whose election as king of the Hellenes, with the title George I., was recognized by the powers (6th of June 1863). The sister of the new sovereign, Princess Alexandra, had a few months before (10th March) married the prince of Wales, afterwards King Edward VII., and his father succeeded to the crown of Denmark in the following November. Another sister, Princess Dagmar, subsequently married the grand duke Alexander Alexandrovitch, afterwards Emperor Alexander III. of Russia. On his accession, King George signed an act resigning his right of succession to the Danish throne in favour of his younger brother Prince Waldemar. He was received with much enthusiasm by the Greeks. Adopting the motto, "My strength is the love of my people," he ruled in strict accordance with constitutional principles, though not hesitating to make the fullest use of the royal prerogative when the intervention of the crown seemed to be required by circumstances. For the events of his reign see GREECE: *History*.

King George married, on the 27th of October 1867, the grand duchess Olga Constantinovna of Russia, who became distinguished in Greece for her activity on behalf of charitable objects. Their children were Prince Constantine, duke of Sparta (b. 1868), who married in 1889 Princess Sophia of Prussia, daughter of the emperor Frederick, and granddaughter of Queen Victoria; Prince George (b. 1869), from November 1898 to October 1906 high commissioner of the powers in Crete; Prince Nicholas (b. 1872), who married in 1902 the grand duchess Helen-Vladimirovna of Russia; Prince Andrew (b. 1882), who married in 1903 Princess Alice of Battenberg; Prince Christopher (b. 1888); and a daughter, Princess Marie (b. 1876), who married in 1900 the grand duke George Michailovich of Russia.

GEORGE, king of Saxony (1832-1904), the youngest son of King John of Saxony (d. 1873) and Queen Amelia, was born at Dresden on the 8th of August 1832. From an early age he received a careful scientific and military training, and in 1846 entered the active army as a lieutenant of artillery. In 1849-1850 he was a student at the university of Bonn, but soon returned to military life, for which he had a predilection. In the Austro-Prussian War of 1866 he commanded a Saxon cavalry brigade, and in the early part of the war of 1870-71 a division, but later succeeded to the supreme command of the XII. (Saxon) army corps in the room of his brother, the crown prince Albert (afterwards king) of Saxony. His name is inseparably associated with this campaign, during which he showed undoubted military ability and an intrepidity which communicated itself to all ranks under his command, notably at the battles of St Privat and Beaumont, in which he greatly distinguished himself. On his brother succeeding to the throne he became commander-in-chief of the Saxon army, and was in 1888 made a Prussian field marshal by the emperor William I. He married in 1859 the infanta Maria, sister of King Louis of Portugal, and King

Albert's marriage being childless, succeeded on his death in 1902 to the throne of Saxony. He died on the 15th of October 1904, at Pillnitz.

GEORGE OF LAODICEA in Syria, often called "the Cappadocian," from 356 to 367 Arian archbishop of Alexandria, was born about the beginning of the 4th century. According to Ammianus (xxii. 11), he was a native of Epiphania, in Cilicia. Gregory Nazianzen tells us that his father was a fuller, and that he himself soon became notorious as a parasite of so mean a type that he would "sell himself for a cake." After many wanderings, in the course of which he seems to have amassed a considerable fortune, first as an army-contractor and then as a receiver of taxes, he ultimately reached Alexandria. It is not known how or when he obtained ecclesiastical orders; but, after Athanasius had been banished in 356, George was promoted by the influence of the then prevalent Arian faction to the vacant see. His theological attitude was that known as semi-Arian or Homoiousian, and his associates were Eustathius of Sebaste and Basil of Ancyra. At George's instigation the second Sirmian formula (promulgated by the third council of Sirmium 357), which was conciliatory towards strict Arianism, was opposed at the council of Ancyra in 358 (Harnack, *Hist. of Dogma*, iv. 76). His persecutions and oppressions of the orthodox ultimately raised a rebellion which compelled him to flee for his life; but his authority was restored, although with difficulty, by a military demonstration. Untaught by experience, he resumed his course of selfish tyranny over Christians and heathen alike, and raised the irritation of the populace to such a pitch that when, on the accession of Julian, his downfall was proclaimed and he was committed to prison, they dragged him thence and killed him, finally casting his body into the sea (24th of December 361). With much that was sordid and brutal in his character George combined a highly cultivated literary taste, and in the course of his chequered career he had found the means of collecting a splendid library, which Julian ordered to be conveyed to Antioch for his own use. An anonymous work against the Manicheans discovered by Lagarde in 1859 in a MS. of Titus of Bostra has been attributed to him.

The original sources for the facts of the life of George of Laodicea are Ammianus, Gregory Nazianzen, Epiphanius and Athanasius. His character has been drawn with graphic fidelity by Gibbon in the 23rd chapter of the *Decline and Fall*; but the theory, accepted by Gibbon, which identifies him with the patron saint of England is now rejected (see **GEORGE, SAINT**). See C. S. Hulst, *St George of Cappadocia in Legend and History* (1910).

GEORGE OF TREBIZOND (1395-1484), Greek philosopher and scholar, one of the pioneers of the revival of letters in the Western world, was born in the island of Crete, and derived his surname Trapezuntios from the fact that his ancestors were from Trebizond. At what period he came to Italy is not certain; according to some accounts he was summoned to Venice about 1430 to act as amanuensis to Francesco Barbaro, who appears to have already made his acquaintance; according to others he did not visit Italy till the time of the council of Florence (1438-1439). He learned Latin from Vittorino da Feltre, and made such rapid progress that in three years he was able to teach Latin literature and rhetoric. His reputation as a teacher and a translator of Aristotle was very great, and he was selected as secretary by Pope Nicholas V., an ardent Aristotelian. The needless bitterness of his attacks upon Plato (in the *Comparatio Aristotelis et Platonis*), which drew forth a powerful response from Bessarion (q.v.), and the manifestly hurried and inaccurate character of his translations of Plato, Aristotle and other classical authors, combined to ruin his fame as a scholar, and to endanger his position as a teacher of philosophy. The indignation against him on account of his first-named work was so great that he would probably have been compelled to leave Italy had not Alphonso V. given him protection at the court of Naples. He subsequently returned to Rome, where he died in great poverty on the 12th of August 1484. He had long outlived his reputation, and towards the end of his life his intellect failed him. From all accounts he was a man of very disagreeable character, conceited and quarrelsome.

See G. Voigt, *Die Wiederbelebung des klassischen Altertums* (1893), and article by C. F. Bähr in Erach and Gruber's *Allgemeine Encyclopädie*. For a complete list of his numerous works, consisting of translations from Greek into Latin (Plato, Aristotle and the Fathers) and original essays in Greek (chiefly theological) and Latin (grammatical and rhetorical), see Fabricius, *Bibliotheca Graeca* (ed. Hales), xii.

GEORGE THE MONK (**GEORGIOS MONACHOS**), called Hamartolos (Greek for "sinner"), Byzantine chronicler, lived during the reign of Michael III. (842-867). He wrote a *Chronicle* of events, in four books, from the creation of the world to the death of the emperor Theophilus (842), whose widow Theodora restored the worship of images in the same year. It is the only original contemporary authority for the years 813-842, and therefore so far indispensable; the early parts of the work are merely a compilation. In the introduction the author disclaims all pretensions to literary style, and declares that his only object was to relate such things as were "useful and necessary" with a strict adherence to truth. Far too much attention, however, is devoted to religious matters; the iconoclasts are fiercely attacked, and the whole is interlarded with theological discussions and quotations from the fathers. The work was very popular, and translations of it served as models for Slavonic writers. The MSS. give a continuation down to 948, the author of which is indicated simply as "the logothete," by whom probably Symeon Metaphrastes (second half of the 10th century) is meant. In this religious questions are relegated to the background, more attention is devoted to political history, and the language is more popular. Still further continuations of little value go down to 1143. The large circulation of the work and its subsequent reissues, with alterations and interpolations, make it very difficult to arrive at the original text.

EDITIONS: E. de Muralt (St. Petersburg, 1859); J. P. Migne, *Patrologia Graeca*, cx.; C. de Boor (in Teubner series, 1904-). See F. Hirsch, *Byzantinische Studien* (1876); C. de Boor in *Historische Untersuchungen* (in honour of Arnold Schäfer, Bonn, 1882); C. Krumbacher, *Geschichte der byzantinischen Literatur* (1897).

GEORGE THE SYNCELLUS (**GEORGIOS SYNKELLOS**), of Constantinople, Byzantine chronicler and ecclesiastic, lived at the end of the 8th and the beginning of the 9th century A.D. He was the *syncellus* (cell-mate, the confidential companion assigned to the patriarchs, sometimes little more than a spy; see **SYNCELLUS**) or private secretary of Tara(u)sus, patriarch of Constantinople (784-806), after whose death he retired to a convent, and wrote his *Chronicle* of events from Adam to Diocletian (285). At his earnest request, the work, which he doubtless intended to bring down to his own times, was continued after his death by his friend Theophanes Confessor. The *Chronicle*, which, as its title implies, is rather a chronological table (with notes) than a history, is written with special reference to pre-Christian times and the introduction of Christianity, and exhibits the author as a staunch upholder of orthodoxy. But in spite of its religious bias and dry and uninteresting character, the fragments of ancient writers and apocryphal books preserved in it render it specially valuable. For instance, considerable portions of the original text of the *Chronicle* of Eusebius have been restored by the aid of Syncellus. His chief authorities were Annianus of Alexandria (5th century) and Panodorus, an Egyptian monk, who wrote about the year 400 and drew largely from Eusebius, Dexippus and Julius Africanus.

EDITION PRINCEPS, by J. Goar (1652); in Bonn *Corpus scriptorum hist. Byz.*, by W. Dindorf (1829). See also H. Gelszer, *Sextus Julius Africanus*, il. 1 (1885); C. Krumbacher, *Geschichte der byzantinischen Literatur* (1897).

GEORGE, HENRY (1839-1897), American author and political economist, was born in Philadelphia, Penn., on the 2nd of September 1839. He settled in California in 1858; removed to New York, 1880; was first a printer, then an editor, but finally devoted all his life to economic and social questions. In 1871 he published *Our Land Policy*, which, as further developed in 1879 under the title of *Progress and Poverty*, speedily attracted the widest attention both in America and in Europe. In 1886 he published *Protection or Free Trade*. Henry George had no political ambition, but in 1886 he received an independent nomination as mayor of New York City, and became so popular

that it required a coalition of the two strongest political parties to prevent his election. He received 68,000 votes, against 90,000 for the coalition candidate. His death on the 29th of October 1897 was followed by one of the greatest demonstrations of popular feeling and general respect that ever attended the funeral of any strictly private citizen in American history. The fundamental doctrine of Henry George, the equal right of all men to the use of the earth, did not originate with him; but his clear statement of a method by which it could be enforced, without increasing state machinery, and indeed with a great simplification of government, gave it a new form. This method he named the *Single Tax*. His doctrine may be condensed as follows: The land of every country belongs of right to all the people of that country. This right cannot be alienated by one generation, so as to affect the title of the next, any more than men can sell their yet unborn children for slaves. Private ownership of land has no more foundation in morality or reason than private ownership of air or sunlight. But the private occupancy and use of land are right and indispensable. Any attempt to divide land into equal shares is impossible and undesirable. Land should be, and practically is now, divided for private use in parcels among those who will pay the highest price for the use of each parcel. This price is now paid to some persons annually, and it is called *rent*. By applying the rent of land, exclusive of all improvements, to the equal benefit of the whole community, absolute justice would be done to all. As rent is always more than sufficient to defray all necessary expenses of government, those expenses should be met by a tax upon rent alone, to be brought about by the gradual abolition of all other taxes. Landlords should be left in undisturbed possession and nominal ownership of the land, with a sufficient margin over the tax to induce them to collect their rents and pay the tax. They would thus be transformed into mere land agents. Obviously this would involve absolute free trade, since all taxes on imports, manufactures, successions, documents, personal property, buildings or improvements would disappear. Nothing made by man would be taxed at all. The right of private property in all things made by man would thus be absolute, for the owner of such things could not be divested of his property, without full compensation, even under the pretence of taxation. The idea of concentrating all taxes upon ground-rent has found followers in Great Britain, North America, Australia and New Zealand. In practical politics this doctrine is confined to the "Single Tax, Limited," which proposes to defray only the needful public expenses from ground-rent, leaving the surplus, whatever it may be, in the undisturbed possession of land-owners.

The principal books by Henry George are: *Progress and Poverty* (1879), *The Irish Land Question* (1881), *Social Problems* (1884), *Protection or Free Trade* (1886), *The Condition of Labor* (1891), *A Perplexed Philosopher* (1892), *Political Economy* (1898). His son, Henry George (b. 1862), has written a *Life* (1900). For the Single Tax theory see Shearman's *Natural Taxation* (1899). (T. G. S.)

GEORGE PISIDA [GEORGIOS PISIDES], Byzantine poet, born in Pisidia, flourished during the 7th century A.D. Nothing is known of him except that he was a deacon and chartophylax (keeper of the records) of the church of St Sophia. His earliest work, in three cantos (*ἀσποδούς*), on the campaign of the emperor Heraclius against the Persians, seems to be the work of an eyewitness. This was followed by the *Avarica*, an account of a futile attack on Constantinople by the Avars (626), said to have been repulsed by the aid of the Virgin Mary; and by the *Heraclias*, a general survey of the exploits of Heraclius both at home and abroad down to the final overthrow of Chosroes in 627. George Pisida was also the author of a didactic poem, *Hexaëmeron* or *Cosmourgia*, upon the creation of the world; a treatise on the vanity of life, after the manner of *Ecclesiastes*; a controversial composition against Severus, bishop of Antioch; two short poems upon the resurrection of Christ and on the recovery of the sacred crucifix stolen by the Persians. The metre chiefly used is the iambic. As a versifier Pisida is correct and even elegant; as a chronicler of contemporary events he is exceedingly useful; and later Byzantine writers enthusiastically compared him with, and even preferred him to Euripides. Recent criticism, however,

characterizes his compositions as artificial and almost uniformly dull.

Complete works in J. P. Migne, *Patrologia Graeca*, xcii.; see also *De Georgii Pisidae apud Theophanem alioque historicos reliquis* (1900), by S. L. Sternbach, who has edited several new poems for the first time from a Paris MS. in *Wiener Studien*, xiii., xiv. (1891-1892); C. Krumbacher, *Geschichte der byzantinischen Litteratur* (1897); C. F. Bähr in Ersch and Gruber's *Allgemeine Encyclopädie*.

GEORGE, LAKE, a lake in the E. part of New York, U.S.A., among the S.E. foothills of the Adirondack Mountains. It extends from N.N.E. to S.S.W. about 34 m., and varies in width from 2 to 4 m. It has a maximum depth of about 400 ft., and is 323 ft. above the sea and 227 ft. above Lake Champlain, into which it has an outlet to the northward through a narrow channel and over falls and rapids. The lake is fed chiefly by mountain brooks and submerged springs; its bed is for the most part covered with a clean sand; its clear water is coloured with beautiful tints of blue and green; and its surface is studded with about 220 islands and islets, all except nineteen of which belong to the state and constitute a part of its forest reserve. Near the head of the lake is Prospect Mountain, rising 1736 ft. above the sea, while several miles farther down the shores is Black Mountain, 2661 ft. in height. Lake George has become a favourite summer resort. Lake steamers ply between the village of Lake George (formerly Caldwell) at the southern end of the lake and Baldwin, whence there is rail connexion with Lake Champlain steamers.

Lake George was formed during the Glacial period by glacial drift which clogged a pre-existing valley. According to Prof. J. F. Kemp the valley occupied by Lake George was a low pass before the Glacial period; a dam of glacial drift at the southern end and of lacustrine clays at the northern end formed the lake which has submerged the pass, leaving higher parts as islands. Before the advent of the white man the lake was a part of the war-path over which the Iroquois Indians frequently made their way northward to attack the Algonquins and the Hurons, and during the struggle between the English and the French for supremacy in America, waterways being still the chief means of communication, it was of great strategic importance (see CHAMPLAIN, Lake). Father Isaac Jogues, René Goupil and Guillaume Couture seem to have been the first white men to see the lake (on the 9th of August 1642) as they were being taken by their Iroquois captors from the St Lawrence to the towns of the Mohawks, and in 1646 Father Jogues, having undertaken a half-religious, half-political mission to the Mohawks, was again at the lake, to which, in allusion to his having reached it on the eve of Corpus Christi, he gave the name Lac Saint Sacrement. This name it bore until the summer of 1755, when General William Johnson renamed it Lake George in honour of King George II.

General Johnson was at this time in command of a force of colonists and Indians sent against the French at Crown Point on Lake Champlain. The expedition, however, had proceeded no farther than to the head of Lake George when Johnson was informed that a force of French and Indians under Baron Ludwig August Dieskau was pushing on from Crown Point to Fort Lyman (later Fort Edward), 14 m. to the S. of their encampment. Accordingly, on the morning of the 8th of September a detachment of 1000 colonials under Colonel Ephraim Williams (1715-1755) and 200 Indians under Hendrick, a Mohawk chief, was sent to aid Fort Lyman, but when about 3 m. S. of the lake this detachment fell into an ambushade prepared for it by Dieskau and both Williams and Hendrick were killed. The survivors were pursued to their camp, and then followed on the same day the main battle of Lake George, in which 1000 colonials fighting at first behind a hastily prepared barricade defeated about 1400 French and Indians. Both commanders were wounded; Dieskau was captured; the French lost about 300; and the colonials nearly the same (including those who fell earlier in the day). Johnson now built on the lake shore, near the battlefield, a fort of gravel and logs and called it Fort William Henry (the site was occupied by the Fort William Henry Hotel till it was burned in 1909). In the meantime the French entrenched themselves at Ticonderoga at the foot of the lake. In March 1757 Fort William Henry successfully withstood an attack of 1600

men sent out by the marquis de Vaudreuil, governor of Canada, but on the 9th of August of the same year its garrison, after being reduced to desperate straits, surrendered to the marquis de Montcalm. By the terms of surrender the garrison was to be allowed to march out with the honours of war and was to be escorted to Fort Edward, but the guard provided by Montcalm was inadequate to protect them from his Indian allies and on the day following the surrender many were massacred or taken prisoners. The fort was razed to the ground. In 1758 General James Abercrombie proceeded by way of Lake George against Fort Ticonderoga, and in 1759 Baron Jeffrey Amherst, while on his way to co-operate with General James Wolfe against Quebec, built near the site of Fort William Henry one bastion of a fort since known as Fort George, the ruins of which still remain.

A monument commemorative of the battle of Lake George was unveiled on the 8th of September 1903, on the site of the battle, and within the state reservation of 35 acres known as Fort George Battle Park. Horicon is a name that was given to the lake by James Fenimore Cooper. The Indian name of the lake was Andia-ta-roc-te.

See Francis Parkman, *Montcalm and Wolfe* (Boston, 1884), and E. E. Seelye, *Lake George in History* (Lake George, 1897).

GEORGE JUNIOR REPUBLIC, an American industrial institution, situated near the small village of Freeville, in Tompkins county, New York, U.S.A., 9 m. E.N.E. of Ithaca, at the junction of the Sayre-Auburn and the Elmira-Cortland branches of the Lehigh Valley railway. The George Junior Republic forms a miniature state whose economic, civic and social conditions, as nearly as possible, reproduce those of the United States, and whose citizenship is vested in young people, especially those who are neglected or wayward, who are thus taught self-reliance, self-control and morality. The founder, William Reuben George (b. 1866), was a native of West Dryden, a village near Freeville, who as a business man in New York City became interested in the Fresh Air Fund charity supervised by the *New York Tribune*, took charge of summer outings for city children (1890-1894), and, becoming convinced that such charities tended to promote pauperism and crime among the older of their protégés, devised first (1894) the plan of requiring payment by the children in labour for all they received during these summer jaunts, then (1895) self-government for a summer colony near Freeville, and finally a permanent colony, in which the children stay for several years. The Republic was founded on the 10th of July 1895; the only check on the powers of executive, representative and judicial branches of the government lies in the veto of the superintendent. "Nothing without labour" is the motto of the community, so strictly carried out that a girl or boy in the Republic who has not money¹ to pay for a night's lodging must sleep in jail and work the next day for the use of the cell. The legislative body, originally a House of Representatives and a Senate, in 1899 became more like the New England town meeting. The respect for the law that follows its enactment by the citizens themselves is remarkable in a class so largely of criminal tendencies; and it is particularly noticeable that positions on the police force are eagerly coveted. Fifteen is the age of majority; suffrage is universal, children under fifteen must be in charge of a citizen guardian. The average age of citizens was seventeen in 1908. The proportion of girls to boys was originally small, but gradually increased; in 1908 there were about 70 girls and 90 boys. The tendency is to admit only those aged at least sixteen and physically well equipped. In the Republic's earlier years the citizens lived in boarding-houses of different grades, but later in family groups in cottages (there were in 1910 twelve cottages) under the care of "house-mothers." The labour of the place is divided into sewing, laundry work, cooking and domestic service for the girls, and furniture making, carpentry, farm work, baking bread and wafers (the business of an Auburn biscuit factory was bought in 1903), plumbing and printing for the boys. Masonry and

¹The "government" issued its own currency in tin and later in aluminium, and "American" money could not be passed within the 48 acres of the Republic until 1906, when depreciation forced the Republic's coinage out of use and "American" coin was made legal tender.

shoe and harness making were tried for a few years. There is an efficient preparatory and high school, from which students enter directly leading colleges. The religious influence is strong, wholesome and unsectarian; students in Auburn Theological Seminary have assisted in the religious work; Roman Catholic and Hebrew services are also held; and attendance at church services is compulsory only on convicts and prisoners.

There are "Woman's Aid" societies in New York City, Ithaca, Syracuse, Buffalo, Boston and elsewhere, to promote the work of the Republic. A "republic" for younger boys, begun at Freeville, was established in Litchfield, Connecticut; and a National Junior Republic near Annapolis Junction, Maryland, and a Carter Junior Republic at Readington, near Easton, Pennsylvania, are modelled on the George Junior Republic. In 1908-1910 new "states" were established at Chino, California, Grove City, Pennsylvania, and Flemington Junction, New Jersey. In February 1908 the National Association of Junior Republics was formed with Mr George (its founder) as its director, its aims being to establish at least one "republic" in each state of the Union, and in other countries similar institutions for youth and miniature governments modelled on that of the country in which each "state" is established, and to establish colonies for younger children, to be sent at the age of fifteen to the Junior Republic. At the time of its formation the National Association included the "states" at Freeville, N.Y., Litchfield, Conn., and Annapolis Junction, Md.; others joined the federation later.

See William R. George, *The Junior Republic: its History and Ideals* (New York, 1910); *The Junior Republic Citizen* (Freeville, 1895 seq.), written and printed by "citizens"; *Nothing Without Labor, George Junior Republic* (7th ed., Freeville, 1909), a manual; J. R. Commons, "The Junior Republic," in *The American Journal of Sociology* (1898); D. F. Lincoln, "The George Junior Republic," in *The Coming Age* (1900); and Lyman Abbott, "A Republic within a Republic," in the *Outlook* for February 15, 1908.

GEORGETOWN, the capital of British Guiana (see **GUIANA**), and the seat of the colonial government, situated on the left bank of the Demerara river at its mouth, in 6° 29' 24" N. and 58° 11' 30" W. It was known during the Dutch occupation as Stabroek, and was established as the seat of government of the combined colonies of Essequibo and Demerara (now with Berbice forming the three counties of British Guiana) in 1784, its name being changed to Georgetown in 1812. It is one of the finest towns in this part of the world, the streets being wide and straight, intersecting each other at right angles, several having double roadways with lily-covered canals in the centre, the grass banks on either side carrying rows of handsome shade trees. In Main Street, the finest street in Georgetown, the canal has been filled in to form a broad walk, an obvious precedent for the treatment of the other canals, which (however beautiful) are useless and merely act as breeding grounds for mosquitoes. The principal residences, standing in their own gardens surrounded by foliage and flowers, are scattered over the town, as are also the slums, almost the worst of which abut on the best residential quarters. Water Street, the business centre, runs parallel to the river for about 2½ m. and contains the stores of the wholesale and retail merchants, their wharves running out into the river to allow steamers to come alongside. Most of the houses and public buildings are constructed of wood, the former generally raised on brick pillars some 4 ft. to 10 ft. from the ground, the bright colouring of the wooden walls, jalousies and roofs adding to the beauty of the best streets. The large structure known as the Public Buildings in the centre of the city, containing the offices of the executive government and the hall of the court of policy, was erected between 1829 and 1834. It is a handsome, E-shaped, brick-plastered building of considerable size, with deep porticos and marble-paved galleries carried on cast-iron columns. The law courts, built in the 'eighties, have a ground floor of concrete and iron, the upper storey being of hardwood. Among other public buildings are the town hall, the Anglican and Roman Catholic cathedrals, several handsome churches, the local banks and insurance offices, and the almshouse. The public hospital consists of several large blocks. The Royal

and Effingham counties. Here the prevailing soils are grey and sandy with a subsoil of loam, but they are less fertile than those of the Lime Sink or Cotton Belts. The coast counties of the S.E. and generally those on the Florida frontier are not suitable for cultivation, on account of the numerous marshes and swamps, Okefinokee Swamp being 45 m. long and approximately 30 m. wide; but the southern portions of Decatur, Grady, Thomas and Brooks counties are sufficiently elevated for agriculture, and the islands off the coast are exceedingly productive.

Minerals.—The mineral resources of Georgia are as varied as its climate and soils, a total of thirty-nine different mineral products being found within its borders. The most important is stone: in 1905 the value of the granite quarried in the state was \$971,207 (Georgia ranking fifth in the United States), of the marble \$774,550 (Georgia ranking third in the United States, Vermont and New York being first and second); in 1908 the granite was valued at \$970,832 (Georgia ranking fifth in the United States), and the marble at \$916,781 (Georgia ranking second in the United States, Vermont being first). Generally more than one-fourth of the granite is used for paving; curb, building and monument stone are next in importance in the order named. Stone Mountain (1866 ft.) in De Kalb county near Atlanta is a remarkable mass of light-coloured muscovite granite, having a circumference at its base of 7 m. Stone Mountain granite was first quarried about 1850; it is extensively used as building material in Georgia and other southern states. A laminated granite, otherwise like the Stone Mountain granite, is found in De Kalb, Rockdale and Gwinnett counties, and is used for curbing and building. Biotite granites, which take a good polish and are used for monuments and for decoration, are quarried in Oglethorpe and Elbert counties. Georgia marble was first quarried on a large scale in Pickens county in 1834; the pure white marble of this county had been worked for tombstones near Tate, the centre of the marble belt, in 1840; after its commercial exploitation it was used in the capitol buildings of Georgia, Rhode Island, Mississippi and Minnesota, in the Corcoran Art Gallery, Washington, D.C., and in St Luke's Hospital, New York City. It is sometimes used for the entire building, and sometimes only for decoration. Other colours than the snowy white are found in the main marble belt of the state, which runs from Canton, Cherokee county, 60 m. generally N. to the northern boundary of the state. Other deposits, less well known, are the dark brown and light grey marbles of Whitfield county, which resemble the stone quarried in eastern Tennessee. Limestone and slate are quarried at Rock Mart, Polk county, and there are cement quarries at Cement, near Kingston, Bartow county. Iron deposits occur in Bartow, Polk and Floyd counties, where are the more important brown ores, and (red ones) in Walker and Chattooga counties. The quantity of iron ore mined in Georgia declined from 1890 to 1900; it was 200,842 long tons in 1905 and 321,060 long tons in 1908, when 319,812 tons were brown haematite and 1248 tons were red haematite. Before the discovery of gold in California the Georgia "placers" were very profitable, the earliest mining being in 1829 by placer miners from the fields of Burke county, North Carolina, who began work in what is now White county, and went thence to Habersham and Lumpkin counties. Dahlonega and Auraria, the latter named by John C. Calhoun, who owned a mine there, were the centres of this early gold mining. Work was summarily stopped by Federal troops enforcing the governor's proclamation in 1831, because of the disorder in the mining region; but it was soon renewed and a mint was established at Dahlonega in 1838. After the discovery of gold in California, mining in Georgia was not renewed on anything but the smallest scale until the early 'eighties. In 1908 the gold product was valued at \$56,207 (it was \$96,910 in 1905) and the silver product at \$106. Up to 1900 the gold product of Georgia (see State Geol. Survey *Bulletin 19*) was about \$17,500,000. Extensive clay deposits occur in all parts of the state, and are remarkable for their comparative freedom from impurities and for their high fusion point, the most valuable are sedimentary, and form a belt several miles wide across the middle of the state from Augusta to Columbus. In 1908 the clay products of the state were valued at \$1,928,611. More asbestos has been found in Georgia than in any other state of the Union; it occurs in the amphibole form throughout the N. part of the state, and most of the country's domestic supply comes from the Sall Mountain mine in White county. Manganese ores, found in Bartow, Polk and Floyd counties, were formerly important; in 1896 4096 long tons were mined, in 1905 only 150 tons, and in 1908 none. Bauxite was found in Georgia first of the United States, near Rome, in 1887; the output, principally from Floyd, Bartow and Polk counties, was the entire product of the United States until 1891, and in 1902 was more than half the country's product, but in 1908, even when combined with the Alabama output, was less than the amount mined in Arkansas. Coal is not extensively found, but the mine on Sand Mountain, in Walker county, was one of the first opened S. of the Ohio river; in 1908 the value of the coal mined in the state was \$364,279 (764,822 short tons), the value of coke at the ovens was \$137,522 (130,422 short tons), and the value of ammonium sulphate, coal tar, illuminating gas and gas coke was more than \$800,000.

Copper was mined in Fannin and Cherokee counties before the Civil War. In 1906 the copper mined was valued at \$5057. Corundum was discovered on Laurel Creek in Rabun county in 1871, and was worked there and at Trackrock, Union county, especially between 1880 and 1893, but in later years low prices closed most of the mines. The limestone formations furnished most of the lime for domestic use. Sandstone, ochre, slate, soapstone, graphite are also mined, and lead, zinc, barytes, gypsum and even diamonds have been discovered but not exploited.

Agriculture.—The principal occupation in Georgia is agriculture, which in 1900 engaged seven-tenths of the land surface of the state and the labour of three-fifths of the population, ten years old and over, who are employed in profitable occupations. The products are so diversified that, with the exception of some tropical fruits of California and Florida, almost everything cultivated in the United States can be produced. The chief staple is cotton, of which a valuable hybrid called the *Floradora* a cross of long and short staple, has been singularly successful. Cotton is raised in all counties of the state except Rabun, Towns and Fannin in the extreme north, and about one-third of the total cultivated land of the state was devoted to it in 1900-1907. In 1899-1904 the crop exceeded that of the other cotton-producing states except Texas, and in 1899, 1900 and 1903 Mississippi, averaging 1,467,121 commercial bales per annum; the crop in 1904 was 1,991,719 bales, and in 1907-1908 the crop was 1,815,834 bales, second only to the crop of Texas. The cause of this extensive cultivation of cotton is not a high average yield per acre, but the fact that before 1860 "Cotton was King," and that the market value of the staple when the Civil War closed was so high that farmers began to cultivate it to the exclusion of the cereals, whose production, Indian corn excepted, showed a decline during each decade from 1879 to 1899. But in the 'nineties the price of the cotton fell below the cost of production, owing to the enormous supply, and this was accompanied by economic depression. These conditions have caused some diversification of crops, and successful experiments in cattle-raising, movements encouraged by the Department of Agriculture and the leading newspapers.

The principal cereals cultivated are Indian corn (product, 53,750,000 bushels in 1908) and wheat; the cultivation of the latter, formerly remunerative, declined on account of the competition of the Western States, but revived after 1890, largely owing to the efforts of the Georgia Wheat Growers' Association (organized in 1897), and in 1908 the yield was 2,208,000 bushels. The sugar-cane crop declined in value after 1890, and each year more of it was made into syrup. In 1908 the tobacco crop was 2,705,625 lb, and the average farm price was 35 cents, being nearly as high as that of the Florida crop; Sumatra leaf for wrappers is grown successfully. The acreage and product of tobacco and peanuts increased from 1890 to 1900 respectively 188% and 319.2%, and 92.6% and 129.9%, and in the production of sweet potatoes Georgia was in 1899 surpassed only by North Carolina. Alfalfa and grasses grow well. Truck farming and the cultivation of orchard and small fruits have long been remunerative occupations; the acreage devoted to peaches doubled between 1890 and 1900. Pecan nuts are an increasingly important crop.

Agriculture in Georgia was in a state of transition at the beginning of the 20th century. Owing to the abundance of land and to negro slavery, exploitative methods of cultivation were employed before the Civil War, and such methods, by which lands after being worked to exhaustion are deserted for new fields, had not yet been altogether abandoned. One reason for this was that, according to the census of 1900, 39.9% of the farms were operated by negroes, of whom 86% were tenants who desired to secure the greatest possible product without regard to the care of the soil. Consequently there were large tracts of untilled "waste" land; but these rapidly responded to fertilization and rotation of crops, often yielding 800 to 1200 lb of cotton per acre, and Georgia in 1899 used more fertilizers than any other state in the Union. Another feature of agriculture in Georgia was the great increase in the number of farms, the average size of plantations having declined from 440 acres in 1860 to 117.5 in 1900, or almost 75% while the area in cultivation increased only 15.6% between 1850 and 1900. The tenantry system was also undergoing a change—the share system which developed in the years succeeding the Civil War being replaced by a system of cash rental.

Manufactures.—Although excelled by Alabama in the





manufacture of mineral products, and by North Carolina and South Carolina in the number and output of cotton mills, in 1900 and in 1905 Georgia surpassed each of those states in the total value of factory products, which was, however, less than the value of the factory products of Louisiana and Virginia among the southern states. The chief features of this industrial activity are its early beginning and steady, constant development. As far back as 1850 there were 1522 manufacturing establishments (35 of which were cotton mills) in the state, whose total product was valued at \$7,082,075. Despite the Civil War, there was some advance during each succeeding decade, the most prosperous relatively being that from 1880 to 1890. In 1900 the number of establishments was 7504, an increase of 75.1% over the number in 1890; the capital invested was \$89,789,656, an increase of 57.7%, and the value of products (\$106,654,527) was 54.8% more than in 1890. Of the 7504 establishments in 1900, 3015 were conducted under the "factory system," and had a capital of \$79,303,316 and products valued at \$94,532,368. In 1905 there were 3219 factories, with a capital of \$135,211,551 (an increase of 70.5% over 1900), and a gross product valued at \$151,040,455 (59.8% greater than the value of the factory product in 1900).

The most important manufacturing industries are those that depend upon cotton for raw material, with a gross product in 1900 valued at \$26,521,757. In that year there were 67 mills engaged in the manufacture of cotton goods, with a capital of \$24,158,159, and they yielded a gross product valued at \$18,457,645; the increase between 1900 and 1905 was actually much larger (and proportionately very much larger) than between 1890 and 1900; the number of factories in 1905 was 101 (an increase of 53.7% over 1900); their capital was \$42,349,618 (53.7% more than in 1900); and their gross product was valued at \$35,174,248 (an increase of 90.6% since 1900). The rank of Georgia among the cotton manufacturing states was seventh in 1900 and fourth in 1905. Cotton-seed oil and cake factories increased in number from 17 to 43 from 1890 to 1900, and to 112 in 1905, and the value of their product increased from \$1,670,196 to \$8,064,112, or 382.8% in 1890-1900, and to \$13,539,899 in 1905, or an increase of 67.0% over 1900, and in 1900 and in 1905 the state ranked second (to Texas) in this industry in the United States. This growth in cotton manufactures is due to various causes, among them being the proximity of raw material, convenient water-power, municipal exemption from taxation and the cheapness of labour. The relation between employer and employee is in the main far more personal and kindly than in the mills of the Northern States.

The forests of Georgia, next to the fields, furnish the largest amount of raw material for manufactures. The yellow pines of the southern part of the state, which have a stand of approximately 13,778,000 ft., yielded in 1900 rosin and turpentine valued at \$8,110,468 (more than the product of any other state in the Union) and in 1905 valued at \$7,705,643 (second only to the product of Florida). From the same source was derived most of the lumber product valued in 1900 at \$13,341,160 (more than double what it was in 1890) and in 1905 at \$16,716,594. The other important woods are cypress, oak and poplar.

Fourth in value in 1905 (first, cotton goods; second, lumber and timber; third, cotton-seed oil and cake) were fertilizers, the value of which increased from \$3,367,353 in 1900 to \$9,461,415 in 1905, when the state ranked first of the United States in this industry; in 1900 it had ranked sixth.

Communications.—Means of transportation for these products are furnished by the rivers, which are generally navigable as far north as the "fall line" passing through Augusta, Milledgeville, Macon and Columbus; by ocean steamship lines which have piers at St Mary's, Brunswick, Darien and Savannah; and by railways whose mileage in January 1909 was 6,871.8 m. The most important of the railways are the Central of Georgia, the Southern, the Atlantic Coast Line, the Seaboard Air Line, the Georgia and the Georgia Southern & Florida. In 1878 a state railway commission was established which has mandatory power for the settlement of all traffic problems and makes annual reports.

Population.—The population of Georgia in 1880 was 1,542,180; in 1890 1,837,353, an increase of 19.1%; in 1900 2,216,331, a fur-

ther increase of 20.6%; in 1910, 2,609,121. Of the 1900 population, 53.3% were whites and 46.7% were negroes, the centre of the black population being a little south of the "fall line." Here the negroes increased, from 1890 to 1900, faster than the whites in eighteen counties, but in northern Georgia, where the whites are in the majority, the negro population declined in twelve counties. Also the percentage of negro illiterates is higher in northern Georgia than in other parts of the state, the percentage of negro male illiterates of voting age being 38.1% in Atlanta in 1900, and in Savannah only 30.7%. The population of Georgia has a very slight foreign-born element (.6% in 1900) and a small percentage (1.7% in 1900) of people of foreign parentage. The urban population (i.e. the population in places of 2500 inhabitants and over) was 15.6% of the total in 1900, and the number of incorporated cities, towns and villages was 372. Of these only forty had a population exceeding 2000, and thirteen exceeding 5000. The largest city in 1900 was Atlanta, the capital since 1868 (Louisville, Jefferson county, was the capital in 1795-1804, and Milledgeville in 1804-1868), with 89,872 inhabitants. Savannah ranked second with 54,244, and Augusta third with 39,441. In 1900 the other cities in the state with a population of more than 5000 were: Macon (23,272), Columbus (17,614), Athens (10,245), Brunswick (9081), Americus (7674), Rome (7291), Griffin (6857), Waycross (5919), Valdosta (5613), and Thomasville (5322).

The total membership of the churches in 1906 was about 1,029,037, of whom 506,319 were Baptists, 349,079 were Methodists, 24,040 were Presbyterians, 19,273 were Roman Catholics, 12,703 were Disciples of Christ, 9790 were Protestant Episcopalians, and 5581 were Congregationalists.

Government.—The present constitution, which was adopted in 1877,¹ provides for a system of government similar in general to that of the other states (see UNITED STATES). The executive officials are elected for a term of two years, and the judges of the Supreme Court and of the court of appeals for six years, while those of the superior court and of the ordinaries and the justices of the peace are chosen every four years. Before 1909 all male citizens of the United States at least twenty-one years of age (except those mentioned below), who had lived in the state for one year immediately preceding an election and in the county six months, and had paid their taxes, were entitled to vote. From the suffrage and the holding of office are excluded idiots and insane persons and all those who have been convicted of treason, embezzlement, malfeasance in office, bribery or larceny, or any crime involving moral turpitude and punishable under the laws of the state by imprisonment in the penitentiary—this last disqualification, however, is removable by a pardon for the offence. Before 1909 there was no constitutional discrimination aimed against the exercise of the suffrage by the negro, but in fact the negro vote had in various ways been greatly reduced. By a constitutional amendment adopted by a large majority at a special election in October 1908, new requirements for suffrage, designed primarily to exclude negroes, especially illiterate negroes, were imposed (supplementary to the requirements mentioned above concerning age, residence and the payment of taxes), the amendment coming into effect on the 1st of January 1909: in brief this amendment requires that the voter shall have served in land or naval forces of the United States or of the Confederate States or of the state of Georgia in time of war, or be lawfully descended from some one who did so serve; or that he be a person of good character who proves to the satisfaction of the registrars of elections that he understands the duties and obligations of a citizen; or that he read correctly in English and (unless physically disabled) write any paragraph of the Federal or state constitution; or that he own 40 acres of land or property valued at \$500 and assessed for

¹ The manufacturing statistics for 1900 which follow are not those given in the Twelfth Census, but are taken from the *Census of Manufactures, 1905*, the 1900 figures here given being only for establishments on a factory basis, and thus being comparable with those of 1905. In 1890 there were 53 mills with a capital of \$17,664,675 and a product valued at \$12,035,629.

² In these valuations for 1900 and for 1905 the rough lumber dressed or remanufactured in planing mills enters twice into the value of the product.

³ The population of the state was 82,548 in 1790, 162,686 in 1800, 252,433 in 1810, 340,989 in 1820, 516,823 in 1830, 691,392 in 1840, 906,185 in 1850, 1,057,286 in 1860, and 1,184,100 in 1870.

⁴ This negro percentage includes 211 Chinese, Japanese and Indians.

⁵ The state has had four other constitutions—those of 1777, 1789, 1798 and 1868.

taxation. After the 1st of January 1915 no one may qualify as a voter under the first or second of these clauses (the "grandfather" and "understanding" clauses); but those who shall have registered under their requirements before the 1st of January 1915 thus become voters for life.

The governor, who receives a salary of \$5000, must be at least thirty years old, must at the time of his election have been a citizen of the United States for fifteen years and of the state for six years, and "shall not be eligible to re-election after the expiration of a second term, for the period of four years." In case of his "death, removal or disability," the duties of his office devolve in the first instance upon the president of the Senate, and in the second upon the speaker of the House of Representatives. The governor's power of veto extends to separate items in appropriation bills, but in every case his veto may be overridden by a two-thirds vote of the legislature. An amendment to the constitution may be proposed by a two-thirds vote of the legislature, and comes into effect on receiving a majority of the popular vote. Members of the Senate must be at least twenty-five years old, must be citizens of the United States, and must, at the time of their election, have been citizens of the state for four years, and of the senatorial district for one year; representatives must be at least twenty-one years old, and must, at the time of their election, have been citizens of the state for two years. By law, in Georgia, lobbying is a felony.

Habitual intoxication, wilful desertion for three years, cruel treatment, and conviction for an offence the commission of which involved moral turpitude and for which the offender has been sentenced to imprisonment for at least two years, are recognized as causes for divorce. All petitions for divorce must be approved by two successive juries, and a woman holds in her own name all property acquired before and after marriage. Marriage between the members of the white and negro races is prohibited by law.

As the result of the general campaign against child labour, an act was passed in 1906 providing that no child under 10 shall be employed or allowed to labour in or about any factory, under any circumstances; after the 1st of January 1907 no child under 12 shall be so employed, unless an orphan with no other means of support, or unless a widowed mother or disabled or aged father is dependent on the child's labour, in which case a certificate to the facts, holding good for one year only, is required; after the 1st of January 1908 no child under 14 shall be employed in a factory between the hours of 7 P.M. and 6 A.M.; after the same date no child under 14 shall be employed in any factory without a certificate of school attendance for 12 weeks (of which 6 weeks must be consecutive) of the preceding year; no child shall be employed without the filing of an affidavit as to age. Making a false affidavit as to age or as to other facts required by the act, and the violation of the act by any agent or representative of a factory or by any parent or guardian of a child are misdemeanours.

In 1907 a state law was passed prohibiting after the 1st of January 1908 the manufacture or sale of intoxicating liquors; nine-tenths of the counties of the state, under local option laws, were already "dry" at the passage of this bill. The law permits druggists to keep for sale no other form of alcoholic drink than pure alcohol; physicians prescribing alcohol must fill out a blank, specifying the patient's ailment, and certifying that alcohol is necessary; the prescription must be filled the day it is dated, must be served directly to the physician or to the patient, must not call for more than a pint, and may not be refilled.¹

The state supports four benevolent institutions: a lunatic asylum for the whites and a similar institution for the negroes, both at Milledgeville, an institute for the deaf and dumb at Cave Spring, and an academy for the blind at Macon. There are

¹ Owing to the custom which holds in Georgia of choosing state senators in rotation from each of the counties making up a senatorial district, it happened in 1907 that few cities were represented directly by senators chosen from municipalities. It is believed that this fact contributed to the passage of the prohibition law.

also a number of private charitable institutions, the oldest being the Bethesda orphan asylum, near Savannah, founded by George Whitefield in 1739. The Methodist, Baptist, Roman Catholic and Protestant Episcopal Churches, and the Hebrews of the state also support homes for orphans. A penitentiary was established in 1817 at Milledgeville. In 1866 the lease system was introduced, by which the convicts were leased for a term of years to private individuals. In 1897 this was supplanted by the contract system, by which a prison commission accepted contracts for convict labour, but the prisoners were cared for by state officials. But the contract system for convicts and the peonage system (under which immigrants were held in practical slavery while they "worked out" advances made for passage-money, &c.) were still sources of much injustice. State laws made liable to prosecution for misdemeanour any contract labourer who, having received advances, failed for any but good cause to fulfil the contract; or any contract labourer who made a second contract without giving notice to his second employer of a prior and unfulfilled contract; or any employer of a labourer who had not completed the term of a prior contract. In September 1908, after an investigation which showed that many wardens had been in the pay of convict lessees and that terrible cruelty had been practised in convict camps, an extra session of the legislature practically put an end to the convict lease or contract system; the act then passed provided that after the 31st of March 1909, the date of expiration of leases in force, no convicts may be leased for more than twelve months and none may be leased at all unless there are enough convicts to supply all demands for convict labour on roads made by counties, each county to receive its *pro rata* share on a population basis, and to satisfy all demands made by municipalities which thus secure labour for \$100 per annum (per man) paid into the state treasury, and all demands made by the state prison farm and factory established by this law.

Education.—Georgia's system of public instruction was not instituted until 1870, but as early as 1817 the legislature provided a fund for the education in the private schools of the state of children of indigent parents. The constitution of 1868 authorized "a thorough system of general education, to be for ever free to all children of the State," and in 1870 the first public school law was enacted. Education, however, has never been made compulsory. The constitution, as amended in 1905, provides that elections on the question of local school taxes for counties or for school districts may be called upon a petition signed by one-fourth of the qualified voters of the county, or district, in question; under this provision several counties and a large number of school districts are supplementing the general fund. But the principal source of the annual school revenue is a state tax; the fund derived from this tax, however, is not large enough. In 1908 the common school fund approximated \$3,786,830, of which amount the state paid \$2,163,200 and about \$1,010,680 was raised by local taxation. In 1908 69% of the school population (79% of whites; 58% of negroes) were enrolled in the schools; in 1902 it was estimated that the negroes, 52.3% of whom (10 years of age and over) were illiterates (*i.e.* could not write or could neither read nor write) in 1900 (81.6% of them were illiterate in 1880), received the benefit of only about a fifth of the school fund. Of the total population, 10 years of age and over, 30.5% were illiterates in 1900—49.9% were illiterates in 1880—and as regards the whites of native birth alone, Georgia ranked ninth in illiteracy, in 1900, among the states and territories of the Union. Of the illiterates about four-fifths were negroes in 1900. In addition to the public schools, the state also supports the University of Georgia; and in 1906 \$235,000 was expended for the support of higher education. In 1906–1907 eleven agricultural and mechanical arts colleges were established, one in each congressional district of the state. Of the colleges of the university, Franklin was the first state college chartered in America (1785); the Medical College of Georgia, at Augusta, was opened in 1829; the State College of Agriculture and Mechanic Arts was established at Athens in 1872; the North Georgia Agricultural College, at

Dahlonega, was opened in 1873; the Georgia School of Technology, at Atlanta, in 1888; the Georgia Normal and Industrial College (for women), in Milledgeville, in 1899; the Georgia State Normal School, at Athens, in 1895; the Georgia State Industrial College for Coloured Youth, near Savannah, in 1890; the School of Pharmacy, at Athens, in 1903; and the School of Forestry, and the Georgia State College of Agriculture, at Athens, in 1906. Affiliated with the university, but not receiving state funds, are three preparatory schools, the South Georgia Military and Agricultural College at Thomasville, the Middle Georgia Military and Agricultural College at Milledgeville, and the West Georgia Agricultural and Mechanical College at Hamilton. Among the institutions generally grouped as denominational are—Baptist: Mercer University, at Macon (Penfield, 1837; Macon, 1871), Shorter College (1877) at Rome, Spelman Seminary (1881) in Atlanta for negro women and girls, and Bessie Tift College, formerly Monroe College (1849) for women, at Forsyth; Methodist Episcopal: Emory College (1836), at Oxford, and Wesleyan Female College (1836) at Macon, both largely endowed by George Inghram Seney (1837-1893), and the latter one of the earliest colleges for women in the country; Methodist Episcopal Church, South: Young Harris College (1855) at Young Harris, Andrew Female College (1854) at Cuthbert, and Dalton Female College (1872) at Dalton; Presbyterian: Agnes Scott College at Decatur; and African Methodist Episcopal: Morris Brown College (1885) at Atlanta. A famous school for negroes is the non-sectarian Atlanta University (incorporated in 1867, opened in 1869), which has trained many negroes for teaching and other professions. Non-sectarian colleges for women are: Lucy Cobb Institute (1858) at Athens, Cox College (1843) at College Park, near Atlanta, and Brenau College Conservatory (1878) at Gainesville.

Finance.—The assessed value of taxable property in 1910 was about \$735,000,000. A general property tax, which furnishes about four-fifths of the public revenue, worked so inequitably that a Board of Equalization was appointed in 1901. By the Constitution the tax rate is limited to \$5 on the thousand, and, as the rate of taxation has increased faster than the taxable property, the state has been forced to contract several temporary loans since 1901, none of which has exceeded \$200,000, the limit for each year set by the Constitution. On the 1st of January 1910 the bonded debt was \$6,044,000, mainly incurred by the extravagance of the Reconstruction administration (see *History*, below). Each year \$100,000 of this debt is paid off, and there are annual appropriations for the payment of interest (about \$303,260 in 1910). The state owns the Western & Atlantic railway (137 m. long) from Chattanooga, Tennessee, to Atlanta, which has valuable terminal facilities in both cities, and which in 1910 was estimated to be worth \$8,400,240 (more than the amount of the bonded debt); this railway the state built in 1841-1850, and in 1890 leased for 29 years, at an annual rental of \$420,012, to the Nashville, Chattanooga & St. Louis railway.

Banking in Georgia is in a prosperous condition. The largest class of depositors are the farmers, who more and more look to the banks for credit, instead of to the merchants and cotton speculators. Hence the number of banks in agricultural districts is increasing. The state treasurer is the bank examiner, and to him all banks must make a quarterly statement and submit their books for examination twice a year. The legal rate of interest is 7%, but by contract it may be 8%.

History.—Georgia derives its name from King George II. of Great Britain. It was the last to be established of the English colonies in America. Its formation was due to a desire of the British government to protect South Carolina from invasion by the Spaniards from Florida and by the French from Louisiana, as well as to the desire of James Edward Oglethorpe (*q.v.*) to found a refuge for the persecuted Protestant sects and the unfortunate but worthy indigent classes of Europe. A charter was granted in 1732 to "the Trustees for establishing the colony of Georgia in America," and parliament gave £10,000 to the enterprise. The first settlement was made at Savannah in 1733 under the personal supervision of Oglethorpe. The early colonists were German Lutherans (Salzburgers), Piedmontese, Scottish Highlanders, Swiss, Portuguese Jews and Englishmen; but the main tide of immigration, from Virginia and the Carolinas, did not set in until 1752. As a bulwark against the Spanish, the colony was successful, but as an economic experiment it was a failure. The trustees desired that there should be grown

in the colony wine grapes, hemp, silk and medical plants (barilla, kali, cubeb, caper, madder, &c.) for which England was dependent upon foreign countries; they required the settlers to plant mulberry trees, and forbade the sale of rum, the chief commercial staple of the colonies. They also forbade the introduction of negro slaves. Land was leased by military tenure, and until 1739 grants were made only in male tail and alienations were forbidden. The industries planned for the colony did not thrive, and as sufficient labour could not be obtained, the importation of slaves was permitted under certain conditions in 1749. About the same time the House of Commons directed the trustees to remove the prohibition on the sale of rum. In 1753 the charter of the trustees expired and Georgia became a royal province.

Under the new regime the colony was so prosperous that Sir James Wright (1716-1785), the last of the royal governors, declared Georgia to be "the most flourishing colony on the continent." The people were led to revolt against the mother country through sympathy with the other colonies rather than through any grievance of their own. The centre of revolutionary ideas was St. John's Parish, settled by New Englanders (chiefly from Dorchester, Massachusetts). The Loyalist sentiment was so strong that only five of the twelve parishes sent representatives to the First Provincial Congress, which met on the 18th of January 1775, and its delegates to the Continental Congress therefore did not claim seats in that assembly. But six months later all the parishes sent representatives to another Provincial Congress which met on the 4th of July 1775. Soon afterward the royal government collapsed and the administration of the colony was assumed by a council of safety.

The war that followed was really a severe civil conflict, the Loyalist and Revolutionary parties being almost equal in numbers. In 1778 the British seized Savannah, which they held until 1782, meanwhile reviving the British civil administration, and in 1779 they captured Augusta and Sunbury; but after 1780 the Revolutionary forces were generally successful. Civil affairs also fell into confusion. In 1777 a state constitution was adopted, but two factions soon appeared in the government, led by the governor and the executive council respectively, and harmony was not secured until 1781.

Georgia's policy in the formation of the United States government was strongly national. In the constitutional convention of 1787 its delegates almost invariably gave their support to measures designed to strengthen the central government. Georgia was the fourth state to ratify (January 2, 1788), and one of the three that ratified unanimously, the Federal Constitution. But a series of conflicts between the Federal government and the state government caused a decline of this national sentiment and the growth of States Rights theories.

First of these was the friction involved in the case, before the Supreme Court of the United States, of *Chisolm v. Georgia*, by which the plaintiff, one Alexander Chisolm, a citizen of South Carolina, secured judgment in 1793 against the state of Georgia (see 2 Dallas Reports 419). In protest, the Georgia House of Representatives, holding that the United States Supreme Court had no constitutional power to try suits against a sovereign state, resolved that any Federal marshal who should attempt to execute the court's decision would be "guilty of felony, and shall suffer death, without benefit of clergy, by being hanged." No effort was made to execute the decision, and in 1798 the Eleventh Amendment to the Federal Constitution was adopted, taking from Federal courts all jurisdiction over any suit brought "against one of the United States by citizens of another state, or by citizens or subjects of any foreign state."

The position of Congress and of the Supreme Court with reference to Georgia's policy in the Yazoo Frauds also aroused distrust of the Federal government. In 1795 the legislature granted for \$500,000 the territory extending from the Alabama and Coosa rivers to the Mississippi river and between 35° and 31° N. lat. (almost all of the present state of Mississippi and more than half of the present state of Alabama) to four land companies, but in the following year a new legislature rescinded the contracts

on the ground that they had been fraudulently and corruptly made, as was probably the case, and the rescindment was embodied in the Constitution of 1798. In the meantime the United States Senate had appointed a committee to inquire into Georgia's claim to the land in question, and as this committee pronounced that claim invalid, Congress in 1800 established a Territorial government over the region. The legislature of Georgia remonstrated but expressed a willingness to cede the land to the United States, and in 1802 the cession was ratified, it being stipulated among other things that the United States should pay to the state \$1,250,000, and should extinguish "at their own expense, for the use of Georgia, as soon as the same can be peaceably obtained on reasonable terms," the Indian title to all lands within the state of Georgia. Eight years later the Supreme Court of the United States decided in the case of *Fletcher v. Peck* (6 Cranch 87) that such a rescindment as that in the new state constitution was illegal, on the ground that a state cannot pass a law impairing the obligation of contracts; and at an expense of more than four millions of dollars the Federal government ultimately extinguished all claims to the lands.

This decision greatly irritated the political leaders of Georgia, and the question of extinguishing the Indian titles, on which there had long been a disagreement, caused further and even more serious friction between the Federal and state authorities. The National government, until the administration of President Jackson, regarded the Indian tribes as sovereign nations with whom it alone had the power to treat, while Georgia held that the tribes were dependent communities with no other right to the soil than that of tenants at will. In 1785 Georgia made treaties with the Creeks by which those Indians ceded to the state their lands S. and W. of the Altamaha river and E. of the Oconee river, but after a remonstrance of one of their half-breed chiefs Congress decided that the cessions were invalid, and the National government negotiated, in 1790, a new treaty which ceded only the lands E. of the Oconee. The state appealed to the National government to endeavour to secure further cessions, but none had been made when, in 1802, the United States assumed its obligation to extinguish all Indian titles within the state. Several cessions were made between 1802 and 1824, but the state in the latter year remonstrated in vigorous terms against the dilatory manner in which the National government was discharging its obligation, and the effect of this was that in 1825 a treaty was negotiated at Indian Springs by which nearly all the Lower Creeks agreed to exchange their remaining lands in Georgia for equal territory beyond the Mississippi. But President J. Q. Adams, learning that this treaty was not approved by the entire Creek nation, authorized a new one, signed at Washington in 1826, by which the treaty of 1825 was abrogated and the Creeks kept certain lands W. of the Chattahoochee. The Georgia government, under the leadership of Governor George M. Troup (1780-1856), had proceeded to execute the first treaty, and the legislature declared the second treaty illegal and unconstitutional. In reply to a communication of President Adams early in 1827 that the United States would take strong measures to enforce its policy, Governor Troup declared that he felt it his duty to resist to the utmost any military attack which the government of the United States should think proper to make, and ordered the military companies to prepare to resist "any hostile invasion of the territory of this state." But the strain produced by these conditions was relieved by information that new negotiations had been begun for the cession of all Creek lands in Georgia. These negotiations were completed late in the year.

There was similar conflict in the relation of the United States and Georgia with the Cherokees. In 1785 the Cherokees of Georgia placed themselves under the protection of the Federal government, and in 1823 their chiefs, who were mostly half-breeds, declared: "It is the fixed and unalterable determination of this nation never again to cede one foot more of land," and that they could not "recognize the sovereignty of any state within the limits of their territory"; in 1827 they framed a constitution and organized a representative government. President Monroe and President J. Q. Adams treated the Cherokees with the

courtesy due to a sovereign nation, and held that the United States had done all that was required to meet the obligation assumed in 1802. The Georgia legislature, however, contended that the United States had not acted in good faith, declared that all land within the boundaries of the state belonged to Georgia, and in 1828 extended the jurisdiction of Georgia law to the Cherokee lands. Then President Jackson, holding that Georgia was in the right on the Indian question, informed the Cherokees that their only alternative to submission to Georgia was emigration. Thereupon the chiefs resorted to the United States Supreme Court, which in 1832 declared that the Cherokees formed a distinct community "in which the laws of Georgia have no force," and annulled the decision of a Georgia court that had extended its jurisdiction into the Cherokee country (*Worcester v. Georgia*). But the governor of Georgia declared that the decision was an attempt at usurpation which would meet with determined resistance, and President Jackson refused to enforce the decree. The President did, however, work for the removal of the Indians, which was effected in 1838.

On account of these conflicts a majority of Georgians adopted the principles of the Democratic-Republican party, and early in the 19th century the people were virtually unanimous in their political ideas. Local partisanship centred in two factions: one, led by George M. Troup, which represented the interests of the aristocratic and slave-holding communities; the other, formed by John Clarke (1766-1832) and his brother Elijah, found support among the non-slave-holders and the frontiersmen. The cleavage of these factions was at first purely personal; but by 1832 it had become one of principle. Then the Troup faction under the name of States Rights party, endorsed the nullification policy of South Carolina, while the Clarke faction, calling itself a Union party, opposed South Carolina's conduct, but on the grounds of expediency rather than of principle. On account, however, of its opposition to President Jackson's attitude toward nullification, the States Rights party affiliated with the new Whig party, which represented the national feeling in the South, while the Union party was merged into the Democratic party, which emphasized the sovereignty of the states.

The activity of Georgia in the slavery controversy was important. As early as 1835 the legislature adopted a resolution which asserted the legality of slavery in the Territories, a principle adopted by Congress in the Kansas Bill in 1854, and in 1847 ex-Governor Wilson Lumpkin (1783-1870) advocated the organization of the Southern states to resist the aggression of the North. Popular opinion at first opposed the Compromise of 1850, and some politicians demanded immediate secession from the Union; and the legislature had approved the Alabama Platform of 1848. But Congressmen Robert Toombs, Alexander H. Stephens, Whigs, and Howell Cobb, a Democrat, upon their return from Washington, contended that the Compromise was a great victory for the South, and in a campaign on this issue secured the election of such delegates to the state convention (at Milledgeville) of 1850 that that body adopted on the 10th of December, by a vote of 237 to 19, a series of conciliatory resolutions, since known as the "Georgia Platform," which declared in substance: (1) that, although the state did not wholly approve of the Compromise, it would "abide by it as a permanent adjustment of this sectional controversy," to preserve the Union, as the thirteen original colonies had found compromise necessary for its formation; (2) that the state "will and ought to resist, even (as a last resort) to the disruption of every tie that binds her to the Union," any attempt to prohibit slavery in the Territories or a refusal to admit a slave state. The adoption of this platform was accompanied by a party reorganization, those who approved it organizing the Constitutional Union party, and those who disapproved, mostly Democrats, organizing the Southern Rights party; the approval in other states of the Georgia Platform in preference to the Alabama Platform (see ALABAMA) caused a reaction in the South against secession. The reaction was followed for a short interval by a return to approximately the former party alignment, but in 1854 the rank

and file of the Whigs joined the American or Know-Nothing party while most of the Whig leaders went over to the Democrats. The Know-Nothing party was nearly destroyed by its crushing defeat in 1856 and in the next year the Democrats by a large majority elected for governor Joseph Emerson Brown (1821-1894), who by three successive re-elections was continued in that office until the close of the Civil War. Although Governor Brown represented the poorer class of white citizens he had taken a course in law at Yale College, had practised law, and at the time of his election was judge of a superior court; although he had never held slaves he believed that the abolition of slavery would soon result in the ruin of the South, and he was a man of strong convictions. The Kansas question and the attitude of the North toward the decision in the Dred Scott case were arousing the South when he was inaugurated the first time, and in his inaugural address he clearly indicated that he would favour secession in the event of any further encroachment on the part of the North. In July 1859 Senator Alfred Iverson (1798-1874) declared that in the event of the election of a Free-Soil president in 1860 he would favour the establishment of an independent confederacy; later in the same year Governor Brown expressed himself to a similar effect and urged the improvement of the military service. On the 7th of November following the election of President Lincoln the governor, in a special message to the legislature, recommended the calling of a convention to decide the question of secession, and Alexander H. Stephens was about the only prominent political leader who contended that Lincoln's election was insufficient ground for such action. On the 17th of November the legislature passed an act directing the governor to order an election of delegates on the 2nd of January 1861 and their meeting in a convention on the 16th. On the 19th this body passed an ordinance of secession by a vote of 208 to 89. Already the first regiment of Georgia Volunteers, under Colonel Alexander Lawton (1818-1896) had seized Fort Pulaski at the mouth of the Savannah river and now Governor Brown proceeded to Augusta and seized the Federal arsenal there. Toward the close of the same year, however, Federal warships blockaded Georgia's ports, and early in 1862 Federal forces captured Tybee Island, Fort Pulaski, St Mary's, Brunswick and St Simon Island. Georgia had responded freely to the call for volunteers, but when the Confederate Congress had passed, in April 1862, the Conscript Law which required all white men (except those legally exempted from service) between the ages of 18 and 35 to enter the Confederate service, Governor Brown, in a correspondence with President Davis which was continued for several months, offered serious objections, his leading contentions being that the measure was unnecessary as to Georgia, unconstitutional, subversive of the state's sovereignty, and therefore "at war with the principles for the support of which Georgia entered into this revolution."

In 1863 north-west Georgia was involved in the Chattanooga campaign. In the following spring Georgia was invaded from Tennessee by a Federal army under General William T. Sherman; the resistance of General Joseph E. Johnston and General J. B. Hood proved ineffectual; and on the 1st of September Atlanta was taken. Then Sherman began his famous "march to the sea," from Atlanta to Savannah, which revealed the weakness of the Confederacy. In the spring of 1865, General J. H. Wilson with a body of cavalry entered the state from Alabama, seized Columbus and West Point on the 16th of April, and on the 10th of May captured Jefferson Davis, president of the Confederacy, at Irwinville in Irwin county.

In accord with President Andrew Johnson's plan for reorganizing the Southern States, a provisional governor, James Johnson, was appointed on the 17th of June 1865, and a state convention reformed the constitution to meet the new conditions, rescinding the ordinance of secession, abolishing slavery and formally repudiating the state debt incurred in the prosecution of the war. A governor and legislature were elected in November 1865, the legislature ratified the Thirteenth Amendment on the 9th of December and five days later the governor-elect was inaugurated.

But both the convention and legislature incurred the suspicion and ill-will of Congress; the convention had congratulated the president on his policy, memorialized him on behalf of Jefferson Davis, and provided pensions for disabled Confederate soldiers and the widows of those who had lost their lives during the war, while the legislature passed apprenticeship, labour and vagrancy laws to protect and regulate the negroes, and rejected the Fourteenth Amendment. Although the civil rights were conferred upon the freedmen, Congress would not tolerate the political incapacity and social inferiority which the legislature had assigned to them, and therefore Georgia was placed under military government, as part of the third military district, by the Reconstruction Act of the 2nd of March 1867. Under the auspices of the military authorities registration of electors for a new state convention was begun and 95,168 negroes and 96,333 whites were registered. The acceptance of the proposition to call the convention and the election of many conscientious and intelligent delegates were largely due to the influence of ex-Governor Brown, who was strongly convinced that the wisest course for the South was to accept quickly what Congress had offered. The convention met in Atlanta on the 9th of December 1867 and by March 1868 had revised the constitution to meet the requirements of the Reconstruction Acts. The constitution was duly adopted by popular vote, and elections were held for the choice of a governor and legislature. Rufus Brown Bullock (b. 1834), Republican, was chosen governor, the Senate had a majority of Republicans, but in the House of Representatives a tie vote was cast for the election of a speaker. On the 21st of July the Fourteenth Amendment was ratified, and a section of the state constitution (which denied the power of state courts to entertain against any resident of the state suits founded on contracts existing on the 15th of June 1865) was repealed by the legislature in pursuance of the congressional "Omnibus Bill" of the 25th of June 1868, and as evidence of the restoration of Georgia to the Union the congressmen were seated on the 25th of July in that year.

But in September of the same year the Democrats in the state legislature, being assisted by some of the white Republicans, expelled the 27 negro members and seated their defeated white contestants, relying upon the legal theory that the right to hold office belonged only to those citizens designated by statute, the common law or custom. In retaliation the 41st Congress excluded the state's representatives on a technicality, and, on the theory that the government of Georgia was a provisional organization, passed an act requiring the ratification of the Fifteenth Amendment before the admission of Georgia's senators and representatives. The war department now concluded that the state was still subject to military authority, and placed General A. H. Terry in command. With his aid, and that of Congressional requirements that all members of the legislature must take the Test Oath and none be excluded on account of colour, a Republican majority was secured for both houses, and the Fifteenth Amendment was ratified. Georgia was now finally admitted to the Union by Act of Congress, on the 15th of July 1870.

The Reconstruction period in Georgia is remarkable for its comparative moderation. Although there was great political excitement, there was not as much extravagance in public administration as there was in other Southern States, the state debt increasing approximately from \$6,600,000 to \$16,000,000. The explanation lies in the fact that there were comparatively few "carpet-baggers" or adventurers in the state, and that a large number of conservative citizens, under the leadership of ex-Governor Brown, supported the Reconstruction policy of Congress and joined the Republican party.

The election of 1871 gave the Democrats a majority in the legislature; Governor Bullock, fearing impeachment, resigned, and at a special election James M. Smith was chosen to fill the unexpired term. After that the control of the Democrats was complete. In 1891 the Populist party was organized, but it never succeeded in securing a majority of the votes in the state.

LIST OF GOVERNORS

I. Administration of the Trustees.

James Edward Oglethorpe ¹	1732-1743
William Stephens ²	1743-1751
Henry Parker ³	1751-1753
Patrick Graham ⁴	1753-1754

II. Royal Administration.

John Reynolds	1754-1757
Henry Ellis	1757-1760
Sir James Wright	1760-1782

III. Provincial Administration.

William Ewen ⁵	1775
Archibald Bulloch ⁶	1776
Button Gwinnett ⁷	1777
Jonathan Bryan ⁸	1777

IV. Georgia as a State.

John A. Treutlen ⁹	1777-1778	
John Houston	1778-1779	
John Weceat ¹⁰	1779	
George Walton	1779-1780	
Richard Hawley	1780	
Stephen Heard ¹¹	1780-1781	
Myrick Davies ¹²	1781	
Nathan Brownson	1781-1782	
John Martin	1782-1783	
Lyman Hall	1783-1785	
Samuel Elbert	1785-1786	
Edward Telfair	1786-1787	
George Matthews	1787-1788	
George Handley	1788-1789	
George Walton	1789-1790	Democratic-Republican
Edward Telfair	1790-1793	"
George Matthews	1793-1796	"
Jared Irwin	1796-1798	"
James Jackson	1798-1801	"
David Emanuel	1801	"
Josiah Tattnall	1801-1802	"
John Milledge	1802-1806	"
Jared Irwin	1806-1809	"
David B. Mitchell	1809-1813	"
Peter Early	1813-1815	"
David B. Mitchell	1815-1817	"
William Rabun ¹³	1817-1819	"
Matthew Talbot ¹⁴	1819	"
John Clarke	1819-1823	"
George M. Troup	1823-1827	"
John Forsyth	1827-1829	"
George R. Gilmer	1829-1831	National Republican
Wilson Lumpkin	1831-1835	Democratic-Republican
William Schley	1835-1837	Union
George Gilmer	1837-1839	Democrat
Charles J. McDonald	1839-1843	Union
George W. Crawford	1843-1847	Whig
George W. B. Towns	1847-1851	Democrat
Howell Cobb	1851-1853	Constitutional Union
Herschell V. Johnson	1853-1856	Democrat
Joseph E. Brown	1857-1865	"
James Johnson ¹⁵	1865	"
Charles J. Jenkins	1865-1868	"
Thomas H. Ruger	1868	"
Rufus B. Bullock	1868-1871	Republican
Benjamin Conley ¹⁶	1871-1872	"
James M. Smith	1872-1876	Democrat
Alfred H. Colquitt	1876-1882	"
Alexander H. Stephens	1882-1883	"
James S. Boynton ¹⁷	1883	"
Henry D. McDaniel	1883-1886	"
John B. Gordon	1886-1890	"
W. J. Northen	1890-1894	"
W. V. Atkinson	1894-1898	"
A. D. Candler	1898-1902	"
Joseph M. Terrell	1902-1907	"
Hoke Smith	1907-1909	"
Joseph M. Brown	1909-1911	"
Hoke Smith	1911-	"

A brief bibliography, chiefly of historical materials, is given by U. B. Phillips in his monograph "Georgia and State Rights," in vol. ii. of the *Annual Report of the American Historical Association for 1907* (Washington, 1902). Valuable information concerning the resources and products of the state is given in the publications of

¹ *De facto*. ² President of the Colony. ³ President of the Council of Safety. ⁴ President of Georgia. ⁵ First Governor under a State Constitution. ⁶ President Executive Council and *de facto* Governor. ⁷ President of Senate. ⁸ Provisional.

the Department of Agriculture, which include weekly and monthly *Bulletins*, *biennial Reports* and a volume entitled *Georgia, Historical and Industrial* (Atlanta, 1901). The Reports of the United States Census (especially the Twelfth Census for 1900 and the special census of manufactures for 1905) should be consulted, and *Memoirs of Georgia* (2 vols., Atlanta, Ga., 1895) contains chapters on industrial conditions.

The principal sources for public administration are the annual reports of the state officers, philanthropic institutions, the prison commission and the railroad commission, and the revised Code of Georgia (Atlanta, 1896), adopted in 1895; see also L. F. Schmeckebier's "Taxation in Georgia" (*Johns Hopkins University Studies*, vol. xviii.) and "Banking in Georgia" (*Banker's Magazine*, vol. xlviii.). Education and social conditions are treated in C. E. Jones's *History of Education in Georgia* (Washington, 1890), the Annual Reports of the School Commissioner, and various magazine articles, such as "Georgia Cracker in the Cotton Mill" (*Century Magazine*, vol. xix.) and "A Plea for Light" (*South Atlantic Quarterly*, vol. iii.). The view of slavery given in Frances A. Kemble's *Journal of a Residence on a Georgia Plantation in 1838-1839* (New York, 1863) should be compared with R. Q. Mallard's *Plantation Life before Emancipation* (Richmond, Va., 1897), and with F. L. Olmsted's *A Journey in the Seaboard Slave States* (New York, 1856).

The best book for the entire field of Georgia history is Lawton B. Evans's *A Student's History of Georgia* (New York, 1898), a textbook for schools. This should be supplemented by C. C. Jones's *Antiquities of the Southern Indians*, particularly by the *Georgia Tribes* (New York, 1873), for the aborigines; W. B. Stevens's *History of Georgia to 1708* (2 vols., Philadelphia, 1847-1859) and C. C. Jones, jun., *History of Georgia* (2 vols., Boston, 1883), for the Colonial and Revolutionary periods; C. H.askins's *The Yazoo Land Companies* (Washington, 1891); the excellent monograph (mentioned above) by U. B. Phillips for politics prior to 1860; Miss Annie H. Abel's monograph "The History of Events Resulting in Indian Consolidation West of the Mississippi," in vol. i. of the *Annual Report of the American Historical Association for 1906* (Washington, 1908), for a good account of the removal of the Indians from Georgia; the judicious monograph by E. C. Woolley, *Reconstruction in Georgia* (New York, 1901); and I. W. Avery's *History of Georgia from 1850 to 1881* (New York, 1881), which is marred by prejudice but contains material of value. *The Confederate Records of the State of Georgia* were published at Atlanta in 1909. See also: E. J. Harden's *Life of George M. Troup* (Savannah, 1840); R. M. Johnston and W. H. Browne, *Life of Alexander H. Stephens* (Philadelphia, 1878), and Louis Pendleton, *Life of Alexander H. Stephens* (Philadelphia, 1907); P. A. Stovall's *Robert Toombs* (New York, 1892); H. Fielder's *Life, Times and Speeches of Joseph E. Brown* (Springfield, Mass., 1883) and C. C. Jones, jun., *Biographical Sketches of Delegates from Georgia to the Continental Congress* (New York, 1891). There is much valuable material, also, in the publications (beginning with 1840) of the Georgia Historical Society (see the list in vol. ii. of the *Report of the American Historical Association for 1905*).

GEORGIA, a former kingdom of Transcaucasia, which existed historically for more than 2000 years. Its earliest name was Kartli or Kartveli; the Persians knew it as Gurjistan, the Romans and Greeks as Iberia, though the latter placed Colchis also in the west of Georgia. Vrastan is the Armenian name and Gruzia the Russian. Georgia proper, which included Kartli and Kakhetia, was bounded on the N. by Ossetia and Daghestan, on the S. by the principalities of Erivan and Kars, and on the W. by Guria and Imeretia; but the kingdom also included at different times Guria, Mingrelia, Abkhazia, Imeretia and Daghestan, and extended from the Caucasus range on the N. to the Aras or Araxes on the S. It is now divided between the Russian governments of Tiflis and Kutais, under which headings further geographical particulars are given. (See also CAUCASIA.)

History.—According to traditional accounts, the Georgian (Karthlian), Kakhetian, Lesghian, Mingrelian and other races of Transcaucasia are the descendants of Thargamos, great-grandson of Japheth, son of Noah, though Gen. x. 3 makes Togarmah to be the son of Gomer, who was the son of Japheth. These various races were subsequently known under the general name of Thargamosides. Karthlos, the second son of Thargamos, is the eponymous king of his race, their country being called Karthli after him. Mtskhetos, son of Karthlos, founded the city of Mtskhetba (the modern Mtskhet) and made it the capital of his kingdom. We come, however, to firmer historic ground when we read that Georgia was conquered by Alexander the Great, or rather by one of his generals. The Macedonian yoke was shaken off by Pharnavaz or Pharnabazus, a prince of the royal race, who ruled from 302 to 237 B.C. All through its history Georgia, being on the outskirts of Armenia and Persia, both of

them more powerful neighbours than itself, was at times more or less closely affected by their destinies. In this way it was sometimes opposed to Rome, sometimes on terms of friendship with Byzantium, according as these were successively friendly or hostile to the Armenians and the Persians. In the end of the 2nd century B.C. the last Pharnavaian prince was dethroned by his own subjects and the crown given to Arsaces, king of Armenia, whose son Arshag, ascending the throne of Georgia in 93 B.C., established there the Arsacid dynasty. This close association with Armenia brought upon the country an invasion (65 B.C.) by the Roman general Pompey, who was then at war with Mithradates, king of Pontus and Armenia; but Pompey did not establish his power permanently over Iberia. A hundred and eighty years later the Emperor Trajan penetrated (A.D. 114) into the heart of the country, and chastised the Georgians; yet his conquest was only a little more permanent than Pompey's. During one of the internecine quarrels, which were not infrequent in Georgia, the throne fell to Mirhan or Mirian (265-342), a son of the Persian king, who had married a daughter of Asphagor, the last sovereign of the Arsacid dynasty.

With Mirian begins the Sassanian dynasty. He and his subjects were converted to Christianity by a nun Nuno (Nino), who had escaped from the religious persecutions of Tiridates, king of Armenia. Mirian erected the first Christian church in Georgia on the site now occupied by the cathedral of Mtskheta. In or about the year 371 Georgia was overrun by the Persian king Shapur or Sapor II., and in 379 a Persian general built the stronghold of Tphlis (afterwards Tiflis) as a counterpoise to Mtskheta. The Persian grasp upon Georgia was loosened by Tiridates, who reigned from 393 to 405. One of Mirian's successors, Vakhtang (446-499), surnamed Gurgaslan or Gurgasal, the Wolf-Lion, established a patriarchate at Mtskheta and made Tphlis his capital. This sovereign, having conquered Mingrelia and Abkhazia, and subdued the Ossetes, made himself master of a large part of Armenia. Then, co-operating for once with the king of Persia, he led an army into India; but towards the end of his reign there was enmity between him and the Persians, against whom he warred unsuccessfully. His son Dachi or Darchil (499-514) upon ascending the throne transferred the seat of government permanently from Mtskheta to Tphlis (Tiflis). Again Persia stretched out her hand over Georgia, and proved a formidable menace to the existence of the kingdom, until, owing to the severe pressure of the Turks on the one side and of the Byzantine Greeks on the other, she found it expedient to relax her grasp. The Georgians, seizing the opportunity, appealed (571) to the Byzantine emperor, Justin II. who gave them a king in the person of Guaram, a prince of the Bagratid family of Armenia, conferring upon him the title, not of king, but of viceroy. Thus began the dynasty of the Bagratids, who ruled until 1803.

This was not, however, the first time that Byzantine influence had been effectively exercised in Georgia. As early as the reign of Mirian, in the 3rd century, the organizers of the early Georgian church had looked to Byzantium, the leading Christian power in the East, for both instruction and guidance, and the connexion thus begun had been strengthened as time went on. From this period until the Arab (*i.e.* Mahomedan) invasions began, the authority of Byzantium was supreme in Georgia. Some seventy years after the Bagratids began to rule in Georgia the all-conquering Arabs appeared on the frontiers of the country, and for the next one hundred and eighty years they frequently devastated the land, compelling its inhabitants again and again to accept Islam at the sword's point. But it was not until the death of the Georgian king Ashod (787-826) that they completely subdued the Caucasian state and imposed their will upon it. Nevertheless they were too much occupied elsewhere or too indifferent to its welfare to defend it against alien aggressors, for in 842 Bogha, a Turkish chief, invaded the country, and early in the 10th century the Persians again overran it. But a period of relief from these hostile incursions was afforded by the reign of Bagrat III. (980-1014). During his father's lifetime he had been made king of Abkhazia, his mother belonging to the royal house of that land, and after ascending the Georgian throne he

made his power felt far beyond the frontiers of his hereditary dominions, until his kingdom extended from the Black Sea to the Caspian, while Armenia, Azerbaijan and Kirman all paid him tribute. Not only did he encourage learning and patronize the fine arts, but he built, in 1003, the cathedral at Kutais, one of the finest examples extant of Georgian architecture. During the reign of Bagrat IV. (1027-1072) the Seljuk Turks more than once burst, after 1048, into the country from Asia Minor, but they were on the whole successfully repulsed, although they plundered Tiflis. During the reign of the next king, George II., they again devastated Tiflis. But once more fortune changed after the accession of David II. (1089-1125), surnamed the Renovator, one of the greatest of Georgian kings. With the help of the Kipchaks, a Mongol or Turkish race, from the steppe lands to the north of the Caucasus, whom he admitted into his country, David drove the Seljuks out of his domains and forced them back over the Armenian mountains. Under George III. (1156-1184), a grandson of David II., Armenia was in part conquered, and Ani, one of its capitals, taken. George's daughter Tamar or Tamara, who succeeded him, reigned over the kingdom as left by David II. and further extended her power over Trebizond, Erzerum, Tovin (in Armenia) and Kars. These successes were continued by her son George IV. (1212-1223), who conquered Ganja (now Elisavetpol) and repulsed the attacks of the Persians; but in the last years of his reign there appeared (1220 and 1222) the people who were to prove the ruin of Georgia, namely the Mongol hosts of Jenghiz Khan, led by his sons. George IV. was succeeded by his sister Rusudan, whose capital was twice captured by the Persians and her kingdom overrun and fearfully devastated by the Mongols in 1236. Then, after a period of wonderful recovery under George V. (1318-1346), who conquered Imeretia and reunited it to his crown, Georgia was again twice (1386 and 1393-1394) desolated by the Mongols under Timur (Tamerlane), prince of Samarkand, who on the second occasion laid waste the entire country with fire and sword, and crushed it under his relentless heel until the year 1403. Alexander I. (1413-1442) freed his country from the last of the Mongols, but at the end of his reign divided his territory between his three sons, whom he made sovereigns of Imeretia, Kakhetia and Karthli (Georgia) respectively. The first mentioned remained a separate state until its annexation to Russia in 1810; the other two were soon reunited.

Political relations between Russia and Georgia began in the end of the same century, namely in 1492, when the king of Kakhetia sought the protection of Ivan III. during a war between the Turks and the Persians. In the 17th century the two states were brought into still closer relationship. In 1619, when Georgia was harried by Shah Abbas of Persia, Themuraz (1620-1634), king of Georgia, appealed for help to Michael, the first of the Romanov tsars of Russia, and his example was followed later in the century by the rulers of other petty Thargamosid or Caucasian states, namely Imeretia and Guria. In 1638 the prince of Mingrelia took the oath of allegiance to the Russian tsar, and in 1650 the same step was taken by the prince of Imeretia. Vakhtang VI. of Georgia put himself under the protection of Peter the Great early in the 18th century. When Persia fell into the grip of the Afghans early in the 18th century the Turks seized the opportunity, and, ousting the Persians from Georgia, captured Tiflis and compelled Vakhtang to abdicate. But in 1735 they renounced all claim to supremacy over the Caucasian states. This left Persia with the predominating influence, for though Peter the Great extorted from Persia (1722) her prosperous provinces beside the Caspian, he left the mountaineers to their own dynastic quarrels. Heraclius II. of Georgia declared himself the vassal of Russia in 1783, and when, twelve years later, he was hard pressed by Agha Mahommed, shah of Persia, who seized Tiflis and laid it in ruins, he appealed to Russia for help. The appeal was again renewed by the next king of Georgia, George XIII., in 1798, and in the following year he renounced his crown in favour of the tsar, and in 1801 Georgia was converted into a Russian province. The state of Guria submitted to Russia in 1829. (J. T. Bz.)

Ethnology.—Of the three main groups into which the Caucasian races are now usually divided, the Georgian is in every respect the most important and interesting. It has accordingly largely occupied the attention of Orientalists almost incessantly from the days of Klaproth. Yet such are the difficulties connected with the origin and mutual relations of the Caucasian peoples that its affinities are still far from being clearly established. Anton von Schiefner and P. V. Uslar, however, arrived at some negative conclusions valuable as starting-points for further research. In their papers, published in the *Memoirs of the St Petersburg Imperial Academy of Sciences* and elsewhere (1859 et seq.), they finally disposed of the views of Bopp and Brosset (1836), who attempted on linguistic grounds to connect the Georgians with the Indo-European family. They also clearly show that Max Müller's "Turanian" theory is untenable, and they go a long way towards proving that the Georgian, with all the other Caucasian languages except the Ossetian, forms a distinct linguistic family absolutely independent of all others. This had already been suspected by Klaproth, and the same conclusion was arrived at by Fr. Müller and Zagarelli.

Uslar's "Caucasian Family" comprises the following three great divisions:

1. Western Group. Typical races: Circassians and Abkhassians.
2. Eastern Group. Typical races: Chechens and Lezgians.
3. Southern Group. Typical race: Georgians.

Here the term "family" must be taken in a far more elastic sense than when applied, for instance, to the Indo-European, Semitic or Eastern Polynesian divisions of mankind. Indeed the three groups present at least as wide divergences as are found to exist between the Semitic and Hamitic linguistic families. Thus, while the Abkhassian of group 1 is still at the agglutinating, the Lezgian of group 2 has fairly reached the inflecting stage, and the Georgian seems still to waver between the two. In consequence of these different stages of development, Uslar hesitated finally to fix the position of Georgian in the family, regarding it as possibly a connecting link between groups 1 and 2, but possibly also radically distinct from both.

Including all its numerous ramifications, the Georgian or southern group occupies the greater part of Transcaucasia, reaching from about the neighbourhood of Batum on the Black Sea eastwards to the Caspian, and merging southwards with the Armenians of Aryan stock. It comprises altogether nine subdivisions, as in the subjoined table:

1. The **GEORGIANS PROPER**, who are the Iberians of the ancients and the Grusians of the Russians, but who call themselves Karthlians, and who in medieval times were masters of the Rion and Upper Kura as far as its confluence with the Alazan.
2. The **IMERETIANS**, west of the Suram mountains as far as the river Tskheniz-Tskhali.
3. The **GURIANS**, between the Rion and Lazistan.
4. The **LAZIS** of Lazistan on the Black Sea.
5. The **SVANETIANS, SHVANS** or **SWANIANS**, on the Upper Ingur and Tskheniz-Tskhali rivers.
6. The **MINGRELIANS**, between the rivers Tskheniz-Tskhali, Rion, Ingur and the Black Sea.
7. The **TUSHES** or **MOSOKS**
8. The **PSHAVS** or **PN'CHAVY**
9. The **KHEVSURS**

The representative branch of the race has always been the Karthlians. It is now pretty well established that the Georgians are the descendants of the aborigines of the Pambak highlands, and that they found their way to their present homes from the south-east some four or five thousand years ago, possibly under pressure from the great waves of Aryan migration flowing from the Iranian tableland westwards to Asia Minor and Europe. The Georgians proper are limited on the east by the Alazan, on the north by the Caucasus, on the west by the Meskes hills, separating them from the Imeretians, and on the south by the Kura river and Kara-dagh and Pambak mountains. Southwards, however, no hard and fast ethnical line can be drawn, for even immediately south of Tiflis, Georgians, Armenians and Tatars are found intermingled confusedly together.

The Georgian race, which represents the oldest elements of civilization in the Caucasus, is distinguished by some excellent

mental qualities, and is especially noted for personal courage and a passionate love of music. The people, however, are described as fierce and cruel, and addicted to intemperance, though Max von Thielmann (*Journey in the Caucasus, &c.*, 1875) speaks of them as "rather hard drinkers than drunkards." Physically they are a fine athletic race of pure Caucasian type; hence during the Moslem ascendancy Georgia supplied, next to Circassia, the largest number of female slaves for the Turkish harems and of recruits for the Osmanli armies, more especially for the select corps of the famous Mamelukes.

The social organization rested on a highly aristocratic basis, and the lowest classes were separated by several grades of vassalage from the highest. But since their incorporation with the Russian empire, these relations have become greatly modified, and a more sharply defined middle class of merchants, traders and artisans has been developed. The power of life and death, formerly claimed and freely exercised by the nobles over their serfs, has also been expressly abolished. The Georgians are altogether at present in a fairly well-to-do condition, and under Russian administration they have become industrious, and have made considerable moral and material progress.

Missionaries sent by Constantine the Great introduced Christianity about the beginning of the 4th century. Since that time the people have, notwithstanding severe pressure from surrounding Mahomedan communities, remained faithful to the principles of Christianity, and are still amongst the most devoted adherents of the Orthodox Greek Church. Indeed it was their attachment to the national religion that caused them to call in the aid of the Christian Muscovites against the proselytizing attempts of the Shiite Persians—a step which ultimately brought about their political extinction.

As already stated, the Karthli language is not only fundamentally distinct from the Indo-European linguistic family, but cannot be shown to possess any clearly ascertained affinities with either of the two northern Caucasian groups. It resembles them chiefly in its phonetic system, so that according to Rosen (*Sprache der Lazen*) all the languages of central and western Caucasus might be adequately rendered by the Georgian alphabet. Though certainly not so harsh as the Avar, Lezgian and other Daghestan languages, it is very far from being euphonic, and the frequent recurrence of such sounds as *ts, ds, thz, kh, khh, gh* (Arab. *غ*), *q* (Arab. *ق*), for all of which there are distinct characters, renders its articulation rather more energetic and rugged than is agreeable to ears accustomed to the softer tones of the Iranian and western Indo-European tongues. It presents great facilities for composition, the laws of which are very regular. Its peculiar morphology, standing midway between agglutination and true inflexion, is well illustrated by its simple declension common to noun, adjective and pronoun, and its more intricate verbal conjugation, with its personal endings, seven tenses and incorporation of pronominal subject and object, all showing decided progress towards the inflecting structure of the Indo-European and Semitic tongues.

Georgian is written in a native alphabet obviously based on the Armenian, and like it attributed to St Mesropius (*Mesrop*), who flourished in the 5th century. Of this alphabet there are two forms, differing so greatly in outline and even in the number of the letters that they might almost be regarded as two distinct alphabetic systems. The first and oldest, used exclusively in the Bible and liturgical works, is the square or monumental Khutsuri, i.e. "sacerdotal," consisting of 38 letters, and approaching the Armenian in appearance. The second is the *Mkhedrli khelli*, i.e. "soldier's hand," used in ordinary writing, and consisting of 40 letters, neatly shaped and full of curves, hence at first sight not unlike the modern Burmese form of the Pali.

Of the Karthli language there are several varieties; and, besides those comprised in the above table, mention should be made of the Kakhetian current in the historic province of Kakhetia. A distinction is sometimes drawn between the Karthlians proper and the Kakhetians, but it rests on a purely political basis, having originated with the partition in 1424 of the ancient Iberian

estates into the three new kingdoms of Karthlinia, Kakhetia and Imeretia. On the other hand, both the Laz of Lazistan and the Svanetian present such serious structural and verbal differences from the common type that they seem to stand rather in the relation of sister tongues than of dialects to the Georgian proper. All derive obviously from a common source, but have been developed independently of each other. The Tush or Mosok appears to be fundamentally a Kistinian or Chechen idiom affected by Georgian influences.

The Bible is said to have been translated into Georgian as early as the 5th century. The extant version, however, dates only from the 8th century, and is attributed to St Euthymius. But even so, it is far the most ancient work known to exist in the language. Next in importance is, perhaps, the curious poem entitled *The Amours of Turiel and Nesian Darejan*, or *The man clothed in the panther's skin*, attributed to Rustavel, who lived during the prosperous reign of Queen Tamar (11th century). Other noteworthy compositions are the national epics of the *Baramiani* and the *Rostomiani*, and the prose romances of *Visramiani* and *Darejaniani*, the former by Sarg of Thmogvi, the latter by Mosi of Khoni. Apart from these, the great bulk of Georgian literature consists of ecclesiastical writings, hymns sacred and profane, national codes and chronicles.

BIBLIOGRAPHY.—The standard authority on the history is M. F. Brosset's translation of the Georgian chronicles under the title of *Histoire de la Géorgie* (5 vols., St Petersburg, 1849-1858); but compare also Khakanov, *Histoire de Géorgie* (Paris, 1900). See further A. Leist, *Das georgische Volk* (Dresden, 1903); M. de Villeneuve, *La Géorgie* (Paris, 1870); O. Wardrop, *The Kingdom of Georgia* (London, 1888); and Langlois, *Namismatique géorgienne* (Paris, 1860). For the philology see Zagarelli, *Examen de la littérature relative à la grammaire géorgienne* (1873); Friedrich Müller, *Grundriss der Sprachwissenschaft* (1887), iii. 2; Leist, *Georgische Dichter* (1887); Erckert, *Sprachen des kaukasischen Stammes* (1895). For other points as to anthropology, Michel Smirnow's paper in *Revue d'anthropologie* (April 15, 1898); Chantre, *Recherches anthropologiques dans le Caucase* (1885-1887); and Erckert, *Der Kaukasus und seine Völker* (1887).

GEORGIAN BAY, the N.E. section of Lake Huron, separated from it by Manitoulin Island and the peninsula comprising the counties of Grey and Bruce, Ontario. It is about 100 m. long and 50 m. wide, and is said to contain 30,000 islands. It receives numerous rivers draining a large extent of country; of these the chief are the French river draining Lake Nipissing, the Maganatawan draining a number of small lakes, the Muskoka draining the Muskoka chain of lakes (Muskoka, Rosseau, Joseph, &c.) and the Severn draining Lake Simcoe. Into its southern extremity, known as Nottawasaga Bay, flows the river of the same name. The Trent valley canal connects Georgian Bay with the Bay of Quinte and Lake Ontario, and a canal system has long been projected to Montreal by way of the French and Ottawa rivers and Lake Nipissing.

GEORGSWALDE, a town of Bohemia, Austria, 115 m. N.E. of Prague by rail. Pop. (1900) 8731, including Neu-Georgswalde, Wiesenthal and Philippsdorf, which form together a single commune. Georgswalde is one of the oldest industrial places of Bohemia, and together with the neighbouring town of Rumburg is the principal centre of the linen industry. The village of Philippsdorf, now incorporated with Georgswalde, has become since 1866 a famous place of pilgrimage, owing to the miracles attributed to an image of the Virgin, placed now in a magnificent new church (1885).

GEPHYREA, the name used for several groups of worm-like animals with certain resemblances but of doubtful affinity. In the article "Annelida" in the 9th edition of this Encyclopaedia, W. C. McIntosh followed the accepted view in associating in this group the *Echiuridae*, *Sipunculidae* and *Priapulidae*. E. Ray Lankester, in the preface to the English translation of C. Gegenbaur's *Comparative Anatomy* (1878), added the *Phoronidae* to these forms. Afterwards the same author (article "Zoology," *Ency. Brit.*, 9th ed.) recognized that the *Phoronidae* had other affinities, and placed the other "gephyreans" in association with the *Polyzoa* as the two classes of a phylum *Podaxonia*. In the present state of knowledge the old group *Gephyrea* is broken up into *Echiuroidea* (q.v.) or *Gephyrea*

armata, which are certainly Annelids; the *Sipunculoides* (q.v.) or *Gephyrea achaeta*, an independent group, certainly coelomate, but of doubtful affinity; the *Priapuloides* (q.v.), equally of doubtful affinity; and the *Phoronidea* (q.v.), which are almost certainly *Hemichordata*.

GERA, a town of Germany, capital of the principality of Reuss-Schleiz (called also Reuss younger line), situated in a valley on the banks of the White Elster, 45 m. S.S.W. of Leipzig on the railway to Probstzella. Pop. (1885) 34,152; (1905) 47,455. It has been mostly rebuilt since a great fire in 1780, and the streets are in general wide and straight, and contain many handsome houses. There are three Evangelical churches and one Roman Catholic. Among other noteworthy buildings are the handsome town-hall (1576, afterwards restored) and the theatre (1902). Its educational establishments include a gymnasium, a commercial and a weaving school. The castle of Osterstein, the residence of the princes of Reuss, dates from the 9th century, but has been almost entirely rebuilt in modern times. Gera is noted for its industrial activity. Its industries include wool-weaving and spinning, dyeing, iron-founding, the manufacture of cotton and silk goods, machinery, sewing machines and machine oil, leather and tobacco, and printing (books and maps) and flower gardening.

Gera (in ancient chronicles *Geraka*) was raised to the rank of a town in the 11th century, at which time it belonged to the counts of Groitich. In the 12th century it came into the possession of the lords of Reuss. It was stormed and sacked by the Bohemians in 1450, was two-thirds burned down by the Swedes in 1639 during the Thirty Years' War, and suffered afterwards from great conflagrations in 1686 and 1780, being in the latter year almost completely destroyed.

GERALDTON, a town in the district of Victoria, West Australia, on Champion Bay, 306 m. by rail N.W. of Perth. Pop. (1901) 2593. It is the seat of a Roman Catholic bishop, an important seaport carrying on a considerable trade with the surrounding gold-fields and agricultural districts, the centre of a considerable railway system and an increasingly popular seaside resort. The harbour is safe and extensive, having a pier affording accommodation for large steamers. The chief exports are gold, copper, lead, wool and sandalwood.

GÉRANDO, MARIE JOSEPH DE (1772-1842), French philosopher, was born at Lyons on the 29th of February 1772. When the city was besieged in 1793 by the armies of the Republic, de Gérando took up arms, was made prisoner and with difficulty escaped with his life. He took refuge in Switzerland, whence he afterwards fled to Naples. In 1796 the establishment of the Directory allowed him to return to France. At the age of twenty-five he enlisted as a private in a cavalry regiment. About this time the Institute proposed as a subject for an essay this question,—"What is the influence of symbols on the faculty of thought?" De Gérando gained the prize, and heard of his success after the battle of Zürich, in which he had distinguished himself. This literary triumph was the first step in his upward career. In 1799 he was attached to the ministry of the interior by Lucien Bonaparte; in 1804 he became general secretary under Champagny; in 1805 he accompanied Napoleon into Italy; in 1808 he was nominated master of requests; in 1811 he received the title of councillor of state; and in the following year he was appointed governor of Catalonia. On the overthrow of the empire, de Gérando was allowed to retain this office; but having been sent during the hundred days into the department of the Moselle to organize the defence of that district, he was punished at the second Restoration by a few months of neglect. He was soon after, however, readmitted into the council of state, where he distinguished himself by the prudence and conciliatory tendency of his views. In 1819 he opened at the law-school of Paris a class of public and administrative law, which in 1822 was suppressed by government, but was reopened six years later under the Martignac ministry. In 1837 he was made a baron. He died at Paris on the 9th of November 1842.

De Gérando's best-known work is his *Histoire comparée des systèmes de philosophie relativement aux principes des connaissances humaines* (Paris, 1804, 3 vols.). The germ of this work

had already appeared in the author's *Mémoire de la génération des connaissances humaines* (Berlin, 1802), which was crowned by the Academy of Berlin. In it de Gérando, after a rapid review of ancient and modern speculations on the origin of our ideas, singles out the theory of primary ideas, which he endeavours to combat under all its forms. The latter half of the work, devoted to the analysis of the intellectual faculties, is intended to show how all human knowledge is the result of experience; and reflection is assumed as the source of our ideas of substance, of unity and of Identity. It is divided into two parts, the first of which is purely historical, and devoted to an exposition of various philosophical systems; in the second, which comprises fourteen chapters of the entire work, the distinctive characters and value of these systems are compared and discussed. In spite of the disadvantage that it is impossible to separate advantageously the history and critical examination of any doctrine in the arbitrary manner which de Gérando chose, the work has great merits. In correctness of detail and comprehensiveness of view it was greatly superior to every work of the same kind that had hitherto appeared in France. During the Empire and the first years of the Restoration, de Gérando found time to prepare a second edition (Paris, 1822, 4 vols.), which is enriched with so many additions that it may pass for an entirely new work. The last chapter of the part published during the author's lifetime ends with the revival of letters and the philosophy of the 15th century. The second part, carrying the work down to the close of the 18th century, was published posthumously by his son in 4 vols. (Paris, 1847). Twenty-three chapters of this were left complete by the author in manuscript; the remaining three were supplied from other sources, chiefly printed but unpublished memoirs.

His essay *Du perfectionnement moral et de l'éducation de soi-même* was crowned by the French Academy in 1825. The fundamental idea of this work is that human life is in reality only a great education, of which perfection is the aim.

Besides the works already mentioned, de Gérando left many others, of which we may indicate the following:—*Considérations sur diverses méthodes d'observation des peuples sauvages* (Paris, 1801); *Éloge de Dumarsais,—discours qui a remporté le prix proposé par la seconde classe de l'Institut National* (Paris, 1805); *Le Visiteur de paxore* (Paris, 1820); *Instituts du droit administratif* (4 vols., Paris, 1830); *Cours normal des instituteurs primaires ou directions relatives à l'éducation physique, morale, et intellectuelle dans les écoles primaires* (Paris, 1832); *De l'éducation des sourds-muets* (2 vols., Paris, 1832); *De la bienfaisance publique* (4 vols., 1838). A detailed analysis of the *Histoire comparée des systèmes* will be found in the *Fragments philosophiques* of M. Cousin. In connexion with his psychological studies, it is interesting that in 1884 the French Anthropological Society reproduced his instructions for the observation of primitive peoples, and modern students of the beginnings of speech in children and the cases of deaf-mutes have found useful matter in his works. See also J. P. Damiron, *Essai sur la philosophie en France au XIX^e siècle*.

GERANIACEAE, in botany, a small but very widely distributed natural order of Dicotyledons belonging to the subclass Polypetalae, containing about 360 species in 11 genera. It is represented in Britain by two genera, *Geranium* (crane's-bill) and *Erodium* (stork's-bill), to which belong nearly two-thirds of the total number of species. The plants are mostly herbs, rarely becoming shrubby, with generally simple glandular hairs on the stem and leaves. The opposite or alternate leaves have a pair of small stipules at the base of the stalk and a palm-nerve blade. The flowers, which are generally arranged in a cymose inflorescence, are hermaphrodite, hypogynous, and, except in *Polygonium* regular. The parts are arranged in fives. There are five free sepals, overlapping in the bud, and, alternating with these, five free petals. In *Polygonium* the flower is zygomorphic with a spurred posterior sepal and the petals differing in size or shape. In *Geranium* the stamens are obdiplostemonous, i.e. an outer whorl of five opposite the petals alternates with an inner whorl of five opposite the sepals; at the base of each of the antiseptalous stamens is a honey-gland. In *Erodium* the members of the outer whorl are reduced to scale-like structures (staminodes), and in *Polygonium* from two to seven only are fertile. There is no satisfactory explanation of this break in

the regular alternation of successive whorls; the outer whorl of stamens arises in course of development before the inner, so that there is no question of subsequent displacement. There are five, or sometimes fewer, carpels, which unite to form an ovary with as many chambers, in each of which are one or two, rarely more, pendulous anatropous ovules, attached to the central column in such a way that the micropyle points outwards and the raphe is turned towards the placenta. The long beak-like style divides at the top into a corresponding number of slender stigmas.

The larger-flowered species of *Geranium* are markedly protandrous, the outer stamens, inner stamens and stigmas becoming functional in succession. For instance, in meadow crane's-bill, *G. pratense*, each whorl of stamens ripens in turn, becoming erect and shedding their pollen; as the anthers wither the filaments bend outwards, and when all the anthers have diverged the stigmas become mature and ready for pollination. By this



Meadow Crane's-bill, *Geranium pratense* (After Curtis, *Flora Londinensis*.)

1, Flower after removal of petals. 2, Fruit after splitting. 3, Floral diagram, the dots opposite the inner stamens represent honey-glands.

arrangement self-pollination is prevented and cross-pollination ensured by the visits of bees which come for the honey secreted by the glands at the base of the inner stamens.

In species with smaller and less conspicuous flowers, such as *G. molle*, the flowers of which are only $\frac{1}{4}$ to $\frac{1}{2}$ in. in diameter, self-pollination is rendered possible, since the divisions of the stigma begin to separate before the outer stamens have shed all their pollen; the nearness of the stigmas to the dehiscing anthers favours self-pollination.

In the ripe fruit the carpels separate into five one-seeded portions (*cocci*), which break away from the central column, either rolling elastically outwards and upwards or becoming spirally twisted. In most species of *Geranium* the cocci split open on the inside and the seeds are shot out by the elastic up-twisting (fig. 1); in *Erodium* and *Polygonium* each coccus remains closed, and the long twisted upper portion separates from the central column, forming an awn, the distribution of which is favoured by the presence of bristles or hairs. The embryo generally fills the seed, and the cotyledons are rolled or folded on each other.

Geranium is the most widely distributed genus; it has 160 species and is spread over all temperate regions with a few species in the tropics. Three British species—*G. sylvaticum*, *G. pratense* and *G. Robertianum* (herb-Robert)—reach the arctic zone, while *G. patagonicum* and *G. magellanicum* are found in the antarctic. *Erodium* contains 50 species (three are British), most of which are confined to the Mediterranean region and west Asia, though others occur in America, in South Africa and West Australia. *Pelargonium*, with 175 species, has its centre in South Africa, the well-known garden and greenhouse "geraniums" are species of *Pelargonium* (see GERANIUM).

GERANIUM, the name of a genus of plants, which is taken by botanists as the type of the natural order Geraniaceae. The name, as a scientific appellation, has a much more restricted application than when taken in its popular sense. Formerly the genus *Geranium* was almost coterminous with the order Geraniaceae. Then as now the geranium was very popular as a garden plant, and the species included in the original genus became widely known under that name, which has more or less clung to them ever since, in spite of scientific changes which have removed the larger number of them to the genus *Pelargonium*. This result has been probably brought about in some degree by an error of the nurserymen, who seem in many cases to have acted on the conclusion that the group commonly known as *Scarlet Geraniums* were really geraniums and not pelargoniums, and were in consequence inserted under the former name in their trade catalogues. In fact it may be said that, from a popular point of view, the pelargoniums of the botanist are still better known as geraniums than are the geraniums themselves, but the term "zonal Pelargonium" is gradually making its way amongst the masses.

The species of *Geranium* consist mostly of herbs, of annual or perennial duration, dispersed throughout the temperate regions of the world. They number about 160, and bear a considerable family resemblance. The leaves are for the most part palmately-lobed, and the flowers are regular, consisting of five sepals, five imbricating petals, alternating with five glandules at their base, ten stamens and a beaked ovary. Eleven species are natives of the British Isles and are popularly known as crane's-bill. *G. Robertianum* is herb-Robert, a common plant in hedgebanks. *G. sanguineum*, with flowers a deep rose colour, is often grown in borders, as are also the double-flowered varieties of *G. pratense*. Many others of exotic origin form handsome border plants in our gardens of hardy perennials; amongst these *G. arvense*, *G. Endressii*, *G. ibericum* and its variety *platypetalum* are conspicuous.

From these regular-flowered herbs, with which they had been mixed up by the earlier botanists, the French botanist L'Heritier in 1787 separated those plants which have since borne the name of *Pelargonium*, and which, though agreeing with them in certain points of structure, differ in others which are admitted to be of generic value. One obvious distinction of *Pelargonium* is that the flowers are irregular, the two petals which stand uppermost being different—larger, smaller or differently marked—from the other three, which latter are occasionally wanting. This difference of irregularity the modern florist has done very much to annul, for the increased size given to the flowers by high breeding has usually been accompanied by the enlargement of the smaller petals, so that a very near approach to regularity has been in some cases attained. Another well-marked difference, however, remains in *Pelargonium*: the back or dorsal sepal has a hollow spur, which spur is adnate, i.e. joined for its whole length with the flower-stalk; while in *Geranium* there is no spur. This peculiarity is best seen by cutting clean through the flower-stalk just behind the flower, when in *Pelargonium* there will be seen the hollow tube of the spur, which in the case of *Geranium* will not be found, but the stalk will appear as a solid mass. There are other characters which support those already pointed out, such as the absence of the glandules, and the declination of the stamens; but the features already described offer the most ready and obvious distinctions.

To recapitulate, the geraniums properly so-called are regular-flowered herbs with the flower-stalks solid, while many geraniums falsely so-called in popular language are really pelargoniums, and may be distinguished by their irregular flowers and hollow flower-stalks. In a great majority of cases too, the pelargoniums so commonly met with in greenhouses and summer parterres are of shrubby or sub-shrubby habit.

The various races of pelargoniums have sprung from the intermixture of some of the species obtained from the Cape. The older show-flowered varieties have been gradually acquired through a long series of years. The fancy varieties, as well as the French spotted varieties and the market type, have been evolved from them. The zonal or bedding race, on the other hand, has been more recently perfected; they are supposed to have arisen from hybrids between *Pelargonium inquinans* and *P. zonale*. In all the sections the varieties are of a highly ornamental character, but for general cultivation the market type is preferable for indoor purposes, while the zonals are effective either in the greenhouse or flower garden. Some of the Cape species are still in cultivation—the leaves of many of them being beautifully subdivided, almost fern-like in character, and some of them are deliciously scented; *P. quercifolium* is the oak-leaf geranium. The ivy-leaf geranium, derived from *P. peltatum*, has given rise to an important class of both double- and single-flowered forms adapted especially for pot culture, hanging baskets, window boxes and the greenhouse. Of late years the ivy-leaf "geraniums" have been crossed with the "zonals," and a new race is being gradually evolved from these two distinct groups.

The best soil for pelargoniums is a mellow fibrous loam with good well-rotted stable manure or leaf-mould in about the proportion of one-fifth; when used it should not be sifted, but pulled to pieces by the hand, and as much sand should be added as will allow the water to pass freely through it. The large-flowered and fancy kinds cannot bear so much water as most soft-wooded plants, and the latter should have a rather lighter soil.

All the pelargoniums are readily increased by cuttings made from the shoots when the plants are headed down after flowering, or in the spring, when they will root freely in a temperature of 65° to 70°. They must not be kept too close, and must be very moderately watered. When rooted they may be moved into well-drained 3-in. pots, and when from 6 to 8 in. high, should have the points pinched out in order to induce them to push out several shoots nearer the base. These shoots are, when long enough, to be trained in a horizontal direction; and when they have made three joints they should have the points again pinched out. These early-struck plants will be ready for shifting into 6-in. pots by the autumn, and should still be trained outwards. The show varieties after flowering should be set out of doors in a sunny spot to ripen their wood, and should only get water enough to keep them from flagging. In the course of two or three weeks they will be ready to cut back within two joints of where these were last stopped, when they should be placed in a frame or pit, and kept close and dry until they have broken. When they have pushed an inch or so, turn them out of their pots, shake off the old soil, trim the straggling roots, and replot them firmly in smaller pots if practicable; keep them near the light, and as the shoots grow continue to train them outwardly. They require to be kept in a light house, and to be set well up to the glass; the night temperature should range about 45°; and air should be given on all mild days, but no cold currents allowed, nor more water than is necessary to keep the soil from getting parched. The young shoots should be topped about the end of October, and when they have grown an inch or two beyond this, they may be shifted into 7-in. pots for flowering. The shoots must be kept tied out so as to be fully exposed to the light. If required to flower early they should not be stopped again; if not until June they may be stopped in February.

The zonal varieties, which are almost continuous bloomers, are of much value as decorative subjects; they seldom require much pruning after the first stopping. For winter flowering,

young plants should be raised from cuttings about March, and grown on during the summer, but should not be allowed to flower. When blossoms are required, they should be placed close up to the glass in a light house with a temperature of 65°, only just as much water being given as will keep them growing. For bedding purposes the zonal varieties are best struck towards the middle of August in the open air, taken up and potted or planted in boxes as soon as struck, and preserved in frames or in the greenhouse during winter.

The fancy varieties root best early in spring from the half-ripened shoots; they are slower growers, and rather more delicate in constitution than the zonal varieties, and very impatient of excess of water at the root.

GERARD (d. 1108), archbishop of York under Henry I., began his career as a chancery clerk in the service of William Rufus. He was one of the two royal envoys who, in 1095, persuaded Urban II. to send a legate and Anselm's pallium to England. Although the legate disappointed the king's expectations, Gerard was rewarded for his services with the see of Hereford (1096). On the death of Rufus he at once declared for Henry I., by whom he was nominated to the see of York. He made difficulties when required to give Anselm the usual profession of obedience; and it was perhaps to assert the importance of his see that he took the king's side on the question of investitures. He pleaded Henry's cause at Rome with great ability, and claimed that he had obtained a promise, on the pope's part, to condone the existing practice of lay investiture. But this statement was contradicted by Paschal, and Gerard incurred the suspicion of perjury. About 1103 he wrote or inspired a series of tracts which defended the king's prerogative and attacked the oecumenical pretensions of the papacy with great freedom of language. He changed sides in 1105, becoming a staunch friend and supporter of Anselm. Gerard was a man of considerable learning and ability; but the chroniclers accuse him of being lax in his morals, an astrologer and a worshipper of the devil.

See the *Tractatus Eboracenses* edited by H. Boehmer in *Libelli de lite Sacerdotii et Imperii*, vol. iii. (in the *Monumenta hist. Germaniae*, quarto series), and the same author's *Kirche und Staat in England und in der Normandie* (Leipzig, 1899). (H. W. C. D.)

GERARD (c. 1040-1120), variously surnamed **TUM, TUNC, TENQUE** or **THOM**, founder of the order of the knights of St John of Jerusalem (*q.v.*), was born at Amalfi about the year 1040. According to other accounts Martigues in Provence was his birthplace, while one authority even names the Château d'Avesnes in Hainaut. Either as a soldier or a merchant, he found his way to Jerusalem, where a hospice had for some time existed for the convenience of those who wished to visit the holy places. Of this institution Gerard became guardian or provost at a date not later than 1100; and here he organized that religious order of St John which received papal recognition from Paschal II. in 1113, by a bull which was renewed and confirmed by Calixtus II. shortly before the death of Gerard in 1120.

GERARD OF CREMONA (c. 1114-1187), the medieval translator of Ptolemy's *Astronomy*, was born at Cremona, Lombardy, in or about 1114. Dissatisfied with the meagre philosophies of his Italian teachers, he went to Toledo to study in Spanish Moslem schools, then so famous as depositories and interpreters of ancient wisdom; and, having thus acquired a knowledge of the Arabic language, he appears to have devoted the remainder of his life to the business of making Latin translations from its literature. The date of his return to his native town is uncertain, but he is known to have died there in 1187. His most celebrated work is the Latin version by which alone Ptolemy's *Almagest* was known to Europe until the discovery of the original *Μεγάλη Σύνταξις*. In addition to this, he translated various other treatises, to the number, it is said, of sixty-six; among these were the *Tables of "Arzakhel,"* or Al Zarkala of Toledo, Al Farabi *On the Sciences (De scientiis)*, Euclid's *Geometry*, Al Farghani's *Elements of Astronomy*, and treatises on algebra, arithmetic and astrology. In the last-named latitudes are reckoned from Cremona and Toledo. Some of the works, however, with which he has been credited (including the *Theoria*

or *Theorica planetarum*, and the versions of Avicenna's *Canon of Medicine*—the basis of the numerous subsequent Latin editions of that well-known work—and of the *Almansorius* of Abu Bakr Razi) are probably due to a later Gerard, of the 13th century, also called Cremonensis but more precisely de Sabbioneta (Sabbionetta). This writer undertook the task of interpreting to the Latin world some of the best work of Arabic physicians, and his translation of Avicenna is said to have been made by order of the emperor Frederic II.

See Pipini, "Cronica," in Muratori, *Script. rer. Ital.* vol. ix.; Nicol. Antonio, *Bibliotheca Hispana vetus*, vol. ii.; Tiraboschi, *Storia della letteratura Italiana*, vols. iii. (333) and iv.; Arisi, *Cremona literata*; Jourdain, *Recherches sur . . . l'origine des traductions latines d'Aristote*; Charles, *Aperçu historique des méthodes en géométrie*, and in *Comptes rendus de l'Académie des Sciences*, vol. xiii. p. 506; J. T. Reinaud, *Géographie d'Aboulféda*, introduction, vol. i. pp. ccxvii-ccxlviii.; Boncompagni, *Della vita e delle opere di Gherardo Cremonese e di Gherardo da Sabbioneta* (Rome, 1851). Much of the work of both the Gerards remains in manuscript, as in Paris, National Library, MSS. Lat. 7400, 7421; MSS. Suppl. Lat. 49; Rome, Vatican library, 4083, and Ottobon, 1826; Oxford, Bodleian library, Digby, 47, 61. The Vatican MS. 2392 is stated to contain an eulogy of "Gerard of Cremona" and a list of "his" translations, apparently confusing the two scholars. The former's most valuable work was in astronomy; the latter's in medicine. (C. R. B.)

GERARD, ÉTIENNE MAURICE, COUNT (1773-1852), French general, was born at Damvilliers (Meuse), on the 4th of April 1773. He joined a battalion of volunteers in 1791, and served in the campaigns of 1792-1793 under Generals Dumouriez and Jourdan. In 1795 he accompanied Bernadotte as aide-de-camp. In 1799 he was promoted *chef d'escadron*, and in 1800 colonel. He distinguished himself at the battles of Austerlitz and Jena, and was made general of brigade in November 1806, and for his conduct in the battle of Wagram he was created a baron. In the Spanish campaign of 1810 and 1811 he gained special distinction at the battle of Fuentes d'Onor; and in the expedition to Russia he was present at Smolensk and Valutina, and displayed such bravery and ability in the battle of Borodino that he was made general of division. He won further distinction in the disastrous retreat from Moscow. In the campaign of 1813, in command of a division, he took part in the battles of Lützen and Bautzen and the operations of Marshal Macdonald, and at the battle of Leipzig (in which he commanded the XI. corps) he was dangerously wounded. After the battle of Bautzen he was created by Napoleon a count of the empire. In the campaign of France of 1814, and especially at La Rothière and Montereau, he won still greater distinction. After the first restoration he was named by Louis XVIII. grand cross of the Legion of Honour and chevalier of St Louis. In the Hundred Days Napoleon made Gérard a peer of France and placed him in command of the IV. corps of the Army of the North. In this capacity Gérard took a brilliant part in the battle of Ligny (see **WATERLOO CAMPAIGN**), and on the morning of the 18th of June he was foremost in advising Marshal Grouchy to march to the sound of the guns. Gérard retired to Brussels after the fall of Napoleon, and did not return to France till 1817. He sat as a member of the chamber of deputies in 1822-1824, and was re-elected in 1827. He took part in the revolution of 1830, after which he was appointed minister of war and named a marshal of France. On account of his health he resigned the office of war minister in the October following, but in 1831 he took the command of the northern army, and was successful in thirteen days in driving the army of Holland out of Belgium. In 1832 he commanded the besieging army in the famous scientific siege of the citadel of Antwerp. He was again chosen war minister in July 1834, but resigned in the October following. In 1836 he was named grand chancellor of the Legion of Honour in succession to Marshal Mortier, and in 1838 commander of the National Guards of the Seine, an office which he held till 1842. He became a senator under the empire in 1852, and died on the 17th of April in the same year.

GERARD, FRANÇOIS, BARON (1770-1837), French painter, was born on the 4th of May 1770, at Rome, where his father occupied a post in the house of the French ambassador. At the age of twelve Gérard obtained admission into the Pension du Roi at Paris. From the Pension he passed to the studio of

Pajou (sculptor), which he left at the end of two years for that of the painter Brenet, whom he quitted almost immediately to place himself under David. In 1789 he competed for the Prix de Rome, which was carried off by his comrade Girodet. In the following year (1790) he again presented himself, but the death of his father prevented the completion of his work, and obliged him to accompany his mother to Rome. In 1791 he returned to Paris; but his poverty was so great that he was forced to forgo his studies in favour of employment which should bring in immediate profit. David at once availed himself of his help, and one of that master's most celebrated pictures—*Le Pelletier de St Fargeau*—may owe much to the hand of Gérard. This painting was executed early in 1793, the year in which Gérard, at the request of David, was named a member of the revolutionary tribunal, from the fatal decisions of which he, however, invariably absented himself. In 1794 he obtained the first prize in a competition, the subject of which was "The Tenth of August," and, further stimulated by the successes of his rival and friend Girodet in the Salons of 1793 and 1794, Gérard (nobly aided by Isabey the miniaturist) produced in 1795 his famous "Bélisaire." In 1796 a portrait of his generous friend (in the Louvre) obtained undisputed success, and the money received from Isabey for these two works enabled Gérard to execute in 1797 his "Psyché et l'Amour." At last, in 1799, his portrait of Madame Bonaparte established his position as one of the first portrait-painters of the day. In 1808 as many as eight, in 1810 no less than fourteen portraits by him, were exhibited at the Salon, and these figures afford only an indication of the enormous numbers which he executed yearly; all the leading figures of the empire and of the restoration, all the most celebrated men and women of Europe, sat to Gérard. This extraordinary vogue was due partly to the charm of his manner and conversation, for his *salon* was as much frequented as his studio; Madame de Staël, Canning, Talleyrand, the duke of Wellington, have all borne witness to the attraction of his society. Rich and famous, Gérard was stung by remorse for earlier ambitions abandoned; at intervals he had indeed striven to prove his strength with Girodet and other rivals, and his "Bataille d'Austerlitz" (1810) showed a breadth of invention and style which are even more conspicuous in "L'Entrée d'Henri IV" (Versailles)—the work with which in 1817 he did homage to the Bourbons. After this date Gérard declined, watching with impotent grief the progress of the Romantic school. Loaded with honours—baron of the empire, member of the Institute, officer of the legion of honour, first painter to the king—he worked on sad and discouraged; the revolution of 1830 added to his disquiet; and on the 11th of January 1837, after three days of fever, he died. By his portraits Gérard is best remembered; the colour of his paintings has suffered, but his drawings show in uninjured delicacy the purity of his line; and those of women are specially remarkable for a virginal simplicity and frankness of expression.

M. Ch. Lenormant published in 1846 *Essai de biographie et de critique sur François Gérard*, a second edition of which appeared in 1847; and M. Delécluz devoted several pages to the same subject in his work *Louis David, son école et son temps*.

GÉRARD, JEAN IGNACE ISIDORE (1803-1847), French caricaturist, generally known by the pseudonym of Grandville—the professional name of his grandparents, who were actors—was born at Nancy on the 13th of September 1803. He received his first instruction in drawing from his father, a miniature painter, and at the age of twenty-one came to Paris, where he soon afterwards published a collection of lithographs entitled *Les Tribulations de la petite propriété*. He followed this by *Les Plaisirs de toutage* and *La Sibylle des salons*; but the work which first established his fame was *Métamorphoses du jour*, published in 1828, a series of seventy scenes in which individuals with the bodies of men and faces of animals are made to play a human comedy. These drawings are remarkable for the extraordinary skill with which human characteristics are represented in animal features. The success of this work led to his being engaged as artistic contributor to various periodicals, such as *La Silhouette*, *L'Artiste*, *La Caricature*, *Le Charivari*; and his political caricatures, which were characterized by marvellous fertility of

satirical humour, soon came to enjoy a general popularity. Besides supplying illustrations for various standard works, such as the songs of Béranger, the fables of La Fontaine, *Don Quixote*, *Gulliver's Travels*, *Robinson Crusoe*, he also continued the issue of various lithographic collections, among which may be mentioned *La Vie privée et publique des animaux*, *Les Cent Proverbes*, *L'Autre Monde* and *Les Fleurs unimées*. Though the designs of Gérard are occasionally unnatural and absurd, they usually display keen analysis of character and marvellous inventive ingenuity, and his humour is always tempered and refined by delicacy of sentiment and a vein of sober thoughtfulness. He died of mental disease on the 17th of March 1847.

A short notice of Gérard, under the name of Grandville, is contained in Théophile Gautier's *Portraits contemporains*. See also Charles Blanc, *Grandville* (Paris, 1855).

GERARD, JOHN (1545-1612), English herbalist and surgeon, was born towards the end of 1545 at Nantwich in Cheshire. He was educated at Wisterton, or Willaston, 2 m. from Nantwich, and eventually, after spending some time in travelling, took up his abode in London, where he exercised his profession. For more than twenty years he also acted as superintendent of the gardens in London and at Theobalds, in Hertfordshire, of William Cecil, Lord Burghley. In 1596 he published a catalogue of plants cultivated in his own garden in Holborn, London, 1039 in number, inclusive of varieties of the same species. Their English as well as their Latin names are given in a revised edition of the catalogue issued in 1590. In 1597 appeared Gerard's well-known *Herball*, described by him in its preface as "the first fruits of these mine own labours," but more truly an adaptation of the *Stirpium historiae pemptades* of Rembert Dodoens (1518-1585), published in 1583, or rather of a translation of the whole or part of the same by Dr Priest, with M. Lobel's arrangement. Of the numerous illustrations of the *Herball* sixteen appear to be original, the remainder are mostly impressions from the wood blocks employed by Jacob Theodorus Tabernaemontanus in his *Icones stirpium*, published at Frankfort in 1590. A second edition of the *Herball*, with considerable improvements and additions, was brought out by Thomas Johnson in 1633, and reprinted in 1636. Gerard was elected a member of the court of assistants of the barber-surgeons in 1595, by which company he was appointed an examiner in 1598, junior warden in 1605, and master in 1608. He died in February 1612, and was buried at St Andrews, Holborn.

See Johnson's preface to his edition of the *Herball*; and *A Catalogue of Plants cultivated in the Garden of John Gerard in the years 1596-1599*, edited with Notes, References to Gerard's *Herball*, the *Addition of modern Names*, and a *Life of the Author*, by Benjamin Daydon Jackson, *F.L.S.*, privately printed (London, 1876, 4to).

GÉRARDMER, a town of north-eastern France, in the department of Vosges, 33 m. E.S.E. of Epinal by rail. Pop. (1906) of the town, 3993; of the commune, 10,041. Gérardmer is beautifully situated at a height of 2200 ft. at the eastern end of the small Lake of Gérardmer (285 acres in extent) among forest-clad mountains. It is the chief summer-resort of the French Vosges and is a centre for excursions, among which may be mentioned those to the Hönneck (4481 ft.), the second highest summit in the Vosges, the Schlucht, the mountain pass from France to Germany, and, nearer the town, the picturesque defile of Granges, watered by the Vologne, which at one point forms the cascade known as the Saut des Cuves. The town itself, in which the chief object of interest is the huge lime-tree in the market-place, carries on cloth-weaving, bleaching, wood-sawing and the manufacture of wooden goods; there is trade in the cheeses (*grômes*) manufactured in the neighbourhood. Gérardmer is said to owe its name to Gerard of Alsace, 1st duke of Lorraine, who in the 11th century built a tower on the bank of the lake or *mer*, near which, in 1285, a new town was founded.

GERASA (mod. *Gerash* or *Jerash*), a city of Palestine, and a member of the league known as the Decapolis (*q.v.*), situated amid the mountains of Gilead, about 1757 ft. above the sea, 30 m. from the Jordan and 21 m. N. of Philadelphia. Of its origin nothing is known; it has been suggested that it represents the biblical Ramoth Gilead. From Josephus we learn that it

was captured by Alexander Jannæus (c. 83 B.C.), rebuilt by the Romans (c. A.D. 65), burned by the Jews in revenge for the massacre at Caesarea, and again plundered and depopulated by Annius, the general of Vespasian; but, in spite of these disasters, it was still in the 2nd and 3rd centuries of the Christian era one of the wealthiest and most flourishing cities of Palestine. It was a centre of Greek civilization, devoted especially to the worship of Artemis, and producing famous teachers, of whom Stephen the Byzantine mentions Ariston, Kerykos and Plato. As late as 1121 the soldiers of Baldwin II. found it defended by a castle built by a king of Damascus; but at the beginning of the following century the Arabian geographer Yaquf speaks of it as deserted and overthrown. The ruins of Jerash, discovered about 1806, and since then frequently visited and described, still attest the splendour of the Roman city. They are distributed along both banks of the Kerwan, a brook which flows south through the Wadi-ed-Dêr to join the Zerka or Jabbok; but all the principal buildings are situated on the level ground to the right of the stream. The town walls, which can still be traced and indeed are partly standing, had a circuit of not more than 2 m., and the main street was less than half a mile in length; but remains of buildings on the road for fully a mile beyond the south gate, show that the town had outgrown the limit of its fortifications. The most striking feature of the ruins is the profusion of columns, no fewer than 230 being even now in position; the main street is a continuous colonnade, a large part of which is still entire, and it terminates to the south in a forum of similar formation. Among the public buildings still recognizable are a theatre capable of accommodating 6000 spectators, a naumachia (circus for naval combats) and several temples, of which the largest was probably the grandest structure in the city, possessing a portico of Corinthian pillars 38 ft. high. The desolation of the city is probably due to earthquake; and the absence of Moslem erections or restorations seems to show that the disaster took place before the Mahomedan period.

The town is now occupied by a colony of Circassians, whose houses have been built with materials from the earlier buildings, and there has been much destruction of the interesting ruins. "The country of the Geraseses" (Matt. viii. 28 and parallels; other readings, Gadarenes, Gergesenes) must be looked for in another quarter—on the E. coast of the Sea of Galilee, probably in the neighbourhood of the modern Khersa (C. W. Wilson in *Recovery of Jerusalem*, p. 369). (R. A. S. M.)

GÉRAULT-RICHARD, ALFRED LÉON (1860—), French journalist and politician, was born at Bonnetable in the department of Sarthe, of a peasant family. He began life as a working upholsterer, first at Mans, then at Paris (1880), where his peasant and socialist songs soon won him fame in the Montmartre quarter. Lissagaray, the communist, offered him a position on *La Bataille*, and he became a regular contributor to the advanced journals, especially to *La Petite République*, of which he became editor-in-chief in 1897. In 1893 he founded *Le Chambard*, and was imprisoned for a year (1894) on account of a personal attack upon the president, Casimir-Périer. In January 1895 he was elected to the chamber as a Socialist for the thirteenth arrondissement of Paris. He was defeated at the elections of 1898 at Paris, but was re-elected in 1902 and in 1906 by the colony of Guadeloupe.

GERBER, ERNST LUDWIG (1746–1810), German musician, author of a famous dictionary of musicians, was born at Sondershausen in the principality of Schwarzburg-Sondershausen on the 20th of September 1746. His father, Henry Nicolas Gerber (1702–1775), a pupil of J. S. Bach, was an organist and composer of some distinction, and under his direction Ernst Ludwig at an early age had made great progress in his musical studies. In 1765 he went to Leipzig to study law, but the claims of music, which had gained additional strength from his acquaintanceship with J. A. Hiller, soon came to occupy almost his sole attention. On his return to Sondershausen he was appointed music teacher to the children of the prince, and in 1775 he succeeded his father as court organist. Afterwards he devoted much of his time to the study of the literature and history of music, and with this

view he made himself master of several modern languages. His *Historisch-biographisches Lexikon der Tonkünstler* appeared in 1790 and 1792 in two volumes; and the first volume of what was virtually an improved and corrected edition of this work was published in 1810 under the title *Neues historisch-biographisches Lexikon der Tonkünstler*, followed by other three volumes in 1812, 1813 and 1814. Gerber also contributed a number of papers to musical periodicals, and published several minor musical compositions. He died at Sondershausen on the 30th of June 1810.

GERBERON, GABRIEL (1628–1711), French Jansenist monk, was born on the 12th of August 1628 at St Calais, in the department of Sarthe. At the age of twenty he took the vows of the Benedictine order at the abbey of Ste Melaine, Rennes, and afterwards taught rhetoric and philosophy in several monasteries. His open advocacy of Jansenist opinions, however, caused his superiors to relegate him to the most obscure houses of the order, and finally to keep him under surveillance at the abbey of St Germain-des-Prés at Paris. Here he wrote a defence of the doctrine of the Real Presence against the Calvinists in the form of an apology for Rupert, abbot of Deutz (*Apologia pro Ruperto abbate Tuitensi*, Paris, 1660). In 1676 he published at Brussels, under the name of "Sieur Flore de Ste Foi" his *Miroir de la piété chrétienne*, an enlarged edition of which appeared at Liège in the following year. This was condemned by certain archbishops and theologians as the repetition of the five condemned propositions of Jansen, and Gerberon defended it, under the name of "Abbé Valentin" in *Le Miroir sans tache* (Paris, 1680). He had by this time aroused against him the full fury of the Jesuits, and at their instigation a royal provost was sent to Corbie to arrest him. He had, however, just time to escape, and fled to the Low Countries, where he lived in various towns. He was invited by the Jansenist clergy to Holland, where he wrote another controversial work against the Protestants: *Défense de l'Eglise Romaine contre la calomnie des Protestants* (Cologne, 1688–1691). This produced unpleasantness with the Reformed clergy, and feeling himself no longer safe he returned to Brussels. In 1700 he published his history of Jansenism (*Histoire générale du Jansénisme*), a dry work, by which, however, he is best remembered. He adhered firmly to the Augustinian doctrine of Predestination, and on the 30th of May 1703 he was arrested at Brussels at the instance of the archbishop of Malines, and ordered to subscribe the condemnation of the five sentences of Jansen. On his refusal, he was handed over to his superiors and imprisoned in the citadel of Amiens and afterwards at Vincennes. Every sort of pressure was brought to bear upon him to make his submission, and at last, broken in health and spirit, he consented to sign a formula which the cardinal de Noailles claimed as a recantation. Upon this he was released in 1710. The first use he made of his freedom was to write a work (which, however, his friends prudently prevented him from publishing), *Le Vaine Triomphe du cardinal de Noailles*, containing a virtual withdrawal of the compulsory recantation. He died at the abbey of St Denis on the 20th of March 1711.

GERBERT, MARTIN (1720–1793), German theologian, historian and writer on music, belonged to the noble family of Gerbert von Hornau, and was born at Horb on the Neckar, Württemberg, on the 12th (or 11th or 13th) of August 1720. He was educated at Freiburg in the Breisgau, at Klingenuan in Switzerland and at the Benedictine abbey of St Blasien in the Black Forest, where in 1737 he took the vows. In 1744 he was ordained priest, and immediately afterwards appointed professor, first of philosophy and later of theology. Between 1754 and 1764 he published a series of theological treatises, their main tendency being to modify the rigid scholastic system by an appeal to the Fathers, notably Augustine; from 1759 to 1762 he travelled in Germany, Italy and France, mainly with a view to examining the collections of documents in the various monastic libraries. In 1764 he was elected prince-abbot of St Blasien, and proved himself a model ruler both as abbot and prince. His examination of archives during his travels had awakened in him a taste for historical research, and under his rule St

Blasien became a notable centre of the methodical study of history; it was here that Marquard Herrgott wrote his *Monumenta domus Austriacae*, of which the first two volumes were edited, for the second edition, by Gerbert, who also published a *Codex epistolaris Rudolphi I., Romani regis* (1772) and *De Rudolpho Suevico comite de Rhinselden, duce et rege, deque ejus familia* (1785). It was, however, in sacramental theology, liturgy, and notably ecclesiastical music that Gerbert was mainly interested. In 1774 he published two volumes *De cantu et musica sacra*; in 1777, *Monumenta veteris liturgiae Alemannicae*; and in 1784, in three volumes, *Scriptores ecclesiastici de musica sacra*, a collection of the principal writers on church music from the 3rd century till the invention of printing. The materials for this work he had gathered during his travels, and although it contains many textual errors, its publication has been of great importance for the history of music, by preserving writings which might either have perished or remained unknown. His interest in music led to his acquaintance with the composer Gluck, who became his intimate friend.

As a prince of the Empire Gerbert was devoted to the interests of the house of Austria; as a Benedictine abbot he was opposed to Joseph II.'s church policy. In the Febronian controversy (see FEBRONIANISM) he had early taken a mediating attitude, and it was largely due to his influence that Bishop Hontheim had been induced to retract his extreme views.

In 1768 the abbey of St Blasien, with the library and church, was burnt to the ground, and the splendid new church which rose on the ruins of the old (1783) remained until its destruction by fire in 1874, at once a monument of Gerbert's taste in architecture and of his Habsburg sympathies. It was at his request that it was made the mausoleum of all the Austrian princes buried outside Austria, whose remains were solemnly transferred to its vaults. In connexion with its consecration he published his *Historia Nigrae Sitaee, ordinis S. Benedicti coloniae* (3 vols., St Blasien, 1783).

Gerbert, who was beloved and respected by Catholics and Protestants alike, died on the 3rd of May 1793.

See Joseph Bader, *Das ehemalige Kloster St Blasien und seine Gelehrtenakademie* (Freiburg-im-Breisgau, 1874), which contains a chronological list of Gerbert's works.

GERBIL, or **GERBILLE**, the name of a group of small, elegant, large-eyed, jumping rodents typified by the North African *Gerbillus aegyptiacus* (or *gerbillus*), and forming a special sub-family, *Gerbillinae*, of the rat tribe or *Muridae*. They are found over the desert districts of both Asia and Africa, and are classed in the genera *Gerbillus* (or *Tatera*), *Pachyromys*, *Meriones*, *Psammomys* and *Rhombomys*, with further divisions into sub-genera. They have elongated hind-limbs and long hairy tails; and progress by leaps, in the same manner as jerboas, from which they differ in having five hind-toes. The cheek-teeth have transverse plates of enamel on the crowns; the number of such plates diminishing from three in the first tooth to one or one and a half in the third. The upper incisor teeth are generally marked by grooves. Gerbils are inhabitants of open sandy plains, where they dwell in burrows furnished with numerous exits, and containing large grass-lined chambers. The Indian *G. indicus* produces at least a dozen young at a birth. All are more or less completely nocturnal.

GERENUK, the Somali name of a long-necked aberrant gazelle, commonly known as Waller's gazelle (*Lithocranius walleri*), and ranging from Somaliland to Kilimanjaro. The long neck and limbs, coupled with peculiarities in the structure of the skull, entitle the gerenuk, which is a large species, to represent a genus. The horns of the bucks are heavy, and have a peculiar forward curvature at the tips; the colour of the coat is red-fawn, with a broad brown band down the back. Gerenuk are browsing ruminants, and, in Somaliland, are found in small family-parties, and feed more by browsing on the branches and leaves of trees and shrubs than by grazing. Frequently they raise themselves by standing on their hind-legs with the fore-feet resting against the trunk of the tree on which they are feeding. Their usual pace is an awkward trot, not unlike that of a camel; and they seldom

break into a gallop. The Somali form has been separated as *L. sclateri*, but is not more than a local race. (See ANTELOPE.)

GERGOVIA (mod. *Gergovie*), in ancient geography, the chief town of the Arverni, situated on a hill in the Auvergne, about 8 m. from the Puy de Dôme, France. Julius Caesar attacked it in 52 B.C., but was beaten off; some walls and earthworks seem still to survive from this period. Later, when Gaul had been subdued, the place was dismantled and its Gaulish inhabitants resettled 4 m. away in the plain at the new Roman city of Augustonemétum (mod. *Clermont-Ferrand*).

GERHARD, FRIEDRICH WILHELM EDUARD (1795-1867), German archaeologist, was born at Posen on the 20th of November 1795, and was educated at Breslau and Berlin. The reputation he acquired by his *Lectiones Apollonianae* (1816) led soon afterwards to his being appointed professor at the gymnasium of Posen. On resigning that office in 1819, on account of weakness of the eyes, he went in 1822 to Rome, where he remained for fifteen years. He contributed to Platner's *Beschreibung der Stadt Rom*, then under the direction of Bunsen, and was one of the principal originators and during his residence in Italy director of the *Istituto di corrispondenza archeologica*, founded at Rome in 1828. Returning to Germany in 1837 he was appointed archaeologist at the Royal Museum of Berlin, and in 1844 was chosen a member of the Academy of Sciences, and a professor in the university. He died at Berlin on the 12th of May 1867.

Besides a large number of archaeological papers in periodicals, in the *Annals* of the Institute of Rome, and in the *Transactions* of the Berlin Academy, and several illustrated catalogues of Greek, Roman and other antiquities in the Berlin, Naples and Vatican Museums, Gerhard was the author of the following works: *Antike Bildwerke* (Stuttgart, 1827-1844); *Ausgrabene griech. Vasenbilder* (1839-1858); *Etruskische Spiegel* (1839-1865); *Hyperboreisch-rom. Studien* (vol. i., 1833; vol. ii., 1852); *Prodromus mytholog. Kunsterklärung* (Stuttgart and Tübingen, 1828); and *Griech. Mythologie* (1854-1855). His *Gesammelte akademische Abhandlungen und kleine Schriften* were published posthumously in 2 vols., Berlin, 1867.

GERHARD, JOHANN (1582-1637), Lutheran divine, was born in Quedlinburg on the 17th of October 1582. In his fifteenth year, during a dangerous illness, he came under the personal influence of Johann Arndt, author of *Das wahre Christenthum*, and resolved to study for the church. He entered the university of Wittenberg in 1599, and first studied philosophy. He also attended lectures in theology, but, a relative having persuaded him to change his subject, he studied medicine for two years. In 1603, however, he resumed his theological reading at Jena, and in the following year received a new impulse from J. W. Winckelmann (1551-1626) and Balthasar Mentzer (1565-1627) at Marburg. Having graduated and begun to give lectures at Jena in 1605, he in 1606 accepted the invitation of John Casimir, duke of Coburg, to the superintendency of Heldburg and mastership of the gymnasium; soon afterwards he became general superintendent of the duchy, in which capacity he was engaged in the practical work of ecclesiastical organization until 1616, when he became theological professor at Jena, where the remainder of his life was spent. Here, with Johann Major and Johann Himmel, he formed the "Trias Johanna." Though still comparatively young, Gerhard had already come to be regarded as the greatest living theologian of Protestant Germany; in the numerous "disputations" of the period he was always protagonist, while on all public and domestic questions touching on religion or morals his advice was widely sought. It is recorded that during the course of his lifetime he had received repeated calls to almost every university in Germany (e.g. Giessen, Altdorf, Helmstädt, Jena, Wittenberg), as well as to Upsala in Sweden. He died in Jena on the 20th of August 1637.

His writings are numerous, alike in exegetical, polemical, dogmatic and practical theology. To the first category belong the *Commentarius in harmoniam historiae evangelicae de passione Christi* (1617), the *Comment. super priorem D. Petri epistolam* (1641), and also his commentaries on Genesis (1637) and on Deuteronomy (1658). Of a controversial character are the *Confessio Catholica* (1633-1637), an extensive work which seeks to prove the evangelical and catholic character of the doctrine of the Augsburg Confession from the writings of approved Roman Catholic authors; and the *Loci communes theologici* (1610-1622), his principal contribution to science, in which Lutheranism is expounded "nervose, solide,

et copiose," in fact with a fulness of learning, a force of logic and a minuteness of detail that had never before been approached. The *Meditationes sacrae* (1606), a work expressly devoted to the uses of Christian edification, has been frequently reprinted in Latin and has been translated into most of the European languages, including Greek. The English translation by R. Winton (1631) has passed through at least nineteen editions. There is also an edition by W. Papillon in English blank verse (1801). His life, *Vita Joh. Gerhardt*, was published by E. R. Fischer in 1723, and by C. J. Böttcher, *Das Leben Dr. Johann Gerhardt*, in 1858. See also W. Gass, *Geschichte der protestantischen Dogmatik* (1854-1867), and the article in the *Allgemeine deutsche Biographie*.

GERHARDT, CHARLES FRÉDÉRIC (1816-1856), French chemist, was born at Strassburg on the 21st of August 1816. After attending the gymnasium at Strassburg and the polytechnic at Karlsruhe, he was sent to the school of commerce at Leipzig, where he studied chemistry under Otto Erdmann. Returning home in 1834 he entered his father's white lead factory, but soon found that business was not to his liking, and after a sharp disagreement with his father enlisted in a cavalry regiment. In a few months military life became equally distasteful, and he purchased his discharge with the assistance of Liebig, with whom, after a short interval at Dresden, he went to study at Giessen in 1836. But his stay at Giessen was also short, and in 1837 he re-entered the factory. Again, however, he quarrelled with his father, and in 1838 went to Paris with introductions from Liebig. There he attended Jean Baptiste Dumas' lectures and worked with Auguste Cahours (1813-1897) on essential oils, especially cumin, in Michel Eugène Chevreul's laboratory, while he earned a precarious living by teaching and making translations of some of Liebig's writings. In 1841, by the influence of Dumas, he was charged with the duties of the chair of chemistry at the Montpellier faculty of sciences, becoming titular professor in 1844. In 1842 he annoyed his friends in Paris by the matter and manner of a paper on the classification of organic compounds, and in 1845 he and his opinions were the subject of an attack by Liebig, unjustifiable in its personalities but not altogether surprising in view of his wayward disregard of his patron's advice. The two were reconciled in 1850, but his faculty for disagreeing with his friends did not make it easier for him to get another appointment after resigning the chair at Montpellier in 1851, especially as he was unwilling to go into the provinces. He obtained leave of absence from Montpellier in 1848 and from that year till 1855 resided in Paris. During that period he established an "École de chimie pratique" of which he had great hopes; but these were disappointed, and in 1855, after refusing the offer of a chair of chemistry at the new Zürich Polytechnic in 1854, he accepted the professorships of chemistry at the Faculty of Sciences and the École Polytechnique at Strassburg, where he died on the 19th of August in the following year. Although Gerhardt did some noteworthy experimental work—for instance, his preparation of acid anhydrides in 1852—his contributions to chemistry consist not so much in the discovery of new facts as in the introduction of new ideas that vitalized and organized an inert accumulation of old facts. In particular, with his fellow-worker Auguste Laurent (1807-1853), he did much to reform the methods of chemical formulation by insisting on the distinction between atoms, molecules and equivalents; and in his unitary system, directly opposed to the dualistic doctrines of Berzelius, he combined Dumas' substitution theory with the old radicle theory and greatly extended the notion of types of structure. His chief works were *Précis de chimie organique* (1844-1845), and *Traité de chimie organique* (1853-1856).

See *Charles Gerhardt, sa vie, son œuvre, sa correspondance*, by his son, Charles Gerhardt, and E. Grimaux (Paris, 1900).

GERHARDT, PAUL (c. 1606-1676), German hymn-writer, was born of a good middle-class family at Gräfenhainichen, a small town on the railway between Halle and Wittenberg, in 1606 or 1607—some authorities, indeed, give the date March 12, 1607, but neither the year nor the day is accurately known. His education appears to have been retarded by the troubles of the period, the Thirty Years' War having begun about the time he reached his twelfth year. After completing his studies for the church he is known to have lived for some years at

Berlin as tutor in the family of an advocate named Berthold, whose daughter he subsequently married, on receiving his first ecclesiastical appointment at Mittelwald (a small town in the neighbourhood of Berlin) in 1651. In 1657 he accepted an invitation as "diaconus" to the Nicolaikirche of Berlin; but, in consequence of his uncompromising Lutheranism in refusing to accept the elector Frederick William's "syncretistic" edict of 1664, he was deprived in 1666. Though absolved from submission and restored to office early in the following year, on the petition of the citizens, his conscience did not allow him to retain a post which, as it appeared to him, could only be held on condition of at least a tacit repudiation of the Formula Concordiae, and for upwards of a year he lived in Berlin without fixed employment. In 1668 he was appointed archdeacon of Lübben in the duchy of Saxe-Merseburg, where, after a somewhat sombre ministry of eight years, he died on the 7th of June 1676. Gerhardt is the greatest hymn-writer of Germany, if not indeed of Europe. Many of his best-known hymns were originally published in various church hymn-books, as for example in that for Brandenburg, which appeared in 1658; others first saw the light in Johann Crüger's *Geistliche Kirchenmelodien* (1649) and *Praxis pietatis melica* (1656). The first complete set of them is the *Geistliche Andachten*, published in 1666-1667 by Ebeling, music director in Berlin. No hymn by Gerhardt of a later date than 1667 is known to exist.

The life of Gerhardt has been written by Roth (1829), by Langbecker (1841), by Schultz (1842), by Wildenhahn (1845) and by Bachmann (1863); also by Kraft in Eruch u. Gruber's *Allg. Encycl.* (1855). The best modern edition of the hymns, published by Wackernagel in 1843, has often been reprinted. There is an English translation by Kelly (*Paul Gerhardt's Spiritual Songs*, 1867).

GÉRICAULT, JEAN LOUIS ANDRÉ THÉODORE (1791-1824), French painter, the leader of the French realistic school, was born at Rouen in 1791. In 1808 he entered the studio of Charles Vernet, from which, in 1810, he passed to that of Guérin, whom he drove to despair by his passion for Rubens, and by the unorthodox manner in which he persisted in interpreting nature. At the Salon of 1812 Géricault attracted attention by his "Officier de Chasseurs à Cheval" (Louvre), a work in which he personified the cavalry in its hour of triumph, and turned to account the solid training received from Guérin in rendering a picturesque point of view which was in itself a protest against the cherished convictions of the pseudo-classical school. Two years later (1814) he re-exhibited this work accompanied with the reverse picture "Cuirassier blessé" (Louvre), and in both subjects called attention to the interest of contemporary aspects of life, treated neglected types of living form, and exhibited that mastery of and delight in the horse which was a feature of his character. Disconcerted by the tempest of contradictory opinion which arose over these two pictures, Géricault gave way to his enthusiasm for horses and soldiers, and enrolled himself in the *mousquetaires*. During the Hundred Days he followed the king to Bethune, but, on his regiment being disbanded, eagerly returned to his profession, left France for Italy in 1816, and at Rome nobly illustrated his favourite animal by his great painting "Course des Chevaux Libres." Returning to Paris, Géricault exhibited at the Salon of 1819 the "Radeau de la Méduse" (Louvre), a subject which not only enabled him to prove his zeal and scientific study of the human form, but contained those elements of the heroic and pathetic, as existing in situations of modern life, to which he had appealed in his earliest productions. Easily depressed or elated, Géricault took to heart the hostility which this work excited, and passed nearly two years in London, where the "Radeau" was exhibited with success, and where he executed many series of admirable lithographs now rare. At the close of 1822 he was again in Paris, and produced a great quantity of projects for vast compositions, models in wax, and a horse *écorché*, as preliminary to the production of an equestrian statue. His health was now completely undermined by various kinds of excess, and on the 26th of January 1824 he died, at the age of thirty-three.

Géricault's biography, accompanied by a *catalogue raisonné* of his works, was published by M. C. Clément in 1868.

GERIZIM, a mountain in the hill-country of Samaria, 2840 ft. above the sea-level, and enclosing, with its companion Ebal, the valley in which lies the town of Nâblus (Shechem). It is the holy place of the community of the Samaritans, who hold that it was the scene of the sacrifice of Isaac—a tradition accepted by Dean Stanley but no other western writers of importance. Here, on the formal entrance of the Israelites into the possession of the Promised Land, were pronounced the blessings connected with a faithful observance of the law (Josh. viii. 33, 34; cf. Deut. xi. 29, 30, xxvii. 12-26), the six tribes, Simcon, Levi, Judah, Issachar, Joseph and Benjamin, standing here for the purpose while the remaining tribes stood on Ebal to accept the curses attached to specific violations thereof. Gerizim was probably chosen as the mount of blessing as being on the right hand, the fortunate side, of a spectator facing east. The counter-suggestion of Eusebius and Jerome that the Ebal and Gerizim associated with this solemnity were not the Shechem mountains at all, but two small hills near Jericho, is no longer considered important. From this mountain Jotham spoke his parable to the elders of Shechem (Judg. ix. 7). Manasseh, the son of the Jewish high-priest in the days of Nehemiah, married the daughter of Sanballat and, about 432 B.C., erected on this mountain a temple for the Samaritans; it was destroyed by Hyrcanus about 300 years afterwards. Its site is a small level plateau a little under the summit of the mountain. Close to this is the place where the Passover is still annually celebrated in exact accordance with the rites prescribed in the Pentateuch. On the summit of the mountain, which commands a view embracing the greater part of Palestine, are a small Moslem shrine and the ruins of a castle probably dating from Justinian's time. There was an octagonal Byzantine church here, but the foundations alone remain. Josephus describes it as the highest of the mountains of Samaria, but Ebal and Tell Azur are both higher. (R. A. S. M.)

GERLACHE, ÉTIENNE CONSTANTIN, BARON DE (1785-1871), Belgian politician and historian, was born at Biourge, Luxemburg, on the 24th of December 1785. He studied law in Paris and practised there for some time, but settled at Liège after the establishment of the kingdom of the Netherlands. As member of the states-general he was an energetic member of the opposition, and, though he repudiated an ultramontane policy, he supported the alliance of the extreme Catholics with the Liberal party, which paved the way for the revolution of 1830. On the outbreak of disturbance in August 1830 he still, however, thought the Orange-Nassau dynasty and the union with the Dutch states essential; but his views changed, and, after holding various offices in the provisional government, he became president of congress, and brought forward the motion inviting Leopold of Saxe-Coburg to become king of the Belgians. In 1832 he was president of the chamber of representatives, and for thirty-five years he presided over the court of appeal. He presided over the Catholic congresses held at Malines between 1863 and 1867. That his early Liberal views underwent some modification is plain from the Conservative principles enunciated in his *Essai sur le mouvement des partis en Belgique* (Brussels, 1852). As an historian his work was strongly coloured by his anti-Dutch prejudices and his Catholic predilections. His *Histoire des Pays-Bas depuis 1814 jusqu'en 1830* (Brussels, 2 vols., 1839), which reached a fourth edition in 1875, was a piece of special pleading against the Dutch domination. The most important of his other works were his *Histoire de Liège* (Brussels, 1843) and his *Études sur Salluste et sur quelques-uns des principaux historiens de l'antiquité* (Brussels, 1847).

A complete edition of his works (6 vols., Brussels, 1874-1875) contains a biography by M. Thonissen.

GERLE, CHRISTOPHE ANTOINE (1736-c. 1801), French revolutionist and mystic, was born at Riom in Auvergne. Entering the Carthusian order early in life, he became prior of Laval-Dieu in Perche, and afterwards of Pont-Sainte-Marie at Moulins. Elected deputy to the states-general in 1789, Gerle became very popular, and though he had no seat in the assembly until after the Tennis Court oath, being only deputy *suppléant*, he is represented in David's classic painting as taking part in it. In 1792

he was chosen elector of Paris. In the revolutionary turmoil Gerle developed a strong vein of mysticism, mingled with ideas of reform, and in June 1790 the prophetic powers of Suzanne Labrousse (1747-1821), a visionary who had predicted the Revolution ten years before, were brought by him to the notice of the Convention. In Paris, where he lived first with a spiritualistic doctor and afterwards, like Robespierre, at the house of a cabinetmaker, his mystical tendencies were strengthened. The insane fancies of Catherine Théot, a convent servant turned prophetess, who proclaimed herself the Virgin, the "Mother of God" and the "new Eve," were eminently attractive to Gerle; in the person of Robespierre he recognized the Messiah, and at the meetings of the Théotists he officiated with the aged prophetess as co-president. But the activities of Catherine and her adepts were short-lived. The Théotists' cult of Robespierre was a weapon in the hands of his opponents; and shortly after the festival of the Supreme Being, Vadier made a report to the Convention calling for the prosecution of Catherine, Gerle and others as fanatics and conspirators. They were arrested, thrown into prison and, in the confusion of Robespierre's fall, apparently forgotten. Catherine died in prison, but Gerle, released by the Directory, became one of the editors of the *Messenger du soir*, and was afterwards in the office of Pierre Bénézech (1775-1802), minister of the interior. Having renounced his monastic vows in Paris, he is thought to have married, towards the close of his life, Christine Raffet, aunt of the artist Denis Raffet. The date of his death is uncertain.

GERMAN BAPTIST BRETHREN, or GERMAN BRETHREN, a sect of American Baptists which originated in Germany, and whose members are popularly known in the United States as "Dunkers," "Dunkards" or "Tunkers," corruptions of the German verb *tunken*, "to dip," in recognition of the sect's continued adherence to the practice of trine immersion. The sect was the outcome of one of the many Pietistic movements of the 17th century, and was founded in 1708 by Andrew Mack of Swartzenau, Germany, and seven of his followers, upon the general issue that both the Lutheran and Reformed churches were taking liberties with the literal teachings of the Scriptures. The new sect was scarcely organized in Germany when its members were compelled by persecution to take refuge in Holland, whence they emigrated to Pennsylvania, in small companies, between 1719 and 1729. The first congregation in America was organized on Christmas Day 1723 by Peter Becker at Germantown, Pennsylvania, and here in 1743 Christopher Sauer, one of the sect's first pastors, and a printer by trade, printed the first Bible (a few copies of which are still in existence) published in a European language in America. From Pennsylvania the sect spread chiefly westward, and, after various vicissitudes, caused by defections and divisions due to doctrinal differences, in 1908 were most numerous in Pennsylvania, Maryland, Virginia, Ohio, Indiana, Illinois, Iowa, Missouri, Nebraska, Kansas and North Dakota.

There is much uncertainty about the early theological history of the sect, but it is probable that Mack and his followers were influenced by both the Greek Catholics and the Waldensians. P. H. Bashor in his historical sketch, read before the World's Fair Congress of the Brethren Church (1894), says: "From the history of extended labour by Greek missionaries, from the active propaganda of doctrine by scattered Waldensian refugees, through parts of Germany and Bavaria, from the credence that may generally be given to local tradition, and from the strong similarity between the three churches in general features of circumstantial service, the conclusion, without additional evidence, is both reasonable and natural that the founders of the new church received their teaching, their faith and much of their church idea from intimate acquaintance with the established usages of both societies, and from their amplification and enforcement by missionaries and pastors. . . . In doctrine the church has been from the first contentious for believers' baptism, holding that nowhere in the New Testament can be found any authority even by inference, precept or example for the baptism of infants. On questions of fundamental doctrine they held to the belief

GERMAN CATHOLICS

in one self-existing supreme ruler of the Universe—the Divine Godhead—the Father, the Son and the Holy Spirit—the trinity. Hence their practice of triple immersion, which provides that the candidate shall kneel in the water and be immersed, face first, three times—in the name of the Father, the Son and the Holy Spirit. (From this practice the sect received the less commonly used nickname "Dompelaers," meaning "tumblers.") They accept implicitly and literally the New Testament as the infallible guide in spiritual matters, holding it to be the inspired word of God, revealed through Jesus Christ and, by inspiration, through the Apostles. They also believe in the inspiration of the Old Testament. In their celebration of the communion service they aim exactly to imitate the forms observed by Christ. It is celebrated in the evening, and is accompanied by the ancient love feast (partaken by all communicants seated at a common table), by the ceremony of the washing of feet and by the salutation of the holy kiss, the three last-named ceremonies being observed by the sexes separately. They pray over their sick and, when so requested, anoint them with oil. They are rigid non-resistants, and will not bear arms or study the art of war; they refuse to take oaths, and discountenance going to law over issues that can possibly be settled out of the courts. The taking of interest was at first forbidden, but that prohibition is not now insisted upon. They "testify" against the use of intoxicating liquor and tobacco, and advocate simplicity in dress. In its earlier history the sect opposed voting or taking any active part in political affairs, but these restrictions have quite generally disappeared. Similarly the earlier prejudice against higher education, and the maintenance of institutions for that purpose, has given place to greater liberality along those lines. In 1782 the sect forbade slaveholding by its members.

The church officers (generally unpaid) comprise bishops (or ministers), elders, teachers, deacons (or visiting brethren) and deaconesses—chiefly aged women who are permitted at times to take leading parts in church services. The bishops are chosen from the teachers; they are itinerant, conduct marriage and funeral services, and are present at communions, at ordinations, when deacons are chosen or elected, and at trials for the excommunication of members. The elders are the first or oldest teachers of congregations, for which there is no regular bishop. They have charge of the meetings of such congregations, and participate in excommunication proceedings, besides which they preach, exhort, baptize, and may, when needed, take the offices of the deacons. The teachers, who are chosen by vote, may also exhort or preach, when their services are needed for such purposes, and may, at the request of a bishop, perform marriage or baptismal ceremonies. The deacons have general oversight of the material affairs of the congregation, and are especially charged with the care of poor widows and their children. In the discharge of these duties they are expected to visit each family in the congregation at least once a year. The government of the church is chiefly according to the congregational principle, and the women have an equal voice with the men; but annual meetings, attended by the bishops, teachers and other delegates from the several congregations are held, and at these sessions the larger questions involving church polity are considered and decided by a committee of five bishops.

An early secession from the general body of Dunkers was that of the Seventh Day Dunkers, whose distinctive principle was that the seventh day was the true Sabbath. Their founder was Johann Conrad Beissel (1690-1768), a native of Eberbach and one of the first emigrants, who, after living as a hermit for several years on Mill Creek, Lancaster county, Pennsylvania, founded the sect (1725), then again lived as a hermit in a cave (formerly occupied by another hermit, one Elimelech) on the Cocalico Creek in Pennsylvania, and in 1732-1735 established a semi-monastic community (the "Order of the Solitary") with a convent (the "Sister House") and a monastery (the "Brother House") at Ephrata, in what is now Lancaster county, about 55 m. W. by N. from Philadelphia. Among the industries of the men were printing (in both English and German), book-

binding, tanning, quarrying, and the operation of a saw mill, a bark mill, and perhaps a pottery; the women did embroidery, quilting, and engraving in a beautiful but peculiar hand, known as Fracturschrift.¹ The monastic feature was gradually abandoned, and in 1814 the Society was incorporated as the Seventh Day Baptists, its affairs being placed in the hands of a board of trustees. More important in the history of the modern church was the secession, in the decade between 1880 and 1890, of the Old Order Brethren, who opposed Sunday Schools and the missionary work of the Brethren, in Asia Minor and India, and in several European countries; and also in 1882 of the radicals, or Progressives, who objected to a distinctive dress and to the absolute supremacy of the yearly conferences. Higher education was long forbidden and is consistently opposed by the Old Order. The same element in the Brethren opposed a census, but according to Howard Miller's census of 1880 (*Record of the Faithful*) the number of Dunkers was 59,749 in that year; by the United States census of 1890 it was then 73,795; the figures for 1904 are given by Henry King Carroll in his "Statistics of the Churches" in the *Christian Advocate* (Jan. 5, 1905): Conservatives, or German Baptist Brethren, 95,000; Old Order, 4,000; Progressives or Brethren, 15,000; Seventh Day, 194; total, 114,194. In 1909 the German Baptist Brethren had an estimated membership of approximately 100,000, and the Brethren of 18,000. The main body, or Conservatives, support schools at Huntington, Pennsylvania; Mt. Morris, Illinois; Lordsburg, California, McPherson, Kansas; Bridgewater, Virginia; Canton, Ohio; Chicago, Illinois, North Manchester, Indiana; Plattsburg, Missouri; Elizabethtown, Pennsylvania; Union Bridge, Maryland; and Fruitdale, Alabama. They have a publishing house at Elgin, Illinois, and maintain missions in Denmark, Sweden, France, Italy, India and China. The Progressives have a college, a theological seminary and a publishing house at Asbland, Ohio; and they carry on missionary work in Canada, South America and Persia.

AUTHORITIES.—Lamech and Agrippa, *Chronicon Ephratense*, in German (Ephrata, Penn., 1786) and in English (Lancaster, 1889); G. N. Falkenstein, "The German Baptist Brethren, or Dunkers," part 8 of "Pennsylvania: The German Influence in its Settlement and Development," in vol. x. of the *Pennsylvania German Society, Proceedings and Addresses* (Lancaster, Penn., 1900); Julius Friedrich Sachse, *The German Sectarians of Pennsylvania, 1742-1800: A Critical and Legendary History of the Ephrata Cloister and the Dunkers* (Philadelphia, 1900); and John Lewis Gillin, *The Dunkers: A Sociological Interpretation* (New York, 1906), a doctor's dissertation, with full bibliography.

GERMAN CATHOLICS (*Deutschkatholiken*), the name assumed in Germany towards the close of 1844 by certain dissentients from the Church of Rome. The most prominent leader of the German Catholic movement was Johann Ronge, a priest who in the *Sächsische Vaterlandsblätter* for the 15th of October 1844 made a vigorous attack upon Wilhelm Arnoldi, bishop of Trier since 1842, for having ordered (for the first time since 1810) the exposition of the "holy coat of Trier," alleged to be the seamless robe of Christ, an event which drew countless pilgrims to the cathedral. Ronge, who had formerly been chaplain at Grottkau, was then a schoolmaster at Laurahütte near the Polish border. The article made a great sensation, and led to Ronge's excommunication by the chapter of Breslau in December 1844. The ex-priest received a large amount of public sympathy, and a dissenting congregation was almost immediately formed at Breslau with a very simple creed, in which the chief articles were belief in God the Father, creator and ruler of the universe;

¹ Beissel (known in the community as "Friedsam") was their leader until his death; he published several collections of hymns. The stone over his grave bears the inscription: "Here rests an outgrowth of the love of God, 'Friedsam,' a Solitary Brother, afterwards a leader of the Solitary and the Congregation of Grace in and around Ephrata. . . . Fell asleep July 6, 1768, in the 52nd year of his spiritual life, but the 72nd year and fourth month of his natural life." The borough of Ephrata was separated from the township in 1891. Pop. (1900) of the borough, 2451; of the township, 2390. The "Brother House" and the "Sister House" are still standing (though in a dilapidated condition). In 1777, after the battle of Brandywine, many wounded American soldiers were nursed here by the Sisters, and about 200 are buried here.

in Jesus Christ the Saviour, who delivers from the bondage of sin by his life, doctrine and death; in the operation of the Holy Ghost; in a holy, universal, Christian church; in forgiveness of sins and the life everlasting. The Bible was made the sole rule, and all external authority was barred. Within a few weeks similar communities were formed at Leipzig, Dresden, Berlin, Offenbach Worms, Wiesbaden and elsewhere; and at a "council" convened at Leipzig at Easter 1845, twenty-seven congregations were represented by delegates, of whom only two or at most three were in clerical orders.

Even before the beginning of the agitation led by Ronge, another movement fundamentally distinct, though in some respects similar, had been originated at Schneidemühl, Posen, under the guidance of Johann Czernski (1813-1893), also a priest, who had come into collision with the church authorities on the then much discussed question of mixed marriages, and also on that of the celibacy of the clergy. The result had been his suspension from office in March 1844; his public withdrawal, along with twenty-four adherents, from the Roman communion in August; his excommunication; and the formation, in October, of a "Christian Catholic" congregation which, while rejecting clerical celibacy, the use of Latin in public worship, and the doctrines of purgatory and transubstantiation, retained the Nicene theology and the doctrine of the seven sacraments. Czernski had been at some of the sittings of the "German Catholic" council of Leipzig; but when a formula somewhat similar to that of Breslau had been adopted, he refused his signature because the divinity of Christ had been ignored, and he and his congregation continued to retain by preference the name of "Christian Catholics," which they had originally assumed. Of the German Catholic congregations which had been represented at Leipzig some manifested a preference for the fuller and more positive creed of Schneidemühl, but a great majority continued to accept the comparatively rationalistic position of the Breslau school. The number of these rapidly increased, and the congregations scattered over Germany numbered nearly 200. External and internal checks, however, soon limited this advance. In Austria, and ultimately also in Bavaria, the use of the name German Catholics was officially prohibited, that of "Dissidents" being substituted, while in Prussia, Baden and Saxony the adherents of the new creed were laid under various disabilities, being suspected both of undermining religion and of encouraging the revolutionary tendencies of the age. Ronge himself was a foremost figure in the troubles of 1848; after the dissolution of the Frankfurt parliament he lived for some time in London, returning in 1861 to Germany. He died at Vienna on the 26th of October 1887. In 1859 some of the German Catholics entered into corporate union with the "Free Congregations," an association of free-thinking communities that had since 1844 been gradually withdrawing from the orthodox Protestant Church, when the united body took the title of "The Religious Society of Free Congregations." Before that time many of the congregations which were formed in 1844 and the years immediately following had been dissolved, including that of Schneidemühl

itself, which ceased to exist in 1857. There are now only about 2000 strict German Catholics, all in Saxony. The movement has been superseded by the Old Catholic (q.v.) organization.

See G. G. Gervinus, *Die Mission des Deutschkatholicismus* (1846); F. Kampe, *Das Wesen des Deutschkatholicismus* (1860); Fintel, *Der Deutschkatholicismus in Sachsen* (1895); Carl Mirbt, in *Herzog-Hauck's Realencyk. für prot. Theol.* iv. 583.

GERMAN EAST AFRICA, a country occupying the east-central portion of the African continent. The colony extends at its greatest length north to south from 1° to 11° S., and west to east from 30° to 40° E. It is bounded E. by the Indian Ocean (the coast-line extending from 4° 20' to 10° 40' S.), N.E. and N. by British East Africa and Uganda, W. by Belgian Congo, S.W. by British Central Africa and S. by Portuguese East Africa.

Area and Boundaries.—On the north the boundary line runs N.W. from the mouth of the Umba river to Lake Jipe and Mount Kil-



manjaro, including both in the protectorate, and thence to Victoria Nyanza, crossing it at 1° S., which parallel it follows till it reaches 30° E. In the west the frontier is as follows. From the point of intersection of 1° S. and 30° E., a line running S. and S.W. to the north-west end of Lake Nyanza, thence across that lake near its western shore, and along the river Rusizi, which issues from it, to the spot where the Rusizi enters the north end of Lake Tanganyika; along the middle line of Tanganyika to near its southern end, when it is deflected eastward to the point where the river Kalambo enters the lake (thus leaving the southern end of Tanganyika to Great Britain). From this point the frontier runs S.E. across the plateau between Lakes Tanganyika and Nyasa, in its southern section following the course of the river Songwe. Thence it goes down the middle of Nyasa as far as 11° 30' S. The southern frontier goes direct from the last-named point eastward to the Rovuma river, which separates German and Portuguese territory. A little before the Indian Ocean is reached the frontier is deflected south so as to leave the mouth of the Rovuma in German East Africa. These boundaries include an area of about 364,000 sq. m. (nearly double the size of Germany), with a population estimated in 1910 at 8,000,000. Of

these above 10,000 were Arabs, Indians, Syrians and Goanese, and 3000 Europeans (over 2000 being Germans). The island of Mafia (see below) is included in the protectorate.

Physical Features.—The coast of German East Africa (often spoken of as the Swahili coast, after the inhabitants of the seaboard) is chiefly composed of coral, is little indented, and is generally low, partly sandy, partly rich alluvial soil covered with dense bush or mangroves. Where the Arabs have established settlements the coco-palm and mango tree introduced by them give variety to the vegetation. The coast plain is from 10 to 30 m. wide and 620 m. long; it is bordered on the west by the precipitous eastern side of the interior plateau of Central Africa. This plateau, considerably tilted from its horizontal position, attains its highest elevation north of Lake Nyasa (see LIVINGSTONE MOUNTAINS), where several peaks rise over 7000 ft., one to 9600, while its mean altitude is about 3000 to 4000 ft. From this region the country slopes towards the north-west, and is not distinguished by any considerable mountain ranges. A deep narrow gorge, the so-called "eastern rift-valley," traverses the middle of the plateau in a meridional direction. In the northern part of the country it spreads into several side valleys, from one of which rises the extinct volcano Kilimanjaro (*q.v.*), the highest mountain in Africa (19,321 ft.). Its glaciers send down a thousand rills which combine to form the Pangani river. About 40 m. west of Kilimanjaro is Mount Meru (14,955 ft.), another volcanic peak, with a double crater. The greater steepness of its sides makes Meru in some aspects a more striking object than its taller neighbour. South-east of Mount Kilimanjaro are the Pare Mountains and Usambara highlands, separated from the coast by a comparatively narrow strip of plain. To the south of the Usambara hills, and on the eastern edge of the plateau, are the mountainous regions of Nguru (otherwise Unguru), Useguha and Usagara. As already indicated, the southern half of Victoria Nyanza and the eastern shores, in whole or in part, of Lakes Kivu, Tanganyika and Nyasa, are in German territory. (The lakes are separately described.) Several smaller lakes occur in parts of the eastern rift-valley. Lake Rukwa (*q.v.*) north-west of Nyasa is presumably only the remnant of a much larger lake. Its extent varies with the rainfall of each year. North-west of Kilimanjaro is a sheet of water known as the Natron Lake from the mineral alkali it contains. In the northern part of the colony the Victoria Nyanza is the dominant physical feature. The western frontier coincides with part of the eastern wall of another depression, the Central African or Albertine rift-valley, in which lie Tanganyika, Kivu and other lakes. Along the north-west frontier north of Kivu are volcanic peaks (see Mfumbiro).

The country is well watered, but with the exception of the Rufiji the rivers, save for a few miles from their mouths, are unnavigable. The largest streams are the Rovuma and Rufiji (*q.v.*), both rising in the central plateau and flowing to the Indian Ocean. Next in importance is the Pangani river, which, as stated above, has its head springs on the slopes of Kilimanjaro. Flowing in a south-easterly direction it reaches the sea after a course of some 250 m. The Wami and Kingani, smaller streams, have their origin in the mountainous region fringing the central plateau, and reach the ocean opposite the island of Zanzibar. Of inland river systems there are four—one draining to Victoria Nyanza, another to Tanganyika, a third to Nyasa and a fourth to Rukwa. Into Victoria Nyanza are emptied, on the east, the waters of the Mori and many smaller streams; on the west, the Kagera (*q.v.*), besides smaller rivers. Into Tanganyika flows the Malagarasi, a considerable river with many affluents, draining the west-central part of the plateau. The Kalambo river, a comparatively small stream near the southern end of Tanganyika, flows in a south-westerly direction. Not far from its mouth there is a magnificent fall, a large volume of water falling 600 ft. sheer over a rocky ledge of horse-shoe shape. Of the streams entering Nyasa the Songwe has been mentioned. The Ruhuhu, which enters Nyasa in 10° 30' S., and its tributaries drain a considerable area west of 36° E. The chief feeders of Lake Rukwa are the Saisi and the Rupa-Songwe.

Mafia Island lies off the coast immediately north of 8° N. It has an area of 200 sq. m. The island is low and fertile, and extensively planted with coco-nut palms. It is continued southwards by an extensive reef, on which stands the chief village, Chobe, the residence of a few Arabs and Banyan traders. Chobe stands on a shallow creek almost inaccessible to shipping.

Geology.—The narrow foot-plateau of British East Africa broadens out to the south of Bagamoyo to a width of over 100 m. This is covered to a considerable extent by rocks of recent and late Tertiary ages. Older Tertiary rocks form the bluffs of Lindi. Cretaceous marls and limestones appear at intervals, extending in places to the edge of the upper plateau, and are extensively developed on the Makonde plateau. They are underlain by Jurassic rocks, from beneath which sandstones and shales yielding *Glossopteris browniana* var. *indica*, and therefore of Lower Karroo age, appear in the south but are overlapped on the north by Jurassic strata. The central plateau consists almost entirely of metamorphic rocks with extensive tracts of granite in Nyamwezi. In the vicinity of Lakes Nyasa and Tanganyika, sandstones and shales of Lower Karroo age and yielding seams of coal are considered to owe their position and preservation to being let down by rift faults into hollows of the

crystalline rocks. In Karagwe certain quartzites, slates and schistose sandstones resemble the ancient gold-bearing rocks of South Africa.

The volcanic plateau of British East Africa extends over the boundary in the region of Kilimanjaro. Of the sister peaks, Kibo and Mawenzi, the latter is far the oldest and has been greatly denuded, while Kibo retains its crateriform shape intact. The rift-valley faults continue down the depression, marked by numerous volcanoes, in the region of the Natron Lake and Lake Manyara; while the steep walls of the deep depression of Tanganyika and Nyasa represent the western rift system at its maximum development.

Fossil remains of saurians of gigantic size have been found; one thigh bone measures 6 ft. 10 in., the same bone in the *Diplodocus Carnegii* measuring only 4 ft. 11 in.

Climate.—The warm currents setting landwards from the Indian Ocean bring both moisture and heat, so that the Swahili coast has a higher temperature and heavier rainfall than the Atlantic seaboard under the same parallels of latitude. The mean temperature on the west and east coasts of Africa is 72° and 80° Fahr. respectively, the average rainfall in Angola 36 in., in Dar-es-Salaam 60 in. On the Swahili coast the south-east monsoon begins in April and the north-east monsoon in November. In the interior April brings south-east winds, which continue until about the beginning of October. During the rest of the year changing winds prevail. These winds are charged with moisture, which they part with on ascending the precipitous side of the plateau. Rain comes with the south-east monsoon, and on the northern part of the coast the rainy season is divided into two parts, the great and the little Masika; the former falls in the month of September, October, November; the latter in February and March. In the interior the climate has a more continental character, and is subject to considerable changes of temperature; the rainy season sets in a little earlier the farther west and north the region, and is well marked, the rain beginning in November and ending in April; the rest of the year is dry. On the highest parts of the plateau the climate is almost European, the nights being sometimes exceedingly cold. Kilimanjaro has a climate of its own; the west and south sides of the mountain receive the greatest rainfall, while the east and north sides are dry nearly all the year. Malarial diseases are rather frequent, more so on the coast than farther inland. The Kilimanjaro region is said to enjoy immunity. Small-pox is frequent on the coast, but is diminishing before vaccination; other epidemic diseases are extremely rare.

Flora and Fauna.—The character of the vegetation varies with and depends on moisture, temperature and soil. On the low littoral zone the coast produced a rich tropical bush, in which the mangrove is very prominent. Coco-palms and mango trees have been planted in great numbers, and also many varieties of bananas. The bush is grouped in copses on meadows, which produce a coarse tall grass. The river banks are lined with belts of dense forest, in which useful timber occurs. The *Hyplaisena* palm is frequent, as well as various kinds of gum-producing mimosa. The slopes of the plateau which face the rain-bringing monsoon are in some places covered with primeval forest, in which timber is plentiful. The silk-cotton tree (*Bombax ceiba*), miomba, tamarisk, copal tree (*Hymenaea courbaril*) are frequent, besides sycamores, banyan trees (*Ficus indica*) and the oleb palm (*Borassus aethiops*). It is here we find the *Landolphia florida*, which yields the best rubber. The plateau is partly grass land without bush and forest, partly steppe covered with mimosa bush, which sometimes is almost impenetrable. Mount Kilimanjaro and Mount Meru exhibit on a vertical scale the various forms of vegetation which characterize East Africa (see KILIMANJARO).

East Africa is rich in all kinds of antelope, and the elephant, rhinoceros and hippopotamus are still plentiful in parts. Characteristic are the giraffe, the chimpanzee and the ostrich. Buffalo and zebras occur in two or three varieties. Lions and leopards are found throughout the country. Crocodiles are numerous in all the larger rivers. Snakes, many venomous, abound. Of birds there are comparatively few on the steppe, but by rivers, lakes and swamps they are found in thousands. Locusts occasion much damage, and ants of various kinds are often a plague. The tsetse fly (*Glossina morsitans*) infests several districts; the sand-flea has been imported from the west coast. Land and water turtles are numerous.

Inhabitants.—On the coast and at the chief settlements inland are Arab and Indian immigrants, who are merchants and agriculturists. The Swahili (*q.v.*) are a mixed Bantu and Semitic race inhabiting the seaboard. The inhabitants of the interior may be divided into two classes, those namely of Bantu and those of Hamitic stock. What may be called the indigenous population consists of the older Bantu races. These tribes have been subject to the intrusion from the south of more recent Bantu folk, such as the Yao, belonging to the Ama-Zulu branch of the race, while from the north there has been an immigration of Hamito-Negroid peoples. Of these the Masai and Wakuhi are found in the region between Victoria Nyanza and Kilimanjaro. The Masai (*q.v.*) and allied tribes are nomads and cattle raisers. They are warlike,

and live in square mud-plastered houses called *tembe* which can be easily fortified and defended. The Bantu tribes are in general peaceful agriculturists, though the Bantus of recent immigration retain the warlike instincts of the Zulus. The most important group of the Bantus is the Wanyamwezi (see WANYAMWEZI), divided into many tribes. They are spread over the central plains, and have for neighbours on the south-east, between Nyasa and the Rufiji, the warlike Wahehe. The Wangoni (Angoni), a branch of the Ama-Zulu, are widely spread over the central and Nyasa regions. Other well-known tribes are the Wasambara, who have given their name to the highlands between Kilimanjaro and the coast, and the Warundi, inhabiting the district between Tanganyika and the Kagera. In Karagwe, a region adjoining the south-west shores of Victoria Nyanza, the Bahima are the ruling caste. Formerly Karagwe under its Bahima kings was a powerful state. Many different dialects are spoken by the Bantu tribes, Swahili being the most widely known (see BANTU LANGUAGES). Their religion is the worship of spirits, ancestral and otherwise, accompanied by a vague and undefined belief in a Supreme Being, generally regarded as indifferent to the doings of the people.

The task of civilizing the natives is undertaken in various ways by the numerous Protestant and Roman Catholic missions established in the colony, and by the government. The slave trade has been abolished, and though domestic slavery is allowed, all children of slaves born after the 31st of December 1905 are free. For certain public works the Germans enforce a system of compulsory labour. Efforts are made by instruction in government and mission schools to spread a knowledge of the German language among the natives, in order to fit them for subordinate posts in administrative offices, such as the customs. Native chiefs in the interior are permitted to help in the administration of justice. The Mission du Sacré Cœur in Bagamoyo, the oldest mission in the colony, has trained many young negroes to be useful mechanics. The number of native Christians is small. The Moslems have vigorous and successful missions.

Chief Towns.—The seaports of the colony are Tanga (pop. about 6000), Bagamoyo 5000 (with surrounding district some 18,000), Dar-es-Salaam 24,000, Kilwa 5000, (these have separate notices), Pangani, Sadani, Lindi and Mikindani. Pangani (pop. about 3500) is situated at the mouth of the river of the same name; it serves a district rich in tropical products, and does a thriving trade with Zanzibar and Pemba. Sadani is a smaller port midway between Pangani and Bagamoyo. Lindi (10° 0' S., 39° 40' E.) is 80 m. north of Cape Delgado. Lindi (Swahili for The Deep Below) Bay runs inland 6 m. and is 3 m. across, affording deep anchorage. Hills to the west of the bay rise over 1000 ft. The town (pop. about 4000) is picturesquely situated on the north side of the bay. The Arab *bonia*, constructed in 1800, has been rebuilt by the Germans, who have retained the fine sculptured gateway. Formerly a rendezvous for slave caravans Lindi now has a more legitimate trade in white ivory. Mikindani is the most southern port in the colony. Owing to the prevalence of malaria there, few Europeans live at the town, and trade is almost entirely in the hands of Banyans.

Inland the principal settlements are Korogwe, Mrogoro, Kilossa, Mpapua and Tabora. Korogwe is in the Usambara hills, on the north bank of the Pangani river, and is reached by railway from Tanga. Mrogoro is some 140 m. due west of Dar-es-Salaam, and is the first important station on the road to Tanganyika. Kilossa and Mpapua are farther inland on the same caravan route. Tabora (pop. about 37,000), the chief town of the Wanyamwezi tribes, occupies an important position on the central plateau, being the meeting-place of the trade routes from Tanganyika, Victoria Nyanza and the coast. In the railway development of the colony Tabora is destined to become the central junction of lines going north, south, east and west.

On Victoria Nyanza there are various settlements. Mwanza, on the southern shore, is the lake terminus of the route from Bagamoyo; Bukoba is on the western shore, and Schirati on the eastern shore; both situated a little south of the British frontier. On the German coast of Tanganyika are Ujiji (q.v.), pop. about 14,000, occupying a central position; Usumbura, at the northern end of the lake where is a fort built by the Germans; and Bismarckburg, near the southern end. On the shores of the lake between Ujiji and Bismarckburg are four stations of the Algerian "White Fathers," all possessing churches, schools and other stone buildings. Langenburg is a settlement on the north-east side of Lake Nyasa. The government station, called New Langenburg, occupies a higher and more healthy site north-west of the lake. Wiedhafen is on the east side of Nyasa at the mouth of the Ruhuhu, and is the terminus of the caravan route from Kilwa.

Productions.—The chief wealth of the country is derived from

agriculture and the produce of the forests. From the forests are obtained rubber, copal, bark, various kinds of fibre, and timber (oak, mahogany, &c.). The cultivated products include coffee, the coconut palm, tobacco, sugar-cane, cotton, vanilla, sorghum, earth-nuts, sesame, maize, rice, beans, peas, bananas (in large quantities), yams, manioc and hemp. Animal products are ivory, hides, tortoise-shell and pearls. On the plateau large numbers of cattle, goats and sheep are reared. The natives have many small smithies. Gold, coal, iron, graphite, copper and salt have been found. Garnets are plentiful in the Lindi district, and agates, topaz, moonstone and other precious stones are found in the colony. The chief gold and iron deposits are near Victoria Nyanza. In the Mwanza district are conglomerate reefs of great extent. Mining began in 1905. Mica is mined near Mrogoro. The chief exports are sisal fibre, rubber, hides and skins, wax, ivory, copra, coffee, ground-nuts and cotton. The imports are chiefly articles of food, textiles, and metals and hardware. More than half the entire trade, both export and import, is with Zanzibar. Germany takes about 30% of the trade. In the ten years 1896-1905 the value of the external trade increased from about £600,000 to over £1,100,000. In 1907 the imports were valued at £1,190,000, the exports at £625,000.

Numerous companies are engaged in developing the resources of the country by trading, planting and mining. The most important is the *Deutsch-Ostafrikanische Gesellschaft*, founded in 1888, which has trading stations in each seaport, and flourishing plantations in various parts of the country. It is the owner of vast tracts of land. From 1890 to 1903 this company was in possession of extensive mining, railway, banking and coining rights, but in the last-named year, by agreement with the German government, it became a land company purely. The company has a right to a fifth part of the land within a zone of 10 m. on either side of any railway built in the colony previously to 1935. In addition to the companies a comparatively large number of private individuals have laid out plantations, Usambara and Pare having become favourite districts for agricultural enterprise. In the delta of the Rufiji and in the Kilwa district cotton-growing was begun in 1901. The plantations are all worked by native labour. The government possesses large forest reserves.

Communications.—Good roads for foot traffic have been made from the seaports to the trading stations on Lakes Nyasa, Tanganyika and Victoria. Caravans from Dar-es-Salaam to Tanganyika take 60 days to do the journey. The lack of more rapid means of communication hindered the development of the colony and led to economic crises (1898-1902), which were intensified, and in part created, by the building of a railway in the adjacent British protectorate from Mombasa to Victoria Nyanza, the British line securing the trade with the lake. At that time the only railway in the country was a line from Tanga to the Usambara highlands. This railway passes through Korogwe (52 m. from Tanga) and is continued via Mombo to Wilhelmstal, a farther distance of 56 m. The building of a trunk line from Dar-es-Salaam to Mrogoro (140 m.), and ultimately to Ujiji by way of Tabora, was begun in 1905. Another proposed line would run from Kilwa to Wiedhafen on Lake Nyasa. This railway would give the quickest means of access to British Central Africa and the southern part of Belgian Congo. On each of the three lakes is a government steamer. British steamers on Victoria Nyanza maintain communication between the German stations and the lake terminus of the Uganda railway. The German East Africa Line of Hamburg runs a fleet of first-class steamers to East Africa, which touch at Tanga, Dar-es-Salaam and Zanzibar. There is a submarine cable from Dar-es-Salaam to Zanzibar, and an overland line connecting all the coast stations.

Administration, Revenue, &c.—For administrative purposes the country is divided into districts (*Bezirke*), and stations (*Stationsbezirke*). Each station has a chief, who is subordinate to the official of his district, these in their turn being under the governor, who resides in Dar-es-Salaam. The governor is commander of the colonial force, which consists of natives under white officers. District councils are constituted, on which the European merchants and planters are represented. Revenue is raised by taxes on imports and exports, on licences for the sale of land and spirituous liquors, and for wood-cutting, by harbour and other dues, and a hut tax on natives. The deficiency between revenue and expenditure is met by a subsidy from the imperial government. In no case during the first twenty-one years' existence of the colony had the local revenue reached 60% of the local expenditure, which in normal years amounted to about £500,000. In 1909, however, only the expenditure necessary for military purposes (£183,500) was received by way of subsidy.

History.—Until nearly the middle of the 19th century only the coast lands of the territory now forming German East Africa were known either to Europeans or to the Arabs. When at the beginning of the 16th century the Portuguese obtained possession of the towns along the East African coast, they had been, for periods extending in some cases fully five hundred years, under Arab dominion. After the final withdrawal of the Portuguese in the early years of the 18th century, the coast towns north of Cape Delgado fell under the sway of the Muscat Arabs, passing

from them to the sultan of Zanzibar. From about 1830, or a little earlier, the Zanzibar Arabs began to penetrate inland, and by 1850 had established themselves at Ujiji on the eastern shore of Lake Tanganyika. The Arabs also made their way south to Nyasa. This extension of Arab influence was accompanied by vague claims on the part of the sultan of Zanzibar to include all these newly opened countries in his empire. How far from the coast the real authority of the sultan extended was never demonstrated. Zanzibar at this time was in semi-dependence on India, and British influence was strong at the court of Bargash, who succeeded to the sultanate in 1870. Bargash in 1877 offered to Sir (then Mr) William Mackinnon a lease of all his mainland territory. The offer, made in the year in which H. M. Stanley's discovery of the course of the Congo initiated the movement for the partition of the continent, was declined. British influence was, however, still so powerful in Zanzibar that the agents of the German Colonization Society, who in 1884 sought to secure for their country territory on the east coast, deemed it prudent to act secretly, so that both Great Britain and Zanzibar might be confronted with accomplished facts. Making their way inland, three young Germans, Karl Peters, Joachim Count Pfeil and Dr Jühlke, concluded a "treaty" in November 1884 with a chieftain in Usambara who was declared to be independent of Zanzibar. Other treaties followed, and on the 17th of February 1885, the German emperor granted a charter of protection to the Colonization Society. The German acquisitions were resented by Zanzibar, but were acquiesced in by the British government (the second Gladstone administration). The sultan was forced to acknowledge their validity, and to grant a German company a lease of his mainland territories south of the mouth of the Umba river, a British company formed by Mackinnon taking a lease of the territories north of that point. The story of the negotiations between Great Britain, Germany and France which led to this result is told elsewhere (see AFRICA, section 5). By the agreement of the 1st of July 1890, between the British and German governments, and by agreements concluded between Germany and Portugal in 1886 and 1894, and Germany and the Congo Free State in 1884 and later dates, the German sphere of influence attained its present area. On the 28th of October 1890 the sultan of Zanzibar ceded absolutely to Germany the mainland territories already leased to a German company, receiving as compensation £200,000.

While these negotiations were going on, various German companies had set to work to exploit the country, and on the 16th of August 1888 the German East African Company, the lessee of the Zanzibar mainland strip, took over the administration from the Arabs. This was followed, five days later, by a revolt of all the coast Arabs against German rule—the Germans, raw hands at the task of managing Orientals, having aroused intense hostility by their brusque treatment of the dispossessed rulers. The company being unable to quell the revolt, Captain Hermann Wissmann—subsequently Major Hermann von Wissmann (1853-1905)—was sent out by Prince Bismarck as imperial commissioner. Wissmann, with 1000 soldiers, chiefly Sudanese officered by Germans, and a German naval contingent, succeeded by the end of 1889 in crushing the power of the Arabs. Wissmann remained in the country until 1891 as commissioner, and later (1895-1896) was for eighteen months governor of the colony—as the German sphere had been constituted by proclamation (1st of January 1897). Towards the native population Wissmann's attitude was conciliatory, and under his rule the development of the resources of the country was pushed on. Equal success did not attend the efforts of other administrators; in 1891-1892 Karl Peters had great trouble with the tribes in the Kilimanjaro district and resorted to very harsh methods, such as the execution of women, to maintain his authority. In 1896 Peters was condemned by a disciplinary court for a misuse of official power, and lost his commission. After 1891, in which year the Wabeche tribe ambushed and almost completely annihilated a German military force of 350 men under Baron von Zelewski, there were for many years no serious risings against German authority, which by the end of 1898 had been

established over almost the whole of the hinterland. The development of the country was, however, slow, due in part to the disinclination of the Reichstag to vote supplies sufficient for the building of railways to the fertile lake regions. Count von Götzen (governor 1901-1906) adopted the policy of maintaining the authority of native rulers as far as possible, but as over the greater part of the colony the natives have no political organizations of any size, the chief burden of government rests on the German authorities. In August 1905 serious disturbances broke out among the Bantu tribes in the colony. The revolt was due largely to resentment against the restrictions enforced by the Germans in their efforts at civilization, including compulsory work on European plantations in certain districts. Moreover, it is stated that the Herero in rebellion in German South-west Africa sent word to the east coast natives to follow their example, an instance of the growing solidarity of the black races of Africa. Though the revolt spread over a very large area, the chief centre of disturbance was the region between Nyasa and the coast at Kilwa and Lindi. Besides a number of settlers a Roman Catholic bishop and a party of four missionaries and nuns were murdered in the Kilwa hinterland, while nearer Nyasa the warlike Wangoni held possession of the country. The Germans raised levies of Masai and Sudanese, and brought natives from New Guinea to help in suppressing the rising, besides sending naval and military contingents from Germany. In general, the natives, when encountered, were easily dispersed, but it was not until March 1906 that the coast regions were again quiet. In July following the Wangoni were beaten in a decisive engagement. It was officially stated that the death-roll for the whole war was not below 120,000 men, women and children. In 1907 a visit was paid to the colony by Herr B. Dernburg, the colonial secretary. As a result of this visit more humane methods in the treatment of the natives were introduced, and measures taken to develop more fully the economic resources of the country.

AUTHORITIES.—S. Passarge and others, *Das deutsche Kolonialreich*, Erster Band (Leipzig, 1909); P. Reichard, *Deutsch Ostafrika, das Land und seine Bewohner* (Leipzig, 1892); F. Stuhlmann, *Mit Emin Pasha im Herzen von Afrika* (Berlin, 1894); Brix Foerster, *Deutsch-Ostafrika; Geographie und Geschichte* (Leipzig, 1890); Oscar Baumann, *In Deutsch-Ostafrika während des Aufstandes* (Vienna, 1890); *Usambara und seine Nachbargebiete* (Berlin, 1891), and *Durch Massailand zur Nilquelle* (Berlin, 1894). For special studies see P. Samassa, *Die Besiedelung Deutsch-Ostafrikas* (Leipzig, 1909); A. Engler, *Die Pflanzenwelt Ost-Afrikas und der Nachbargebiete* (Berlin, 1895-1896) and other works by the same author; Stromer von Reichenbach, *Die Geologie der deutschen Schutzgebiete in Afrika* (Munich and Leipzig, 1896); W. Bornhardt, *Deutsch-Ostafrika* (Berlin, 1898); F. Fullerton, *Beiträge zur physischen Anthropologie der Nord-Nyassaländer* (Berlin, 1902), a fine series of pictures of native types, and *Das Deutsche Nyassa- und Ruwuma-gebiet, Land und Leute* (Berlin, 1906); K. Weule, *Native Life in East Africa* (London, 1909); Hans Meyer, *Der Kilimanjaro* (Berlin, 1900) and *Die Eisenbahnen im tropischen Afrika* (Leipzig, 1902); J. Strandes, *Die Portugiesenszeit von Deutsch- u. Englisch-Ostafrika* (Berlin, 1899), a valuable monograph on the Portuguese period. See also British Official Reports on East Africa (especially No. 4221 ann. ser.), the German White Books and annual reports, the *Mitteilungen aus den deutschen Schutzgebieten*, and the *Deutsches Kolonialblatt*, published fortnightly at Berlin since 1890. The *Deutscher Kolonial-Atlas* has maps on the 1:1,000,000 scale. (F. R. C.)

GERMAN EVANGELICAL SYNOD OF NORTH AMERICA, a Protestant church dating from October 1840, and known, in its early years, as the German Evangelical Association of the West. It was formed by six German ministers who had been ordained in Prussia and were engaged in missionary and pioneer work in Missouri and Illinois. The original organization was strengthened in 1858 by amalgamation with the German Evangelical Church Association of Ohio, and later by the inclusion of the German United Evangelical Synod of the East (1866), the Evangelical Synod of the North-West (1872) and the United Evangelical Synod of the East (1872). The church bases its position on the Bible as interpreted by the symbols of the Lutheran and Reformed churches so far as they are in agreement, points of difference being left to "that liberty of conscience which, as a component part of the basis of man's ultimate

responsibility to God himself, is the inalienable privilege of every believer." The church, which has (1000) 985 ministers and some 238,000 communicant members, is divided into seventeen districts, with officers responsible to the General Synod, which meets every four years. There are boards for home and foreign missions, the latter operating chiefly in the Central Provinces of India. The literature of the church is mainly in German, though English is rapidly gaining ground.

GERMANIC LAWS, EARLY. Of those Germanic laws of the early middle ages which are known as *leges barbarorum*, we here deal with the principal examples other than Frankish, viz. (1) *Leges Wisigothorum*, (2) *Lex Burgundionum*, (3) *Pactus Alamannorum* and *Lex Alamannorum*, (4) *Lex Bajuvariorum*, (5) *Lex Saxonum*, (6) *Lex Frisionum*, (7) *Lex Anglorum et Werinorum, hoc est, Thuringorum*, and (8) *Leges Langobardorum*. All these laws may in general be described as codes of procedure and tariffs of compositions. They present somewhat similar features with the Salic law, but often differ from it in the date of compilation, the amount of fines, the number and nature of the crimes, the number, rank, duties and titles of the officers, &c. For the Salic law and other Frankish laws, see SALIC LAW, and for the edict of Theodoric I., which was applicable to the Ostrogoths and Romans, see ROMAN LAW.

For the whole body of the Germanic laws see P. Canciani, *Barbarorum leges antiquae* (Venice, 1781-1780); F. Walter, *Corpus juris germanici antiqui* (Berlin, 1824); *Monumenta Germaniae historica, Leges*. For further information on the codes in general, see H. M. Zöpfl, *Deutsche Rechtsgeschichte* (4th ed., Heidelberg, 1871-1876); J. E. O. Stobbe, *Geschichte der deutschen Rechtsquellen* (Brunswick, 1860-1864); Paul Viollet, *Histoire du droit civil français* (2nd ed., Paris, 1893); H. Brunner, *Deutsche Rechtsgeschichte* (2nd ed., Leipzig, 1906).

1. *Leges Wisigothorum*.—Karl Zeumer's edition of these laws in the 410 series of the *Mon. Germ. Hist.* throws new light on all questions relating to their date and composition. It is now certain that the earliest written code of the Visigoths dates back to King Euric (466-485). Besides his own constitutions, Euric included in this collection constitutions of his predecessors, Theodoric I. (419-451), Thorismund (451-453), and Theodoric II. (453-466), and he arranged the whole in a logical order. Of this code fragments of chapters cclxxvi. to cccxxvi.¹ have been discovered in a palimpsest MS. in the Bibliothèque Nationale at Paris (Latin coll. No. 12161), a fact which proves that the code ran over a large area. Euric's code was used for all cases between Goths, and between them and Romans; in cases between Romans, Roman law was used. At the instance of Euric's son, Alaric II., an examination was made of the Roman laws in use among Romans in his dominions, and the resulting compilation was approved in 506 at an assembly at Aire, in Gascony, and is known as the Breviary of Alaric, and sometimes as the *Liber Aniani*, from the fact that the authentic copies bear the signature of the *referendarius* Anian.

Euric's code remained in force among the Visigoths of Spain until the reign of Leovigild (568-586), who made a new one, improving upon that of his predecessor. This work is lost, and we have no direct knowledge of any fragment of it. In the 3rd codification, however, many provisions have been taken from the 2nd, and these are designated by the word "*antiqua*"; by means of these "*antiqua*" we are enabled in a certain measure to reconstruct the work of Leovigild.

After the reign of Leovigild the legislation of the Visigoths underwent a transformation. The new laws made by the kings were declared to be applicable to all the subjects in the kingdom, of whatever race—in other words, they became territorial; and this principle of territoriality was gradually extended to the ancient code. Moreover, the conversion of Reccared I. (586-601) to orthodoxy effaced the religious differences among his subjects, and all subjects, *qua* Christians, had to submit to the canons of the councils, which were made obligatory by the kings. After this change had been accepted, Recceswinth (649-672) made a new code, which was applicable to Visigoths and Romans alike. This code, known as the *Liber iudiciorum*, is

¹ The lacunae in these fragments have been filled in by the aid of the law of the Bavarians, where the chief provisions are reproduced.

divided into 12 books, which are subdivided into *tituli* and chapters (*aeræ*): It comprises 324 constitutions taken from Leovigild's collection, a few of the laws of Reccared and Sisebut, 99 laws of Chindaswinth (642-653), and 87 of Recceswinth. A recension of this code of Recceswinth was made in 681 by King Erwig (680-687), and is known as the *Lex Wisigothorum renovata*; and, finally, some additamenta were made by Egica (687-702). In Zeumer's edition of the *Leges Wisigothorum* the versions of Recceswinth and Erwig, where they differ from each other, are shown in parallel columns, and the laws later than Erwig are denoted by the sign "*nov.*"

For further information see the preface to Zeumer's edition; H. Brunner, *Deutsche Rechtsgeschichte* (2nd ed., Leipzig, 1906); Ureña y Smenyau, *La Legislación Gótica-hispánica* (Madrid, 1905).

2. *Lex Burgundionum*.—This code was compiled by King Gundobald (474-516), very probably after his defeat by Clovis in 500. Some additamenta were subsequently introduced either by Gundobald himself or by his son Sigismund. This law bears the title of *Liber Constitutionum*, which shows that it emanated from the king; it is also known as the *Lex Gundobada* or *Lex Gombata*. It was used for cases between Burgundians, but was also applicable to cases between Burgundians and Romans. For cases between Romans, however, Gundobald compiled the *Lex Romana Burgundionum*, called sometimes, through a misreading of the MSS., the *Liber Papiani* or simply *Papianus*. The barbarian law of the Burgundians shows strong traces of Roman influence. It recognizes the will and attaches great importance to written deeds, but on the other hand sanctions the judicial duel and the *cojuratores* (sworn witnesses). The vehement protest made in the 9th century by Agobard, bishop of Lyons, against the *Lex Gundobada* shows that it was still in use at that period. So late as the 10th and even the 11th centuries we find the law of the Burgundians invoked as personal law in Cluny charters, but doubtless these passages refer to accretions of local customs rather than to actual paragraphs of the ancient code.

The text of the *Lex Burgundionum* has been published by F. Blühme in the *Mon. Germ. hist., Leges*, iii. 525; by Karl Binding in the *Foixes rerum Bernensium* (vol. i. 1880); by J. E. Valentin Smith (Paris, 1880 seq.); and by von Salis (1892) in the 410 series of the *Mon. Germ. hist.* Cf. R. Darest, "La Loi Gombette," in the *Journal des savants* (July 1891).

3. *Pactus Alamannorum* and *Lex Alamannorum*.—Of the laws of the Alamanni, who dwelt between the Rhine and the Lech, and spread over Alsace and what is now Switzerland to the south of Lake Constance, we possess two different texts. The earlier text, of which five short fragments have come down to us, is known as the *Pactus Alamannorum*, and from the persistent recurrence of the expression "*et sic conventi*" was most probably drawn up by an official commission. The reference to *affranchisement in ecclesia* shows that it was composed at a period subsequent to the conversion of the Alamanni to Christianity. There is no doubt that the text dates back to the reign of Dagobert I., i.e. to the first half of the 7th century. The later text, known as the *Lex Alamannorum*, dates from a period when Alamannia was independent under national dukes, but recognized the theoretical suzerainty of the Frankish kings. There seems no reason to doubt the St. Gall MS., which states that the law had its origin in an agreement between the great Alamannic lords and Duke Landfrid, who ruled the duchy from 700 to 730. The two texts have been published by J. Merkel in the *Mon. Germ. hist., Leges*, iii., and by Karl Lehmann in the 410 series of the same collection.

4. *Lex Bajuvariorum*.—We possess an important law of the Bavarians, whose duchy was situated in the region east of the Lech, and was an outpost of Germany against the Huns, known later as Avars. Parts of this law have been taken directly from the Visigothic law of Euric and from the law of the Alamanni. The Bavarian law, therefore, is later than that of the Alamanni. It dates unquestionably from a period when the Frankish authority was very strong in Bavaria, when the dukes were vassals of the Frankish kings. Immediately after the revolt of Bavaria in 743 the Bavarian duke Odilo was forced to submit to Pippin and Carloman, the sons of Charles Martel, and

recognize the Frankish suzerainty. About the same period, too, the church of Bavaria was organized by St Boniface, and the country divided into several bishoprics; and we find frequent references to these bishops (in the plural) in the law of the Bavarians. On the other hand, we know that the law is anterior to the reign of Duke Tassilo III. (740-788). The date of compilation must, therefore, be placed between 743 and 749.

There is an edition of the *Lex Bajuvariorum* by J. Merkel in the *Mon. Germ. hist., Leges*, iii. 183, and another was undertaken by E. von Schwind for the 4th series of the same collection. Cf. von Schwind's article in the *Neues Archiv*, vol. xxxd.

5. *Lex Saxonum*.—Germany comprised two other duchies, Saxony and Frisia, of each of which we possess a text of law. The *Lex Saxonum* has come down to us in two MSS. and two old editions (those of B. J. Herold and du Tillet), and the text has been edited by Karl von Richthofen in the *Mon. Germ. hist., Leges*, v. The law contains ancient customary enactments of Saxony, and, in the form in which it has reached us, is later than the conquest of Saxony by Charlemagne. It is preceded by two capitularies of Charlemagne for Saxony—the *Capitulatio de partibus Saxonie* (A. Boretius i. 68), which dates undoubtedly from 782, and is characterized by great severity, death being the penalty for every offence against the Christian religion; and the *Capitulare Saxonicum* (A. Boretius i. 71), of the 28th of October 797, in which Charlemagne shows less brutality and pronounces simple compositions for misdeeds which formerly entailed death. The *Lex Saxonum* apparently dates from 803, since it contains provisions which are in the *Capitulare legi Ribuarie additum* of that year. The law established the ancient customs, at the same time eliminating anything that was contrary to the spirit of Christianity; it proclaimed the peace of the churches, whose possessions it guaranteed and whose right of asylum it recognized.

6. *Lex Frisionum*.—This consists of a medley of documents of the most heterogeneous character. Some of its enactments are purely pagan—thus one paragraph allows the mother to kill her new-born child, and another prescribes the immolation to the gods of the defiler of their temple; others are purely Christian, such as those which prohibit incestuous marriages and working on Sunday. The law abounds in contradictions and repetitions, and the compositions are calculated in different moneys. From this it would appear that the documents were merely materials collected from various sources and possibly with a view to the compilation of a homogeneous law. These materials were apparently brought together at the beginning of the 9th century, at a time of intense legislative activity at the court of Charlemagne.

There are no MSS. of the document extant; our knowledge of it is based upon B. J. Herold's edition (*Originum ac Germanicarum antiquitatum libri*, Basel, 1557), which has been reproduced by Karl von Richthofen in the *Mon. Germ. hist., Leges*, iii. 631.

7. *Lex Angliorum et Werinorum, hoc est, Thuringorum*.—In early times there dwelt in Thuringia, south of the river Unstrut, the Angli, who gave their name to the *pagus Engili*, and to the east, between the Saale and the Elster, the Warni (Werini, or Varini), whose name is seen in Wernefeld. In the 9th century, however, this region (then called Werenefeld) was occupied by the Sorabi, and the Warni and Angli either coalesced with the Thuringi or sought an asylum in the north of Germany. A collection of laws has come down to us bearing the name of these two peoples, the *Lex Angliorum et Werinorum, hoc est, Thuringorum*. This text is a collection of local customs arranged in the same order as the law of the Ripuarians. Parts of it are based on the *Capitulare legi Ribuarie additum* of 803, and it seems to have been drawn up in the same conditions and circumstances as the law of the Saxons. There is an edition of this code by Karl von Richthofen in the *Mon. Germ. hist., Leges*, v. 103. The old opinion that the law originated in south Holland is entirely without foundation.

8. *Leges Langobardorum*.—We possess a fair amount of information on the origin of the last barbarian code, the laws of the Lombards. The first part, consisting of 388 chapters, is known as the *Edictus Langobardorum*, and was promulgated by King Rothar at a diet held at Pavia on the 22nd of November 643. This work, composed at one time and arranged on a

systematic plan, is very remarkable. The compilers knew Roman law, but drew upon it only for their method of presentation and for their terminology; and the document presents Germanic law in its purity. Rothar's edict was augmented by his successors: Grimoald (668) added nine chapters; Liutprand (713-735), fifteen volumes, containing a great number of ecclesiastical enactments; Ratchis (746), eight chapters; and Aistulf (755), thirteen chapters. After the union of the Lombards to the Frankish kingdom, the capitularies made for the entire kingdom were applicable to Italy. There were also special capitularies for Italy, called *Capitula Italica*, some of which were appended to the edict of Rothar.

At an early date compilations were formed in Italy for the use of legal practitioners and jurists. Eberhard, duke and margrave of Rhaetia and Friuli, arranged the contents of the edict with its successive additamenta into a *Concordia de singulis censis* (829-832). In the 10th century a collection was made of the capitularies in use in Italy, and this was known as the *Capitulare Langobardorum*. Then appeared, under the influence of the school of law at Pavia, the *Liber legis Langobardorum*, also called *Liber Papiensis* (beginning of 11th century), and the *Lombarda* (end of 11th century) in two forms—that given in a Monte Cassino MS. and known as the *Lombarda Casinensis*, and the *Lombarda Vulgata*.

There are editions of the *Edictus*, the *Concordia*, and the *Liber Papiensis* by F. Bluhme and A. Boretius in the *Mon. Germ. hist., Leges*, iv. Bluhme also gives the rubrics of the *Lombarda*, which were published by F. Lindenberg in his *Codex legum antiquarum* in 1613. For further information on the laws of the Lombards see J. Merkel, *Geschichte des Langobardenrechts* (1850); A. Boretius, *Die Kapitularien im Langobardenreich* (1864); and C. Kier, *Edictus Rotari* (Copenhagen, 1898). Cf. R. Dareste in the *Nouvelle Revue historique de droit français et étranger* (1900, p. 143). (C. Fr.)

GERMANICUS CAESAR (15 B.C.—A.D. 19), a Roman general and provincial governor in the reign of Tiberius. The name Germanicus, the only one by which he is known in history, he inherited from his father, Nero Claudius Drusus, the famous general, brother of Tiberius and stepson of Augustus. His mother was the younger Antonia, daughter of Marcus Antonius and niece of Augustus, and he married Agrippina, the granddaughter of the same emperor. It was natural, therefore, that he should be regarded as a candidate for the purple. Augustus, it would seem, long hesitated whether he should name him as his successor, and as a compromise required his uncle Tiberius to adopt him, though Tiberius had a son of his own. Of his early years and education little is known. That he possessed considerable literary abilities, and that these were carefully trained, we gather, both from the speeches which Tacitus puts into his mouth, and from the reputation he left as an orator, as attested by Suetonius and Ovid, and from the extant fragments of his works.

At the age of twenty he served his apprenticeship as a soldier under Tiberius, and was rewarded with the triumphal insignia for his services in crushing the revolt in Dalmatia and Pannonia. In A.D. 11 he accompanied Tiberius in his campaign on the Rhine, undertaken, in consequence of the deicait of Varus, with the object of securing the German frontier. In 12 he was made consul, and increased his popularity by appearing as an advocate in the courts of justice, and by the celebration of brilliant games. Soon afterwards he was appointed by Augustus to the important command of the eight legions on the Rhine. The news of the emperor's death (14) found Germanicus at Lugdunum (Lyons), where he was superintending the census of Gaul. Close upon this came the report that a mutiny had broken out among his legions on the lower Rhine. Germanicus hurried back to the camp, which was now in open insurrection. The tumult was with difficulty quelled, partly by well-timed concessions, for which the authority of the emperor was forged, but chiefly owing to his personal popularity. Some of the insurgents actually proposed that he should put himself at their head and secure the empire for himself, but their offer was rejected with indignation. In order to calm the excitement Germanicus determined at once on an active campaign. Crossing the Rhine, he attacked and routed the Marsi, and laid waste the valley of the Ems

In the following year he marched against Arminius, the conqueror of Varus, and performed the last rites over the remains of the Roman soldiers that still lay there unburied, erecting a barrow to mark the spot. Arminius, however, favoured by the marshy ground, was able to hold his own, and it required another campaign before he was finally defeated. A masterly combined movement by land and water enabled Germanicus to concentrate his forces against the main body of the Germans encamped on the Weser, and to crush them in two obstinately contested battles. A monument erected on the field proclaimed that the army of Tiberius had conquered every tribe between the Rhine and the Elbe. Great, however, as the success of the Roman arms had been, it was not such as to justify this boastful inscription; we read of renewed attacks from the barbarians, and plans of a fourth campaign for the next summer.

But the success of Germanicus had already stirred the jealousy and fears of Tiberius, and he was reluctantly compelled to return to Rome. On the 26th of May 17 he celebrated a triumph. The enthusiasm with which he was welcomed, not only by the populace, but by the emperor's own praetorians, was so great that the earliest pretext was seized to remove him from the capital. He was sent to the East with extraordinary powers to settle a disputed succession in Parthia and Armenia. At the same time Gnaeus Calpurnius Piso, one of the most violent and ambitious of the old nobility, was sent as governor of Syria to watch his movements. Germanicus proceeded by easy stages to his province, halting on his way in Dalmatia, and visiting the battlefield of Actium, Athens, Ilium, and other places of historic interest. At Rhodes he met his coadjutor Piso, who was seeking everywhere to thwart and malign him. When at last he reached his destination, he found little difficulty in effecting the settlement of the disturbed provinces, notwithstanding Piso's violent and persistent opposition. At Artaxata Zeno, the popular candidate for the throne, was crowned king of Armenia. To the provinces of Cappadocia and Commagene Roman governors were assigned; Parthia was conciliated by the banishment of the dethroned king Vonones.

After wintering in Syria Germanicus started for a tour in Egypt. The chief motive for his journey was love of travel and antiquarian study, and it seems never to have occurred to him, till he was warned by Tiberius, that he was thereby transgressing an unwritten law which forbade any Roman of rank to set foot in Egypt without express permission. On his return to Syria he found that all his arrangements had been upset by Piso. Violent recriminations followed, the result of which, it would seem, was a promise on the part of Piso to quit the province. But at this juncture Germanicus was suddenly attacked at Epidaphne near Antioch by a violent illness, which he himself and his friends attributed to poison administered by Plancina, the wife of Piso, at the instigation of Tiberius. Whether these suspicions were true is open to question; it seems more probable that his death was due to natural causes. His ashes were brought to Rome in the following year (20) by his wife Agrippina, and deposited in the grave of Augustus. He had nine children, six of whom, three sons and three daughters, survived him, amongst them the future emperor Gaius and the notorious Agrippina, the mother of Nero. The news of his death cast a gloom over the whole empire. Nor was Germanicus unworthy of this passionate devotion. He had wiped out a great national disgrace; he had quelled the most formidable foe of Rome. His private life had been stainless, and he possessed a singularly attractive personality. Yet there were elements of weakness in his character which his short life only half revealed: an impetuosity which made him twice threaten to take his own life; a superstitious vein which impelled him to consult oracles and shrink from bad omens; an amiable dilettantism which led him to travel in Egypt while his enemy was plotting his ruin; a want of nerve and resolution which prevented him from coming to an open rupture with Piso till it was too late.

He possessed considerable literary abilities; his speeches and Greek comedies were highly spoken of by his contemporaries. But the only specimen of his work that has come down to us is

the translation in Latin hexameters (generally attributed to him, although some consider Domitian the author), together with scholia, of the *Phaenomena* of Aratus, which is superior to those of Cicero and Avienus (best edition by A. Breyssig, 1867; 1899, without the scholia). A few extant Greek and Latin epigrams also bear the name Germanicus.

In addition to monographs by A. Zingerle (Trent, 1867) and A. Breyssig (Erfurt, 1892), there are treatises on the German campaigns by E. von Wietersheim (1850), P. Höfer (1884), F. Knoke (1887, 1889), W. Fricke (1890), A. Tarantelli (1891), Dahm (1902).

See Tacitus, *Annals*, i-iv. (ed. Furneaux); Suetonius, *Augustus*, *Tiberius*; J. C. Tarver, *Tiberius* (1902); Merivale, *Hist. of the Romans under the Empire*, chs. 42, 43; H. Schiller, *Geschichte der römischen Kaiserzeit*, i. 1 (1883), pp. 227, 258, 261-266, 270-276; M. Schanz, *Geschichte der römischen Literatur*, pt. ii. (2nd ed., 1901), and Teuffel-Schwabe, *Hist. of Roman Literature* (Eng. tr., 1900), 275.

GERMANIUM (symbol Ge, atomic weight 72.5); one of the metallic elements included in the same natural family as carbon, silicon, tin and lead. It was discovered in 1886 by C. Winkler in argyrodite, a mineral found at Freiberg in Saxony. On examination of the metal and its salts it was shown to be identical with the hypothetical element *ekasilicon*, whose properties had been predicted by D. Mendeléeff many years previously. The element is of extremely rare occurrence, being met with only in argyrodite and, to a very small extent, in euxenite. It may be obtained from argyrodite by heating the mineral in a current of hydrogen; or by heating the dioxide to redness with carbon. It forms grey coloured octahedra of specific gravity 5.496 at 20° C., melting at 900° C.; it burns at a red heat, is insoluble in hydrochloric acid, but dissolves in *aqua regia*, and is also soluble in molten alkalis. Two oxides of germanium are known, the *dioxide*, GeO₂, being obtained by roasting the sulphide and treatment with nitric acid. It is a white powder, very slightly soluble in water, and possesses acid properties. By heating with a small quantity of magnesium it is converted into *germanious oxide*, GeO. By heating the metal with chlorine, *germanic chloride*, GeCl₄, is obtained as a colourless fuming liquid boiling at 86.87° C., it is decomposed by water forming a hydrated germanium dioxide. *Germanium dichloride*, GeCl₃, and *germanium chloroform*, GeHCl₃, have also been described.

Germanium compounds on fusion with alkaline carbonates and sulphur form salts known as *thiogermanates*. If excess of a mineral acid be added to a solution of an alkaline thiogermanate a white precipitate of *germanium disulphide*, GeS₂, is obtained. It can also be obtained by passing sulphuretted hydrogen through a solution of the dioxide in hydrochloric acid. It is appreciably soluble in water, and also in solutions of the caustic alkalis and alkaline sulphides. By heating the disulphide in a current of hydrogen, *germanious sulphide*, GeS, is formed. It sublimes in thin plates of a dark colour and metallic lustre, and is soluble in solutions of the caustic alkalis. Alkyl compounds of germanium such as *germanium tetra-ethyl*, Ge(C₂H₅)₄, a liquid boiling at 160° C., have been obtained. The germanium salts are most readily recognized by the white precipitate of the disulphide, formed in acid solutions, on passing sulphuretted hydrogen. The atomic weight of the element was determined by C. Winkler by analysis of the pure chloride GeCl₄, the value obtained being 72.32, whilst Lecoq de Boisbaudran (*Comptes rendus*, 1886, 103, 452), by a comparison of the lines in the spark spectrum of the element, deduced the value 72.3.

GERMAN LANGUAGE. Together with English and Frisian, the German language forms part of the West Germanic group of languages. To this group belongs also Langobardian, a dialect which died out in the 9th or 10th century, while Burgundian, traces of which are not met with later than the 5th century, is usually classed with the East Germanic group. Both these tongues were at an early stage crushed out by Romance dialects, a fate which also overtook the idiom of the Western Franks, who, in the so-called *Strassburg Oaths*¹ of 842, use the Romance tongue, and are addressed in that tongue by Louis the German.

Leaving English and Frisian aside, we understand by *Deutsche* ¹K. Müllenhoff and W. Scherer, *Denkmäler deutscher Poesie und Prosa*, 3rd ed., by E. Steinmeyer, 1892, No. lxvii.

Sprache the language of those West Germanic tribes, who, at their earliest appearance in history, spoke a Germanic tongue, and still speak it at the present day. The chief of these tribes are: the Saxons, the Franks (but with the restriction noted above), the Chatti (Hessians), Thuringians, Alemannians and Bavarians. This definition naturally includes the languages spoken in the Low Countries, Flemish and Dutch, which are offsprings of the Low Franconian dialect, mixed with Frisian and Saxon elements; but, as the literary development of these languages has been in its later stages entirely independent of that of the German language, they are excluded from the present survey.

The German language, which is spoken by about seventy-one millions, and consequently occupies in this respect the third place among European languages, borders, in the west and south, on Romance languages (French, Italian), and also to some extent on Slavonic. On Italian and Slovenian territory there are several German-speaking "islands," notably the Sette and Tredici Comuni, east and north-east of the Lake of Garda, and the "Gottschee Ländchen" to the south of Laibach. The former of these is, however, on the point of dying out. Neighbours on the east, where the boundary line runs by no means as straight as on the west or south, are the Magyars and again Slavonic races. Here, too, there are numerous "islands" on Hungarian and Slavonic territory. Danes and Frisians join hands with the Germans in the north.¹

In the west and south the German language has, compared with its status in earlier periods, undoubtedly lost ground, having been encroached upon by Romance tongues. This is the case in French Flanders, in Alsace and Lorraine, at any rate before the war of 1870, in the valleys south of Monte Rosa and in southern Tirol; in Styria and Carinthia the encroachment is less marked, but quite perceptible. On the east, on the other hand, German steadily spread from the days of Charles the Great down to recent times, when it has again lost considerable ground in Bohemia, Moravia and Livonia. At the time of Charles the Great the eastern frontier extended very little beyond the lower Elbe, following this river beyond Magdeburg, whence it passed over to the Saale, the Bohemian forest and the river Enns (cf. the map in F. Dahn, *Urgeschichte der germanischen und romanischen Völker*, vol. iii.). Partly as a result of victories gained by the Germans over the Avars and Slavs, partly owing to peaceful colonization, the eastern boundary was pushed forward in subsequent centuries; Bohemia was in this way won for the German tongue by German colonists in the 13th century, Silesia even a little earlier; in Livonia German gained the upper hand during the 13th century, while about the same time the country of the Prussians was conquered and colonized by the knights of the Teutonic order. The dialect which these colonists and knights introduced bore the Middle German character; and this, in various modifications, combined with Low German and even Dutch elements, formed the German spoken in these newly-won territories. In the north (Schleswig), where at the time of Charles the Great the river Eider formed the linguistic boundary, German has gained and is still gaining on Danish.

Before considering the development of the language spoken within these boundaries, a word of explanation is perhaps necessary with regard to the word *deutsch*. As applied to the language, *deutsch* first appears in the Latin form *theotiscus*, *lingua theotisca*, *teutisca*, in certain Latin writings of the 8th and 9th centuries, whereas the original Old High German word *thiudisc*, *tiutisc* (from *thiot*, *diot*, "people," and the suffix *-isc*) signified only "appertaining to the people," "in the manner of the people." Cf. also Gothic *þiudisko* as a translation of *ἠθικῶς* (Gal. ii. 14). It, therefore, seems probable that if the application of the word to the language (*lingua theotisca*) was not exactly an invention of Latin authors of German nationality, its use in this sense was at least encouraged by them in order to

distinguish their own vernacular (*lingua vulgaris*) from Latin as well as from the *lingua romana*.²

In the 8th and 9th centuries German or "Deutsch" first appears as a written language in the dialects of Old High German and Old Low German. Of an "Urdeutsch" or primitive German, i.e. the common language from which these sharply distinguished dialects of the earliest historical period must have developed, we have no record; we can only infer its character—and it was itself certainly not free from dialectic variations—by a study of the above-named and other Germanic dialects. It is usual to divide the history of the German language from this earliest period, when it appears only in the form of proper names and isolated words as glosses to a Latin text, down to the present day, into three great sections: (1) Old High German (*Althochdeutsch*) and Old Low German (Old Saxon; *Altniederdeutsch*, *Altsächsisch*); (2) Middle High German (*Mittelhochdeutsch*) and Middle Low German (*Mittelniederdeutsch*); and (3) Modern High German and Modern Low German (*Neuhochdeutsch* and *Nenniederdeutsch*). It is more difficult to determine the duration of the different periods, for it is obvious that the transition from one stage of a language to another takes place slowly and gradually.

The first or Old High German period is commonly regarded as extending to about the year 1100. The principal characteristic of the change from Old High German to Middle High German is the weakening of the unaccented vowels in final syllables (cf. O.H.G. *tagō*, *gesti*, *geban*, *gābum* and M.H.G. *tagē*, *geste*, *geben*, *gāben*). But it must be remembered that this process began tentatively as early as the 10th century in Low German, and also that long, unaccented vowels are preserved in the Alemannic dialect as late as the 14th century and even later. Opinion is more at variance with regard to the division between the second and third periods. Some would date Modern High German from the time of Luther, that is to say, from about 1500. But it must be noted that certain characteristics attributed to the Modern German vowel system, such as lengthening of Middle High German short vowels, the change from Middle High German *i*, *ē*, *iu* to Modern High German *ei*, *au*, *eu* (*eu*), of Middle High German *ie*, *uo*, *üe* to Modern High German *i*, *ä*, *ö*, made their appearance long before 1500. Taking this fact into consideration, others distinguish a period of classical Middle High German extending to about 1250, and a period of transition (sometimes called *Frühneuhochdeutsch*, or Early Modern High German) from 1250 to 1650. The principal characteristics of Modern High German would then consist in a greater stability of the grammatical and syntactical rules, due to the efforts of earlier grammarians, such as Schottelius, Gottsched and others, and the substitution of a single vowel sound for the varying vowels of the singular and plural of the preterite of strong verbs (cf. Middle High German *schreib*, *scriben*, and Modern High German *schrieb*, *schrieben*, &c.). The much debated question of the origins of Modern High German has been recently reopened by O. Behaghel (*Geschichte der deutschen Sprache*, i.c. 561), who hopes that a more satisfactory solution may be arrived at by the study of certain syntactical peculiarities to be seen in the dialects of more recent periods.

As the middle ages did not produce a German *Schriftsprache* or literary language in the modern sense of the word, which—as is undoubtedly the case in Modern German—might have influenced the spoken language (*Umgangssprache*), the history of the language in its earlier stages is a history of different dialects. These dialects will, therefore, claim our attention at some length.

It may be assumed that the languages of the different West Germanic tribes enumerated above were, before the appearance of the tribes in history, distinguished by many dialectic variations;

¹ Cf. J. Grimm, *Deutsche Grammatik*, 3rd ed., i. p. 13; F. Kluge, *Etymologisches Wörterbuch*, 6th ed., pp. 75 ff.; K. Luick, "Zur Geschichte des Wortes 'deutsch,'" in *Anzeiger für deutsches Altertum*, xv., pp. 135, 248; H. Fischer, "Theotiscus, Deutsch," in Paul and Braune's *Beiträge*, xviii. p. 203; H. Paul, *Deutsches Wörterbuch* (1897), p. 93.

² For a detailed description of the boundary line cf. O. Behaghel's article in Paul's *Grundriss*, 2nd ed., pp. 652-657, where there is also a map, and a very full bibliography relative to the changes in the boundary.

this was certainly the case immediately after the Migrations, when the various races began to settle down. But these differences, consisting presumably in matters of phonology and vocabulary, were nowhere so pronounced as to exclude a mutual understanding of individuals belonging to different tribes. One might compare the case of the Poles and Czechs of the present day. During the 6th century, however, a phonological process set in, which ultimately resulted in the separation of Germany into two great linguistic divisions, south and north, or, as the languages are called, High and Low German. This fundamental change, which is known as the second or High German Soundshifting (*Lautverschiebung*), spread northward from the mountainous districts in the south, and, whatever its cause may have been,¹ left behind it clear and easily recognizable effects on the Germanic voiced stop *d*, which became changed to *t*, and more especially on the voiceless stops *t*, *p* and *k*. Dialects which have shifted initial *t* and *tt* in the middle of a word to the affricate *ts* (written *z*, *tz*) and *p* and *k* in corresponding positions to the affricates *pf* and *kx* (written *ch*), further, *t*, *p* and *k* in the middle of words between vowels, to the double spirant *ss* (now written *sz*, *sz*), *ff*, *hh* (written *ch*), are called High German; those in which these changes have not taken place form the Low German group, this group agreeing in this respect with English and Frisian.

Of these sound changes, that of *t* to *ts* and *ss* (*sz*) is the most universal, extending over the whole region in which shifting occurs; that of *k* to *kx* (*ch*), the most restricted, being only found in Old Bavarian, and in the Swiss pronunciation, e.g. in *chind*. The remaining dialects occupy positions between the two extremes of complete shifting and the absence of shifting. Some Franconian dialects, for instance, leave *p* unchanged under certain conditions, and in one dialect at least, Middle Franconian, *t* has remained after vowels in certain pronominal forms (*dat*, *wat*, *allet*, &c.). On this ground a subdivision has been made in the High German dialects into (a) an Upper German (*Oberdeutsch*) and (b) a Middle German (*Mitteldeutsch*) group; and this subdivision practically holds good for all periods of the language, although in Old High German times the Middle German group is only represented, as far as the written language is concerned, by Franconian dialects.

As the scientific study of the German language advanced there arose a keen revival of interest—and that not merely on the part of scholars—in the dialects which were so long held in contempt as a mere corruption of the *Schriftsprache*.² We are still in the midst of a movement which, under the guidance of scholars, has, during the last three decades, bestowed great care on many of the existing dialects; phonological questions have received most attention, but problems of syntax have also not been neglected. Monumental works like Wenker's *Sprachatlas des deutschen Reiches* and dialect dictionaries are either in course of publication or preparing;³ while the difficult questions concerned with defining the boundaries of the various dialects

¹ Cf. P. Kretschmer, *Einleitung in die Geschichte der griechischen Sprache* (Göttingen, 1896), who holds the mingling of Celtic and Germanic elements in southern and south-western Germany responsible for the change. It might also be mentioned here that H. Meyer (*Zeitschrift f. deut. Altertum*, xiv pp. 101 ff.) endeavours to explain the first soundshifting by the change of abode of the Germanic tribes from the lowlands to the highlands of the Carpathian Mountains.

² Of writers who have made extensive use of dialects, it must suffice to mention here the names of J. H. Voss, Hebel, Klaus Groth, Fritz Reuter, Usteri, G. D. Arnold, Holtei, Castelli, J. G. Seidl and Anzengruber, and in our own days G. Hauptmann.

³ Cf. F. Staub and L. Tobler, *Schweizerisches Idiotikon* (1881 ff.); E. Martin and F. Lienhart, *Wörterbuch der elssassischen Mundarten* (Strasbourg, 1899 ff.); H. Fischer, *Schwabisches Wörterbuch* (Tübingen, 1901 ff.). Earlier works, which are already completed, are J. A. Schmeller, *Bayrisches Wörterbuch* (2nd ed., 2 vols., Munich, 1872-1877); J. B. Schöpl, *Tiroler Idiotikon* (Innsbruck, 1886); M. Lexer, *Kärntisches Wörterbuch* (1862); H. Gradl, *Egerländer Wörterbuch*, i. (Eger, 1883); A. F. C. Vilmar, *Idiotikon von Kurhessen* (Marburg, 1883) (with supplements by H. von Pfister); W. Crellius, *Oberhessisches Wörterbuch* (Darmstadt, 1890-1898). Professor J. Franck is responsible for a *Rheinisches Wörterbuch* for the Prussian Academy.

and explaining the reasons for them form the subject of many monographs.⁴

Beginning in the north we shall now pass briefly in review the dialects spoken throughout the German-speaking area.

A. THE LOW GERMAN DIALECTS

The Low German dialects, as we have seen, stand nearest to the English and Frisian languages, owing to the total absence of the consonantal shifting which characterizes High German, as well as to other peculiarities of sounds and inflections, e.g. the loss of the nasals *m* and *n* before the spirants *f*, *s* and *þ*. Cf. Old Saxon *ff* (five), *us* (us), *kup* (cf. uncouth). The boundary-line between Low and High German, the so-called *Benrather Linie*, may roughly be indicated by the following place-names, on the understanding, however, that the Riparian dialect (see below) is to be classed with High German: Montjoie (French border-town), Eupen, Aachen, Benrath, Düsseldorf, north of Siegen, Cassel, Heiligenstadt, Harzgerode, to the Elbe south of Magdeburg; this river forms the boundary as far as Wittenberg, whence the line passes to Lübben on the Spree, Fürstenwald on the Oder and Birnbaum near the river Warthe. Beyond this point the Low Germans have Slavs as their neighbours. Compared with the conditions in the 13th century, it appears that Low German has lost ground; down to the 14th and 15th centuries several towns, such as Mansfeld, Eisleben, Merseburg, Halle, Dessau and Wittenberg, spoke Low German.

Low German falls into two divisions, a western division, namely, Low Franconian, the parent, as we have already said, of Flemish and Dutch, and an eastern division, Low Saxon (*Platdeutsch*, or, as it is often simply called, Low German). The chief characteristic of the division is to be sought in the ending of the first and third person plural of the present indicative of verbs, this being in the former case *-en*, in the latter *-et*. Inasmuch as the south-eastern part of Low Franconian—inclusive of Gelderland and Cleves—shifts final *k* to *ch* (e.g. *ich*, *mich*, *auch*, *-lich*), it must obviously be separated from the rest, and in this respect be grouped with High German. Low Saxon is usually divided into Westphalian (to the west of the Weser) and Low Saxon proper, between Weser and Elbe. The south-eastern part of the latter has the verbal ending *-en* and further shows the peculiarity that the personal pronoun has the same form in the dative and accusative (*mik*, *dick*), whereas the remainder, as well as the Westphalian, has *mi*, *di* in the dative, and *mi*, *di* or *mik*, *dik* in the accusative. To these Low German dialects must also be added those spoken east of the Elbe on what was originally Slavonic territory; they have the ending *-en* in the first and third person plural of verbs.⁵

B. THE HIGH GERMAN DIALECTS

1. *The Middle German Group.*—This group, which comprises the dialects of the Middle Rhine, of Hesse, Thuringia, Upper Saxony (Meissen), Silesia and East Prussia to the east of the lower Vistula between Bischofswerder, Marienburg, Elbing, Wormditt and Wartenberg—a district originally colonized from Silesia—may be most conveniently divided into an East and a West Middle German group. A common characteristic of all these dialects is the diminutive suffix *-chen*, as compared with the Low German form *-ken* and the Upper German *-lein* (O.H.G. *lin*). East Middle German consists of Silesian, Upper Saxon and Thuringian,⁶ together with the linguistic colony in East Prussia. While these dialects have shifted initial Germanic *p* to *ph*, or even to *f* (*fer* = *pfers*), the West Middle German dialects (roughly speaking to the west of the watershed of Werra and Fulda) have retained it. It, following a convincing article in the *Zeitschrift für deutsche Altertum* (37, 288 ff.) by F. Wrede, we class East and South Franconian—both together may be called High Franconian—with the Upper German dialects, there only remain in the West Middle German group: (a) Middle

⁴ Cf. the article "Mundarten" by R. Loewe in R. Bethge, *Ergebnisse und Fortschritte der germanistischen Wissenschaft* (Leipzig, 1902), pp. 75-88; and F. Meutz, *Bibliographie der deutschen Mundartenforschung* (Leipzig, 1892). Of periodicals may be mentioned *Deutsche Mundarten*, by J. W. Nagl (Vienna, 1896 ff.); *Zeitschrift für hochdeutsche Mundarten*, by O. Heilig and Ph. Lenz (Heidelberg, 1900 ff.), continued as *Zeitschrift f. deutsche Mundarten*, Verlag des Allgemeinen Deutschen Sprachvereins. Owing to its importance as a model for subsequent monographs J. Kintler's *Die Kreuzer Mundart des Kantons Glarus* (Leipzig, 1876) should not be passed unnoticed.

⁵ Cf. especially H. Tümpel, "Die Mundarten des alten niedersächsischen Gebietes zwischen 1300 und 1500" (Paul und Braune's *Beiträge*, vii, pp. 1-104); *Niederdeutsche Studien*, by the same writer (Bielefeld, 1898); Bahnc, "Über Sprach- und Gaugrenzen zwischen Elbe und Weser" (*Jahrbuch des Vereins für niederdeutsche Sprachforschung*, vii, p. 77).

⁶ Upper Saxon and Thuringian are sometimes taken as a separate group.

⁷ Cf. W. Braune, "Zur Kenntnis des Fränkischen" (*Beiträge*, i, pp. 1-56); O. Böhm, *Zur Kenntnis des Oberfränkischen im 13. 14. und 15. Jahrh.* (Dissertation) (Leipzig, 1893), where a good account of the differences between the Rhenish Franconian and South Franconian dialects will be found.

Franconian and (b) Rhenish Franconian. The former of these,¹ which with its *dal*, *wal*, *allei*, &c. (cf. above) and its retention of the voiced spirant *b* (written *v*) represents a kind of transition dialect to Low German, is itself divided into (a) Ripuarian or Low Rhenish with Cologne and Aachen (Aix-la-Chapelle) as centres, and (b) Moselle Franconian,² with Trier (Treves) as principal town. The latter is distinguished by the fact that in the Middle High German period it shifts Germanic *-pp-* and *-rd-*, which are retained in (a), to *-rf-* and *-rd-* (cf. *werfen*, *hirtin* with *werpen*, *hirtin*).³ The Rhenish Franconian dialect is spoken in the Rhenish palatinate, in the northern part of Baden (Heidelberg, Hesse), and Nassau, and in the German-speaking part of Lorraine. A line drawn from Falkenberg at the French frontier to Siegen on the Lahn, touching the Rhine near Boppard, roughly indicates the division between Middle and Rhenish Franconian.

2. The Upper German Group.—The Upper German dialects, which played the most important part in the literature of the early periods, may be divided into (a) a Bavarian-Austrian group and (b) a High Franconian-Alemannic group. Of all the German dialects the Bavarian-Austrian has carried the soundshifting to its furthest extreme; here only do we find the labial voiced stop *b* written *p* in the middle of a word, viz. old Bavarian *kāpamēs*, old Alemannic *kābamēs* ("we gave"); here too, in the 12th century, we find the first traces of that broadening of *i*, *ū*, *iū* (to *ei*, *au*, *eu*, a change which, even at the present day, is still foreign to the greater part of the Alemannic dialects. Only in Bavarian do we still find the old pronominal dual forms *es* and *enk* (for *ih* and *euch*). Finally, Bavarian forms diminutives in *-el* and *-erl* (*Madel*, *Mädel*), while the Franconian-Alemannic forms are *-la* and *-le* (*Mädle*). On the other hand, the pronunciation of *-s* as *-sch*, especially *-st* as *-stich* (cf. *Last*, *Haupt*, pronounced *Lascht*, *Häuschpel*), may be mentioned as characteristic of the Alemannic, just as the *fortis* pronunciation of initial *t* is characteristic of High Franconian, while the other Franconian and Upper German dialects employ the *lenis*.

The Alemannic dialect which, roughly speaking, is separated from Bavarian by the Lech and borders on Italian territory in the south and on French in the west, is subdivided into: (a) Swabian, the dialect of the kingdom of Württemberg and the north-western part of Tirol (cf. H. Fischer, *Geographie der schwabischen Mundart*, 1895); (b) High Alemannic (Swiss), including the German dialects of Switzerland, of the southern part of the Black Forest (the Basel-Breisgau dialect), and that of Vorarlberg; (c) Low Alemannic, comprising the dialects of Alsace and part of Baden (to the north of the Feldberg and south of Rastatt), also, at the present day, the town of Basel. Only Swabian has taken part in the change of *i* to *e*, &c., mentioned above, while initial Germanic *k* has been shifted to *ck* (*x*) only in High Alemannic (cf. *chalt*, *chind*, *chorn*, for *kalt*, *kind*, *korn*). The pronunciation of *š* as *š*, *š* (*Hus* for *Haus*) is peculiar to Alsatian.

The High Franconian dialects, that is to say, east and south (or south-Rhenish) Franconian, which are separated broadly speaking by the river Neckar, comprise the language spoken in a part of Baden, the dialects of the Main valley from Würzburg upwards to Bamberg, the dialect of Nuremberg and probably of the Vogtland (Plauen) and Egerland. During the older historical period the principal difference between East and South Franconian consisted in the fact that initial Germanic *d* was retained in the latter dialect, while East Franconian shifted it to *t*. Both, like Bavarian and Alemannic, shift initial Germanic *p* to the affricate *pf*.

Finally, the Bavarian-Austrian dialect is spoken throughout the greater part of the kingdom of Bavaria (i.e. east of the Lech and a line drawn from the point where the Lech joins the Danube to the sources of the rivers Elster and Mulde, this being the East Franconian border-line), in Austria, western Bohemia, and in the German linguistic "islands" embedded in Hungary, in Gottschee and the Sette and Tredecim Comuni (cf. above).⁴

¹ Cf. C. Nörrenberg, "Lautverehungsstufe des Mittelfränkischen" (*Beitrage*, ix. 371 ff.); R. Heinzel, *Geschichte der niederfränkischen Geschäftssprache* (Paderborn, 1874).

² This is also the dialect of the so-called Siebenbürger Sachsen.

³ Cf. E. Sievers, *Oxford Benedictinerregel* (Halle, 1887), p. xvi.; J. Meier, *Jolande* (1887), pp. vii. ff., O. Böhm, *l.c.* p. 60.

⁴ Lower Hesse (the northern and eastern parts) goes, however, in many respects its own way.

⁵ On the High German dialects cf. K. Weinhold, *Alemannische Grammatik* (Berlin, 1863); F. Kaufmann, *Geschichte der schwabischen Mundart* (Strassburg, 1870); E. Haendcke, *Die mundartlichen Elemente in den altsächsischen Urkunden* (Strassburg, 1893); K. Weinhold, *Basische Grammatik* (1867); J. A. Schmeller, *Die Mundarten Baierns* (Munich, 1821); J. N. Schwäb, *Die altsächsischen Mundarten* (München, 1903); O. Brenner, *Mundarten und Schriftsprache in Bayern* (Bamberg, 1890); J. Schatz, *Die Mundart von Imst* (Strassburg, 1897); J. W. Nagl, *Der Vocalismus der bairisch-österreichischen Mundarten* (1890-1891); W. Grail, *Die Mundarten Westböhmens* (Munich, 1896); P. Lessiak, "Die Mundart von Pernegg in Kärnten" (Paul and Brauns, *Beiträge*, vol. xxviii.).

THE OLD HIGH GERMAN PERIOD

The language spoken during the Old High German period, that is to say, down to about the year 1050, is remarkable for the fullness and richness of its vowel-sounds in word-stems as well as in inflections. Cf. *elenti*, *Elend*; *luginari*, *Lugner*; *karkari*, *Kerker*; *menniskona slakta*, *Menschengeschlecht*; *herano*, *Herzen* (gen. pl.); *jurisio*, *vorderste*; *hartost*, (am) *härtesten*; *zibanzug*, *siebzg*; *zichemes*, (*wir*) *ziehen*; *salboto*, (*er*) *salbt*; *gaworahos*, (*du*) *wirktest*, &c. Of the consonantal changes which took place during this period that of the spirant *th* (preserved only in English) to *d* (*werthan*, *werdian*; *theob*, *deob*) deserves mention. It spread from Upper Germany, where it is noticeable as early as the 8th century to Middle and finally, in the 11th and 12th centuries, to Low Germany. Further, the initial *h* in *hl*, *hn*, *hr*, *hw* (cf. *huor*, *wer*; *hreisn reis*; *hlakhan*, *lachen*) and *w* in *w* (*werecco*, *Recke*) disappeared, this change also starting in Upper Germany and spreading slowly north. The most important vowel-change is the so-called mutation (*Umlaut*),⁵ that is to say, the qualitative change of a vowel (except *i*) in a stem-syllable, owing to the influence of an *i* or *j* in the following syllable. This process commenced in the north where it seems to have been already fully developed in Low German as early as the 8th century. It is to be found, it may be noted, in Anglo-Saxon, as early as the 6th century. It gradually worked its way southwards to Middle and Upper Germany where, however, certain consonants seem to have protected the stem syllable from the influence of *i* in a following syllable. Cf., for instance, Modern High German *drucken* and *drucken*; *glauben*, *kaufen*, *Haupt*, words which in Middle German dialects show mutation. Orthographically, however, this process is, during the first period, only to be seen in the change of *ā* to *ei* from the 10th century onwards; there are, it is true, some traces of other changes, and vowels like *ū*, *ō*, *ou* must have already been affected, otherwise we could not account for the mutation of these vowels at a period when the cause of it, the *i* or *j*, no longer existed. A no less important change, for it helped to differentiate High from Low German, was that of Germanic *ē* (a closed *e*-sound) and *ō* diphthongs in Old High German, while they were retained in Old Low German. Cf. O.H.G. *hēr*, *hear*, *hīar*, O.L.G. *hēr*; O.H.G. *fuoz*, O.L.G. *fōt*. The final result was that in the 10th century *ē* (older forms, *ie*, *ea*) and *uo* (older *ua*, *ou* in Alemannic, *ua* in South Franconian) had asserted themselves throughout all the High German dialects. Again while in Old High German the older diphthongs *ai* and *au* were preserved as *ei* and *ou*, unless they happened to stand at the end of a word or were followed by certain consonants (*h*, *w*, *r* in the one case, and *h*, *r*, *l*, *n*, *th*, *d*, *t*, *z*, *s* in the other; cf. *zēh* from *zihun*, *zōh* from *ziokun*, *verlōs*, &c.), the Old Low German shows throughout the monophthongs *ē* (in Middle Low German a closed sound) and *ō* (cf. O.L.G. *sēn*, *ōga*). These monophthongs are also to be heard in Rhenish Franconian, the greater part of East Franconian and the Upper Saxon and Silesian dialects of modern times (cf. *Slein*: *Slees* or *Slew*; *laufen*: *lofen* or *lopen*).

Of the dialects enumerated above, Bavarian and Alemannic, High and Rhenish Franconian as well as Old Saxon are more or less represented in the literature of the first period. But this literature, the chief monuments of which are Otfrid's *Evangelienbuch* (in South Franconian), the Old Saxon *Heliand* (a life of Christ in alliterative verse), the translation of Tatian's *Gospel Harmony* (East Franconian) and that of a theological tract by Bishop Isidor of Seville and of parts of the Bible (Rhenish Franconian), is almost exclusively theological and didactic in character. One is consequently inclined to attach more value to the scanty remains of the *Hildebrandslied* and some interesting and ancient charms. The didactic spirit again pervades the translations and commentaries of Notker of St Gall in the early part of the 11th century; as well as a paraphrase of the *Song of Songs* by an abbot William of Ebersberg a little later. Latin, however, reigned supreme throughout this period, it being the language of the charters, the lawbooks (there is nothing in Germany to compare with the laws of the Anglo-Saxons), of science, medicine, and even poetry. It is thus needless to say that there was no recognized literary language (*Schriftsprache*) during this period, nor even any attempt to form one; at most, we might speak of schools in the large monasteries, such as Reichenau, St Gall, Fulda, which contributed to the spread and acceptance of certain orthographical rules.

THE MIDDLE HIGH GERMAN PERIOD

The following are the chief changes in sounds and forms which mark the development of the language in the Middle High German period. The orthography of the MSS. reveals a much more extensive employment of mutation (*Umlaut*) than was the case in the first period; we find, for instance, as the mutation of *o*, *ō*, of *ō*, *ou*, of *ū*, *iū*, of *uo*, *ūe*, of *ou*, *ōu*, and *eu* (cf. *holer*, *basse*, *hüser*, *guete*, *bäume*), although many scribes, and more especially those of Middle and Low German districts, have no special signs for the mutation of *ū*, *ū*, and *o*. Of special interest is the so-called "later (or weaker)

⁵ Cf., for a hypothesis of two *Umlautperioden* during the Old High German time, F. Kaufmann, *Geschichte der schwabischen Mundart* (Strassburg, 1890), S. 152.

mutation" (*jüngerer oder schwächerer Umlaut*) of *ä* to a very open *e* sound, which is often written *ai*. Cf. *mähle* (O.H.G. *mähli*), *mägede* (O.H.G. *magudi*). The earlier mutation of this sound produced an *e(é)*, a closed sound (i.e. nearer *i*). Cf. *geste* (O.H.G. *gesti*).

The various Old High German vowels in unstressed syllables were either weakened to an indiffererent *e* sound (*geben*, O.H.G. *geban*; *bole*, O.H.G. *bot*; *stige*, O.H.G. *stiga*) or disappeared altogether. The latter phenomenon is to be observed after *l* and *r*, and partly after *n* and *m* (cf. *ar(e)*, O.H.G. *aro*; *zal*, O.H.G. *zala*; *wundern*, O.H.G. *wuntarön*, &c.); but it by no means took place everywhere in the same degree and at the same time. It has been already noted that the Alemannic dialect (as well as the archaic poets of the German national epic) retained at least the long unstressed vowels until as late as the 14th century (*gemartertöt*, *gerünsetöt*, &c.), and Low and Middle German preserved the weakened *e* sound in many cases where Upper German dropped it. In this period the beginnings are also to be seen in Low and Middle German (Heinrich von Veldeke shows the first traces of it) of a process which became of great importance for the formation of the Modern German literary language. This is the lengthening of originally short vowels in open syllables,¹ for example, in Modern High German *Tages*, *Weges*, *Löbe* (Middle High German *tages*, *weges*, *lobbe*). In Austria, on the other hand, there began as far back as the first half of the 12th century another movement of equal importance for Modern High German, namely, the conversion of the long vowels, *ī*, *ū*, into *ei* (*ou*), *au*, *eu* (*äu*).² It is, therefore, in MSS. written in the south-into that we find forms like *zeit*, *lauter* (*löter*), *heute*, &c., for the first time. With the exception of Low German and Alemannic—Swabian, however, follows in this respect the majority—all the German dialects participated in this change between the 14th and 16th centuries, although not all to the same degree. The change was perhaps assisted by the influence of the literary language which had recognized the new sounds. In England the same process has led to the modern pronunciation of *time*, *house*, &c., and in Holland to that of *tijd*, *huis*, &c. F. Wrede (*Zeitschrift für deutsches Altertum* xxxix, 257 ff.) has suggested that the explanation of the change is to be sought in the apocope and syncope of the final *e*, and the greater stress which was in consequence put on the stem-syllable. The tendency to a change in the opposite direction, namely, the narrowing of diphthongs to monophthongs, is to be noticed in Middle German dialects, i.e. in dialects which resisted the apocope of the final *e*, where *ie*, *uo*, *ue* become *i*, *ū*, *ü*; thus we have for *Brief*, *brif*, for *huon*, *hin*, for *brüeder*, *brüder*, and this too was taken over into the Modern High German literary language.³

No consonantal change was so widespread during this period as that of initial *t* to *sch* before *l*, *n*, *m*, *w*, *p* and *t*. Cf. *slingen*, *schlingen*; *swer* (*e*), *schwören*, &c. The forms *scht*- and *schnp*-are often to be met with in Alemannic MSS., but they were discarded again, although modern German recognizes the pronunciation *schnp*, *scht*.⁴ With regard to changes affecting the inflections of verbs and nouns, it must suffice here to point out that the weakening or disappearance of vowels in unstressed syllables necessarily affected the characteristic endings of the older language; groups of verbs and substantives which in Old High German were distinct now become confused. This is best seen in the case of the weak verbs, where the three Old High German classes (cf. *merien*, *sahbin*, *dagin*) were fused into one. Similarly in the declensions we find an increasing tendency of certain forms to influence substantives belonging to other classes; there is, for instance, an increase in the number of neuter nouns taking *-er* (*-ir*) in the plural, and of those which show mutation in the plural on the model of the *i*-stems (O.H.G. *gast*, pl. *gesti*; cf. forms like *ban*, *henne*; *hals*, *helse*; *wald*, *welde*). Of changes in syntax the gradual decay in the use of the genitive case dependent on a noun or governed by a verb (cf. constructions like *eine brünne rotes goldes*, or *des todes wünschen*) towards the end of the period, and also the disappearance of the Old High German sequence of tenses ought at least to be mentioned.

In the Middle High German period, the first classical period of German poetry, the German language made great advances as a vehicle of literary expression; its power of expression was increased and it acquired a beauty of style hitherto unknown. This was the period of the *Minnesang* and the great popular and court epics, of Walther von der Vogelweide, Hartmann von Aue, Wolfram von Eschenbach and Gottfried von Strassburg; it was a period when literature enjoyed the fostering care of the courts and the nobility. At the same time German prose celebrated its first triumphs in the sermons of Berthold von Regensburg, and in the mystic writings and sermons of Meister Eckhart, Tauler and others. History (Eike von Repkow's *Weltchronik*) and law (*Sachsenspiegel*, *Schwabenspiegel*) no longer despised the vernacular, and from about the middle of the 13th century German becomes, in an ever-increasing percentage, the language of deeds and charters.

¹ Cf. W. Wilmanns, *Deutsche Grammatik*, i. (2nd edition) pp. 300-304.

² Wilmanns, *l.c.* pp. 273-280. It might be mentioned that, in Modern High German, these new diphthongs are neither in spelling nor in educated pronunciation distinguished from the older ones.

³ Cf. Wilmanns, pp. 280-284. ⁴ *Ibid.* pp. 129-132.

It has been a much debated question how far Germany in Middle High German times possessed or aspired to possess a *Schriftsprache* or literary language.⁵ About the year 1200 there was undoubtedly a marked tendency towards a unification of the literary language on the part of the more careful poets like Walther von der Vogelweide, Hartmann von Aue and Gottfried von Strassburg; they avoid, more particularly in their rhymes, dialectic peculiarities, such as the Bavarian dual forms *ei* and *enb*, or the long vowels in unstressed syllables, retained in Alemannic, and they do not make use of archaic words or forms. We have thus a right to speak, if not of a Middle High German literary language in the widest sense of the word, at least of a Middle High German *Dichtersprache* or poetic language, on an Alemannic-Franconian basis. Whether, or in how far, this may have affected the ordinary speech of the nobility or courts, is a matter of conjecture; but it had an undeniable influence on Middle and Low German poets, who endeavoured at least to use High German forms in their rhymes. Attempts were also made in Low German districts, though at a later stage of this period, to unify the dialects and raise them to the level of an accepted literary language. It will be shown later why these attempts were unsuccessful. Unfortunately, however, the efforts of the High German poets to form a uniform language were also short-lived; by the end of the 13th century the *Dichtersprache* had disappeared, and the dialects again reigned supreme.

MODERN HIGH GERMAN

Although the Middle High German period had thus not succeeded in effecting any permanent advance in the direction of a uniform literary language, the desire for a certain degree of uniformity was never again entirely lost. At the close of the 13th century literature had passed from the hands of the nobility to those of the middle classes of the towns; the number of writers who used the German tongue rapidly increased; later the invention of printing, the increased efficiency of the schools, and above all the religious movement of the Reformation, contributed to awakening the desire of being understood by those who stood outside the dialectic community of the individual. A single authoritative form of writing and spelling was felt on all sides to be particularly necessary. This was shown in the language used officially by the various chanceries (*Kanzleien*), and more especially the imperial chancery. Since the days of Charles IV. (1347-1378) the latter had striven after a certain uniform language in the documents it issued, and by the time of Maximilian I. (1493-1519) all its official documents were characterized by pretty much the same phonology, forms and vocabulary, in whatever part of Germany they originated. And under Maximilian's successor, Charles V., the conditions remained pretty much the same. The fact that the seat of the imperial chancery had for a long time been in Prague, led to a mingling of Upper and Middle German sounds and inflections; but when the crown came with Frederick III. (1440-1493) to the Habsburgs, the Upper German elements were considerably increased. The chancery of the Saxon electorate, whose territory was exclusively Middle German, had to some extent, under the influence of the imperial chancery, allowed Upper German characteristics to influence its official language. This is clearly marked in the second half of the 15th century, and about the year 1500 there was no essential difference between the languages of the two chanceries. Thuringia, Silesia and Brandenburg soon followed suit, and even Low German could not ultimately resist the accepted High German notation (*ö*, *ö*, *ü*, *ü*, *ä*, *ä*, &c.). We have here very favourable conditions for the creation of a uniform literary language, and, as has already been said, the tendency to follow these authorities is clearly marked.

In the midst of this development arose the imposing figure of Luther, who, although by no means the originator of a common High German speech, helped very materially to establish it. He deliberately chose (cf. the often quoted passage in his *Tischreden*, ch. 69) the language of the Saxon chancery as the vehicle of his Bible translation and subsequently of his own writings. The differences between Luther's usage and that of the chancery, in phonology and inflection, are small; still he shows, in his writings subsequent to 1524, a somewhat more pronounced tendency towards Middle German. But it is noteworthy that he, like the chancery, retained the old vowel-change in the singular and plural of the preterite of the strong verbs (i.e. *stieg*, *stigen*; *starb*, *starben*), although before Luther's time the uniformity of the modern preterite had already begun to show itself here and there. The adoption of the language

⁵ Cf. K. Lachmann, *Kleinere Schriften*, i. p. 161 ff.; Müllenhoff and Scherer's *Denkmäler* (3rd ed.), i. p. xxvii; H. Paul, *Geb es eine mhd. Schriftsprache?* (Halle, 1873); O. Behagel, *Zur Frage nach einer mhd. Schriftsprache* (Basel, 1886) (Cf. Paul and Braune's *Beiträge*, xiii. p. 464 ff.); A. Socin, *Schriftsprache und Dialekte* (Heilbronn, 1888); H. Fischer, *Zur Geschichte des Mittelhochdeutschen* (Tübingen, 1889); O. Behagel, *Schriftsprache und Mundart* (Gießen, 1896); K. Zwierzina, *Beobachtungen zum Reimgebrauch Hartmanns und Wolframs* (Halle, 1898); S. Singer, *Die mhd. Schriftsprache* (1900); C. Kraus, *Heinrich von Veldeke und die mhd. Dichtersprache* (Halle, 1899); G. Roethe, *Die Reimwörter des Sachsenspiegels* (Berlin, 1899); H. Tümpel, *Niederdeutsche Studien* (1898).

of the chancery gave rise to the mixed character of sounds and forms which is still a feature of the literary language of Germany. Thus the use of the monophthongs *i*, *ü*, and *ä*, instead of the old diphthongs *ie*, *uo* and *üe*, comes from Middle German; the forms of the words and the gender of the nouns follow Middle rather than Upper German usage, whereas, on the other hand, the consonantal system (*þ* to *f*; *d* to *t*) betrays in its main features its Upper German (Bavarian-Austrian) origin.

The language of Luther no doubt shows greater originality in its style and vocabulary (cf. its influence on Goethe and the writers of the *Sturm und Drang*), for in this respect the chancery could obviously afford him but scanty help. His vocabulary is drawn to a great extent from his own native Middle German dialect, and the fact that, since the 14th century, Middle German literature (cf. for instance, the writings of the German mystics, at the time of and subsequent to Eckhart) had exercised a strong influence over Upper Germany, stood him in good stead. Luther is, therefore, strictly speaking, not the father of the modern German literary language, but he forms the most important link in a chain of development which began long before him, and did not reach its final stage until long after him. To infer that Luther's language made any rapid conquest of Germany would not be correct. It was, of course, immediately acceptable to the eastern part of the Middle German district (Thuringia and Silesia), and it did not find any great difficulty in penetrating into Low Germany, at least into the towns and districts lying to the east of the Saale and Elbe (Magdeburg, Hamburg). One may say that about the middle of the 16th century Luther's High German was the language of the chanceries, about 1600 the language of the pulpit (the last Bible in Low German was printed at Goslar in 1621) and the printing presses. Thus the aspirations of Low Germany to have a literary language of its own were at an early stage crushed. Protestant Switzerland, on the other hand, resisted the "uncommon new German" until well into the 17th century. It was also natural that the Catholic Lower Rhine (Cologne) and Catholic South Germany held out against it, for to adopt the language of the reformer would have seemed tantamount to offering a helping hand to Protestant ideas. At the same time, geographical and political conditions, as well as the pronounced character of the Upper German dialects, formed an important obstacle to a speedy unification. South German grammarians of the 16th century, such as Laurentius Albertus, raise a warning voice against those who, although far distant from the proper use of words and the true pronunciation, venture to teach *non puriores Germanos*, namely, the Upper Germans.

In 1593 J. Helber, a Swiss schoolmaster and notary, spoke of three separate dialects as being in use by the printing presses:¹ (1) *Mitteldeutsch* (the language of the printers in Leipzig, Erfurt, Nuremberg, Würzburg, Frankfurt, Mainz, Spire, Strassburg and Cologne; at the last mentioned place in the event of their attempting to print *Ober-Teutsch*); (2) *Donausch* (the printers' language in South Germany, but limited to Bavaria and Swabia proper—here more particularly the Augsburg idiom, which was considered to be particularly *stetlich*); (3) *Höchst Reinisch*, which corresponds to Swiss German. Thus in the 16th century Germany was still far from real unity in its language; but to judge from the number and the geographical position of the towns which printed in *Mitteldeutsch* it is pretty clear, which idiom would ultimately predominate. During the 17th century men like M. Opitz (*Buch von der deutschen Poeserey*) and J. G. Schottelius (*Teutsche Sprachkunst*, 1641, and *Von der teutschen Sprachkunst*, 1663), together with linguistic societies like the *Fruchbringende Gesellschaft* and the Nuremberg *Pegnitzerorden*, did a great deal to purify the German language from foreign (especially French) elements; they insisted on the claims of the vernacular to a place beside and even above Latin (in 1687 Christian Thomasius held for the first time lectures in the German language at the university of Leipzig), and they established a firm grammatical basis for Luther's common language, which especially in the hymnals had become modernized and more uniform. About the middle of the 17th century the disparity between the vowels of the singular and plural of the preterite of the strong verbs practically ceases; under East Middle German influence the final *i* is restored to words like *Knabe*, *Jude*, *Pfaffe*, which in South German had been *Knab*, &c.; the mixed declension (*Ehren*, *Ehren*, *Schmerzen*, *Schmerzen*) was established, and the plural in *-er* was extended to some masculine nouns (*Wald*, *Wälder*);² the use of the mutated sound has now

¹ For literature bearing on the complicated question of the *Druckersprachen*, readers are referred to the article "Neuhochdeutsche Schriftsprache," by W. Scheel, in *Bethge's Ergebnisse . . . der germanistischen Wissenschaft* (1902), pp. 47, 50 f. Cf. also K. von Bahder, *Grundlagen des nhd. Lautsystems* (1890), pp. 15 ff.

² A German *Priamel* mentions as an essential quality in a beautiful woman: "die red dort her von Swaben."

³ Cf. for a detailed discussion of the noun declension, K. Boiung, *Die Entwicklung der mhd. Substantivflexion* (Leipzig, 1890); and, more particularly for the masculine and neuter nouns, two articles by H. Molt, "Die Substantivflexion seit mhd. Zeit," in Paul and Braune's *Beiträge*, xxvii, p. 209 ff. and xxxi, 277 ff. For the changes in the gender of nouns, A. Polzin, *Geschlechtswandel der Substantiva im Deutschen* (Hildesheim, 1903).

become the rule as a plural sign (*Väter*, *Bäume*). How difficult, even in the first half of the 18th century, it was for a Swiss to write the literary language which Luther had established is to be seen from the often quoted words of Haller (1708-1777): "I am a Swiss, the German language is strange to me, and its choice of words was almost unknown to me." The Catholic south clung firmly to its own literary language, based on the idiom of the imperial chancery, which was still an influential force in the 17th century or on local dialects. This is apparent in the writings of Abraham a Sancta Clara,⁴ who died in 1709, or in the attacks of the Benedictine monk, Augustin Dornblüh, on the *Meissner Schriftsprache* in 1755.

In the 18th century, to which these names have introduced us, the grammatical writings of J. C. Gottsched (*Deutsche Sprachkunst*, 1748) and J. C. Adelung (*Grammatisch-kritisches Wörterbuch der hochdeutschen Mundart*, 1774-1780) exercised a decisive and far-reaching influence. Gottsched took as his basis the spoken language (*Umgangssprache*) of the educated classes of Upper Saxony (Meissen), which at this time approximated as nearly as possible to the literary language. His *Grammar* did enormous services to the cause of unification, ultimately winning over the resisting south; but he carried his purism to pedantic lengths, he would tolerate no archaic or dialectal words, no unusual forms or constructions, and consequently made the language unsuited for poetry. Meanwhile an interest in Old German literature was being awakened by Bodmer; Herder set forth better ideas on the nature of language, and insisted on the value of native idioms; and the *Sturm und Drang* led by Goethe encouraged all individualistic tendencies. All this gave rise to a movement counter to Gottsched's absolutism, which resulted in the revival of many obsolete German words and forms, these being drawn partly from Luther's Bible translation (cf. V. Hehn, "Goethe und die Sprache der Bibel," in the *Goethe-Jahrbuch*, viii, p. 187 ff.), partly from the older language and partly from the vocabulary peculiar to different social ranks and trades.⁵ The latter is still a source of linguistic innovations. German literary style underwent a similar rejuvenation, for we are on the threshold of the second classical period of German literature. It had strengthened Gottsched's hand as a linguistic reformer that the earlier leaders of German literature, such as Gellert, Klopstock and Lessing, were Middle Germans; now Wieland's influence, which was particularly strong in South Germany, helped materially towards the establishment of one accepted literary language throughout all German-speaking countries; and the movement reaches its culmination with Goethe and Schiller. At the same time this unification did not imply the creation of an unalterable standard; for, just as the language of Opitz and Schottelius differed from that of Luther, so—although naturally in a lesser degree—the literary language of our day differs from that of the classic writers of the 18th century. Local peculiarities are still to be met with, as is to be seen in the modern German literature that emanates from Switzerland or Austria.

But this unity, imperfect as it is, is limited to the literary language. The differences are much more sharply accentuated in the *Umgangssprache*,⁶ whereby we understand the language as it is spoken by educated people throughout Germany; this is not only the case with regard to pronunciation, although it is naturally most noticeable here, but also with regard to the choice of words and the construction of sentences. Compared with the times of Goethe and Schiller a certain advance towards unification has undoubtedly been made, but the differences between north and south are still very great. This is particularly noticeable in the pronunciation of *r*—either the uvular *r* or the *r* produced by the tip of the tongue; of the voiced and voiceless stops, *b*, *p*, *d*, *t*, *g* and *k*; of the *s* sounds; of the diphthongs; of the long vowels *ē* and *ō*, &c. (cf. W. Victor, *German Pronunciation*, 2nd ed., 1890). The question as to whether a unified pronunciation (*Einheitsausprache*) is desirable or even possible has occupied the attention of academics, scholars and the educated public during recent years, and in 1898 a commission made up of scholars and theatre directors drew up a scheme of pronunciation for use in the royal theatres of Prussia.⁷ This scheme has since been recommended to all German theatres by the German *Bühnenverein*. Desirable as such a uniform pronunciation is for the national theatre, it is a much debated question how far it should be adopted in the ordinary speech of everyday life. Some scholars, such as W. Braune, declared themselves strongly in favour of its adoption; * Braune's

⁴ Cf. C. Blanckenburg, *Studien über die Sprache Abrahams a S. Clara* (Halle, 1897); H. Strigl, "Einiges über die Sprache des P. Abraham a Sancta Clara (*Zeitschr. f. deutsche Wortforschung*, xii, 206 ff.).

⁵ Cf. F. Kluge, *Etymologisches Wörterbuch* (6th ed.), pp. 508 ff. One can speak of *Studenten-, Soldaten-, Weidmanns-, Bergmanns-, Drucker-, Juristen-, und Zigeunersprache, und Rotwelsch*. Cf. F. Kluge, *Die deutsche Studentensprache* (Strassburg, 1894); *Rotwelsch I.* (Strassburg, 1901); R. Bethge, *Ergebnisse*, &c., p. 55 f.

⁶ Cf. H. Wunderlich, *Unsere Umgangssprache* (Weimar, 1894).

⁷ Cf. Th. Siebs, *Deutsche Bühnenausprache* (2nd ed., Berlin, 1901), and the same writer's *Grundzüge der Bühnensprache* (1900).

⁸ W. Braune, *Über die Einigung der deutschen Aussprache* (Halle, 1905); and the review by O. Brenner, in the *Zeitschrift des allgemeinen deutschen Sprachvereins*, Beil. iv, 37, pp. 228-232.

argument being that the system of modern pronunciation is based on the spelling, not on the sounds produced in speaking. The latter, he holds, is only responsible for the pronunciation of *-ch-* as *-ks-* in *wachsen, Ochse, &c.*, or for that of *sp-* and *st-* in *spielen, stehen, &c.* Other scholars, again, such as K. Luick and O. Brenner, warn against any such attempts to create a living language on an artificial basis: the *Bühnendeutsch* or "stage-German" they regard as little more than an abstract ideal. Thus the decision must be left to time.

AUTHORITIES.—General Literature: J. Grimm, *Geschichte der deutschen Sprache* (Leipzig, 1881; 3th ed., 1880); W. Scherer, *Zur Geschichte der deutschen Sprache* (Berlin, 1868; 2nd ed., 1878); E. Förstemann, *Geschichte des deutschen Sprachstammes* (Nordhausen, 1874-1875); O. Behagel, *Die deutsche Sprache* (Leipzig, 1886; 2nd ed., 1902); the same, "Geschichte der deutschen Sprache," in Paul's *Grundriss der germanischen Philologie* (2nd ed.), i. pp. 650 ff.; O. Weise, *Unsere deutsche Sprache, ihr Werden und ihr Wesen* (Leipzig, 1898); K. von Raumer, *Geschichte der germanischen Philologie* (Munich, 1870); J. Grimm, *Deutsche Grammatik* (4 vols., vols. i.-iii. in new edition, 1870-1890); Dieter, *Laut- und Formenlehre der altgermanischen Dialekte* (2 vols., Leipzig, 1898-1900); F. Kauffmann, *Deutsche Grammatik* (2nd ed., 1895); W. Wilmanns, *Deutsche Grammatik*, so far, vols. i., ii. and iii., I (Strassburg, 1893-1906, vol. i., 2nd ed., 1897); O. Brenner, *Grundzüge der geschichtlichen Grammatik der deutschen Sprache* (Munich, 1896); H. Lichtenberger, *Histoire de la langue allemande* (Paris, 1895).

Old and Middle High German Period: W. Braune, *Althochdeutsche Grammatik* (2nd ed., Halle, 1891); the same, *Abriss der althochdeutschen Grammatik* (3rd ed., 1900); F. Holthausen, *Altösisches Elementarbuch* (Heidelberg, 1890); W. Schlüter, *Untersuchungen zur Geschichte der altösischen Sprache*, i. (Göttingen, 1892); O. Schade, *Altösisches Wörterbuch* (2nd ed., Halle, 1872-1882); G. E. Graff, *Althochdeutscher Sprachschatz* (6 vols., Berlin, 1834-1842) (Index by Massmann, 1846); E. Steinmeyer and E. Sievers, *Althochdeutsche Glossen* (4 vols., Berlin, 1879-1898); J. A. Schmeller, *Glossarium Saxonum* (Munich, 1840); K. Weinhold, *Mittelhochdeutsche Grammatik* (3rd ed., Paderborn, 1892); H. Paul, *Mittelhochdeutsche Grammatik* (5th ed., Halle, 1900); V. Michels, *Mittelhochdeutsches Elementarbuch* (Heidelberg, 1900); O. Brenner, *Mittelhochdeutsche Grammatik* (3rd ed., Munich, 1894); K. Zwierniza, "Mittelhochdeutsche Studien," in *Zeitschrift für deutsches Altertum*, vols. xliiv. and xlv.; A. Lübben, *Mittelniederdeutsche Grammatik* (Leipzig, 1882); W. Müller and F. Zarncke, *Mittelhochdeutsches Wörterbuch* (4 vols., Leipzig, 1854-1866); M. Lexer, *Mittelhochdeutsches Handwörterbuch* (3 vols., 1872-1878); the same, *Mittelhochdeutsches Taschenwörterbuch* (8th ed., 1906); K. Schiller and A. Lübben, *Mittelniederdeutsches Wörterbuch* (6 vols., Bremen, 1875-1881); A. Lübben, *Mittelniederdeutsches Handwörterbuch* (Norden, 1888); F. Seiler, *Die Entwicklung der deutsch. Kulturen im Spiegel des deutschen Lehnworts* (Halle, i., 1895, 2nd ed., 1905, ii., 1900).

Modern High German Period: E. Wulker, "Die Entstehung der kursächsischen Kanzleisprache" (in the *Zeitschrift des Vereins für kursächsische Geschichte*, ix. p. 349); the same, "Luthers Stellung zur kursächsischen Kanzleisprache" (in *Germania*, xxviii. pp. 191 ff.); P. Pietsch, *Martin Luther und die hochdeutsche Schriftsprache* (Breslau, 1883); K. Burdach, *Die Einigung der neuhochdeutschen Schriftsprache* (1883); E. Opitz, *Die Sprache Luthers* (Halle, 1866); J. Luther, *Die Sprache Luthers in der Septemberbibel* (Halle, 1887); F. Kluge, *Von Luther bis Lessing* (Strassburg, 1888) (cf. E. Schröder's review in the *Göttinger gelehrte Anzeiger*, 1888, 249); H. Rückert, *Geschichte der neuhochdeutschen Schriftsprache bis zur Mitte des 18. Jahrhunderts* (1875); J. Kehrein, *Grammatik der deutschen Sprache des 15. bis 17. Jahrhunderts* (Leipzig, 2d ed., 1863); K. von Bahder, *Grundlagen des neuhochdeutschen Lautsystems* (Strassburg, 1890); R. Meyer, *Einführung in das ältere Neuhochdeutsche* (Leipzig, 1894); W. Scheel, *Beiträge zur Geschichte der neuhochdeutschen Gemeinsprache in Köln* (Marburg, 1892); R. Brandtetter, *Die Reception der neuhochdeutschen Schriftsprache in Stadt und Landschaft Luzern* (1892); K. Burdach, "Zur Geschichte der neuhochdeutschen Schriftsprache" (*Forschungen zur deutschen Philologie*, 1894); the same, "Die Sprache des jungen Goethe" (*Verhandlungen der Dessauer Philologenversammlung*, 1884, p. 164 ff.); F. Kasch, *Die Sprache des jungen Schiller* (Dissertation, 1900); F. Kluge, "Über die Entstehung unserer Schriftsprache" (Beihfte zur *Zeitschrift des allgemeinen Sprachvereins*, Heft 6, 1894); A. Waag, *Bedeutungsentwicklung unseres Wortschatzes* (Lahr, 1901).

Mention must also be made of the work of the German commission of the Royal Prussian Academy, which in 1904 drew up plans for making an inventory of all German literary MSS. dating from before the year 1600 and for the publication of Middle High German and early Modern High German texts. This undertaking, which has made considerable progress, provides rich material for the study of the somewhat neglected period between the 14th and 16th centuries; at the same time it provides a basis on which a monumental history of Modern High German may be built up, as well as for a *Thesaurus linguae germanicae*. (R. Ph.)

¹ Cf. K. Luick, *Deutsche Lautlehre mit besonderer Berücksichtigung der Sprechweise Wiens und der österreichischen Alpenländer* (1904); O. Brenner, "Zur Aussprache des Hochdeutschen," *l.c.*, pp. 218-228.

GERMAN LITERATURE. Compared with other literatures, that of the German-speaking peoples presents a strangely broken and interrupted course; it falls into more or less isolated groups, separated from each other by periods which in intellectual darkness and ineptitude are virtually without a parallel in other European lands. The explanation of this irregularity of development is to be sought less in the chequered political history of the German people—although this was often reason enough than in the strongly marked, one might almost say, provocative character of the national mind as expressed in literature. The Germans were not able, like their partially latinized English cousins—or even their Scandinavian neighbours—to adapt themselves to the various waves of literary influence which emanated from Italy and France and spread with irresistible power over all Europe; their literary history has been rather a struggle for independent expression, a constant warring against outside forces, even when the latter—like the influence of English literature in the 18th century and of Scandinavian at the close of the 19th—were hailed as friendly and not hostile. It is a peculiarity of German literature that in those ages when, owing to its own poverty and impotence, it was reduced to borrowing its ideas and its poetic forms from other lands, it sank to the most servile imitation; while the first sign of returning health has invariably been the repudiation of foreign influence and the assertion of the right of genius to untrammelled expression. Thus Germany's periods of literary efflorescence rarely coincide with those of other nations, and great European movements, like the Renaissance, passed over her without producing a single great poet.

This chequered course, however, renders the grouping of German literature and the task of the historian the easier. The first and simplest classification is that afforded by the various stages of linguistic development. In accordance with the three divisions in the history of the High German language, there is an Old High German, a Middle High German and a New High German or Modern High German literary epoch. It is obvious, however, that the last of these divisions covers too enormous a period of literary history to be regarded as analogous to the first two. The present survey is consequently divided into six main sections:

I. The Old High German Period, including the literature of the Old Saxon dialect, from the earliest times to the middle of the 11th century.

II. The Middle High German Period, from the middle of the 11th to the middle of the 14th century.

III. The Transition Period, from the middle of the 14th century to the Reformation in the 16th century.

IV. The Period of Renaissance and Pseudo-classicism, from the end of the 16th century to the middle of the 18th.

V. The Classical Period of Modern German literature, from the middle of the 18th century to Goethe's death in 1832.

VI. The Period from Goethe's death to the present day.

I. THE OLD HIGH GERMAN PERIOD (c. 750-1050)

Of all the Germanic races, the tribes with which we have more particularly to deal here were the latest to attain intellectual maturity. The Goths had, centuries earlier, under their famous bishop Ulfilas or Wulfila, possessed the Bible in their vernacular, the northern races could point to their *Edda*, the Germanic tribes in England to a rich and virile Old English poetry, before a written German literature of any consequence existed at all. At the same time, these continental tribes, in the epoch that lay between the Migrations of the 5th century and the age of Charles the Great, were not without poetic literature of a kind, but it was not committed to writing, or, at least, no record of such a poetry has come down to us. Its existence is vouched for by indirect historical evidence, and by the fact that the sagas, out of which the German national epic was welded at a later date, originated in the great upheaval of the 5th century. When the vernacular literature began to emerge from an unwritten state in the 8th century, it proved to be merely a weak reflection of the ecclesiastical writings of the monasteries; and this, with

very few exceptions, Old High German literature remained. Translations of the liturgy, of Tatian's *Gospel Harmony* (c. 835), of fragments of sermons, form a large proportion of it. Occasionally, as in the so-called *Monsee Fragments*, and at the end of the period, in the prose of Notker Labeo (d. 1022), this ecclesiastical literature attains a surprising maturity of style and expression. But it had no vitality of its own; it virtually sprang into existence at the command of Charlemagne, whose policy with regard to the use of the vernacular in place of Latin was liberal and far-seeing; and it docilely obeyed the tastes of the rulers that followed, becoming severely orthodox under Louis the Pious, and consenting to immediate extinction when the Saxon emperors withdrew their favour from it. Apart from a few shorter poetic fragments of interest, such as the *Merseburg Charms* (*Zaubersprüche*), an undoubted relic of pre-Christian times, the *Wessobrunn Prayer* (c. 780), the *Muspilli*, an imaginative description of the Day of Judgment, and the *Ludwiglied* (881), which may be regarded as the starting point for the German historical ballad, the only High German poem of importance in this early period was the *Gospel Book* (*Liber evangeliorum*) of Otfried of Weissenburg (c. 800-870). Even this work is more interesting as the earliest attempt to supersede alliteration in German poetry by rhyme, than for such poetic life as the monk of Weissenburg was able to instil into his narrative. In fact, for the only genuine poetry of this epoch we have to look, not to the High German but to the Low German races. They alone seemed able to give literary expression to the memories handed down in oral tradition from the 5th century; to Saxon tradition we owe the earliest extant fragment of a national saga, the *Lay of Hildebrand* (*Hildebrandslied*, c. 800), and a Saxon poet was the author of a vigorous alliterative version of the Gospel story, the *Heliant* (c. 830), and also of part of the Old Testament (*Genesis*). This alliterative epic—for epic it may be called—is the one poem of this age in which the Christian tradition has been adapted to German poetic needs. Of the existence of a lyric poetry we only know by hearsay; and the drama had nowhere in Europe yet emerged from its earliest purely liturgic condition. Such as it was, the vernacular literature of the Old High German period enjoyed but a brief existence, and in the 10th and 11th centuries darkness again closed over it. The dominant "German" literature in these centuries is in Latin; but that literature is not without national interest, for it shows in what direction the German mind was moving. The *Lay of Walter* (*Waltherlied*, c. 930), written in elegant hexameters by Ekkehard of St Gall, the moralizing dramas of Hrosvitha (Roswitha) of Gandersheim, the *Ecbasis captivi* (c. 940), earliest of all the Beast epics, and the romantic adventures of *Ruodlieb* (c. 1030), form a literature which, Latin although it is, foreshadows the future developments of German poetry.

II. THE MIDDLE HIGH GERMAN PERIOD (1050-1350)

(a) *Early Middle High German Poetry*.—The beginnings of Middle High German literature were hardly less tentative than those of the preceding period. The Saxon emperors, with their Latin and even Byzantine tastes, had made it extremely difficult to take up the thread where Notker let it drop. Williram of Ebersberg, the commentator of the *Song of Songs* (c. 1063), did certainly profit by Notker's example, but he stands alone. The Church had no helping hand to offer poetry, as in the more liberal epoch of the great Charles; for, at the middle of the 11th century, when the linguistic change from Old to Middle High German was taking place, a movement of religious asceticism, originating in the Burgundian monastery of Cluny, spread across Europe, and before long all the German peoples fell under its influence. For a century there was no room for any literature that did not place itself unreservedly at the service of the Church, a service which meant the complete abnegation of the brighter side of life. Repellent in their asceticism are, for instance, poems like *Memento mori* (c. 1050), *Vom Glauben*, a verse commentary on the creed by a monk Hartmann (c. 1120), and a poem on "the remembrance of death" (*Von des todes gehugede*) by *Heinrich von Melk* (c. 1150); only rarely, as in a few narrative

poems on Old Testament subjects, are the poets of this time able to forget for a time their lugubrious faith. In the *Enzlied* (c. 1060), a spirited lay by a monk of Bamberg on the life, miracles and death of Christ, and in the *Annolied* (c. 1080), a poem in praise of the archbishop Anno of Cologne, we find, however, some traces of a higher poetic imagination.

The transition from this rigid ecclesiastical spirit to a freer, more imaginative literature is to be seen in the lyric poetry inspired by the Virgin, in the legends of the saints which bulk so largely in the poetry of the 12th century, and in the general trend towards mysticism. Andreas, Pilatus, Aegidius, Albanus are the heroes of monkish romances of that age, and the stories of Sylvester and Crescentia form the most attractive parts of the *Kaiserchronik* (c. 1130-1150), a long, confused chronicle of the world which contains many elements common to later Middle High German poetry. The national sagas, of which the poet of the *Kaiserchronik* had not been oblivious, soon began to assert themselves in the popular literature. The wandering *Spilleute*, the lineal descendants of the jesters and minstrels of the dark ages, who were now rapidly becoming a factor of importance in literature, were here the innovators; to them we owe the romance of *König Rother* (c. 1160), and the kindred stories of *Orendel*, *Oswald* and *Salomon* and *Markolf* (*Salman und Mprolf*). All these poems bear witness to a new element, which in these years kindled the German imagination and helped to counteract the austerity of the religious faith—the Crusades. With what alacrity the Germans revelled in the wonderland of the East is to be seen especially in the *Alexanderlied* (c. 1130), and in *Herzog Ernst* (c. 1180), romances which point out the way to another important development of German medieval literature, the Court epic. The latter type of romance was the immediate product of the social conditions created by chivalry and, like chivalry itself, was determined and influenced by its French origin; so also was the version of the *Chanson de Roland* (*Rolandlied*, c. 1135), which we owe to another priest, Konrad of Regensburg, who, with considerable probability, has been identified with the author of the *Kaiserchronik*.

The Court epic was, however, more immediately ushered in by Eilhart von Oberge, a native of the neighbourhood of Hildesheim who, in his *Tristan* (c. 1170), chose that Arthurian type of romance which from now on was especially cultivated by the poets of the Court epic; and of equally early origin is a knightly romance of *Floris und Blancheffur*, another of the favourite love stories of the middle ages. In these years, too, the Beast epic, which had been represented by the Latin *Ecbasis captivi*, was reintroduced into Germany by an Alsatian monk, Heinrich der Gliechezere, who based his *Reinhart Fuchs* (c. 1180) on the French *Roman de Renart*. Lastly, we have to consider the beginning of the *Minnesang*, or lyric, which in the last decades of the 12th century burst out with extraordinary vigour in Austria and South Germany. The origins are obscure, and it is still debatable how much in the German *Minnesang* is indigenous and national, how much due to French and Provençal influence; for even in its earliest phases the *Minnesang* reveals correspondences with the contemporary lyric of the south of France. The freshness and originality of the early South German singers, such as Kurenberg, Dietmar von Eist, the Burggraf of Rietenburg and Meinloh von Sevelingen, are not, however, to be questioned; in spite of foreign influence, their verses make the impression of having been a spontaneous expression of German lyric feeling in the 12th century. The *Spruchdichtung*, a form of poetry which in this period is represented by at least two poets who call themselves Herger and "Der Spervogel," was less dependent on foreign models; the pointed and satirical strophes of these poets were the forerunners of a vast literature which did not reach its highest development until after literature had passed from the hands of the noble-born knight to those of the burgher of the towns.

(b) *The Flourishing of Middle High German Poetry*.—Such was the preparation for the extraordinarily brilliant, although brief epoch of German medieval poetry, which corresponded to the reigns of the Hohenstaufen emperors, Frederick I

Barbarossa, Henry VI. and Frederick II. These rulers, by their ambitious political aspirations and achievements, filled the German peoples with a sense of "world-mission," as the leading political power in medieval Europe. Docile pupils of French chivalry, the Germans had no sooner learned their lesson than they found themselves in the position of being able to dictate to the world of chivalry. In the same way, the German poets, who, in the 12th century, had been little better than clumsy translators of French romances, were able, at the beginning of the 13th, to substitute for French *chansons de geste* epics based on national sagas, to put a completely German imprint on the French Arthurian romance, and to sing German songs before which even the lyric of Provence paled. National epic, Court epic and Minnesang—these three types of medieval German literature, to which may be added as a subordinate group didactic poetry comprise virtually all that has come down to us in the Middle High German tongue. A Middle High German prose hardly existed, and the drama, such as it was, was still essentially Latin.

The first place among the National or Popular epics belongs to the *Nibelungenlied*, which received its present form in Austria about the turn of the 12th and 13th centuries. Combining, as it does, elements from various cycles of sagas—the lower Rhenish legend of Siegfried, the Burgundian saga of Gunther and Hagen, the Gothic saga of Dietrich and Etzel—it stands out as the most representative epic of German medieval life. And in literary power, dramatic intensity and singleness of purpose its eminence is no less unique. The vestiges of gradual growth—of irreconcilable elements imperfectly welded together—may not have been entirely effaced, but they in no way lessen the impression of unity which the poem leaves behind it; whoever the welder of the sagas may have been, he was clearly a poet of lofty imagination and high epic gifts (see *NIBELUNGENLIED*). Less imposing as a whole, but in parts no less powerful in its appeal to the modern mind, is the second of the German national epics, *Gudrun*, which was written early in the 13th century. This poem, as it has come down to us, is the work of an Austrian, but the subject belongs to a cycle of sagas which have their home on the shores of the North Sea. It seems almost a freak of chance that Siegfried, the hero of the Rhineland, should occupy so prominent a position in the *Nibelungenlied*, whereas Dietrich von Bern (i.e. of Verona), the name under which Theodoric the Great had been looked up to for centuries by the German people as their national hero, should have left the stamp of his personality on no single epic of the intrinsic worth of the *Nibelungenlied*. He appears, however, more or less in the background of a number of romances—*Die Rabenschlacht*, *Dietrichs Flucht*, *Alpharts Tod*, *Biterolf und Dietlieb*, *Laurin*, &c.—which make up what is usually called the *Heldenbuch*. It is tempting, indeed, to see in this very unequal collection the basis for what, under more favourable circumstances, might have developed into an epic even more completely representative of the German nation than the *Nibelungenlied*.

While the influence of the romance of chivalry is to be traced on all these popular epics, something of the manlier, more primitive ideals that animated German national poetry passed over to the second great group of German medieval poetry, the Court epic. The poet who, following Eilhart von Oberg's tentative beginnings, established the Court epic in Germany was Heinrich von Veldeke, a native of the district of the lower Rhine; his *Encid*, written between 1173 and 1186, is based on a French original. Other poets of the time, such as Herbot von Fritzlar, the author of a *Lied von Troje*, followed Heinrich's example, and selected French models for German poems on antique themes; while Albrecht von Halberstadt translated about the year 1210 the *Metamorphoses* of Ovid into German verse. With the three masters of the Court epic, Hartmann von Aue, Wolfram von Eschenbach and Gottfried von Strassburg—all of them contemporaries—the Arthurian cycle became the recognized theme of this type of romance, and the accepted embodiment of the ideals of the knightly classes. Hartmann was a Swabian, Wolfram a Bavarian, Gottfried presumably a

native of Strassburg. Hartmann, who in his *Erec* and *Iwein*, *Gregorius* and *Der arme Heinrich* combined a tendency towards religious asceticism with a desire to imbue the worldly life of the knight with a moral and religious spirit, provided the Court epic of the age with its best models; he had, of all the medieval court poets, the most delicate sense for the formal beauty of poetry, for language, verse and style. Wolfram and Gottfried, on the other hand, represent two extremes of poetic temperament. Wolfram's *Parzival* is filled with mysticism and obscure spiritual significance; its flashes of humour irradiate, although they can hardly be said to illumine, the gloom; its hero is, unconsciously, a symbol and allegory of much which to the poet himself must have been mysterious and inexplicable; in other words, *Parzival*—and Wolfram's other writings, *Willehalm* and *Titurel*, point in the same direction—is an instinctive or, to use Schiller's word, a "naïve" work of genius. Gottfried, again, is hardly less gifted and original, but he is a poet of a wholly different type. His *Tristan* is even more lucid than Hartmann's *Iwein*, his art is more objective; his delight in it is that of the conscious artist who sees his work growing under his hands. Gottfried's poem, in other words, is free from the obtrusion of those subjective elements which are in so high a degree characteristic of *Parzival*; in spite of the tragic character of the story, *Tristan* is radiant and serene, and yet uncontaminated by that tone of frivolity which the Renaissance introduced into love stories of this kind.

Parzival and *Tristan* are the two poles of the German Court epic, and the subsequent development of that epic stands under the influence of the three poets, Hartmann, Wolfram and Gottfried; according as the poets of the 13th century tend to imitate one or other of these, they fall into three classes. To the followers and imitators of Hartmann belong Ulrich von Zatzikhoven, the author of a *Lanzelet* (c. 1195); Wirt von Gravenberg, a Bavarian, whose *Wigalois* (c. 1205) shows considerable imaginative power; the versatile Spielmann, known as "Der Stricker"; and Heinrich von dem Türlin, author of an unwieldy epic, *Die Krone* ("the crown of all adventures," c. 1220). The fascination of Wolfram's mysticism is to be seen in *Der jüngere Titurel* of a Bavarian poet, Albrecht von Scharfenberg (c. 1270), and in the still later *Lohengrin* of an unknown poet; whereas Gottfried von Strassburg dominates the *Flöre und Blanschefur* of Konrad Fleck (c. 1220) and the voluminous romances of the two chief poets of the later 13th century, Rudolf von Ems, who died in 1254, and Konrad von Würzburg, who lived till 1287. Of these, Konrad alone carried on worthily the traditions of the great age, and even his art, which excels within the narrow limits of romances like *Die Herzemoere* and *Engelhard*, becomes diffuse and wearisome on the unlimited canvas of *Der Trojanerkrieg* and *Partonopier und Meliur*.

The most conspicuous changes which came over the narrative poetry of the 13th century were, on the one hand, a steady encroachment of realism on the matter and treatment of the epic, and, on the other, a leaning to didacticism. The substitution of the "history" of the chronicle for the confessedly imaginative stories of the earlier poets is to be seen in the work of Rudolf von Ems, and of a number of minor chroniclers like Ulrich von Eschenbach, Berthold von Holle and Jans Enikel; while for the growth of realism we may look to the *Pfaffe Amis*, a collection of comic anecdotes by "Der Stricker," the admirable peasant romance *Meier Helmbrecht*, written between 1236 and 1250 by Wernher der Gartenaere in Bavaria, and to the adventures of Ulrich von Lichtenstein, as described in his *Frauentienst* (1255) and *Frauenbuch* (1257).

More than any single poet of the Court epic, more even than the poet of the *Nibelungenlied*, Walther von der Vogelweide summed up in himself all that was best in the group of poetic literature with which he was associated—the Minnesang. The early Austrian singers already mentioned, poets like Heinrich von Veldeke, who in his lyrics, as in his epic, introduced the French conception of *Minne*, or like the manly Friedrich von Hausen, and the Swiss imitator of Provençal measures, Rudolf von Feins appear only in the light of forebears. Even those

original poets, like Heinrich von Morungen and Walther's own master, Reinmar von Hagenau, the author of harmonious but monotonously elegiac verses, or among immediate contemporaries, Hartmann von Aue and Wolfram von Eschenbach, whose few lyric strophes are as deeply stamped with his individuality as his epics—seem only tributary to the full rich stream of Walther's genius. There was not a form of the German Minnesang which Walther did not amplify and deepen; songs of courtly love and lowly love, of religious faith and delight in nature, patriotic songs and political *Sprüche*—in all he was a master. Of Walther's life we are somewhat better informed than in the case of his contemporaries: he was born about 1170 and died about 1230; his art he learned in Austria, whereupon he wandered through South Germany, a welcome guest wherever he went, although his vigorous championship of what he regarded as the national cause in the political struggles of the day won him foes as well as friends. For centuries he remained the accepted exemplar of German lyric poetry; not merely the Minnesänger who followed him, but also the Meistersinger of the 15th and 16th centuries looked up to him as one of the founders and lawgivers of their art. He was the most influential of all Germany's lyric poets, and in the breadth, originality and purity of his inspiration one of her greatest (see WALTHER VON DER VOGELWEIDE).

The development of the German Minnesang after Walther's death and under his influence is easily summed up. Contemporaries had been impressed by the dual character of Walther's lyric; they distinguished a higher courtly lyric, and a lower more outspoken form of song, free from the constraint of social or literary conventions. The later Minnesang emphasized this dualism. Amongst Walther's immediate contemporaries, high-born poets, whose lives were passed at courts, naturally cultivated the higher lyric; but the more gifted and original singers of the time rejoiced in the freedom of Walther's poetry of *niedere Minne*. It was, in fact, in accordance with the spirit of the age that the latter should have been Walther's most valuable legacy to his successors; and the greatest of these, Neidhart von Reuenthal (c. 1180-c. 1250), certainly did not allow himself to be hampered by aristocratic prejudices. Neidhart sought the themes of his *höfische Dorfpoesie* in the village, and, as the mood happened to dictate, depicted the peasant with humorous banter or biting satire. The lyric poets of the later 13th century were either, like Burkart von Hohenfels, Ulrich von Winterstetten and Gottfried von Neifen, echoes of Walther von der Vogelweide and of Neidhart, or their originality was confined to some particular form of lyric poetry in which they excelled. Thus the singer known as "Der Tannhäuser" distinguished himself as an imitator of the French *pastourelle*; Reinmar von Zweter was purely a *Spruchdichter*. More or less common to all is the consciousness that their own ideas and surroundings were no longer in harmony with the aristocratic world of chivalry, which the poets of the previous generation had glorified. The solid advantages, material prosperity and increasing comfort of life in the German towns appealed to poets like Steinmar von Klingenua more than the unworldly ideals of self-effacing knighthood which Ulrich von Lichtenstein and Johann Hadlaub of Zürich clung to so tenaciously and extolled so warmly. On the whole, the *Spruchdichter* came best out of this ordeal of changing fashions; and the increasing interest in the moral and didactic applications of literature favoured the development of this form of verse. The confusion of didactic purpose with the lyric is common to all the later poetry, to that of the learned Marner, of Boppe, Rumezland and Heinrich von Meissen, who was known to later generations as "Frauenlob." The *Spruchdichtung*, in fact, was one of the connecting links between the Minnesang of the 13th and the lyric and satiric poetry of the 15th and 16th centuries.

The disturbing and disintegrating element in the literature of the 13th century was thus the substitution of a utilitarian didacticism for the idealism of chivalry. In the early decades of that century, poems like *Der Wilsheke*, by a Bavarian, and *Der welsche Gast*, written in 1215-1216 by Thomasin von Zirclara (Zirclaria), a native of Friuli, still teach with uncompromis-

ing idealism the duties and virtues of the knightly life. But in the *Bescheidenheit* (c. 1215-1230) of a wandering singer, who called himself Freidank, we find for the first time an active antagonism to the unworldly code of chivalry and an unmistakable reflection of the changing social order, brought about by the rise of what we should now call the middle class. Freidank is the spokesman of the *Bürger*, and in his terse, witty verses may be traced the germs of German intellectual and literary development in the coming centuries—even of the Reformation itself. From the advent of Freidank onwards, the satiric and didactic poetry went the way of the epic; what it gained in quantity it lost in quality and concentration. The satires associated with the name of Seifried Helbling, an Austrian who wrote in the last fifteen years of the 13th century, and *Der Renner* by Hugo von Trimberg, written at the very end of the century, may be taken as characteristic of the later period, where terseness and incisive wit have given place to diffuse moralizing and allegory.

There is practically no Middle High German literature in prose; such prose as has come down to us—the tracts of David of Augsburg, the powerful sermons of Berthold von Regensburg (d. 1272), Germany's greatest medieval preacher, and several legal codes, as the *Sachsenspiegel* and *Schwabenspiegel*—only prove that the Germans of the 13th century had not yet realized the possibilities of prose as a medium of literary expression.

III. THE TRANSITION PERIOD (1350-1600)

(a) *The Fourteenth and Fifteenth Centuries.*—As is the case with all transitional periods of literary history, this epoch of German literature may be considered under two aspects: on the one hand, we may follow in it the decadence and disintegration of the literature of the Middle High German period; on the other, we may study the beginnings of modern forms of poetry and the preparation of that spiritual revolution, which meant hardly less to the Germanic peoples than the Renaissance to the Latin races—the Protestant Reformation.

By the middle of the 14th century, knighthood with its chivalric ideals was rapidly declining, and the conditions under which medieval poetry had flourished were passing away. The social change rendered the courtly epic of Arthur's Round Table in great measure incomprehensible to the younger generation, and made it difficult for them to understand the spirit that actuated the heroes of the national epic; the tastes to which the lyrics of the great Minnesingers had appealed were vitiated by the more practical demands of the rising middle classes. But the stories of chivalry still appealed as stories to the people, although the old way of telling them was no longer appreciated. The feeling for beauty of form and expression was lost; the craving for a moral purpose and didactic aim had to be satisfied at the cost of artistic beauty; and sensational incident was valued more highly than fine character-drawing or inspired poetic thought. Signs of the decadence are to be seen in the *Karlmeinet* of this period, stories from the youth of Charlemagne, in a continuation of *Parzival* by two Alsatians, Claus Wisse and Philipp Colin (c. 1335), in an *Apollonius von Tyrus* by Heinrich von Neuenstadt (c. 1315), and a *Königstochter von Frankreich* by Hans von Bühel (c. 1400). The story of Siegfried was retold in a rough ballad, *Das Lied von hürnen Seyfried*, the *Heldenbuch* was recast in *Knittelvers* or doggerel (1472), and even the Arthurian epic was parodied. A no less marked symptom of decadence is to be seen in a large body of allegorical poetry analogous to the *Roman de la rose* in France; Heinzelein of Constance, at the end of the 13th, and Hadamar von Laber and Hermann von Sachsenheim, about the middle of the 15th century, were representatives of this movement. As time went on, prose versions of the old stories became more general, and out of these developed the *Volksbücher*, such as *Loher und Maller*, *Die Haimonskinder*, *Die schöne Magelone*, *Melusine*, which formed the favourite reading of the German people for centuries. As the last monuments of the decadent narrative literature of the middle ages, we may regard the *Buch der Abenteuer* of Ulrich Füetzer, written at the end of the 15th century, and *Der Weiskönig* and *Tuerdank* by the emperor Maximilian I. (1459-1519),

printed in the early years of the 16th. At the beginning of the new epoch the Minnesang could still point to two masters able to maintain the great traditions of the 13th century, Hugo von Montfort (1357-1423) and Oswald von Wolkenstein (1367-1445); but as the lyric passed into the hands of the middle-class poets of the German towns, it was rapidly shorn of its essentially lyric qualities; *die Minne* gave place to moral and religious dogmatism, emphasis was laid on strict adherence to the rules of composition, and the simple forms of the older lyric were superseded by ingenious metrical distortions. Under the influence of writers like Heinrich von Meissen ("Frauenlob," c. 1250-1318) and Heinrich von Mügeln in the 14th century, like Muskatblut and Michael Beheim (1416-c. 1480) in the 15th, the Minnesang thus passed over into the Meistersang. In the later 15th and in the 16th centuries all the south German towns possessed flourishing Meistersinger schools in which the art of writing verse was taught and practised according to complicated rules, and it was the ambition of every gifted citizen to rise through the various grades from *Schüler* to *Meister* and to distinguish himself in the "singing contests" instituted by the schools.

Such are the decadent aspects of the once rich literature of the Middle High German period in the 14th and 15th centuries. Turning now to the more positive side of the literary movement, we have to note a revival of a popular lyric poetry—the *Volkslied*—which made the futility and artificiality of the Meistersang more apparent. Never before or since has Germany been able to point to such a rich harvest of popular poetry as is to be seen in the *Volkslieder* of these two centuries. Every form of popular poetry is to be found here—songs of love and war, hymns and drinking-songs, songs of spring and winter, historical ballads, as well as lyrics in which the old motives of the Minnesang reappear stripped of all artificiality. More obvious ties with the literature of the preceding age are to be seen in the development of the *Schwank* or comic anecdote. Collections of such stories, which range from the practical jokes of *Till Eulenspiegel* (1515), and the coarse witticisms of the *Pfaffe vom Kalenberg* (end of 14th century) and *Peter Leu* (1550), to the religious and didactic anecdotes of J. Pauli's *Schimpf und Ernst* (1522) or the more literary *Rothaugenbüchlein* (1555) of Jörg Wickram and the *Wendunmut* (1563 ff.) of H. W. Kirckhoff—these dominate in large measure the literature of the 15th and 16th centuries; they are the literary descendants of the medieval *Pfaffe Amis*, *Markolf* and *Reinhart Fuchs*. An important development of this type of popular literature is to be seen in the *Narrenschiff* of Sebastian Brant (1457-1521), where the humorous anecdote became a vehicle of the bitterest satire; Brant's own contempt for the vulgarity of the ignorant, and the deep, unsatisfied craving of all strata of society for a wider intellectual horizon and a more humane and dignified life, to which Brant gave voice, make the *Narrenschiff*, which appeared in 1494, a landmark on the way that led to the Reformation. Another form—the *Beast fable* and *Beast epic*—which is but sparingly represented in earlier times, appealed with peculiar force to the new generation. At the very close of the Middle High German period, Ulrich Boner had revived the Aesopic fable in his *Edelstein* (1349), translations of Aesop in the following century added to the popularity of the fable (*q.v.*), and in the century of the Reformation it became, in the hands of Burkard Waldis (*Esopus*, 1548) and Erasmus Alberus (*Buch von der Tugend und Weisheit*, 1550), a favourite instrument of satire and polemic. A still more attractive form of the *Beast fable* was the epic *Reinke de Vos*, which had been cultivated by Flemish poets in the 13th and 14th centuries and has come down to us in a Low Saxon translation, published at Lübeck in 1498. This, too, like Brant's poem, is a powerful satire on human folly, and is also, like the *Narrenschiff*, a harbinger of the coming Reformation.

A complete innovation was the drama (*q.v.*), which, as we have seen, had practically no existence in Middle High German times. As in all European literatures, it emerged slowly and with difficulty from its original subservience to the church liturgy. As time went on, the vernacular was substituted for the original Latin, and with increasing demands for pageantry, the scene

of the play was removed to the churchyard or the market-place; thus the opportunity arose in the 14th and 15th centuries for developing the *Weihnachtsspiel*, *Osternspiel* and *Passionsspiel* on secular lines. The enlargement of the scope of the religious play to include legends of the saints implied a further step in the direction of a complete separation of the drama from ecclesiastical ceremony. The most interesting example of this encroachment of the secular spirit is the *Spiel von Frau Jullen*—Jutta being the notorious Pope Joan—by an Alsatian, Dietrich Schernberg, in 1480. Meanwhile, in the 15th century, a beginning had been made of a drama entirely independent of the church. The mimic representations—originally allegorical in character—with which the people amused themselves at the great festivals of the year, and more especially in spring, were interspersed with dialogue, and performed on an improvised stage. This was the beginning of the *Fastnachtsspiel* or Shrovetide-play, the subject of which was a comic anecdote similar to those of the many collections of *Schwänke*. Amongst the earliest cultivators of the *Fastnachtsspiel* were Hans Rosenplüt (*fl. c. 1460*) and Hans Folz (*fl. c. 1510*), both of whom were associated with Nuremberg.

(b) *The Age of the Reformation*.—Promising as were these literary beginnings of the 15th century, the real significance of the period in Germany's intellectual history is to be sought outside literature, namely, in two forces which immediately prepared the way for the Reformation—mysticism and humanism. The former of these had been a more or less constant factor in German religious thought throughout the middle ages, but with Meister Eckhart (? 1260-1327), the most powerful and original of all the German mystics, with Heinrich Seuse or Suso (*c. 1300-1366*), and Johannes Tauler (*c. 1300-1361*), it became a clearly defined mental attitude towards religion; it was an essentially personal interpretation of Christianity, and, as such, was naturally conducive to the individual freedom which Protestantism ultimately realized. It is thus not to be wondered at that we should owe the early translations of the Bible into German—one was printed at Strassburg in 1466—to the mystics. Johann Geiler von Kaisersberg (1445-1510), a pupil of the humanists and a friend of Sebastian Brant, may be regarded as a link between Eckhart and the earlier mysticists and Luther. Humanism was transplanted to German soil with the foundation of the university of Prague in 1348, and it made even greater strides than mysticism. Its immediate influence, however, was restricted to the educated classes; the pre-Reformation humanists despised the vernacular and wrote and thought only in Latin. Thus although neither Johann Reuchlin of Pforzheim (1455-1522), nor even the patriotic Alsatian, Jakob Wimpfeling (or Wimpeling) (1450-1528)—not to mention the great Dutch humanist Erasmus of Rotterdam (1466-1536)—has a place in the history of German literature, their battle for liberalism in thought and scholarship against the narrow orthodoxy of the Church cleared the way for a healthy national literature among the German-speaking peoples. The incisive wit and irony of humanistic satire—we need only instance the *Epistolae obscurorum virorum* (1515-1517)—prevented the German satirists of the Reformation age from sinking entirely into that coarse brutality to which they were only too prone. To the influence of the humanists we also owe many translations from the Latin and Italian dating from the 15th century. Prominent among the writers who contributed to the group of literature were Niklas von Wyl, chancellor of Würtemberg, and his immediate contemporary Albrecht von Eyb (1420-1475).

Martin Luther (1483-1546), Germany's greatest man in this age of intellectual new-birth, demands a larger share of attention in a survey of literature than his religious and ecclesiastical activity would in itself justify, if only because the literary activity of the age cannot be regarded apart from him. From the *Volkslied* and the popular *Schwank* to satire and drama, literature turned exclusively round the Reformation which had been inaugurated on the 31st of October 1517 by Luther's publication of the *Theses against Indulgences* in Wittenberg. In his three tracts, *An den christlichen Adel deutscher Nation, De captivitate*

Babylonica ecclesias, and *Von der Freiheit eines Christenmenschen* (1520), Luther laid down his principles of reform, and in the following year resolutely refused to recant his heresies in a dramatic scene before the Council of Worms. Luther's Bible (1522-1534) had unique importance not merely for the religious and intellectual welfare of the German people, but also for their literature. It is in itself a literary monument, a German classic, and the culmination and justification of that movement which had supplanted the medieval knight by the burgher and swept away Middle High German poetry. Luther, well aware that his translation of the Bible must be the keystone to his work, gave himself endless pains to produce a thoroughly German work—German both in language and in spirit. It was important that the dialect into which the Bible was translated should be comprehensible over as wide an area as possible of the German-speaking world, and for this reason he took all possible care in choosing the vocabulary and forms of his *Gemeindeutsch*. The language of the Saxon chancery thus became, thanks to Luther's initiative, the basis of the modern High German literary language. As a hymn-writer (*Geistliche Lieder*, 1564), Luther was equally mindful of the importance of adapting himself to the popular tradition; and his hymns form the starting-point for a vast development of German religious poetry which did not reach its highest point until the following century.

The most powerful and virile literature of this age was the satire with which the losing side retaliated on the Protestant leaders. Amongst Luther's henchmen, Philipp Melancthon (1497-1560), the "praecceptor Germaniae," and Ulrich von Hutten (1488-1523) were powerful allies in the cause, but their intellectual sympathies were with the Latin humanists; and with the exception of some vigorous German prose and still more vigorous German verse by Hutten, both wrote in Latin. The satirical dramas of Niklas Manuel, a Swiss writer and the polemical fables of Erasmus Alberus (c. 1500-1553), on the other hand, were insignificant compared with the fierce assault on Protestantism by the Alsatian monk, Thomas Murner (1475-1537). The most unscrupulous of all German satirists, Murner shrank from no extremes of scurrility, his attacks on Luther reaching their culmination in the gross personalities of *Von dem lutherischen Narren* (1522). It was not until the following generation that the Protestant party could point to a satirist who in genius and power was at all comparable to Murner, namely, to Johann Fischart (c. 1550-c. 1591); but when Fischart's Rabelaisian humour is placed by the side of his predecessor's work, we see that, in spite of counter-reformations, the Protestant cause stood in a very different position in Fischart's day from that which it had occupied fifty years before. Fischart took his stand on the now firm union between humanism and Protestantism. His chief work, the *Affenheuerlich Neupengeheuerliche Geschichtsklitterung* (1575), a Germanization of the first book of Rabelais' satire, is a witty and ingenious monstrosity, a satirical comment on the life of the 16th century, not the virulent expression of party strife. The day of a personal and brutal type of satire was clearly over, and the writers of the later 16th century reverted more and more to the finer methods of the humanists. The satire of Bartholomaeus Ringwaldt (1530-1599) and of Georg Rollenhagen (1542-1600), author of the *Froschmeuseler* (1595), was more "literary" and less actual than even Fischart's.

On the whole, the form of literature which succeeded best in emancipating itself from the trammels of religious controversy in the 16th century was the drama. Protestantism proved favourable to its intellectual and literary development, and the humanists, who had always prided themselves on their imitations of Latin comedy, introduced into it a sense for form and proportion. The Latin school comedy in Germany was founded by J. Wimpfeling with his *Stylpho* (1470) and by J. Reuchlin with his witty adaptation of *Mattre Paulein* in his *Henno* (1498). In the 16th century the chief writers of Latin dramas were Thomas Kirchmair or Naogeorgus (1511-1563), Caspar Brulow (1585-1627), and Nikodemus Frischlin (1547-1590), who also wrote dramas in the vernacular. The work of these men bears testimony in its form and its choice of subjects to the close

relationship between Latin and German drama in the 16th century. One of the earliest focuses for a German drama inspired by the Reformation was Switzerland. In Basel, Pamphilus Gengenbach produced moralizing *Fastnachtsspiele* in 1515-1516; Niklas Manuel of Bern (1484-1530)—who has just been mentioned—employed the same type of play as a vehicle of pungent satire against the Mass and the sale of indulgences. But it was not long before the German drama benefited by the humanistic example: the *Parabell vom verlorenen Sohn* by Burkard Waldis (1527), the many dramas on the subject of *Susanna*—notably those of Sixt Birck (1532) and Paul Rebhun (1535)—and Frischlin's German plays are attempts to treat Biblical themes according to classic methods. In another of the important literary centres of the 16th century, however, in Nuremberg, the drama developed on indigenous lines. Hans Sachs (1494-1576), the Nuremberg cobbler and Meistersinger, the most productive writer of the age, went his own way; a voracious reader and an unwearied storyteller, he left behind him a vast literary legacy, embracing every form of popular literature from *Spruch* and *Schwank* to complicated *Meistergesang* and lengthy drama. He laid under contribution the rich Renaissance literature with which the humanistic translators had flooded Germany, and he became himself an ardent champion of the "Wittebergisch Nachtigall" Luther. But in the progressive movement of the German drama he played an even smaller rôle than his Swiss and Saxon contemporaries; for his tragedies and comedies are deficient in all dramatic qualities; they are only stories in dialogue. In the *Fastnachtsspiele*, where dramatic form is less essential than anecdotal point and brevity, he is to be seen at his best. Rich as the 16th century was in promise, the conditions for the development of a national drama were unfavourable. At the close of the century the influence of the English drama—brought to Germany by English actors—introduced the deficient dramatic and theatrical force into the humanistic and "narrative" drama which has just been considered. This is to be seen in the work of Jakob Ayer (d. 1605) and Duke Henry Julius of Brunswick (1564-1613). But unfortunately these beginnings had hardly made themselves felt when the full current of the Renaissance was diverted across Germany, bringing in its train the Senecan tragedy. Then came the Thirty Years' War, which completely destroyed the social conditions indispensable for the establishment of a theatre at once popular and national.

The novel was less successful than the drama in extricating itself from satire and religious controversy. Fischart was too dependent on foreign models and too erratic—at one time adapting Rabelais, at another translating the old heroic romance of *Amadis de Gaula*—to create a national form of German fiction in the 16th century; the most important novelist was a much less talented writer, the Alsatian Meistersinger and dramatist Jörg Wickram (d. c. 1560), who has been already mentioned as the author of a popular collection of anecdotes, the *Rottwegebüchlein*. His longer novels, *Der Knabenspiegel* (1554) and *Der Goldfaden* (1557), are in form, and especially in the importance they attach to psychological developments, the forerunners of the movement to which we owe the best works of German fiction in the 18th century. But Wickram stands alone. So inconsiderable, in fact, is the fiction of the Reformation age in Germany that we have to regard the old *Volksbücher* as its equivalent; and it is significant that of all the prose writings of this age, the book which affords the best insight into the temper and spirit of the Reformation was just one of these crude *Volksbücher*, namely, the famous story of the magician *Doctor Johann Faust*, published at Frankfort in 1587.

IV. THE RENAISSANCE (1600-1740)

The 17th century in Germany presents a complete contrast to its predecessor; the fact that it was the century of the Thirty Years' War, which devastated the country, crippled the prosperity of the towns, and threw back by many generations the social development of the people, explains much, but it can hardly be held entirely responsible for the intellectual apathy, the slavery

to foreign customs and foreign ideas, which stunted the growth of the nation. The freedom of Lutheranism degenerated into a paralyzing Lutheran orthodoxy which was as hostile to the "Freiheit eines Christenmenschen" as that Catholicism it had superseded; the idealism of the humanists degenerated in the same way into a dry, pedantic scholasticism which held the German mind in fetters until, at the very close of the century, Leibnitz set it free. Most disheartening of all, literature which in the 16th century had been so full of promise and had conformed with such aptitude to the new ideas, was in all its higher manifestations blighted by the dead hand of pseudo-classicism. The unkept literature of the Reformation age admittedly stood in need of guidance and discipline, but the 17th century made the fatal mistake of trying to impose the laws and rules of Romance literatures on a people of a purely Germanic stock.

There were, however, some branches of German poetry which escaped this foreign influence. The church hymn, continuing the great Lutheran traditions, rose in the 17th century to extraordinary richness both in quality and quantity. Paul Gerhardt (1607-1676), the greatest German hymn-writer, was only one of many Lutheran pastors who in this age contributed to the German hymnal. On the Catholic side, Angelus Silesius, or Johann Scheffler (1624-1677) showed what a wealth of poetry lay in the mystic speculations of Jakob Boehme, the gifted shoemaker of Görlitz (1575-1624), and author of the famous *Aurora, oder Morgenröte im Aufgang* (1612); while Friedrich von Spee (1591-1635), another leading Catholic poet of the century, cultivated the pastoral allegory of the Renaissance. The revival of mysticism associated with Boehme gradually spread through the whole religious life of the 17th century, Protestant as well as Catholic, and in the more specifically Protestant form of pietism, it became, at the close of the period, a force of moment in the literary revival. Besides the hymn, the Volkslied, which amidst the struggles and confusion of the great war bore witness to a steadily growing sense of patriotism, lay outside the domain of the literary theorists and dictators, and developed in its own way. But all else—if we except certain forms of fiction, which towards the end of the 17th century rose into prominence—stood completely under the sway of the Latin Renaissance.

The first focus of the movement was Heidelberg, which had been a centre of humanistic learning in the sixteenth century. Here, under the leadership of J. W. Zingref (1591-1635), a number of scholarly writers carried into practice that interest in the vernacular which had been shown a little earlier by the German translator of Marot, Paul Schede or Melissus, librarian in Heidelberg. The most important forerunner of Opitz was G. R. Weckherlin (1584-1653), a native of Württemberg who had spent the best part of his life in England; his *Oden und Gesänge* (1618-1619) ushered in the era of Renaissance poetry in Germany with a promise that was but indifferently fulfilled by his successors. Of these the greatest, or at least the most influential, was Martin Opitz (1597-1639). He was a native of Silesia and, as a student in Heidelberg, came into touch with Zingref's circle; subsequently, in the course of a visit to Holland, a more definite trend was given to his ideas by the example of the Dutch poet and scholar, Daniel Heinsius. As a poet, Opitz experimented with every form of recognized Renaissance poetry from ode and epic to pastoral romance and Senecan drama; but his poetry is for the most part devoid of inspiration; and his extraordinary fame among his contemporaries would be hard to understand, were it not that in his *Buch von der deutschen Poeserey* (1624) he gave the German Renaissance its theoretical textbook. In this tract, in which Opitz virtually reproduced in German the accepted dogmas of Renaissance theorists like Scaliger and Ronsard, he not merely justified his own mechanical verse-making, but also gave Germany a law-book which regulated her literature for a hundred years.

The work of Opitz as a reformer was furthered by another institution of Latin origin, namely, literary societies modelled on the *Accademia della Crusca* in Florence. These societies, of which the chief were the *Fruchtbringende Gesellschaft* or *Palmenorden* (founded 1617), the *Elbschwabenorden* in Hamburg

and the *Gekrönter Blumenorden an der Pegnitz* or *Gesellschaft der Pegnitzschüler* in Nuremberg, were the centres of literary activity during the unsettled years of the war. Although they produced much that was trivial—such as the extraordinary *Nürnbergischer Trichter* (1647-1653) by G. P. Harndörffer (1607-1658), a treatise which professed to turn out a fully equipped German poet in the space of six hours—these societies also did German letters an invaluable service by their attention to the language, one of their chief objects having been to purify the German language from foreign and un-German ingredients. J. G. Schottelius (1612-1676), for instance, wrote his epoch-making grammatical works with the avowed purpose of furthering the objects of the *Fruchtbringende Gesellschaft*. Meanwhile the poetic centre of gravity in Germany had shifted from Heidelberg to the extreme north-east, to Königsberg, where a group of academic poets gave practical expression to the Opitzian theory. Chief among them was Simon Dach (1605-1659), a gentle, elegiac writer on whom the laws of the *Buch von der deutschen Poeserey* did not lie too heavily. He, like his more manly and vigorous contemporary Paul Fleming (1609-1640), showed, one might say, that it was possible to write good and sincere poetry notwithstanding Opitz's mechanical rules.

In the previous century the most advanced form of literature had been satire, and under the new conditions the satiric vein still proved most productive; but it was no longer the full-blooded satire of the Reformation, or even the rich and luxuriant satiric fancy of Fischart, which found expression in the 17th century. Satire pure and simple was virtually only cultivated by two Low German poets, J. Lauremberg (1590-1658) and J. Rachel (1618-1666), of whom at least the latter was accepted by the Opitzian school; but the satiric spirit rose to higher things in the powerful and scathing sermons of J. B. Schupp (1610-1661), an outspoken Hamburg preacher, and in the scurrilous wit of the Viennese monk Abraham a Sancta Clara (1644-1709), who had inherited some of his predecessor Murner's intellectual gifts. Best of all are the epigrams of the most gifted of all the Silesian group of writers, Friedrich von Logau (1604-1655). Logau's three thousand epigrams (*Deutsche Sinngedichte*, 1654) afford a key to the intellectual temper of the 17th century; they are the epitome of their age. Here are to be seen reflected the vices of the time, its aping of French customs and its contempt for what was national and German; Logau held up to ridicule the vain bloodshed of the war in the interest of Christianity, and, although he praised Opitz, he was far from prostrating himself at the dictator's feet. Logau is an epigrammatist of the first rank, and perhaps the most remarkable product of the Renaissance movement in Germany.

Opitz found difficulty in providing Germany with a drama according to the classic canon. He had not himself ventured beyond translations of Sophocles and Seneca, and Johann Rist (1607-1667) in Hamburg, one of the few contemporary dramatists, had written plays more in the manner of Duke Heinrich Julius of Brunswick than of Opitz. It was not until after the latter's death that the chief dramatist of the Renaissance movement came forward in the person of Andreas Gryphius (1616-1664). Like Opitz, Gryphius also was a Silesian, and a poet of no mean ability, as is to be seen from his lyric poetry; but his tragedies, modelled on the stiff Senecan pattern, suffered from the lack of a theatre, and from his ignorance of the existence of a more highly developed drama in France, not to speak of England. As it was, he was content with Dutch models. In the field of comedy, where he was less hampered by theories of dramatic propriety, he allowed himself to benefit by the freedom of the Dutch farce and the comic effects of the English actors in Germany; in his *Horribilicribrifax* and *Herr Peter Squenta*—the latter an adaptation of the comic scenes of the *Midsummer Night's Dream*—Gryphius has produced the best German plays of the 17th century.

The German novel of the 17th century was, as has been already indicated, less hampered by Renaissance laws than other forms of literature, and although it was none the less at the mercy of foreign influence, that influence was more varied and manifold in its character. *Don Quixote* had been read

translated early in the 17th century, the picaresque romance had found its way to Germany at a still earlier date; while H. M. Moscherosch (1601-1669) in his *Gesichte Philanders von Silewald* (1642-1643) made the *Sneños* of Quevedo the basis for vivid pictures of the life of the time, interspersed with satire. The best German novel of the 17th century, *Der abenteuerliche Simplicissimus* (1669) by H. J. Christoffel von Grimmelshausen (c. 1625-1676), is a picaresque novel, but one that owed little more than its form to the Spaniards. It is in great measure the autobiography of its author, and describes with uncompromising realism the social disintegration and the horrors of the Thirty Years' War. But this remarkable book stands alone; Grimmelshausen's other writings are but further contributions to the same theme, and he left no disciples worthy of carrying on the tradition he had created. Christian Weise (1642-1708), rector of the Zittau gymnasium, wrote a few satirical novels, but his realism and satire are too obviously didactic. He is seen to better advantage in his dramas, of which he wrote more than fifty for performance by his scholars.

The real successor of *Simplicissimus* in Germany was the English *Robinson Crusoe*, a novel which, on its appearance, was immediately translated into German (1721); it called forth an extraordinary flood of imitations, the so-called "Robinsonaden," the vogue of which is even still kept alive by *Der schweizerische Robinson* of J. R. Wyss (1812 ff.). With the exception of J. G. Schnabel's *Insel Felsenburg* (1731-1743), the literary value of these imitations is slight. They represented, however, a healthier and more natural development of fiction than the "galant" romances which were introduced in the train of the Renaissance movement, and cultivated by writers like Philipp von Zesen (1619-1689), Duke Anton Ulrich of Brunswick (1633-1714), A. H. Buchholtz (1607-1671), H. A. von Ziegler (1653-1697)—author of the famous *Asiatische Banise* (1688)—and D. C. von Lohenstein (1635-1683), whose *Arminius* (1689-1690) is on the whole the most promising novel of this group. The last mentioned writer and Christian Hofmann von Hofmannswaldau (1617-1679) are sometimes regarded as the leaders of a "second Silesian school," as opposed to the first school of Opitz. As the cultivators of the bombastic and Euphuistic style of the Italians Guarini and Marini, and of the Spanish writer Gongora, Lohenstein and Hofmannswaldau touched the lowest point to which German poetry ever sank.

But this aberration of taste was happily of short duration. Although socially the recovery of the German people from the desolation of the war was slow and laborious, the intellectual life of Germany was rapidly recuperating under the influence of foreign thinkers. Samuel Pufendorf (1632-1694), Christian Thomasius (1655-1728), Christian von Wolff (1679-1754) and, above all, Gottfried Wilhelm Leibnitz (1646-1716), the first of the great German philosophers, laid the foundations of that system of rationalism which dominated Germany for the better part of the 18th century; while German religious life was strengthened and enriched by a revival of pietism, under mystic thinkers like Philipp Jakob Spener (1635-1705), a revival which also left its traces on religious poetry. Such hopeful signs of convalescence could not but be accompanied by an improvement in literary taste, and this is seen in the first instance in a substitution for the bombast and conceits of Lohenstein and Hofmannswaldau, of poetry on the stricter and soberer lines laid down by Boileau. The so-called "court poets" who opposed the second Silesian school, men like Rudolf von Canitz (1654-1699), Johann von Besser (1654-1729) and Benjamin Neukirch (1665-1729), were not inspired, but they had at least a certain "correctness" of taste; and from their midst sprang one gifted lyric genius, Johann Christian Günther (1695-1723), who wrote love-songs such as had not been heard in Germany since the days of the Minnesang. The methods of Hofmannswaldau had obtained considerable vogue in Hamburg, where the Italian opera kept the decadent Renaissance poetry alive. Here, however, the incisive wit of Christian Wernigke's (1661-1725) epigrams was an effective antidote, and Barthold Heinrich Brockes (1680-1747), a native of Hamburg, who had been deeply

impressed by the appreciation of nature in English poetry, gave the artificialities of the Silesians their death-blow. But the influence of English literature was not merely destructive in these years; in the translations and imitations of the English *Spectator*, *Tatler* and *Guardian*—the so-called *moralische Wechselschriften*—it helped to regenerate literary taste, and to implant healthy moral ideas in the German middle classes.

The chief representative of the literary movement inaugurated by the Silesian "court poets" was Johann Christoph Gottsched (1700-1766), who between 1724 and 1740 succeeded in establishing in Leipzig, the metropolis of German taste, literary reforms modelled on the principles of French 17th-century classicism. He reformed and purified the stage according to French ideas, and provided it with a repertory of French origin; in his *Kritische Dichtkunst* (1730) he laid down the principles according to which good literature was to be produced and judged. As Opitz had reformed German letters with the help of Ronsard, so now Gottsched took his standpoint on the principles of Boileau as interpreted by contemporary French critics and theorists. With Gottsched, whose services in purifying the German language have stood the test of time better than his literary or dramatic reforms, the period of German Renaissance literature reaches its culmination and at the same time its close. The movement of the age advanced too rapidly for the Leipzig dictator; in 1740 a new epoch opened in German poetry and he was soon left hopelessly behind.

V. THE CLASSICAL PERIOD OF MODERN GERMAN LITERATURE (1740-1832)

(a) *From the Swiss Controversy to the "Sturm und Drang."*—Between Opitz and Gottsched German literature passed successively through the various stages characteristic of all Renaissance literatures—from that represented by Trissino and the French *Pléiade*, by way of the aberrations of Marini and the *estilo culto*, to the *art poétique* of Boileau. And precisely as in France, the next advance was achieved in a battle between the "ancients" and the "moderns," the German "ancients" being represented by Gottsched, the "moderns" by the Swiss literary reformers, J. J. Bodmer (1698-1783) and J. J. Breitinger (1701-1776). The latter in his *Kritische Dichtkunst* (1739) maintained doctrines which were in opposition to Gottsched's standpoint in his treatise of the same name, and Bodmer supported his friend's initiative; a pamphlet war ensued between Leipzig and Zurich, with which in 1740-1741 the classical period of modern German literature may be said to open. The Swiss, men of little originality, found their theories in the writings of Italian and English critics; and from these they learned how literature might be freed from the fetters of pseudo-classicism. Basing their arguments on Milton's *Paradise Lost*, which Bodmer had translated into prose (1732), they demanded room for the play of genius and inspiration, they insisted that the imagination should not be hindered in its attempts to rise above the world of reason and common sense. Their victory was due, not to the skill with which they presented their arguments, but to the fact that literature itself was in need of greater freedom. It was in fact a triumph, not of personalities or of leaders, but of ideas. The effects of the controversy are to be seen in a group of Leipzig writers of Gottsched's own school, the *Bremer Beiträge* as they were called after their literary organ. These men—C. F. Gellert (1715-1769), the author of graceful fables and tales in verse, G. W. Rabener (1714-1771), the mild satirist of Saxon provinciality, the dramatist J. Elias Schlegel (1719-1749), who in more ways than one was Lessing's forerunner, and a number of minor writers—did not set themselves up in active opposition to their master, but they tacitly adopted many of the principles which the Swiss had advocated. And in the *Bremer Beiträge* there appeared in 1748 the first instalment of an epic by F. G. Klopstock (1724-1803), *Der Messias*, which was the best illustration of that lawlessness against which Gottsched had protested. More effectively than Bodmer's dry and uninspired theorizing, Klopstock's *Messias*, and in a still higher degree, his *Odes*, laid the foundations of modern German literature in the 18th century.

His immediate followers, it is true, did not help to advance matters; Bodmer and J. K. Lavater (1741-1801), whose "physiognomic" investigations interested Goethe at a later date, wrote dreary and now long forgotten epics on religious themes. Klopstock's rhapsodic dramas, together with Macpherson's *Ossian*, which in the 'sixties awakened a widespread enthusiasm throughout Germany, were responsible for the so-called "bardic" movement; but the noisy rhapsodies of the leaders of this movement, the "bards" H. W. von Gerstenberg (1737-1823), K. F. Kretschmann (1738-1800) and Michael Denis (1729-1800), had little of the poetic inspiration of Klopstock's *Odes*.

The indirect influence of Klopstock as the first inspired poet of modern Germany and as the realization of Bodmer's theories can, however, hardly be over-estimated. Under Frederick the Great, who, as the docile pupil of French culture, had little sympathy for unregulated displays of feeling, neither Klopstock nor his imitators were in favour in Berlin, but at the university of Halle considerable interest was taken in the movement inaugurated by Bodmer. Here, before Klopstock's name was known at all, two young poets, J. I. Pyra (1715-1744) and S. G. Lange (1711-1781), wrote *Freundschaftliche Lieder* (1737), which were direct forerunners of Klopstock's rhyemless lyric poetry; and although the later Prussian poets, J. W. L. Gleim (1719-1803), J. P. Uz (1720-1796) and J. N. Götze (1721-1781), who were associated with Halle, and K. W. Ramler (1725-1798) in Berlin, cultivated mainly the Anacreontic and the Horatian ode—artificial forms, which kept strictly within the classic canon—yet Friedrich von Hagedorn (1708-1754) in Hamburg showed to what perfection even the Anacreontic and the lighter *vers de société* could be brought. The Swiss physiologist Albrecht von Haller (1708-1777) was the first German poet to give expression to the beauty and sublimity of Alpine scenery (*Die Alpen*, 1734), and a Prussian officer, Ewald Christian von Kleist (1715-1759), author of *Der Frühling* (1749), wrote the most inspired nature-poetry of this period. Klopstock's supreme importance lay, however, in the fact that he was a forerunner of the movement of *Sturm und Drang*. But before turning to that movement we must consider two writers who, strictly speaking, also belong to the age under consideration—Lessing and Wieland.

As Klopstock had been the first of modern Germany's inspired poets, so Gotthold Ephraim Lessing (1729-1781) was the first critic who brought credit to the German name throughout Europe. He was the most liberal-minded exponent of 18th-century rationalism. Like his predecessor Gottsched, whom he vanquished more effectually than Bodmer had done, he had unwavering faith in the classic canon, but "classic" meant for him, as for his contemporary, J. J. Winckelmann (1717-1768), Greek art and literature, and not the products of French pseudo-classicism, which it had been Gottsched's object to foist on Germany. He went, indeed, still further, and asserted that Shakespeare, with all his irregularities, was a more faithful observer of the spirit of Aristotle's laws, and consequently a greater poet, than were the French classic writers. He looked to England and not to France for the regeneration of the German theatre, and his own dramas were pioneer-work in this direction. *Miss Sara Sampson* (1755) is a *bürgerliche Tragödie* on the lines of Lillo's *Merchant of London*, *Minna von Barnhelm* (1767), a comedy in the spirit of Farquhar; in *Emilia Galotti* (1772), again with English models in view, he remoulded the "tragedy of common life" in a form acceptable to the *Sturm und Drang*; and finally in *Nathan der Weise* (1779) he won acceptance for iambic blank verse as the medium of the higher drama. His two most promising disciples—J. F. von Cronqk (1731-1758) and J. W. von Brawe (1738-1758)—unfortunately died young, and C. F. Weiss (1726-1804) was not gifted enough to advance the drama in its literary aspects. Lessing's name is associated with Winckelmann's in *Laokoon* (1766), a treatise in which he set about defining the boundaries between painting, sculpture and poetry, and with those of the Jewish philosopher, Moses Mendelssohn (1729-1786) and the Berlin bookseller C. F. Nicolai (1733-1811) in the famous *Literaturbriefe*. Here Lessing identified

himself with the best critical principles of the rationalistic movement—principles which, in the later years of his life, he employed in a fierce onslaught on Lutheran orthodoxy and intolerance.

To the widening and deepening of the German imagination C. M. Wieland (1733-1813) also contributed, but in a different way. Although no enemy of pseudo-classicism, he broke with the stiff dogmatism of Gottsched and his friends, and tempered the pietism of Klopstock by introducing the Germans to the lighter poetry of the south of Europe. With the exception of his fairy epic *Oberon* (1780), Wieland's work has fallen into neglect; he did, however, excellent service to the development of German prose fiction with his psychological novel, *Agathon* (1766-1767), which may be regarded as a forerunner of Goethe's *Wilhelm Meister*, and with his humorous satire *Die Abderiten* (1774). Wieland had a considerable following, both among poets and prose writers; he was particularly looked up to in Austria, towards the end of the 18th century, where the literary movement advanced more slowly than in the north. Here Aloys Blumauer (1755-1780) and J. B. von Alxinger (1755-1797) wrote their travesties and epics under his influence. In Saxony, M. A. von Thümmel (1738-1817) showed his adherence to Wieland's school in his comic epic in prose, *Wilhelmine* (1764), and in the general tone of his prose writings; on the other hand, K. A. Kortum (1745-1824), author of the most popular comic epic of the time, *Die Jobsiade* (1784), was but little influenced by Wieland. The German novel owed much to the example of *Agathon*, but the groundwork and form were borrowed from English models; Gellert had begun by imitating Richardson in his *Schwedische Gräfin* (1747-1748), and he was followed by J. T. Hermes (1738-1821), by Wieland's friend Sophie von La Roche (1730-1807), by A. von Knigge (1752-1796) and J. K. A. Musäus (1735-1787), the last mentioned being, however, best known as the author of a collection of *Volksmärchen* (1782-1786). Meanwhile a rationalism, less materialistic and strict than that of Wolff, was spreading rapidly through educated middle-class society in Germany. Men like Knigge, Moses Mendelssohn, J. G. Zimmermann (1738-1795), T. G. von Hippel (1741-1796), Christian Garve (1742-1798), J. J. Engel (1741-1802), as well as the educational theorists J. B. Basedow (1723-1790) and J. H. Pestalozzi (1746-1827), wrote books and essays on "popular philosophy" which were as eagerly read as the *moralische Wochenschriften* of the preceding epoch; and with this group of writers must also be associated the most brilliant of German 18th-century satirists, G. C. Lichtenberg (1742-1799).

Such was the *milieu* from which sprang the most advanced pioneer of the classical epoch of modern German literature, J. G. Herder (1744-1803). The transition from the popular philosophers of the *Aufklärung* to Herder was due in the first instance to the influence of Rousseau; and in Germany itself that transition is represented by men like Thomas Abbt (1738-1766) and J. G. Hamann (1730-1788). The revolutionary nature of Herder's thought lay in that writer's antipathy to hard and fast systems, to laws imposed upon genius; he grasped, as no thinker before him, the idea of historical evolution. By regarding the human race as the product of a slow evolution from primitive conditions, he revolutionized the methods and standpoint of historical science and awakened an interest—for which, of course, Rousseau had prepared the way—in the early history of mankind. He himself collected and published the *Volkslieder* of all nations (1778-1779), and drew attention to those elements in German life and art which were, in the best and most precious sense, national—elements which his predecessors had despised as inconsistent with classic formulae and systems. Herder is thus not merely the forerunner, but the actual founder of the literary movement known as *Sturm und Drang*. New ground was broken in a similar way by a group of poets, who show the results of Klopstock's influence on the new literary movement: the Göttingen "Bund" or "Hain," a number of young students who met together in 1772, and for several years published their poetry in the *Göttinger Musenalmanach*. With the exception of the two brothers, Ch. zu Stolberg (1748-1821) and F. L. zu Stolberg (1750-1819), who occupied a somewhat peculiar position

in the "Bund," the members of this coterie were drawn from the peasant class of the lower *bourgeoisie*; J. H. Voss (1751-1826), the leader of the "Bund," was a typical North German peasant, and his idyll, *Luisie* (1784), gives a realistic picture of German provincial life. L. H. C. Höltz (1748-1776) and J. M. Miller (1750-1814), again, excelled in simple lyrics in the tone of the *Volkslied*. Closely associated with the Göttingen group were M. Claudius (1740-1815), the *Wandsbecker Bote*—as he was called after the journal he edited—an even more unassuming and homely representative of the German peasant in literature than Voss, and G. A. Bürger (1748-1794) who contributed to the *Göttinger Musenalmanach* ballads, such as the famous *Lenore* (1774), of the very first rank. These ballads were the best products of the Göttingen school, and, together with Goethe's Strassburg and Frankfurt songs, represent the highest point touched by the lyric and ballad poetry of the period.

But the Göttingen "Bund" stood somewhat aside from the main movement of literary development in Germany; it was only a phase of *Sturm und Drang*, and quieter, less turbulent than that on which Goethe had set the stamp of his personality. Johann Wolfgang Goethe (1749-1832) had, as a student in Leipzig (1765-1768), written lyrics in the Anacreontic vein and dramas in alexandrines. But in Strassburg, where he went to continue his studies in 1770-1771, he made the personal acquaintance of Herder, who won his interest for the new literary movement. Herder imbued him with his own ideas of the importance of primitive history and Gothic architecture and inspired him with a pride in German nationality; Herder convinced him that there was more genuine poetry in a simple Volkslied than in all the ingenuity of the German imitators of Horace or Anacreon; above all, he awakened his enthusiasm for Shakespeare. The pamphlet *Von deutscher Art und Kunst* (1773), to which, besides Goethe and Herder, the historian Justus Möser (1720-1794) also contributed, may be regarded as the manifesto of the *Sturm und Drang*. The effect on Goethe of the new ideas was instantaneous; they seemed at once to set his genius free, and from 1771 to 1775 he was extraordinarily fertile in poetic ideas and creations. His *Göts von Berlichingen* (1771-1773), the first drama of the *Sturm und Drang*, was followed within a year by the first novel of the movement, *Werthers Leiden* (1774); he dashed off *Clavigo* and *Stella* in a few weeks in 1774 and 1775, and wrote a large number of *Singspiele*, dramatic satires and fragments—including *Faust* in its earliest form (the so-called *Urfaust*)—not to mention love-songs which at last fulfilled the promise of Klopstock. Goethe's lyrics were no less epoch-making than his first drama and novel, for they put an end to the artificiality which for centuries had fettered German lyric expression. In all forms of literature he set the fashion to his time; the Shakespearian restlessness of *Göts von Berlichingen* found enthusiastic imitators in J. M. R. Lenz (1751-1792), whose *Anmerkungen übers Theater* (1774) formulated theoretically the laws, or defiance of laws, of the new drama, in F. M. von Klinger (1752-1832), J. A. Leisewitz (1752-1806), H. L. Wagner (1747-1779) and Friedrich Müller, better known as Maler Müller (1749-1825). The dramatic literature of the *Sturm und Drang* was its most characteristic product—indeed, the very name of the movement was borrowed from a play by Klinger; it was inspired, as *Göts von Berlichingen* had been, by the desire to present upon the stage figures of Shakespearian grandeur impelled and tortured by gigantic passions, all considerations of plot, construction and form being regarded as subordinate to the development of character. The fiction of the *Sturm und Drang*, again, was in its earlier stages dominated by *Werthers Leiden*, as may be seen in the novels of F. H. Jacobi (1743-1819) and J. M. Miller, who has been already mentioned. Later, in the hands of J. J. W. Heinse (1749-1803), author of *Ardinghelo* (1787), Klinger, K. Ph. Moritz (1757-1793), whose *Anton Reiser* (1785) clearly foreshadows *Wilhelm Meister*, it reflected not merely the sentimentalism, but also the philosophic and artistic ideas of the period.

With the production of *Die Räuber* (1781) by Johann Friedrich Schiller (1759-1805), the drama of the *Sturm und Drang* entered

upon a new development. Although hardly less turbulent in spirit than the work of Klinger and Leisewitz, Schiller's tragedy was more skillfully adapted to the exigencies of the theatre; his succeeding dramas, *Fiesco* and *Kabale und Liebe*, were also admirable stage-plays, and in *Don Carlos* (1787) he abandoned prose for the iambic blank verse which Lessing had made acceptable in *Nathan der Weise*. The "practical" character of the new drama is also to be seen in the work of Schiller's contemporary, O. von Gemmingen (1755-1836), the imitator of Diderot, in the excellent domestic dramas of the actors F. L. Schröder (1744-1816) and A. W. Iffland (1759-1814), and even in the popular medieval plays, the so-called *Ritterdramen* of which *Göts von Berlichingen* was the model. Germany owes to the *Sturm und Drang* her national theatre; permanent theatres were established in these years at Hamburg, Mannheim, Gotha, and even at Vienna, which, as may be seen from the dramas of C. H. von Ayrenhoff (1733-1819), had hardly then advanced beyond Gottsched's ideal of a national literature. The Hofburg-theater of Vienna, the greatest of all the German stages, was virtually founded in 1776.

(b) *German Classical Literature*.—The energy of the *Sturm und Drang*, which was essentially iconoclastic in its methods, soon exhausted itself. For Goethe this phase in his development came to an end with his departure for Weimar in 1775, while, after writing *Don Carlos* (1787), Schiller turned from poetry to the study of history and philosophy. These subjects occupied his attention almost exclusively for several years, and not until the very close of the century did he, under the stimulus of Goethe's friendship, return to the drama. The first ten years of Goethe's life in Weimar were comparatively unproductive; he had left the *Sturm und Drang* behind him; its developments, for which he himself had been primarily responsible, were distasteful to him; and he had not yet formed a new creed. Under the influence of the Weimar court, where classic or even pseudo-classic tastes prevailed, he was gradually finding his way to a form of literary art which should reconcile the humanistic ideals of the 18th century with the poetic models of ancient Greece. But he did not arrive at clearness in his ideas until after his sojourn in Italy (1786-1788), an episode of the first importance for his mental development. Italy was, in the first instance, a revelation to Goethe of the antique; he had gone to Italy to find realized what Winckelmann had taught, and here he conceived that ideal of a classic literature, which for the next twenty years dominated German literature and made Weimar its metropolis. In Italy he gave *Iphigenie auf Tauris* (1787) its final form, he completed *Egmont* (1788)—like the exactly contemporary *Don Carlos* of Schiller, a kind of bridge from *Sturm und Drang* to classicism—and all but finished *Torquato Tasso* (1790). *Wilhelm Meisters Lehrjahre* (1795-1796) bears testimony to the clear and decisive views which he had acquired on all questions of art and of the practical conduct of life.

Long before *Wilhelm Meister* appeared, however, German thought and literature had arrived at that stability and self-confidence which are the most essential elements in a great literary period. In the year of Lessing's death, 1781, Immanuel Kant (1724-1804), the great philosopher, had published his *Kritik der reinen Vernunft*, and this, together with the two later treatises, *Kritik der praktischen Vernunft* (1788) and *Kritik der Urteilskraft* (1790), placed the Germans in the front rank of thinking nations. Under the influence of Kant, Schiller turned from the study of history to that of philosophy and more especially aesthetics. His philosophic lyrics, his treatises on *Anmut und Würde*, on the *Ästhetische Erziehung des Menschen* (1795), and *Über naive und sentimentalische Dichtung* (1795) show, on the philosophic and the critical side, the movement of the century from the irresponsible subjectivity of *Sturm und Drang* to the calm idealism of classic attainment. In the same way, German historical writing had in these years, under the leadership of men like Justus Möser, Thomas Abbt, I. Iselin, F. C. Schlosser, Schiller himself and, greatest of all, Johanna von Müller (1757-1809), advanced from disconnected, unsystematic chronicling to a clearly thought-out philosophic and scientific method. I. C.

A. Forster (1754-1794), who had accompanied Cook round the world, and Alexander von Humboldt (1769-1859), gave Germany models of clear and lucid descriptive writing. In practical politics and economics, when once the unbalanced vagaries of undiluted Rousseauism had fallen into discredit, Germany produced much wise and temperate thinking which prevented the spread of the French Revolution to Germany, and provided a practical basis on which the social and political fabric could be built up anew, after the Revolution had made the old régime impossible in Europe. Men like Wilhelm von Humboldt (1767-1835) and the philosopher J. G. Fichte (1762-1814) were, in two widely different spheres, representative of this type of intellectual eminence.

Meanwhile, in 1794, that friendship between Goethe and Schiller had begun, which lasted, unbroken, until the younger poet's death in 1805. These years mark the summit of Goethe and Schiller's classicism, and the great epoch of Weimar's history as a literary focus. Schiller's treatises had provided a theoretical basis; his new journal, *Die Horen*, might be called the literary organ of the movement—although in this respect the subsequent *Musenalmannach*, in which the two poets published their magnificent ballad poetry, had more value. Goethe, as director of the ducal theatre, could to a great extent control dramatic production in Germany. Under his encouragement, Schiller turned from philosophy to poetry and wrote the splendid series of classic dramas beginning with the trilogy of *Wallenstein* and closing with *Wilhelm Tell* and the fragment of *Demetrius*; while to Goethe we owe, above all, the epic of *Hermann und Dorothea*. Less important were the latter's severely classical plays *Die natürliche Tochter* and *Pandora*; but it must not be forgotten that it was chiefly owing to Schiller's stimulus that in those years Goethe brought the first part of *Faust* (1808) to a conclusion.

Although acknowledged leaders of German letters, Goethe and Schiller had considerable opposition to contend with. The *Sturm und Drang* had by no means exhausted itself, and the representatives of the once dominant rationalistic movement were particularly arrogant and overbearing. The literature associated with both *Sturm und Drang* and rationalism was at this period palpably decadent; no comparison could be made between the magnificent achievements of Goethe and Schiller, or even of Herder and Wieland with the "family" dramas of Iffland, still less with the extraordinarily popular plays of A. von Kotzebue (1761-1819), or with those bustling medieval *Ritterdramen*, which were especially cultivated in south Germany. There is a wide gap between Moritz's *Anton Reiser* or the philosophic novels which Klingler wrote in his later years, and Goethe's *Meister*; nor can the once so fervently admired novels of Jean Paul Richter (1763-1825) take a very high place. Neither the fantastic humour nor the penetrating thoughts with which Richter's books are strewn make up for their lack of artistic form and interest; they are essentially products of *Sturm und Drang*. Lastly, in the province of lyric and epic poetry, it is impossible to regard poets like the gentle F. von Matthiäson (1761-1831), or the less inspired G. L. Kosegarten (1758-1818) and C. A. Tiedge (1752-1841), as worthily seconding the masterpieces of Goethe and Schiller. Thus when we speak of the greatness of Germany's classical period, we think mainly of the work of her two chief poets; the distance that separated them from their immediate contemporaries was enormous. Moreover, at the very close of the 18th century a new literary movement arose in admitted opposition to the classicism of Weimar, and to this movement, which first took definite form in the Romantic school, the sympathies of the younger generation turned. Just as in the previous generation the *Sturm und Drang* had been obliged to make way for a return to classic and impersonal principles of literary composition, so now the classicism of Goethe and Schiller, which had produced masterpieces like *Wallenstein* and *Hermann und Dorothea*, had to yield to a revival of individualism and subjectivity, which, in the form of Romanticism, profoundly influenced the literature of the whole 19th century.

(c) *The Romantic Movement*.—The first Romantic school, however, was founded, not as a protest against the classicism of

Weimar, with which its leaders were in essential sympathy, but against the shallow, utilitarian rationalism of Berlin. Ludwig Tieck (1773-1853), a leading member of the school, was in reality a belated *Stürmer und Dränger*, who in his early years had chafed under the unimaginative tastes of the Prussian capital, and sought for a positive faith to put in their place. Friedrich Hölderlin (1770-1843), one of the most gifted poets of this age, demonstrates no less clearly than Tieck the essential affinity between *Sturm und Drang* and Romanticism; he, too, forms a bridge from the one individualistic movement to the other. The theoretic basis of Romanticism was, however, established by the two brothers, August Wilhelm and Friedrich Schlegel (1767-1845 and 1772-1829), who, accepting, in great measure, Schiller's aesthetic conclusions, adapted them to the needs of their own more subjective attitude towards literature. While Schiller, like Lessing before him, insisted on the critic's right to sit in judgment according to a definite code of principles, these Romantic critics maintained that the first duty of criticism was to understand and appreciate; the right of genius to follow its natural bent was sacred. The *Hersensgeriessungen eines kunstliebenden Klosterbruders* by Tieck's school-friend W. H. Wackenroder (1773-1798) contained the Romantic art-theory, while the hymns and fragmentary novels of Friedrich von Hardenberg (known as Novalis, 1772-1801), and the dramas and fairy tales of Tieck, were the characteristic products of Romantic literature. The universal sympathies of the movement were exemplified by the many admirable translations—greatest of all, Schlegel's *Shakespeare* (1797-1810)—which were produced under its auspices. Romanticism was essentially conciliatory in its tendencies, that is to say, it aimed at a reconciliation of poetry with other provinces of social and intellectual life; the hard and fast boundaries which the older critics had set up as to what poetry might and might not do, were put aside, and the domain of literature was regarded as co-extensive with life itself; painting and music, philosophy and ethics, were all accepted as constituent elements of or aids to Romantic poetry. Fichte, and to a much greater extent, F. W. J. von Schelling (1775-1854) were the exponents of the Romantic doctrine in philosophy, while the theologian F. E. D. Schleiermacher (1768-1834) demonstrated how vital the revival of individualism was for religious thought.

The Romantic school, whose chief members were the brothers Schlegel, Tieck, Wackenroder and Novalis, was virtually founded in 1798, when the Schlegels began to publish their journal the *Athenaeum*; but the actual existence of the school was of very short duration. Wackenroder and Novalis died young, and by the year 1804 the other members were widely separated. Two years later, however, another phase of Romanticism became associated with the town of Heidelberg. The leaders of this second or younger Romantic school were K. Brentano (1778-1842), L. A. von Arnim (1781-1831) and J. J. von Görres (1776-1848), their organ, corresponding to the *Athenaeum*, was the *Zeitung für Einsiedler*, or *Tröst-Einsamkeit*, and their most characteristic production the collection of *Volkslieder*, published under the title *Des Knaben Wunderhorn* (1805-1808). Compared with the earlier school the Heidelberg writers were more practical and realistic, more faithful to nature and the commonplace life of everyday. They, too, were interested in the German past and in the middle ages, but they put aside the idealizing glasses of their predecessors and kept to historic truth; they wrote historical novels, not stories of an imaginary medieval world as Novalis had done, and when they collected *Volkslieder* and *Volksbücher*, they refrained from decking out the simple tradition with musical effects, or from heightening the poetic situation by "Romantic irony." Their immediate influence on German intellectual life was consequently greater; they stimulated and deepened the interest of the German people in their own past; and we owe to them the foundations of the study of German philology and medieval literature, both the brothers Jakob and Wilhelm Grimm (1785-1863 and 1786-1859) having been in touch with this circle in their early days. Again, the Heidelberg poets strengthened the national and patriotic spirit

of their people; they prepared the way for the rising against Napoleon, which culminated in the year 1813, and produced that outburst of patriotic song, associated with E. M. Arndt (1769-1860), K. Th. Körner (1791-1813) and M. von Schenkendorf (1783-1817).

The subsequent history of Romanticism stands in close relation to the Heidelberg school, and when, about 1809, the latter broke up, and Arnim and Brentano settled in Berlin, the Romantic movement followed two clearly marked lines of development, one north German, the other associated, with Württemberg. The Prussian capital, hotbed of rationalism as it was, had, from the first, been intimately associated with Romanticism; the first school had virtually been founded there, and north Germans, like Heinrich von Kleist (1777-1811) and Zacharias Werner (1768-1823) had done more for the development of the Romantic drama than had the members of either Romantic school. These men, and more especially Kleist, Prussia's greatest dramatic poet, showed how the capricious Romantic ideas could be brought into harmony with the classic tradition established by Schiller, how they could be rendered serviceable to the national theatre. At the same time, Berlin was not a favourable soil for the development of Romantic ideas, and the circle of poets which gathered round Arnim and Brentano there, either themselves demonstrated the decadence of these ideas, or their work contained elements which in subsequent years hastened the downfall of the movement. Friedrich de la Motte Fouqué (1777-1843), for instance, shows how easy it was for the medieval tastes of the Romanticists to degenerate into mediocre novels and plays, hardly richer in genuine poetry than were the productions of the later *Sturm und Drang*; and E. T. A. Hoffmann (1776-1822), powerful genius though he was, cultivated with preference in his stories, a morbid supernaturalism, which was only a decadent form of the early Romantic delight in the world of fairies and spirits. The lyric was less sensitive to baleful influences, but even here the north German Romantic circle could only point to one lyric poet of the first rank, J. von Eichendorff (1788-1857); while in the poetry of A. von Chamisso (1781-1838) the volatile Romantic spirituality is too often wanting. Others again, like Friedrich Rückert (1788-1866), sought the inspiration which Romanticism was no longer able to give, in the East; still another group, of which Wilhelm Müller (1794-1827) is the chief representative, followed Byron's example and awakened German sympathy for the oppressed Greeks and Poles.

Apart from Eichendorff, the vital lyric poetry of the third and last phase of Romanticism must be looked for in the Swabian school, which gathered round Uhland. Ludwig Uhland (1787-1862) was himself a disciple of the Heidelberg poets, and, in his lyrics and especially in his ballads, he succeeded in grafting the lyricism of the Romantic school on to the traditions of German ballad poetry which had been handed down from Bürger, Schiller and Goethe. But, as was the case with so many other disciples of the Heidelberg Romanticists, Uhland's interest in the German past was the serious interest of the scholar rather than the purely poetic interest of the earlier Romantic poets. The merit of the Swabian circle, the chief members of which were J. Kerner (1786-1862), G. Schwab (1792-1850), W. Waiblinger (1804-1830), W. Hauff (1802-1827) and, most gifted of all, E. Mörike (1804-1875) was that these writers preserved the Romantic traditions from the disintegrating influences to which their north German contemporaries were exposed. They introduced few new notes into lyric poetry, but they maintained the best traditions intact, and when, a generation later, the anti-Romantic movement of "Young Germany" had run its course, it was to Württemberg Germany looked for a revival of the old Romantic ideas.

Meanwhile, in the background of all these phases of Romantic evolution, through which Germany passed between 1768 and 1832, stands the majestic and imposing figure of Goethe. Personally he had in the early stages of the movement been opposed to that reversion to subjectivity and lawlessness which the first Romantic school seemed to him to represent; to the end of his life he regarded himself as a "classic," not a "romantic"

poet. But, on the other hand, he was too liberal-minded a thinker and critic to be oblivious to the fruitful influence of the new movement. Almost without exception he judged the young poets of the new century fairly, and treated them sympathetically and kindly; he was keenly alive to the new—and for the most part "unclassical"—development of literature in England, France and Italy; and his own published work, above all, the first part of *Faust* (1808), *Die Wahlverwandtschaften* (1800), *Dichtung und Wahrheit* (1811-1814, a final volume in 1833), *Westöstlicher Divan* (1819), *Wilhelm Meisters Wanderjahre* (1821-1829) and the second part of *Faust* (published in 1832 after the poet's death), stood in no antagonism to the Romantic ideas of their time. One might rather say that Goethe was the bond between the two fundamental literary movements of the German classical age; that his work achieved that reconciliation of "classic" and "romantic" which, rightly regarded, was the supreme aim of the Romantic school itself.

VI. GERMAN LITERATURE SINCE GOETHE (1832-1906)

(a) *Young Germany*.—With Goethe's death a great age in German poetry came to a close. Long before 1832 Romanticism had, as we have seen, begun to lose ground, and the July revolution of 1830, the effects of which were almost as keenly felt in Germany as in France, gave the movement its death-blow. Meanwhile the march of ideas in Germany itself had not been favourable to Romanticism. Schelling had given place to G. W. F. Hegel (1770-1831), now the dominant force in German philosophy, and the Hegelian metaphysics proved as unfruitful an influence on literature as that of Fichte and Schelling had been fruitful. The transference of Romantic ideas to the domain of practical religion and politics had proved reactionary in its effects; Romanticism became the cloak for a kind of Neo-catholicism, and Romantic politics, as enunciated by men like F. von Gentz (1764-1832) and Adam Müller (1779-1829), served as an apology for the Metternich régime in Austria. Only at the universities—in Göttingen, Heidelberg and Berlin—did the movement continue, in the best sense, to be productive; German philology, German historical science and German jurisprudence benefited by Romantic ideas, long after Romantic poetry had fallen into decay. The day of Romanticism was clearly over; but a return to the classic and humanitarian spirit of the 18th century was impossible. The social condition of Europe had been profoundly altered by the French Revolution; the rise of industrialism had created new economic problems, the march of science had overturned old prejudices. And in a still higher degree were the ideas which lay behind the social upheaval of the July revolution incompatible with a reversion in Germany to the conditions of Weimar classicism. There was, moreover, no disguising the fact that Goethe himself did not stand high with the younger generation of German writers who came into power after his death.

"Young Germany" did not form a school in the sense in which the word was used by the early Romanticists; the bond of union was rather the consequence of political persecution. In December 1835 the German "Bund" issued a decree suppressing the writings of the "literary school" known as "Young Germany," and mentioned by name Heinrich Heine, Karl Gutzkow, Ludolf Wienberg, Theodor Mundt and Heinrich Laube. Of these men, Heine (1797-1856) was by far the most famous. He had made his reputation in 1826 and 1827 with *Die Harzreise* and *Das Buch der Lieder*, both of which books show how deeply he was immersed in the Romantic traditions. But Heine felt perhaps more acutely than any other man of his time how the ground was slipping away from beneath his feet; he repudiated the Romantic movement and hailed the July revolution as the first stage in the "liberation of humanity"; while ultimately he sought in France the freedom and intellectual stimulus which Germany withheld from him. Heine suffered from having been born in an age of transition; he was unable to realize in a wholehearted way all that was good in the new movement, which he had embraced so warmly; his optimism was counteracted by doubts as to whether, after all, life had not been better in that

old Romantic Germany of his childhood for which, to the last, he retained so warm an affection. Personal disappointments and unhappiness added to the bitterness of Heine's nature, and the supremely gifted lyric poet and the hardly less gifted satirist were overshadowed by the cynic from whose biting wit nothing was safe.

Heine's contemporary and—although he was not mentioned in the decree against the school—fellow-fighter, Ludwig Börne (1786–1837), was a more characteristic representative of the "Young German" point of view; for he was free from Romantic prejudices. Börne gave vent to his enthusiasm for France in eloquent *Briefe aus Paris* (1830–1833), which form a landmark of importance in the development of German prose style. With Karl Gutzkow (1811–1878), who was considerably younger than either Heine or Börne, the more positive aspects of the "Young German" movement begin to be apparent. He, too, had become a man of letters under the influence of the July revolution, and with an early novel, *Wally, die Zweiflerin* (1835), which was then regarded as atheistic and immoral, he fought in the battle for the new ideas. His best literary work, however, was the comedies with which he enriched the German stage of the forties, and novels like *Die Ritter vom Geiste* (1850–1851), and *Der Zauberer von Rom* (1858–1861), which have to be considered in connexion with the later development of German fiction. Heinrich Laube (1806–1884), who, as the author of lengthy social novels, and *Reisenotellen* in the style of Heine's *Reisebilder*, was one of the leaders of the new movement, is now only remembered as Germany's greatest theatre-director. Laube's connexion (1850–1867) with the Burgtheater of Vienna forms one of the most brilliant periods in the history of the modern stage. Heine and Börne, Gutzkow and Laube—these were the leading spirits of "Young Germany"; in their train followed a host of lesser men, who to the present generation are hardly even names. In the domain of scholarship and learning the "Young German" movement was associated with the supremacy of Hegelianism, the leading spirits being D. F. Strauss (1808–1874), author of the *Leben Jesu* (1835), the historians G. G. Gervinus (1805–1871) and W. Menzel (1798–1873), and the philosopher L. A. Feuerbach (1804–1872), who, although a disciple of Hegel, ultimately helped to destroy the latter's influence.

Outside the immediate circle of "Young Germany," other tentative efforts were made to provide a substitute for the discredited literature of Romanticism. The historical novel, for instance, which Romanticists like Arnim had cultivated, fell at an early date under the influence of Sir Walter Scott; Wilhelm Hauff, Heinrich Zschokke (1771–1848) and K. Spindler (1796–1855) were the most prominent amidst the many imitators of the Scottish novelist. The drama, again, which since Kleist and Werner had been without definite principles, was, partly under Austrian influence, finding its way back to a condition of stability. In Germany proper, the men into whose hands it fell were, on the one hand, undisciplined geniuses such as C. D. Grabbe (1801–1836), or, on the other, poets with too little theatrical blood in their veins like K. L. Immermann (1796–1840), or with too much, like E. von Raupach (1784–1852), K. von Holtei (1798–1880) and Adolf Müllner (1774–1829)—the last named being the chief representative of the so-called *Schicksals-tragödie*. In those years the Germans were more seriously interested in their opera, which, under C. M. Weber, H. A. Marschner, A. Lortzing and O. Nicolai, remained faithful to the Romantic spirit. In Austria, however, the drama followed lines of its own; here, at the very beginning of the century, H. J. von Collin (1771–1811) attempted in *Regulus* and other works to substitute for the lifeless pseudo-classic tragedy of Ayrenhoff the classic style of Schiller. His attempt is the more interesting, as the long development that had taken place in Germany between Gottsched and Schiller was virtually unrepresented in Austrian literature. M. von Collin (1770–1824), a younger brother of H. J. von Collin, did a similar service for the Romantic drama. Franz Grillparzer (1791–1872), Austria's greatest poet, began in the school of Müllner with a "fate

drama," but soon won an independent place for himself; more successfully than any other dramatist of the century, he carried out that task which Kleist had first seriously faced, the reconciliation of the classicism of Goethe and Schiller with the Romantic and modern spirit of the 19th century. It is from this point of view that works like *Das goldene Vlies* (1820), *König Ottokars Glück und Ende* (1825), *Der Traum, ein Leben* (1834) and *Des Meeres und der Liebe Wellen* (1831) must be regarded. As far as the poetic drama was concerned, Grillparzer stood alone, for E. F. J. von Münch-Bellinghausen (1806–1871), his most promising contemporary, once so popular under the pseudonym of Friedrich Halm, soon fell back into the trivial sentimentality of the later Romanticists. In other forms of dramatic literature Austria could point to many distinguished writers, notably the comedy-writer, E. von Bauernfeld (1802–1890), while a host of playwrights, chief of whom were F. Raimund (1790–1836) and J. Nestroy (1801–1862), cultivated the popular Viennese farce and fairy-play. Thus, in spite of Metternich's censorship of the drama, the Viennese theatre was, in the first half of the 19th century, in closer touch with literature than that of any other German centre.

The transitional character of the age is best illustrated by two eminent writers whom outward circumstances rather than any similarity of character and aim have classed together. These were K. L. Immermann, who has been already mentioned, and A. von Platen-Hallermund (1796–1835). Immermann's dramas were of little practical value to the theatre, but one at least, *Merlin* (1832), is a dramatic poem of great beauty. In his novels, however, *Die Epigonen* (1836) and *Münchhausen* (1838–1839), Immermann was the spokesman of his time. He looked backwards rather than forwards; he saw himself as the belated follower of a great literary age rather than as the pioneer of a new one. The bankruptcy of Romanticism and the poetically arid era of "Young Germany" left him little confidence in the future. Platen, on the other hand, went his own way; he, too, was the antagonist both of Romanticism and "Young Germany," and with Immermann himself he came into sharp conflict. But in his poetry he showed himself indifferent to the strife of contending literary schools. He began as an imitator of the German oriental poets—the only Romanticists with whom he had any personal sympathy—and with his matchless *Sonette aus Venedig* (1825) he stands out as a master in the art of verse-writing and as the least subjective of all German lyric-poets. In the imitation of Romance metres he sought a refuge from the extravagances and excesses of the Romantic decadence.

Meanwhile the political side of the "Young German" movement, which the German Bund aimed at stamping out, gained rapidly in importance under the influence of the unsettled political conditions between the revolutions of 1830 and 1848. The early forties were in German literature marked by an extraordinary outburst of political poetry, which may be aptly compared with the national and patriotic lyric evoked by the year 1813. The principles which triumphed in France at the revolution of 1848 were, to a great extent, fought out by the German singers of 1841 and 1842. Begun by mediocre talents like N. Becker (1809–1845) and R. E. Prutz (1816–1872), the movement found a vigorous champion in Georg Herwegh (1817–1875), who in his turn succeeded in winning Ferdinand Freiligrath (1810–1876) for the revolutionary cause. Others joined in the cry for freedom—F. Dingelstedt (1814–1881), A. H. Hoffmann von Fallersleben (1798–1874), and a number of Austrians, who had even more reason for rebellion and discontent than the north Germans. But the best Austrian political poetry, the *Spaziergänge eines Wiener Poeten*, 1831, by "Anastasio Grün" (Graf A. A. von Auersperg, 1806–1876), belonged to a decade earlier. The political lyric culminated in and ended with the year 1848; the revolutionists of the forties were, if not appeased, at least silenced by the revolution which in their eyes had effected so little. If Freiligrath be excepted, the chief lyric poets of this epoch stood aside from the revolutionary movement; even E. Geibel (1815–1884), the representative poet of the succeeding age, was only temporarily interested in the political

movement, and his best work is of a purely lyric character. M. von Strachwitz's (1822-1847) promising talent did not flourish in the political atmosphere; Annette von Droste-Hülshoff (1797-1848), and the Austrian, Nikolaus Lenau (1802-1850), both stand far removed from the world of politics; they are imbued with that pessimistic resignation which is, more or less, characteristic of all German literature between 1850 and 1870.

(b) *Mid-Century Literature.*—When once the revolution of 1848 was over, a spirit of tranquillity came over German letters; but it was due rather to the absence of confidence in the future than to any hopefulness or real content. The literature of the middle of the century was not wanting in achievement, but there was nothing buoyant or youthful about it; most significant of all, the generation between 1848 and 1880 was either oblivious or indifferent to the good work and to the new and germinating ideas which it produced. Hegel, who held the earlier half of the 19th century in his ban, was still all-powerful in the universities, but his power was on the wane in literature and public life. The so-called "Hegelian Left" had advanced so far as to have become incompatible with the original Hegelianism; the new social and economic theories did not fit into the scheme of Hegelian collectivism; the interest in natural science—fostered by the popular books of J. Moleschott (1822-1893), Karl Vogt (1817-1895) and Ludwig Büchner (1824-1899)—created a healthy antidote to the Hegelian metaphysics. In literature and art, on which Hegel, as we have seen, had exerted so blighting an influence, his place was taken by the chief exponent of philosophic pessimism, Arthur Schopenhauer (1788-1860). Schopenhauer's antagonism to Hegelianism was of old standing, for his chief work, *Die Welt als Wille und Vorstellung*, had appeared as far back as 1819; but the century was more than half over before the movement of ideas had, as it were, caught up with him, before pessimism became a dominant force in intellectual life.

The literature produced between 1850 and 1870 was pre-eminently one of prose fiction. The beginnings which the "Young German" school had made to a type of novel dealing with social problems—the best example is Gutzkow's *Ritter vom Geiste*—developed rapidly in this succeeding epoch. Friedrich Spielhagen (born 1829) followed immediately in Gutzkow's footsteps, and in a series of romances from *Problematische Naturen* (1860) to *Sturmflut* (1876), discussed in a militant spirit that recalls Laube and Gutzkow the social problems which agitated German life in these decades. Gustav Freytag (1816-1895), although an older man, freed himself more successfully from the "Young German" tradition; his romance of German commercialism, *Soll und Haben* (1855), is the masterpiece of mid-century fiction of this class. Less successful was Freytag's subsequent attempt to transfer his method to the milieu of German academic life in *Die verlorene Handschrift* (1864). As was perhaps only natural in an age of social and political interests, the historical novel occupies a subordinate place. The influence of Scott, which in the earlier period had been strong, produced only one writer, Wilhelm Häring ("Willibald Alexis," 1798-1871), who was more than a mere imitator of the Scottish master. In the series of six novels, from *Der Roland von Berlin* to *Dorothe*, which Alexis published between 1840 and 1856, he gave Germany, and more particularly Prussia, a historical fiction which might not unworthily be compared with the *Waverley Novels*. But Alexis had no successor, and the historical novel soon made way for a type of fiction in which the accurate reproduction of remote conditions was held of more account than poetic inspiration or artistic power. Such are the "antiquarian" novels of ancient Egyptian life by Georg Ebers (1837-1898), and those from primitive German history by Felix Dahn (born 1834). The vogue of historical fiction was also transferred to some extent, as in English literature, to novels of American life and adventure, of which the chief German cultivators were K. A. Postl, who wrote under the pseudonym of Charles Sealsfield (1793-1864) and Friedrich Gerstäcker (1816-1872).

Of greater importance was the fiction which owed its inspiration to the Romantic traditions that survived the "Young German" age. To this group belongs the novel of peasant and provincial life, of which Immermann had given an excellent example in *Der Oberhof*, a story included in the arabesque of *Münchhausen*. A Swiss pastor, Albrecht Bitzias, better known by his pseudonym "Jeremias Gotthelf" (1797-1854), was, however, the real founder of this class of romance; and his simple, unvarnished and naively didactic stories of the Swiss peasant were followed not long afterwards by the more famous *Schwarzwälder Dorfgeschichten* (1843-1854) of Berthold Auerbach (1812-1882). Auerbach is not by any means so naive and realistic as Gotthelf, nor is his work free from tendencies and ideas which recall "Young German" rationalism rather than the unsophisticated life of the Black Forest; but the *Schwarzwälder Dorfgeschichten* exerted a decisive influence; they were the forerunners of a large body of peasant literature which described with affectionate sympathy and with a liberal admixture of dialect, south German village life. With this group of writers may also be associated the German Bohemian, A. Stifter (1805-1868), who has called up unforgettable pictures and impressions of the life and scenery of his home.

Meanwhile, the Low German peoples also benefited by the revival of an interest in dialect and peasant life; it is to the credit of Fritz Reuter (1810-1874) that he brought honour to the Plattdeutsch of the north, the dialects of which had played a fitful, but by no means negligible rôle in the earlier history of German letters. His Mecklenburg novels, especially *Ull de Franzesentid* (1860), *Ull mine Festungstid* (1863) and *Ull mine Stromtid* (1862-1864), are a faithful reflection of Mecklenburg life and temperament, and hold their place beside the best German fiction of the period. What Reuter did for Plattdeutsch prose, his contemporary, Klaus Groth (1819-1899), the author of *Quickborn* (1852), did for its verse. We owe, however, the best German prose fiction of these years to two writers, whose affinity with the older Romanticists was closer. The north German, Theodor Storm (1817-1888) is the author of a series of short stories of delicate, lyric inspiration, steeped in that elegiac Romanticism which harmonized so well with mid-century pessimism in Germany. Gottfried Keller (1819-1890), on the other hand, a native of Zürich, was a modern Romanticist of a robust type; his magnificent autobiographical novel, *Der grüne Heinrich* (1854-1855), might be described as the last in the great line of Romantic fiction that had begun with *Wilhelm Meister*, and the short stories, *Die Leute von Seldwyla* (1856-1874) and *Züricher Novellen* (1878) are masterpieces of the first rank.

In the dramatic literature of these decades, at least as it was reflected in the repertoires of the German theatres, there was little promise. French influence was, in general, predominant; French translations formed the mainstay of the theatre-directors, while successful German playwrights, such as R. Benedix (1811-1873) and Charlotte Birch-Pfeiffer (1800-1868), have little claim to consideration in a literary survey. Gustav Freytag's admirable comedy, *Die Journalisten* (1852), was one of the rare exceptions. But the German drama of this epoch is not to be judged solely by the theatres. At the middle of the century Germany could point to two writers who, each in his way, contributed very materially to the development of the modern drama. These were Friedrich Hebbel (1813-1863) and Otto Ludwig (1813-1865). Both of these men, as a later generation discovered, were the pioneers of that dramatic literature which at the close of the century accepted the canons of realism and aimed at superseding outward effects by psychological conflicts and problems of social life. Hebbel, especially, must be regarded as the most original and revolutionary German dramatist of the 19th century. Unlike his contemporary Grillparzer, whose aim had been to reconcile the "classic" and the "romantic" drama with the help of Spanish models, Hebbel laid the foundations of a psychological and social drama, of which the most modern interpreter has been Henrik Ibsen. Hebbel's first tragedy, *Judith*, appeared in 1840, his masterpieces, *Herold*

und Marianne, Agnes Bernauer, Gyges und sein Ring, and the trilogy of *Die Nibelungen* between 1850 and 1862.

In this period of somewhat confused literary striving, there is, however, one body of writers who might be grouped together as a school, although the designation must be regarded rather as an outward accident of union than as implying conformity of aims. This is the group which Maximilian II. of Bavaria gathered round him in Munich between 1852 and 1860. A leading spirit of the group was Emanuel Geibel, who, as we have seen, set a model to the German lyric in this age; F. von Bodenstedt (1810-1892), the popular author of *Mirza Schaffy*; and J. V. von Scheffel (1826-1886), who, in his verse-romance, *Der Trompeter von Säckingen* (1854), broke a lance for a type of literature which had been cultivated somewhat earlier, but with no very conspicuous success, by men like O. von Redwitz (1823-1891) and G. Kinkel (1815-1882). The romance was, in fact, one of the favourite vehicles of poetic expression of the Munich school, its most successful exponents being J. Wolff (b. 1834) and R. Baumbach (1840-1905); while others, such as H. Lingg (1820-1905) and R. Hamerling (1830-1889) devoted themselves to the more ambitious epic. The general tone of the literary movement was pessimistic, the hopelessness of the spiritual outlook being most deeply engrained in the verse of H. Lorm (pseudonym for Heinrich Landesmann, 1821-1902) and H. Leuthold (1827-1879). On the whole, the most important member of the Munich group is Paul Heyse (b. 1830), who, as a writer of "Novellen" or short stories, may be classed with Storm and Keller. An essentially Latin genius, Heyse excels in stories of Italian life, where his lightness of touch and sense of form are shown to best advantage; but he has also written several long novels. Of these, *Kinder der Welt* (1873) and, in a lesser degree, *Im Paradiese* (1875), sum up the spirit and tendency of their time, just as, in earlier decades, *Die Ritter vom Geiste*, *Problematische Naturen* and *Soll und Haben* were characteristic of the periods which produced them.

(c) *German Literature after 1870.*—In the years immediately following the Franco-German War, the prevailing conditions were unfavourable to literary production in Germany, and the re-establishment of the empire left comparatively little trace on the national literature. All minds were for a time engrossed by the *Kulturkampf*, by the financial difficulties—the so-called *Gründerium*—due to unscrupulous speculation, and, finally, by the rapid rise of social democracy as a political force. The intellectual basis of the latter movement was laid by Ferdinand Lassalle (1825-1864) and Karl Marx (1818-1883), author of *Das Kapital* (vol. I, 1867). But even had such disturbing elements been wanting, the general tone of German intellectual life at that time was not buoyant enough to inspire a vigorous literary revival. The influence of Hegel was still strong, and the "historical" method, as enunciated in *Der alte und der neue Glaube* (1872) by the Hegelian D. F. Strauss, was generally accepted at the German universities. To many the compromise which H. Lotze (1817-1881) had attempted to establish between science and metaphysics, came as a relief from the Hegelian tradition, but in literature and art the dominant force was still, as before the war, the philosophy of Schopenhauer. In his *Philosophie des Unbewusstten* (1869), E. von Hartmann (1842-1906) endeavoured to bring pessimism into harmony with idealism. In lyric poetry, the dull monotony was broken by the excitement of the war, and the singers of the revolution of 1848 were among the first to welcome the triumph and unification of Germany. At the same time, men of the older generation, like Herwegh, Freiligrath and Geibel could ill conceal a certain disappointment with the new régime; the united Germany of 1871 was not what they had dreamed of in their youth, when all hopes were set on the Frankfort parliament.

The novel continued to be what it was before 1870, the most vigorous form of German literature, but the novelists who were popular in the early 'seventies were all older men. Laube, Gutzkow and Auerbach were still writing; Fritz Reuter was a universal favourite; while among the writers of short stories, Storm, who, between 1877 and 1888, put the crown to his work

with his *Chroniknovellen*, and Paul Heyse were the acknowledged masters. It was not until at least a decade later that the genius of Gottfried Keller was generally recognized. The historical novel seemed, in those days, beyond hope of revival. Gustav Freytag, it is true, had made the attempt in *Die Ahnen* (1872-1881), a number of independent historical romances linked together to form an ambitious prose epic; but there was more of the spirit of Ebers and Dahn in Freytag's work than of the spacious art of Scott, or of Scott's disciple, Willibald Alexis.

The drama of the 'seventies was in an even less hopeful condition than during the preceding period. The classical iambic tragedy was cultivated by the Munich school, by A. Wilbrandt (b. 1837), A. Lindner (1831-1888), H. Kruse (1815-1902), by the Austrian F. Nissel (1831-1893), and A. Fitger (b. 1840); but it was characteristic of the time that Halm was popular, while Hebbel and Grillparzer were neglected, it might even be said ignored. The most gifted German dramatist belonging exclusively to the decade between 1870 and 1880 was an Austrian, Ludwig Anzengruber (1830-1889), whose *Pfarrer von Kirchfeld* (1870) recalled the controversies of the *Kulturkampf*. This was Anzengruber's first drama, and it was followed by a series of powerful plays dealing with the life of the Austrian peasant; Anzengruber was, indeed, one of the ablest exponents of that village life, which had attracted so many gifted writers since the days of Goethe and Auerbach. But the really popular dramatists of this epoch were either writers who, like Benedix in the older generation, cultivated the *bourgeoisie* comedy—A. L'Arronge (b. 1838), G. von Moser (1825-1903), F. von Schönthan (b. 1849) and O. Blumenthal (b. 1852)—or playwrights, of whom P. Lindau (b. 1839) may be regarded as representative, who imitated French models. The only sign of progress in the dramatic history of this period was the marked improvement of the German stage, an improvement due, on the one hand, to the artistic reforms introduced by the duke of Meiningen in the Court theatre at Meiningen, and, on the other hand, to the ideals of a national theatre realized at Bayreuth by Richard Wagner (1813-1883). The greatest composer of the later 19th century is also one of Germany's leading dramatists; and the first performance of the trilogy *Der Ring der Nibelungen* at Bayreuth in the summer of 1876 may be said to have inaugurated the latest epoch in the history of the German drama.

The last fifteen or twenty years of the 19th century were distinguished in Germany by a remarkable literary activity. Among the younger generation, which was growing up as citizens of the united German empire, a more hopeful and optimistic spirit prevailed. The influence of Schopenhauer was on the wane, and at the universities Hegelianism had lost its former hold. The sponsor of the new philosophic movement was Kant, the master of 18th-century "enlightenment," and under the influence of the "neo-Kantian" movement, not merely German school philosophy, but theology also, was imbued with a healthier spirit. L. von Ranke (1795-1886) was still the dominant force in German historical science, and between 1881 and 1888 nine volumes appeared of his last great work, *Weltgeschichte*. Other historians of the period were H. von Sybel (1817-1895) and H. von Treitschke (1834-1896), the latter a vigorous and inspiring spokesman of the new political conditions; while J. Burckhardt (1818-1897), author of the masterly *Kultur der Renaissance in Italien* (1860) and the friend of Nietzsche, exerted an influence on German thought which was not confined to academic circles. Literary criticism perhaps benefited most of all by the dethronement of Hegel and the more objective attitude towards Schopenhauer; it seemed as if in this epoch the Germans first formed definite ideas—and ideas which were acceptable and accepted outside Germany—as to the rank and merits of their great poets. A marked change came over the nation's attitude towards Goethe, a poet to whom, as we have seen, neither the era of Hegel nor that of Schopenhauer had been favourable; Schiller was regarded with less national prejudice, and—most important of all—amends were made by the new generation for the earlier neglect of Kleist, Grillparzer, Hebbel and Keller.

The thinker and poet who most completely embodies the spirit

of this period—who dealt the Hegelian metaphysics its death-blow as far as its wider influence was concerned—was Friedrich Nietzsche (1844-1900). Nietzsche had begun as a disciple of Schopenhauer and a friend of Wagner, and he ultimately became the champion of an individualistic and optimistic philosophy which formed the sharpest possible contrast to mid-century pessimism. The individual, not the race, the *Herrenmensch*, not the slave, self-assertion, not self-denying renunciation—these are some of the ideas round which this new optimistic ethics turns. Nietzsche looked forward to the human race emerging from an effete culture, burdened and clogged by tradition, and re-establishing itself on a basis that is in harmony with man's primitive instincts. Like Schopenhauer before him, Nietzsche was a stylist of the first rank, and his literary masterpiece, *Also sprach Zarathustra* (1883-1891), is to be regarded as the most important imaginative work of its epoch.

Nietzschean individualism was only one of many factors which contributed to the new literary development. The realistic movement, as it had manifested itself in France under Flaubert, the Goncourts, Zola and Maupassant, in Russia under Dostoevsky and Tolstoi, and in Norway under Ibsen and Björnson, was, for a time, the dominant force in Germany, and the younger generation of critics hailed it with undisguised satisfaction; most characteristic and significant of all, the centre of this revival was Berlin, which, since it had become the imperial capital, was rapidly establishing its claim to be also the literary metropolis. It was the best testimony to the vitality of the movement that it rarely descended to slavish imitation of the realistic masterpieces of other literatures; realism in Germany was, in fact, only an episode of the 'eighties, a stimulating influence rather than an accepted principle or dogma. And its suggestive character is to be seen not merely in the writings of the young *Stürmer und Dränger* of this time, but also in those of the older generation who, in temperament, were naturally more inclined to the ideals of a past age.

Of the novelists of the latter class, A. Wilbrandt, who has already been mentioned as a dramatist, has shown, since about 1890, a remarkable power of adapting himself, if not to the style and artistic methods of the younger school, at least to the ideas by which it was agitated; F. Spielhagen's attitude towards the realistic movement has been invariably sympathetic, while a still older writer, Theodor Fontane (1819-1898), wrote between 1880 and 1898 a series of works in which the finer elements of French realism were grafted on the German novel. To the older school belong Wilhelm Jensen (b. 1837), and that fine humorist, Wilhelm Raabe (b. 1831), with whom may be associated as other humorists of this period, H. Seidel (1842-1906) and W. Busch (1832-1908). Some of the most interesting examples of recent German fiction come, however, from Austria and Switzerland. The two most eminent Austrian authors, Marie von Ebner-Eschenbach (b. 1830), and Ferdinand von Saar (1833-1906), both excel as writers of Novellen or short stories—the latter especially being an exponent of that pessimism which is Austria's peculiar heritage from the previous generation of her poets. Austrians too, are Peter Rosegger (b. 1843), who has won popularity with his novels of peasant life, K. E. Franzos (1848-1904) and L. von Sacher-Masoch (1835-1895). German prose fiction is, in Switzerland, represented by two writers of the first rank: one of these, Gottfried Keller, has already been mentioned; the other, Konrad Ferdinand Meyer (1825-1898), turned to literature or, at least, made his reputation, comparatively late in life. Although, like Keller, a writer of virile, original verse, Meyer is best known as a novelist; he, too, was a master of the short story. His themes are drawn by preference from the epoch of the Renaissance, and his method is characterized by an objectivity of standpoint and a purity of style exceptional in German writers.

The realistic novels of the period were written by H. Conradi (1862-1890), Max Kretzer (b. 1854), M. G. Conrad (b. 1846), H. Heiberg (b. 1840), K. Bleibtreu (b. 1850), K. Alberti (pseudonym for Konrad Sittenfeld, b. 1862) and Hermann Sudermann (b. 1857). A want of stability was, however, as has been already

indicated, characteristic of the realistic movement in Germany; the idealistic trend of the German mind proved itself ill-adapted to the uncompromising realism of the French school, and the German realists, whether in fiction or in drama, ultimately sought to escape from the logical consequences of their theories. Even Sudermann, whose *Frau Sorge* (1887), *Der Katensteg* (1889), and the brilliant, if somewhat sensational romance, *Es war* (1894), are among the best novels of this period, has never been a consistent realist. It is consequently not surprising to find that, before long, German fiction returned to psychological and emotional problems, to the poetical or symbolical presentation of life, which was more in harmony with the German temperament than was the robust realism of Flaubert or Zola. This trend is noticeable in the work of Gustav Frenssen (b. 1863), whose novel *Jörn Uhm* (1901) was extraordinarily popular; it is also to be seen in the studies of child life and educational problems which have proved so attractive to the younger writers of the present day, such as Hermann Hesse (b. 1877), Emil Strauss (b. 1866), Rudolf Huch (b. 1862) and Friedrich Huch (b. 1873). One might say, indeed, that at the beginning of the 20th century the traditional form of German fiction, the *Bildungsroman*, had come into its ancient rights again. Mention ought also to be made of J. J. David (1850-1907), E. von Keyserling (b. 1858), W. Hegeler (b. 1870), G. von Ompteda (b. 1863), J. Wassermann (b. 1873), Heinrich Mann (b. 1871) and Thomas Mann (b. 1875). *Buddenbrooks* (1902) by the last mentioned is one of the outstanding novels of the period. Some of the best fiction of the most recent period is the work of women, the most distinguished being Helene Böhlau (b. 1859), Gabriele Reuter (b. 1859), Clara Viebig (C. Cohn-Viebig, b. 1860) and Ricarda Huch (b. 1864). Whether the latest movement in German poetry and fiction, which, under the catchword *Heimatkunst*, has favoured the province rather than the city, the dialect in preference to the language of the educated classes, will prove a permanent gain, it is still too soon to say, but the movement is at least a protest against the decadent tendencies of naturalism.

At no period of German letters were literature and the theatre in closer touch than at the end of the 19th and the beginning of the 20th centuries; more than at any previous time has the theatre become the arena in which the literary battles of the day are fought out. The general improvement in the artistic, technical and economic conditions of the German stage have already been indicated; but it was not until 1889 that the effects of these improvements became apparent in dramatic literature. Before that date, it is true, Ernst von Wildenbruch (1845-1900) had attempted to revive the historical tragedy, but the purely literary qualities of his work were handicapped by a too effusive patriotism and a Schillerian pathos; nor did the talent of Richard Voss (b. 1851) prove strong enough to effect any lasting reform. In October 1889, however, Gerhart Hauptmann's play, *Vor Sonnenaufgang*, was produced on the then recently founded *Freie Bühne* in Berlin; and a month later, *Die Elrn* by Hermann Sudermann met with a more enthusiastic reception in Berlin than had fallen to the lot of any German play for more than a generation.

Hauptmann (b. 1862), the most original of contemporary German writers, stands, more or less, alone. His early plays, the most powerful of which is *Die Weber* (1892), were written under the influence either of an uncompromising realism, or of that modified form of realism introduced from Scandinavia; but in *Hanneles Himmelfahrt* (1893) he combined realism with the poetic mysticism of a child's dream, in *Florian Geyse* (1895) he adapted the methods of realism to an historical subject, and in the year 1896 he, to all appearance, abandoned realism to write an allegorical dramatic poem, *Die versunkene Glocke*. Hauptmann's subsequent work has oscillated between the extremes marked out by these works—from the frank naturalism of *Fuhrmann Henschel* (1898) and *Rose Berndt* (1903), to the fantastic mysticism of *Der arme Heinrich* (1902) and *Und Pippa tanzt!* (1906).

The dramatic talent of Hermann Sudermann has developed

on more even lines; the success of *Die Ehre* was due in the first instance to the ability which Sudermann had shown in adapting the ideas of his time and the new methods of dramatic presentation to the traditional German *bürgerliches Drama*. This is the characteristic of the majority of the many plays which followed of which *Heimat* (1893), *Das Glück im Winkel* (1896) and *Es lebe das Leben!* (1902) may be mentioned as typical. With less success Sudermann attempted in *Johannes* (1898) a tragedy on lines suggested by Hebbel. A keen observer, a writer of brilliant and suggestive ideas, Sudermann is, above all, the practical playwright; but it is unfortunate that the theatrical element in his work too often overshadows its literary qualities.

Since 1899, the drama has occupied the foreground of interest in Germany. The permanent repertory of the German theatre has not, it is true, been much enriched, but it is at least to the credit of contemporary German playwrights that they are unwilling to rest content with their successes and are constantly experimenting with new forms. Besides Hauptmann and Sudermann, the most talented dramatists of the day are Max Halbe (b. 1865), O. E. Hartleben (1864-1905), G. Hirschfeld (b. 1873), E. Rosmer (pseudonym for Elsa Bernstejn, b. 1866), Ludwig Fulda (b. 1862), Max Dreyer (b. 1862), Otto Ernst (pseudonym for O. E. Schmidt, b. 1862) and Frank Wedekind (b. 1864). In Austria, notwithstanding the preponderant influence of Berlin, the drama has retained its national characteristics, and writers like Arthur Schnitzler (b. 1862), Hermann Bahr (b. 1863), Hugo von Hofmannsthal (b. 1874) and R. Beer-Hofmann (b. 1866) have introduced symbolic elements and peculiarly Austrian problems, which are foreign to the theatre of north Germany.

The German lyric of recent years shows a remarkable variety of new tones and pregnant poetic ideas; it has, as is natural, been more influenced by the optimism of Nietzsche—himself a lyric poet of considerable gifts—than has either novel or drama. Detlev von Liliencron (1844-1909) was one of the first to break with the traditions of the lyric as handed down from the Romantic epoch and cultivated with such facility by the Munich poets. An anthology of specifically modern lyrics, *Moderne Dichtercharaktere* (1885) by W. Arent (b. 1864), may be regarded as the manifesto of the movement in lyric poetry corresponding to the period of realism in fiction and the drama. Representative poets of this movement are Richard Dehmel (b. 1863), K. Henckell (b. 1864), J. H. Mackay (b. 1864 at Greenock), G. Falke (b. 1853), F. Avenarius (b. 1856), F. Evers (b. 1871), F. Dörmann (b. 1870) and K. Busse (b. 1872). A later development of the lyric—a return to mysticism and symbolism—is to be seen in the poetry of Hofmannsthal, already mentioned as a dramatist, and especially in Stefan George (b. 1868). Epic poetry, although little in harmony with the spirit of a realistic age, has not been altogether neglected. Heinrich Hart (1855-1906), one of the leading critics of the most advanced school, is also the author of an ambitious *Lied der Menschheit* (vols. 1-3, 1888-1896); more conservative, on the other hand, is *Robespierre* (1894), an epic in the style of Hamerling by an Austrian, Marie delle Grazie (b. 1864). Attention may also be drawn to the popularity which, for a few years, the so-called *Überbrett* or cabaret enjoyed, a popularity which has left its mark on the latest developments of the lyric. Associated with this movement are O. J. Bierbaum (1865-1910), whose lyrics, collected in *Der Irrgarten der Liebe* (1901), have been extraordinarily popular, E. von Wolzogen (b. 1855) and the dramatist F. Wedekind, who has been already mentioned.

Whether or not the work that has been produced in such rich measure since the year 1890—or however much of it—is to be regarded as a permanent addition to the storehouse of German national literature, there can be no question of the serious artistic earnestness of the writers; the conditions for the production of literature in the German empire in the early years of the 20th century were eminently healthy, and herein lies the best promise for the future.

BIBLIOGRAPHY.—(a) *General Histories, Anthologies, &c.*: A. Koberstein, *Grundriss der Geschichte der deutschen Nationalliteratur* (1827; 5th ed. by K. Bartsch, 5 vols., 1872-1874; 6th ed., vol. i.,

1884); G. G. Gervinus, *Geschichte der poetischen Nationalliteratur der Deutschen* (5 vols., 1835-1842; 5th ed. by K. Bartsch, 1871-1874); A. F. C. Vilmar, *Geschichte der deutschen Nationalliteratur* (1848; 25th ed., 2 vols., 1900, with a continuation by A. Stern); W. Wackernagel, *Geschichte der deutschen Literatur* (1851-1855; 2nd ed. by E. Martin, 1879-1894); K. Goedeke, *Grundriss zur Geschichte der deutschen Dichtung* (3 vols., 1857-1881; 2nd ed. by E. Goetze and others, in 9 vols., 1884 ff.); W. Menzel, *Deutsche Dichtung von der ältesten bis auf die neueste Zeit* (1858-1859); H. Kurz, *Geschichte der deutschen Literatur mit ausgewählten Stücken* (3 vols., 1857-1859; 7th ed., 4 vols., 1876-1882); O. Roquette, *Geschichte der deutschen Dichtung* (2 vols., 1862; 3rd ed., 1878-1879); W. Scherer, *Geschichte der deutschen Literatur* (1883; 10th ed., 1905). English translation by Mrs F. C. Conybeare (2 vols., 1885; new ed., 1906); Kuno Francke, *German Literature as determined by Social Forces* (1896; 6th ed., 1903); F. Vogt and M. Koch, *Geschichte der deutschen Literatur* (1897; 2nd ed., 2 vols., 1903); J. G. Robertson, *History of German Literature* (1902); A. Bartels, *Geschichte der deutschen Literatur* (2 vols., 1901-1902), with the accompanying bibliographical summary, *Handbuch zur Geschichte der deutschen Literatur* (1906). There are also histories of the literature of separate countries and districts, such as J. Bächtold, *Geschichte der deutschen Literatur in der Schweiz* (1887); R. Krauss, *Schwabische Literaturgeschichte* (2 vols., 1897-1899); J. W. Nagl and J. Zeidler, *Deutsch-österreichische Literaturgeschichte* (2 vols., 1899 ff.). The most comprehensive collection of German literature in selections is J. Kürschner, *Deutsche Nationalliteratur* (222 vols. in selections). Of general anthologies mention may be made of W. Wackernagel, *Deutsches Lesebuch* (4 vols., 1835-1872; new ed., 1882 ff.), and F. Max Müller, *The German Classics from the Fourth to the Nineteenth Century* (1858; ed. by F. Lichtenstein, 2 vols., 1886; new ed., 1906). For illustrations to the history of German literature, see G. Könnecke, *Bildertafel zur Geschichte der deutschen Nationalliteratur* (1807; 2nd ed., 1895).

(b) *Special Periods*: i. *Old High German and Middle High German Periods*: R. Kögel and W. Bruckner, "Geschichte der althochdeutschen Literatur," and F. Vogt, "Geschichte der mittelhochdeutschen Literatur," in H. Paul's *Grundriss der germanischen Philologie* (2nd ed., vol. ii, pt. 1, 1901); F. Kuhl, *Geschichte der altdutschen Dichtung* (1886); J. Kelle, *Geschichte der deutschen Literatur, i-ii* (1892-1896); K. Kögel, *Geschichte der deutschen Literatur bis zum Ausgang des Mittelalters, i* (1894-1897); W. Golther, *Geschichte der deutschen Literatur von den ersten Anfängen bis zum Ausgang des Mittelalters* (in Kürschner's *Deutsche Nationalliteratur*, vol. 163, pt. 1, 1892); W. Scherer, *Geschichte der deutschen Dichtung im 11. und 12. Jahrhundert*, and by the same author, *Geistliche Poeten der deutschen Kaiserzeit* (both works in *Quellen und Forschungen*, 1874-1875); O. Lyon, *Minne- und Meistersang* (1882). There are numerous series of editions of medieval texts: K. Müllenhoff and W. Scherer, *Denkmäler deutscher Poesie und Prosa aus des 9-12. Jahrhundert* (2 vols., 3rd ed., 1892); M. Heyne, *Bibliothek der ältesten Literaturdenkmäler* (14 vols., begun 1858); F. Pfeiffer, *Deutsche Klassiker des Mittelalters* (12 vols., begun 1865), with the supplementary *Deutsche Dichtungen des Mittelalters*, edited by K. Bartsch (7 vols., 1872 ff.); K. Goedeke, *Deutsche Dichtung im Mittelalter* (2nd ed., 1871); J. Zacher, *Germanistische Handbibliothek* (9 vols., begun 1869); H. Paul, *Altddeutsche Textbibliothek* (16 vols., begun 1882); *Deutsche Texte des Mittelalters*, ed. by the Berlin Academy (1904 ff.). Convenient editions of the Minnesang are K. Lachmann and M. Haupt, *Des Minnesangs Frühling* (4th ed. by F. Vogt, 1888), and K. Bartsch, *Deutsche Liederdichter des 12. bis 14. Jahrh.* (4th ed. by W. Golther, 1903).

ii. *From 1350-1700.*—L. Geiger, *Renaissance and Humanismus in Italien und Deutschland* (1882; 2nd ed., 1899); K. Borinski, *Geschichte der deutschen Literatur seit dem Ausgang des Mittelalters* (in Kürschner's *Deutsche Nationalliteratur*, vol. 163, ii, 1898); H. Palm, *Beiträge zur Geschichte der deutschen Literatur des 16. und 17. Jahrhunderts* (1877); C. H. Herford, *Studies in the Literary Relations of England and Germany in the Sixteenth Century* (1886); C. Lomcke, *Von Opitz bis Klopstock, i* (1871; 2nd ed., 1882); M. von Waldberg, *Deutsche Renaissance-Lyrik* (1888), and *Die galante Lyrik* (1883); F. Bobertag, *Geschichte des Romans in Deutschland, i* (to 1700) (1877-1884); K. Borinski, *Die Poetik der Renaissance und die Anfänge der literarischen Kritik in Deutschland* (1886). A vast quantity of the literature of these centuries has been republished by the Stuttgarter literarischer Verein (founded in 1839), whose publications now number considerably over two hundred volumes; further, W. Braune, *Neudrucke deutscher Literaturwerke des 16. und 17. Jahrhunderts* (begun 1882); K. Goedeke and J. Tittmann, *Deutsche Dichter des 16. Jahrhunderts* (18 vols., 1867 ff.), and *Deutsche Dichter des 17. Jahrhunderts* (15 vols., 1869 ff.). A valuable anthology is K. Goedeke's *Elf Bücher deutscher Dichtung von Sebastian Brant bis auf die Gegenwart* (2 vols., 1849). Since 1890 the *Jahresberichte für neuere deutsche Literaturgeschichte* have provided an exhaustive survey of all publications dealing with modern German literature. A useful practical bibliography for English readers, covering this and the succeeding periods, is I. S. Nollen, *A Chronology and Practical Bibliography of Modern German Literature* (1903).

iii. *The Eighteenth Century*.—J. Schmidt, *Geschichte der deutschen Literatur von Leibniz bis auf unsere Zeit* (4 vols., 1862-1867; 2nd ed. 1886-1890); J. Hillebrand, *Die deutsche Nationalliteratur im 18. und 19. Jahrhundert* (3 vols., 1845-1846; 3rd ed. 1875); H. Hettner, *Geschichte der deutschen Literatur im 18. Jahrhundert* (4 vols., 1862-1870; 4th ed. by O. Harnack, 1893-1895); J. W. Schäfer, *Geschichte der deutschen Literatur des 18. Jahrhunderts* (1855-1860; 2nd ed. by F. Muncker, 1881); J. K. Mörkeler, *Die schweizerische Literatur des 18. Jahrhunderts* (1861); J. W. Löbell, *Entwicklung der deutschen Poesie von Klopstock bis zu Goethes Tod* (3 vols., 1856-1865). There are also innumerable more special treatises, such as A. Eloesser, *Das bürgerliche Drama* (1898); O. Brahm, *Das deutsche Ritterdrama des 18. Jahrhunderts* (1880), &c. Of collections of the literature of this and the following century, reference need only be made to the *Bibliothek der deutschen Nationalliteratur des 18. und 19. Jahrhunderts*, published by Brockhaus (44 vols., 1868-1891), and *Deutsche Literaturdenkmale des 18. und 19. Jahrhunderts*, edited first by B. Seuffert (1882-1894), and subsequently by A. Sauer.

iv. *The Nineteenth Century*.—Th. Ziegler, *Die geistigen und sozialen Strömungen des neunzehnten Jahrhunderts* (1899; 2nd ed. 1901); R. von Gottschall, *Die deutsche Nationalliteratur des 19. Jahrhunderts* (1854; 7th ed., 4 vols., 1900-1902); R. M. Meyer, *Die deutsche Literatur des 19. Jahrhunderts* (1899; 4th ed. 1910); R. M. Meyer, *Grundriss der neueren deutschen Literaturgeschichte* (1902); C. Busse, *Geschichte der deutschen Dichtung im neunzehnten Jahrhundert* (1901); R. Haym, *Die romantische Schule* (1870; 2nd ed. 1906); G. Brandes, "Den romantiske Skole i Tyskland" (1873), and "Det unge Tyskland" (1890), in *Hovedstrømninger i det 19de Aarhundredes Literatur*, vols. ii. and vi. (German translations, 1887 and 1891; several subsequent editions, Danish and German; English translations, ii. 1903, and vi. 1905); R. Huch, *Die Blüthezeit der Romantik* (2nd ed. 1901), and *Ausbretung und Verfall der Romantik* (1902); F. Wehl, *Das junge Deutschland* (1886); J. Froelich, *Das junge Deutschland* (1892); A. Bartels, *Die deutsche Dichtung der Gegenwart* (7th ed., 1907); A. von Hanstein, *Das jüngste Deutschland* (2nd ed., 1901); J. F. Coar, *Studies in German Literature in the Nineteenth Century* (1903); Ch. Petzet, *Die Blüthezeit der deutschen politischen Lyrik* (1903); H. Mielke, *Der deutsche Roman des 19. Jahrhunderts* (4th ed., 1900); S. Friedmann, *Das deutsche Drama des 19. Jahrhunderts* (2 vols., 1900-1903); B. Litzmann, *Das deutsche Drama in den literarischen Bewegungen der Gegenwart* (4th ed., 1898). (J. G. R.)

GERMAN REED ENTERTAINMENT. The dramatic and musical entertainment which for many years was known in London by the title of "German Reed" was a form of theatrical enterprise deserving of commemoration in connexion with those who made it successful. Mr THOMAS GERMAN REED (born in Bristol in 1817, died 1888) married in 1844 Miss PRISCILLA HORTON (1818-1895), and in 1855 they started their entertainment at the "Gallery of Illustration," in Waterloo Place, London. From 1860 to 1877 they were assisted by JOHN ORLANDO PARRY (1810-1879), an accomplished pianoforte player, mimic, parodist and humorous singer; and the latter created a new type of musical and dramatic monologue which became very popular. His tradition was carried on after 1870 by Mr CORNEY GRAIN (1844-1895), who, as a clever, refined, and yet highly humorous society entertainer (originally a barrister), was one of the best-known figures of his day. After the retirement of the elder German Reeds, their son, ALFRED GERMAN REED (1846-1895), himself a capital actor, carried on the business in partnership with Corney Grain. The "German Reed Entertainment"—which was always patronized by a large class of people, many of whom objected on principle to going or taking their children to a regular theatre or a music-hall—retained its vogue for forty years at Waterloo Place and at the St George's Hall, Regent Street. But the death of Mr Corney Grain almost simultaneously with Mr Alfred German Reed, in 1895, together with the changed public attitude towards the regular theatre, ended his career.

GERMAN SILVER or NICKEL SILVER, an alloy of copper, nickel and zinc, prepared either by melting the copper and nickel together in a crucible, and adding piece by piece the previously heated zinc, or by heating the finely divided metals under a layer of charcoal. To destroy its crystalline structure and so render it fit for working, it is heated to dull redness, and then allowed to cool. German silver is harder than silver; it resembles that metal in colour, but is of a greyer tinge. Exposed to the air it *tarnishes slightly yellow, and with vinegar affords a crust of verdigris. At a bright red heat it melts, losing its zinc by oxida-*

tion unless protected from the atmosphere. At a heat above dull redness it becomes exceedingly brittle. German silver in various modifications of composition is much used in the arts. Alloys, of which about 50% is copper and the residue zinc and nickel in about equal proportions take a fine polish, and are used as imitation silver for knives and forks. With a somewhat higher proportion of copper an alloy is formed suitable for rolling and for wire. In Chinese *white silver* or *packjong* (pakjong) the amount of copper is smaller, about 40%, with about 32% of nickel, 25 of zinc, and 2 or 3 of iron. German silver for casting contains 2 or 3% of lead, which like iron increases the whiteness of the alloy. German silver, having a high specific resistance and a low temperature coefficient, has been used for electrical resistance coils, and these qualities are possessed in a still greater degree in *manganin*, which contains manganese in place of zinc, its composition being 84% of copper, 12 of manganese and 4 of nickel. The addition of a trace of tungsten to German silver, as in *platinoid*, also largely increases the resistance.

GERMAN SOUTH-WEST AFRICA. This German possession is bounded W. by the Atlantic, N. by Angola, S. by the Cape province, E. by Bechuanaland and Rhodesia, and is the only German dependency in Africa suited to white colonization. It has an area of about 322,450 sq. m., and a population of Bantu Negroes and Hottentots estimated in 1903 at 200,000.¹ The European inhabitants, in addition to the military, numbered 7110 in 1907, of whom the majority were German.

Area and Boundaries.—The boundary separating the German protectorate from the Portuguese possessions of Angola is the lower Kunene, from its mouth in 17° 18' S., 11° 40' E. to the limit of navigability from the sea, thence in a direct line, corresponding roughly to the lat. of 17° 20' S., to the river Okavango, which it follows eastwards until the stream turns abruptly south (towards Lake Ngami) From this point a strip of German territory 300 m. long and about 50 m. broad, projects eastward until it reaches the Zambezi a little above the Victoria Falls. On the south this narrow strip of land (known as the Caprivi enclave) is separated from southern Rhodesia by the Kwando or Chobe river. On the east the frontier between British and German territory is in its northern half the 21st degree of E. longitude, in its southern half the 20th degree. This frontier is drawn through desert country. The southern frontier is the Orange river from its mouth to the 20° E. The coast-line between the Kunene and Orange rivers is not wholly German. Just north of the tropic of Capricorn is the British enclave of Walfish Bay (q.v.). The northern part of the protectorate is known as Ovampoland, the central portion as Damara (or Herero) land; the southern regions as Great Namaqualand. These names are derived from those of the dominant native races inhabiting the country.

Physical Features.—The coast-line is generally low and little broken by bays or promontories. In its entire length of about 800 m. it has no good natural harbour, and its bays—Angra Pequena, otherwise Lüderitz Bay, Sierra Bay, Sandwich Harbour—are in danger of being filled with sand by the strong, cold, northerly coast current. Swakopmund is an artificial harbour at the mouth of the river Swakop. The small islands which stud the coast north and south of Angra Pequena belong to Great Britain. The coast-line is bordered by a belt of sand-dunes and desert, which, about 35 m. wide in the south, narrows towards the north. This coast belt is flanked by a mountain range, which attains its highest elevation in Mount Omatako (8972 ft.), in about 21° 15' S., 16° 40' E. N.E. of Omatako is the Omoroko range, otherwise known as the Waterberg. South of Omoroko, occupying the centre of the country, the range attains its highest average altitude. The following massifs with their highest points may be distinguished: Gans (7664 ft.), Nu-ubeb (7480 ft.), Onyati (7201 ft.), Awas (6988 ft.), Komas (5331 ft.) and Ganab (4902 ft.). In the S.E. are the Karas mountains, which attain an elevation of 6570 ft. The mountains for the main part form the escarpment of the great Kalahari plateau, which, gently rising from the interior towards the west, slopes again towards the south and north from the point of its highest elevation. The Kalahari plateau changes the undulating character it has in the west to a perfect plain in the far east, where the watered and habitable country merges into the sterile Kalahari desert. In the northern half of the country the central plateau contains much rich grass-land, while in the north-eastern region the Omaheke desert has all the characteristics of the Kalahari.

There are no rivers of importance wholly within German South-West Africa. The Kunene (q.v.) has but a small portion of the southern bank in the colony, and similarly only part of the northern

¹ As the result of wars with the natives, the population greatly decreased. The number of adult (native) males in the colony at the beginning of 1908 was officially estimated at 19,900, a figure indicating a total population of little more than 100,000.

bank of the Orange river (*q.v.*) is in German territory. Several streams run south into the Orange; of those the chief is the Great Fish river, which has a course of nearly 500 m. Both the Kunene and the Orange carry water all the year round, but are not navigable. Neither is the Great Fish river, which, however, is rarely dry. The Okavango, which comes from the north and runs towards Ngami (*q.v.*), is perennial, but like the Kunene and Orange, belongs only partly to the hydrographic system of the country. From the inner slopes of the coast chain many streams go N.E. to join the Okavango. They cross the Omaheke waste and are usually dry. Ovampoland has a hydrographic system connected with the Kunene, and, in seasons of great flood, with that of Ngami. Before the Kunene breaks through the outer edge of the plateau, it sends divergent channels south-east to a large marsh or lake called Etosha, which is cut by 17° E. and 19° S. Of these channels the Kwamatuo or Okipoko, which is perennial, enters Etosha at its N.W. corner. The lake when full extends about 80 m. W. to E. and 50 m. N. to S. From its S.E. corner issues the Omuramba, which divides into two branches, known respectively as the Omaheke and the Ovampo. These streams have an easterly direction, their beds, often dry, joining the Okavango. The other rivers of the protectorate have as a rule plenty of water in their upper courses in the rainy season, though some river beds are dry for years together. After a heavy thunderstorm such a river bed will be suddenly filled with a turbid current half a mile wide. The water is, however, before long absorbed by the thirsty land. Only in exceptionally rainy years do the streams which cross the sand belt carry water to the ocean. But in the sand which fills the river beds water may be obtained by digging. Of rivers running direct to the Atlantic the Little Fish river enters the sea at Angra Pequena and the Kuusip in Walfish Bay. The Swakop rises in the hills near the Waterberg, and north of it is the Omaruru, which carries water for the greater part of the year. Hot springs are numerous, and it is remarkable that those of Windhoek flow more copiously during the dry than the rainy season. There are also many cold springs, and wells which contain water all the year.

Geology.—Gneiss and schist, with intrusive granites and porphyries, overlie to a great extent by sand and lateritic deposits, occupy the coast belt, coast mountains and the plateau of Damaraland. In the Huib and Han-ami plateaus of Great Namaqualand the crystalline rocks are overlain by sandstones, slates, quartzites and Jasper rocks, and these in turn by dolomites. They are probably equivalent to the Transvaal and Pretoria series (see TRANSVAAL: *Geology*). The next oldest rocks are of recent geological date. The Kalahari Kalk, which extends over large areas to the south-east of Ovampoland, may be of Miocene age, but it has not yielded fossils. Extensive tracts of alluvium occur in the basin of the Ovampo, while the dunes and sand-tracts of the Kalahari occupy the eastern regions.

Climate.—On the coast the mean temperature is low, and there is little rainfall. Moisture is supplied by dense fogs, which rise almost daily. South-west winds prevail. Inland the climate is temperate rather than tropical, with bracing, clear atmosphere. There are considerable differences of temperature between day and night, and two well-marked seasons, one cold and dry from May to September, the other hot and rainy from October to April. In winter ice frequently forms during the night on open water on the plateau, but it never remains all day. The yearly rainfall is about 20 in. in the Damarara Hills; there is more rain in the north than in the south, and in the east than in the west. In the greater part of the colony the climate is favourable for European settlement.

Flora and Fauna.—The vegetation corresponds exactly with the climate. In the dry littoral region are plants able to exist with the minimum of moisture they derive from the daily fog—*Amaranthaceae*, *Sarcocaula*, *Aloe dichotoma*, *Aristida subcaulis* and the wonderful *Wehutschia*. Farther inland are plants which spring up and disappear with the rain, and others whose roots reach permanent water. The former are chiefly grasses, the latter exist almost solely in or near river-beds. Amongst the fine trees often seen here, the ana tree (*Acacia albida*) is the most noteworthy, its seeds being favourite fodder for all domestic animals. *Acacia graftedae*, *Ac. horrida*, *Adansonia sterculioides*, near the Kunene the *Hyphaene verticillata*, deserve special notice. The vegetation in the mountain valleys is luxuriant, and towards the north is of a tropical character. The palm zone extends a considerable distance south of the Kunene, and here vegetation spreads over the sand-dunes of the coast plain, which are covered with grasses.

Large game, formerly abundant, especially pachyderms, is scarce. Of antelopes the following species are plentiful in parts: springbok, steenbok, kudu, rietbok, pallah; of monkeys, the *Cynocephalus porcellus* is frequent. Various kinds of hyenas and jackals with fine fur (*Canis mesomelas*), also *Felis caracal*, abound. The spring-hare (*Pedestea capensis*) and rock-rabbit (*Hyrax capensis*) may often be observed. Of birds there are 728 species. Crocodiles, turtles and snakes are numerous.

Inhabitants.—Among the natives of German South-West Africa three classes may be distinguished. In the first class are the Namaqua (Hottentots) and Bushmen. The Namaqua probably came from the south, while the Bushmen may be looked upon as an indigenous race. The Hottentots, the purest

existing types of that race, are divided into numerous tribes, independent of one another, such as the Witbois, Swartzbois, Bondelzwarts. The Bushmen are found scattered over the eastern parts of the country (see HOTTENTOTS and BUSHMEN). The second class consists of the mountain Damara (Hau-Khoim), a race of doubtful affinities, probably of Bantu-Negro origin, but speaking the Hottentot language. The third class belongs to the Bantu-Negro stock, and came from the north-east, expelling and enslaving the mountain Damara, and settling in various parts of the country under different names. The most prominent are the Herero, thorough nomads and cattle-breeders; while the Ovampo (Ovambo or Ambo), in the northern part of the protectorate, are agriculturists. The Herero (*q.v.*) are also known by the Hottentot name Damara, and by this name their country is generally called. The Bastards, who live in Namaqualand, are a small tribe originating from a mingling of Cape Boers with Hottentots. They are Christians, and able to read and write. The other natives are spirit-worshippers, save for the comparatively few converts of the Protestant missions established in the country. Of white races represented the chief are Germans and Boers. In the S.E. Boer settlers form the bulk of the white population. There are also numbers of British colonists in this region—emigrants from the Cape. The immigration of Germans is encouraged by subsidies and in other ways.

Towns.—The chief port is Swakopmund, built on the northern bank of the Swakop river (the southern bank belonging to the British territory of Walfish Bay). The harbour is partially protected by a breakwater. There are also settlements at Lüderitz Bay (white pop. 1909, over 1000) and at Sandwich Harbour. Swakopmund is connected by a narrow gauge railway with Windhoek, the administrative capital of the colony, situated in a hilly district 180 m. due east of the port, but 237 m. by the railway. Karibib is the only place of consequence on the line. Otyimbingue is a government station 70 m. W.N.W. of Windhoek, and Tsumeb a mining centre 240 m. N.N.E. of the same place. Olukonda is a government post in Ovampoland. In the S.E. corner of the colony, 30 m. N. of the Orange river, is the town of Warmbad. Kectmanshoop, 100 m. N. of Warmbad and 180 m. E. of Lüderitz Bay, is the centre of a small mining industry. Gibeon is a government station and missionary settlement about midway between Kectmanshoop and Windhoek. Besides these places there are numbers of small native towns at which live a few white traders and missionaries. The missionaries have given Biblical names to several of their stations, such as Bethany and Beersheba in Namaqualand, and Rehoboth in Damaraland. In the Caprivi enclave are a German residency and the site of the town of Linyante, once the capital of the Makololo dynasty of Barotseland (see BAROTSE).

Industries.—Agriculture is followed by the natives in the northern districts, but the chief industry is stock-raising. The scarcity of water in the southern parts is not favourable for agricultural pursuits, while the good grazing lands offer splendid pasturage for cattle, which the Herero raise in numbers amounting to many hundred thousands. Sheep and goats thrive well. Horses have been imported from the Cape. Unfortunately the climate does not suit them everywhere, and they are subject to a virulent distemper. Cattle and sheep also suffer from the diseases which are common in the Cape Colony. Camels have been imported, and are doing well. Wheat, maize and sorghum are the chief crops raised, though not enough is grown to meet even local requirements. Near the coast the natives collect the kernels of the nara, a wild-growing pumpkin which, in the words of an early traveller, C. J. Andersson, "are eaten by oxen, mice, men, ostriches and lions." About half the European settlers are engaged in agriculture. They raise maize, wheat, tobacco, fruit and vegetables. Cotton cultivation and viticulture are carried on in some districts.

Minerals, especially copper, are plentiful in the country. The chief copper deposits are at Tsumeb, which is 4230 ft. above the sea, in the Otavi district. Diamonds are found on and near the surface of the soil in the Lüderitz Bay district, and diamonds have also been found in the neighbourhood of Gibeon. A little pottery is made, and the Hottentot women are clever in making fur cloths. In the north the Ovampo do a little smith-work and grass-plaiting. The external trade of the country was of slow growth. The exports previous to the opening up of the Otavi mines, consisted chiefly of live stock—sent mainly to Cape Colony—ivory, horns, hides and ostrich feathers. The chief imports are food stuffs, textiles and metals, and hardware. In 1903 the value of the exports was £168,560, that of the imports £388,210. The war which followed (see below, *History*) led to a great shrinking of exports, rendering the figures for the period 1904-1907 useless for purposes of comparison. About 85% of the imports are from Germany.

Communications.—The economic development of the country is largely dependent on transport facilities. The railway crosses

Swakopmund to Windhoek, mentioned above, was begun in 1897, and was opened for traffic in July 1902. It cost nearly £700,000 to build. Another narrow gauge railway, to serve the Otavi copper mines, was begun in 1904 and completed in 1908. It starts from Swakopmund and is 400 m. long, the terminus being at Grootfontein, 40 m. S.E. of Tsumeb. The highest point on this line is 5213 ft. above the sea. In 1906-1908 a railway, 180 m. long, was built from Lüderitz Bay to Keetmanshoop. This line is of the standard South African gauge (3 ft. 6 in.), that gauge being adopted in view of the eventual linking up of the line with the British railway systems at Kimberley. A branch from Seeheim on the Keetmanshoop line runs S.E. to Kalkfontein.

Besides railways, roads have been made between the chief centres of population. Along these, in the desert districts, wells have been dug. Across the Awas Mountains, separating Windhoek from the central plateau, a wide road has been cut. In 1903 the colony was placed in telegraphic communication with Europe and Cape Colony by the laying of submarine cables having their terminus at Swakopmund. There is a fairly complete inland telegraphic service.

There is regular steamship communication between Hamburg and Swakopmund, Walfish Bay and Lüderitz Bay. Regular communication is also maintained between Cape Town and the ports of the colony.

Administration.—At the head of the administration is an imperial governor, responsible to the colonial office in Berlin, who is assisted by a council consisting of chiefs of departments. The country is divided into various administrative districts. In each of these there is a *Besirksamtmann*, with his staff of officials and police force. In each district is a law court, to whose jurisdiction not alone the whites, but also the Bastaards are subject. As in all German colonies, there is a court of appeal at the residence of the governor. The government maintains schools at the chief towns, but education is principally in the hands of missionaries. The armed force consists of regular troops from Germany and a militia formed of Bastaards. The local revenue for some years before 1903 was about £130,000 per annum, the expenditure about £400,000, the difference between local receipts and expenditure being made good by imperial subsidies. In 1908 local revenue had risen to £250,000, but the imperial authorities incurred an expenditure of over £2,000,000, largely for military purposes. On articles of export, such as feathers and hides, 5% *ad valorem* duty has to be paid; on cattle and horses an export tax per head. There is a 10% *ad valorem* duty on all imports, no difference being made between German and foreign goods. The sale of spirituous liquors is subject to a licence.

History.—The coast of south-west Africa was discovered by Bartholomew Diaz in 1487, whilst endeavouring to find his way to the Indies. He anchored in a bay which by reason of its smallness he named Angra Pequena. Portugal, however, took no steps to acquire possession of this inhospitable region, which remained almost unvisited by Europeans until the early years of the 19th century. At this time the country was devastated by a Hottentot chief known as Afrikander, who had fled thither with a band of outlaws after murdering his master, a Boer farmer by whom he had been ill-treated, in 1796. In 1805 some missionaries (of German nationality) went into Namaqualand in the service of the London Missionary Society, which society subsequently transferred its missions in this region to the Rhenish mission, which had had agents in the country since about 1840. The chief station of the missionaries was at a Hottentot settlement named Bethany (1820), a place 125 m. E. by Angra Pequena. The missionaries had the satisfaction of stopping Afrikander's career of bloodshed. He became a convert, a great friend of the mission, and took the name of Christian. The proximity of Great Namaqualand to Cape Colony led to visits from British and Dutch farmers and hunters, a few of whom settled in the country, which thus became in some sense a dependency of the Cape.

In 1867 the islands along the coast north and south of Angra Pequena, on which were valuable guano deposits, were annexed to Great Britain. At this time a small trade between the natives and the outside world was developed at Angra Pequena, the merchants engaged in it being British and German. The political influence of the Cape spread meantime northward to the land of the Herero (Damaras). The Herero had been subjugated by Jonker Afrikander, a son of Christian Afrikander, who followed the early footsteps of his sire and had renounced Christianity, but in 1865 they had recovered their independence. The Rhenish missionaries appealed (1868) to the British government for protection, and asked for the annexation of the country. *This request, although supported by the Prussian government,*

was refused. In 1876, however, a special commissioner (W. Coates Palgrave) was sent by the Cape government "to the tribes north of the Orange river." The commissioner concluded treaties with the Namaqua and Damara which fixed the limits of the territories of the two races and placed the whole country now forming German South-West Africa within the sphere of British influence. In the central part of Damaraland an area of some 35,000 sq. m. was marked out as a British reservation. The instrument by which this arrangement was made was known as the treaty of Okahandya. Neither it nor the treaty relating to Great Namaqualand was ratified by the British government, but at the request of Sir Bartle Frere, then high commissioner for South Africa, Walfish Bay (the best harbour along the coast) was in 1878 annexed to Great Britain.

In 1880 fighting between the Namaqua, who were led by Jan Afrikander, son of Jonker and grandson of Christian Afrikander, and the Damara broke out afresh, and was not ended until the establishment of European rule. In 1883 F. A. E. Lüderitz (1834-1886), a Bremen merchant, with the approval of Prince Bismarck, established a trading station at Angra Pequena. This step led to the annexation of the whole country to Germany (see AFRICA, § 5) with the exception of Walfish Bay and the islands actually British territory. On the establishment of German rule Jonker Afrikander's old headquarters were made the seat of administration and renamed Windhoek. The Hottentots, under a chieftain named Hendrik Witboi, offered a determined opposition to the Germans, but after a protracted war peace was concluded in 1894 and Hendrik became the ally of the Germans. Thereafter, notwithstanding various local risings, the country enjoyed a measure of prosperity, although, largely owing to economic conditions, its development was very slow.

In October 1903 the Bondelzwarts, who occupy the district immediately north of the Orange river, rose in revolt. This act was the beginning of a struggle between the Germans and the natives which lasted over four years, and cost Germany the lives of some 5000 soldiers and settlers, and entailed an expenditure of £15,000,000. Abuses committed by white traders, the brutal methods of certain officials and the occupation of tribal lands were among the causes of the war, but impatience of white rule was believed to be the chief reason for the revolt of the Herero, the most formidable of the opponents of the Germans. The Herero had accepted the German protectorate by treaty—without fully comprehending that to which they had agreed. To crush the Bondelzwarts, an object attained by January 1904, the governor, Colonel Theodor Leutwein, had denuded Damaraland of troops, and advantage was taken of this fact by the Herero to begin a long-planned and well-prepared revolt. On the 12th of January 1904 most of the German farmers in Damaraland were attacked, and settlers and their families murdered and the farms devastated. Reinforcements were sent from Germany, and in June General von Trotha arrived and took command of the troops. On the 11th of August von Trotha attacked the Herero in their stronghold, the Waterberg, about 200 m. N. of Windhoek, and inflicted upon them a severe defeat. The main body of the enemy escaped, however, from the encircling columns of the Germans, and thereafter the Herero, who were under the leadership of Samuel Maberero, maintained a guerrilla warfare, rendering the whole countryside unsafe. The Germans found pursuit almost hopeless, being crippled by the lack of water and the absence of means of transport. To add to their troubles a Herero bastard named Morenga, with a following of Hottentots, had, in July, recommenced hostilities in the south. On the 2nd of October 1904 von Trotha, exasperated at his want of success in crushing the enemy, issued a proclamation in which he said: "Within the German frontier every Herero with or without a rifle, with or without cattle, will be shot. I will not take over any more women and children. But I will either drive them back to your people or have them fired on." In a later order von Trotha instructed his soldiers not to fire into, but to fire over the heads of the women and children, and Prince Bülow ordered the general to repeal the

whole proclamation. Whenever they had the chance, however, the Germans hunted down the Herero, and thousands perished in the Omaheke desert, across which numbers succeeded in passing to British territory near Ngami.

On the day following the issue of von Trotha's proclamation to the Herero, i.e. on the 3rd of October 1904, Hendrik Witboi sent a formal declaration of war to the Germans. Hendrik had helped to suppress the Bondelzwarts rising, and had received a German decoration for his services, and his hostility is said to have been kindled by the supersession of Colonel Leutwein, for whom he entertained a great admiration. The Witbois were joined by other Hottentot tribes, and their first act was to murder some sixty German settlers in the Gibeon district. Both British and Boer farmers were spared—the Hottentots in this matter follow the example of the Herero. In November, considerable reinforcements having come from Germany, the Witbois were attacked, and Hendrik's headquarters, Reimont, captured. Another defeat was inflicted on Hendrik in January 1905, but, lacking ammunition and water, the Germans could not follow up their victory. As in Damaraland, the warfare in Namaqualand now assumed a guerrilla character, and the Germans found it almost impossible to meet their elusive enemy, while small detachments were often surprised and sometimes annihilated. In May 1905 von Trotha tried the effect on the Hottentots of another of his proclamations. He invited them to surrender, adding that in the contrary event all rebels would be exterminated. A price was at the same time put on the heads of Hendrik Witboi and other chiefs. This proclamation was unheeded by the Hottentots, who were in fact continuing the war with rifles and ammunition seized from the Germans, and replenishing their stock with cattle taken from the same source. In the north, however, Samuel Maherero had fled to British territory, and the resistance of the Herero was beginning to collapse. Concentration camps were established in which some thousands of Herero women and children were cared for. Meanwhile, the administration of von Trotha, who had assumed the governorship as well as the command of the troops, was severely criticized by the civilian population, and the non-success of the operations against the Hottentots provoked strong military criticism. In August 1905 Colonel (afterwards General) Leutwein, who had returned to Germany, formally resigned the governorship of the protectorate, and Herr von Lindequist, late German consul-general at Cape Town, was nominated as his successor. Von Trotha, who had publicly criticized Prince Bülow's order to repeal the Herero proclamation, was superseded. He had in the summer of 1905 instituted a series of "drives" against the Witbois, with no particular results. Hendrik always evaded the columns and frequently attacked them in the rear.

In November 1905 von Lindequist arrived at Windhoek. The new governor issued a general amnesty to the Herero, and set aside two large reserves for those who surrendered. His conciliatory policy was in the end successful, and the Ovampo, who threatened to give trouble, were kept in hand. The task of pacifying Damaraland was continued throughout 1906, and by the close of that year about 16,000 Herero had been established in the reserves. Some 3000 had sought refuge in British territory, while the number who had perished may be estimated at between 20,000 and 30,000.

In Namaqualand von Lindequist found an enemy still unbroken. On the 3rd of November, however, Hendrik Witboi died, aged seventy-five, and his son and successor Samuel Isaac Witboi shortly afterwards surrendered, and the hostility of the tribe ceased. Morenga now became the chief of the rebel Hottentots, and "drives" against him were organized. Early in May 1906 an encounter between Morenga and a German column was fought close to the British frontier of the Bechuanaland protectorate. Morenga fled, was pursued across the frontier, and wounded, but escaped. On the 16th of May he was found hiding by British patrols and interned. Other Hottentot chiefs continued the conflict, greatly aided by the immense difficulty the Germans had in transporting supplies; to remedy which defect the building of a railway

from Lüderitz Bay to Kubub was begun early in 1906. A camel transport corps was also organized, and Boer auxiliaries engaged. Throughout the later half of 1906 the Hottentots maintained the struggle, the Karas mountains forming a stronghold from which their dislodgment was extremely difficult. Many of their leaders and numbers of the tribesmen had a considerable strain of white (chiefly Dutch) blood and were fairly educated men, with a knowledge not only of native, but European ways; facts which helped to make them formidable opponents. Gradually the resistance of the Hottentots was overcome, and in December 1906 the Bondelzwarts again surrendered. Other tribes continued the fight for months longer, but by March 1907 it was found possible to reduce the troops in the protectorate to about 5000 men. At the height of the campaign the Germans had 19,000 men in the field.

In August 1907 renewed alarm was created by the escape of Morenga from British territory. The Cape government, regarding the chief as a political refugee, had refused to extradite him and he had been assigned a residence near Uppington. This place he left early in August and, eluding the frontier guards, re-entered German territory. In September, however, he was again on the British side of the border. Meantime a force of the Cape Mounted Police under Major F. A. H. Elliott had been organized to effect his arrest. Summoned to surrender, Morenga fled into the Kalahari Desert. Elliott's force of sixty men pursued him through a waterless country, covering 80 m. in 24 hours. When overtaken (September 21st), Morenga, with ten followers, was holding a kopje and fired on the advancing troops. After a sharp engagement the chief and five of his men were killed, the British casualties being one killed and one wounded. The death of Morenga removed a serious obstacle to the complete pacification of the protectorate. Military operations continued, however, during 1908. Herr von Lindequist, being recalled to Berlin to become under-secretary in the colonial office, was succeeded as governor (May 1907) by Herr von Schuckmann. In 1908 steps were taken to establish German authority in the Caprivi enclave, which up to that time had been neglected by the colonial authorities.

The discovery of diamonds in the Lüderitz Bay district in July 1908 caused a rush of treasure-seekers. The diamonds were found mostly on the surface in a sandy soil and were of small size. The stones resemble Brazilian diamonds. By the end of the year the total yield was over 39,000 carats. One of the difficulties encountered in developing the field was the great scarcity of fresh water. During 1909 various companies were formed to exploit the diamondiferous area. The first considerable packet of diamonds from the colony reached Germany in April 1909. The output for the year was valued at over £1,000,000.

AUTHORITIES.—Karl Dove, *Deutsch-Südwestafrika* (Berlin, 1903); W. Külz, *Deutsch-Südafrika* . . . (Berlin, 1909); T. Leutwein, *25 Jahre Gouverneur in Deutsch-Südwestafrika* (Berlin, 1908), an authoritative work, largely historical; P. Rohrbach, *Deutsche Kolonialwirtschaft*, Band I: *Südwestafrika* (Berlin, 1907), a comprehensive economic study; I. Irle, *Die Herero, ein Beitrag zur Landes-, Volks- und Missionskunde* (Gütersloh, 1906), a valuable summary of information concerning Damaraland; Major K. Schwabe, *Im deutschen Diamantenlande* (Berlin, 1909); I. Rehbock, *Deutsch-Südwestafrika, seine wirtschaftliche Erschliessung unter besonderer Berücksichtigung der Nutsbarmachung des Wassers* (Berlin, 1898); C. von François, *Deutsch-Südwestafrika: Geschichte der Kolonisation bis zum Ausbruch des Krieges mit Witbooi, April 1893* (Berlin, 1899), a history of the protectorate up to 1893; H. Schintz, *Deutsch-Südwestafrika, Forschungsreisen durch die deutschen Schutzgebiete Grotz-Nama und Hereroland, nach dem Kunene, &c., 1884-1887* (Oldenburg, n.d. [1891]); H. von François, *Nama und Damara* (Magdeburg, n.d. [1896]). See also for Ethnology, "Die Eingeborenen Deutsch-Südwestafrikas nach Geschichte, Charakter, Sitten, Gebräuchen und Sprachen," in *Mitteilungen des Seminars für orientalische Sprachen* (Berlin and Stuttgart) for 1899 and 1900; and G. W. Stow, *The Native Races of South Africa* (London, 1905); ch. xvii. contains an account of the Afrikaander family. For geology consult A. Schenk, "Die geologische Entwicklung Südafrikas (mit Karte)," *Peterm. Mit.* (1888); Stromer von Reichenbach, *Die Geologie der deutschen Schutzgebiete in Afrika* (Munich and Leipzig, 1896). Of early books of travel the most valuable are: F. Galton, *Theological South Africa* (1853; new ed. 1889); Charles J. Anderson, *Lake Ngami* (1858);

The Hottentots subdued.

The Obosango River (1867) and *Notes of Travel* (1873). See also Sir J. E. Alexander, *An Expedition of Discovery into the Interior of Africa* (London, 1838). Reports on the German colonies are published by the British foreign office. The *Kriegskarte von Deutsch-Südwestafrika* (Berlin, 1904), in nine sheets on a scale of 1:300,000, will be found useful. (F. R. C.)

GERMANTOWN, a residential district and former suburb, now the Twenty-second Ward, of Philadelphia, Pennsylvania, U.S.A., on Wissahickon Creek, in the N. part of the city. It is served by the Pennsylvania and the Philadelphia & Reading railways. There are many old colonial houses and handsome modern residences along Main Street (the old Germantown Road or Avenue). Prominent among the historic houses is Cliveden, or the "Chew House," built about 1761 by Benjamin Chew (1722-1810), who was chief-justice of Pennsylvania in 1774-1777 and was imprisoned as a Loyalist in 1777, and whose home during the battle of Germantown (see below) was occupied by British troops. The well-preserved Morris House (1772) was the headquarters of General Howe at the close of the battle, and in 1793, when Germantown, owing to the yellow fever in Philadelphia, was the temporary capital of the United States, it was occupied by President Washington. Three doors above stood until 1904 the Ashmead House, used for a time by Count Nicholas Lewis Zinzendorf and his daughters for their Moravian school, which was removed to Bethlehem. In the same street, opposite Indian Queen Lane, is the old Wister Mansion, built as a country-seat in 1744 and occupied by British officers during the War of Independence. In another old house (now Nos. 5275-5277), John Fanning Watson (1779-1866), the annalist of Philadelphia, did most of his literary work. Just outside the ward limits, in what has since become a part of Fairmont Park, is the house in which David Rittenhouse, the astronomer, was born; it stands on Monoshore Creek or Paper Mill Run, in what was long called Roxborough (now the 21st ward of Philadelphia). In this vicinity the first paper mill in America was erected in 1690 by a company of which William Rittenhouse, David's great-grandfather, was the leading member. The King of Prussia Inn, built about 1740, and the Mermaid Hotel, as old or older, are interesting survivals of the inns and taverns of old Germantown. The Germantown Academy was built in 1760, and after the battle of Germantown was used by the British as a hospital. In Germantown are also a Friends' (orthodox) school, a Friends' free library, and the Germantown branch of the Philadelphia public library. The first school in Germantown was established about 1701, and for the first eighteen years was under the mastership of Francis Daniel Pastorius (1651-1719), the leader in founding the town, who lived in a house that stood on the site of the present First Methodist Episcopal church, High Street and Main Street. He compiled a primer which was the first school book produced in the state; with three others he drafted and signed in 1688 what seems to have been the first public protest made in America against slavery; and he is celebrated in Whittier's *Pennsylvania Pilgrim*. Later the same school passed to Christopher Dock (d. 1771), who in 1770 published an essay on teaching (written in 1750), which is said to have been the first book on pedagogy published in America. The first Bible printed in America in any European language was published in Germantown in 1743 by Christopher Sauer (d. 1758), a preacher of the German Baptist Brethren, who in 1739 established Germantown's first newspaper, *The High German Pennsylvania Historian, or Collection of Important News from the Kingdom of Nature and of the Church*. His grandsons are said to have cast about 1772 the first American printing type. The Friends were the first sect to erect a meeting-house of their own (about 1693). The Mennonites built a log meeting-house in 1709, and their present stone church was built in 1770. The town hall of Germantown was used as a hospital during the last three years of the Civil War. In Market Square a soldiers' monument was erected in 1883. The Site and Relic Society of Germantown maintains a museum of relics. Many of the early settlers were linen weavers, and Germantown still manufactures textiles, knit goods and yarns.

Germantown was founded in October 1683 by thirteen families from Crefeld, Germany, under the leadership of Francis Daniel

Pastorius. The township, as originally laid out, contained four distinct villages known as Germantown, Creshcim, Sommerhausen and Crefeld. Creshcim was later known as Mount Airy, and Sommerhausen and Crefeld became known as Chestnut Hill. The borough of Germantown was incorporated in 1686. For many years it was a straggling village extending about 2 m. along Main Street. Its growth was more rapid from the middle of the 18th century. In 1789 a motion for the permanent location of the national capital at Germantown was carried in the Senate, and the same measure passed the House, amended only with respect to the temporary government of the ceded district; but the Senate killed the bill by voting to postpone further consideration of it until the next session. Germantown was annexed to Philadelphia in 1854.

Battle of Germantown.—This famous encounter in the American War of Independence was fought on the 4th of October 1777. After the battle of Brandywine (q.v.) and the occupation of Philadelphia, the British force commanded by Sir W. Howe encamped at Germantown, where Washington determined to attack them. The Americans advanced by two roads, General Sullivan leading the column on the right and General Greene that on the left. Washington himself accompanied Sullivan, with whom were Stirling (an officer who claimed to be earl of that name) and Anthony Wayne. The right at first met with success, driving the British advanced troops back on the main body near the Chew House. Colonel Musgrave, of the 40th Foot, threw a portion of his regiment into this house, and General Agnew came up with his command. The Americans under Stirling attempted to dislodge Musgrave, thus losing time and alarming part of Sullivan's advance who had pushed farther forward in the fog. General Greene on the left was even less fortunate. Meeting with unexpected opposition at the first point of attack his troops were thrown into confusion and compelled to retreat. One of his brigades extended itself to the right wing, and by opening fire on the Chew House caused Wayne to retreat, and presently both of the American columns retired rapidly in the direction of their camp. The surprise had failed, with the loss to Washington's army of 673 men as against 500 on the side of the British. The British General Agnew and the American General Nash were both mortally wounded. In December Washington went into winter quarters at Valley Forge, 40 m. west of Philadelphia. The British wintered in and around the city.

See N. H. Keyser, "Old Historic Germantown," in the *Proceedings and Addresses of the Pennsylvania-German Society* (Lancaster, 1906); S. W. Pennypacker, *The Settlement of Germantown, Pennsylvania, and the Beginning of German Emigration to North America* (Philadelphia, 1899), and S. F. Hotchkin, *Ancient and Modern Germantown, Mount Airy and Chestnut Hill* (Philadelphia, 1889).

GERMANY (Ger. *Deutschland*), or, more properly, **THE GERMAN EMPIRE** (*Deutsches Reich*), a country of central Europe. The territories occupied by peoples of distinctively Teutonic race and language are commonly designated as German, and in this sense may be taken to include, besides Germany proper (the subject of the present article), the German-speaking sections of Austria, Switzerland and Holland. But Germany, or the German empire, as it is now understood, was formed in 1871 by virtue of treaties between the North German Confederation and the South German states, and by the acquisition, in the peace of Frankfurt (May 10, 1871), of Alsace-Lorraine, and embraces all the countries of the former German Confederation, with the exception of Austria, Luxemburg, Limburg and Liechtenstein. The sole addition to the empire proper since that date is the island of Heligoland, ceded by Great Britain in 1890, but Germany has acquired extensive colonies in Africa and the Pacific (see below, *Colonies*).

The German empire extends from 47° 16' to 55° 53' N., and from 5° 52' to 22° 52' E. The eastern provinces project so far that the extent of German territory is much greater from southwest to north-east than in any other direction. Tilsit is 815 m. from Metz, whereas Hadersleben, in Schleswig, is only 540 m. from the Lake of Constance. The actual difference in time between the eastern and western points is 1 hour and 8 minutes,

but the empire observes but one time—1 hour E. of Greenwich. The empire is bounded on the S.E. and S. by Austria and Switzerland (for 1650 m.), on the S.W. by France (242 m.), on the W. by Luxembourg, Belgium and Holland (together 558 m.). The length of German coast on the North Sea or German Ocean is 293 m., and on the Baltic 927 m., the intervening land boundary on the north of Schleswig being only 47 m. The eastern boundary is with Russia 843 m. The total length of the frontiers is thus 4569 m. The area, including rivers and lakes but not the *haffs* or lagoons on the Baltic coast, is 208,830 sq. m., and the population (1905) 60,641,278. In respect of its area, the German empire occupied in 1909 the third place among European countries, and in point of population the second, coming in point of area immediately after Russia and Austria-Hungary, and in population next to Russia.

Political Divisions.—The empire is composed of the following twenty-six states and divisions: the kingdoms of Prussia, Bavaria, Saxony and Württemberg; the grand-duchies of Baden, Hesse, Mecklenburg-Schwerin, Mecklenburg-Strelitz, Oldenburg and Saxe-Weimar; the duchies of Anhalt, Brunswick, Saxe-Altenburg, Saxe-Coburg-Gotha and Saxe-Meiningen; the principalities of Lippe-Deimold, Reuss-Greiz, Reuss-Schleiz, Schaumburg-Lippe, Schwarzburg-Rudolstadt, Schwarzburg-Sondershausen and Waldeck-Pyrmont; the free towns of Bremen, Hamburg and Lübeck, and the imperial territory of Alsace-Lorraine.

Besides these political divisions there are certain parts of Germany which, not conforming with political boundaries, retain appellations derived either from former tribal settlements or from divisions of the old Holy Roman Empire. These are Franconia (Franken), which embraces the districts of Bamberg, Schweinfurt and Würzburg on the upper Main; Swabia (Schwaben), in which is included Württemberg, parts of Bavaria and Baden and Hohenzollern; the Palatinate (Pfalz), embracing Bavaria west of the Rhine and the contiguous portion of Baden; Rhineland, applied to Rhenish Prussia, Nassau, Hesse-Darmstadt and parts of Bavaria and Baden; Vogtland,¹ the mountainous country lying in the south-west corner of the kingdom of Saxony; Lusatia (Lausitz), the eastern portion of the kingdom of Saxony and the adjacent portion of Prussia watered by the upper Spree; Thuringia (Thüringen), the country lying south of the Harz Mountains and including the Saxon duchies; East Friesland (Ost Friesland), the country lying between the lower course of the Weser and the Ems, and Westphalia (Westfalen), the fertile plain lying north and west of the Harz Mountains and extending to the North Sea and the Dutch frontier.

Coast and Islands.—The length of the coast-line is considerably less than the third part of the whole frontier. The coasts are shallow, and deficient in natural ports, except on the east of Schleswig-Holstein, where wide bays encroach upon the land, giving access to the largest vessels, so that the great naval harbour could be constructed at Kiel. With the exception of those on the east coast of Schleswig-Holstein, all the important trading ports of Germany are river ports, such as Emden, Bremen, Hamburg, Lübeck, Stettin, Danzig, Königsberg, Memel. A great difference, however, is to be remarked between the coasts of the North Sea and those of the Baltic. On the former, where the sea has broken up the ranges of dunes formed in bygone times, and divided them into separate islands, the mainland has to be protected by massive dikes, while the Frisian Islands are being gradually washed away by the waters. On the coast of East Friesland there are now only seven of these islands, of which Norderney is best known, while of the North Frisian Islands, on the western coast of Schleswig, Sylt is the most considerable. Besides the ordinary waste of the shores, there have been extensive inundations by the sea within the historic period, the gulf of the Dollart having been so caused in the year 1276. Sands surround the whole coast of the North Sea to such an extent that the entrance to the ports is not practicable without the aid of pilots. Heligoland is a rocky island, but it

¹ *i.e.* the territory once under the jurisdiction of an imperial *Vogt* or *advocatus* (see *ADVOCATE*).

also has been considerably reduced by the sea. The tides rise to the height of 12 or 13 ft. in the Jade Bay and at Bremerhaven, and 6 or 7 ft. at Hamburg. The coast of the Baltic, on the other hand, possesses few islands, the chief being Alsen and Fehmarn off the coast of Schleswig-Holstein, and Rügen off Pomerania. It has no extensive sands, though on the whole very flat. The Baltic has no perceptible tides; and a great part of its coast-line is in winter covered with ice, which also so blocks up the harbours that navigation is interrupted for several months every year. Its *haffs* fronting the mouths of the larger rivers must be regarded as lagoons or extensions of the river beds, not as bays. The Pommersche or Oder Haff is separated from the sea by two islands, so that the river flows out by three mouths, the middle one (Swine) being the most considerable. The Frische Haff is formed by the Nogat, a branch of the Vistula, and by the Pregel, and communicates with the sea by means of the Pillauer Tief. The Kurische Haff receives the Memel, called Niemen in Russia, and has its outlet in the extreme north at Memel. Long narrow alluvial strips called *Nehrungen*, lie between the last two haffs and the Baltic. The Baltic coast is further marked by large indentations, the Gulf of Lübeck, that of Pomerania, east of Rügen, and the semicircular Bay of Danzig between the promontories of Rixhöft and Brästerort. The German coasts are well provided with lighthouses.

Surface.—In respect of physical structure Germany is divided into two entirely distinct portions, which bear to one another a ratio of about 3 to 4. The northern and larger part may be described as a uniform plain. South and central Germany, on the other hand, is very much diversified in scenery. It possesses large plateaus, such as that of Bavaria, which stretches away from the foot of the Alps, fertile low plains like that intersected by the Rhine, mountain chains and isolated groups of mountains, comparatively low in height, and so situated as not seriously to interfere with communication either by road or by railway.

Bavaria is the only division of the country that includes within it any part of the Alps, the Austro-Bavarian frontier running along the ridge of the Northern Tirolese or Bavarian Alps. The *Mountain and plateau* (highest peak of this group, the Zugspitze (57 m. S. of Munich), is 9738 ft. in height, being the highest summit in the empire. The upper German plain sloping northwards from the Bavarian Alps is watered by the Lech, the Isar and the Inn, tributaries of the Danube, all three rising beyond the limits of German territory. This plain is separated on the west from the Swiss plain by the Lake of Constance (Bodensee, 1306 ft. above sea-level), and on the east from the undulating grounds of Austria by the Inn. The average height of the plain may be estimated at about 1800 ft., the valley of the Danube on its north border being from 1540 ft. (at Ulm) to 920 ft. (at Passau). The plain is not very fertile. In the upper part of the plain, towards the Alps, there are several lakes, the largest being the Ammersee, the Würmsee or Starnberger See and the Chiemsee. Many portions of the plain are covered by moors and swamps of large extent, called *Mooss*. The left or northern bank of the Danube from Regensburg downwards presents a series of granitic rocks called the Bavarian Forest (Bayrischer Wald), which must be regarded as a branch of the Bohemian Forest (Böhmer Wald). The latter is a range of wooded heights on the frontier of Bavaria and Bohemia, occupying the least known and least frequented regions of Germany. The summits of the Bayrischer Wald rise to the height of about 4000 ft., and those of the Böhmer Wald to 4800 ft., Arber being 4872 ft. The valley of the Danube above Regensburg is flanked by plateaus sloping gently to the Danube, but precipitous towards the valley of the Neckar. The centre of this elevated tract is the Raube Alb, so named on account of the harshness of the climate. The plateau continuing to the north-east and then to the north, under the name of the Franconian Jura, is crossed by the valley of the winding Altmühl, and extends to the Main. To the west extensive undulating grounds or low plateaus occupy the area between the Main and the Neckar.

The south-western corner of the empire contains a series of better defined hill-ranges. Beginning with the Black Forest (Schwarzwald), we find its southern heights decline to the valley of the Rhine, above Basel, and to the Jura. The summits are rounded and covered with wood, the highest being the Feldberg (10 m. S.E. of Freiburg, 4898 ft.). Northwards the Black Forest passes into the plateau of the Neckarbergland (average height, 1000 ft.). The heights between the lower Neckar and the Main form the Odenwald (about 1700 ft.); and the Spessart, which is watered by the Main on three sides, is nothing but a continuation of the Odenwald. West of this range of hills lies the valley of the upper Rhine, extending about 180 m. from south to north, and with a width of only 20 to 25 m. In the upper parts the Rhine is rapid, and therefore navigable with difficulty; this explains why the towns there are not along the banks of the river, but some 5 to 10 m. off. But from Speyer (Speyers) south

one proceeds to the east the greater are the contrasts of summer and winter. While the average summer warmth of Germany is 60° to 62°, the January temperature falls as low as 26° to 28° in West Prussia, Posen and Silesia, and 22° to 26° in East Prussia and upper Silesia. The navigation of the rivers is regularly interrupted by frost. Similarly the upper basin of the Danube, or the Bavarian plain, has a rather inclement climate in winter, the average for January being 25° to 26°.

As regards rainfall, Germany belongs to those regions where precipitation takes place at all seasons, but chiefly in the form of summer rains. In respect to the quantity of rain the empire takes a middle position between the humidity of north-western Europe and the aridity of the east. There are considerable differences between particular places. The rainfall is greatest in the Bavarian tableland and the hilly regions of western Germany. For the Eifel, Sauerland, Harz, Thuringian Forest, Rhön, Vogelsberg, Spessart, the Black Forest, the Vosges, &c., the annual average may be stated at 34 in. or more, while in the lower terraces of south-western Germany, as in the Erzgebirge and the Sudectic range, it is estimated at 30 to 32 in. only. The same average obtains also on the humid north-west coast of Germany as far as Bremen and Hamburg. In the remaining parts of western Germany, on the shores of farther Pomerania, and in East Prussia, it amounts to upwards of 24 in. In western Germany there is a district famous for the scarcity of rain and for producing the best kind of wine: in the valley of the Rhine below Strassburg, in the Palatinate, and also in the valley of the Main, no more than from 16 to 20 in. fall. Mecklenburg, Brandenburg and Lusatia, Saxony and the plateau of Thuringia, West Prussia, Posen and lower Silesia are also to be classed among the more arid regions of Germany, the annual rainfall being 16 to 20 in. Thunderstorms are most frequent in July, and vary between fifteen and twenty-five in the central districts, descending in the eastern provinces of Prussia to ten annually.

Flora.—The flora of Germany comprises 3413 species of phanerogamic and 4306 cryptogamic plants. The country forms a section of the central European zone, and its flora is largely under the influence of the Baltic and Alpine elements, which to a great degree here coalesce. All plants peculiar to the temperate zone abound. Wheat, rye, barley and oats are cultivated everywhere, but spelt only in the south and buckwheat in the north and north-west. Maize only ripens in the south. Potatoes grow in every part of the country, those of the sandy plains in the north being of excellent quality. All the commoner sorts of fruit—apples, pears, cherries, &c.—grow everywhere, but the more delicate kinds, such as figs, apricots and peaches, are confined to the warmer districts. The vine flourishes as far as the 51° N., but only yields good wine in the districts of the Rhine and Danube. Flax is grown in the north, and hemp more particularly in the central districts. Rape can be produced everywhere when the soil permits. Tobacco is cultivated on the upper Rhine and in the valley of the Oder. The northern plain, especially in the province of Saxony, produces beet (for sugar), and hops are largely grown in Bavaria, Württemberg, Alsace, Baden and the Prussian province of Posen.

Speaking generally, northern Germany is not nearly so well wooded as central and southern Germany, where indeed most of the lower mountains are covered with timber, as is indicated by the frequent use of the termination *wald* affixed to the names of the mountain ranges (as Schwarzwald, Thüringerwald, &c.). The "Seenplatten" are less wooded than the hill country, but the eastern portion of the northern lowlands is well provided with timber.

A narrow strip along the shores of the Baltic is covered with oaks and beeches; farther inland, and especially east of the Elbe, coniferous trees are the most prevalent, particularly the Scotch fir; birches are also abundant. The mountain forests consist chiefly of firs, pines and larches, but contain also silver firs, beeches and oaks. Chestnuts and walnuts appear on the terraces of the Rhine valley and in Swabia and Franconia. The whole north-west of Germany is desti-

tute of wood, but to compensate for this the people have ample supplies of fuel in the extensive stretches of turf.

Fauna.—The number of wild animals in Germany is not very great. Foxes, martens, weasels, badgers and otters are to be found everywhere; bears are found in the Alps, wolves are rare, but they find their way sometimes from French territory to the western provinces, or from Poland to Prussia and Posen. Among the rodents the hamster and the field-mouse are a scourge to agriculture. Of game there are the roe, stag, boar and hare; the fallow deer and the wild rabbit are less common. The elk is to be found in the forests of East Prussia. The feathered tribes are everywhere abundant in the fields, woods and marshes. Wild geese and ducks, grouse, partridges, snipe, woodcock, quails, widgeons and teal are plentiful all over the country, and in recent years preserves have been largely stocked with pheasants. The length of time that birds of passage remain in Germany differs considerably with the different species. The stork is seen for about 170 days, the house-swallow 160, the snow-goose 260, the snipe 220. In northern Germany these birds arrive from twenty to thirty days later than in the south.

The waters of Germany abound with fish; but the genera and species are few. The carp and salmon tribes are the most abundant; after them rank the pike, the eel, the shad, the roach, the perch and the lamprey. The Oder and some of the tributaries of the Elbe abound in crayfish, and in the stagnant lakes of East Prussia leeches are bred. In addition to frogs, Germany has few varieties of Amphibia. Of serpents there are only two poisonous kinds, the common viper and the adder (*Kreuzotter*).

Population.—Until comparatively recent times no estimate of the population of Germany was precise enough to be of any value. At the beginning of the 19th century the country was divided into some hundred states, but there was no central agency for instituting an exact census on a uniform plan. The formation of the German Confederation in 1815 effected but little change in this respect, and it was left to the different states to arrange in what manner the census should be taken. On the foundation, however, of the German customs union, or *Zollverein*, between certain German states, the necessity for accurate statistics became apparent and care was taken to compile trustworthy tables. Researches show the population of the German empire, as at present constituted, to have been: (1816) 24,833,396; (1855) 36,113,644; and (1871) 41,058,792. The following table shows the population and area of each of the states included in the empire for the years 1871, 1875, 1900 and 1905:—

Area and Population of the German States.

States of the Empire.	Area English Sq. m.	Population.				Density per Sq. m.
		1871.	1875.	1900.	1905.	
Kingdoms—						
Prussia	134,616	24,691,433	25,742,404	34,472,509	37,293,324	277.3
Bavaria	29,292	4,863,459	5,022,390	6,176,957	6,524,372	232.7
Saxony	5,789	2,556,244	2,760,586	4,202,216	4,508,001	778.8
Württemberg	7,534	1,818,539	1,881,505	2,169,480	2,302,179	305.5
Grand-Duchies—						
Baden	5,823	1,461,562	1,507,179	1,867,944	2,010,728	345.3
Hesse	2,966	852,894	884,218	1,119,893	1,209,175	407.6
Mecklenburg-Schwerin	5,068	537,897	553,785	607,770	625,045	123.3
Saxe-Weimar	1,397	286,183	292,933	362,873	388,095	277.8
Mecklenburg-Strelitz	1,131	96,982	95,673	102,602	103,451	91.5
Oldenburg	2,482	314,459	319,314	399,180	438,856	176.8
Duchies—						
Brunswick	1,418	311,764	327,493	464,333	485,958	342.5
Saxe-Meiningen	953	187,957	194,494	259,731	268,916	282.2
Saxe-Altenburg	511	142,122	145,844	194,914	206,508	404.1
Saxe-Coburg-Gotha	764	174,339	182,599	229,550	242,432	317.3
Anhalt	888	203,437	213,595	316,085	328,029	369.4
Principalities—						
Schwarzburg-Sondershausen	333	75,523	76,676	80,898	85,152	255.7
Schwarzburg-Rudolstadt	363	67,191	67,480	93,059	96,835	266.7
Waldeck	433	56,274	54,743	57,918	59,127	136.5
Reuss-Griz	122	45,094	46,085	68,396	79,603	578.7
Reuss-Schleiz	319	89,612	92,375	139,210	144,584	453.2
Schaumburg-Lippe	131	32,059	33,133	43,132	44,992	343.4
Lippe	469	111,135	112,452	138,952	145,577	310.4
Free Towns—						
Lübeck	115	52,158	56,912	96,775	105,857	920.5
Bremen	99	122,402	142,200	224,882	263,440	2661.0
Hamburg	160	338,974	388,618	768,349	874,878	5467.9
Imperial Territory—						
Alsace-Lorraine	5,604	1,549,738	1,531,804	1,719,470	1,814,564	323.8
German Empire	208,780	41,058,792	42,727,360	56,367,178	60,641,278	290.4



The population of the empire has thus increased, since 1871, by 19,582,486 or 47.6%. The increase of population during 1895-1900 was greatest in Hamburg, Bremen, Lübeck, Saxony, Prussia and Baden, and least in Mecklenburg-Strelitz and Waldeck. Of the total population in 1900, 54.3% were urban (i.e. living in towns of 2000 inhabitants and above), leaving 45.7% to be classified as rural. On the 1st of December 1905, of the total population 29,884,681 were males and 30,756,597 females; and it is noticeable that the male population shows of late years a larger relative increase than the female, the male population having in five years increased by 2,147,434 and the female by only 2,126,666. The greater increase in the male population is attributable to diminished emigration and to the large increase in immigrants, who are mostly males. In 1905, 485,906 marriages were contracted in Germany, being at the rate of 8.0 per thousand inhabitants. In the same year the total number of births was 2,048,453. Of these, 61,300 were stillborn and 174,494 illegitimate, being at the rate, respectively, of 3% and 8.5% of the total. Illegitimacy is highest in Bavaria (about 15%), Berlin (14%), and over 12% in Saxony, Mecklenburg-Schwerin and Saxe-Meiningen. It is lowest in the Rhine Province and Westphalia (3.9 and 2.6 respectively). Divorce is steadily on the increase, being in 1904, 11.1 per 10,000 marriages, as against 8.1, 8.1, 9.3 and 10.1 for the four preceding years. The average deaths for the years 1901-1905 amounted to 1,227,903; the rate was thus 20.2 per thousand inhabitants, but the death-rate has materially decreased, the total number of deaths in 1907 standing at 1,178,349; the births for the same year were 2,060,974. In connexion with suicides, it is interesting to observe that the highest rates prevail in some of the smaller and more prosperous states of the empire—for example, in Saxe-Weimar, Saxe-Coburg-Gotha and Saxe-Altenburg (on a three years' average of figures), while the Roman Catholic country Bavaria, and the impoverished Prussian province of Posen show the most favourable statistics. For Prussia the rate is 20, and for Saxony it is as high as 31 per 100,000 inhabitants. The large cities, notably Berlin, Hamburg, Breslau and Dresden, show, however, relatively the largest proportion.

In 1900 the German-speaking population of the empire amounted to 51,883,131. Of the inhabitants speaking other languages there were: Polish, 3,086,489; French (mostly in Lorraine), 211,679; Masurian, 142,049; Danish, 141,061; Lithuanian, 106,305; Cassubian, 100,213; Wendish, 95,032; Dutch, 80,361; Italian, 65,961; Moravian, 64,382; Czech, 43,016; Frisian, 20,677; English, 20,217; Walloon, 11,841. In 1905 there were resident within the empire 1,008,650 subjects of foreign states, as compared with 778,698 in 1900. Of these 17,203 were subjects of Great Britain and Ireland, 17,181 of the United States of America and 20,584 of France. The bulk of the other foreigners residing in the country belonged to countries lying contiguous, such as Austria, which claimed nearly the half, Russia and Italy.

Languages.—The German-speaking nations in their various branches and dialects, if we include the Dutch and the Walloons, extend in a compact mass along the shores of the Baltic and of the North Sea, from Memel in the east to a point between Gravelines and Calais near the Straits of Dover. On this northern line the Germans come in contact with the Danes who inhabit the northern parts of Schleswig within the limits of the German empire. A line from Flensburg south-westward to Joldelund and thence north-westward to Hoyer will nearly give the boundary between the two idioms.¹ The German-French frontier traverses Belgium from west to east, touching the towns of St Omer, Courtrai and Maastricht. Near Eupen, south of Aix-la-Chapelle, it turns southward, and near Arlon south-east as far as the crest of the Vosges mountains, which it follows up to Belfort, traversing there the watershed of the Rhine and the Doubs. In the Swiss territory the line of demarcation passes through Bienne, Fribourg, Saanen, Leuk and Monte Rosa. In the south the Germans come into contact with Rhetio-Romans and Italians, the former inhabiting the valley of the Vorder-Rhein and the Engadine, while the latter have settled on the southern slopes of the Alps, and are continually advancing up the valley of the Adige. Carinthia and Styria are inhabited by German people, except the valley of the Drave towards Klagenfurt. Their eastern neighbours there are first the Magyars, then the northern Slavs and the Poles. The whole eastern frontier is very much broken, and cannot be described in a few words. Besides detached German colonies in Hungary proper, there is a considerable and compact German (Saxon) population in Transylvania. The river March is the frontier north of the Danube from Pressburg as far as Brünn, to the north of which the German regions begin near Olmütz, the interior of Bohemia and Moravia being occupied by Czechs and Moravians. In these countries the Slav language has been steadily superseding the German. In the Prussian provinces of Silesia and Posen the eastern parts are mixed territories, the German language progressing very slowly among the Poles. In Bromberg and Thorn, in the valley of the Vistula, German is prevalent. In West Prussia some parts of the interior, and in East Prussia a small region along the Russian frontier, are occupied by Poles (Casubians in West Prussia, Masurians in

East Prussia). The total number of German-speaking people, within the boundaries wherein they constitute the compact mass of the population, may be estimated, if the Dutch and Walloons be included, at 65 millions.

The geographical limits of the German language thus do not quite coincide with the German frontiers. The empire contains about 33 millions of persons who do not make use of German in everyday life, not counting the resident foreigners.

Apart from the foreigners above mentioned, German subjects speaking a tongue other than German are found only in Prussia, Saxony and Alsace-Lorraine. The following table shows roughly the distribution of German-speaking people in the world outside the German empire:—

Austria-Hungary	12,000,000	Other European Countries	2,300,000
Netherlands (Dutch)	5,000,000	America	13,000,000
Belgium (Walloon)	4,000,000	Asia	100,000
Luxemburg	200,000	Africa	600,000
Switzerland	2,300,000	Australia	150,000
France	500,000		

According to the census of the 1st of December 1900 there were 51,634,757 persons speaking commonly one language and 248,374 speaking two languages. In the kingdom of Saxony, according to the census of 1900, there were 48,000 Wends, mostly in Lusatia. With respect to Alsace-Lorraine, detailed estimates (but no census) gave the number of French in the territory of Lorraine at about 170,000, and in that of Alsace at about 46,000.

The Poles have increased very much, owing to a greater surplus of births than in the case of the German people in the eastern provinces of Prussia, to immigration from Russia, and to the Polonization of many Germans through clerical and other influences (see *History*). The Poles are in the majority in upper Silesia (Government district of Oppeln, 55%) and the province of Posen (60%). They are numerous in West Prussia (34%) and East Prussia (14%).

The Wends are decreasing in number, as are also the Lithuanians on the eastern border of East Prussia, Czechs are only found in Silesia on the confines of Bohemia.

Russians flocked to Germany in thousands after the Russo-Japanese War and the insurrections in Russia, and the figures given for 1900 had been doubled in 1907. Males predominate among the various nationalities, with the exception of the British, the larger proportion of whom are females either in domestic service or engaged in tuition.

Chief Towns.—According to the results of the census of the 1st of December 1905 there were within the empire 47 towns with populations exceeding 100,000, viz:—

	State.	Population.
Berlin	Prussia	2,040,148
Hamburg	Hamburg	802,793
Munich	Bavaria	538,393
Dresden	Saxony	516,996
Leipzig	"	502,570
Breslau	Prussia	470,751
Cologne	"	428,593
Frankfort-on-Main	"	334,951
Nuremberg	Bavaria	294,344
Düsseldorf	Prussia	253,099
Hanover	"	250,032
Stuttgart	Württemberg	249,443
Chemnitz	Saxony	244,405
Magdeburg	Prussia	240,661
Charlottenburg	"	239,512
Essen	"	231,396
Stettin	"	224,078
Königsberg	"	219,862
Bremen	Bremen	214,953
Duisburg	Prussia	192,227
Dortmund	"	175,575
Halle	"	169,899
Altona	"	168,301
Strassburg	Alsace-Lorraine	167,342
Kiel	Prussia	163,710
Elberfeld	"	162,682
Mannheim	Baden	162,607
Danzig	Prussia	159,685
Barmen	"	156,148
Rixdorf	"	153,650
Gelsenkirchen	"	147,037
Aix-la-Chapelle	"	143,000
Schönberg	"	140,992
Brunswick	Brunswick	136,423
Posen	Prussia	137,067
Cassel	"	120,446
Bochum	"	118,455
Karlsruhe	Baden	111,200
Crefeld	Prussia	110,347
Plauen	Saxony	105,182
Wiesbaden	Prussia	100,953

¹ The question, much disputed between Germans and Danes, is exclusively treated by P. Lauridsen in F. de Jeason's *La Question de Slesvig* (Copenhagen, 1906), pp. 114 et seq.

Density of Population.—In respect of density of population, Germany with (1900) 269.9 and (1905) 300.4 inhabitants to the square mile is exceeded in Europe only by Belgium, Holland and England. Apart from the free cities, Hamburg, Bremen and Lübeck, the kingdom of Saxony is the most, and Mecklenburg-Strelitz the least, closely peopled state of the empire. The most thinly populated districts are found, not as might be expected in the mountain regions, but in some parts of the plains. Leaving out of account the small centres, Germany may be roughly divided into two thinly and two densely populated parts. In the former division has to be classed all the North German plain. There it is only in the valleys of the larger navigable rivers and on the southern border of the plain that the density exceeds 200 inhabitants per square mile. In some places, indeed, it is far greater, e.g. at the mouths of the Elbe and the Weser, in East Holstein, in the delta of the Memel and the environs of Hamburg. This region is bordered on the south by a densely peopled district, the northern boundary of which may be defined by a line from Coburg via Cassel to Münster, for in this part there are not only very fertile districts, such as the *Goldene Aue* in Thuringia, but also centres of industry. The population is thickest in upper Silesia around Beuthen (coal-fields), around Ratibor, Neisse and Waldenburg (coal-fields), around Zittau (kingdom of Saxony), in the Elbe valley around Dresden, in the districts of Zwickau and Leipzig as far as the Saale, on the northern slopes of the Harz and around Bielefeld in Westphalia. In all these the density exceeds 400 inhabitants to the square mile, and in the case of Saxony rises to 750. The third division of Germany comprises the basin of the Danube and Franconia, where around Nuremberg, Bamberg and Würzburg the population is thickly clustered. The fourth division embraces the valleys of the upper Rhine and Neckar and the district of Düsseldorf on the lower Rhine. In this last the proportion exceeds 1200 inhabitants to the square mile.

Emigration.—There have been great oscillations in the actual emigration by sea. It first exceeded 100,000 soon after the Franco-German War (1872, 126,000), and this occurred again in the years 1880 to 1892. Germany lost during these thirteen years more than 1,700,000 inhabitants by emigration. The total number of those who sailed for the United States from 1820 to 1900 may be estimated at more than 4,500,000. The number of German emigrants to Brazil between 1870 and 1900 was about 52,000. The greater number of the more recent emigrants was from the agricultural provinces of northern Germany—West Prussia, Posen, Pomerania, Mecklenburg, Schleswig-Holstein and Hanover, and sometimes the emigration reached 1% of the total population of these provinces. In subsequent years the emigration of native Germans greatly decreased and, in 1905, amounted only to 28,075. But to this number must be added 284,787 foreigners who in that year were shipped from German ports (notably Hamburg and Bremen) to distant parts. Of the above given numbers of purely German emigrants 26,007 sailed for the United States of America; 243 to Canada; 333 to Brazil; 674 to the Argentine Republic; 7 to other parts of America; 57 to Africa; and 84 to Australia.

Agriculture.—Despite the enormous development of industries and commerce, agriculture and cattle-rearing still represent in Germany a considerable portion of its economic wealth. Almost two-thirds of the soil is occupied by arable land, pastures and meadows, and of the whole area, in 1900, 91% was classed as productive. Of the total area 47.07% was occupied by land under tillage, 0.89% by gardens, 11.02% by meadow-land, 5.01% by pastures, and 0.25% by vineyards. The largest estates are found in the Prussian provinces of Pomerania, Posen and Saxony, and in East and West Prussia, while in the Prussian Rhine province, in Baden and Württemberg small farms are the rule.

The same kinds of cereal crops are cultivated in all parts of the empire, but in the south and west wheat is predominant, and in the north and east rye, oats and barley. To these in some districts are added spelt, buckwheat, millet, rice-wheat, lesser spelt and maize. In general the soil is remarkably well cultivated. The three years' rotation formerly in use, where autumn and spring-sown grain and fallow succeeded each other, has now been abandoned, except in some districts, where the system has been modified and improved. In south Germany the so-called *Fruchtwechsel* is practised, the fields being sown with grain crops every second year, and with peas or beans, grasses, potatoes, turnips, &c., in the intermediate years. In north Germany the mixed *Koppelwirtschaft* is the rule, by which system, after several years of grain crops, the ground is for two or three seasons in pasture.

Taking the average of the six years 1900-1905, the crop of wheat amounted to 3,550,033 tons (metric), rye to 9,296,616 tons, barley to 3,102,883 tons, and oats to 7,160,883 tons. But, in spite of this considerable yield in cereals, Germany cannot cover her home consumption, and imported on the average of the six years 1900-1905 about 4½ million tons of cereals to supply the deficiency. The potato is largely cultivated, not merely for food, but for distillation into spirits. This manufacture is prosecuted especially in eastern Germany. The number of distilleries throughout the German empire was, in 1905-1906, 68,405. The common beet

(*Beta vulgaris*) is largely grown in some districts for the production of sugar, which has greatly increased of recent years. There are two centres of the beet sugar production: Magdeburg for the districts Prussian Saxony, Hanover, Brunswick, Anhalt and Thuringia, and Frankfort-on-Oder at the centre of the group Silesia, Brandenburg and Pomerania. Flax and hemp are cultivated, though not so much as formerly, for manufacture into linen and canvas, and also rape seed for the production of oil. The home supply of the former no longer suffices for the native demand. The cultivation of hops is in a very thriving condition in the southern states of Germany. The soil occupied by hops was estimated in 1905 at 98,000 acres—a larger area than in Great Britain, which had in the same year about 48,000 acres. The total production of hops was 29,000 tons in 1905, and of this over 25,000 were grown in Bavaria, Württemberg, Baden and Alsace-Lorraine. Almost the whole yield in hops is consumed in the country by the great breweries.

Tobacco forms a most productive and profitable object of culture in many districts. The total extent under this crop in 1905 was about 35,000 acres, of which 45% was in Baden, 12% in Bavaria, 30% in Prussia, and the rest in Alsace and Hesse-Darmstadt. In the north the plant is cultivated principally in Pomerania, Brandenburg and East and West Prussia. Of late years the production has somewhat diminished, owing to the extensive tobacco manufacturing industries of Bremen and Hamburg, which import almost exclusively foreign leaves.

Ulm, Nuremberg, Quedlinburg, Erfurt, Strasburg and Guben are famed for their vegetables and garden seeds. Berlin is noted for its flower nurseries, the Rhine valley, Württemberg and the Elbe valley below Dresden for fruit, and Frankfort-on-main for cider.

The culture of the vine is almost confined to southern and western Germany, and especially to the Rhine district. The northern limits of its growth extend from Bonn in a north-easterly direction through Cassel to the southern foot of the Harz, crossing 52° N. on the Elbe, running then east some miles to the north of that parallel, and finally turning sharply towards the south-west on the Warthe. In the valley of the Saale and Elbe (near Dresden), and in lower Silesia (between Guben and Grünberg), the number of vineyards is small, and the wines of inferior quality; but along the Rhine from Basel to Coblenz, in Alsace, Baden, the Palatinate and Hesse, and above all in the province of Nassau, the lower slopes of the hills are literally covered with vines. Here are produced the celebrated Rudesheimer, Hochheimer and Johannisberger. The vines of the lower Main, particularly those of Würzburg, are the best kinds; those of the upper Main and the valley of the Neckar are rather inferior. The Moselle wines are lighter and more acid than those of the Rhine. The total amount produced in Germany is estimated at 1000 million gallons, of a value of £4,000,000; Alsace-Lorraine turning out 400 millions; Baden, 175; Bavaria, Württemberg and Hesse together, 300; while the remainder, which though small in quantity is in quality the best, is produced by Prussia.

The cultivation of grazing lands in Germany has been greatly improved in recent times and is in a highly prosperous condition. The provinces of Schleswig-Holstein, Pomerania, Hanover (especially the marsh-lands near the sea) and the grand-duchy of Mecklenburg-Schwerin are particularly remarkable in this respect. The best meadow-lands of Bavaria are in the province of Franconia and in the outer range of the Alps, and those of Saxony in the Erzgebirge. Württemberg, Hesse and Thuringia also yield cattle of excellent quality. These large cattle-rearing centres not only supply the home markets but export live stock in considerable quantities to England and France. Butter is also largely exported to England from the North Sea districts and from Schleswig-Holstein and Mecklenburg. The breeding of horses has attained a great perfection. The main centre is in East and West Prussia, then follow the marsh districts on the Elbe and Weser, some parts of Westphalia, Oldenburg, Lippe, Saxony and upper Silesia, lower Bavaria and Alsace-Lorraine. Of the stud farms Trakehnen in East Prussia and Graditz in the Prussian province of Saxony enjoy a European reputation. The aggregate number of sheep has shown a considerable falling off, and the rearing of them is mostly carried on only on large estates, the number showing only 9,602,501 in 1900, and 7,907,200 in 1904, as against 28,000,000 in 1860. As a rule, sheep-farming is resorted to where the soil is of inferior quality and unsuitable for tillage and the breeding of cattle. Far more attention is accordingly given to sheep-farming in northern and north-eastern Germany than in Schleswig-Holstein, Westphalia, the Rhineland and south Germany. The native demand for wool is not covered by the home production, and in this article the export from the United Kingdom to Germany is steadily rising, having amounted in 1905 to a value of £1,691,035, as against £742,632 in 1900. The largest stock of pigs is in central Germany and Saxony, in Westphalia, on the lower Rhine, in Lorraine and Hesse. Central Germany (especially Gotha and Brunswick) exports sausages and hams largely, as well as Westphalia, but here again considerable importation takes place from other countries. Goats are found everywhere, but especially in the hilly districts. Poultry farming is a considerable industry, the geese of Pomerania and the fowls of Thuringia and Lorraine being in especial favour. Bee-keeping is of considerable importance, particularly in north Germany and Silesia.

On the whole, despite the prosperous condition of the German live-stock farming, the consumption of meat exceeds the amount rendered available by home production, and prices can only be kept down by a steady increase in the imports from abroad.

Fisheries.—The German fisheries, long of little importance, have been carefully fostered within recent years. The deep-sea fishing in the North Sea, (thanks to the exertions of the German fishing league (*Deutscher Fischereiverein*) and to government support, is extremely active. Trawlers are extensively employed, and steamers bring the catches directly to the large fish markets at Geestemünde and Altona, whence facilities are afforded by the railways for the rapid transport of fish to Berlin and other centres. The fish most commonly caught are cod, haddock and herrings, while Heligoland yields lobsters, and the islands of Föhr, Amrum and Sylt oysters of good quality. The German North Sea fishing fleet numbered in 1905 618 boats, with an aggregate crew of 5441 hands. Equally well developed are the Baltic fisheries, the chief ports engaged in which are Danzig, Eckernförde, Kolberg and Travemünde. The principal catch is haddock and herrings. The catch of the North Sea and Baltic fisheries in 1906 was valued at over £700,000, exclusive of herrings for salting. The fisheries do not, however, supply the demand for fish, and fresh, salt and dried fish is imported largely in excess of the home yield.

Minerals and Minerals.—Germany abounds in minerals, and the extraordinary industrial development of the country since 1870 is largely due to its mineral wealth. Having left France much behind in this respect, it now rivals Great Britain and the United States.

Germany produces more silver than any other European state, and the quantity is annually increasing. It is extracted from the ores in the mines of Freiberg (Saxony), the Harz Mountains, upper Silesia, Merseburg, Aix-la-Chapelle, Wiesbaden and Arnsberg. Gold is found in the sand of the rivers Isar, Inn and Rhine, and also, to a limited extent, on the Harz. The quantity yielded in 1905 was, of silver, about 400 tons of a value of £1,600,000, and gold, about 4 tons, valued at about £548,000.

Lead is produced in considerable quantities in upper Silesia, the Harz Mountains, in the Prussian province of Nassau, in the Saxon Erzgebirge and in the Sauerland. The yield in 1905 amounted to about 153,000 tons, of which 20,000 tons were exported.

Copper is found principally in the Mansfeld district of the Prussian province of Saxony and near Arnsberg in the Sauerland, the ore yielding 31,713 tons in 1905, of which 5000 tons were exported.

About 90% of the zinc produced in Europe is yielded by Belgium and Germany. It is mostly found in upper Silesia, around Beuthen, and in the districts of Wiesbaden and Aix-la-Chapelle. In 1905 no less than 198,000 tons of block zinc were produced, of which 16,500 tons were exported.

Of other minerals (with the exceptions of coal, iron and salt treated below) nickel and antimony are found in the upper Harz; cobalt in the hilly districts of Hesse and the Saxon Erzgebirge; arsenic in the Riesengebirge; quicksilver in the Sauerland and in the spurs of the Saarbrücken coal hills; graphite in Bavaria; porcelain clay in Saxony and Silesia; amber along the whole Baltic coast; and lime and gypsum in almost all parts.

Coal-mining appears to have been first practised in the 14th century at Zwickau (Saxony) and on the Ruhr. There are six large coal-

Coal. fields, occupying an area of about 3600 sq. m., of which the most important occupies the basin of the Ruhr, its extent being estimated at 2800 sq. m. Here there are more than 60 beds, of a total thickness of 150 to 200 ft. of coal; and the amount in the pits has been estimated at 45,000 millions of tons. Smaller fields are found near Osnabrück, Ibbenbüren and Minden, and a larger one near Aix-la-Chapelle. The Saar coal-field, within the area enclosed by the rivers Saar, Nahe and Blies (460 sq. m.), is of great importance. The thickness of 80 beds amounts to 250 ft., and the total mass of coal is estimated at 45,400 million tons. The greater part of the basin belongs to Prussia, the rest to Lorraine. A still larger field exists in the upper Silesian basin, on the borderland between Austria and Poland, containing about 50,000 million tons. Beuthen is the chief centre. The Silesian coal-fields have a second centre in Waldenburg, east of the Riesengebirge. The Saxon coal-fields stretch eastwards for some miles from Zwickau. Deposits of less consequence are found in upper Bavaria, upper Franconia, Baden, the Harz and elsewhere.

The following table shows the rapidly increasing development of the coal production. That of lignite is added the provinces of Saxony and Brandenburg being rich in this product—

Production of Coal and Lignite.

Year.	Coal.			Lignite.		
	Quantities.	Value.	Hands	Quantities.	Value.	Hands.
	Mill. Tons.	Mill. Mk.		Mill. Tons.	Mill. Mk.	
1871	29.4	218.4		8.5	26.2	
1881	48.7	252.3	186,000	12.8	38.1	
1891	73.7	589.5	283,000	20.5	54.2	25,600
1899	101.6	789.6	379,000	34.2	78.4	44,700
1900	109.3	966.1	414,000	40.5	98.5	50,900
1905	121.2	1049.9	490,000	52.5	122.2	52,800

This production permits a considerable export of coal to the west and south of the empire, but the distance from the coal-fields to the German coast is such that the import of British coal cannot yet be dispensed with (1905, over 7,000,000 tons). Besides this, from 7,000,000 to 8,000,000 tons of lignite come annually from Bohemia. In north Germany peat is also of importance as a fuel; the area of the peat moors in Prussia is estimated at 8000 sq. m., of which 2000 are in the north of Hanover.

The iron-fields of Germany fall into three main groups: those of the lower Rhine and Westphalia, of which Dortmund and Düsseldorf are the centres; those of Lorraine and the Saar; and those of upper Silesia. The output of the ore has enormously increased of recent years, and the production of pig iron, as given for 1905, amounted to 10,875,000 tons of a value of £28,900,000.

Germany possesses abundant salt deposits. The actual production not only covers the home consumption, but also allows a yearly increasing exportation, especially to Russia, Austria and Scandinavia. The provinces of Saxony and Hanover, with Thuringia and Anhalt, produce half the whole amount. A large salt-work is found at Strzalkowo (Posen), and smaller ones near Dortmund, Lippstadt and Minden (Westphalia). In south Germany salt abounds most in Württemberg (Hall, Heilbronn, Rottweil); the principal Bavarian works are at the foot of the Alps near Freising and Rosenheim. Hesse and Baden, Lorraine and the upper Palatinate have also salt-works. The total yield of mined salt amounted in 1905 to 6,209,000 tons, including 1,165,000 tons of rock salt. The production has made great advance, having in 1850 been only 5 million cwt.

Manufactures.—In no other country of the world has the manufacturing industry made such rapid strides within recent years as in Germany. This extraordinary development of industrial energy embraces practically all classes of manufactured articles. In a general way the chief manufactures may be geographically distributed as follows. Prussia, Alsace-Lorraine, Bavaria and Saxony are the chief seats of the iron manufacture. Steel is produced in Rhenish Prussia. Saxony is predominant in the production of textiles, though Silesia and Westphalia manufacture linen. Cotton goods are largely produced in Baden, Bavaria, Alsace-Lorraine and Württemberg, woollens and worsteds in Saxony and the Rhine province, silk in Rhenish Prussia (Elberfeld), Alsace and Baden. Glass and porcelain are largely produced in Bavaria, lace in Saxony; tobacco in Bremen and Hamburg, chemicals in the Prussian province of Saxony, watches in Saxony (Glashütte) and Nuremberg, toys in Bavaria, gold and silver filigree in Berlin and Aschaffenburg; and beer in Bavaria and Prussia.

It is perhaps more in respect of its iron industry than of its other manufactures that Germany has attained a leading position in the markets of the world. Its chief centres are in Westphalia, the Rhine province (*Lower Rhenish*), in upper Silesia, and in Alsace-Lorraine and in Saxony. Of the total production of pig iron in 1905 amounting to over 10,000,000 tons, more than the half was produced in the Rhineland and Westphalia. Huge blast furnaces are in constant activity, and the output of rolled iron and steel is constantly increasing. In the latter the greatest advance has been made. The greater part of it is produced at or around Essen, where are the famous Krupp works, and Bochum; Many states have been for a considerable time supplied by Krupp with steel guns and battleship plates. The export of steel (railway) rails and bridges from this part is steadily on the increase.

Hardware also, the production of which is centred in Solingen, Heilbronn, Esslingen, &c., is largely exported. Germany stands second to Great Britain in the manufacture of machines and engines. There are in many large cities of north Germany extensive establishments for this purpose; but the industry is not limited to the large cities. In agricultural machinery Germany is a serious competitor with England. The locomotives and wagons for the German railways are almost exclusively built in Germany; and Russia, as well as Austria, receives large supplies of railway plant from German works. In shipbuilding, likewise, Germany is practically independent, yards having been established for the construction of the largest vessels.

Before 1871 the production of cotton fabrics in France exceeded that in Germany, but as the cotton manufacture is pursued largely in Alsace, the balance is now against the former country. In 1905 there were about 9,000,000 spindles in Germany. The export of the goods manufactured amounted in this year to an estimated value of £19,600,000. Cotton spinning and weaving are not confined to one district, but are prosecuted in upper Alsace (Mülhausen, Gebweiler, Colmar), in Saxony (Zwickau, Chemnitz, Annaberg), in Silesia (Breslau, Liegnitz), in the Rhine province (Düsseldorf, Münster, Cologne), in Erfurt and Hanover, in Württemberg (Reutlingen, Cannstatt), in Baden, Bavaria (Augsburg, Bamberg, Bayreuth) and in the Palatinate.

Although Germany produces wool, flax and hemp, the home production of these materials is not sufficient to meet the demand of manufactures, and large quantities of them have to be imported. In 1895 almost a million persons (half of them women) were employed in this branch of industry, and in 1897 the value of the cloth, buckskin and flannel manufacture was estimated at £18,000,000. The chief seats of this manufacture are the Rhenish districts of Aix-la-Chapelle, Düren, Eppen and Lennep, Brandenburg, Saxony, Silesia and lower Lusatia, the chief centres in this group being Berlin, Cottbus, Spremberg, Sagan and Sommerfeld.

The manufacture of woollen and half-woollen dress materials centres mainly in Saxony, Silesia, the Rhine province and in Alsace. Furniture covers, table covers and plush are made in Elberfeld and Chemnitz, in Westphalia and the Rhine province (notably in Elberfeld and Berlin); shawls in Berlin and the Bavarian Vogtland; carpets in Berlin, Barmen and Silesia. In the town of Schmiedeberg in the last district, as also in Cottbus (Lusatia), oriental patterns are successfully imitated. The chief seats of the stocking manufacture are Chemnitz and Zwickau in Saxony, and Apolda in Thuringia. The export of woollen goods from Germany in 1905 amounted to a value of £13,000,000.

Although linen was formerly one of her most important articles of manufacture, Germany is now left far behind in this industry by Great Britain, France and Austria-Hungary. This branch of textile manufacture has its principal centres in Silesia, Westphalia, Saxony and Württemberg, while Hirschberg in Silesia, Bielefeld in Westphalia and Zittau in Saxony are noted for the excellence of their productions. The goods manufactured, now no longer, as formerly, coarse in texture, vie with the finer and more delicate fabrics of Belfast. In the textile industry for flax and hemp there were, in 1905, 276,000 fine spindles, 22,300 hand-loom and 17,600 power-loom in operation, and, in 1905, linen and jute materials were exported of an estimated value of over £2,000,000. The jute manufacture, the principal centres of which are Berlin, Bonn, Brunswick and Hamburg, has of late attained considerable dimensions.

Raw silk can scarcely be reckoned among the products of the empire, and the annual demand has thus to be provided for by importation. The main centre of the silk industry is Crefeld and its neighbourhood; then come Elberfeld and Barmen, Aix-la-Chapelle, as well as Berlin, Bielefeld, Chemnitz, Stuttgart and the district around Mülhausen in Alsace.

The manufacture of paper is prosecuted almost everywhere in the empire. There were 1020 mills in operation in 1895, and the exports in 1905 amounted to more than £3,700,000 sterling, as against imports of a value of over £700,000.

Paper. The manufacture is carried on to the largest extent in the Rhine province, in Saxony and in Silesia. Wall papers are produced chiefly in Rhenish Prussia, Berlin and Hamburg; the finer sorts of letter-paper in Berlin, Leipzig and Nuremberg; and printing-paper (especially for books) in Leipzig, Berlin and Frankfort-on-Main.

The chief seat of the leather industry is Hesse-Darmstadt, in which Mainz and Worms produce excellent material. In Prussia large factories are in operation in the Rhine province, in **Leather.** Westphalia and Silesia (Brieg). Boot and shoe manufactures are carried on everywhere; but the best goods are produced by Mainz and Pirmasans. Gloves for export are extensively made in Württemberg, and Offenbach and Aschaffenburg are renowned for fancy leather wares, such as purses, satchels and the like.

Berlin and Mainz are celebrated for the manufacture of furniture; Bavaria for toys; the Black Forest for clocks; Nuremberg for pencils; Berlin and Frankfort-on-Main for various perfumes; and Cologne for the famous eau-de-Cologne.

The beetroot sugar manufacture is very considerable. It centres mainly in the Prussian province of Saxony, where Magdeburg is the chief market for the whole of Germany, in Anhalt, Brunswick and Silesia. The number of factories was, in 1905,

Sugar. 376, and the amount of raw sugar and molasses produced amounted to 2,643,531 metric tons, and of refined sugar 1,711,063 tons.

Beer is produced throughout the whole of Germany. The production is relatively greatest in Bavaria. The **Brausteuergeliet** (beer excise district) embraces all the states forming the

Beer. Zollverein, with the exception of Bavaria, Württemberg, Baden and Alsace-Lorraine, in which countries the excise duties are separately collected. The total number of breweries in the beer excise district was, in 1905-1906, 5995, which produced 1017 million gallons; in Bavaria nearly 6000 breweries with 392 million gallons; in Baden over 700 breweries with 68 million gallons; in Württemberg over 5000 breweries with 87 million gallons; and in Alsace-Lorraine 95 breweries with about 29 million gallons. The amount brewed per head of the population amounted, in 1905, roughly to 160 imperial pints in the excise district; to 450 in Bavaria; 280 in Württemberg; 260 in Baden; and 122 in Alsace-Lorraine. It may be remarked that the beer brewed in Bavaria is generally of darker colour than that produced in other states, and extra strong brews are exported largely into the beer excise district and abroad.

Commerce.—The rapid development of German trade dates from the *Zollverein* (customs union), under the special rules and regulations of which it is administered. The *Zollverein*

emanates from a convention originally entered into, in 1828, between Prussia and Hesse, which, subsequently joined by the Bavarian customs-league, by the kingdom of Saxony and the Thuringian states, came into operation, as regards the countries concerned, on the 1st of January 1834. With progressive territorial extensions during the ensuing fifty years, and embracing the grand-duchy of Luxemburg, it had in 1871, when the German empire was founded, an area of about 209,281 sq. m., with a population of 40,678,000. The last important addition was in October 1888, when Hamburg and Bremen were incorporated. Included within it, besides the grand-duchy of Luxemburg, are the Austrian communes of Jungholz and Mittelberg; while, outside, lie the little free-port territories of Hamburg, Cuxhaven, Bremerhaven and Geestemünde, Helgoland, and small portions of the districts of Constance and Waldshut, lying on the Baden Swiss frontier. Down to 1879 Germany was, in general, a free-trade country. In this year, however, a rigid protective system was introduced by the *Zolltarifgesetz*, since modified by the commercial treaties between Germany and Austria-Hungary, Italy, Switzerland and Belgium, of the 1st of February 1892, and by a customs tariff law of the 25th of December 1902. The foreign commercial relations of Germany were again altered by the general and conventional customs tariff, which came into force on the 1st of March 1906. The *Zolltarifgesetz* of the 15th of July 1879, while restricting the former free import, imposed considerable duties. Exempt from duty were now only refuse, raw products, scientific instruments, ships and literary and artistic objects; forty-four articles—notably beer, vinegar, sugar, herrings, cocoa, salt, fish oils, ether, alum and soda—were unaffected by the change, while duties were henceforth levied upon a large number of articles which had previously been admitted duty free, such as pig iron, machines and locomotives, grain, building timber, tallow, horses, cattle and sheep; and, again, the tariff law further increased the duties leviable upon numerous other articles. Export duties were abolished in 1865 and transit dues in 1861. The law under which Great Britain enjoyed the "most favoured nation treatment" expired on the 31st of December 1905, but its provisions were continued by the *Bundesrat* until further notice. The average value of each article is fixed annually in Germany under the direction of the Imperial Statistical Office, by a commission of experts, who receive information from chambers of commerce and other sources. There are separate valuations for imports and exports. The price fixed is that of the goods at the moment of crossing the frontier. For imports the price does not include customs duties, cost of transport, insurance, warehousing, &c., incurred after the frontier is passed. For exports, the price includes all charges within the territory, but drawbacks and bounties are not taken into account. The quantities are determined according to obligatory declarations, and, for imports, the fiscal authorities may actually weigh the goods. For packages an official tax is deducted. The countries whence goods are imported and the ultimate destination of exports are registered. The import dues amounted in the year 1906, the first year of the revised tariff, to about £31,639,000, or about 10s. 5d. per head of population.

Statistics relating to the foreign trade of the Empire are necessarily confined to comparatively recent times. The quantities of such imported articles as are liable to duty have, indeed, been known for many years; and in 1872 official tables were compiled showing the value both of imports and of exports. But when the results of these tables proved the importation to be very much greater than the exportation, the conviction arose that the valuation of the exports was erroneous and below the reality. In 1872 the value of the imports was placed at £173,400,000 and that of the exports at £124,700,000. In 1905 the figures were—imports, £371,000,000, and exports, £292,000,000, including precious metals.

Table A following shows the classification of goods adopted before the tariff revision of 1906. From 1907 a new classification has been adopted, and the change thus introduced is so great that it is impossible to make any comparisons between the statistics of years subsequent to and preceding the year 1906. Table B shows imports and exports for 1907 and 1908 according to the new classification adopted.

TABLE A.—Classes of Imports and Exports, 1905.

Groups of Articles.	Imports.		Exports.	
	1907.	1908. ¹	1907.	1908. ¹
Refuse	£6,866,250		£1,170,200	
Cotton and cottons	23,488,750		22,949,600	
Lead and by-products	996,300		979,400	
Brush and sieve makers' goods	102,400		515,450	
Drugs, chemists' and oilmen's colours	15,896,900		23,196,250	
Iron and iron goods	3,156,500		33,126,400	
Ores, precious metals, asbestos, &c.	28,834,050		9,899,450	
Flax and other vegetable spinning materials except cotton	6,794,100		1,235,700	
Grain and agricultural produce	59,130,200		7,496,500	
Glass	538,050		2,743,900	
Hair, leathers, bristles	3,218,600		1,848,150	
Skins	18,965,500		9,548,450	
Wood and wooden wares	16,940,850		6,050,150	
Hops	913,150		2,135,600	
Instruments, machines, &c.	4,351,500		17,898,250	
Calendars	34,300		74,700	
Caoutchouc, &c.	7,379,600		4,616,400	
Clothes, body linen, millinery	739,900		7,321,050	
Copper and copper goods	8,273,400		10,307,050	
Hardware, &c.	2,042,400		12,610,550	
Leather and leather goods	3,597,950		9,665,300	
Linens	1,750,100		1,904,950	
Candles	11,150		42,350	
Literary and works of art	3,066,050		9,025,500	
Groceries and confectionery	41,446,400		17,585,000	
Fats and oils	12,510,600		2,631,600	
Paper goods	1,086,800		720,200	
Furs	265,700		132,300	
Petroleum	5,030,600		8,889,000	
Silks and silk goods	9,533,300		768,200	
Soap and perfumes	151,600		400	
Playing cards	400		18,950	
Stone goods	2,822,000		2,110,550	
Coal, lignite, coke and peat	10,136,800		15,096,450	
Straw and hemp goods	561,650		262,100	
Tar, pitch, resin	2,504,400		834,100	
Animals, and animal products	9,926,200		590,700	
Earthenware goods	391,650		5,076,350	
Cattle	11,366,200		725,100	
Oilcloth	43,150		177,300	
Wools and woollen textiles	25,290,200		21,562,900	
Zinc and zinc goods	682,250		2,413,600	
Tin and japanned goods	1,770,550		744,100	
Goods insufficiently declared			806,300	
Total	£352,317,250		£284,626,900	

TABLE B.—Classes of Imports and Exports, 1907 and 1908.

Groups of Articles.	Imports.		Exports.	
	Value in £1000.		Value in £1000.	
	1907.	1908. ¹	1907.	1908. ¹
Agricultural and forest produce ²	215,532	205,512	45,796	50,324
Agricultural produce ³	93,253	102,954	10,369	15,168
Colonial produce and substitutes for the same	12,151	12,328	84	108
Southern fruit and fruit peel	3,214	3,262	20	23
Forest produce	28,166	26,299	4,066	3,967
Resins	8,216	8,209	2,500	2,325
Animals and animal products ²	63,283	61,794	9,607	9,676
Hides and skins	16,920	17,099	5,383	5,453
Meat, oil, sugar, beverages	21,523	20,404	20,284	20,048
Mineral and fossil raw materials, mineral oils	47,575	45,540	26,166	26,208
Earths and stones	6,541	7,542	3,250	3,006
Ores, slag, cinders	16,465	15,451	1,407	1,206
Mineral fuel	16,895	14,910	19,445	20,020
Mineral oils and other fossil raw materials	7,168	7,209	558	491
Coal-tar, coal-tar oils	506	428	1,506	1,485

¹ Provisional figures only.

² Excluding vegetable and animal textile materials.

³ Excluding vegetable textile materials.

Groups of Articles.	Imports.		Exports.	
	Value in £1000.		Value in £1000.	
	1907.	1908. ¹	1907.	1908. ¹
Chemical and pharmaceutical products, colours	14,784	14,850	28,116	26,845
Chemical primary materials, acids, salts	9,226	9,550	9,661	9,832
Colours and dyeing materials	951	870	11,630	10,518
Varnish, lacquer	189	158	206	221
Ether, alcohol not included elsewhere, essential oils, perfumery and cosmetics	1,979	1,918	1,118	1,004
Artificial manures	992	1,001	1,303	1,236
Explosives of all kinds	86	74	1,612	1,269
Other chemical and pharmaceutical products	1,361	1,270	2,586	2,765
Animal and vegetable textile materials and wares thereof	98,540	92,105	78,086	70,343
Silk and silk goods	13,533	13,704	13,324	11,364
Wool	33,260	31,195	27,114	24,918
Unworked wool	19,975	19,309	2,647	2,561
Worked wool	4,625	4,961	3,799	3,393
Wares of spun wool	8,660	6,925	20,668	18,964
Cotton	38,543	34,450	29,004	26,201
Unworked cotton	27,795	26,167	3,264	2,987
Worked cotton	980	950	912	891
Cotton wares	9,858	7,338	24,828	22,324
Other vegetable textile materials	10,783	10,411	3,777	3,471
Unworked	7,923	7,819	1,125	1,211
Worked	166	168	122	137
Wares thereof	2,685	2,423	2,531	2,124
Leather and leather wares, furriers' wares	6,695	6,657	16,778	17,835
Leather	2,658	2,804	7,593	8,328
Leather wares	1,332	1,176	4,016	3,867
Furriers' wares	2,698	2,672	5,237	5,616
Caoutchouc wares	694	754	2,328	2,325
Wares of soft caoutchouc	670	735	1,694	1,723
Hardened caoutchouc and wares thereof	24	19	634	602
Wares of animal or vegetable material for carving or moulding	2,448	2,068	4,260	4,131
Wooden wares	859	769	1,707	1,666
Paper, cardboard and wares thereof	1,349	1,295	9,342	9,111
Books, pictures, paintings	1,992	2,036	4,667	4,765
Earthenware	467	377	5,224	4,612
Glass and glassware	747	728	5,671	5,149
Precious metals and wares thereof	13,281	21,243	18,629	6,858
Gold	11,616	19,295	15,898	6,151
Gold	11,184	18,873	11,071	2,897
Gold wares	432	422	4,827	3,254
Silver	1,665	1,948	2,731	2,707
Silver	1,434	1,716	1,206	1,418
Silver wares	231	232	1,525	1,289
Base metals and wares thereof	26,035	26,398	57,146	58,895
Pig iron (including non-malleable alloys)	5,993	4,472	38,899	40,162
Iron wares	1,601	912	966	905
Aluminium and aluminium wares	4,302	3,560	37,933	39,257
Raw aluminium	546	453	368	273
Aluminium wares	529	433	152	77
Lead and lead wares	17	20	216	196
Raw lead (including waste)	1,438	1,484	945	985
Lead wares	1,427	1,470	525	568
Zinc and zinc wares	11	14	420	417
Raw zinc (including waste)	727	847	2,433	2,489
Zinc wares	706	825	1,631	1,784
Tin and tin wares	21	22	802	705
Raw tin (including waste)	2,405	2,629	1,380	1,236
Tin wares	2,357	2,581	787	688
Nickel and nickel wares	48	48	593	548
Raw nickel	400	540	246	298
	375	527	160	233

¹ Provisional figures only.

Groups of Articles.	Imports.		Exports.		Groups of Articles.	Imports.		Exports.	
	Value in £1000.		Value in £1000.			Value in £1000.		Value in £1000.	
	1907.	1908. ¹	1907.	1908. ¹		1907.	1908. ¹	1907.	1908. ¹
Nickel wares	25	13	86	65	Electro-technical products	411	451	8,227	9,107
Copper and copper wares	13,803	15,088	7,998	8,470	Vehicles and vessels . . .	2,562	1,587	5,849	4,862
Raw copper (including copper coin, brass, tombac, &c.)	12,995	14,192	2,204	2,014	Firearms, clocks, musical instruments, toys	1,732	1,424	8,704	7,595
Copper wares	868	896	5,794	6,456	Clocks and watches	1,382	1,134	1,296	1,210
Instruments of precision	813	885	4,877	4,982	Musical instruments	223	170	3,176	2,780
Machinery, vehicles	7,093	5,489	33,117	34,653	Toys	39	35	3,949	3,273
Machinery	4,090	3,451	19,041	20,684	Total	442,663	429,636	349,114	336,347

¹ Provisional figures only.

The following table shows the commercial intercourse in imports and exports, exclusive of bullion and coin, between Germany and the chief countries of the world in 1905, 1906 and 1907.

Imports.

Country.	1905.		1906.		1907.	
	Value in £1000.	Percentage of Germany's Total Imports.	Value in £1000.	Percentage of Germany's Total Imports.	Value in £1000.	Percentage of Germany's Total Imports.
Belgium	13,439	3.8	14,315	3.6	14,586	3.4
Denmark	5,986	1.7	6,302	1.6	6,050	1.4
France	19,772	5.6	21,306	5.4	22,302	5.2
United Kingdom	35,320	10.1	40,531	10.3	48,014	11.2
Italy	10,350	3	11,851	3	14,030	3.3
Netherlands	12,077	3	11,864	3	11,187	2.6
Austria-Hungary	36,974	10.6	39,814	10.1	39,939	9.3
Rumania	4,568	1.3	5,774	1.5	7,365	1.7
Russia	47,816	13.6	52,528	13.4	54,447	12.7
Sweden	5,887	1.7	7,359	1.9	8,457	2
Switzerland	8,980	2.6	10,659	2.9	10,366	2.4
Spain	5,742	1.6	7,410	1.9	6,878	1.6
British South Africa	1,769	0.5	1,766	0.4	2,258	0.5
Dominion of Canada	481	0.1	463	0.1	483	0.1
New Zealand	75	..	87	..	94	..
British West Africa	2,562	0.7	2,731	0.7	3,601	0.8
British India	13,657	3.9	15,842	4	20,016	4.7
Dutch Indies	5,848	1.7	7,002	1.8	9,199	2.1
Argentine Republic	18,150	5.2	18,302	4.7	21,756	5.1
Brazil	8,454	2.4	9,246	2.4	9,636	2.2
Chile	6,536	1.9	7,131	1.8	7,074	1.6
United States	48,770	13.9	60,787	15.4	64,864	15.1
Commonwealth of Australia	7,690	2.2	8,619	2.2	11,209	2.6

Exports.

Country.	1905.		1906.		1907.	
	Value in £1000.	Percentage of Germany's Total Exports.	Value in £1000.	Percentage of Germany's Total Exports.	Value in £1000.	Percentage of Germany's Total Exports.
Belgium	15,364	5.6	17,509	5.6	16,861	5
Denmark	8,668	3.1	9,699	3.1	10,182	3
France	14,420	5.1	18,815	6	22,080	6.6
United Kingdom	51,253	18.2	52,473	16.8	52,135	15.5
Italy	8,045	2.9	11,354	3.6	14,893	4.4
Netherlands	21,395	7.6	21,799	7	22,232	6.6
Norway	3,447	1.2	3,573	1.2	4,211	1.3
Austria-Hungary	28,526	10.1	31,926	10.2	35,231	10.5
Rumania	2,144	0.8	3,140	1	3,372	1
Russia	17,027	6	19,962	6.4	21,531	6.4
Sweden	7,653	2.7	8,675	2.8	9,177	2.7
Switzerland	17,649	6.3	18,367	5.9	21,948	6.5
Spain	2,609	0.9	2,838	0.9	3,228	1
British South Africa	1,687	0.6	1,607	0.5	1,422	0.4
Dominion of Canada	1,071	0.4	1,203	0.4	1,455	0.4
New Zealand	227	0.1	244	0.1	263	0.1
Turkey	3,484	1.3	3,357	1.1	4,011	1.2
British India	4,226	1.5	5,011	1.6	4,868	1.4
China	3,727	1.3	3,331	1.1	3,105	0.9
Japan	4,158	1.5	4,328	1.4	5,036	1.5
Argentine Republic	6,463	2.3	8,367	2.7	8,810	2.6
Brazil	3,525	1.3	4,364	1.4	5,118	1.5
Chile	2,632	0.9	3,561	1.2	4,167	1.2
United States	26,660	9.5	31,281	10	32,070	9.5
Commonwealth of Australia	2,264	0.8	2,863	0.9	3,004	0.9

The commerce of Germany shows an upward tendency, which progresses *pari passu* with its greatly increased production. The export of ships from the United Kingdom to the empire decreased during two years, 1903 (£305,682) and 1904 (£365,062), almost to a vanishing point, German yards being able to cope with the demands made upon them for the supply of vessels of all classes, including mercantile vessels and ships of war. In 1905 and subsequent years, however, the degree of employment in German yards increased to such an extent, principally owing to the placing of the Admiralty contracts with private builders, that the more urgent orders for mercantile vessels were placed abroad.

The following tables give the value of trade between the United Kingdom and Germany in 1900 and 1905—

Staple Imports into the United Kingdom from Germany.	1900.	1905.
Sugar	£ 9,164,573	£ 10,488,085
Glass and manufactures	1,078,648	1,108,117
Eggs	1,017,119	764,966
Cottons and yarn	992,244	1,476,385
Woolens and yarn	1,312,671	1,984,475
Iron and steel and manufactures	1,012,376	379,479
Machinery	411,178	735,536
Paper	523,544	528,946
Musical instruments	660,777	676,391
Toys	644,690	714,628
Zinc and manufactures	461,023	673,602
Wood and manufactures	1,470,839	1,109,584
Chemicals	513,200	735,830

Principal Articles exported by Great Britain to Germany.	1900.	1905.
Cottons and yarn	£ 3,843,917	£ 4,941,917
Woolens and yarn	3,743,842	3,795,591
Alpaca, &c., yarn	1,022,259	1,325,519
Wool	742,632	1,691,035
Ironwork	2,937,055	1,500,414
Herrings	1,651,441	2,042,483
Machinery	2,040,797	2,102,835
Coals, cinders	4,267,172	3,406,535
New ships	1,592,865	1,377,081

Navigation.—The seamen of Frisia are among the best in the world, and the shipping of Bremen and Hamburg had won a respected name long before a German mercantile marine, properly so called, was heard of. Many Hamburg vessels sailed under charter of English and other houses in foreign, especially Chinese, waters. Since 1868 all German ships have carried a common flag—black, white, red; but formerly Oldenburg, Hanover, Bremen, Hamburg, Lübeck, Mecklenburg and Prussia had each its own flag, and Schleswig-Holstein vessels sailed under the Danish flag. The German mercantile fleet occupies, in respect of the number of vessels, the fourth place—after Great Britain, the United States of America and Norway; but in respect of tonnage it stands third—after Great Britain and the United States only.

The following table shows its distribution on the 1st of January of the two years 1905 and 1908:—

	Baltic Ports.		North Sea Ports.		Total Shipping.	
	Number.	Tonnage.	Number.	Tonnage.	Number.	Tonnage.
1905—						
Sailing vessels	386	19,067	2181	559,436	2567	578,503
Steamers	486	236,509	1171	1,537,563	1657	1,774,072
Totals	872	255,576	3352	2,096,999	4224	2,352,575
1908—						
Sailing vessels	394	17,472	2255	516,180	2649	533,652
Steamers	521	274,952	1401	1,981,831	1922	2,256,783
Totals	915	292,424	3656	2,498,011	4571	2,790,435

In 1905, 2136 vessels of 283,171 tons, and in 1908, 2218 vessels of 284,081 tons, belonged to Prussian ports, and the number of sailors of the mercantile marine was 60,616 in 1905 and 71,853 in 1908.

The chief ports are Hamburg, Stettin, Bremen, Kiel, Lübeck, Flensburg, Bremerhaven, Danzig (Neufahrwasser), Geestemünde and Emden; and the number and tonnage of vessels of foreign nationality entering and clearing the ports of the empire, as compared with national shipping, were in 1906:—

Foreign Ships.	Number entered in Cargo.	Tonnage.	Number cleared in Cargo.	Tonnage.
Danish	5917	1,589,346	5059	1,219,388
British	5327	5,129,017	3211	2,552,268
Swedish	4891	1,164,431	3317	747,656
Dutch	2181	456,401	1973	316,562
Norwegian	1565	817,483	720	347,311
Russian	720	250,664	439	143,983

The ports of Hamburg and Bremen, which are the chief outlets for emigration to the United States of America, carry on a vast commercial trade with all the chief countries of the world, and are the main gates of maritime intercourse between the United Kingdom and Germany.

The inland navigation is served by nearly 25,000 river, canal and coasting vessels, of a tonnage of about 4,000,000.

Railways.—The period of railway construction was inaugurated in Germany by the opening of the line (4 m. in length) from Nuremberg to Fürth in 1835, followed by the main line (71 m.) between Leipzig and Dresden, opened throughout in 1839. The development of the railway system was slow and was not conceived on any uniform plan. The want of a central government operated injuriously, for it often happened that intricate negotiations and solemn treaties between several sovereign states were required before a line could be constructed; and, moreover, the course it was to take was often determined less by the general exigencies of commerce than by many trifling interests or desires of neighbouring states. The state which was most self-seeking in its railway politics was Hanover, which separated the eastern and western parts of the kingdom of Prussia. The difficulties arising to Prussia from this source were experienced in a still greater degree by the seaports of Bremen and Hamburg, which were severely hampered by the particularism displayed by Hanover.

The making of railways was from the outset regarded by some German states as exclusively a function of the government. The South German states, for example, have only possessed state railways. In Prussia numerous private companies, in the first instance, constructed their systems, and the state contented itself for the most part with laying lines in such districts only as were not likely to attract private capital.

The development of the German railway system falls conveniently into four periods. The first, down in 1840, embraces the beginnings of railway enterprise. The next, down to 1848, shows the linking-up of various existing lines and the establishment of inter-connexion between the chief towns. The third, down to 1881, shows the gradual establishment of state control in Prussia, and the formation of direct trunk lines. The fourth begins from 1881 with the purchase of practically all the railways in Prussia by the government, and the introduction of a uniform system of interworking between the various state systems. The purchase of the railways by the Prussian government was on the whole equably carried out, but there were several hard cases in the expropriation of some of the smaller private lines.

The majority of the German railways are now owned by the state governments. Out of 34,470 m. of railway completed and open for traffic in 1906, only 2579 m. were the property of private undertakings, and of these about 150 were worked by the state. The bulk of the railways are of the normal 4 ft. 8½ in. gauge. Narrow-gauge (2½ ft.) lines—or light railways—extended over 1218 m. in 1903, and of these

537 m. were worked by the state. The board responsible for the imperial control over the whole railway system in Germany is the *Reichseisenbahnverwaltung*.

in Berlin, the administration of the various state systems residing, in Prussia, in the ministry of public works; in Bavaria in the ministry of the royal house and of the exterior; in Württemberg in the ministry of the exterior; in Saxony in the ministry of the interior; in Baden and Hesse-Darmstadt in commissions of the ministry of finance; and in Alsace-Lorraine in the imperial ministry of railways.

The management of the Prussian railway system is committed to the charge of twenty "directions," into which the whole network of lines is divided, being those of Altona, Berlin, Breslau, Bromberg, Danzig, Elberfeld, Erfurt, Essen a.d. Ruhr, Frankfurt-on-Main, Halle a.d. Saale, Hanover, Cassel, Kattowitz, Cologne, Königsberg, Magdeburg, Münster, Posen, Saarbrücken and Stettin. The entire length of the system was in 1906 20,835 m., giving an average of about 950 m. to each "direction." The smallest mileage controlled by a "direction" is Berlin, with 380 m., and the greatest, Königsberg, with 1200 m.

The Bavarian system embraces 4642 m., and is controlled and managed, apart from the "general direction" in Munich, by ten traffic boards, in Augsburg, Bamberg, Ingolstadt, Kempten, Munich, Nuremberg, Regensburg, Rosenheim, Weiden and Würzburg.

The system of the kingdom of Saxony has a length of 1616 m., and is controlled by the general direction in Dresden.

The length of the Württemberg system is 1141 m., and is managed by a general direction in Stuttgart.

Baden (state) controls 1233, Oldenburg (state) 382, Mecklenburg-Schwerin 726 and Saxe-Weimar 257 m. respectively. Railways lying within the other smaller states are mostly worked by Prussia.

Alsace-Lorraine has a separate system of 1085 m., which is worked by the imperial general direction in Strassburg.

By the linking-up of the various state systems several grand trunk line routes have been developed—notably the lines Berlin-Vienna-Budapest; Berlin-Cologne-Brussels and Paris; Berlin-Halle-Frankfurt-on-Main-Basel; Hamburg-Cassel-Munich and Verona; and Breslau-Dresden-Bamberg-Geneva. Until 1907 no uniform system of passenger rates had been adopted, each state retaining its own fares—a condition that led to much confusion. From the 1st of May 1907 the following tariff came into force. For ordinary trains the rate for first class was fixed at 1½d. a mile; for second class at 7d.; for third class at ½d., and for fourth class at ¼d. a mile. For express trains an extra charge is made of 2s. for distances exceeding 93 m. (150 kils.) in the two superior classes, and 1s. for a lesser distance, and of 1s. and 6d. respectively in the case of third class tickets. Fourth class passengers are not conveyed by express trains. The above rates include government duty; but the privilege of free luggage (as up to 56 lb) has been withdrawn, and all luggage other than hand baggage taken into the carriages is charged for. In 1903 371,084,000 metric tons of goods, including animals, were conveyed by the German railways, yielding £68,085,000 sterling, and the number of passengers carried was 957,684,000, yielding £29,500,000.

The passenger ports of Germany affording oversea communications to distant lands are mainly those of Bremen (Bremerhaven) and Hamburg (Cuxhaven) both of which are situate on the North Sea. From them great steamship lines, notably the North German Lloyd, the Hamburg-American, the Hamburg South American and the German East African steamship companies, maintain express mail and other services with North and South America, Australia, the Cape of Good Hope and the Far East. London and other English ports, French, Italian and Levant coast towns are also served by passenger steamboat sailings from the two great North Sea ports. The Baltic ports, such as Lübeck, Stettin, Danzig (Neufahrwasser) and Königsberg, principally provide communication with the coast towns of the adjacent countries, Russia and Sweden.

Waterways.—In Germany the waterways are almost solely in the possession of the state. Of ship canals the chief is the Kaiser Wilhelm canal (1887-1895), 61 m. long, connecting the North Sea and the Baltic; it was made with a breadth at bottom of 72 ft. and at the surface of 213 ft., and with a depth of 29 ft. 6 in., but in 1908 work was begun for doubling the bottom width and increasing the depth to 36 ft. In respect of internal navigation, the principal of the greater undertakings are the Dortmund-Ems and the Elbe-Trave canals. The former, constructed in 1892-1899, has a length of 150 m. and a mean depth of 8 ft. The latter, constructed 1895-1900, has a length of 43 m. and a mean depth of about 7½ ft. A project was sanctioned in 1905 for a canal, adapted for vessels up to 600 tons, from the Rhine to the Weser at Hanover, utilizing a portion of the Dortmund-Ems canal; for a channel accommodating vessels of similar size between Berlin and Stettin; for improving the waterway between the Oder and the Vistula, so as to render it capable

of accommodating vessels of 400 tons; and for the canalization of the upper Oder.

On the whole, Germany cannot be said to be rich in canals. In South Germany the Ludwigs canal was, until the annexation of Alsace-Lorraine, the only one of importance. It was constructed by King Louis I. of Bavaria in order to unite the German Ocean and the Black Sea, and extends from the Main at Bamberg to Kelheim on the Danube. Alsace-Lorraine had canals for connecting the Rhine with the Rhone and the Marne, a branch serving the collieries of the Saar valley. The North German plain has, in the east, a canal by which Russian grain is conveyed to Königsberg, joining the Pregel to the Memel, and the upper Silesian coalfield is in communication with the Oder by means of the Kłodnitz canal. The greatest number of canals is found around Berlin; they serve to join the Spree to the Oder and Elbe, and include the Teltow canal opened in 1906. The canals in Germany (including ship canals through lakes) have a total length of about 2600 m. Navigable and canalized rivers, to which belong the great water-systems of the Rhine, Elbe and Oder, have a total length of about 6000 m.

Roads.—The construction of good highways has been well attended to in Germany only since the Napoleonic wars. The separation of the empire into small states was favourable to road-making, inasmuch as it was principally the smaller governments that expended large sums for their network of roads. Hanover and Thuringia have long been distinguished for the excellence of their roads, but some districts suffer even still from the want of good highways. The introduction of railways for a time diverted attention from road-making, but this neglect has of late been to some extent remedied. In Prussia the districts (*Kreise*) have undertaken the charge of the construction of the roads; but they receive a subsidy from the public funds of the several provinces. Turnpikes were abolished in Prussia in 1874 and in Saxony in 1885. The total length of the public roads is estimated at 80,000 m.

Posts and Telegraphs.—With the exception of Bavaria and Württemberg, which have administrations of their own, all the German states belong to the imperial postal district (*Reichspostgebiet*). Since 1874 the postal and telegraphic departments have been combined. Both branches of administration have undergone a surprising development, especially since the reduction of the postal rates. Germany, including Bavaria and Württemberg, constitutes with Austria-Hungary a special postal union (Deutsch-Österreichischer Postverband), besides forming part of the international postal union. There are no statistics of posts and telegraphs before 1867, for it was only when the North German union was formed that the lesser states resigned their right of carrying mails in favour of the central authority. Formerly the prince of Thurn-and-Taxis was postmaster-general of Germany, but only some of the central states belonged to his postal territory. The seat of management was Frankfurt-on-Main.

The following table shows the growth in the number of post offices for the whole empire:—

Year.	Post Offices.	Men employed.
1872	7,518	..
1880	9,450	..
1890	24,952	128,687
1899	36,388	206,945
1904	38,688	261,985
1907	40,083	319,026

In 1872 there were 2359 telegraph offices: in 1880, 9980; in 1890, 17,200; and in 1907, 37,309. There were 188 places provided with telephone service in 1888, and 13,175 in 1899. The postal receipts amounted for the whole empire in 1907 to £13,789,450, and the expenditure to £31,096,944, thus showing a surplus of £2,692,516.

Constitution.—The constitution of the German empire is, in all essentials, that of the North German Confederation, which came into force on the 7th of June 1867. Under this the presidency (*Præsidium*) of the confederation was vested in the king of Prussia and his heirs. As a result of the Franco-German war of 1870 the South German states joined the confederation; on the 9th of December 1870 the diet of the confederation accepted the treaties and gave to the new confederation the name of German Empire (*Deutsches Reich*), and on the 18th of January 1871 the king of Prussia was proclaimed German

emperor (*Deutscher Kaiser*) at Versailles. This was a change of style, not of functions and powers. The title is "German emperor," not "emperor of Germany," being intended to show that the Kaiser is but *primus inter pares* in a confederation of territorial sovereigns; his authority as territorial sovereign (*Landesherr*) extends over Prussia, not over Germany.

The imperial dignity is hereditary in the line of Hohenzollern, and follows the law of primogeniture. The emperor exercises the imperial power in the name of the confederated states. In his office he is assisted by a federal council (*Bundesrat*), which represents the governments of the individual states of Germany. The members of this council, 58 in number, are appointed for each session by the governments of the individual states. The legislative functions of the empire are vested in the emperor, the Bundesrat, and the Reichstag or imperial Diet. The members of the latter, 397 in number, are elected for a space of five years by universal suffrage. Vote is by ballot, and one member is elected by (approximately) every 150,000 inhabitants.

As regards its legislative functions, the empire has supreme and independent control in matters relating to military affairs and the navy, to the imperial finances, to German commerce, to posts and telegraphs, and also to railways, in so far as these affect the common defence of the country. Bavaria and Württemberg, however, have preserved their own postal and telegraphic administration. The legislative power of the empire also takes precedence of that of the separate states in the regulation of matters affecting freedom of migration (*Freizügigkeit*), domicile, settlement and the rights of German subjects generally, as well as in all that relates to banking, patents, protection of intellectual property, navigation of rivers and canals, civil and criminal legislation, judicial procedure, sanitary police, and control of the press and of associations.

The executive power is in the emperor's hands. He represents the empire internationally, and can declare war if defensive, and make peace as well as enter into treaties with other nations; he also appoints and receives ambassadors. For declaring offensive war the consent of the federal council must be obtained. The separate states have the privilege of sending ambassadors to the other courts; but all consuls abroad are officials of the empire and are named by the emperor.

Both the Bundesrat and the Reichstag meet in annual sessions convoked by the emperor who has the right of proroguing and dissolving the Diet; but the prorogation must not exceed 60 days, and in case of dissolution new elections must be ordered within 60 days, and the new session opened within 90 days. All laws for the regulation of the empire must, in order to pass, receive the votes of an absolute majority of the federal council and the Reichstag.

Alsace-Lorraine is represented in the Bundesrat by four commissioners (*Kommissäre*), without votes, who are nominated by the Statthalter (imperial lieutenant).

The fifty-eight members of the Bundesrat are nominated by the governments of the individual states for each session; while the members of the Reichstag are elected by universal suffrage and ballot for the term of five years. Every German who has completed his twenty-fifth year is *prima facie* entitled to the suffrage in the state within which he has resided for one year. Soldiers and those in the navy are not thus entitled, so long as they are serving under the colours. Excluded, further, are persons under tutelage, bankrupts and paupers, as also such persons who have been deprived of civil rights, during the time of such deprivation. Every German citizen who has completed his twenty-fifth year and has resided for a year in one of the federal states is eligible for election in any part of the empire, provided he has not been, as in the cases above, excluded from the right of suffrage. The secrecy of the ballot is ensured by special regulations passed on the 28th of April 1903. The voting-paper, furnished with an official stamp, must be placed in an envelope by the elector in a compartment set apart for the purpose in the polling room, and, thus enclosed, be handed by him to the presiding officer. An absolute majority of votes decides the election. If (as in the case of several candidates) an absolute majority over all the others has not been declared, a test election (*Stichwahl*) takes place between the two candidates who have received the greatest number of votes. In case of an equal number of votes being cast for both candidates, the decision is by lot.

The subjoined table gives the names of the various states composing the empire and the number of votes which the separate states

have in the federal council. Each state may appoint as many members to the federal council as it has votes. The table also gives the number of the deputies in the Reichstag.

States of the Empire.	No. of Members in Bundesrat.	No. of Members in Reichstag.
Kingdom of Prussia	17	236
.. Bavaria	6	48
.. Saxony	4	23
.. Württemberg	4	17
Grand duchy of Baden	3	14
.. Hesse	3	9
.. Mecklenburg-Schwerin	2	6
.. Saxe-Weimar	1	3
.. Mecklenburg-Strelitz	1	1
.. Oldenburg	1	3
Duchy of Brunswick	2	3
.. Saxe-Meiningen	1	2
.. Saxe-Altenburg	1	1
.. Saxe-Coburg-Gotha	1	2
.. Anhalt	1	2
Principality of Schwarzburg-Sondershausen	1	1
.. Schwarzburg-Rudolstadt	1	1
.. Waldeck	1	1
.. Reuss-Greiz	1	1
.. Reuss-Schleiz	1	1
.. Schaumburg-Lippe	1	1
.. Lippe	1	1
Free town of Lübeck	1	1
.. Bremen	1	1
.. Hamburg	1	3
Imperial territory of Alsace-Lorraine	15
Total	58	397

The Reichstag must meet at least once in each year. Since November 1906 its members have been paid (see PAYMENT OF MEMBERS).

The following table shows its composition after the elections of 1903 and 1907:—

Parties.	1903.	1907.
Centre	100	108
Social Democrats	81	43
Conservatives	51	60
National Liberals	49	57
Freisinnige Volkspartei	27	33
Reichspartei	19	22
Alsations, Guelphs and Danes	15	5
Poles	16	20
Wirtschaftliche Vereinigung (Reform Partei)	12	21
Freisinnige Vereinigung	9	16
Wilde (no party)	9	5
Bund der Landwirte	3	6
Bauernbund	3	1

All the German states have separate representative assemblies, except Alsace-Lorraine and the two grand-duchies of Mecklenburg. The six larger states have adopted the two-chamber system, but in the composition of the houses great differences are found. The lesser states also have chambers of representatives numbering from 12 members (in Reuss-Greiz) to 48 members (in Brunswick); and in most states the different classes, as well as the cities and the rural districts, are separately represented. The free towns have legislative assemblies, numbering from 120 to 200 members.

Imperial measures, after passing the Bundesrat and the Reichstag, must obtain the sanction of the emperor in order to become law, and must be countersigned, when promulgated, by the chancellor of the empire (*Reichskanzler*). All members of the federal council are entitled to be present at the deliberations of the Reichstag. The Bundesrat, acting under the direction of the chancellor of the empire, is also a supreme administrative and consultative board, and as such it has nine standing committees, viz.: for army and fortresses; for naval purposes; for tariffs, excise and taxes; for trade and commerce; for railways, posts and telegraphs; for civil and criminal law; for financial accounts; for foreign affairs; and for Alsace-Lorraine. Each committee includes representatives of at least four states of the empire.

For the several branches of administration a considerable number of imperial offices have been gradually created. All of them, however, either are under the immediate authority of the chancellor of the empire, or are separately managed under his responsibility. The most important are the chancery office, the foreign office and the general post and telegraph office. But the heads of these do not form a cabinet.

The Chancellor of the Empire (Reichskanzler).

—The Prussian plenipotentiary to the Bundesrat is the president of that assembly; he is appointed by the emperor, and bears the title Reichskanzler. This head official can be represented by any other member of the Bundesrat named in a document of substitution. The Reichskanzler is the sole responsible official, and conducts all the affairs of the empire, with the exception of such as are of a purely military character, and is the intermediary between the emperor, the Bundesrat and the Reichstag. All imperial decrees require the counter-signature of the chancellor before attaining validity. All measures passed by the Reichstag require the sanction of the majority of the Bundesrat, and only become binding on being proclaimed on behalf of the empire by the chancellor, which publication takes place through the *Reichsgesetzblatt* (the official organ of the chancellor).

Government Offices.—The following imperial offices are directly responsible to the chancellor and stand under his control:—

1. The foreign office, which is divided into three departments: (i.) the political and diplomatic; (ii.) the political and commercial; (iii.) the legal. The chief of the foreign office is a secretary of state, taking his instructions immediately from the chancellor.

2. The colonial office (under the direction of a secretary of state) is divided into (i.) a civil department; (ii.) a military department; (iii.) a disciplinary court.

3. The ministry of the interior or home office (under the conduct of a secretary of state). This office is divided into four departments, dealing with (i.) the business of the Bundesrat, the Reichstag, the elections, citizenship, passports, the press, and military and naval matters, so far as the last concern the civil authorities; (ii.) purely social matters, such as old age pensions, accident insurance, migration, settlement, poor law administration, &c.; (iii.) sanitary matters, patents, canals, steamship lines, weights and measures; and (iv.) commercial and economic relations—such as agriculture, industry, commercial treaties and statistics.

4. The imperial admiralty (*Reichsmarineamt*), which is the chief board for the administration of the imperial navy, its maintenance and development.

5. The imperial ministry of justice (*Reichsjustizamt*), presided over by a secretary of state. This office, not to be confused with the *Reichsgericht* (supreme legal tribunal of the empire) in Leipzig, deals principally with the drafting of legal measures to be submitted to the Reichstag.

6. The imperial treasury (*Reichsschatzamt*), or exchequer, is the head financial office of the empire. Presided over by a secretary of state, its functions are principally those appertaining to the control of the national debt and its administration, together with such as in the United Kingdom are delegated to the board of inland revenue.

7. The imperial railway board (*Reichseisenbahnamt*), the chief official of which has the title of "president," deals exclusively with the management of the railways throughout the empire, in so far as they fall under the control of the imperial authorities in respect of laws passed for their harmonious interworking, their tariffs and the safety of passengers conveyed.

8. The imperial post office (*Reichspostamt*), under a secretary of state, controls the post and telegraph administration of the empire (with the exception of Bavaria and Württemberg), as also those in the colonies and dependencies.

9. The imperial office for the administration of the imperial railways in Alsace-Lorraine, the chief of which is the Prussian minister of public works.

10. The office of the accountant-general of the empire (*Rechnungshof*), which controls and supervises the expenditure of the sums voted by the legislative bodies, and revises the accounts of the imperial bank (*Reichsbank*).

11. The administration of the imperial invalid fund, *i.e.* of the fund set apart in 1871 for the benefit of soldiers invalidated in the war of 1870-71.

12. The imperial bank (*Reichsbank*), supervised by a committee of four under the presidency of the imperial chancellor, who is a fifth and permanent member of such committee.

The heads of the various departments of state do not form, as in England, the nucleus of a cabinet. In so far as they are secretaries of state, they are directly responsible to the chancellor, who repre-

sents all the offices in his person, and, as has been said, is the medium of communication between the emperor and the Bundesrat and Reichstag.

Colonies.—The following table gives some particulars of the dependencies of the empire:—

Name.	Date of Acquisition.	Area (estimated) sq. m.	Pop. (estimated).
In Africa—			
Togoland	1884	33,700	1,000,000
Cameroon	1884	190,000	3,500,000
S.W. Africa	1884	322,450	200,000
East Africa	1885	364,000	7,000,000
Total in Africa		910,150	11,700,000
In the Pacific—			
German New Guinea	1884	70,000	110,000
Bismarck Archipelago	1884	20,000	185,000
Caroline, Pelew and Mariana Islands	1889	800	41,600
Solomon Islands	1886	4,200	45,000
Marshall Islands	1885	160	15,000
Samoa Islands	1899	985	33,700
Total in Pacific		96,145	432,600
In Asia—			
Kiao-chow	1897	117	60,000
Total dependencies	1884-1899	1,006,412	12,192,600

Except Kiao-chow, which is controlled by the admiralty, the dependencies of the empire are under the direction of the colonial office. This office, created in 1907, replaced the colonial department of the foreign office which previously had had charge of colonial affairs. The value of the trade of the colonies with Germany in 1906 was: imports into Germany, £1,028,000; exports from Germany, £2,236,000. For 1907 the total revenue from the colonies was £849,000; the expenditure of the empire on the colonies in the same year being £4,362,000. (See the articles on the various colonies.)

Local Government.—In the details of its organization local self-government differs considerably in the various states of the German empire. The general principle on which it is based, however, is that which has received its most complete expression in the Prussian system: government by experts, checked by lay criticism and the power of the purse, and effective control by the central authorities. In Prussia at least the medieval system of local self-government had succumbed completely to the centralizing policy of the monarchy, and when it was revived it was at the will and for the purposes of the central authorities, as subsidiary to the bureaucratic system. This fact determined its general characteristics. In England the powers of the local authorities are defined by act of parliament, and within the limits of these powers they have a free hand. In Germany general powers are granted by law, subject to the approval of the central authorities, with the result that it is the government departments that determine what the local elected authorities may do, and that the latter regard themselves as commissioned to carry out, not so much the will of the locality by which they are elected, as that of the central government. This attitude is, indeed, inevitable from the double relation in which they stand. A *Bürgermeister*, once elected, becomes a member of the bureaucracy and is responsible to the central administration; even the headman of a village commune is, within the narrow limits of his functions, a government official. Moreover, under the careful classification of affairs into local and central, many things which in England are regarded as local (*e.g.* education, sanitary administration, police) are regarded as falling under the sphere of the central government, which either administers them directly or by means of territorial delegations consisting either of individuals or of groups of individuals. These may be purely official (*e.g.* the Prussian *Regierung*), a mixture of officials and of elected non-official members approved by the government (*e.g.* the *Bezirksausschuss*), or may consist wholly of authorities elected for another purpose, but made to act as the agents of the central departments (*e.g.* the *Kreisrausschuss*). That this system works without friction is due to the German habit of discipline; that it is, on the whole, singularly effective is a result of the

peculiarly enlightened and progressive views of the German bureaucracy.¹

The unit of the German system of local government is the commune (*Gemeinde*, or more strictly *Ortsgemeinde*). These are divided into rural communes (*Landgemeinden*) and urban communes (*Stadtgemeinden*), the powers and functions of which, though differing widely, are based upon the same general principle of representative local self-government. The higher organs of local government, so far as these are representative, are based on the principle of a group or union of communes (*Gemeindeverband*). Thus, in Prussia, the representative assembly of the Circle (*Kreistag*) is composed of delegates of the rural communes, as well as of the large landowners and the towns, while the members of the provincial diet (*Provinziallandtag*) are chosen by the *Kreistage* and by such towns as form separate *Kreise*.

In Prussia the classes of administrative areas are as follows: (1) the province, (2) the government district (*Regierungsbezirk*), (3) the rural circle (*Landkreis*) and urban circle (*Stadtkreis*), (4) the official district (*Amtsbezirk*), (5) the town commune (*Stadtgemeinde*) and rural commune (*Landgemeinde*). Of these areas the provinces, circles and communes are for the purposes both of the central administration and of local self-government, and the bodies by which they are governed are corporations. The *Regierungsbezirke* and *Amtsbezirke*, on the other hand, are for the purposes of the central administration only and are not incorporated. The Prussian system is explained in greater detail in the article PRUSSIA (*q.v.*). Here it must suffice to indicate briefly the general features of local government in the other German states, as compared with that in Prussia. The province, which usually covers the area of a formerly independent state (e.g. Hanover) is peculiar to Prussia. The *Regierungsbezirk*, however, is common to the larger states under various names, *Regierungsbezirk* in Bavaria, *Kreisshauptmannschaft* in Saxony, *Kreis* in Württemberg. Common to all is the president (*Regierungspräsident*, *Kreisshauptmann* in Saxony), an official who, with a committee of advisers, is responsible for the oversight of the administration of the circles and communes within his jurisdiction. Whereas in Prussia, however, the *Regierung* is purely official, with no representative element, the *Regierungsbezirk* in Bavaria has a representative body, the *Landrat*, consisting of delegates of the district assemblies, the towns, large landowners, clergy and—in certain cases—the universities; the president is assisted by a committee (*Landratsausschuss*) of six members elected by the *Landrat*. In Saxony the *Kreisshauptmann* is assisted by a committee (*Kreisausschuss*).

Below the *Regierungsbezirk* is the *Kreis*, or Circle, in Prussia, Baden and Hesse, which corresponds to the *Distrikt* in Bavaria, the *Oberamt* in Württemberg² and the *Amtshauptmannschaft* in Saxony. The representative assembly of the Circle (*Kreistag*, *Distriktsrat* in Bavaria, *Amtsversammlung* in Württemberg, *Bezirksversammlung* in Saxony) is elected by the communes, and is presided over by an official, either elected or, as in the case of the Prussian *Landrat*, nominated from a list submitted by the assembly. So far as their administrative and legislative functions are concerned the German *Kreistage* have been compared to the English county councils or the Hungarian *comitatus*. Their decisions, however, are subject to the approval of their official chiefs. To assist the executive a small committee (*Kreisausschuss*, *Distriktsausschuss*, &c.) is elected subject to official approval. The official district (*Amtsbezirk*), a subdivision of the circle for certain administrative purposes (notably police), is peculiar to Prussia.

Rural Communes.—As stated above, the lowest administrative area is the commune, whether urban or rural. The laws as to the constitution and powers of the rural communes vary much in the different states. In general the commune is a body corporate, its assembly consisting either (in small villages) of the whole body of the qualified inhabitants (*Gemeindeversammlung*), or of a representative

assembly (*Gemeindevertretung*) elected by them (in communes where there are more than forty qualified inhabitants). At its head is an elected headman (*Schulze*, *Dorfvorsteher*, &c.), with a small body of assistants (*Schöffen*, &c.). He is a government official responsible, *inter alia*, for the policing of the commune. Where there are large estates these sometimes constitute communes of themselves. For common purposes several communes may combine, such combinations being termed in Württemberg *Bürgermeistereien*, in the Rhine province *Amtsverbände*. In general the communes are of slight importance. Where the land is held by small peasant proprietors, they display a certain activity; where there are large ground landlords, these usually control them absolutely.

Towns.—The constitution of the towns (*Städteverfassung*) varies more greatly in the several states than that of the rural communes. According to the so-called *Stein'sche Städteverfassung* (the system introduced in Prussia by Stein in 1808), which, to differentiate between it and other systems, is called the *Magistratsverfassung* (or magisterial constitution), the municipal communes enjoy a greater degree of self-government than do the rural. In the magisterial constitution of larger towns and cities, the members of the *Magistrat*, i.e. the executive council (also called *Stadttrat*, *Gemeinderat*), are elected by the representative assembly of the citizens (*Stadtvorversammlung*) out of their own body.

In those parts of Germany which come under the influence of French legislation, the constitution of the towns and that of the rural communes (the so-called *Bürgermeisterverfassung*) is identical, in that the members of the communal executive body are, in the same way as those of the communal assembly, elected to office immediately by the whole body of municipal electors.

The government of the towns is regulated in the main by municipal codes (*Städteordnungen*), largely based upon Stein's reform of 1808. This, superseding the autonomy severally enjoyed by the towns and cities since the middle ages (see COMMUNE), aimed at welding the citizens, who had hitherto been divided into classes and guilds, into one corporate whole, and giving them all an active share in the administration of public affairs, while reserving to the central authorities the power of effective control.

The system which obtains in all the old Prussian provinces (with the exception of Rügen and Vorpommern or Hither Pomerania) and in Westphalia is that of Stein, modified by subsequent laws—notably those of 1853 and 1856—which gave the state a greater influence, while extending the powers of the *Magistrat*. In Vorpommern and Rügen, and thus in the towns of Gröfswald, Stralsund and Bergen, among others, the old civic constitutions remain unchanged. In the new Prussian provinces, Frankfurt-on-Main received a special municipal constitution in 1867 and the towns of Schleswig-Holstein in 1869. The province of Hanover retains its system as amended in 1853, and Hesse-Nassau, with the exception of Frankfurt-on-Main, received a special corporate system in 1897. The municipal systems of Bavaria, Württemberg and Saxony are more or less based on that of Stein, but with a wider sphere of self-government. In Mecklenburg there is no uniform system. In Saxe-Coburg, the towns of Coburg and Neustadt have separate and peculiar municipal constitutions. In almost all the other states the system is uniform. The free cities of Lübeck, Hamburg and Bremen, as sovereign states, form a separate class. Their constitutions are described in the articles on them.

Where the "magisterial" constitution prevails, the members of the *Magistrat*, i.e. the executive council (also called variously *Stadttrat*, *Gemeindevorstand*, &c.), are as a rule elected by the representative assembly of the burghesses (*Stadtvorversammlung*; also *Gemeinderat*, *städtischer Ausschuss*, *Kollegium der Bürgervorsteher*, *Stadthalten*, &c.). The *Magistrat* consists of the chief burghomaster (*Erster Bürgermeister* or *Stadtschultheiss*), and in the large cities of a number of paid and unpaid town councillors (*Rathsherren*, *Senatoren*, *Schöffen*, *Ratsmänner*, *Magistratsräde*), together with certain salaried members selected for specific purposes (e.g. *Bauat*, for building). Over this executive body the *Stadtvorordneten*, who are elected by the whole body of citizens and unpaid, exercise a general control, their assent being necessary to any measures of importance, especially those involving any considerable outlay. They are elected for from three to six years; the members of the *Magistrat* are chosen for six, nine or twelve years, sometimes even for life. In the large towns the burghomasters must be jurists, and are paid. The police are under the control of the *Magistrat*, except in certain large cities, where they are under a separate state department.

The second system mentioned above (*Bürgermeisterverfassung*) prevails in the Rhine province, the Bavarian Palatinate, Hesse, Saxe-Weimar, Anhalt, Waldeck and the principalities of Reuss and Schwarzburg. In Württemberg, Baden and Hesse-Nassau the system is a compromise between the two; both the town and rural communes have a mayor (*Bürgermeister* or *Schultheiss*, as the case may be) and a *Gemeinderat* for administrative purposes, the citizens exercising control through a representative *Gemeindeausschuss* (communal committee).

Justice.—By the Judicature Act—*Gerichtsverfassungsgesetz*—of 1879, the so-called "regular litigious" jurisdiction of the

¹ See the comparative study in Percy Ashley's *Local and Central Government* (London, 1906).

² The *Kreis* in Württemberg corresponds to the *Regierungsbezirk* elsewhere.

courts of law was rendered uniform throughout the empire, and the courts are now everywhere alike in character and composition; and with the exception of the *Reichsgericht* (supreme court of the empire), immediately subject to the government of the state in which they exercise jurisdiction, and not to the imperial government. The courts, from the lowest to the highest, are *Amtsgericht*, *Landgericht*, *Oberlandesgericht* and *Reichsgericht*. There are, further, *Verwaltungsgerichte* (administrative courts) for the adjustment of disputes between the various organs of local government, and other special courts, such as military; consular and arbitration courts (*Schiedsgericht*). In addition to litigious business the courts also deal with non-litigious matters, such as the registration of titles to land, guardianship and the drawing up and custody of testamentary dispositions, all which are almost entirely within the province of the *Amtsgerichte*. There are uniform codes of criminal law (*Strafgesetzbuch*), commercial law and civil law (*Bürgerliches Gesetzbuch*), the last of which came into force on the 1st of January 1900. The criminal code, based on that of Prussia anterior to 1870, was gradually adopted by all the other states and was generally in force by 1872. It has, however, been frequently amended and supplemented.

The lowest courts of first instance are the *Amtsgerichte*, each presided over by a single judge, and with jurisdiction in petty criminal and civil cases, up to 300 marks (£15). They are also competent to deal with all disputes as to wages, and letting and hiring, without regard to the value of the object in dispute. Petty criminal cases are heard by the judge (*Amtsrichter*) sitting with two *Schöffen*—assessors—selected by lot from the jury lists, who are competent to try prisoners for offences punishable with a fine, not exceeding 600 marks (£30) or corresponding confinement, or with imprisonment not exceeding three months. The *Landgerichte* revise the decisions of the *Amtsgerichte*, and have also an original jurisdiction in criminal and civil cases and in divorce proceedings. The criminal chamber of the *Landgericht* is composed of five judges, and a majority of four is required for a conviction. These courts are competent to try cases of felony punishable with a term of imprisonment not exceeding five years. The preliminary examination is conducted by a judge, who does not sit on the bench at the trial. Jury courts (*Schwurgerichte*) are not permanent institutions, but are periodically held. They are formed of three judges of the *Landgericht* and a jury of twelve; and a two-thirds majority is necessary to convict. There are 173 *Landgerichte* in the empire, being one court for every 325,822 inhabitants. The first court of second instance is the *Oberlandesgericht*, which has an original jurisdiction in grave offences and is composed of seven judges. There are twenty-eight such courts in the empire. Bavaria alone has an *Oberstes Landesgericht*, which exercises a revising jurisdiction over the *Oberlandesgerichte* in the state. The supreme court of the German empire is the *Reichsgericht*, having its seat at Leipzig. The judges, numbering ninety-two, are appointed by the emperor on the advice of the federal council (*Bundesrat*). This court exercises an appellate jurisdiction in civil cases remitted, for the decision of questions of law, by the inferior courts and also in all criminal cases referred to it. It sits in four criminal and six civil senates, each consisting of seven judges, one of whom is the president. The judges are styled *Reichsgerichtsräte* (counsellors of the imperial court).

In the *Amtsgericht* a private litigant may conduct his own case; but where the object of the litigation exceeds 300 marks (£15), and in appeals from the *Amtsgericht* to the *Landgericht*, the plaintiff (and also the defendant) must be represented by an advocate—*Rechtsanwalt*.

A *Rechtsanwalt*, having studied law at a university for four years and having passed two state examinations, if desiring to practise must be admitted as "defending counsel" by the *Amtsgericht* or *Landgericht*, or by both. These advocates are not state officials, but are sworn to the due execution of their duties. In case a client has suffered damage owing to the negligence of the advocate, the latter can be made responsible. In every district of the *Oberlandesgericht*, the *Rechtsanwälte* are formed into an *Anwaltskammer* (chamber of advocates), and the council of each chamber, sitting as a court of honour, deals with and determines matters affecting the honour of the profession. An appeal lies from this to a second court of honour, consisting of the president, three judges of the *Reichsgericht* and of three lawyers admitted to practice before that court.

Criminal prosecutions are conducted in the name of the crown by the *Staatsanwälte* (state attorneys), who form a separate branch of the judicial system, and initiate public prosecutions or reject evidence as being insufficient to procure conviction. The proceedings in the

courts are, as a rule, public. Only in exceptional circumstances are cases heard *in camera*.

Military offences come before the military court and serious offences before the *Kriegsgericht*. The court-martial is, in every case, composed of the commander of the district as president, and four officers, assisted by a judge-advocate (*Kriegsgerichtsrat*), who conducts the case and swears the judges and witnesses. In the most serious class of cases, three officers and two judge-advocates are the judges. The prisoner is defended by an officer, whom he may himself appoint, and can be acquitted by a simple majority, but only be condemned by a two-thirds majority. There are also *Kaufmanns-* and *Gewerbegerichte* (commercial and industrial courts), composed of persons belonging to the classes of employers and employees, under the presidency of a judge of the court. Their aim is the effecting of a reconciliation between the parties. From the decision of these courts an appeal lies to the *Landgericht* where the amount of the object in dispute exceeds 100 marks (£5).

The following table shows the number of criminal cases tried before the courts of first instance, with the number and sex of convicted persons, and the number of the latter per 10,000 of the civil population over twelve years of age:—

Year.	Cases tried.		Persons convicted.		Total.	Convictions per 10,000 inhabitants.
	<i>Amtsgericht.</i>	<i>Landgericht.</i>	Males.	Females.		
1900	1,143,687	94,241	396,075	72,844	469,819	119.5
1901	1,205,558	101,471	419,502	77,718	497,310	125.6
1902	1,221,080	104,434	431,257	81,072	512,329	127.3
1903	1,251,662	108,241	424,813	80,540	505,353	123.4
1904	1,287,686	105,457	435,191	81,785	516,976	124.2

Of those convicted in 1904, 225,326 had been previously convicted.

Poor Law.—A law passed by the North German Confederation of the 6th of June 1870, and subsequently amended by an imperial law of the 12th of March 1894, laid down rules for the relief of the destitute in all the states composing the empire, with the exception of Bavaria and Alsace-Lorraine. According to the system adopted, the public relief of the poor is committed to the care of local unions (*Ortsarmenverbände*) and provincial unions (*Landarmenverbände*), the former corresponding, generally, to the commune, and the latter to a far wider area, a circle or a province. Any person of eighteen years, who has continuously resided with a local union for the space of two years, there acquires his domicile. But any destitute German subject must be relieved by the local union in which he happens to be at the time, the cost of the relief being defrayed by the local or provincial union in which he has his domicile. The wife and children have also their domicile in the place where the husband or father has his.¹

Relief of the poor is one of the chief duties of the organs of local self-government. The moneys for the purpose are mainly derived from general taxation (poor rates *per se* being, but rarely directly levied), special funds and voluntary contributions. In some German states and communes certain dues (such as the dog tax in Saxony), death duties and particularly dues payable in respect of public entertainments and police court fines, are assigned to the poor-relief chest. In some large towns the Elberfeld system of unpaid district visitors and the interworking of public and private charity is in force. The imperial laws which introduced the compulsory insurance of all the humbler workers within the empire, and gave them, when incapacitated by sickness, accident and old age, an absolute right to pecuniary assistance, have greatly reduced pauperism and crime.

Workmen's Insurance.—On June 15, 1883, the Reichstag, as the result of the policy announced by the emperor William I. in his speech from the throne in 1881, passed an act making insurance against sickness, accident, and incapacity compulsory on all workers in industrial pursuits. By further laws, in 1885 and 1892, this obligation was extended to certain other classes of workers, and the system was further modified by acts passed in 1900 and 1903. Under this system every person insured has a right to assistance in case of sickness, accident, or incapacity, while in case of death his widow and children receive an annuity.

1. Insurance against sickness is provided for under these laws partly by the machinery already existing, i.e. the sick benefit societies.

¹ The system of compulsory registration, which involves a notification to the police of any change of address (even temporary), of course makes it easy to determine the domicile in any given case.

partly by new machinery devised to meet the new obligation imposed. The sick-funds (*Krankenkassen*) are thus of seven kinds: (1) free assistance funds (*Freie Hilfskassen*), either registered under the law of 1876, as modified in 1884 (*Eingeschriebene Hilfskassen*), or established under the law of the separate states (*Landesrechtliche Hilfskassen*); (2) *Betriebs- or Fabrikkrankenstellen*, funds established by individual factory-owners; (3) *Baukrankenstelle*, a fund established for workmen engaged on the construction (*Bau*) of particular engineering works (canal-digging, &c.), by individual contractors; (4) gild sick funds (*Innungskrankenkassen*), established by the guilds for the workmen and apprentices of their members; (5) miners' sick fund (*Knappschaftskasse*); (6) local sick fund (*Ortskrankenstelle*), established by the commune for particular crafts or classes of workmen; (7) *Gemeindekrankenversicherung*, i.e. insurance of members of the commune as such, in the event of their not subscribing to any of the other funds. Of these, 2, 3, 6 and 7 were created under the above-mentioned laws.

The number of such funds amounted in 1903 to 23,271, and included 10,224,297 workmen. The *Ortskrankenstellen*, with 4,975,322 members, had the greatest, and the *Baukrankenstellen*, with 16,459, the smallest number of members. The *Ortskrankenstellen*, which endeavour to include workmen of a like trade, have to a great extent, especially in Saxony, fallen under the control of the Social Democrats. The appointment of permanent doctors (*Kassenärzte*) at a fixed salary has given rise to much difference between the medical profession and this local sick fund; and the insistence on "freedom of choice" in doctors, which has been made by the members and threatens to militate against the interest of the profession, has been met on the part of the medical body by the appointment of a commission to investigate cases of undue influence in the selection.

According to the statistics furnished in the *Vierteljahreshfte zur Statistik des deutschen Reiches* for 1905, the receipts amounted to upwards of £10,000,000 for 1903, and the expenditure to somewhat less than this sum. Administrative changes were credited with nearly £600,000, and the invested funds totalled £9,000,000. The workmen contribute at the rate of two-thirds and the employers at the rate of one-third; the sum payable in respect of each workman varying from 13.2% of the earnings in the "communal sick fund" to at most 14.4% in the others.

2. Insurance against old age and invalidity comprehends all persons who have entered upon their 17th year, and who belong to one of the following classes of wage-earners: artisans, apprentices, domestic servants, dressmakers, charwomen, laundresses, seamstresses, housekeepers, foremen, engineers, journeymen, clerks and apprentices in shops (excepting assistants and apprentices in chemists' shops), schoolmasters, schoolmistresses, teachers and governesses, provided the earnings do not exceed £100 per annum. The insured are arranged in five classes, according to the amount of their yearly earnings: viz. £17, 10s.; £27, 10s.; £47, 10s.; £57, 10s.; and £100. The contributions, affixed to a "pension book" in stamps, are payable each week, and amount, in English money, to 1-45d., 2-34d., 2-82d., 3-30d. and 4-23d. Of the contribution one half is paid by the employer and the other by the employee, whose duty it is to see that the amount has been properly entered in the pension book. The pensions, in case of invalidity, amount (including a state subsidy of £2, 10s. for each) respectively to £8, 8s.; £11, 5s.; £13, 10s.; £15, 15s.; and £18. The old-age pensions (beginning at 70 years) amount to £5, 10s.; £7; £8, 10s.; £10; and £11, 10s. The old-age and invalid insurance is carried out by thirty-one large territorial offices, to which must be added nine special unions. The income of the forty establishments was, in 1903, £8,500,000 (including £1,700,000 imperial subsidy). The capital collected was upwards of £50,000,000.

It may be added that employes in mercantile and trading houses, who have not exceeded the age of 40 years and whose income is below £150, are allowed voluntarily to share in the benefits of this insurance.

3. *Accident Insurance (Unfallversicherung)*.—The insurance of workmen and the lesser officials against the risks of accident is effected not through the state or the commune, but through associations formed *ad hoc*. These associations are composed of members following the same or allied occupations (e.g. foresters, seamen, smiths, &c.), and hence are called "professional associations" (*Berufsgenossenschaften*). They are empowered, subject to the limits set by the law, to regulate their own business by means of a general meeting and of elected committees. The greater number of these associations cover a very wide field, generally the whole empire; in such cases they are empowered to divide their spheres into sections, and to establish agents in different centres to inquire into cases of accident, and to see to the carrying out of the rules prescribed by the association for the avoidance of accidents. Those associations, of which the area of operations extends beyond any single state, are subordinate to the control of the imperial insurance bureau (*Reichsversicherungsamt*) at Berlin; those that are confined to a single state (as generally in the case of foresters and husbandmen) are under the control of the state insurance bureau (*Landesversicherungsamt*).

So far as their earnings do not exceed £150 per annum, the following classes are under the legal obligation to insure: labourers in mines,

quarries, dockyards, wharves, manufactories and breweries; bricklayers and navvies; post-office, railway, and naval and military servants and officials; carters, raftsmen and canal hands; cellarmen, warehousemen; stevedores; and agricultural labourers. Each of these groups forms an association, which within a certain district embraces all the industries with which it is connected. The funds for covering the compensation payable in respect of accidents are raised by payments based, in agriculture, on the taxable capital, and in other trades and industries on the earnings of the insured. Compensation in respect of injury or death is not paid if the accident was brought about through the culpable negligence or other delict of the insured. In case of injury, involving incapacity for more than thirteen weeks (for the earlier period the *Krankenkassen* provide), the weekly sum payable during complete or permanent incapacity is fixed at the ratio of two-thirds of the earnings during the year preceding the accident, and in case of partial disablement, at such a proportion of the earnings as corresponds to the loss through disablement. In certain circumstances (e.g. need for paid nursing) the sum may be increased to the full rate of the previous earnings. In case of death, as a consequence of injury, the following payments are made: (1) a sum of at least £2, 10s. to defray the expenses of interment; (2) a monthly allowance of one-fifth of the annual earnings as above to the widow and each child up to the age of 15.

Life Insurance.—There were forty-six companies in 1900 for the insurance of life. The number of persons insured was 1,446,249 at the end of that year, the insurances amounting to roughly £320,000,000. Besides these are sixty-one companies—of which forty-six are comprised in the above life insurance companies—paying subsidies in case of death or of military service, endowments, &c. Some of these companies are industrial. The transactions of all these companies included in 1900 over 4,179,000 persons, and the amount of insurances effected was £80,000,000.

Religion.—So far as the empire as a whole is concerned there is no state religion, each state being left free to maintain its own establishment. Thus while the emperor, as king of Prussia, is *summus episcopus* of the Prussian Evangelical Church, as emperor he enjoys no such ecclesiastical headship. In the several states the relations of church and state differ fundamentally according as these states are Protestant or Catholic. In the latter these relations are regulated either by concordats between the governments and the Holy See, or by bulls of circumscription issued by the pope after negotiation. The effects of concordats and bulls alike are tempered by the exercise by the civil power of certain traditional reserved rights, e.g. the *placetum regium*, *recursus ab abusu*, *nominatione regia*, and that of vetoing the nomination of *personae minus gratiae*. In the Protestant states the ecclesiastical authority remains purely territorial, and the sovereign remains effective head of the established church. During the 19th century, however, a large measure of ecclesiastical self-government (by means of general synods, &c.) was introduced, *pari passu* with the growth of constitutional government in the state; and in effect, though the theoretical supremacy of the sovereign survives in the church as in the state, he cannot exercise it save through the general synod, which is the state parliament for ecclesiastical purposes. Where a sovereign rules over a state containing a large proportion of both Catholics and Protestants, which is usually the case, both systems coexist. Thus in Prussia the relations of the Roman Catholic community to the Protestant state are regulated by arrangement between the Prussian government and Rome; while in Bavaria the king, though a Catholic, is legally *summus episcopus* of the Evangelical Church.

According to the religious census of 1900 there were in the German empire 35,231,104 Evangelical Protestants, 20,327,913 Roman Catholics, 6472 Greek Orthodox, 203,678 Christians belonging to other confessions, 586,948 Jews, 11,597 members of other sects and 9938 unclassified. The Christians belonging to other confessions include Moravian Brethren, Mennonites, Baptists, Methodists and Quakers, German Catholics, Old Catholics, &c. The table on following page shows the distribution of the population according to religious beliefs as furnished by the census of 1900.

Almost two-thirds of the population belong to the Evangelical Church, and rather more than a third to the Church of Rome; the actual figures (based on the census of 1900) being (%) Evangelical Protestants, 62.5; Roman Catholics, 36.1; Dissenters and others, .043, and Jews, 1.0. The Protestants have not increased proportionately in number since 1890, while the Roman Catholics show a small relative increase. Three states in Germany have a decidedly predominant Roman Catholic population, viz. Alsace-Lorraine, Bavaria and Baden; and in four states the Protestant element prevails, but with from 24 to 34% of Roman Catholics; viz. Prussia, Württemberg, Hesse and Oldenburg. In Saxony and

States.	Evangelicals.	Catholics.	Other Christians.	Jews.
Prussia	21,817,577	12,113,670	139,127	392,322
Bavaria	1,749,206	4,363,178	7,607	54,928
Saxony	3,973,063	198,265	19,103	12,416
Württemberg	1,497,299	650,392	9,426	11,916
Baden	794,058	1,131,639	5,561	26,132
Hesse	746,201	341,570	7,368	24,486
Mecklenburg-Schwerin	597,268	8,182	487	1,763
Saxe-Weimar	347,144	14,158	361	1,188
Mecklenburg-Strelitz	100,568	1,612	62	331
Oldenburg	309,510	86,920	1,334	1,359
Brunswick	436,076	24,175	1,271	1,824
Saxe-Meiningen	244,810	4,170	395	1,351
Saxe-Altenburg	189,885	4,723	206	99
Saxe-Coburg-Gotha	225,074	3,330	515	608
Anhalt	301,953	11,699	794	1,605
Schwarzburg-Sondershausen	79,593	1,110	27	166
Schwarzburg-Rudolstadt	92,298	676	37	48
Waldeck	55,285	1,831	164	637
Reuss-Greiz	66,860	1,043	444	48
Reuss-Schleiz	135,958	2,579	466	178
Schaumburg-Lippe	41,908	785	177	257
Lippe	132,708	5,157	205	879
Lübeck	93,671	2,199	213	670
Bremen	208,815	13,506	876	1,409
Hamburg	712,338	39,093	3,149	17,949
Alsace-Lorraine	372,078	1,310,450	4,304	32,379
Total	35,231,104	20,327,913	203,678	586,948

the eighteen minor states the number of Roman Catholics is only from 0.3 to 3.3 % of the population.

From the above table little can be inferred as to the geographical distribution of the two chief confessions. On this point it must be borne in mind that the population of the larger towns, on account of the greater mobility of the population since the introduction of railways and the abolition of restrictions upon free settlement, has become more mixed—Berlin, Leipzig, Hamburg, &c., showing proportionally more Roman Catholics, and Cologne, Frankfurt-on-Main, Munich more Protestants than formerly. Otherwise the geographical limits of the confessions have been but little altered since the Thirty Years' War. In the mixed territories those places which formerly belonged to Roman Catholic princes are Roman Catholic still, and *vice versa*. Hence a religious map of South Germany looks like an historical map of the 17th century. The number of localities where the two confessions exist side by side is small. Generally speaking, South Germany is predominantly Roman Catholic. Some districts along the Danube (province of Bavaria, Upper Palatinate, Swabia), southern Württemberg and Baden, and in Alsace-Lorraine are entirely so. These territories are bordered by a broad stretch of country on the north, where Protestantism has maintained its hold since the time of the Reformation, including Bayreuth or eastern upper Franconia, middle Franconia, the northern half of Württemberg and Baden, with Hesse and the Palatinate. Here the average proportion of Protestants to Roman Catholics is two to one. The basin of the Main is again Roman Catholic from Bamberg to Aschaffenburg (western upper Franconia and lower Franconia). In Prussia the western and south-eastern provinces are mostly Roman Catholic, especially the Rhine province, together with the government districts of Münster and Arnsberg. The territories of the former principality of Cleves and of the countship of Mark (comprising very nearly the basin of the Ruhr), which went to Brandenburg in 1609, must, however, be excepted. North of Münster, Roman Catholicism is still prevalent in the territory of the former bishopric of Osnabrück. In the east, East Prussia (Ermeland excepted) is purely Protestant. Roman Catholicism was predominant a hundred years ago in all the frontier provinces acquired by Prussia in the days of Frederick the Great, but since then the German immigrants have widely propagated the Protestant faith in these districts. A prevalently Roman Catholic population is still found in the district of Oppeln and the countship of Glatz, in the province of Posen, in the Polish-speaking *Kreise* of West Prussia, and in Ermeland (East Prussia). In all the remaining territory the Roman Catholic creed is professed only in the Eichsfeld on the southern border of the province of Hanover and around Hildesheim.

The adherents of Protestantism are divided by their confessions into Reformed and Lutheran. To unite these "church union" has been introduced in several Protestant states, as for example in Prussia and Nassau in 1817, in the Palatinate in 1818 and in Baden in 1822. Since 1817 the distinction has accordingly been ignored in Prussia, and Christians are there enumerated only as Evangelical or Roman Catholic. The union, however, has not remained wholly unopposed—a section of the more rigid Lutherans who separated themselves from the state church being now known as Old Lutherans. In 1866 Prussia annexed Hanover and Schleswig-Holstein, where the Protestants were Lutherans, and

and Hesse, where the Reformed Church had the preponderance. The inhabitants of these countries opposed the introduction of the union, but could not prevent their being subordinated to the Prussian *Oberkirchenrat* (high church-council), the supreme court of the state church. A synodal constitution for the Evangelical State Church was introduced in Prussia in 1875. The *Oberkirchenrat* retains the right of supreme management. The ecclesiastical affairs of the separate provinces are directed by consistorial boards. The parishes (*Pfarreien*) are grouped into dioceses (*Sprengel*), presided over by superintendents, who are subordinate to the superintendent-general of the province. Prussia has sixteen superintendents-general. The ecclesiastical administration is similarly regulated in the other countries of the Protestant creed. Regarding the number of churches and chapels Germany has no exact statistics.

There are five archbishoprics within the German empire: Gnesen-Posen, Cologne, Freiburg (Baden), Munich-Freising and Bamberg. The twenty bishoprics are: Breslau (where the bishop has the title of "prince-bishop"), Ermeland (seat at Frauenburg, East Prussia), Kulm (seat at Pelplin, West Prussia), Fulda, Hildesheim, Osnabrück, Paderborn, Münster, Limburg, Trier, Metz, Strassburg, Spire, Würzburg, Regensburg, Passau, Eichstätt, Augsburg, Rottenburg (Württemberg) and Mainz. Apostolic vicariates exist in Dresden (for Saxony), and others for Anhalt and the northern missions.

The Old Catholics (*o.v.*), who seceded from the Roman Church in consequence of the definition of the dogma of papal infallibility, number roughly 50,000, with 51 clergy.

It is in the towns that the Jewish element is chiefly to be found. They belong principally to the mercantile class, and are to a very large extent dealers in money. Their wealth has grown to an extraordinary degree. They are increasingly numerous in Hamburg, Berlin, Frankfurt-on-Main, Breslau, Königsberg, Posen, Cologne, Nuremberg and Fürth. As a rule their numbers are proportionately greater in Prussia than elsewhere within the empire. But, since 1871, the Jewish population of Germany shows a far smaller increase than that of the Christian confessions, and even in the parts of the country where the Jewish population is densest it has shown a tendency to diminish. It is relatively greatest in the province of Posen, where the numbers have fallen from 61,982 (39.1 per thousand) in 1871 to 35,327 (18.7 per thousand) in 1900. The explanation is twofold—the extraordinary increase (1) in their numbers in Berlin and the province of Brandenburg, and (2) in the number of conversions to the Christian faith. In this last regard it may be remarked that the impulse is less from religious conviction than from a desire to associate on more equal terms with their neighbours. Though still, in fact at least, if not by law, excluded from many public offices, especially from commands in the army, they nevertheless are very powerful in Germany, the press being for the most part in their hands, and they furnish in many cities fully one-half of the lawyers and the members of the corporation. It should be mentioned, as a curious fact, that the numbers of the Jewish persuasion in the kingdom of Saxony increased from 3358 (1.3 per thousand) in 1871 to 12,416 (3 per thousand) in 1900.

Education.—In point of educational culture Germany ranks high among all the civilized great nations of the world (see EDUCATION: Germany). Education is general and compulsory throughout the empire, and all the states composing it have, with minor modifications, adopted the Prussian system providing for the establishment of elementary schools—*Volkschulen*—in every town and village. The school age is from six to fourteen, and parents can be compelled to send their children to a *Volkschule*, unless, to the satisfaction of the authorities, they are receiving adequate instruction in some other recognized school or institution.

The total number of primary schools was 60,584 in 1906-1907; teachers, 166,597; pupils, 9,737,262—an average of about one *Volkschule* to every 900 inhabitants. The annual expenditure was over £26,000,000, of which sum £7,500,000 was provided by state subvention. There were also in Germany in the same year 643 private schools, giving instruction similar to that of the elementary schools, with 41,000 pupils. A good criterion of the progress of education is obtained from the diminishing number of illiterate army recruits, as shown by the following

Years.	Number of Recruits.	Unable to Read or Write.	
		Total.	Per 1000 Recruits.
1875-1876	130,855	3311	23.7
1880-1881	151,180	2406	15.9
1885-1886	152,933	1657	10.8
1890-1891	193,318	1035	5.4
1895-1896	250,287	374	1.5
1898-1899	252,382	173	0.7
1900-1901	253,000	131	0.45

Of the above 131 illiterates in 1900-1901, 114 were in East and West Prussia, Posen and Silesia.

Universities and Higher Technical Schools.—Germany owes its large number of universities, and its widely diffused higher education to its former subdivision into many separate states. Only a few of the universities date their existence from the 19th century; the majority of them are very much older. Each of the larger provinces, except Posen, has at least one university, the entire number being 21. All have four faculties except Münster, which has no faculty of medicine. As regards theology, Bonn, Breslau and Tübingen have both a Protestant and a Catholic faculty; Freiburg, Munich, Münster and Würzburg are exclusively Catholic; and all the rest are Protestant.

The following table gives the names of the 21 universities, the dates of their respective foundations, the number of their professors and other teachers for the winter-half-year 1908-1909, and of the students attending their lectures during the winter half-year of 1907-1908:

	Date of Foundation.	Professors and Teachers.	Students.				Total.
			Theology.	Law.	Medicine.	Philosophy.	
Berlin . . .	1809	493	326	2747	1153	3934	8220
Bonn . . .	1818	190	395	833	282	1699	3209
Breslau . . .	1811	189	330	617	284	840	2071
Erlangen . . .	1743	77	155	323	355	225	1058
Freiburg . . .	1457	150	219	373	580	642	1814
Giessen . . .	1607	100	63	204	331	546	1144
Göttingen . . .	1737	161	102	441	188	1126	1857
Greifswald . . .	1456	105	68	188	186	361	803
Halle . . .	1694	174	331	450	217	1239	2237
Heidelberg . . .	1385	176	35	387	385	879	1676
Jena . . .	1558	116	48	267	265	795	1375
Kiel . . .	1665	121	35	271	239	480	1025
Königsberg . . .	1544	152	68	317	218	502	1105
Leipzig . . .	1409	234	303	1013	606	2419	4341
Marburg . . .	1527	117	133	400	261	876	1670
Munich . . .	1826	239	169	1892	1903	1979	5943
Münster . . .	1902	95	278	458	..	870	1606
Rostock . . .	1418	65	48	67	211	322	648
Strassburg . . .	1872	167	241	369	255	844	1709
Tübingen . . .	1477	111	464	467	263	384	1578
Würzburg . . .	1582	102	106	331	625	320	1382

Not included in the above list is the little academy—Lyceum Hosianum—at Braunsberg in Prussia, having faculties of theology (Roman Catholic) and philosophy, with 13 teachers and 150 students. In all the universities the number of matriculated students in 1907-1908 was 46,471, including 320 women, 2 of whom studied theology, 14 law, 150 philosophy and 154 medicine. There were also, within the same period, 5653 non-matriculated *Hörer* (hearers), including 2486 women.

Technical schools, technical high schools, or *Polytechnica*, rank with the universities, and have the power of granting certain degrees. They have departments of architecture, building, civil engineering, chemistry, metallurgy and, in some cases, anatomy. These schools are as follows: Berlin (Charlottenburg), Munich, Darmstadt, Karlsruhe, Hanover, Dresden, Stuttgart, Aix-la-Chapelle, Brunswick and Danzig; in 1908 they were attended by 14,149 students (2531 foreigners), and had a teaching staff of 753. Among the remaining higher technical schools may be mentioned the three mining academies of Berlin, Clausthal, in the Harz, and Freiberg in Saxony. For instruction in agriculture there are agricultural schools attached to several universities—notably Berlin, Halle, Göttingen, Königsberg, Jena, Poppelsdorf near Bonn, Munich and Leipzig. Noted academies of forestry are those of Tharandt (in Saxony), Eberswalde, Münden on the Weser, Hohenheim near Stuttgart, Brunswick, Eisenach, Giessen and Karlsruhe. Other technical schools are again the five veterinary academies of Berlin, Hanover, Munich, Dresden and Stuttgart, the commercial colleges (*Handelshochschulen*) of Leipzig, Aix-la-Chapelle, Hanover, Frankfurt-on-Main and Cologne, in

addition to 424 commercial schools of a lesser degree, 100 schools for textile manufactures and numerous schools for special metal industries, wood-working, ceramic industries, naval architecture and engineering and navigation. For military science there are the academies of war (*Kriegsakademien*) in Berlin and Munich, a naval academy in Kiel; and various cadet and non-commissioned officers' schools.

Libraries.—Mental culture and a general diffusion of knowledge are extensively promoted by means of numerous public libraries established in the capital, the university towns and other places. The most celebrated public libraries are those of Berlin (1,000,000 volumes and 30,000 MSS.); Munich (1,000,000 volumes, 40,000 MSS.); Heidelberg (563,000 volumes, 8000 MSS.); Göttingen (523,000 volumes, 6000 MSS.); Strassburg (760,000 volumes); Dresden (500,000 volumes, 6000 MSS.); Hamburg (municipal library, 600,000 volumes, 5000 MSS.); Stuttgart (400,000 volumes, 3500 MSS.); Leipzig (university library, 500,000 volumes, 5000 MSS.); Würzburg (350,000 volumes); Tübingen (340,000 volumes); Rostock (318,000 volumes); Breslau (university library, 300,000 volumes, 7000 MSS.); Freiburg-im-Breisgau (250,000 volumes); Bonn (265,000 volumes); and Königsberg (230,000 volumes, 1100 MSS.). There are also famous libraries at Gotha, Wolfenbüttel and Celle.

Learned Societies.—There are numerous societies and unions, some of an exclusively scientific character and others designed for the popular diffusion of useful knowledge. Foremost among German academies is the Academy of Sciences (*Akademie der Wissenschaften*) in Berlin, founded in 1700 on Leibnitz's great plan and opened in 1711. After undergoing various vicissitudes, it was reorganized by Frederick the Great on the French model and received its present constitution in 1812. It has four sections: physical, mathematical, philosophical and historical. The members are (1) ordinary (50 in number, each receiving a yearly dotation of £30), and (2) extraordinary, consisting of honorary and corresponding (foreign) members. It has published since 1811 a selection of treatises furnished by its

most eminent men, among whom must be reckoned Schleiermacher, the brothers Humboldt, Grimm, Savigny, Böckh, Ritter and Lachmann, and has promoted philological and historical research by helping the production of such works as *Corpus inscriptionum Græcarum*; *Corpus inscriptionum Latinarum*; *Monumenta Germaniæ historica*, the works of Aristotle, Frederick the Great's works and Kant's collected works. Next in order come (1) the Academy of Sciences at Munich, founded in 1759, divided into three classes, philosophical, historical and physical, and especially famous

for its historical research; (2) the Society of Sciences (*Gesellschaft der Wissenschaften*) in Göttingen, founded in 1742; (3) that of Erfurt, founded 1758; (4) Götting (1779) and (5) the "Royal Saxon Society of Sciences" (*Königliche sächsische Gesellschaft der Wissenschaften*), founded in Leipzig in 1846. Ample provision is made for scientific collections of all kinds in almost all places of any importance, either at the public expense or through private munificence.

Observatories.—These have in recent years been considerably augmented. There are 19 leading observatories in the empire, viz., at Bamberg, Berlin (2), Bonn, Bothkamp in Schleswig, Breslau, Düsseldorf, Gotha, Göttingen, Hamburg, Heidelberg, Jena, Kiel, Königsberg, Leipzig, Munich, Potsdam, Strassburg and Wilhelms-haven.

Book Trade.—This branch of industry, from the important position it has gradually acquired since the time of the Reformation, is to be regarded as at once a cause and a result of the mental culture of Germany. Leipzig, Berlin and Stuttgart are the chief centres of the trade. The number of booksellers in Germany was not less than 10,000 in 1907, among whom were approximately 6000 publishers. The following figures will show the recent progress of German literary production, in so far as published works are concerned:

Year	1570	1600	1618	1650	1700	1750	1800	1840	1884	1902
Books	229	791	1293	725	951	1219	3335	6904	15,607	26,902

Newspapers.—While in England a few important newspapers have an immense circulation, the newspapers of Germany are much more numerous, but on the whole command a more limited sale.

Some large cities, notably Berlin, Cologne, Hamburg, Dresden, Leipzig and Munich, have, however, newspapers with a daily circulation of over 100,000 copies, and in the case of some papers in Berlin a million copies is reached. Most readers receive their newspapers through the post office or at their clubs, which may help to explain the smaller number of copies sold.

Fine Arts.—Perhaps the chief advantage which Germany has derived from the survival of separate territorial sovereignties within the empire has been the decentralization of culture. Patronage of art is among the cherished traditions of the German princes; and even where—as for instance at Cassel—there is no longer a court, the artistic impetus given by the former sovereigns has survived their fall. The result has been that there is in Germany no such concentration of the institutions for the encouragement and study of the fine arts as there is in France or England. Berlin has no practical monopoly, such as is possessed by London or Paris, of the celebrated museums and galleries of the country. The picture galleries of Dresden, Munich and Cassel still rival that at Berlin, though the latter is rapidly becoming one of the richest in the world in works of the great masters, largely at the cost of the private collections of England. For the same reason the country is very well provided with excellent schools of painting and music. Of the art schools the most famous are those of Munich, Düsseldorf, Dresden and Berlin, but there are others, e.g. at Karlsruhe, Weimar and Königsberg. These schools are in close touch with the sovereigns and the governments, and the more promising pupils are thus from the first assured of a career, especially in connexion with the decoration of public buildings and monuments. To this fact is largely due the excellence of the Germans in grandiose decorative painting and sculpture, a talent for the exercise of which plenty of scope has been given them by the numerous public buildings and memorials raised since the war of 1870. Perhaps for this very reason, however, the German art schools have had no such cosmopolitan influence as that exercised by the schools of Paris, the number of foreign students attending them being comparatively small. It is otherwise with the schools of music, which exercise a profound influence far beyond the borders of Germany. Of these the most important are the conservatoires of Leipzig, Dresden, Berlin, Munich and Frankfort-on-Main. The fame of Weimar as a seat of musical education, though it possesses an excellent conservatoire, is based mainly on the tradition of the abbé Liszt, who gathered about him here a number of distinguished pupils, some of whom have continued to make it their centre. Music in Germany also receives a great stimulus from the existence, in almost every important town, of opera-houses partly supported by the sovereigns or by the civic authorities. Good music being thus brought within the reach of all, appreciation of it is very wide-spread in all classes of the population. The imperial government maintains institutes at Rome and Athens which have done much for the advancement of archaeology. (P. A. A.)

Army.—The system of the "nation in arms" owes its existence to the reforms in the Prussian army that followed Jena. The "nation in arms" itself was the product of the French Revolutionary and Napoleonic wars, but it was in Prussia that was seen the systematization and the economical and effective application of the immense forces of which the revolutionary period had demonstrated the existence (see also ARMY; CONSCRIPTION; FRENCH REVOLUTIONARY WARS, &c.). It was with an army and a military system that fully represented the idea of the "nation in arms" that Prussia created the powerful Germany of later days, and the same system was extended by degrees over all the other states of the new empire. But these very successes contained in themselves the germ of new troubles. Increased prosperity, a still greater increase in population and the social and economic disturbances incidental to the conversion of an agricultural into a manufacturing community, led to the practical abandonment of the principle of universal service. More men came before the recruiting officer than there was money to train; and in 1895 the period of service with the colours was reduced from three to two years—a step since followed by other military powers, the idea being that with the same peace effective and financial grants half as many men again could be passed through the ranks as before.

In 1907 the recruiting statistics were as follows:

Number of young men attaining service age (including those who had voluntarily enlisted before their time)	556,772
Men belonging to previous years who had been put back for re-examination, &c., still borne on the lists	657,753
	<hr/>
	1,214,525
<i>Deduct</i> —Physically unfit, &c.	35,802
<i>Struck off</i>	860

Voluntarily enlisted in the army and navy, on or before attaining service age	57,739
Assigned as recruits to the navy	10,374
Put back, &c.	684,193
	<hr/>
	788,948

Available as army recruits, fit	425,557
Of these, (a) Assigned to the active army for two or three years' service with the colours	212,661
(b) Assigned to the Ersatz-Reserve of the army and navy	89,877
(c) Assigned to the 1st levy of Landsturm	123,019
	<hr/>
	425,557

Thus only half the men on whom the government has an effective hold go to the colours in the end. Moreover few of the men "put back, &c.," who figure on both sides of the account for any one year, and seem to average 600,000, are really "put back." They are in the main those who have failed or fail to present themselves, and whose names are retained on the liability lists against the day of their return. Many of these have emigrated.

By the constitution of the 16th of April 1871 every German is liable to service and no substitution is allowed. Liability begins at the age of seventeen, and actual service, as a rule, from the age of twenty. The men serve in the active army and army reserve for seven years, of which two years (three in the case of cavalry and horse artillery recruits) are spent with the colours. During his four or five years in the reserve, the soldier is called out for training with his corps twice, for a maximum of eight weeks (in practice usually for six). After quitting the reserve the soldier is drafted into the first ban of the *Landwehr* for five years more, in which (except in the cavalry, which is not called out in peace time) he undergoes two trainings of from eight to fourteen days. Thence he passes into the second ban and remains in it until he has completed his thirty-ninth year—i.e. from six to seven years more, the whole period of army and *Landwehr* service being thus nineteen years. Finally, all soldiers are passed into the *Landsturm*, in the first ban of which they remain until the completion of their forty-fifth year. The second ban consists of untrained men between the ages of thirty-nine and forty-five. Young men who reach a certain standard of education, however, are only obliged to serve for one year in the active army. They are called One-Year Volunteers (*Einjährig-Freiwilligen*), defray their own expenses and are the chief source of supply of reserve and *Landwehr* officers. That proportion of the annual contingents which is dismissed untrained goes either to the Ersatz-Reserve or to the 1st ban of the *Landsturm* (the *Landwehr*, it will be observed, contains only men who have served with the colours). The Ersatz consists exclusively of young men, who would in war time be drafted to the regimental depots and thence sent, with what training circumstances had in the meantime allowed, to the front. Some men of the Ersatz receive a short preliminary training in peace time.

In 1907 the average height of the private soldiers was 5 ft. 6 in., that of the non-commissioned officers 5 ft. 6½ in., and that of the one-year volunteers 5 ft. 9½ in. A much greater proportion of the country recruits were accepted as "fit" than of those coming from the towns. Voluntary enlistments of men who desired to become non-commissioned officers were most frequent in the provinces of the old Prussian monarchy, but in Berlin itself and in Westphalia the enlistments fell far short of the number of non-commissioned officers required for the territorial regiments of the respective districts. Above all, in Alsace-Lorraine one-eighth only of the required numbers were obtained.

Peace and War Strengths.—German military policy is revised every five years; thus a law of April 1905 fixes the strength and establishments to be attained on March 31, 1910, the necessary augmentations, &c., being carried out gradually in the intervening years. The peace strength for the latter date was fixed at 505,839 men (not including officers, non-commissioned officers and one-year volunteers), forming—

633 battalions infantry.
510 squadrons cavalry.
574 batteries field and horse artillery.
40 battalions foot artillery.
29 battalions pioneers.
12 battalions communication troops.
23 train battalions, &c.

The addition of about 25,000 officers and 85,000 non-commissioned officers, one-year men, &c., brings the peace footing of the German army in 1910 to a total of about 615,000 of all ranks.

As for war, the total fighting strength of the German nation (including the navy) has been placed at as high a figure as 11,000,000. Of these 7,000,000 have received little or no training, owing to medical unfitness, residence abroad, failure to appear, surplus of annual contingents, &c., as already explained, and not more than 3,000,000 of these would be available in war. The real military resources of Germany, untrained and trained, are thus about 7,000,000, of whom 4,000,000 have at one time or another done a continuous period of service with the colours.¹ This is of course for a war of defence & offence. For an offensive war, only the active army, the reserve, the Ersatz and the 1st levy of the Landwehr would be really available.

A rough calculation of the number of these who go to form or to reinforce the field armies and the mobilized garrisons may be given:

Cadres of officers and non-commissioned officers	100,000
From 7 annual contingents of recruits (i.e. active army and reserve)	1,200,000
From 5 contingents of Landwehr (1st ban)	600,000
From 7 classes of Ersatz reserve called to the depots, able-bodied men	400,000
One-year volunteers recalled to the colours or serving as reserve and Landwehr officers	100,000
	2,400,000

These again would divide into a first line army of 1,350,000 and a second of 1,050,000. It is calculated that the field army would consist, in the third week of a great war, of 633 battalions, 410 squadrons and 574 batteries, with technical, departmental and medical troops (say 630,000 bayonets, 60,000 sabres and 3444 guns, or 750,000 men), and that these could be reinforced in three or four weeks by 350 fresh battalions. Behind these forces there would shortly become available for secondary operations about 460 battalions of the 1st ban Landwehr, and 200 squadrons and about 230 batteries of the reserve and Landwehr. In addition, each would leave behind depot troops to form the nucleus on which the 2nd ban Landwehr and the Landsturm would eventually be built up. The total number of units of the three arms in all branches may be stated approximately at 2200 battalions, 780 squadrons and 950 batteries.

Command and Organisation.—By the articles of the constitution the whole of the land forces of the empire form a united army in war and peace under the orders of the emperor. The sovereigns of the chief states are entitled to nominate the lower grades of officers, and the king of Bavaria has reserved to himself the special privilege of superintending the general administration of the three Bavarian army corps; but all appointments are made subject to the emperor's approval. The emperor is empowered to erect fortresses in any part of the empire. It is the almost invariable practice of the kings of Prussia to command their forces in person, and the army commands, too, are generally held by leaders of royal or princely rank. The natural corollary to this is the assignment of special advisory duties to a responsible chief of staff. The officers are recruited either from the Cadet Corps at Berlin or from amongst those men of sufficient social standing, who join the ranks as "avantagurs" with a view to obtaining commissions. Reserve and Landwehr officers are drawn from among officers and selected non-commissioned officers retired from the active army, and one-year volunteers who have passed a special examination. All candidates, from whatever source they come, are subject to approval or rejection by their brother officers before being definitively commissioned. Promotion in the German army is excessively slow, the senior subalterns having eighteen to twenty years' commissioned service and the senior captains sometimes thirty. The number of officers on the active list is about 25,000. The under-officers number about 84,000.

The German army is organized in twenty-three army corps, stationed and recruited in the various provinces and states as follows: Guard, Berlin (general recruiting); I. Königsberg (East Prussia); II. Stettin (Pomerania); III. Berlin (Brandenburg); IV. Magdeburg (Prussian Saxony); V. Posen (Poland and part of Silesia); VI. Breslau (Silesia); VII. Münster (Westphalia); VIII. Coblenz (Rhineland); IX. Altona (Hanse Towns and Schleswig-Holstein); X. Hanover (Hanover); XI. Cassel (Hesse-Cassel); XII. Dresden (Saxony); XIII. Stuttgart (Württemberg); XIV. Karlsruhe (Baden); XV. Strassburg (Alsace); XVI. Metz (Lorraine); XVII. Danzig (West Prussia); XVIII. Frankfurt-am-Main (Hesse Darmstadt, Main county); XIX. Leipzig (Saxony); I. Bavarian Corps, Munich; II. Bavarian Corps, Würzburg; III. Bavarian Corps, Nuremberg. The formation of a XX. army corps out of the extra division of the XIV. corps at Colmar in Alsace, with the addition of two regiments from Westphalia and drafts of the XV. and XVI. corps, was announced in 1908 as the final step of the programme for the period 1906-1910. The normal composition of an army corps on war is (a) staff, (b) 2 infantry divisions, each of 2 brigades (4

regiments or 12 battalions), 2 regiments of field artillery (comprising 9 batteries of field-guns and 3 of field howitzers, 72 pieces in all), 3 squadrons of cavalry, 1 or 2 companies of pioneers, a bridge train and 1 or 2 bearer companies; (c) corps troops, 1 battalion rifles, telegraph troops, bridge train, ammunition columns, train (supply) battalion, field bakeries, bearer companies and field hospitals, &c., with, as a rule, one or two batteries of heavy field howitzers or mortars and a machine-gun group. The remainder of the cavalry and horse artillery attached to the army corps in peace goes in war to form the cavalry divisions. Certain corps have an increased effective; thus the Guard has a whole cavalry division, and the I. corps (Königsberg) has three divisions. Several corps possess an extra infantry brigade of two 2-battalion regiments, but these, unless stationed on the frontiers, are gradually absorbed into new divisions and army corps. In war several army corps, cavalry divisions and reserve divisions are grouped in two or more "armies," and in peace the army corps are divided for purposes of superior control amongst several "army inspections."

The cavalry is organized in regiments of cuirassiers, dragoons, lancers, hussars and mounted rifles,² the regiments having four service and one depot squadrons. Troopers are armed with lance, sword and carbine (for which in 1908 the substitution of a short rifle with bayonet was suggested). In peace time the highest permanent organization is the brigade of two regiments or eight squadrons, but in war and at manoeuvres divisions of three brigades, with horse artillery attached, are formed.

The infantry consists of 216 regiments, mostly of three battalions each. These are numbered, apart from the eight Guard regiments and the Bavarians, serially throughout the army. Certain regiments are styled grenadiers and fusiliers. In addition there are eighteen chasseur or rifle battalions (*Jäger*). The battalion has always four companies, each, at war strength, 250 strong. The armament of the infantry is the model 1898 magazine rifle and bayonet (see RIFLE).

The field (including horse) artillery consists in peace of 94 regiments subdivided into two or three groups (*Abteilungen*), each of two or three 6-gun batteries. The field gun in use is the quick-firing gun 96/N.A. (see ORDNANCE: *Field Equipments*).

The foot artillery is intended for siege and fortress warfare, and to furnish the heavy artillery of the field army. It consists of forty battalions. Machine gun detachments, resembling 4-gun batteries and horsed as artillery, were formed to the number of sixteen in 1904-1906. These are intended to work with the cavalry divisions. Afterwards it was decided to form additional small groups of two guns each, less fully horsed, to assist the infantry, and a certain number of these were created in 1906-1908.

The engineers are a technical body, not concerned with field warfare or with the command of troops. On the other hand, the pioneers (29 battalions) are assigned to the field army, with duties corresponding roughly to those of field companies R.E. in the British service. Other branches represented in Great Britain by the Royal Engineers are known in Germany by the title "communication troops," and comprise railway, telegraph and airship and balloon battalions. The Train is charged with the duties of supply and transport. There is one battalion to each army corps.

Remounts.—The peace establishment in horses is approximately 100,000. Horses serve eight to nine years in the artillery and nine to ten in the cavalry, after which, in the autumn of each year, they are sold, and their places taken by remounts. The latter are bought at horse-fairs and private sales, unbroken, and sent to the 25 remount depots, whence, when fit for the service, they are sent to the various units, as a rule in the early summer. Most of the cavalry and artillery riding horses come from Prussia proper. The Polish districts produce swift Hussar horses of a semi-eastern type. Hanover is second only to East Prussia in output of horses. Bavaria, Saxony and Württemberg do not produce enough horses for their own armies and have to draw on Prussia. Thirteen thousand four hundred and forty-five young horses were bought by the army authorities during 1907. The average price was about £51 for field artillery draught horses, £65 for heavy draught horses, and £46 for riding horses.

The military expenditure of Germany, according to a comparative table furnished to the House of Commons by the British war office in 1907, varied between £36,000,000 and £44,000,000 per annum in the period 1899-1902, and between £42,000,000 and £51,000,000 per annum in that of 1905-1909.

Colonial Troops.—In 1906 these, irrespective of the brigade of occupation then maintained in north China and of special reinforcements sent to S.W. Africa during the Herrero war, consisted of the German East Africa troops, 220 Europeans and 1470 natives; the Cameroon troops, 145 European and 1170 natives; S.W. African troops, entirely European and normally consisting of 606 officers

¹ Actually between 1883 and 1908 over five million recruits passed through the drill sergeant's hands, as well as perhaps 210,000 one-year volunteers.

² These last have a curious history. They were formed from about 1890 onwards, by individual squadrons, two or three being voted each year. Ostensibly raised for the duties of mounted orderlies, at a time when it would have been impolitic to ask openly for more cavalry, they were little by little trained in real cavalry work, then combined in provisional regiments for disciplinary purposes and at last frankly classed as cavalry.

and men active and a reserve of ex-soldier settlers; the Kiao-Chau garrison (chiefly marines), numbering 2687 officers and men; and various small police forces in Togo, New Guinea, Samoa, &c.

Fortresses.—The fixed defences maintained by the German empire (apart from naval ports and coast defences) belong to two distinct epochs in the military policy of the state. In the first period (roughly 1871-1899), which is characterized by the development of the offensive spirit, the fortresses, except on the French and Russian frontiers, were reduced to a minimum. In the interior only Spandau, Cüstrin, Magdeburg, Ingolstadt and Ulm were maintained as defensive supporting points, and similarly on the Rhine, which was formerly studded with fortresses from Basel to Emmerich, the defences were limited to New Breisach, Germersheim, Mainz, Coblenz, Cologne and Wesel, all of a "barrier" character and not organized specially as centres of activity for field armies. The French frontier, and to a less extent the Russian, were organized offensively. Metz, already surrounded by the French with a girdle of forts, was extended and completed (see FORTIFICATION AND SIEGE-CRAFT) as a great entrenched camp, and Strassburg, which in 1870 possessed no outlying works, was similarly expanded, though the latter was regarded an instrument of defence more than of attack. On the Russian frontier Königsberg, Danzig, Thorn, Posen, Glogau (and on a smaller scale Boyen in East Prussia and Graudenz on the Vistula) were modernized and improved.

From 1899, however, Germany began to pay more attention to her fixed defences, and in the next years a long line of fortifications came into existence on the French frontier, the positions and strength of which were regulated with special regard to a new strategic disposition of the field armies and to the number and sites of the "strategic railway stations" which were constructed about the same time. Thus, the creation of a new series of forts extending from Thionville (Diedenhofen) to Metz and thence south-eastward was coupled with the construction of twelve strategic railway stations between Cologne and the Belgian frontier, and later—the so-called "fundamental plan" of operations against France having apparently undergone modification in consequence of changes in the foreign relations of the German government—an immense strategic railway station was undertaken at Saarburg, on the right rear of Thionville and well away from the French frontier, and many important new works both of fortification and of railway construction were begun in Upper Alsace, between Colmar and Basel.

The coast defences include, besides the great naval ports of Wilhelmshaven on the North Sea, and Kiel on the Baltic, Danzig, Pillau, Memel, Friedrichsort, Cuxhaven, Geestemünde and Swinemünde. (C. F. A.)

Navy.—The German navy is of recent origin. In 1848 the German people urged the construction of a fleet. Money was collected, and a few men-of-war were fitted out; but these were subsequently sold, the German *Bundestag* (federal council) not being in sympathy with the aspirations of the nation. Prussia however, began laying the foundations of a small navy. To meet the difficulty arising from the want of good harbours in the Baltic, a small extent of territory near Jade Bay was bought from Oldenburg in 1854, for the purpose of establishing a war-port there. Its construction was completed at enormous expense, and it was opened for ships by the emperor in June 1860 under the name of Wilhelmshaven. In 1864 Prussia, in annexing Holstein, obtained possession of the excellent port of Kiel, which has since been strongly fortified. From the time of the formation of the North German Confederation the navy has belonged to the common federal interest. Since 1st October 1867 all its ships have carried the same flag, of the national colours—black, white, red, with the Prussian eagle and the iron cross.

From 1848 to 1868 the increase of the navy was slow. In 1851 it consisted of 51 vessels, including 36 small gunboats of 2 guns each. In 1868 it consisted of 45 steamers (including 2 ironclads) and 44 sailing vessels, but during the various wars of the period 1848-1871, only a few minor actions were fought at sea, and for many years after the French War the development of the navy did not keep pace with that of the empire's commercial interests beyond the seas, or compete seriously with the naval power of possible rivals. But towards the end of the 19th century Germany started on a new naval policy, by which her fleet was largely and rapidly increased. Details of this development will be found in the article NAVY (see also *History* below, *ad fin.*). It will be sufficient here to give the statistics relating to the beginning of the year 1909, reference being made only to ships effective at that date and to ships authorized in the construction programme of 1907:

Modern battleships . . . 20 effective, 4 approaching completion.
Old battleships and coast defence ships . . . 11 effective (4 non-effective).
Armoured cruisers . . . 9 effective, 1 approaching completion.
Protected cruisers . . . 31 effective, 2 approaching completion.
Torpedo craft of modern types . . . 130 effective, 3 approaching completion.

Administration.—In 1880 the administration was transferred from the ministry of war to the imperial admiralty (*Reichsmarsineamt*), at the head of which is the naval secretary of state. The chief command was at the same time separated from the administration and vested in a naval officer, who controls the movements of the fleet, its personnel and training, while the maintenance of the arsenals and dockyards, victualling and clothing and all matters immediately affecting the *material*, fall within the province of the secretary of state. The navy is divided between the Baltic (Kiel) and North Sea (Wilhelmshaven) stations, which are strategically linked by the Kaiser Wilhelm Canal (opened in 1895), across the Schleswig-Holstein peninsula. Danzig, Cuxhaven and Sonderburg have also been made naval bases.

Personnel.—The German navy is manned by the obligatory service of the essentially maritime population—such as sailors, fishermen and others, as well as by volunteers, who elect for naval service in preference to that in the army. It is estimated that the total seafaring population of Germany amounts to 80,000. The active naval personnel was, in 1906, 2631 officers (including engineers, marines, medical, &c.) and 51,138 under-officers and men, total 53,769. In addition, there is a reserve of more than 100,000 officers and men. (P. A. A.)

Finance.—The imperial budget is voted every year by the Reichstag. The "extraordinary funds," from which considerable sums appear annually in the budget, were created after the Franco-German War. Part of the indemnity was invested for definite purposes. The largest of these investments served for paying the pensions of the invalided, and amounted originally to £28,000,000. Every year, not only the interest, but part of the capital is expended in paying these pensions, and the capital sum was thus reduced in 1903 to £15,100,000, and in 1904 to £13,200,000. Another fund, of about £5,200,000, serves for the construction and armament of fortresses; while £6,000,000, known as the *Reichskriegsschatz*—or "war treasure fund"—is not laid out at interest, but is stored in coined gold and bullion in the Julüsturm at Spandau. In addition to these, the railways in Alsace-Lorraine, which France bought of the Eastern Railway Company for £13,000,000, in order to transfer them to the control of Germany, are also the property of the empire.

During the years 1908 and 1909 considerable public discussion and political activity were devoted to the reorganization of German imperial finance, and it is only possible here to deal historically with the position up to that time, since further developments of an important nature were already foreshadowed.

In 1871 the system accepted was that the imperial budget should be financed substantially by its reliance on the revenue from what were the obvious imperial resources—customs and excise duties, stamp duties, post and telegraph receipts, and among minor sources the receipts from the Alsace-Lorraine railways. But it was also provided that, for the purpose of deficits, the states should, in addition, if required by the imperial minister of finance, contribute their quotas according to population—*Matrikular Beiträge*. It was not expected that these would become chronic, but in a few years, and emphatically by the early 'eighties, they were found to be an essential part of the financial system, owing to regular deficits. It had been intended that, in return for the *Matrikular Beiträge*, regular assignments (*Überweisungen*) should be returned to the states, in relief of their own taxation, which would practically wipe out the contribution; but instead of these the *Überweisungen* were considerably less. Certain reorganizations were made in 1887 and 1902, but the excess of the *Matrikular Beiträge* over the *Überweisungen* continued; the figures in 1905 and 1908 being as follows (in millions of marks):—

	Matrikular-Beiträge.	Überweisungen.	Excess.
1905	213	189	24
1908	346	195	150

These figures show how natural it was to desire to relieve the states by increasing the direct imperial revenue.

Meanwhile, in spite of the "matricular contributions," the calls on imperial finance had steadily increased, and up to 1908 were continually met to a large extent by loans, involving a continual growth of the imperial debt, which in 1907 amounted to 3643 millions of marks. The imperial budget, like that of most European nations, is divided into two portions, the ordinary and the extraordinary; and the increase under both heads (especially for army and navy) became a recurrent factor. A typical situation is represented by the main figures for 1905 and 1906 (in millions of marks):

	Expenditure.		Revenue.	Raised by Loan.
	Ordinary.	Extra-ordinary.		
1905	2002	193	2053	341
1906	2157	235	2118	258

The same process went on in 1907 and 1908, and it was necessarily recognized that the method of balancing the imperial budget by a regular increase of debt could not be satisfactory in a country where the general increase of wealth and taxable capacity had meanwhile been conspicuous. And though the main proposals made by the government for new taxation, including new direct taxes, resulted in a parliamentary deadlock in 1909, and led to Prince von Bülow's resignation as chancellor, it was already evident that some important reorganization of the imperial financial system was inevitable.

Currency.—The German empire adopted a gold currency by the law of the 4th of December 1871. Subsequently the old local coinages (*Landesmünzen*) began to be called in and replaced by new gold and silver coins. The old gold coins, amounting to 84,550,000, had been called in as early as 1873; and the old silver coins have since been successively put out of circulation, so that none actually remains as legal tender but the thaler (3s.). The currency reform was at first facilitated by the French indemnity, a great part of which was paid in gold. But later on that metal became scarcer; the London gold prices ran higher and higher, while silver prices declined. The average rate per ounce of standard silver in 1866–1870 was 60½d., in January 1875 only 57½d., in July 1876 as low as 49d. It rose in January 1877 to 57½d., but again declined, and in September 1878 it was 50½d. While the proportion of like weights of fine gold and fine silver in 1866–1870 averaged 1 to 15.55, it was 1 to 17.79 in 1876, 1 to 17.18 in 1877, and, in 1902, in consequence of the heavy fall in silver, the ratio became as much as 1 to 39. By the currency law of the 9th of July 1873, the present coinage system was established and remains, with certain minor modifications, now in force as then introduced. The unit is the mark (1 shilling)—the tenth part of the imperial gold coin (Krone=crown), of which last 1394 are struck from a pound of pure gold. Besides these ten-mark pieces, there are Doppelkronen (double crowns), about equivalent in value to an English sovereign (the average rate of exchange being 20 marks 40 pfennige per £1 sterling), and, formerly, half-crowns (half the Krone=5 marks) in gold were also issued, but they have been withdrawn from circulation. Silver coins are 5, 2 and 1 mark pieces, equivalent to 5, 2 and 1 shillings respectively, and 50 pfennige pieces=6d. Nickel coins are 10 and 5 pfennige pieces, and there are bronze coins of 2 and 1 pfennige. The system is decimal; thus 100 pfennige=1 mark, 1000 pfennige=the gold krone (or crown), and 1d. English amounts roughly to 8 pfennige.

Banking.—A new banking law was promulgated for the whole empire on the 14th of March 1875. Before that date there existed thirty-two banks with the privilege of issuing notes, and on the 31st of December 1872, £67,100,000 in all was in circulation, £25,100,000 of that sum being uncovered. The banking law was designed to reduce this circulation of notes; £19,250,000 was fixed as an aggregate maximum of uncovered notes of the banks. The private banks were at the same time obliged to erect branch offices in Berlin or Frankfurt-on-Main for the payment of their notes. In consequence of this regulation numerous banks resigned the privilege of issuing notes, and at present there are in Germany but the following private note banks issuing private notes, viz. the Bavarian, the Saxon, the Württemberg, the Baden and the Brunswick, in addition to the

Imperial Bank. The Imperial Bank (Reichsbank) ranks far above the others in importance. It took the place of the Prussian Bank in 1876, and is under the superintendence and management of the empire, which shares in the profits. Its head office is in Berlin, and it is entitled to erect branch offices in any part of the empire. It has a capital of £9,000,000 divided into 40,000 shares of £150 each, and 60,000 shares of £50 each. The Imperial Bank is privileged to issue bank-notes, which must be covered to the extent of 1s. 3d. in coined money, bullion or bank-notes, the remainder in bills at short sight. Of the net profits, a dividend of 3½% is first payable to the shareholders, 20% of the remainder is transferred to the reserve until this has reached a total of £3,000,000, and of the remainder again a quarter is apportioned to the shareholders and three-quarters falls to the imperial exchequer. If the net profits do not reach 3½%, the balance must be made good from the reserve. Private note banks are not empowered to do business outside the state which has conceded them the privilege to issue notes, except under certain limitations. One of these is that they agree that their privilege to issue private notes may be withdrawn at one year's notice without compensation. But this condition has not been enforced in the case of such banks as have agreed to accept as binding the official rate of discount of the Reichsbank after this has reached or when it exceeds 4%. At other times they are not to discount at more than ½% below the official rate of the Reichsbank, or in case the Reichsbank itself discounts at a lower rate than the official rate, at more than ½% below that rate.

The following table shows the financial condition of the note-issuing banks, in thousands of marks, over a term of years:

Liabilities.

Year.	Banks.	Capital.	Reserve.	Notes in Circulation.	Total, including other Liabilities.
1900	8	219,672	48,329	1,313,855	2,237,017
1901	7	231,672	54,901	1,345,436	2,360,453
1902	6	216,000	56,684	1,373,482	2,353,951
1903	6	216,000	60,131	1,394,336	2,368,256
1904	6	216,000	64,385	1,433,421	2,378,845

Assets.

Year.	Banks.	Coin and Bullion.	Notes of State and other Banks.	Bills.	Total.
1900	8	899,630	51,931	1,036,961	2,239,564
1901	7	990,262	60,770	990,950	2,360,355
1902	6	1,052,391	54,389	901,408	2,354,253
1903	6	973,953	54,231	984,604	2,356,511
1904	6	996,601	66,372	947,358	2,379,234

The total turnover of the Imperial Bank was, in the first year of its foundation, 1½ milliards pounds sterling; and, in 1899, 90 milliards. Eighty-five per cent of its bank-notes have been, on the average, covered by metal reserve.

The total value of silver coins is not to exceed 10 marks, and that of copper and nickel 2½ marks per head of the population. While the coinage of silver, nickel and copper is reserved to the state, the coinage of gold pieces can be undertaken by the state for the account of private individuals on payment of a fixed charge. The coinage takes place in the six mints belonging to the various states—thus Berlin (Prussia), Munich (Bavaria), Dresden (in the Muldenhütte near Freiberg, Saxony), Stuttgart (Württemberg), Karlsruhe (Baden) and Hamburg (for the state of Hamburg). Of the thalers, the Vereinsthaler, coined until 1867 in Austria, was by ordinance of the Bundesrat declared illegal tender since the 1st of January 1903. No one can be compelled to accept more than 20 marks in silver or more than 1 mark in nickel and copper coin; but, on the other hand, the Imperial Bank accepts imperial silver coin in payment to any amount.

The total value of thalers, which, with the exception of the Vereinsthaler, are legal tender, was estimated in 1894 at about £20,000,000.

BIBLIOGRAPHY.—Cotta, *Deutschlands Boden* (3 vols., 1853); H. A. Daniel, *Deutschland* (1896); J. Kutzeln, *Das deutsche Land* (Breslau, 1900); Von Klöden, *Geographisches Handbuch*, vol. ii. (1875); G. Neumann, *Das deutsche Reich* (2 vols., 1874); O. Brunckow, *Die Wohnplätze des deutschen Reiches—auf Grund der amtlichen Materialien bearbeitet* (new ed., Berlin, 1897); *Handbuch der Wirtschaftskunde Deutschlands* (4 vols., Leipzig, 1901–1905); *Gothaischer genealogischer Hofkalender auf das Jahr 1907* (Gotha); A. von W. Keil, *Neumanns Orlisxikon des deutschen Reiches* (3rd ed., Leipzig, 1894); Meyer, *Konversations-Lexikon* (1902 seq.); Brockhaus, *Konversations-Lexikon* (1900 seq.); J. Kürschner, *Staats- Hof- und Kommunal-handbuch des Reiches und der Einzelstaaten* (Leipzig, 1900); P. Hage, *Grundriss der deutschen Staats- und Rechtskunde* (Stuttgart, 1906), and for statistical matter chiefly the following: *Centralblatt für das deutsche Reich. Herausgegeben im Reichsamt der Innern* (Berlin, 1900); *Die deutsche Armee und die kaiserliche Marine* (Berlin, 1900).

Gewerbe und Handel im deutschen Reich nach der gewerblichen Betriebszählung, vom 14. Juni 1895 (Berlin, 1899); *Handbuch für das deutsche Reich auf das Jahr 1900*, bearbeitet im Reichsamt der Innern (Berlin); *Handbuch für die deutsche Handelsmarine auf das Jahr 1900*; *Statistik des deutschen Reichs*, published by the Kaiserliches Statistisches Amt (including trade, navigation, criminal statistics, sick insurance, &c.); *Statistisches Jahrbuch für das deutsche Reich* (Berlin, 1906) and *Vierteljahrshäfte für Statistik des deutschen Reichs* (including census returns, commerce and railways). See also among English publications on geographical and statistical matter: *Annual Statement of the Trade of the United Kingdom with Foreign Countries and British Possessions for the Year 1899* (London, 1900); and G. G. Chisholm, *Europe*, being vols. i. and ii. of *Stanford's Compendium of Geography and Travel* (London, 1899 and 1900). The fullest general account of the geology of Germany will be found in R. Lepsius, *Geologie von Deutschland und den angrenzenden Gebieten* (Stuttgart, first volume completed in 1892). Shorter descriptions will be found in E. Kayser, *Lehrbuch der geologischen Formationskunde* (Stuttgart, English edition under the title *Text-book of Comparative Geology*), and H. Credner, *Elemente der Geologie* (Leipzig).

ARCHAEOLOGY

From an archaeological point of view Germany is very far from being a homogeneous whole. Not only has the development of the south differed from that of the north, and the west been subjected to other influences than those affecting the east, but even where the same influences have been at work the period of their operation has often varied widely in the different districts, so that in a general sketch of the whole country the chronology can only be a very rough approximation. In this article the dates assigned to the various periods in south Germany are those given by Sophus Müller, on the lines first laid down by Montelius. As regards north Germany, Müller puts the Northern Bronze age 500 years later than the Southern, but a recent find in Sweden bears out Montelius's view that southern influence made itself rapidly felt in the North. The conclusions of Montelius and Müller are disputed by W. Ridgeway, who maintains that the Iron age originated in central Europe, and that iron must consequently have been worked in those regions as far back as c. 2000 B.C.

Older Palaeolithic Period.—The earliest traces of man's handiwork are found either at the end of the pre-Glacial epoch, or in an inter-Glacial period, but it is a disputed point whether the latter is the first of a series of such periods. A typical German find is at Taubach, near Weimar, where almond-shaped stone wedges, small flint knives, and roughly-hacked pieces of porphyry and quartz are found, together with the remains of elephants. There are also bone implements, which are not found in the earliest periods in France.

Palaeolithic Transition Period (Solutré).—More highly developed forms are found when the mammoth has succeeded the elephant. Implements of chipped stone for the purposes of boring and scraping suggest that man worked hides for clothing. Ornaments of perforated teeth and shells are found.

Later Palaeolithic Period (La Madeleine).—The next period is marked by the presence of reindeer. In the Hohlefels in the Swabian Achthal there is still no trace of earthenware, and we find the skull of a reindeer skillfully turned into a drinking-vessel. Saws, needles, awls and bone harpoons are found. It is to be noticed that none of the German finds (mostly in the south and west) show any traces of the highly developed artistic sense so characteristic of the dwellers in France at this period.

The gap in our knowledge of the development of Palaeolithic into Neolithic civilization has recently been partially filled in by discoveries in north Germany and France of objects showing rather more developed forms than those of the former period, but still unaccompanied by earthenware. It is a disputed point whether the introduction of Neolithic civilization is due to a new ethnological element.

Neolithic Age (in south Germany till c. 2000 B.C.).—Neolithic man lived under the same climatic conditions as prevail to-day, but amidst forests of fir. He shows advance in every direction, and by the end of the later Neolithic period he is master of the arts of pottery and spinning, is engaged in agricultural pursuits, owns domestic animals, and makes weapons and tools of fine shape, either ground and polished or beautifully chipped.

Traces of Neolithic settlements have been found chiefly in the neighbourhood of Worms, in the Main district and in Thuringia. These dwellings are usually holes in the ground, and presumably had thatched roofs. Our knowledge of the later Neolithic age, as of the succeeding periods, is largely gained from the remains of lake-dwellings, represented in Germany chiefly by Bavarian finds. The lake-dwellings in Mecklenburg, Pomerania and East Prussia are of a different type, and it is not certain that they date back to the Stone age. Typical Neolithic cemeteries are found at Hinkelstein, Alzey and other places in the neighbourhood of Worms. In these graves the skeletons lie flat, while in other cemeteries, as at Flomborn in Rhine-Hessen, and near Heilbronn, they are in a huddled position (hence the name *Hockergäber*). Necklaces and bracelets of Mediterranean shells point to a considerable amount of commerce. Other objects found in the graves are small flint knives, stone axes, flint and lumps of pyrites for obtaining fire, and, in the women's graves, hand-mills for grinding corn. The earthenware vessels usually have rounded bottoms. The earliest ornamentation consists of finger-imprints. Later we find two periods of zigzag designs in south Germany with an intermediate stage of spirals and wavy lines, while in north and east Germany the so-called string-ornamentation predominates. Towards the end of the period the inhabitants of north Germany erect megalithic graves, and in Hanover especially the passage-graves.

Bronze Age (in south Germany from c. 2000-1000 B.C.).—In the later Stone age we note the occasional use of copper, and then the gradual appearance of bronze. The bronze civilization of the Aegean seems to have had direct influence along the basins of the Danube and Elbe, while the culture of the western parts of central Germany was transmitted through Italy and France. No doubt the pre-eminence of the north, and especially of Denmark, at this period, was due to the amber trade, causing southern influence to penetrate up the basin of the Elbe to Jutland. The earlier period is characterized by the practice of inhumation in barrows made of clays, stones or sand, according to the district. Bronze is cast, whereas at a later time it shows signs of the hammer. From the finds in Bavarian graves it appears that the chief weapons were the dagger and the long pointed *Palstab* (palstave), while a short dagger fixed like an axe on a long shaft is characteristic of the North. The women wore two bronze pins, a bracelet on each arm, amber ornaments and a necklace of bronze tubes in spirals. One or two vases are found in each barrow, ornamented with finger-imprints, "string" decoration, &c. The later period is characterized by the practice of cremation, though the remains are still placed in barrows. Swords make their appearance. The women wear more and more massive ornaments. The vases are highly polished and of elegant form, with zigzag decoration.

Hallstatt Period (in Germany 8th-5th century B.C.).—The Hallstatt stage of culture, named after the famous cemetery in upper Austria, is marked by the introduction of iron (see *HALLSTATT*). In Germany its centre is Bavaria, Baden and Württemberg, with the Thuringian forest as the northern boundary. In Brandenburg, Lusatia, Silesia, Posen and Saxony, where there was no strong Bronze age tradition, Hallstatt influence is very noticeable. In west Prussia the urns with human faces deserve notice. The dead are either buried in barrows or cremated, the latter especially in north and east Germany. In Bavaria both practices are resorted to, as at Hallstatt. The pottery develops beautiful form and colour. Fibulae, often of the "kettle-drum" form, take the place of the Bronze age pin.

La Tène Period (4th-1st century B.C.).—Down to this time there is very little evidence concerning the racial affinities of the population. When our records first begin the western and southern portions of Germany seem to have been inhabited by Celtic peoples (see below "Ethnography"). *La Tène*, in Switzerland, has given its name to the period, of which the earlier part corresponds to the time of Celtic supremacy. It is interesting to note how the Celts absorb Roman and still more Greek culture, even imitating foreign coins, and pass on their new arts to their Teutonic neighbours; but in spite of the strong foreign influence

the Celtic civilization can in some sort be termed national. Later it has a less rich development, betraying the political decay of the race. Its centres in Germany are the southern districts as far as Thuringia, and the valleys of the Main and Saar. The ornamentation is of the conventionalized plant type: gold is freely used, and enamel, of a kind different from the Roman enamel used later in Germany, is applied to weapons and ornaments. Chariots are used in war, and fortified towns are built, though we must still suppose the houses to have consisted of a wooden framework coated with clay. In these districts La Tène influence is contemporary with the use of tumuli, but in the (non-Celtic) coast districts it must be sought in urn-cemeteries.

Roman Period (from the 1st century A.D.).—The period succeeding to La Tène ought rather to be called Romano-Germanic, the relation of the Teutonic races to the Roman civilization being much the same as that of the Celts to classical culture in the preceding period. The Rhine lands were of course the centre of Roman civilization, with Roman roads, fortresses, stone and tiled houses and marble temples. By this time the Teutonic peoples had probably acquired the art of writing, though the origin of their national (Runic) alphabet is still disputed. The graves of the period contain urns of earthenware or glass, cremation being the prevalent practice, and the objects found include one or more coins in accordance with Roman usage.

Period of National Migrations (A.D. 300–500).—The grave-finds do not bear out the picture of a period of ceaseless war painted by the Roman historians. On the contrary, weapons are seldom found, at any rate in graves, the objects in which bear witness to a life of extraordinary luxury. Magnificent drinking-vessels, beautifully ornamented dice and draughtsmen, masses of gay beads, are among the commonest grave-finds. A peculiarity of the period is the development of decoration inspired by animal forms, but becoming more and more tortuous and fantastic. Only those eastern parts of Germany which were now occupied by Slavonic peoples remained uninfluenced by this rich civilization.

The Merovingian Period (A.D. 500–800) sees the completion of the work of converting the German tribes to Christianity. *Reihengräber*, containing objects of value; but otherwise like modern cemeteries, with the dead buried in rows (*Reihen*), are found over all the Teutonic part of Germany, but some tribes, notably the Alamanni, seem still to have buried their dead in barrows. Among the Franks and Burgundians we find monolithic sarcophagi in imitation of the Romans, and in other districts sarcophagi were constructed out of several blocks of stone—the so-called *Plattengräber*. The weapons are the *spatha*, or double-bladed German sword, the *sax* (a short sword, or long knife, *semispathium*), the knife, shield, and the favourite German axe, though this latter is not found in Bavaria. The ornaments are beads, earrings, brooches, rings, bracelets, &c., thickly studded with precious stones.

AUTHORITIES.—S. Müller, *Urgeschichte Europas* (1905), and *Tierornamentik* (1881); O. Montelius, "Chronologie der Bronzezeit in N. Deutschland und Skandinavien," in *Archiv für Anthropologie*, vols. xxv. and xxvi.; M. Hoernes, *Urgeschichte des Menschen* (1892), and *Der diluviale Mensch in Europa* (1903); M. Much, *Kupferzeit in Europa* (1893); R. Munro, *Lake-dwellings of Europe* (1890); J. Naue, *Bronzezeit in Ober-Bayern* (1894); O. Tischler, *Ostpreussische Altertümer* (1902); R. Virchow, *Über Hünengräber und Pfahlbauten* (1866); J. Meistert, *Urnenfriedhöfe in Schleswig-Holstein* (1886); A. Lissauer, *Prähistorische Denkmäler Preussens* (1887); I. Undset, *Erstes Auftreten des Eisens in N. Europa* (1882); L. Lindenschmit, *Handbuch der deutschen Altertumskunde*, i. (1880–1889); and W. Ridgeway, *Early Age of Greece*, i. (1901). Also articles by the above and others, chiefly in *Zeitschrift für Ethnologie* (Berlin); *Archiv für Anthropologie* (Brunswick); *Globus* (Brunswick); *Westdeutsche Zeitschrift* (Trier); *Schriften der physikalisch-ökonomischen Gesellschaft* (Königsberg); *Nachrichten über deutsche Altertumskunde* (Berlin); *Verhandlungen der Berliner Gesellschaft für Anthropologie, &c.*; *Beiträge zur Anthropologie Bayerns* (Munich); and *Zeitschrift für deutsches Altertum* (Berlin). (B. S. P.)

ETHNOGRAPHY AND EARLY HISTORY

Our direct knowledge of Germany begins with the appointment of Julius Caesar as governor of Gaul in 59 B.C. Long before that time there is evidence of German communication

with southern civilization, as the antiquities prove, and occasional travellers from the Mediterranean had made their way into those regions (e.g. Pytheas, towards the end of the 4th century), but hardly any records of their journeys survive. The first Teutonic peoples whom the Romans are said to have encountered are the Cimbric and Teutonic, probably from Denmark, who invaded Illyria, Gaul and Italy towards the end of the 2nd century B.C. When Caesar arrived in Gaul the westernmost part of what is now Germany was in the possession of Gaulish tribes. The Rhine practically formed the boundary between Gauls and Germans, though one Gaulish tribe, the Menapii, is said to have been living beyond the Rhine at its mouth, and shortly before the arrival of Caesar an invading force of Germans had seized and settled down in what is now Alsace, 72 B.C. At this time the Gauls were being pressed by the Germans along the whole frontier, and several of Caesar's campaigns were occupied with operations, either against the Germans, or against Gaulish tribes set in motion by the Germans. Among these we may mention the campaign of his first year of office, 58 B.C., against the German king Ariovistus, who led the movement in Alsace, and that of 55 B.C. in which he expelled the Usipetes and Tencteri who had crossed the lower Rhine. During the period of Caesar's government he succeeded in annexing the whole of Gaul as far as the Rhine. (For the campaigns see CAESAR, JULIUS.)

After peace had been established in Italy by Augustus, attempts were made to extend the Roman frontier beyond the Rhine. The Roman prince Nero Claudius Drusus (q.v.) in the year 12 B.C. annexed what is now the kingdom of the Netherlands, and constructed a canal (Fossa Drusiana) between the Rhine and the lake Flevo (Lacus Flevus), which partly corresponded to the Zuyder Zee, though the topography of the district has greatly altered. He also penetrated into regions beyond and crossed the Weser, receiving the submission of the Bructeri, Chatti and Cherusci. After Drusus' death in 9 B.C., while on his return from an expedition which reached the Elbe, the German command was twice undertaken by Tiberius, who in A.D. 5 received the submission of all the tribes in this quarter, including the Chauci and the Langobardi. A Roman garrison was left in the conquered districts between the Rhine and the Elbe, but the reduction was not thoroughly completed. About the same time the Roman fleet voyaged along the northern coast apparently as far as the north of Jutland, and received the nominal submission of several tribes in that region, including the Cimbric and the Charudes. In A.D. 9 Quintilius Varus, the successor of Tiberius, was surprised in the *Saltus Teutobergensis* between the Lippe and the Weser by a force raised by Arminius, a chief of the Cherusci, and his army consisting of three legions was annihilated. Germanicus Caesar, during his tenure of the command of the Roman armies on the Rhine, made repeated attempts to recover the Roman position in northern Germany and exact vengeance for the death of Varus, but without real success, and after his recall the Rhine formed for the greater part of its course the boundary of the Empire. A standing army was kept up on the Rhine, divided into two commands, upper and lower Germany, the headquarters of the former being at Mainz, those of the latter at Vetera, near Xanten. A number of important towns grew up, among which we may mention Trier (Augusta Treverorum), Cologne (Colonia Agrippinensis), Bonn (Bonna), Worms (Borbetomagus), Spire (Noviomagus), Strassburg (Argentoratum) and Augsburg (Augusta Vindelicorum).

At a later date, however, probably under the Flavian emperors, the frontier of upper Germany was advanced somewhat beyond the Rhine, and a fortification, the *Pfalzgraben*, constructed to protect it. It led from Hönningen on the Rhine, about half-way between Bonn and Coblenz, to Mittenberg above Aschaffenburg on the Main, thence southwards to Lorch in Würtemberg, whence it turned east to the junction of the Altmühl with the Danube at Kelheim.

During the wars of Drusus, Tiberius and Germanicus the Romans had ample opportunity of getting to know the tribal

Julius
Caesar in
Germany.

The cam-
paigns of
other
Roman
leaders.

geography of Germany, especially the western part, and though most of our authorities lived at a somewhat later period, it is probable that they derived their information very largely from records of that time. It will be convenient, therefore, to give an account of the tribal geography of Germany in the time of Augustus, as our knowledge of the subject is much more complete for his reign than for several centuries later.

Of the Gaulish tribes west of the Rhine, the most important was the Treveri, inhabiting the basin of the Moselle, from whom the city of Trier (Trèves) derives its name. The Rauraci probably occupied the south of Alsace. To the south of the Treveri lay the Mediomatrici, and to the west of them lay the important tribe of the Sequani, who had called in Ariovistus. The Treveri claimed to be of German origin, and the same claim was made by a number of tribes in Belgium, the most powerful of which were the Nervii. The meaning of this claim is not quite clear, as there is some obscurity concerning the origin of the name Germani. It appears to be a Gaulish term, and there is no evidence that it was ever used by the Germans themselves. According to Tacitus it was first applied to the Tungri, whereas Caesar records that four Belgic tribes, namely, the Condrusi, Eburones, Caeraesi and Paemani, were collectively known as Germani. There is no doubt that these tribes were all linguistically Celtic, and it is now the prevailing opinion that they were not of German origin ethnologically, but that the ground for their claim was that they had come from over the Rhine (cf. Caesar, *De Bello Gallico* ii. 4). It would therefore seem that the name Germani originally denoted certain Celtic tribes to the east of the Rhine, and that it was then transferred to the Teutonic tribes which subsequently occupied the same territory.

There is little doubt that during the last century before the Christian era the Celtic peoples had been pushed considerably farther west by the Teutonic peoples, a process which was still going on in Caesar's time, when we hear of the overthrow of the Menapii, the last Gaulish tribe beyond the Rhine. In the south the same process can be observed. The Boii were expelled from their territories in Bohemia by the Marcomanni in the time of Augustus, and the Helvetii are also recorded to have occupied formerly lands east of the Rhine, in what is now Baden and Württemberg. Caesar also mentions a Gaulish tribe named Volcae Tectosages as living in Germany in his time. The Volcae Arcomici in the south of France and the Tectosages of Galatia were in all probability offshoots of this people. The name of the tribe was adopted in the Teutonic languages as a generic term for all Celtic and Italian peoples (O.H.G. *Walha*, A.S. *Wealas*), from which it is probably to be inferred that they were the Celtic people with whom the Teutonic races had the closest association in early times. It has been thought that they inhabited the basin of the Weser, and a number of place-names in this district are supposed to be of Celtic origin. Farther to the south and west Ptolemy mentions a number of place-names which are certainly Celtic, e.g. Mediolanion, Aregelia, Lougidounon, Lokoriton, Segodounon. There is therefore great probability that a large part of western Germany east of the Rhine had formerly been occupied by Celtic peoples. In the east a Gaulish people named Cotini are mentioned, apparently in the upper basin of the Oder, and Tacitus speaks of a tribe in the same neighbourhood, the Osi, who he says spoke the Pannonian language. It is probable, therefore, that in other directions also the Germans had considerably advanced their frontier southwards at a comparatively recent period.

Coming now to the Germans proper, the basin of the Rhine between Strassburg and Mainz was inhabited by the Tribocci, Nemetes and Vangiones, farther down by the Mattiaci about Wiesbaden, and the Ubii in the neighbourhood of Cologne; beyond them were the Sugambri, and in the Rhine delta the Batavi and other smaller tribes. All these tribes remained in subjection to the Romans. Beyond them were the Tencteri, probably about the basin of the *Lahn*, and the *Usipetes* about the basin of the Ruhr. The

The German tribes.

Their movements.

Tribes in the west and north.

basin of the Lippe and the upper basin of the Ems were inhabited by the Bructeri, and in the same neighbourhood were the Ampsivarii, who derive their name from the latter river. East of them lay the Chasuarii, presumably in the basin of the Hase. The upper basin of the Weser was inhabited by the Chatti, whose capital was Mattium, supposed to be Maden on the Eder. To the north-west of them were situated the Marsi, apparently between the Diemel and the Lippe, while the central part of the basin of the Weser was inhabited by the Cherusci, who seem to have extended considerably eastward. The lower part of the river-basin was inhabited by the Angrivarii. The coastlands north of the mouth of the Rhine were occupied by the Canninates, beyond them by the Frisii as far as the mouth of the Ems, thence onward to the mouth of the Elbe by the Chauci. As to the affinities of all these various tribes we have little definite information, but it is worth noting that the Batavi in Holland are said to have been a branch of the Chatti, from whom they had separated owing to a *sedilio domestica*. The basin of the Elbe was inhabited by Suebic tribes, the chief of which were the Marcomanni, who seem to have been settled on the Saale during the latter part of the 1st century B.C., but moved into Bohemia before the beginning of the Christian era, where they at once became a formidable power under their king Maroboduus. The Quadi were settled somewhat farther east about the source of the Elbe. The Hermunduri in the basin of the Saale were in alliance with the Romans and occupied northern Bavaria with their consent. The Semnones apparently dwelt below the junction of the Saale and Elbe. The Langobardi (see LOMBARDS) possessed the land between the territory of the Semnones and the mouth of the river. Their name is supposed to be preserved in Bardengau, south of Hamburg. From later evidence it is likely that another division of the Suebi inhabited western Holstein. The province of Schleswig (perhaps only the west coast) and the islands adjacent were inhabited by the Saxons, while the east coast, at least in later times, was occupied by the Angli. The coast of Mecklenburg was probably inhabited by the Varini (the later Warni). The eastern part of Germany was much less known to the Romans, information being particularly deficient as to the populations of the coast districts, though it seems probable that the Rugii inhabited the eastern part of Pomerania, where a trace of them is preserved in the name Rügenwalde. The lower part of the basin of the Oder was probably occupied by the Burgundiones, and the upper part by a number of tribes collectively known as Lugii who seem to correspond to the Vandals of later times, though the early Roman writers apparently used the word Vandilii in a wider sense, embracing all the tribes of eastern Germany. Among the Lugii we may probably include the Silingae, who afterwards appear among the Vandals in Spain, and whose name is preserved in Slavonic form in that of the province Silesia. The Goths (Gotones) apparently inhabited the basin of the Vistula about the middle of its course, but the lower part of the basin was inhabited by non-Teutonic peoples, among whom we may mention the Galindi, probably Prussians, and the Aestii, either Prussian or Esthonian, in the coastlands at the mouth of the river, who are known especially in connexion with the amber trade. To the east of the Vistula were the Slavonic tribes (Veneti), and amongst them, perhaps rather to the north, a Finnish population (Fenni), which disappeared in later times.

In the time of Augustus by far the most powerful ruler in Germany was Maroboduus, king of the Marcomanni. His supremacy extended over all the Suebic tribes (except perhaps the Hermunduri), and most of the peoples of eastern Germany, including apparently the Lugii and Goths. But in the year A.D. 17 he became involved in an unsuccessful campaign against Arminius, prince of the Cherusci, in which the Semnones and Langobardi revolted against him, and two years later he was deprived of his throne by a certain Catualda. The latter, however, was soon expelled by Vibilius, king of the Hermunduri, and his power was transferred to Vannius, who belonged to the Quadi. About the same time Arminius met his death while trying to make himself king of the

Domestic wars of the Germans.

Cherusci. In the year 28 the Frisians revolted from the Romans, and though they submitted again in the year 47, Claudius immediately afterwards recalled the Roman troops to the left bank of the Rhine. In the year 50 Vannius, king of the Suebi, was driven from the throne by Vibilius, king of the Hermunduri, and his nephews Vangio and Sido obtained his kingdom. In the year 58 the Chatti suffered a serious disaster in a campaign against the Hermunduri. They seem, however, to have recovered very soon, and at the end of the 1st century had apparently extended their power at the expense of the Cherusci. During the latter part of the 1st century the Chauca seem to have been enlarging their territories: as early as the year 47 we find them raiding the Roman lands on the lower Rhine, and in 58 they expelled the Ampsivarii, who after several vain attempts to acquire new possessions were annihilated by the neighbouring tribes. During the last years of the 1st century the Angrivarii are found moving westwards, probably under pressure from the Chauca, and the power of the Bructeri was almost destroyed by their attack. In 69 the Roman territory on the lower Rhine was disturbed by the serious revolt of Claudius Civilis, a prince of the Batavi who had served in the Roman army. He was joined by the Bructeri and other neighbouring tribes, but being defeated by Petilius Cerealis (afterwards consular legate in Britain) at Vetera and in other engagements gave up the struggle and arranged a capitulation in A.D. 70. By the end of the 1st century the Chauca and Chatti seem to have become by far the most powerful tribes in western Germany, though the former are seldom mentioned after this time.

After the time of Tacitus our information regarding German affairs becomes extremely meagre. The next important conflict with the Romans was the Marcomannic War (166-180), in which all the Suebic tribes together with the Vandals (apparently the ancient Lugii) and the Sarmatian Iazyges seem to have taken part. Peace was made by the emperor Commodus in A.D. 180 on payment of large sums of money.

About the beginning of the 3rd century we find a forward movement in south-west Germany among a group of tribes known collectively as Alamanni (*q.v.*) who came in conflict with the emperor Caracalla in the year 213. About the same time the Goths also made their first appearance in the south-east and soon became the most formidable antagonists of Rome. In the year 251 they defeated and slew the emperor Decius, and in the reign of Gallienus their fleets setting out from the north of the Black Sea worked great havoc on the coast of the Aegean (see *GOths*). It is not to be supposed, however, that they had quitted their own lands on the Vistula by this time. In this connexion we hear also of the Heruli (*q.v.*), who some twenty years later, about 280, make their appearance in the western seas. In 286 we hear for the first time of maritime raids by the Saxons in the same quarter. About the middle of the 3rd century the name Franks (*q.v.*) makes its first appearance, apparently a new collective term for the tribes of north-west Germany from the Chatti to the mouth of the Rhine.

In the 4th century the chief powers in western Germany were the Franks and the Alamanni, both of whom were in constant conflict with the Romans. The former were pressed in their rear by the Saxons, who at some time before the middle of the 4th century appear to have invaded and conquered a considerable part of north-west Germany. About the same time great national movements seem to have been taking place farther east. The Burgundians made their appearance in the west shortly before the end of the 3rd century, settling in the basin of the Main, and it is probable that some portions of the north Suebic peoples, perhaps the ancient Semnones, had already moved westward. By the middle of the 4th century the Goths had become the dominant power in eastern Germany, and their King Hermanaric held a supremacy which seems to have stretched from the Black Sea to Holstein. At his death, however, the supremacy of eastern Germany passed to the Huns, an invading people from the east, whose arrival seems to have produced a complete displacement of

population in this region. With regard to the course of events in eastern Germany we have no knowledge, but during the 5th century several of the peoples previously settled there appear to have made their way into the lands south of the Carpathians and Riesengebirge, amongst whom (besides the Goths) may be especially mentioned the Rugii and the Gepides, the latter perhaps originally a branch of the Goths. According to tradition the Vandals had been driven into Pannonia by the Goths in the time of Constantine. We do not know how far northward the Hunnish power reached in the time of Attila, but the invasion of this nation was soon followed by a great westward movement of the Slavs.

In the west the Alamanni and the descendants of the Marcomanni, now called Baiouarii (Bavarians), had broken through the frontiers of the Roman provinces of Vindelicia and Noricum at the beginning of the 5th century, while the Vandals together with some of the Suebi and the non-Teutonic Alani from the east crossed the Rhine and invaded Gaul in 406. About 435-440 the Burgundians were overthrown by Attila, and their king Guntharicus (Gundahar) killed. The remains of the nation shortly afterwards settled in Gaul. About the same time the Franks overran and occupied the modern Belgium, and in the course of the next half-century their dominions were enormously extended towards the south (see *FRANKS*). After the death of Attila in 453 the power of the Huns soon collapsed, but the political divisions of Germany in the ensuing period are far from clear.

In the 6th century the predominant peoples are the Franks, Frisians, Saxons, Alamanni, Bavarians, Langobardi, Heruli and Warni. By the beginning of this century the Saxons seem to have penetrated almost, if not quite, to the Rhine in the Netherlands. Farther south, however, the old land of the Chatti was included in the kingdom of Clovis. Northern Bavaria was occupied by the Franks, whose king Clovis subdued the Alamanni in 495. To the east of the Franks between the Harz, the Elbe and the Saale lay the kingdom of the Thuringi, the origin of whom is not clear. The Heruli also had a powerful kingdom, probably in the basin of the Elbe, and to the east of them were the Langobardi. The Warni apparently now dwelt in the regions about the mouth of the Elbe, while the whole coast from the mouth of the Weser to the west Scheldt was in the hands of the Frisians. By this time all the country east of the lower Elbe seems to have been Slavonic. In the north, perhaps in the province of Schleswig, we hear now for the first time of the Danes. Theodorich, king of the Ostrogoths, endeavoured to form a confederacy with the Thuringi, Heruli and Warni against Clovis in order to protect the Visigoths in the early years of the 6th century, but very shortly afterwards the king of the Heruli was slain by the Langobardi and their existence as an independent power came to an end. In 531 the Thuringian kingdom was destroyed by the Frankish king Theodorich, son of Clovis, with whom the Saxons were in alliance.

During the 6th and 7th centuries the Saxons were intermittently under Frankish supremacy, but their conquest was not complete until the time of Charlemagne. Shortly after the middle of the 6th century the Franks were threatened with a new invasion by the Avars. In 567-568 the Langobardi, who by this time had moved into the Danube basin, invaded Italy and were followed by those of the Saxons who had settled in Thuringia. Their lands were given by the Frankish king Sigeberht to the north Suebi and other tribes who had come either from the Elbe basin or possibly from the Netherlands. About the same time Sigeberht was defeated by the Avars, and though the latter soon withdrew from the Frankish frontiers, their course was followed by a movement of the Slavs, who occupied the basin of the Elster and penetrated to that of the Main.

By the end of the 6th century the whole basin of the Elbe except the Saxon territory near the mouth had probably become Slavonic. To the east of the Saale were the Sorbs (Sorabi), and beyond them the Daleminci and Siusii. To the east of the

The Alamanni, the Goths and the Franks.

Arrival of the Huns.

The Burgundians and other tribes.

The Franks and others in the 6th century.

The Saxons and the Franks.

appear in Franconia, Bavaria, Swabia and Lorraine. These dukes acquired large tracts of land of which they gave grants on conditions of military service to persons on whom they could rely; while many independent landowners sought their protection on terms of vassalage. The same process took place in the case of great numbers of freemen of a lower class, who put themselves at the service of their more powerful neighbours in return for protection. In this manner the feudal tenure of land began to prevail in almost all parts of Germany, and the elaborate social system which became known as feudalism was gradually built up. The dukes became virtually independent, and when Louis the Child died in 911, the royal authority existed in name only.

While Louis the Child lived the German dukes were virtually kings in their duchies, and their natural tendency was to make themselves absolute rulers. But, threatened as they were by the Magyars, with the Slavs and Northmen always ready to take advantage of their weakness, they could not afford to do without a central government. Accordingly the nobles assembled at Forchheim, and by the advice of Otto the Illustrious, duke of Saxony, Conrad of Franconia was chosen German king. The dukes of Bavaria, Swabia and Lorraine were displeased at this election, probably because Conrad was likely to prove considerably more powerful than they wished. Rather than acknowledge him, the duke of Lotharingia, or Lorraine, transferred his allegiance to Charles the Simple of France; and it was in vain that Conrad protested and despatched armies into Lorraine. With the help of the French king the duke maintained his ground, and for the time his country was lost to Germany. Bavaria and Swabia yielded, but, mainly through the fault of the king himself, their submission was of brief duration. The rise of the dukes had been watched with extreme jealousy by the leading prelates. They saw that the independence they had hitherto enjoyed would be much more imperilled by powerful local governors than by a sovereign who necessarily regarded it as part of his duty to protect the church. Hence they had done everything they could to prevent the dukes from extending their authority, and as the government was carried on during the reign of Louis the Child mainly by Hatto I., archbishop of Mainz, they had been able to throw considerable obstacles in the way of their rivals. They had now induced Conrad to quarrel with both Swabia and Bavaria, and also with Henry, duke of Saxony, son of the duke to whom he chiefly owed his crown. In these contests the German king met with indifferent success, but the struggle with Saxony was not very serious, and when dying in December 919 Conrad recommended the Franconian nobles to offer the crown to Henry, the only man who could cope with the anarchy by which he had himself been baffled.

The nobles of Franconia acted upon the advice of their king, and the Saxons were very willing that their duke should rise to still higher honours. Henry I., called "the Fowler," who was chosen German king in May 919, was one of the best of German kings, and was a born statesman and warrior. His ambition was of the noblest order, for he sank his personal interests in the cause of his country, and he knew exactly when to attain his objects by force, and when by concession and moderation. Almost immediately he overcame the opposition of the dukes of Swabia and Bavaria; some time later, taking advantage of the troubled state of France, he accepted the homage of the duke of Lorraine, which for many centuries afterwards remained a part of the German kingdom.

Having established internal order, Henry was able to turn to matters of more pressing moment. In the first year of his reign the Magyars, who had continued to scourge Germany during the reign of Conrad, broke into Saxony and plundered the land almost without hindrance. In 924 they returned, and this time by good fortune one of their greatest princes fell into the hands of the Germans. Henry restored him to his countrymen on condition that they made a truce for nine years; and he promised to pay yearly tribute during this period. The barbarians accepted his terms, and faithfully kept their word in regard to Henry's own

lands, although Bavaria, Swabia and Franconia they occasionally invaded as before. The king made admirable use of the opportunity he had secured, confining his efforts, however, to Saxony and Thuringia, the only parts of Germany over which he had any control.

In the southern and western German lands towns and fortified places had long existed; but in the north, where Roman influence had only been feeble, and where even the Franks had not exercised much authority until the time of Charlemagne, the people still lived as in ancient times, either on solitary farms or in exposed villages. Henry saw that, while this state of things lasted, the population could never be safe, and began the construction of fortresses and walled towns. Of every group of nine men one was compelled to devote himself to this work, while the remaining eight cultivated his fields and allowed a third of their produce to be stored against times of trouble. The necessities of military discipline were also a subject of attention. Hitherto the Germans had fought mainly on foot, and, as the Magyars came on horseback, the nation was placed at an immense disadvantage. A powerful force of cavalry was now raised, while at the same time the infantry were drilled in new and more effective modes of fighting. Although these preparations were carried on directly under Henry's supervision, only in Saxony and Thuringia the neighbouring dukes were stimulated to follow his example. When he was ready he used his new troops, before turning them against their chief enemy, the Magyars, to punish refractory Slavonic tribes; and he brought under temporary subjection nearly all the Slavs between the Elbe and the Oder. He proceeded also against the Bohemians, whose duke was compelled to do homage.

The truce with the Magyars was not renewed, whereupon in 933 a body of invaders crossed, as in former years, the frontier of Thuringia. Henry prudently waited until dearth of provisions forced the enemy to divide into two bands. He then swept down upon the weaker force, annihilated it, and rapidly advanced against the remaining portion of the army. The second battle was more severe than the first, but not less decisive. The Magyars, unable to cope with a disciplined army, were cut down in great numbers, and those who survived rode in terror from the field. The exact scenes of these conflicts are not known, although the date of the second encounter was the 15th of March 933; but few more important battles have ever been fought. The power of the Magyars was not indeed destroyed, but it was crippled, and the way was prepared for the effective liberation of Germany from an intolerable plague. While the Magyars had been troubling Germany on the east and south, the Danes had been irritating her on the north. Charlemagne had established a march between the Eider and the Schlei; but in course of time the Danes had not only seized this territory, but had driven the German population beyond the Elbe. The Saxons had been slowly reconquering the lost ground, and now Henry, advancing with his victorious army into Jutland, forced Gorm, the Danish king, to become his vassal and regained the land between the Eider and the Schlei. But Henry's work concerned the duchy of Saxony rather than the kingdom of Germany. He concentrated all his energies on the government and defence of northern and eastern Germany, leaving the southern and western districts to profit by his example, while his policy of refraining from interference in the affairs of the other duchies tended to diminish the ill-feeling which existed between the various German tribes and to bring peace to the country as a whole. It is in these directions that the reign of Henry the Fowler marks a stage in the history of Germany.

When this great king died in July 936 every land inhabited by a German population formed part of the German kingdom, and none of the duchies were at war either with him or among themselves. Along the northern and eastern frontier were tributary races, and the country was for the time rid of an enemy which, for nearly a generation, had kept it in perpetual fear. Great as were these results, perhaps Henry did even greater service

Henry the Fowler.

Henry and the Magyars.

Henry's work in Saxony.

The Magyars return.



in beginning the growth of towns throughout north Germany. Not content with merely making them places of defence, he decreed that they should be centres for the administration of justice, and that in them should be held all public festivities and ceremonies; he also instituted markets, and encouraged traders to take advantage of the opportunities provided for them. A strong check was thus imposed upon the tendency of freemen to become the vassals of great lords. This movement had become so powerful by the troubles of the epoch that, had no other current of influence set in, the entire class of freemen must soon have disappeared. As they now knew that they could find protection without looking to a superior, they had less temptation to give up their independence, and many of them settled in the towns where they could be safe and free. Besides maintaining a manly spirit in the population, the towns rapidly added to their importance by the stimulus they gave to all kinds of industry and trade.

Before his death Henry obtained the promise of the nobles at a national assembly, or diet, at Erfurt to recognize his son

Otto as his successor, and the promise was kept, Otto being chosen German king in July 936. Otto I. the Great began his reign under the most favourable circumstances. He was twenty-four years of age, and at the coronation festival, which was held at Aix-la-Chapelle, the dukes performed for the first time the nominally menial offices known as the arch-offices of the German kingdom. But these peaceful relations soon came to an end. Reversing his father's policy, Otto resolved that the dukes should act in the strictest sense as his vassals, or lose their dignities. At the time of his coronation Germany was virtually a federal state; he wished to transform it into a firm and compact monarchy. This policy speedily led to a formidable rebellion, headed by Thankmar, the king's half-brother, a fierce warrior, who fancied that he had a prior claim to the crown, and who secured a number of followers in Saxony. He was joined by Eberhard, duke of Franconia, and it was only by the aid of the duke of Swabia, whom the duke of Franconia had offended, that the rising was put down. This happened in 938, and in 939 a second rebellion, led by Otto's brother Henry, was supported by the duke of Franconia and by Giselbert, duke of Lorraine. Otto again triumphed, and derived immense advantages from his success. The duchy of Franconia he kept in his own hands, and in 944 he granted Lorraine to Conrad the Red, an energetic and honourable count, whom he still further attached to himself by giving him his daughter for his wife. Bavaria, on the death of its duke in 947, was placed under his brother Henry, who, having been pardoned, had become a loyal subject. The duchy of Swabia was also brought into Otto's family by the marriage of his son Ludolf with Duke Hermann's daughter, and by these means Otto made himself master of the kingdom. For the time, feudalism in truth meant that lands and offices were held on condition of service; the king was the genuine ruler, not only of freemen, but of the highest vassals in the nation.

In the midst of these internal troubles Otto was attacked by the French king, Louis IV., who sought to regain Lorraine.

However, the German king was soon able to turn his arms against his new enemy; he marched into France and made peace with Louis in 942. Otto's subsequent interventions in the affairs of France were mainly directed towards making peace between Louis and his powerful and rebellious vassal, Hugh the Great, duke of the Franks, both of whom were married to sisters of the German king. Much more important than Otto's doings in France were his wars with his northern and eastern neighbours. The duke of Bohemia, after a long struggle, was brought to submission in 950. Among the Slavs between the Elbe and the Oder the king was represented by Margrave Gero, a warrior well fitted for the rough work he had to do, loyal to his sovereign, but capable of any treachery towards his enemies, who conquered much of the country north of Bohemia between the Oder and the upper and middle Elbe. Margrave Billung, who looked after the Abotrites on the lower Elbe, was less fortunate, mainly because

of the neighbourhood of the Danes, who, after the death of King Henry, often attacked the hated Germans, but some progress was made in bringing this district under German influence. Otto, having profound faith in the power of the church to reconcile conquered peoples to his rule, provided for the benefit of the Danes the bishoprics of Schleswig, Ripen and Aarhus; and among those which he established for the Slavs were the important bishoprics of Brandenburg and Havelberg. In his later years he set up the archbishopric of Magdeburg, which took in the sees of Meissen, Zeitz and Merseburg.

Having secured peace in Germany and begun the real conquest of the border races, Otto was by far the greatest sovereign in Europe; and, had he refused to go beyond the limits within which he had hitherto acted, it is probable that he would have established a united monarchy. But a decision to which he soon came deprived posterity of the results which might have sprung from the policy of his earlier years. About 951 Adelaide, widow of Lothair, son of Hugh, king of Italy, having refused to marry the son of Berengar, margrave of Ivrea, was cast into prison and cruelly treated. She appealed to Otto; other reasons called him in the same direction, and in 951 he crossed the Alps and descended into Lombardy. He displaced Berengar, and was so fascinated by Queen Adelaide that within a few weeks he was married to her at Pavia. But Otto's son, Ludolf, who had received a promise of the German crown, saw his rights threatened by this marriage. He went to an old enemy of his father, Frederick, archbishop of Mainz, and the two plotted together against the king, who, hearing of their proceedings, returned to Germany in 952, leaving Duke Conrad of Lorraine as his representative in Italy. Otto, who did not suspect how deep were the designs of the conspirators, paid a visit to Mainz, where he was seized and was compelled to take certain solemn pledges which, after his escape, he repudiated.

War broke out in 953, and the struggle was the most serious in which he had been engaged. In Lorraine, of which duchy Otto made his brother Bruno, archbishop of Cologne, administrator, his cause was triumphant; but everywhere else dark clouds gathered over his head. Conrad the Red hurried from Italy and joined the rebels; in Swabia, in Bavaria, in Franconia and even in Saxony, the native land of the king, many sided with them. It is extremely remarkable that this movement acquired so quickly such force and volume. The explanation, according to some historians, is that the people looked forward with alarm to the union of Germany with Italy. There were still traditions of the hardships inflicted upon the common folk by the expeditions of Charlemagne, and it is supposed that they anticipated similar evils in the event of his empire being restored. Whether or not this be the true explanation, the power of Otto was shaken to its foundations. At last he was saved by the presence of an immense external peril. The Magyars were as usual stimulated to action by the disunion of their enemies; and Conrad and Ludolf made the blunder of inviting their help, a proceeding which disgusted the Germans, many of whom fell away from their side and rallied to the head and protector of the nation. In a very short time Conrad and the archbishop of Mainz submitted, and although Ludolf held out a little longer he soon asked for pardon. Lorraine was given to Bruno; but Conrad, its former duke, although thus punished, was not disgraced, for Otto needed his services in the war with the Magyars. The great battle against these foes was fought on the 10th of August 955 on the Lechfeld near Augsburg. After a fierce and obstinate fight, in which Conrad and many other nobles fell, the Germans were victorious; the Magyars were even more thoroughly scourged than in the battles in which Otto's father had given them their first real check. The deliverance of Germany was complete, and from this time, notwithstanding certain wild raids towards the east, the Magyars began to settle in the land they still occupy, and to adapt themselves to the conditions of civilized life.

Entreated by Pope John XII., who needed a helper against

The growth of towns.

Otto the Great.

Otto in Italy.

The civil war.

Otto's wars with France and with the Slavs.

Defeat of Magyars.

Berengar, Otto went a second time to Italy, in 961; and on this occasion he received from the pope at Rome the imperial crown. In 966 he was again in Italy, where he remained six years, exercising to the full his imperial rights in regard to the papacy, but occupied mainly in an attempt to make himself master of the southern, as well as of the northern half of the peninsula.

By far the most important act of Otto's eventful life was his assumption of the Lombard and the imperial crowns. His successors steadily followed his example, and the sovereign crowned at Aix-la-Chapelle claimed as his right coronation by the pope in Rome. Thus grew up the Holy Roman Empire, that strange state which, directly descending through the empire of Charlemagne from the empire of the Caesars, contained so many elements foreign to ancient life. We are here concerned with it only as it affected Germany. Germany itself never until our own day became an empire. It is true that at last the Holy Roman Empire was in reality confined to Germany; but in theory it was something quite different. Like France, Germany was a kingdom, but it differed from France in this, that its king was also king in Italy and Roman emperor. As the latter title made him nominally the secular lord of the world, it might have been expected to excite the pride of his German subjects; and doubtless, after a time, they did learn to think highly of themselves as the imperial race. But the evidence tends to show that at first at least they had no wish for this honour, and would have preferred their ruler to devote himself entirely to his own people.

There are signs that during Otto's reign they began to have a distinct consciousness of national life, their use of the word "deutsch" to indicate the whole people being one of these symptoms. Their common sufferings, struggles and triumphs, however, account far more readily for this feeling than the supposition that they were elated by their king undertaking obligations which took him for years together away from his native land. So solemn were the associations of the imperial title that, after acquiring it, Otto probably looked for more intimate obedience from his subjects. They were willing enough to admit the abstract claims of the Empire; but in the world of feudalism there was a multitude of established customs and rights which rudely conflicted with these claims, and in action, remote and abstract considerations gave way before concrete and present realities. Instead of strengthening the allegiance of the Germans towards their sovereign, the imperial title was the means of steadily undermining it. To the connexion of their kingdom with the Empire they owe the fact that for centuries they were the most divided of European nations, and that they have only recently begun to create a genuinely united state. France was made up of a number of loosely connected lands, each with its own lord, when Germany, under Otto, was to a large extent moved by a single will, well organized and strong. But the attention of the French kings was concentrated on their immediate interests, and in course of time they brought their unruly vassals to order. The German kings, as emperors, had duties which often took them away for long periods from Germany. This alone would have shaken their authority, for, during their absence, the great vassals seized rights which were afterwards difficult to recover. But the emperors were not merely absent, they had to engage in struggles in which they exhausted the energies necessary to enforce obedience at home; and, in order to obtain help, they were sometimes glad to concede advantages to which, under other conditions, they would have tenaciously clung. Moreover, the greatest of all their struggles was with the papacy; so that a power outside their kingdom, but exercising immense influence within it, was in the end always prepared to weaken them by exciting dissension among their people. Thus the imperial crown was the most fatal gift that could have been offered to the German kings; apparently giving them all things, it deprived them of nearly everything. And in doing this it inflicted on many generations incalculable and needless suffering.

By the policy of his later years Otto did much to prepare the way for the process of disintegration which he rendered inevitable by restoring the Empire. With the kingdom divided into five great duchies, the sovereign could always have maintained at least so much unity as Henry the Fowler secured; and, as the experience of Otto himself showed, there would have been chances of much greater centralization. Yet he threw away this advantage. Lorraine was divided into two duchies, Upper Lorraine and Lower Lorraine. In each duchy of the kingdom he appointed a count palatine, whose duty was to maintain the royal rights; and after Margrave Gero died in 965 his territory was divided into three marches, and placed under margraves, each with the same powers as Gero. Otto gave up the practice of retaining the duchies either in his own hands or in those of relatives. Even Saxony, his native duchy and the chief source of his strength, was given to Margrave Billung, whose family kept it for many years. To combat the power of the princes, Otto, especially after he became emperor and looked upon himself as the protector of the church, immensely increased the importance of the prelates. They received great gifts of land, were endowed with jurisdiction in criminal as well as civil cases, and obtained several other valuable sovereign rights. The emperor's idea was that, as church lands and offices could not be hereditary, their holders would necessarily favour the crown. But he forgot that the church had a head outside Germany, and that the passion for the rights of an order may be not less intense than that for the rights of a family. While the Empire was at peace with the popes the prelates did strongly uphold it, and their influence was unquestionably, on the whole, higher than that of rude secular nobles. But with the Empire and the Papacy in conflict, they could not but abide, as a rule, by the authority which had the most sacred claims to their loyalty. From all these circumstances it curiously happened that the sovereign who did more than almost any other to raise the royal power, was also the sovereign who, more than any other, wrought its decay.

Otto II. had been crowned German king at Aix-la-Chapelle and emperor at Rome during his father's lifetime. Becoming sole ruler in May 973, his troubles began in Lorraine, but were more serious in Bavaria, which was now a very important duchy. Its duke, Henry, the brother of Otto I., had died in 955 and had been succeeded by a young son, Henry, whose turbulent career subsequently induced the Bavarian historian Aventinus to describe him as *rixosus*, or the Quarrelsome. In 973 Burchard II., duke of Swabia, died, and the new emperor refused to give this duchy to Henry, further irritating this duke by bestowing it upon his enemy, Otto, a grandson of the emperor Otto I. Having collected allies Henry rebelled, and in 976 the emperor himself marched against him and drove him into Bohemia. Bavaria was taken from him and given to Otto of Swabia, but it was deprived of some of its importance. The southern part, Carinthia, which had hitherto been a march district, was separated from it and made into a duchy, and the church in Bavaria was made dependent upon the king and not upon the duke. Having arrived at this settlement Otto marched against the Bohemians, but while he was away from Germany war was begun against him by Henry, the new duke of Carinthia, who, forgetting the benefits he had just received, rose to avenge the wrongs of his friend, the deposed duke Henry of Bavaria. The emperor made peace with the Bohemians and quickly put down the rising. Henry of Bavaria was handed over to the keeping of the bishop of Utrecht and Carinthia received another duke.

In his anxiety to obtain possession of southern Italy, Otto I. had secured as a wife for his son and successor Theophano, daughter of the East Roman emperor, Romanus II., the ruler of much of southern Italy. Otto II., having all his father's ambition with much of his strength and haughtiness, longed to get away from Germany and to claim these remoter districts. But he was detained for some time owing to the sudden invasion of Lower Lorraine by Lothair, king of France, in 978. So stealthily did the invader

Otto crowned emperor.

Connexion of Germany with the Empire.

Otto and the duchies.

Otto II.

Otto and France.

advance that the emperor had only just time to escape from Aix-la-Chapelle before the town was seized and plundered. As quickly as possible Otto placed himself at the head of a great army and marched to Paris, but he was compelled to retreat without taking the city, and in 980 peace was made.

At last, after an expedition against the Poles, Otto was able to fulfil the wish of his heart; he went to Italy in 980 and never returned to Germany. His claims to southern Italy were vehemently opposed, and in July 982 he suffered a disastrous defeat at the hands of the East Roman emperor's subjects and their Saracen allies. The news of this crushing blow cast a gloom over Germany, which was again suffering from the attacks of her unruly neighbours. The Saxons were able to cope with the Danes and the German boundary was pushed forward in the south-east; but the Slavs fought with such courage and success that during the reigns of the emperors Otto II. and Otto III. much of the work effected by the margraves Hermann Billung and Gero was undone, and nearly two centuries passed before they were driven back to the position which they had perforce occupied under Otto the Great. Such were the first-fruits of the assumption of the imperial crown.

About six months before his death in Rome, in December 983, Otto held a diet at Verona which was attended by many of the German princes, who recognized his infant son Otto as his successor. Otto was then taken to Germany, and after his father's death he was crowned at Aix-la-Chapelle on Christmas Day 983. Henry of Bavaria was released from his confinement and became his guardian; but as this restless prince showed an inclination to secure the crown for himself, the young king was taken from him and placed in the care of his mother Theophano. Henry, however, gained a good deal of support both within and without Germany and caused much anxiety to Otto's friends, but in 985 peace was made and he was restored to Bavaria. While Theophano acted as regent, the chief functions of government were discharged by Willigis, archbishop of Mainz (d. 1011), a vigorous prelate who had risen from a humble rank to the highest position in the German Church. He was aided by the princes, each of whom claimed a voice in the administration, and, during the lifetime of Theophano at least, a stubborn and sometimes a successful resistance was offered to the attacks of the Slavs. But under the prevalent conditions a vigorous rule was impossible, and during Otto's minority the royal authority was greatly weakened. In Saxony the people were quickly forgetting their hereditary connexion with the successors of Henry the Fowler; in Bavaria, after the death of Duke Henry in 995, the nobles, heedless of the royal power, returned to the ancient German custom and chose Henry's son Henry as their ruler.

In 995 Otto III. was declared to have reached his majority. He had been so carefully trained in all the learning of the time that he was called the "wonder of the world," and a certain fascination still belongs to his imaginative and fantastic nature. Imbued by his mother with the extravagant ideas of the East Roman emperors he introduced into his court an amount of splendour and ceremonial hitherto unknown in western Europe. The heir of the western emperors and the grandson of an eastern emperor, he spent most of his time in Rome, and fancied he could unite the world under his rule. In this vague design he was encouraged by Gerbert, the greatest scholar of the day, whom, as Silvester II., he raised to the papal throne. Meanwhile Germany was suffering severely from internal disorders and from the inroads of her rude neighbours; and when in the year 1000 Otto visited his northern kingdom there were hopes that he would smite these enemies with the vigour of his predecessors. But these hopes were disappointed; on the contrary, Otto seems to have released Boleslaus, duke of the Poles, from his vague allegiance to the German kings, and he founded an archbishopric at Gnesen, thus freeing the Polish sees from the authority of the archbishop of Magdeburg.

The character of Otto.

When Otto III. died in January 1002 there remained no representative of the elder branch of the imperial family, and several candidates came forward for the vacant throne. Among these candidates was Henry of Bavaria, son of Duke Henry the Quarrelsome and a great-grandson of Henry the Fowler, and at Mainz in June 1002 this prince was chosen German king as Henry II. Having been recognized as king by the Saxons, the Thuringians and the nobles of Lorraine, the new king was able to turn his attention to the affairs of government, but on the whole his reign was an unfortunate one for Germany. For ten years civil war raged in Lorraine; in Saxony much blood was shed in petty quarrels; and Henry made expeditions against his turbulent vassals in Flanders and Friesland. He also interfered in the affairs of Burgundy, but the acquisition of this kingdom was the work of his successor, Conrad II. During nearly the whole of this reign the Germans were fighting the Poles. Boleslaus of Poland, who was now a very powerful sovereign, having conquered Lusatia and Silesia, brought Bohemia also under his rule and was soon at variance with the German king. Anxious to regain these lands Henry allied himself with some Slavonic tribes, promising not to interfere with the exercise of their heathen religion, while Boleslaus found supporters among the discontented German nobles. The honours of the ensuing war were with Henry, and when peace was made in 1006 Boleslaus gave up Bohemia, but the struggle was soon renewed and neither side had gained any serious advantage when peace was again made in 1013. A third Polish war broke out in 1015. Henry led his troops in person and obtained assistance from the Russians and the Hungarians; peace was concluded in 1018, the Elbe remaining the north-east boundary of Germany. Henry made three journeys to Italy, being crowned king of the Lombards at Pavia in 1004 and emperor at Rome ten years later. Before the latter event, in order to assert his right of sovereignty over Rome, he called himself king of the Romans, a designation which henceforth was borne by his successors until they received the higher title from the pope. Hitherto a sovereign crowned at Aix-la-Chapelle had been "king of the West Franks," or "king of the Franks and Saxons." Henry was generous to the church, to which he looked for support, but he maintained the royal authority over the clergy. Although generally unsuccessful he strove hard for peace, and during this reign the principle of inheritance was virtually established with regard to German fiefs.

After Henry's death the nobles met at Kamba, near Oppenheim, and in September 1024 elected Conrad, a Franconian count, to the vacant throne. Although favoured by the German clergy the new king, Conrad II., had to face some opposition; this, however, quickly vanished and he received the homage of the nobles in the various duchies and seemed to have no reason to dread internal enemies. Nevertheless, he had soon to battle with a conspiracy headed by his stepson, Ernest II., duke of Swabia. This was caused primarily by Conrad's avowed desire to acquire the kingdom of Burgundy, but other reasons for dissatisfaction existed, and the revolting duke found it easy to gather around him the scattered forces of discontent. However, the king was quite able to deal with the rising, which, indeed, never attained serious proportions, although Ernest gave continual trouble until his death in 1030. With regard to the German duchies Conrad followed the policy of Otto the Great. He wished to control, not to abolish them. In 1026, when Duke Henry of Bavaria died, he obtained the duchy for his son Henry, afterwards the emperor Henry III.; later, despite the opposition of the nobles, he invested the same prince with Swabia, where the ducal family had died out. Franconia was in the hands of Conrad himself; thus Saxony, Thuringia, Carinthia and Lorraine were the only duchies not completely dependent upon the king.

When Conrad ascended the throne the safety of Germany was endangered from three different points. On the north was Denmark ruled by Canute the Great; on the east was the wide Polish state whose ruler, Boleslaus, had just taken the title of king; and on the south-east was Hungary, which under its king,

St Stephen, was rapidly becoming an organized and formidable power. Peace was maintained with Canute, and in 1035 a treaty was concluded and the land between the Eider and the Schlei was ceded to Denmark. In 1030 Conrad waged a short war against Hungary, but here also he was obliged to assent to a cession of territory. In Poland he was more fortunate. After the death of Boleslaus in 1025 the Poles plunged into a civil war, and Conrad was able to turn this to his own advantage. In 1031 he recovered Lusatia and other districts, and in 1033 the Polish duke of Mesislaus did homage to him at Merseburg. His authority was recognized by the Bohemians, and two expeditions taught the Slavonic tribes between the Elbe and the Oder to respect his power.

In Italy, whither he journeyed in 1026 and 1036, Conrad was not welcomed. Although as emperor and as king of the Lombards he was the lawful sovereign of that country, the Germans were still regarded as intruders and could only maintain their rights by force. The event which threw the greatest lustre upon this reign was the acquisition of the kingdom of Burgundy, or Arles, which was bequeathed to Conrad by its king, Rudolph III., the uncle of his wife, Gisela. Rudolph died in 1032, and in 1033 Conrad was crowned king at Peterlingen, being at once recognized by the German-speaking population. For about two years his rival, Odo, count of Champagne, who was supported by the Romance-speaking inhabitants, kept up the struggle against him, but eventually all opposition was overcome and the possession of Burgundy was assured to the German king.

This reign is important in the history of Germany because it marks the beginning of the great imperial age, but it has other features of interest. In dealing with the revolt of Ernest of Swabia Conrad was aided by the reluctance of the vassals of the great lords to follow them against the king. This reluctance was due largely to the increasing independence of this class of landholders, who were beginning to learn that the sovereign, and not their immediate lord, was the protector of their liberties; the independence in its turn arose from the growth of the principle of heredity. In Germany Conrad did not definitely decree that fiefs should pass from father to son, but he encouraged and took advantage of the tendency in this direction, a tendency which was, obviously, a serious blow at the power of the great lords over their vassals. In 1037 he issued from Milan his famous edict for the kingdom of Italy which decreed that upon the death of a landholder his fief should descend to his son, or grandson, and that no fiefholder should be deprived of his fief without the judgment of his peers. In another direction Conrad's policy was to free himself as king from dependence upon the church. He sought to regain lands granted to the church by his predecessors; prelates were employed on public business much less frequently than heretofore. He kept a firm hand over the church, but his rule was purely secular; he took little or no interest in ecclesiastical affairs. During this reign the centre and basis of the imperial power in Germany was moved southwards. Saxony, the home of the Ottos, became less prominent in German politics, while Bavaria and the south were gradually gaining in importance.

Henry III., who had been crowned German king and also king of Burgundy during his father's lifetime, took possession of his great inheritance without the slightest sign of opposition in June 1039. He was without the impulsiveness which marred Conrad's great qualities, but he had the same decisive judgment, wide ambition and irresistible will as his father. During the late king's concluding years a certain Bretislaus, who had served Conrad with distinction in Lusatia, became duke of Bohemia and made war upon the disunited Poles, easily bringing them into subjection. Thus Germany was again threatened with the establishment of a great and independent Slavonic state upon her eastern frontier. To combat this danger Henry invaded Bohemia, and after two reverses compelled Bretislaus to appear before him as a suppliant at Regensburg. The German king treated his foe generously and was rewarded by receiving to the end of his reign the service

of a loyal vassal; he also gained the goodwill of the Poles by helping to bring about the return of their duke, Casimir I., who willingly did homage for his land. The king of Denmark, too, acknowledged Henry as his feudal lord. Moreover, by several campaigns in Hungary the German king brought that country into the position of a fief of the German crown. This war was occasioned by the violence of the Hungarian usurper, Aba Samuel, and formed Henry's principal occupation from 1041 to 1045.

In Germany itself Henry acquired, during the first ten years of his rule, an authority which had been unknown since the days of Otto the Great. Early in his reign he had made a determined enemy of Godfrey the Bearded, duke of upper Lorraine, who, in 1044, conspired against him and who found powerful allies in Henry I., king of France, in the counts of Flanders and Holland, and in certain Burgundian nobles. However, Godfrey and his friends were easily worsted, and when the dispossessed duke again tried the fortune of war he found that the German king had detached Henry of France from his side and was also in alliance with the English king, Edward the Confessor. While thus maintaining his authority in the north-east corner of the country by alliances and expeditions, Henry was strong enough to put the laws in motion against the most powerful princes and to force them to keep the public peace. Under his severe but beneficent rule, Germany enjoyed a period of internal quiet such as she had probably never experienced before, but even Henry could not permanently divert from its course the main political tendency of the age, the desire of the great feudal lords for independence.

Cowed, but unpacified and discontented, the princes awaited their opportunity, while the king played into their hands by allowing the southern duchies, Swabia, Bavaria and Carinthia, to pass from under his own immediate control. His position was becoming gradually weaker when in 1051 he invaded Hungary, where a reaction against German influence was taking place. After a second campaign in 1052 the Hungarian king, Andrew, was compelled to make peace and to own himself the vassal of the German king. Meanwhile Saxony and Bavaria were permeated by the spirit of unrest, and Henry returned from Hungary just in time to frustrate a widespread conspiracy against him in southern Germany. Encouraged by the support of the German rebels, Andrew of Hungary repudiated the treaty of peace and the German supremacy in that country came to a sudden end. Among the causes which undermined Henry's strength was the fact that the mediate nobles, who had stood loyally by his father, Conrad, were not his friends; probably his wars made serious demands upon them, and his strict administration of justice, especially his insistence upon the maintenance of the public peace, was displeasing to them.

At the beginning of Henry's reign the church all over Europe was in a deplorable condition. Simony was universally practised and the morality of the clergy was very low. The Papacy, too, had sunk to a degraded condition and its authority was annihilated, not only by the character of successive popes, but by the fact that there were at the same time three claimants for the papal throne. Henry, a man of deep, sincere and even rigorous piety, regarded these evils with sorrow; he associated himself definitely with the movement for reform which proceeded from Cluny, and commanded his prelates to put an end to simony and other abuses. Then moving farther in the same direction he resolved to strike at the root of the evil by the exercise of his imperial authority. In 1046 he entered Italy at the head of an army which secured for him greater respect than had been given to any German ruler since Charlemagne, and at Sutri and in Rome he deposed the three rival popes. He then raised to the papal see Suidger, bishop of Bamberg, who, as Pope Clement II., crowned him emperor; after Clement three other German popes—Damasus II., Leo IX. and Victor II.—owed their elevation to Henry. Under these popes a new era began for the church, and in thus reforming the Papacy Henry III. fulfilled what was regarded as the noblest duty of his imperial office, but he also

*The
neigh-
bouring
countries.*

*Conrad in
Italy.*

*The
nobles
and the
land.*

*Henry's
internal
policy.*

*Henry's
wars.*

*Henry
and the
church.*

sharpened a weapon whose keen edge was first tried against his son.

The last years of Henry III. form a turning-point in German history. Great kings and emperors came after him, but none of them possessed the direct, absolute authority which he freely wielded; even in the case of the strongest the forms of feudalism more and more interposed themselves between the monarch and the nation, and at last the royal authority virtually disappeared. During this reign the towns entered upon an age of prosperity, and the Rhine and the Weser became great avenues of trade.

When Henry died in October 1056 the decline of the royal authority was accelerated by the fact that his successor was a child. Henry IV., who had been crowned king in 1054, was at first in charge of his mother, the empress Agnes, whose weak and inefficient rule was closely watched by Anno, archbishop of Cologne. In 1062, however, Anno and other prominent prelates and laymen, perhaps jealous of the influence exercised at court by Henry, bishop of Augsburg (d. 1063), managed by a clever trick to get possession of the king's person. Deserted by her friends Agnes retired, and forthwith Anno began to rule the state. But soon he was compelled to share his duties with Adalbert, archbishop of Bremen, and a year or two later Adalbert became virtually the ruler of Germany, leaving Anno to attend to affairs in Italy. Adalbert's rule was very successful. Compelling King Solomon to own Henry's supremacy he restored the influence of Germany in Hungary; in internal affairs he restrained the turbulence of the princes, but he made many enemies, especially in Saxony, and in 1066 Henry, who had just been declared of age, was compelled to dismiss him. The ambitious prelate, however, had gained great influence over Henry, who had grown up under the most diverse influences. The young king was generous and was endowed with considerable intellectual gifts; but passing as he did from Anno's gloomy palace at Cologne to Adalbert's residence in Bremen, where he was petted and flattered, he became wayward and wilful.

Henry IV. assumed the duties of government soon after the fall of Adalbert and quickly made enemies of many of the chief princes, including Otto of Nordheim, the powerful duke of Bavaria, Rudolph, duke of Swabia, and Berthold of Zähringen, duke of Carinthia. In Saxony, where, like his father, he frequently held his court, he excited intense hostility by a series of injudicious proceedings. While the three Ottos were pursuing the shadow of imperial greatness in Italy, much of the crown land in this duchy had been seized by the nobles and was now held by their descendants. Henry IV. insisted on the restoration of these estates and encroached upon the rights of the peasants. Moreover, he built a number of forts which the people thought were intended for prisons; he filled the land with riotous and overbearing Swabians; he kept in prison Magnus, the heir to the duchy; and is said to have spoken of the Saxons in a tone of great contempt. All classes were thus combined against him, and when he ordered his forces to assemble for a campaign against the Poles the Saxons refused to join the host. In 1073 the universal discontent found expression in a great assembly at Wormesleben, in which the leading part was taken by Otto of Nordheim, by Werner, archbishop of Magdeburg, and by Burkhard II., bishop of Halberstadt. Under Otto's leadership the Thuringians joined the rising, which soon spread far and wide. Henry was surprised by a band of rebels in his fortress at the Harzburg; he fled to Hersfeld and appealed to the princes for support, but he could not compel them to aid him and they would grant him nothing. After tedious negotiations he was obliged to yield to the demands of his enemies, and peace was made at Gerstungen in 1074. Zealously carrying out the conditions of the peace, the peasants not only battered down the detested forts, they even destroyed the chapel at the Harzburg and committed other acts of desecration. These proceedings alarmed the princes, both spiritual and secular, and Henry, who had gained support from the cities of the Rhineland, was able to advance with a formidable army

into Saxony in 1075. He gained a decisive victory, rebuilt the forts and completely restored the authority of the crown.

In 1073, while Germany was in this confused state, Hildebrand had become pope as Gregory VII., and in 1075 he issued his famous decree against the marriage of the clergy and against their investiture by laymen. To the latter decree it was impossible for any sovereign to submit, and in Germany there were stronger reasons than elsewhere for resistance. A large part of the land of the country was held by the clergy, and most of it had been granted to them because it was supposed that they would be the king's most efficient helpers. Were the feudal tie broken, the crown must soon vanish, and the constitution of medieval society undergo a radical change. Henry, who hitherto had treated the new pope with excessive respect, now announced his intention of going to Rome and assuming the imperial title. The pope, to whom the Saxons had been encouraged to complain, responded by sending back certain of Henry's messengers, with the command that the king should do penance for the crimes of which his subjects accused him. Enraged by this unexpected arrogance, Henry summoned a synod of German bishops to Worms in January 1076, and Hildebrand was declared deposed. The papal answer was a bull excommunicating the German king, dethroning him and liberating his subjects from their oath of allegiance.

Never before had a pope ventured to take so bold a step. It was within the memory even of young men that a German king had dismissed three popes, and had raised in turn four of his own prelates to the Roman see. And now a pope attempted to drag from his throne the successor of this very sovereign. The effect of the bull was tremendous; no other was ever followed by equally important results. The princes had long been chafing under the royal power; they had shaken even so stern an autocrat as Henry III., and the authority of Henry IV. was already visibly weakened. At this important stage in their contest with the crown a mighty ally suddenly offered himself, and with indecent eagerness they hastened to associate themselves with him. Their vassals and subjects, appalled by the invisible powers wielded by the head of the church, supported them in their rebellion. The Saxons again rose in arms and Otto of Nordheim succeeded in uniting the North and South German supporters of the pope. Henry had looked for no such result as this; he did not understand the influences which lay beneath the surface and was horrified by his unexpected isolation. At a diet in Tribur he humbled himself before the princes, but in vain. They turned from him and decided that the pope should be asked to judge Henry; that if, within a year, the sentence of excommunication were not removed, the king should lose his crown; and that in the meantime he should live in retirement.

Next came the strange scene at Canossa which burned itself into the memory of Europe. For three days the representative of the Caesars entreated to be admitted into the pope's presence. No other mode of escape than complete subjection to Gregory had suggested itself, or was perhaps possible; but it did not save him. Although the pope forgave him, the German princes, resolved not to miss the chance which fortune had given them, met in March 1077, and deposed him, electing Rudolph, duke of Swabia, as his successor. But Henry's bitter humiliations transformed his character; they brought out all his latent capacities of manliness.

The war of investitures that followed was the opening of the tremendous struggle between the Empire and the Papacy, which is the central fact of medieval history and which, after two centuries of conflict, ended in the exhaustion of both powers. Its details belong more to the history of Italy than to that of Germany, where it took the form of a fight between two rival kings, but in Germany its effects were more deeply felt. The nation now plucked bitter fruit from the seed planted by Otto the Great in assuming the imperial crown and by a long line of kings and emperors in lavishing worldly power upon the church. In the

Pope
Gregory
VII.

The
minority
of Henry
IV.

Effect of
Henry's
excom-
municat-
ion.

Henry's
personal
rule.

Scene at
Canossa.

The
struggle
over in-
vestitures.

ambition of the spiritual and the secular princes the pope had an immensely powerful engine of offence against the emperor, and without the slightest scruple this was turned to the best advantage.

When this struggle began it may be said in general that Henry was supported by the cities and the lower classes, while Rudolph *Henry IV. and the anti-kings.* relied upon the princes and the opponents of a united Germany; or, to make another division, Henry's strength lay in the duchies of Franconia and Bavaria, Rudolph's in Swabia and Saxony. In the Rhineland and in southern Germany the cities had been steadily growing in wealth and power, and they could not fail to realize that they had more to fear from the princes than from the crown. Hence when Henry returned to Germany in 1078 Worms, Speirs and many other places opened their gates to him and contributed freely to his cause; nevertheless his troops were beaten in three encounters and Pope Gregory thundered anew against him in March 1080. However, the fortune of war soon turned, and in October 1080 Rudolph of Swabia was defeated and slain. Henry then carried the war into Italy; in 1084 he was crowned emperor in Rome by Wibert, archbishop of Ravenna, whom, as Clement III., he had set up as an anti-pope, and in 1085 Gregory died an exile from Rome. Meanwhile in Germany Henry's opponents had chosen Hermann, count of Luxemburg, king in succession to Rudolph of Swabia. Hermann, however, was not very successful, and when Henry returned to Germany in 1084 he found that his most doughty opponent, Otto of Nordheim, was dead, and that the anti-king had few friends outside Saxony. This duchy was soon reduced to obedience and was treated with consideration, and when the third anti-king, Egbert, margrave of Meissen, was murdered in 1090 there would have been peace if Germany had followed her own impulses.

In the Papacy, however, Henry had an implacable foe; and again and again when he seemed on the point of a complete triumph the smouldering embers of revolt were kindled once more into flame. In Italy his son, Conrad, was stirred up against him and in 1093 was crowned king at Monza; then ten years later, when Germany was more peaceful than it had been for years and when the emperor's authority was generally acknowledged, his second son, Henry, afterwards the emperor Henry V., was induced to head a dangerous rebellion. The Saxons and the Thuringians were soon in arms, and they were joined by those warlike spirits of Germany to whom an age of peace brought no glory and an age of prosperity brought no gain. After some desultory fighting Henry IV. was taken prisoner and compelled to abdicate; he had, however, escaped and had renewed the contest when he died in August 1106.

During this reign the first crusade took place, and the German king suffered severely from the pious zeal which it expressed and intensified. The movement was not in the end favourable to papal supremacy, but the early crusaders, and those who sympathized with them, regarded the enemies of the pope as the enemies of religion.

The early years of Henry V.'s reign were spent in campaigns in Flanders, Bohemia, Hungary and Poland, but the new king was soon reminded that the dispute over investitures was unsettled. Pope Paschal II. did not doubt, now that Henry IV. was dead, that he would speedily triumph; but he was soon undeceived. Henry V., who with unconscious irony had promised to treat the pope as a father, continued, like his predecessors, to invest prelates with the ring and the staff, and met the exhortations of Paschal by declaring that he would not surrender a right which had belonged to all former kings. Lengthened negotiations took place but they led to no satisfactory result, while the king's enemies in Germany, taking advantage of the deadlock, showed signs of revolt. One of the most ardent of these enemies was Lothair of Supplinburg, whom Henry himself had made duke of Saxony upon the extinction of the Billung family in 1106. *Lothair was humbled in 1112, but he took advantage of the*

emperor's difficulties to rise again and again, the twin pillars of his strength being the Saxon hatred of the Franconian emperor and an informal alliance with the papal see. Henry's chief friends were his nephews, the two Hohenstaufen princes, Frederick and Conrad, to whose father Frederick the emperor Henry IV. had given the duchy of Swabia when its duke Rudolph became his rival. The younger Frederick succeeded to this duchy in 1105, while ten years later Conrad was made duke of Franconia, a country which for nearly a century had been under the immediate government of the crown. The two brothers were enthusiastic imperialists, and with persistent courage they upheld the cause of their sovereign during his two absences in Italy.

At last, in September 1122, the investiture question was settled by the concordat of Worms. By this compromise, which exhaustion forced upon both parties, the right of electing prelates was granted to the clergy, and the emperor surrendered the privilege of investing them with the ring and the staff. On the other hand it was arranged that these elections should take place in the presence of the emperor or his representative, and that he should invest the new prelate with the sceptre, thus signifying that the bishop, or abbot, held his temporal fiefs from him and not from the pope. In Germany the victory remained with the emperor, but it was by no means decisive. The Papacy was far from realizing Hildebrand's great schemes; yet in regard to the question in dispute it gained solid advantage, and its general authority was incomparably more important than it had been half a century before. During this period it had waged war upon the emperor himself. Instead of acknowledging its inferiority as in former times it had claimed to be the higher power; it had even attempted to dispose of the imperial crown as if the Empire were a papal fief; and it had found out that it could at any time tamper, and perhaps paralyse, the imperial authority by exciting internal strife in Germany. Having thus settled this momentous dispute Henry spent his later years in restoring order in Germany, and in planning to assist his father-in-law, Henry I. of England, in France. During this reign under the lead of Otto, bishop of Bamberg (c. 1063-1139), Pomerania began to come under the influence of Germany and of Christianity.

The Franconian dynasty died out with Henry V. in May 1125, and after a protracted contest Lothair, duke of Saxony, the candidate of the clergy, was chosen in the following August to succeed him. The new king's first enterprise was a disastrous campaign in Bohemia, but before this occurrence he had aroused the enmity of the Hohenstaufen princes by demanding that they should surrender certain lands which had formerly been the property of the crown. Lothair's rebuff in Bohemia stiffened the backs of Frederick and Conrad, and in order to contend with them the king secured a powerful ally by marrying his daughter Gertrude to Henry the Proud, a grandson of Welf, whom Henry IV. had made duke of Bavaria, a duchy to which Henry himself had succeeded in 1126. Henry was perhaps the most powerful of the king's subjects, nevertheless the dukes of Swabia and Franconia withstood him, and a long war desolated South Germany. This was ended by the submission of Frederick in 1134 and of Conrad in the following year. Lothair's position, which before 1130 was very weak, had gradually become stronger. He had put down the disorder in Bavaria, in Saxony and in Lorraine; a diet held at Magdeburg in 1135 was attended by representatives from the vassal states of Denmark, Hungary, Bohemia and Poland; and in 1136, when he visited Italy for the second time, Germany was in a very peaceful condition. In June 1133 during the king's first visit to Italy he had received from Pope Innocent II. the imperial crown and also the investiture of the extensive territories left by Matilda, marchioness of Tuscany; and at this time the pope seems to have claimed the emperor as his vassal, a statement to this effect (*post homo si papae, sumit quo dante coronam*) being inscribed in the audience hall of the Lateran at Rome.

Nothing could indicate more clearly than this fact how much of their old power the German kings had lost. It was not past hope that even yet some of their former splendour might be restored, and for a brief period monarchy did again stand high. Still, its foundations were sapped.

Decay of the royal power.

Incessant war, both at home and in Italy, had deprived it of its force; it had lost moral influence by humiliations, of which the scene at Canossa was an extreme type. Steadily, with unwearied energy, letting no opportunity escape, the princes had advanced towards independence, and they might well look forward to such a bearing in regard to the kings as the kings had formerly adopted in regard to them.

Henry the Proud was confident that he would succeed Lothair, who had died on his return from Italy in December 1137; but, by a hasty and irregular election, Conrad of Hohenstaufen, duke of Franconia, was chosen king in March 1138.

Henry the Proud rebelled and was declared to have forfeited his two duchies, Saxony and Bavaria, the former being given to Albert the Bear, margrave of Brandenburg, and the latter to Leopold IV., margrave of Austria. Henry defended his rights with vigour and once again Germany was ravaged by war, for although he was unpopular in Bavaria he was strongly supported by the Saxons, who, since the time of Henry IV., had always been ready to join in an attack on the monarchy, and he had little difficulty in driving Albert the Bear from the land. However, in October 1139 Henry died suddenly, but his young son, Henry the Lion, was recognized at once as duke of Saxony, while his brother, Welf, upheld the fortunes of his house in Bavaria. The struggle went on until May 1142, when peace was made at Frankfurt. Saxony, with the assent of Albert the Bear, was granted by Conrad to Henry the Lion, and Bavaria was given to Henry Jasomirgott, who had just succeeded his brother Leopold as margrave of Austria. But this was only a lull in the civil strife, which was renewed after the king had made a successful expedition into Bohemia. The princes clerical and lay were fighting against each other, and the Bavarians were at war with the Hungarians, who gained a great victory in 1146. Notwithstanding the many sources of confusion Conrad was persuaded by the passionate eloquence of Bernard of Clairvaux to take part in the second crusade; he left for the East in 1147 and returned to Germany in 1149, to find Welf again in arms and Henry the Lion claiming Bavaria. The king had done nothing to stem the rising tide of disorder when he died at Bamberg in February 1152. During this reign the work of conquering and Germanizing the Slavonic tribes east of the Elbe was seriously taken in hand under the lead of Albert the Bear and Henry the Lion, and the foundation of the margraviate of Brandenburg by Albert tended to make life and property more secure in the north-east of Germany.

After Conrad's death Germany passed under the rule of one of the greatest of her sovereigns, Frederick I., called Barbarossa, nephew of the late king and son of Frederick, that duke of Swabia who had fought along with Conrad against Henry the Proud. Frederick himself had also been closely associated with Conrad, who advised the prince to choose his nephew as his successor. This was done, and the new king was crowned at Aix-la-Chapelle in March 1152. Allied through his mother to the Welfs of Bavaria, and anxious to put an end to the unrest which dominated Germany, especially to the strife between the families of Welf and Hohenstaufen, Frederick began his reign by promising to secure for Henry the Lion the duchy of Bavaria, and by appeasing Henry's uncle, Count Welf, by making him duke of Spoleto and margrave of Tuscany. But the new king had another, and perhaps a more potent, reason for wishing to see peace restored in Germany. For his adventurous and imaginative spirit Italy and the imperial title had an irresistible charm, and in 1154, two years after he had ascended the throne, he crossed the Alps, being crowned emperor at Rome in June 1155. After this event the best years of his life were spent in Italy, where, in his long and obstinate struggle with the Lombard cities and with Pope Alexander III., he chiefly acquired his fame. Although on the emperor's side

this struggle was conducted mainly with German troops it falls properly under the history of Italy. In that country the record of this reign is a blood-stained page, while in the history of Germany, on the contrary, Frederick's name is associated with a peaceful and prosperous period.

The promise that Bavaria should be granted to Henry the Lion was not easily fulfilled, as Henry Jasomirgott refused to give up the duchy. At last, however, in 1156, after his return from his first expedition to Italy, Frederick reconciled the latter prince by making Austria into a duchy with certain special privileges, an important step in the process by which that country became the centre of a powerful state. Henry Jasomirgott then renounced Bavaria, and Henry the Lion became its duke. It was, however, in his other duchy of Saxony that the latter duke's most important work was done. Although he often gave offence by his haughty and aggressive disposition, few German princes have earned so thoroughly the goodwill of posterity. Since the death of Otto the Great the Slavonic lands to the east of the Elbe had been very imperfectly held in subjection by the Germans. Devoting himself to the conquest of the lands lying along the shore of the Baltic, Henry succeeded as no one before him had ever done. But he was not only a conqueror. He built towns and encouraged those which already existed; he founded and restored bishoprics in his new territories; and between the Elbe and the Oder he planted bodies of industrious colonists. While he was thus at work a similar task was being performed to the south-east of Saxony by Albert the Bear, the first margrave of Brandenburg, who, by his energetic rule was preparing this country for its great destinies.

Bavaria and Saxony.

Early in his reign, by settling a dispute over the crown of Denmark, Frederick brought the king of that country once more into the position of a German vassal. Having spent the year 1156 in settling the Bavarian question and in enforcing order in the Rhineland and elsewhere, the emperor marched into Poland in 1157, compelled its ruler, Boleslaus IV., to do the homage which he had previously refused to perform, and in return for services rendered during the campaign and for promises of future aid, raised the duke of Bohemia to the rank of a king, a change which in no way affected his duties to the German crown, but which gave him a certain precedence over other vassal princes. The king of Hungary, too, although no attempt was made to subdue him, became a useful ally. Thus the fame of Germany in the neighbouring countries, which had been nearly destroyed during the confusion of Henry IV.'s reign, was to a large extent restored. Frederick asserted his authority in Burgundy or, as it was sometimes called, Franche Comté. In Germany itself internal order was established by a strict appliance of the existing laws against those who broke the peace, fresh orders for its observance were issued, and in Frederick the robber nobles found a most implacable enemy. The cities, too, flourished during this reign. The emperor attached them to himself by granting to many of them the very liberties which, by a strained interpretation of his imperial rights, he withheld from the cities of Lombardy. Yet, notwithstanding his policy, in these directions the German nobles appear to have been enthusiastically devoted to Frederick. Time after time they followed him to Italy, enduring serious losses and hardships in order that he might enforce claims which were of no advantage to them, and which, previously, had been a curse to their nation. Their loyalty is well illustrated by the famous scene at Besançon in October 1157. During a meeting of the diet a papal legate read a letter from Pope Adrian IV., which seemed to imply that the Empire was a papal fief. Indignant murmurs rose from the assembled nobles, and the life of the legate was only saved from their fury by the intervention of the emperor himself. The secret of Frederick's great popularity was partly the national pride excited by his foreign achievements, partly the ascendancy over other minds which his genius gave him, and partly the conviction that while he would forego none of his rights he would demand from his vassals nothing more than was sanctioned by the laws of the Empire.

Frederick in Poland and Germany.

Frederick I. becomes king.

Having suppressed a rising at Mainz Frederick set out in the autumn of 1163 for Italy, which country was now distracted by a papal schism. This incident was bound to affect German politics. After the death of Adrian IV. in 1159 the imperial party put forward an anti-pope, Victor IV., against Alexander III., who had been canonically elected. The emperor made stupendous efforts to secure for Victor and then for his successor, Paschal III., recognition by the sovereigns of Europe, but in vain; and almost the only support which the anti-pope received came from the German clergy. In May 1165 Frederick held a diet at Würzburg, where the princes lay and clerical swore to be faithful to Paschal and never to recognize Alexander. But Alexander soon found partisans among the German clergy, hitherto the most loyal of the emperor's friends; and Frederick retaliated by driving the offending prelates from their sees, a proceeding which tended to disturb the peace of the land. Then in August 1167, in the midst of the struggle in Italy, came the pestilence which destroyed the imperial army in Rome, and drove the emperor as a fugitive across the Alps. After this humiliation Frederick remained for six years in Germany. He was fully occupied in restoring order in Saxony, in the diocese of Salzburg and elsewhere; in adding to his hereditary lands; in negotiating for a better understanding with France and England; and in reminding the vassal states, Hungary, Poland and Bohemia, of their duties towards the Empire. The success with which he carried out this work shows clearly that, in Germany at least, the disaster at Rome had not seriously affected his prestige. Again in Italy in 1174 the contest with the Papacy was abruptly ended by Frederick's overwhelming defeat at Legnano in May 1176, and by the treaty of Venice made about a year later with Alexander III.

In the later years of his reign the emperor's chief enemy was Henry the Lion. Rendered arrogant by success and confident that his interests were in northern, and not in southern Europe, the Saxon duke refused to assist Frederick in the campaign which ended so disastrously at Legnano. Ascribing his defeat to Henry's defection, Frederick returned to Germany full of anger against the Saxon duke and firmly resolved to punish him. The immediate cause of Henry's downfall, however, was not his failure to appear in Italy, but his refusal to restore some lands to the bishop of Halberstadt, and it was on this charge that he was summoned before the diet. Three times he refused to appear, and early in 1180 sentence was pronounced against him; he was condemned to lose all his lands and to go into banishment. For some time he resisted, but at length the emperor in person marched against him and he was forced to submit; the only favour he could secure when peace was made at Erfurt in November 1181 was permission to retain Brunswick and Lüneburg, which have remained in the possession of his descendants until our own day. Bavaria was granted to Otto of Wittelsbach, but it lost some of its importance because Styria was taken from it and made into a separate duchy. The extensive duchy of Saxony was completely dismembered. The name was taken by the small portion of the former duchy which was given to Bernard, son of Albert the Bear, the founder of a new Saxon line, and the extensive western part was added to the archbishopric of Cologne. The chief prelates of Saxony and many of the late duke's most important feudatories were made virtually independent of all control save that of the crown. Frederick's object in thus breaking up the two greatest duchies in his kingdom was doubtless to strengthen the imperial authority. But in reality he made it certain that the princes would one day shake off the imperial power altogether; for it was perhaps more difficult for the sovereign to contend with scores of petty nobles than with two or three great princes.

Less serious than the struggle with Henry the Lion was Frederick's struggle with Philip of Heinsberg, archbishop of Cologne (d. 1191), on whom he had just conferred a great part of Saxony. When the emperor went to Italy in 1184 he left the government of Germany to his son Henry, afterwards the emperor Henry VI., who had been crowned German king in 1169. On all

sides, but especially in the north-west, Henry was faced with incipient revolution, and while he was combating this the quarrel between Frederick and the Papacy broke out again in Italy. At this juncture Philip of Cologne united the German and the Italian oppositions. Several princes rallied to his standard and foreign powers promised aid, but although very formidable in appearance the combination had no vestige of popular support. The greater part of the German clergy again proved their loyalty to Frederick, who hurried to Germany only to see the opposition vanish before him. In March 1188 Philip of Cologne submitted at Mainz.

Germany was now at peace. With the accession of Gregory VIII. pope and emperor were reconciled, and by the marriage of his son Henry with Constance, daughter of Roger I., king of Sicily, the emperor had reason to hope that the Empire would soon include Naples and Sicily. Resolving that the sunset of his life should be even more splendid than its dawn he decided to go on crusade, and in 1189 he started with a great army for the Holy Land. When the news reached Germany that he had been drowned, an event which took place in Cilicia in June 1190, men felt that evil days were coming upon the country, for the elements of discord would no longer be controlled by the strong hand of the great emperor.

Evil days did not, however, come in the time of Henry VI., who, although without his father's greatness, had some of his determination and energy, and was at least his equal in ambition. Having in 1190 reduced Henry the Lion once more to submission, the new king set out to take possession of his Sicilian kingdom, being on the way crowned emperor at Rome. At the end of 1191 he returned to Germany, where he was soon faced by two serious risings. The first of these centred round the restless and unruly Welfs; after a time these insurgents were joined by their former enemies, the rulers of Saxony, of Thuringia and of Meissen, who were angered by Henry's conduct. The Welfs also gained the assistance of Canute VI., king of Denmark. Equally dangerous was a rebellion in the Lower Rhineland, where the emperor made many foes by appointing, regardless of their fitness, his own candidates to vacant bishoprics. At Liège this led to serious complications; and when Bishop Albert, who had been chosen against Henry's wish, was murdered at Reims in November 1192, the emperor was openly accused of having instigated the crime. At once the rulers of Brabant, of Limburg and of Flanders, with the archbishops of Cologne and Trier, were in arms. In the east of Germany Ottakar I. of Bohemia joined the circle of Henry's enemies, and the southern duchies, Bavaria, Swabia and Austria, were too much occupied with internal quarrels to send help to the harassed emperor. But formidable as were these risings they were crushed, although not entirely by force of arms. In 1193 Richard I. of England passed as a prisoner into Henry's keeping, and with rare skill the emperor used him as a means of compelling his enemies to come to terms. Henry the Lion was the last to submit. He made his peace in 1194, when his son Henry was promised the succession to the Rhenish Palatinate. Returning from another visit to Sicily, the emperor was now so powerful that, in pursuance of his plan for making himself the head of a great world monarchy, he put forward the suggestion that the imperial crown should be declared hereditary in his family. This proposal aroused much opposition, but Henry persisted with it; he promised important concessions to the princes, many of whom were induced to consent, and but for his sudden death, which occurred in Sicily in September 1197, it is probable that he would have attained his end.

Great as was Henry's authority many of the princes, chief among them being Adolph, archbishop of Cologne (d. 1220), refused to recognize his son, Frederick, who had been chosen king of the Romans in 1196. This attitude was possibly owing to the fact that Frederick was young and inexperienced; it was, however, more probably due to a revival of the fear that the German princes would be entangled in Italian politics. For a time Adolph and his friends, who were mainly princes of the Rhineland,

Frederick and Alexander III.

Frederick and Philip of Heinsberg.

Frederick's death.

Henry VI.

Frederick and Henry the Lion.

Philip of Swabia and Otto of Brunswick.

sought in vain for a new king. While they were thus employed the friends of the house of Hohenstaufen, convinced that Frederick's kingship was not possible, chose the late emperor's brother, Philip, duke of Swabia, to fill the vacant throne; soon afterwards the enemies of the house found a candidate in the person of Henry the Lion's son, Otto of Brunswick, who was also chosen German king. Thus the struggle between Welf and Hohenstaufen was renewed and civil war broke out at once. Philip's supporters were the nobles of southern and eastern Germany, while a few cities in the west owned his authority; Otto's friends were found mainly in the north and the north-west of the country. The number of available warriors was increased by the return of many crusaders, among them being the famous soldier, Henry von Kalden, who was mainly responsible for the success of Philip's cause in 1199. If Germany had been unconnected with the Papacy, or even if the Papacy had been as weak as in the days of Henry VI., the issue of the strife would almost certainly have been an early victory for Philip. A majority of the princes were on his side and the French king Philip Augustus was his ally, while his personal character commanded general respect. Otto, whose chief supporter outside Germany was his uncle Richard I. of England, on the other hand was a harsh and violent man. But unfortunately for Germany the papal chair at this time was occupied by Innocent III., a pope who emulated Hildebrand in ambition and in statesmanship. At first vacillating, but by no means indifferent, Innocent was spurred to action when a number of princes met at Spire in May 1200, declared Philip to be the lawful king, and denied the right of the pope to interfere. He was also annoyed by Philip's attitude with regard to a vacancy in the archbishopric of Cologne, and in March 1201 he declared definitely for Otto. The efforts of the pope helped to rekindle the expiring flames of war, and for a year or two success completely deserted Philip. He lost the support of Ottakar of Bohemia and of Hermann I., landgrave of Thuringia; he was driven from North Germany into Swabia and Otto's triumph seemed assured. From 1204 onwards, however, fortune again veered round, and Philip's prospects began to improve. Deserted by Ottakar and even by Adolph of Cologne and his own brother Henry, count palatine of the Rhine, Otto was forced to take refuge in Brunswick, his last line of defence, and was only saved by Philip's murder, which occurred at Bamberg in June 1208. A feature of this struggle was the reckless way in which the rival kings gave away the property of the crown in order to gain adherents, thus enriching the princes and weakening the central government.

Otto was now again chosen German king, and to aid and mark the general reconciliation he was betrothed to the murdered king's daughter Beatrix. Nearly all the princes

*Otto IV.
becomes
sole king.*

acknowledged him, and as pope and king were at peace, Germany enjoyed a period of comparative quiet. This however, did not last long. Having secured his coronation at Rome in October 1209, Otto repudiated the many pledges he had made to Innocent and began to act in defiance of the papal wishes. To punish him the pope put forward his own ward, Henry VI.'s son Frederick, who was living in Sicily, as a rival king. While Otto was warring in Italy a number of influential princes met at Nuremberg, at the instigation of Innocent and of his ally Philip Augustus of France, and invited Frederick to come to Germany. Otto then left Italy hurriedly, but he was quickly followed by his young rival, who in the warfare which had already broken out proved himself a formidable opponent. Seeking to mend his failing fortunes, the Welf went to France to support his ally, the English king John, against Philip Augustus, and at the battle of Bouvines (July 27, 1214) memorable in the history alike of Germany, of England and of France, his fate was sealed, although until his death in May 1218 he maintained a desultory warfare against Frederick.

Frederick II. was, if not the strongest, certainly the most brilliant of German kings. With the medieval passion for adventure he combined the intellectual culture and freedom of

a modern gentleman. A lover of poetry, of art and of science, he was also a great statesman; he knew how to adapt his policy to changing circumstances and how to move men by appealing at one time to their selfishness and weakness and at another time to the nobler qualities of human nature. For outward splendour his position was never surpassed, and before he died he possessed six crowns, those of the Empire, Germany, Sicily, Lombardy, Burgundy and Jerusalem. But Germany profited neither by his gifts nor by his prestige. After Bouvines he purchased the assistance of Valdemar II., king of Denmark, by ceding to him a large stretch of land along the Baltic coast; and, promising to go on crusade, he secured his coronation at Aix-la-Chapelle in July 1215. Then being generally recognized as king he was able to do something to quell disturbances in various parts of the country, and, in April 1220, to bring about the election of his young son Henry as king of the Romans. But for this favour he had been compelled to pay a high price. Seven years before, at Eger in July 1213, he had made extensive concessions to the church, undertaking to take no part in episcopal elections, thus surrendering the advantages gained by the concordat of Worms, and to allow to German bishops the right of appeal to Rome. Proceeding a step farther in the same direction, he now promised to erect no new toll-centre, or mint, on the lands of the spiritual princes, and to allow no towns to be built thereon. Thus the prelates possessed nearly all the rights of sovereigns, and regarded the pope in Italy and not the king in Germany as their head, a state of affairs which was fatal to the unity, nay, even to the existence of the Empire.

Frederick II.

Having made peace with Henry, count palatine of the Rhine and brother of Otto IV., and settled a dispute about the lands of the extinct family of Zähringen in the south-west of the country, Frederick left Germany in August 1220; engaged in his bitter contest with the Papacy and the Lombard cities, in ruling Sicily, and, after several real or imaginary delays, in fulfilling his crusading vow, he did not return to it for fifteen years. During this period he was represented by his son Henry, in whose name the government of Germany was carried on by the regent Engelbert, archbishop of Cologne. While Engelbert lived the country was in a fairly peaceable condition, although, thanks to the emperor's concessions, the spiritual princes were predominant, and all possible means were taken to check the growth of the towns, whose interests and aspirations were not favourable to this state of affairs. There was, moreover, a struggle between Valdemar of Denmark and some neighbouring German nobles. But after Engelbert's murder (November 1225) there was a change for the worse, and the only success which can be placed to the credit of the German arms during the next few years was the regaining of the lands ceded to Denmark in 1215, lands which included the cities of Hamburg and Lübeck. Under the rule of the new regent, Louis I., duke of Bavaria, confusion reigned supreme, and civil war prevailed in nearly every part of the country.

*Germany
in Frederick's
absence.*

After the treaty of San Germano, which was made with Pope Gregory in 1230, and the consequent lull in the struggle with the Papacy, Frederick was able to devote some little attention to Germany, and in 1231 he sanctioned the great Privilege of Worms. This was a reward to the princes for their efforts in bringing about the peace, and an extension of the concessions made in 1220. The princes, now for the first time referred to officially as *domini terrae*, were given full rights of jurisdiction over their lands and all the inferior officers of justice were made subservient to them. Practically they became independent sovereigns, and to make their victory more complete serious restraints were laid upon the freedom of the towns. Before this date King Henry had begun to take a personal part in the government and was already involved in a quarrel with Otto II., duke of Bavaria. He disliked the Privilege of Worms and, favouring the towns against the princes, his policy was diametrically opposed to that of the emperor; however, in 1232 he went to Italy and promised to

*Rebellion
of King
Henry.*

obey his father's commands. But in 1234, at a time of great and increasing disorder in Germany, he rebelled; he appealed publicly to the princes for support, gained some followers, especially in his own duchy of Swabia, and made an alliance with the Lombard cities. Confident of his strength Frederick entered Germany with a few attendants in the middle of 1235, and his presence had the anticipated effect of quelling the insurrection; Henry was sent a prisoner to Italy and disappeared from history. Then, in August 1235, amid surroundings of great splendour, the emperor held a diet at Mainz, which was attended by a large number of princes. This diet is very important in the legal history of Germany, because here was issued that great "land peace" (*Landfrieden*) which became the model for all subsequent enactments of the kind. By it private war was declared unlawful, except in cases where justice could not be obtained; a chief justiciar was appointed for the Empire; all tolls and mints erected since the death of Henry VI. were to be removed; and other provisions dealt with the maintenance of order.

In 1236, during another short stay in Germany, Frederick in person led the imperial army against Frederick II., duke of Austria, who had defied and overcome his representatives; having taken possession of Vienna and the Austrian duchies he there secured the election of his son Conrad, who had already succeeded his brother as duke of Swabia, as king of the Romans (May 1237). But in spite of these imposing displays of power the princes looked with suspicion upon an emperor who was almost a stranger to their country and who was believed to be a renegade from their faith, and soon after Frederick's return to Italy the gulf between him and his German subjects was widened by his indifference to a great danger which threatened them. This came from the Mongols who ravaged the eastern frontiers of the country, but the peril was warded off by the efforts of Henry II., duke of Silesia, who lost his life in a fight against these foes near Liegnitz in April 1241, and of Wenceslaus I., king of Bohemia.

The emperor's attitude with regard to the Mongol invasion is explained by events in Italy where Frederick was engaged in a new and, if possible, a more virulent struggle with the Lombard cities and with Gregory IX. As usual, the course of politics in Germany, which at this time was ruled by King Conrad and by the regent Siegfried, archbishop of Mainz (d. 1245), was influenced by this quarrel. Frederick of Austria had allied himself with Wenceslaus of Bohemia, and spurred on by the papal emissary had tried to set up a rival king; but both the Danish and the French princes who were asked to accept this thankless position declined the invitation, and Frederick and Wenceslaus made their peace, the former receiving back his duchies. After the defeat of the Mongols, however, there was again the danger of a rebellion based upon a union between the princes and the pope. Siegfried of Mainz deserted his master, and visiting Germany in 1242 Frederick found it necessary to purchase the support of the towns by a grant of extensive privileges; but, although this had the desired effect, Conrad could make but little headway against the increasing number of his enemies. At last the Papacy found an anti-king. Having declared Frederick deposed at the council of Lyons in 1245, Gregory's successor, Innocent IV., induced a number of princes to choose as their king the landgrave of Thuringia, Henry Raspe, who had served as regent of Germany. This happened in May 1246, and the conduct of the struggle against the *Pfaffenkönig*, as Henry was called, was left to Conrad, who was aided by the Bavarians, until February 1247, when the anti-king died. The papal party then elected William II., count of Holland, as Henry Raspe's successor, and during the state of anarchy which now prevailed in Germany the emperor died in Italy in December 1250.

Upon his father's death Conrad IV. was acknowledged by many as king in Germany, but in 1251 he went to Italy, where he was fully occupied in fighting against the enemies of his house until his death in May 1254. The struggle to maintain the position of the Hohenstaufen in Italy

was continued after this event; but in October 1268, by the execution of Conrad's son Conradin, the family became extinct.

After Conrad's death William of Holland received a certain allegiance, especially in the north of the country, and was recognized by the Rhenish cities which had just formed a league for mutual protection, a league which for a short time gave promise of great strength and usefulness. In January 1256, however, William was killed, and in the following year there was a double election for the German crown, Alphonso X., king of Castile, a grandson of Philip of Swabia, and Richard, earl of Cornwall, brother of the English king Henry III., being each chosen by parties of electors. Richard was crowned in May 1257, but the majority of his subjects were probably ignorant of his very name; Alphonso did not even visit the country over which he claimed to rule.

During the reign of Frederick II. Prussia was conquered for Christianity and civilization by the knights of the Teutonic Order, who here built up the state which was later, in association with Brandenburg, deeply to influence the course of history. This work was begun in 1230. Knights eager to win fame by engaging in the war against the heathen Prussians flocked hither from all lands; towns, Königsberg, Thorn, Kulm and others, were founded; and in alliance with the Brothers of the Sword, the order was soon pressing farther eastwards. Courland and Livonia were brought into subjection, and into these lands also Christian institutions were introduced and German settlers brought the arts of peace.

The age of the Hohenstaufen emperors is, in many respects, the most interesting in the medieval history of Germany. It was a period of great men and great ideas, of dramatic contrasts of character and opinion—on the one side a broad humanitarianism combined with a gay enjoyment of the world, on the other side an almost superhuman spirituality which sought its ideal in the rejection of all that the world could give. It saw the new-birth of poetry and of art; it witnessed the rise of the friars. The contest between Empire and Papacy was more than a mere struggle for supremacy between two world-powers; it was a war to the death between two fundamentally opposite conceptions of life, which in many respects anticipated and prepared the way for the Renaissance and the Reformation. The emperor Frederick II. himself stands out as the type of the one tendency; Innocent III., Francis of Assisi and Dominic, in their various degrees, are types of the other. Frederick himself, of course, was Italian rather than German, akin to the despots of the Renaissance in his many-sided culture, his tolerant scepticism and his policy of "cruelty well applied." The culture of which he was the supreme representative, that of Italy and of Provence, took a more serious shade when it penetrated into Germany. The German *Minnesinger* and romance-writers, whose golden age corresponded with that of the Hohenstaufen, were not content only to sing the joy of life or the chivalrous virtues of courage, courtesy and reverence for women; they in some sort anticipated the underlying ideas of the Reformation by championing the claims of the German nation against the papal monarchy and pure religion, as they conceived it, against the arrogance and corruption of the clergy. In them the medieval lay point of view became articulate, finding perhaps its most remarkable expression in the ideas of religious toleration proclaimed by Walther von der Vogelweide and Wolfram von Eschenbach. In Germany, as elsewhere, the victory of the Papacy was the victory of obscurantism. German culture, after a short revival, perished once more amid the smoke of the fires kindled by Conrad of Marburg and his fellow inquisitors.

In architecture, as in literature, this period was also one of great achievement in Germany. Of the noble palaces which it produced the castle of the Wartburg (*g.v.*) remains a perfect specimen, while the many magnificent churches dating from this time that still survive, prove the taste, wealth and piety

The Inter-regnum.

The Teutonic Order in Prussia.

Period of Hohenstaufen dynasty.

of the burghers. For the science of government, too, much was done, partly by the introduction from Italy of the study of Roman law, partly by the collection of native customs in the *Sachsenspiegel* compiled by Eike von Repgow early in the 13th century, and the less valuable *Deutschenspiegel* and *Schwabenspiegel*. Altogether, Germany has seen no more fascinating epoch, none more full of life, movement and colour.

Yet it was in this age that the German nation utterly lost its political strength. Even after Lothair the Saxon, a line of sovereigns rigidly confining themselves to their own kingdom might have mastered the many influences which were making for disunion. But the Hohenstaufen family, like their Saxon and Franconian predecessors, would be content with nothing short of universal dominion; and thus the crown which had once been significant of power and splendour gradually sank into contempt. Under the strong rule of Frederick Barbarossa and his son this process was temporarily stopped, but only to advance more rapidly when they were gone. During the confusion of the civil war carried on by Otto IV. and Philip, the princes, being subject to hardly any check, freely obtained crown lands and crown rights, and the mischief was too extensive to be undone by Frederick II. In 1220, in order to secure the adhesion of the church to his son Henry, he formally confirmed the spiritual princes in their usurpations; eleven years later at Worms still more extensive advantages were granted to the princes, both spiritual and secular, and these formal concessions formed the lawful basis of the independence of the princely class. Such authority as the emperor reserved for himself he could exercise but feebly from a distant land in which his energies were otherwise occupied. His immediate successors can hardly be said to have exercised any authority whatever; and they lost hold of the border countries which had hitherto been dependent upon or connected with Germany. Thenceforth Denmark and Poland rendered no homage to the German crown, and Burgundy was gradually absorbed by France.

The country was not now divided into a few duchies which, with skilful management, might still in times of emergency have been made to act together. The age of the great duchies was past. As we have seen, Bavaria was shorn of extensive lands, over which new dukes were placed, and the duchy of Saxony was altogether broken up. Swabia and Franconia ceased to have dukes, and Lorraine gave place to the duchy of Brabant and other smaller states. Thus there were archbishops, bishops, abbots, dukes, margraves, landgraves, counts—forming together a large body—each of whom claimed to have no superior save the emperor, whose authority they and their predecessors had slowly destroyed. All immediate nobles were not princes; but even petty knights or barons, who possessed little more than the rude towers from which they descended upon passing travellers, if their only lord was the emperor, recognized no law save their own will. Another independent element of the state was composed of the imperial cities. So long as the emperor really reigned, they enjoyed only such liberties as they could wring from him, or as he voluntarily conferred. But when the sovereign's power decayed, the imperial cities were really free republics, governing themselves according to their own ideas of law and justice (see *COMMUNE*). Besides the imperial cities, and the princes and other immediate nobles, there were the mediate nobles, the men who held land in fief of the highest classes of the aristocracy, and who, in virtue of this feudal relation, looked down upon the allodial proprietors or freemen, and upon the burghers. There were also mediate towns, acknowledging the supremacy of some lord other than the sovereign. Beneath all these, forming the mass of the agricultural population, were the peasantry and the serfs, the latter attached to the land, the former ground down by heavy taxes. There was another class, large and increasing in number, which was drawn from various sections of society. This was composed of men who, being without land, attached themselves to the emperor or to some powerful noble; they performed services, generally of a military nature, for their

lord, and were called *Dienstmannen* (*ministeriales*). They were often transformed into "free knights" by the grant of a fief, and the class ultimately became absorbed in that of the knights.

The period from the death of Conrad IV. to the election of Rudolph of Habsburg in 1273 is generally called the Great Interregnum, and it was used by the princes to extend their territories and to increase their authority. On several occasions it had seemed as if the German crown would become hereditary, but it had been kept elective by a variety of causes, among them being the jealousy of the Papacy and the growing strength of the aristocracy. In theory the election of each king needed the sanction of the whole of the immediate nobles, but in practice the right to choose the king had passed into the hands of a small but varying number of the leading princes. During the 13th century several attempts were made to enumerate these princes, and at the contested election of 1257 seven of them took part. This was the real beginning of the electoral college whose members at this time were the archbishops of Mainz, Cologne and Trier, the duke of Saxony, the duke of Bavaria, who was also count palatine of the Rhine, the margrave of Brandenburg and the king of Bohemia. After this event the electors became a distinct element in the state. They were important because they could maintain the impotence of the crown to check disorder by imposing conditions upon candidates for the throne, and by taking care that no prince powerful enough to be dangerous to themselves should be elected to this position.

Until the time of the interregnum the territories of a prince were rarely divided among his descendants, the reason being that, although the private fiefs of the nobles were hereditary, their offices—margrave, count and the like—were in theory at the disposal of the king. There was now a tendency to set this principle aside. Otto II., duke of Bavaria, a member of the Wittelsbach family, had become by marriage ruler of the Rhenish Palatinate, and after his death these extensive lands were ruled in common by his two sons; but in 1255 a formal division took place and the powerful family of Wittelsbach was divided into two branches. About the same time the small duchy of Saxony was divided into two duchies, those of Wittenberg and Lauenburg, the former to the south and the latter to the north of the great mark of Brandenburg, and there were similar divisions in the less important states. It was thus practically settled that the offices and territories, as well as the private fiefs, of the princes were hereditary, to be disposed of by them at their pleasure. This being thoroughly established it would have been hard, perhaps impossible, even for a sovereign of the greatest genius, to reassert in anything like its full extent the royal authority. The process of division and subdivision which steadily went on broke up Germany into a bewildering multitude of principalities; but as a rule the members of each princely house held together against common enemies, and ultimately they learned to arrange by private treaties that no territory should pass from the family while a single representative survived.

The consolidation of the power of the princes was contemporary with the rise of the cities into new importance. Several of them, especially Mainz, Worms and Spire, had received valuable rights from the kings and other lords; they were becoming self-governing and to some extent independent communities and an important and growing element in the state. The increase of trade and a system of taxation provided the governing body with funds, which were used to fortify the city and in other ways to make life and property more secure. The destruction of imperial authority compelled them to organize their resources, so as to be at all times prepared against ambitious neighbours. They began to form leagues which the greatest princes and combinations of princes could not afford to despise. Of these leagues the chief at this time was the Rhenish Confederation, which has been already mentioned. Great importance was also acquired by the Hanseatic League, which had originated during the interregnum in a treaty of alliance between Lübeck

Political character of Germany settled.

The electors.

Division of the princely lands.

Classes of the population.

The cities.

and Hamburg. It ultimately included more than eighty cities and became one of the greatest commercial powers in Europe (see HANSEATIC LEAGUE).

A political system which allowed the princes to do as they pleased was very much to their liking, and if they had followed their own impulse it is possible that they would never have placed a king over their country. But the pope intervened. He found from his troubles in Italy and from his diminished revenues from Germany that it would be still convenient to have in the latter country a sovereign who, like some of his predecessors, would be the protector of the church. Therefore, after the death of Richard of Cornwall in April 1272, Pope Gregory X., ignoring the absent Alphonso of Castile, told the electors that if they did not choose a king he himself would appoint one. The threat was effective. In September 1273 the electors met and raised to the throne a Swabian noble, Rudolph, count of Habsburg, who proved to possess more energy than they had imagined possible. For some time before this event the most powerful prince in Germany had been Ottakar II., king of Bohemia, who by marriage and conquest had obtained large territories outside his native kingdom, including the duchy of Austria and other possessions of the extinct family of Babenberg. Having himself cherished some hopes of receiving the German crown Ottakar refused to do homage to the new sovereign; after a time war broke out between them, and in August 1278 in a battle at Dürnkrut on the March Ottakar was defeated and slain, his lands, save Bohemia, passing into the possession of the victor. Rudolph had been able to give his whole attention to this enterprise owing to the good understanding which had been reached between himself and the pope, to whom he had promised to allow a free hand in Italy.

Rudolph has often been called the restorer of the German kingdom, but he has little real claim to this honourable title.

He marched once or twice against law-breakers, but in all the German duchies there were frequent disturbances which he did very little to check. In his later years he made some attempts to maintain the public peace, and he distinguished himself by the vigour with which he punished robber barons in Thuringia; he also won back some of the crown lands and dues which had been stolen during the interregnum. But he made no essential change in the condition of Germany. There seemed to be only one way in which a king could hope to overcome the arrogance of the princes, and that was to encourage the towns by forming with them a close and enduring alliance. Rudolph, however, almost invariably favoured the princes and not the towns. The latter had a class of burgher called *Pfahlbürger*, men who lived in the open country outside the *Pfähle*, or palisades of the town, but who could claim the protection of the municipal authorities. By becoming *Pfahlbürger* men were able of escape from the tyranny of the large landholders, and consequently the princes strongly opposed the right of the towns to receive them. Not only did the king take the part of the princes in this important struggle, but he harassed the towns by subjecting them to severe imposts, a proceeding which led to several risings. About this time the princes were gaining influence in another direction. Their assent to all important acts of state, especially to grants of crown property, was now regarded as necessary and was conveyed by means of *Willebriefe*; henceforward they were not merely the advisers of the king, they were rather partners with him in the business of government.

Rudolph had all the sympathies and prejudices of the noble class, and the supreme object of his life was not to increase the power of the state but to add to the greatness of his own family, a policy which was perhaps justified by the condition of the German kingdom, the ruler of which had practically no strength save that which he derived from his hereditary lands. In this he was very successful. Four years after the fall of Ottakar he obtained from the princes a tardy and reluctant assent to the granting of Austria, Styria and Carniola to his own sons, Rudolph and Albert. In 1286

Carinthia was given to Meinhard, count of Tirol, on condition that when his male line became extinct it should pass to the Habsburgs. Thus Rudolph made himself memorable as the real founder of the house of Habsburg.

It was in vain that Rudolph sought to obtain the succession to the crown for one of his sons; the electors would not take a step which might endanger their own rights, and nearly a year after the king's death in July 1291 they chose Adolph, count of Nassau, and not Rudolph's surviving son Albert, as their sovereign. Adolph, an insignificant prince, having been obliged to reward his supporters richly, wished to follow the lines laid down by his predecessor and to secure an extensive territory for his family. Meissen, which he claimed as a vacant fief of the Empire, and Thuringia, which he bought from the landgrave Albert II., seemed to offer a favourable field for this undertaking, and he spent a large part of his short reign in a futile attempt to carry out his plan. In his foreign policy Adolph allied himself with Edward I. of England against Philip IV. of France, but after declaring war on France in August 1294 he did nothing to assist his ally. At home he relieved the cities of some of their burdens and upheld them in the quarrel about the *Pfahlbürger*; and he sought to isolate Albert of Habsburg, who was treating with Philip of France. But many of the princes were disgusted with him and, led by Albert of Habsburg, Gerhard, archbishop of Mainz, and Wenceslaus II., king of Bohemia, they decided to overthrow him, and at Mainz in June 1298 he was declared deposed. He resisted the sentence, but Albert, who had been chosen his successor, marched against him, and in July 1298, at Gölheim near Worms, Adolph was defeated and killed.

After Adolph's death Albert was again chosen German king, and was crowned at Aix-la-Chapelle in August 1298. Like his father Rudolph, the new king made it the principal object of his reign to increase the power of his house, but he failed in his attempts to add Bohemia and Thuringia to the hereditary lands of the Habsburgs, and he was equally unsuccessful in his endeavour to seize the countries of Holland and Zealand as vacant fiefs of the Empire. In other directions, however, he was more fortunate. He recovered some of the lost crown lands and sought to abolish new and unauthorized tolls on the Rhine; he encouraged the towns and took measures to repress private wars; he befriended the serfs and protected the persecuted Jews. For a time Albert allied himself with Philip IV. of France against Pope Boniface VIII., who had refused to recognize him as king, but in 1303 he made peace with the pope, a step which enabled him to turn his attention to Bohemia and Thuringia. The greatest danger which he had to face during his reign came from a league which was formed against him in 1300 by the four Rhenish electors—the three archbishops and the count palatine of the Rhine—who disliked his foreign policy and resented his action with regard to the tolls. Albert, however, supported by the towns, was victorious; and the revolting electors soon made their peace.

After Albert's murder, which took place in May 1308, Henry, count of Luxemburg, a brother of Baldwin (1285-1354), the powerful archbishop of Trier, became king as Henry VII. Although fortunate enough to obtain for his son John the crown of Bohemia, the aggrandizement of his family was not the main object of this remarkable sovereign, the last German king of the old, ambitious type. It was the memory of the Empire which stirred his blood; from the beginning of his reign he looked forward to securing the Lombard and the imperial crowns. His purpose to cross the Alps at the head of a great force was hailed with delight by the Ghibellines, whose aspirations found utterance in Dante's noble prose, but his life was too short for him to fulfil the hopes of his friends. Having restored the Rhine tolls to the Rhenish archbishops and made his peace with the Habsburgs, Henry went to Italy in the autumn of 1310, not, however, with a large army, and remained in the peninsula until his death in August 1313. As in former times the effect of the connexion of Germany with Italy was altogether mischievous, because to expedite his Italian journey the king

Rudolph
of Habs-
burg.

Adolph of
Nassau.

The
regns.

Albert I.

Henry VII.

The
Habsburg
dynasty.

had added to the great privileges of the princes and had repressed the energies of the towns.

After Henry's death the electors, again fearing lest the German crown should become hereditary, refused to choose the late king's young son, John of Bohemia, as their ruler, although the candidature of this prince was supported by the powerful archbishops Baldwin of Trier and Peter of Mainz. They failed, in fact, to agree upon any one candidate, and after a long delay there was a double election for the throne. This took place in October 1314, when the larger party chose Louis IV., duke of Upper Bavaria, while the smaller party gave their votes to Frederick the Fair, duke of Austria, a son of King Albert I. Although related to each other, Louis and Frederick had come to blows before this event; they represented two rival houses, those of Wittelsbach and Habsburg, and the election only served to feed the flame of their antagonism. A second time war broke out between them. The struggle, marked by numerous raids, sieges and skirmishes, lasted for nine years, being practically ended by Frederick's decisive defeat at Mühlendorf in September 1322. The vanquished king remained in captivity until 1325, when, during the contest between the Empire and the Papacy, Louis came to terms with him. Frederick acknowledged his rival, and later the suggestion was put forward that they should rule Germany jointly, but this arrangement aroused much opposition and it came to nothing. Frederick returned into an honourable captivity and died in January 1330.

The success of Louis in his war with Frederick was to some extent due to the imperial cities, which supported him from the first. Not only did they pay high taxes, but they made splendid voluntary contributions, thus enabling the sovereign of their choice to continue the fight. But Louis was perhaps still more indebted for his victory to the memorable conflict between the Swiss and the Habsburgs, the defeat of Leopold of Austria at Morgarten in 1315 striking a heavy blow at his position. Thus this struggle for freedom, although belonging properly to the history of Switzerland, exercised much influence on the course of German history.

Had Louis been wise and prudent, it would have been fairly easy for him to attain a strong position after his victory at Mühlendorf. But he threw away his advantages. He offended John of Bohemia, who had aided him at Mühlendorf, thus converting a useful friend into a formidable foe, and his other actions were hardly more judicious. John was probably alarmed at the increase in the power of the German king, and about the same time a similar fear had begun to possess Pope John XXII. and Charles IV. of France. About 1323 Louis had secured the mark of Brandenburg for his son Louis, and he was eager to aggrandize his family in other directions. It was just at the time when he had estranged John of Bohemia that the pope made his decisive move. Asserting that the German crown could only be worn by one who had received the papal approbation he called upon Louis to lay it down; the answer was an indignant refusal, and in 1324 the king was declared deposed and excommunicate. Thus the ancient struggle between the Papacy and the Empire was renewed, a struggle in which the pen, wielded by Marsiglio of Padua, William of Occam, John of Jandun and others, played an important part, and in which the new ideas in religion and politics worked steadily against the arrogant papal claim. The pope and his French ally, Charles IV., whom it was proposed to seat upon the German throne, had completely misread the signs of the times, and their schemes met with very little favour in Germany. No longer had the princes as in former years any reason to dread the designs of an ambitious king; the destinies of the kingdom were in their own hands and they would not permit them to be controlled by an alien power. Such was the attitude of most of the temporal princes, and many spiritual princes took the same view. As for the electors, they had the strongest possible motive for resisting the papal claim, because if this were once admitted they would quickly lose their growing importance in the state.

Lastly, the cities which had stood behind the Empire in the most difficult crises of its contest with Rome were not likely to desert it now.

Thus encouraged, or rather driven forward, by the national sentiment Louis continued to assert the independence of the crown against the pope. In 1327 he marched into Italy, where he had powerful and numerous friends in the Ghibelline party, the Visconti family and others; in January 1328 he was crowned emperor at Rome, and after this event he declared Pope John deposed and raised Peter of Corvara to the papal chair as Nicholas V. The concluding stages of this expedition were not favourable to the new emperor, but his humiliation was only slight and it did not appreciably affect the conditions of the controversy.

For a short time after the emperor's return to Germany there was peace. But this was soon broken by a dispute over the succession to the duchy of Carinthia and the county of Tirol, then ruled by Henry V., who was without sons, and whose daughter, Margaret Maultasch, was married to John Henry, margrave of Moravia, a son of John of Bohemia. Upon these lands the three great families in Germany, those of Wittelsbach, of Habsburg and of Luxemburg, were already casting covetous eyes; Carinthia, moreover, was claimed by the Habsburgs in virtue of an arrangement made in 1286. Thus a struggle between the Luxemburgs and the Habsburgs appeared certain, and Louis, anxious to secure for his house a share of the spoil, hesitated for a time between these rivals. In 1335 Duke Henry died and the emperor adjudged his lands to the Habsburgs; wars broke out, and the result was that John Henry secured Tirol while the other contending family added Carinthia to its Austrian possessions.

During this time Louis had been negotiating continually with Pope John and with his successor Benedict XII. to regain the favour of the church, and so to secure a free hand for his designs in Germany. But the pope was not equally complaisant, and in 1337 the emperor allied himself with Edward III. of England against Philip VI. of France, whom he regarded as primarily responsible for the unyielding attitude of the Papacy. This move was very popular in Germany, and the papal party received a further rebuff in July 1338 when the electors met at Rense and declared that in no possible manner could they allow any control over, or limitation of, their electoral rights. As a sequel to this declaration the diet, meeting at Frankfort a month later, asserted that the imperial power proceeded from God alone and that the individual chosen by a majority of the electors to occupy this high station needed no confirmation from the pope, or from any one else, to make his election valid. Contrary opinions they denounced as *pestifera dogmata*.

But in spite of this support Louis threw away his advantages; he abandoned Edward III. in 1341, although this step did not win for him, as he desired, the goodwill of the pope, and he was soon involved in a more serious struggle with John of Bohemia and the Luxemburgs. With his Bohemian followers John Henry had made himself very unpopular in Tirol, where his wife soon counted herself among his enemies, and in 1341 he was driven from the land, while Margaret announced her intention of repudiating him and marrying the emperor's son Louis, margrave of Brandenburg. The emperor himself entered heartily into this scheme for increasing the power of his family; he declared the marriage with John Henry void, and bestowed upon his son and his bride Margaret not only Tirol, but also Carinthia, now in the hands of the Habsburgs. Nothing more was needed to unite together all the emperor's foes, including Pope Clement VI., who, like his predecessors, had rejected the advances of Louis; but in 1345, before the gathering storm broke, the emperor took possession of the counties of Holland, Zealand and Friesland, which had been left without a ruler by the death of his brother-in-law, Count William IV. By this time John of Bohemia and his allies had completed their plans. In July 1346 five of the electors met, and, having declared Louis deposed, they raised John's

Louis the
Bavarian
and
Frederick
of Austria.

Louis in
Italy.

Louis in
Germany.

Causes
of the
success of
Louis.

The pope
and the
electors.

Louis IV.
and the
pope.

Louis
and the
Luxemburgs.

son Charles, margrave of Moravia, to the German throne. For a time no serious steps were taken against Louis, but after King John had met his death at Crécy Charles, who succeeded him as king of Bohemia, began to make vigorous preparations for war, and only the sudden death of the emperor (October 1347) saved Germany from civil strife.

Notwithstanding the defects of Louis's personal character his reign is one of the most important in German history. The claim of the Papacy to political supremacy received in his time its death-blow, and the popes themselves sowed the seeds of the alienation from Rome which was effected at the Reformation. With regard to the public peace Louis persistently followed the lines laid down by Albert I. He encouraged the princes to form alliances for its maintenance, and at the time of his death such alliances existed in all parts of the country. To the cities he usually showed himself a faithful friend. In many of them there had been for more than a century a struggle between the old patrician families and the democratic guilds. Louis could not always follow his own impulses, but whenever he could he associated himself with the latter party. Thus in his day the government of the imperial cities became more democratic and industry and trade flourished as they had never before done. The steady dislike of the princes was the best proof of the importance of the cities. They contained elements capable of enormous development; and had a great king arisen he might even yet, by their means, have secured for Germany a truly national life.

In January 1349 the friends of the late emperor elected Günther, count of Schwarzburg, as their king, but before this occurrence Charles of Moravia, by a liberal use of gifts and promises, had won over many of his enemies, prominent among whom were the cities. In a few months Günther himself abandoned the struggle, dying shortly afterwards, and about the same time his victorious rival was recognized by Louis of Brandenburg, the head of the Wittelsbach family. As king of Bohemia Charles was an enlightened and capable ruler, but he was indifferent towards Germany, although this country never stood in more urgent need of a strong and beneficent sovereign. In the early years of the reign the people, especially in the south and west, attacked and plundered the Jews; and the consequent disorder was greatly increased by the ravages of the Black Death and by the practices and preaching of the Flagellants, both events serving to spur the maddened populace to renewed outrages on the Jews. In dealing with this outburst of fanaticism many of the princes, both spiritual and secular, displayed vigour and humanity, but Charles saw only in the sufferings of this people an excuse for robbing them of their wealth.

Charles's most famous achievement was the issue of the Golden Bull (*q.v.*). Although the principle of election had long been admitted and practised with regard to the German crown, yet it was surrounded by many practical difficulties. For instance, if the territory belonging to an electoral family were divided, as was often the case, it had never been settled whether all the ruling princes were to vote, or, if one only were entitled to this privilege, by what principle the choice was to be made. Over these and other similar points many disputes had arisen, and, having been crowned emperor at Rome in April 1355, Charles decided to set these doubts at rest. The Golden Bull, promulgated in January 1356 and again after some tedious negotiations in December of the same year, fixed the number of electors at seven, Saxe-Wittenberg and not Saxe-Lauenburg obtaining the Saxon vote, and the vote of the Wittelsbachs being given to the ruler of the Rhenish Palatinate and not to the duke of Bavaria. The votes of a majority of the electors were held to make an election valid. In order that there might be no possibility of dispute between the princes of a single house, the countries ruled by the four secular electors—Bohemia, the Rhenish Palatinate, Saxony and Brandenburg—were declared to be indivisible and to be heritable only by the accepted rules of primogeniture. The electors were granted full sovereign rights over their lands,

and their subjects were allowed to appeal to the royal or the imperial tribunals only in case they could not obtain justice elsewhere. A blow was struck at the cities, which were forbidden to form leagues or to receive *Pfahlbürger*.

If the Golden Bull be excepted, the true interest of this reign is in the movements beyond the range of the emperor's influence. It is significant that at this time the *Femgerichte*, or Fehmlic Courts (*q.v.*), vastly extended the sphere of their activities, and that in the absence of a strong central authority they were respected as a check upon the lawlessness of the princes. The cities, notwithstanding every kind of discouragement, formed new associations for mutual defence or strengthened those which already existed. The Hanseatic League carried on war with Valdemar V., king of Denmark, and his ally, the king of Norway, seventy-seven towns declaring war on these monarchs in 1367, and emerged victorious from the struggle, while its commerce extended to nearly all parts of the known world. In 1376 some Swabian towns formed a league which, in spite of the imperial prohibition, soon became powerful in south-west Germany and defeated the forces of the count of Württemberg at Reutlingen in May 1377. The emperor, meanwhile, was occupied in numerous intrigues to strengthen his personal position and to increase the power of his house. In these he was very fortunate, managing far more than his predecessors to avoid conflicts with the Papacy and the princes. The result was that when he died in November 1378 he wore the crowns of the Empire, of Germany, of Bohemia, of Lombardy and of Burgundy; he had added Lower Lusatia and parts of Silesia to Bohemia; he had secured the mark of Brandenburg for his son Wenceslaus in 1373; and he had bought part of the Upper Palatinate and territories in all parts of Germany.

After the death of Charles, his son Wenceslaus, who had been crowned German king in July 1376, was recognized by the princes as their ruler, but the new sovereign was careless and indolent and in a few years he left Germany to look after itself. During his reign the struggle between the princes and the cities reached its climax. Following the example set by the electors at Rense both parties formed associations for protection, prominent among these being the Swabian League on the one side and the League of the Lion (*Löwenbund*)¹ on the other. The result was that the central authority was almost entirely disregarded. Wenceslaus favoured first one of the antagonists and then the other, but although he showed some desire to put an end to the increasing amount of disorder he was unable, or unwilling, to take a strong and definite line of action. The cities entered upon the approaching contest at a considerable disadvantage. Often they were separated one from the other by large stretches of territory under the rule of a hostile prince and their trade was peculiarly liable to attack by an adventurous body of knights. The citizens, who were called upon to fight their battles, were usually unable to contend successfully with men whose whole lives had been passed in warfare; the isolation of the cities was not favourable to the creation or mobilization of an active and homogeneous force; and, moreover, at this time many of them were disturbed by internal troubles. However, they minimized this handicap by joining league to league; in 1381 the Swabian and the Rhenish cities formed an alliance for three years, while the Swabian League obtained promises of help from the Swiss.

The Swiss opened the fight. Attacked by the Habsburgs they defeated and killed Duke Leopold of Austria at Sempach in July 1386 and gained another victory at Näfels two years later; but their allies, the Swabian cities, were not equally prompt or equally fortunate. The decisive year was 1388, when the strife became general all over south-west Germany. In August 1388 the princes, under Count Eberhard of Württemberg, completely defeated their foes at Döffingen, while in the following November Rupert II., elector palatine of the Rhine, was equally successful in his attack on the forces of the Rhenish cities near Worms.

¹So called from the badge worn by the knights (*Löwenritter*) who composed it.

The domestic policy of Louis.

Charles IV. becomes King.

The Golden Bull.

Palatin Courts.

Wenceslaus.

General disorder in Germany.

Exhaustion soon compelled the combatants to come to terms, and greatly to the disadvantage of the cities peace was made in 1389. The main result of this struggle was everywhere to strengthen the power of the princes and to incite them to fresh acts of aggression. During the same time the Hanse towns were passing through a period of difficulty. They were disturbed by democratic movements in many of the cities and they were threatened by the changing politics of the three northern kingdoms, Norway, Sweden and Denmark, and by their union in 1397; their trading successes had raised up powerful enemies and had embroiled them with England and with Flanders, and the Teutonic Order and neighbouring princes were not slow to take advantage of their other difficulties.

Towards the close of the century the discontent felt at the incompetent and absent German king took a decided form.

The movement was led by the four Rhenish electors, and after some preliminary proceedings these princes met in August 1400; having declared Wenceslaus dethroned they chose one of their number, the elector palatine Rupert III., in his stead, and the deposed monarch accepted the sentence almost without demur. Rupert was an excellent elector, and under more favourable circumstances would have made a good king, but so serious were the jealousies and divisions in the kingdom that he found little scope for his energies outside the Palatinate. In spite of the peace of 1389 the cities had again begun to form leagues for peace; but, having secured a certain amount of recognition in the south and west of Germany, the new king turned aside from the pressing problems of government and in 1401 made a futile attempt to reach Rome, an enterprise which covered him with ridicule. After his return to Germany he had to face the hostility of many of the princes, and this contest, together with vain attempts to restore order, occupied him until his death in May 1410.

After Rupert's death two cousins, Jobst, margrave of Moravia, and Sigismund, king of Hungary, were in the autumn of 1410 both chosen to fill the vacant throne by opposing parties; and the position was further complicated by the fact that the deposed king, Wenceslaus, was still alive. Jobst, however, died in January 1411, and in the succeeding July Sigismund, having come to terms with Wenceslaus, was again elected king and was generally recognized. The commanding questions of this reign were ecclesiastical. It was the age of the great schism, three popes claiming the allegiance of Christendom, and of the councils of Constance and of Basel; in all ranks of the Church there was an urgent cry for reform. Unfortunately the council of Constance, which met mainly through the efforts of Sigismund in 1414, marred its labours by the judicial murders of John Huss and of Jerome of Prague. This act greatly incensed the Bohemians, who broke into revolt in 1419, and a new and fiercer outburst occurred in 1420 when Sigismund, who had succeeded his brother Wenceslaus as king of Bohemia in the preceding August, announced his intention of crushing the Hussites. Led by their famous general, John Žižka, the Bohemians won several battles and spread havoc and terror through the neighbouring German lands. During the progress of this revolt Germany was so divided and her king was so poor that it was impossible to collect an army of sufficient strength to crush the malcontents. At the diet of Nuremberg in 1422 and at that of Frankfort in 1427 Sigismund endeavoured to raise men and money by means of contributions from the estates, but the plan failed owing to mutual jealousies and especially to the resistance of the cities. He secured some help from Frederick of Brandenburg, from Albert of Austria, afterwards the German king Albert II., and from Frederick of Meissen, to whom he granted the electoral duchy of Saxe-Wittenberg; but it was only when the Hussites were split into two factions, and when Žižka was dead, that Germany was in any way relieved from a crushing and intolerable burden.

The continual poverty which hindered the successful prosecution of the war against the Hussites, and which at times placed Sigismund in the undignified position of having to force himself

as an unwelcome guest upon princes and cities, had, however, one good result. In 1415 he granted, or rather sold, the mark of Brandenburg to his friend Frederick of Hohen-zollern, burgrave of Nuremberg, this land thus passing into the hands of the family under whom it was destined to develop into the kingdom of Prussia. During this reign the princes, especially the electors, continued their endeavours to gain a greater share in the government of Germany, and to some extent they succeeded. Sigismund, on his part, tried to enforce peace upon the country by forming leagues of the cities, but to no purpose; in fact all his plans for reform came to nothing.

Sigismund, who died in December 1437, was succeeded on the German throne and also in Hungary and Bohemia by his son-in-law Albert of Austria, and from this time, although remaining in theory elective, the German crown was always conferred upon a member of the house of Habsburg until the extinction of the male line of this family in 1740. The reign of Albert II. was too short to enable him to do more than indicate his good intentions; he acted in general with the electors in observing a neutral attitude with regard to the dispute between the council of Basel and Pope Eugenius IV., and he put forward a scheme to improve the administration of justice. He died in October 1439, and was succeeded by his kinsman Frederick, duke of Styria, who became German king as Frederick IV. and, after his coronation at Rome in 1452, emperor as Frederick III.

The first concern of the new king was with the papal schism. The council of Basel was still sitting, and had elected an anti-pope, Felix V., in opposition to Eugenius IV., while the electors, adhering to their neutral attitude, sought to bring Frederick into line with them on this question. Some years were occupied in negotiations, but the king soon showed himself anxious to come to terms with Eugenius, and about 1446 the electors ceased to act together. At length peace was made. The consent of several of the electors having been purchased by concessions, Frederick signed with Pope Nicholas V., the successor of Eugenius, in February 1448 the concordat of Vienna, an arrangement which bound the German Church afresh to Rome and perpetuated the very evils from which earnest churchmen had been seeking deliverance. Thus Germany lost the opportunity of reforming the Church from within, and the upheaval of the 16th century was rendered inevitable.

Frederick's reign is one of great importance in the history of Austria and of the house of Habsburg, but under him the fortunes of Germany sank to the lowest possible point. Without any interference from the central authority wars were waged in every part of the country, and disputes of every kind were referred to the decision of the sword.

The old enmity between the cities and the princes blazed out afresh; grievances of every kind were brought forward and many struggles were the result. Perhaps the most famous of these was one between a confederation of Franconian and Swabian cities under the leadership of Nuremberg on the one side, and Albert Achilles, afterwards elector of Brandenburg, and a number of princes on the other. The war was carried on with great barbarity for about four years (1449-1453), and was in every respect a critical one. If the cities had gained the day they might still have aimed at balancing the power of the princes, but owing partly to their imperfect union, partly to the necessity of fighting with hired troops, they did not gain any serious advantage. On the whole, indeed, in spite of temporary successes, they decidedly lost ground, and on the conclusion of peace there was no doubt that the balance of power in the state inclined to the princes. Frederick meanwhile was involved in wars with the Swiss, with his brother Albert and his Austrian subjects, and later with the Hungarians. He had no influence in Italy; in Burgundy he could neither stop Duke Philip the Good from adding Luxemburg to his possessions, nor check the towering ambition of Charles the Bold; while after the death of Charles in 1477 he was equally unable to prevent the king of

France from seizing a large part of his lands. Torn by dissensions the Teutonic Order was unsuccessful in checking the encroachments of the Poles, and in 1466 the land which it had won in the north-east of Germany passed under the suzerainty of Poland, care being taken to root out all traces of German influence therein. Another loss took place in 1460, when Schleswig and Holstein were united with Denmark. In Germany itself the king made scarcely any pretence of exercising the supreme authority; for nearly thirty years he never attended the imperial diet; and the suggestions which were made for his deposition failed only because the electors could not agree upon a successor. In his later years he became more of a recluse than ever, and even before February 1486, when his son Maximilian was chosen German king, he had practically ceased to take any part in the business of the Empire, although he survived until August 1493.

During the reign of Frederick the electors and the greater princes continued the process of consolidating and increasing their power. Lands under their rule, which were technically imperial fiefs, were divided and devised by them at will like other forms of private property; they had nearly all the rights of a sovereign with regard to levying tolls, coining money, administering justice and granting privileges to towns; they were assisted in the work of government by a privy council, while their courts with their numerous officials began to resemble that of the king or emperor. They did not, however, have everything their own way. During this century their power was limited by the formation of diets in many of the principalities. These bodies were composed of the mediate prelates, the mediate nobles and representatives of the mediate cities. They were not summoned because the princes desired their aid, but because arms could only be obtained from the nobles and money from the cities, at least on an adequate scale. Once having been formed these local diets soon extended their functions. They claimed the right of sanctioning taxation; they made their voice heard about the expenditure of public money; they insisted, although perhaps not very effectually, on justice being administered. Such institutions as these were clearly of the highest importance, and for two centuries they did something to atone for the lack of a genuine monarchy.

During this reign the conditions of warfare began to change. The discovery of gunpowder made small bodies of men, adequately armed, more than a match for great forces equipped in medieval fashion. Hence the custom of hiring mercenary troops was introduced, and a prince could never be certain, however numerous his vassals might be, that the advantage would not rest with his opponent. This fact, added to the influence of the local diets, made even the princes weary of war, and a universal and continuous demand arose for some reform of the machinery of government. Partly at the instance of the emperor a great Swabian confederation was formed in 1488. This consisted of both princes and cities and was intended to enforce the public peace in the southwestern parts of Germany. Its effects were excellent; but obviously no partial remedy was sufficient. It was essential that there should be some great reform which would affect every part of the kingdom, and for the present this was not to be secured.

Maximilian came to the throne in 1486 with exceptional advantages. He was heir to the extensive Austrian lands, and as the widowed husband of Charles the Bold's daughter Mary he administered the Netherlands. Although he soon gave up these provinces to his son Philip, the fact that they were in the possession of his family added to his influence, and this was further increased when Philip married Joanna, the heiress of the Spanish kingdoms. From Maximilian's accession the Empire exercised in the affairs of Europe an authority which had not belonged to it for centuries. The reason for this was not that the Empire was stronger, but that its crown was worn by a succession of princes who were great sovereigns in their own right.

Having in 1490 driven the Hungarians from Vienna and recovered his hereditary lands, and having ordered the affairs of the Netherlands, Maximilian turned his attention to Italy,

whither he was drawn owing to the invasion of that country by Charles VIII. of France in 1494. But before he could take any steps to check the progress of Charles pecuniary necessities compelled him to meet the diet. At this time the German, or imperial, diet consisted of three colleges, one of the electors, another of the princes, both spiritual and secular, and a third of representatives of the free cities, who had, however, only just gained the right to sit beside the other two estates. The diet was an extremely clumsy instrument of government, and it was perhaps never more discredited or more impotent than when it met Maximilian at Worms in March 1495. But in spite of repeated rebuffs the party of reform was valorous and undaunted; its members knew that their case was overwhelmingly strong. Although disappointed in the hope which they had nourished until about 1490 that Maximilian himself would lead them, they had found a capable head in Bertold, elector of Mainz. The king lost no time in acquainting the diet with his demands. He wished for men and money to encounter the French in Italy and to resist the Turks. Bertold retorted that redress of grievances must precede supply, and Maximilian and the princes were soon discussing the proposals put forward by the sagacious elector. His first suggestion that a council nominated by the estates should be set up with the power of vetoing the acts of the king was abandoned because of the strenuous opposition of Maximilian; but Bertold was successful in getting the diet to proclaim an eternal *Landfriede*, that is, to forbid private war without any limitation of time, and it was agreed that the diet should meet annually to advise the king on matters of moment. The idea of a council, however, was not given up although it took a different form. An imperial court of justice, the *Reichskammergericht*, was established; this consisted of sixteen members nominated by the estates and a president appointed by the king. Its duties were to judge between princes of the Empire and to act as the supreme court of appeal in cases where humbler persons were concerned. Partly to provide for the expenses of this court, partly to furnish Maximilian with the promised monetary aid, a tax called the common penny was instituted, this impost taking the form both of a property tax and of a poll tax. Such in outline were the reforms effected by the important diet of Worms.

The practical difficulties of the reformers, however, were only just beginning. Although Maximilian took some interest in the collection of the common penny it was difficult, *Dans* and from some classes impossible, to obtain payment *causes* of this tax, and the king was persistently hostile *and* to the imperial court of justice, his hostility and the want *return* of money being indeed successful in preventing that institution for a time from doing any real service to Germany. In 1497 he set up a new Aulic council or *Hofrat*, the members of which were chosen by himself, and to this body he gave authority to deal with all the business of the Empire. Thus he undermined the foundations of the *Reichskammergericht* and stole a march upon Bertold and his friends. A series of diets between 1495 and 1499 produced only mutual recriminations, and then Maximilian met with a serious rebuff. The Swiss refused to pay the common penny and to submit to the jurisdiction of the imperial court of justice. Consequently, in 1499, Maximilian sent such troops as he could collect against them, but his forces were beaten, and by the peace of Basel he was forced to concede all the demands made by the Swiss, who became virtually independent of the Empire. Heartened by this circumstance Bertold and his followers returned to the attack when the diet met at Augsburg in 1500. The common penny as a means of taxation fell into the background, and in its place a scheme was accepted which it was thought would provide the king with an army of about 30,000 men. But more important perhaps was the administrative council, or *Reichsregiment*, which was established by the diet at this time. A revival of the idea put forward by the elector of Mainz at Worms in 1495, this council was to consist of twenty members appointed by the electors and other princes and by representatives of the cities, with a president named by the king. Its work was practically that of

Reforms in Germany, 1495.

governing Germany, and it was the most considerable encroachment which had yet been made on the power of the king. It is not surprising therefore that Maximilian hated the new body, to the establishment of which he had only consented under great pressure.

In 1500 the *Reichsregiment* met at Nuremberg and began at once to treat for peace with France. Maximilian was not slow to resent this interference; he refused to appoint a president, and soon succeeded in making the meetings of the council impossible. The relations between the king and the princes were now very strained. Bertold called the electors together to decide upon a plan of campaign; Maximilian on his part tried to destroy the electoral union by winning over individual members. The result was that when the elector of Mainz died in 1504 the king's victory was complete. The *Reichskammergericht* and the *Reichsregiment* were for all practical purposes destroyed, and greater authority had been given to the *Hofrat*. Henceforward it was the king who put forward schemes of reform and the diet which modified or rejected them. When the diet met at Cologne in 1505 Maximilian asked for an army and the request was granted, the necessary funds being raised by the old plan of a levy on the estates. At Constance, two years later, the diet raised men and money in a similar fashion, and on this occasion the imperial court of justice was restored, with some slight alteration in the method of appointing its members. After Maximilian had taken the novel step of assuming the title of Roman emperor at Trent in 1508 the last of the reforming diets met at Cologne in 1512. In 1500 Germany had been divided into six circles (*Kreise*) or districts, for the purpose of sending representatives to the *Reichsregiment*. These circles were now increased in number to ten and an official (*Hauptmann*) was placed over each, his duties being to enforce the decisions of the *Reichskammergericht*. But it was some time before the circles came into working order; the only permanent reform of the reign was the establishment of the imperial court of justice, and even this was not entirely satisfactory, Maximilian's remaining diets loudly denouncing it for delay and incompetence. The period marked by the attempted reform of Bertold of Mainz was that of the last struggle between the supporters of a united Germany and those who preferred a loose confederation of states. Victory remained with the latter party. Maximilian himself had done a great deal to promote the unity of his Austrian lands and, incidentally, to cut them off from the remainder of the German kingdom, and other princes were following his example. This movement spelled danger to the small principalities and to the free cities, but it gave a powerful impetus to the growth of Brandenburg, of Saxony, of Bavaria and of the Palatinate, and the future of the country seemed likely to remain with the particularist and not with the national idea.

During the period of these constitutional struggles the king's chief energies were spent in warring against the French kings Charles VIII. and Louis XII. in Italy, where he hoped to restore the claims, dormant, perhaps even extinct, of the German kings. In 1508 he helped to promote the league of Cambrai, formed to despoil Venice, but he soon returned to his former policy of waging war against France, and he continued to do this until peace was made in 1516. The princes of Germany showed themselves singularly indifferent to this struggle, and their king's battles were largely fought with mercenary troops. Maximilian gained his most conspicuous success in his own kingdom in 1504, when he interfered in a struggle over the succession to the duchy of Bavaria-Landsbut. He gained some additions of territory, but his victory was more important because it gave him the prestige which enabled him to break down the opposition of the princes and to get his own way with regard to his domestic policy.

In many respects the reign of Maximilian must be regarded as the end of the middle ages. The feudal relation between the king and the princes and between the princes and their vassals had become purely nominal. No real control was exerted by the

crown over the heads of the various states, and, now that war was carried on mainly by mercenary troops, the mediate nobles did not hold their lands on condition of military service.

The princes were sovereigns, not merely feudal lords; and by the institution of local diets in their territories an approach was made to modern conceptions of government. The age of war was far indeed from being over, but men were at least beginning to see that unnecessary bloodshed is an evil, and that the true outlet for the mass of human energies is not conflict but industry. By the growth of the cities in social, if not in political, importance the products of labour were more and more widely diffused; and it was easier than at any previous time for the nation to be moved by common ideas and impulses. The discovery of America, the invention of printing, the revival of learning and many other causes had contributed to effect a radical change in the point of view from which the world was regarded; and the strongest of all medieval relations, that of the nation to the Church, was about to pass through the fiery trial of the Reformation. This vast movement, which began in the later years of Maximilian, definitely severed the medieval from the modern world.

The seeds of the Reformation were laid during the time of the great conflict between the Papacy and the Empire. The arrogance and the ambition of the popes then stamped upon the minds of the people an impression that was never effaced. During the struggle of Louis IV. with the popes of his day the feeling revived with fresh intensity; all classes, clerical as well as lay, looked upon resistance to papal pretensions as a necessity imposed by the national honour. At the same time the spiritual teaching of the mystics awakened in many minds an aspiration which the Church, in its corrupt state, could not satisfy, and which was in any case unfavourable to an external authority. The Hussite movement further weakened the spell of the Church. Still more powerful, because touching other elements of human nature and affecting a more important class, was the influence of the Renaissance, which, towards the end of the 15th century, passed from Italy to the universities of Germany. The men of the new learning did not sever themselves from Christianity, but they became indifferent to it; its conceptions seemed to them dim and faded, while there was a constantly increasing charm in literature, in philosophy and in art. No kind of effort was made by the Church to prepare for the storm. The spiritual princes, besides displaying all the faults of the secular princes, had special defects of their own; and as simony was universally practised, the lives of multitudes of the inferior clergy were a public scandal, while their services were cold and unimpressive. The moral sense was outraged by such a pope as Alexander VI.; and neither the military ambition of Julius II. nor the refined paganism of Leo X. could revive the decaying faith in the spirituality of their office. Pope Leo, by his incessant demands for money and his unscrupulous methods of obtaining it, awakened bitter hostility in every class of the community.

The popular feeling for the first time found expression when Luther, on All Saints' day 1517, nailed to a church door in Wittenberg the theses in which he contested the doctrine which lay at the root of the scandalous traffic in indulgences carried on in the pope's name by Tetzel and his like. This episode, derided at first at Rome as the act of an obscure Augustinian friar intent on scoring a point in a scholastic disputation, was in reality an event of vast significance, for it brought to the front, as the exponent of the national sentiment, one of the mightiest spirits whom Germany has produced. Under the influence of Luther's strong personality the most active and progressive elements of the nation were soon in more or less open antagonism to the Papacy.

When Maximilian died in January 1550 his throne was competed for by his grandson Charles, king of Spain, and by Francis I. of France, and after a long and costly contest the former was chosen in the following June. By the time Charles reached Germany and was crowned at Aix-la-Chapelle (October 1520)

Decay of feudal relations.

The Reformation.

Luther.

Maximilian hampers the reformers.

Luther had confronted the cardinal legate Cajetan, had passed through his famous controversy at Leipzig with Johann Eck, and was about to burn the bull of excommunication.

Charles V. After this daring step retreat was impossible, and with keen excitement both the reformer's followers and Luther.

his enemies waited for the new sovereign to declare himself on one side or on the other. Charles soon made up his mind about the general lines of his policy, although he was completely ignorant of the strength of the feeling which had been aroused. He fancied that he had to deal with a mere monkish quarrel; at one time he even imagined that a little money would set the difficulty at rest. It was not likely, however, in any case that he would turn against the Roman Church, and that for various reasons. He was by far the most important ruler of the time, and the peoples under his direct sway were still adherents of the old faith. He was king of Spain, of Sicily, of Naples and of Sardinia; he was lord of the Netherlands, of the free county of Burgundy and of the Austrian archduchies; he had at his command the immense resources of the New World; and he had been chosen king of Germany, thus gaining a title to the imperial crown. Following the example set by Maximilian he called himself emperor without waiting for the formality of a coronation at Rome. Now the protection of the Church had always been regarded as one of the chief functions of the emperors; Charles could not, therefore, desert it when it was so greatly in need of his services. Like his predecessors he reserved to himself the right to resist it in the realm of politics; in the realm of faith he considered that he owed to it his entire allegiance. Moreover, he intended to undertake the subjugation of northern Italy, a task which had baffled his imperial grandfather, and in order to realize this scheme it was of the highest importance that he should do nothing to offend the pope. Thus it came about that at the diet of Worms, which met in January 1521, without any thorough examination of Luther's position, Charles issued the famous edict, drawn up by Cardinal Aleandro, which denounced the reformer and his followers. This was accepted by the diet and Luther was placed under the imperial ban.

When Charles was chosen German king he was obliged to make certain promises to the electors. Embodied in a *Wahlkapitulation*, as it was called, these were practically the conditions on which the new sovereign was allowed to take the crown, and the precedent was followed at subsequent elections. At the diet of Worms steps were taken to carry these promises into effect. By his *Wahlkapitulation* Charles had promised to respect the freedom of Germany, for the princes looked upon him as a foreigner. He was neither to introduce foreign troops into the country, nor to allow a foreigner to command German soldiers; he must use the German language and every diet must meet on German soil. An administrative council, a new *Reichsregiment*, must be established, and other reforms were to be set on foot. The constitution and powers of this *Reichsregiment* were the chief subject of difference between Charles and the princes at the diet. Eventually it was decided that this council should consist of twenty-two members with a president named by the emperor; but it was only to govern Germany during the absence of the sovereign, at other times its functions were merely advisory. The imperial chamber was restored on the lines laid down by Bertold of Mainz in 1495 (it survived until the dissolution of the Empire in 1806), and the estates undertook to aid the emperor by raising and paying an army. In April 1521 Charles invested his brother Ferdinand, afterwards the emperor Ferdinand I., with the Austrian archduchies, and soon afterwards he left Germany to renew his long struggle with Francis I. of France.

While the emperor was thus absent great disturbances took place in Germany. Among Luther's friends was one, Ulrich Hutten, at once penetrated with the spirit of the Renaissance and emphatically a man of action. The class to which Hutten and his friend, Franz von Sickingen, a daring and ambitious Rhenish baron, belonged, was that of the small feudal tenants in chief, the

Ritterschaft or knights of the Empire. This class was subject only to the emperor, but its members lacked the territorial possessions which gave power to the princes; they were partly deprived of their employment owing to the suppression of private wars, and they had suffered through the substitution of Roman law for the ancient feudal laws and customs. They had no place in the constitution or in the government of Germany, and they had already paralysed the administration by refusing to pay the taxes. They were intensely jealous of the princes, and it occurred to Hutten and Sickingen that the Reformation might be used to improve the condition of the knights and to effect a total change in the constitution of the Empire. No general reform, they maintained, either in church or state, could be secured while the country was divided into a number of principalities, and their plan was to combine with all those who were discontented with the existing order to attack the princes and to place the emperor at the head of a united nation. Sickingen, who has been compared to Wallenstein, and who doubtless hoped to secure a great position for himself, had already collected a large army, which by its very presence had contributed somewhat to the election of Charles at Frankfurt in 1519. He had also earned renown by carrying on feuds with the citizens of Worms and of Metz, and now, with a view to realizing his larger ambitions, he opened the campaign (August 1522) by attacking the elector of Trier, who, as a spiritual prince, would not, it was hoped, receive any help from the religious reformers. For a moment it seemed as if Hutten's dream would be realized, but it was soon evident that it was too late to make so great a change. Luther and other persons of influence stood aloof from the movement; on the other hand, several princes, including Philip, landgrave of Hesse, united their forces against the knights, and in May 1523 Sickingen was defeated and slain. A few weeks later Hutten died on an island in the lake of Zürich.

This war was followed by another of a much more serious nature. The German peasants had grievances compared with which those of the knights and lesser barons were imaginary. For about a century several causes had tended to make their condition worse and worse. While taxes and other burdens were increasing the power of the king to protect them was decreasing; with or without the forms of law they were plundered by every other class in the community; their traditional privileges were withdrawn and, as in the case of the knights, their position had suffered owing to the introduction of Roman law into Germany. In the west and south-west of the country especially, opportunities of migration and of expansion had been gradually reduced, and to provide for their increasing numbers they were compelled to divide their holdings again and again until these patches of land became too small for the support of a household. Thus, solely under the influence of social and economic conditions, various risings of the peasants had taken place during the latter part of the 15th century, the first one being in 1461, and at times the insurgents had combined their forces with those of the lower classes in the towns, men whose condition was hardly more satisfactory than their own. In the last decade of the 15th and the first decade of the 16th century there were several insurrections in the south-west of Germany, each of which was called a *Bundschuh*, a shoe fastened upon a pole serving as the standard of revolt. In 1514 Württemberg was disturbed by the rising of "poor Conrad," but these and other similar revolts in the neighbourhood were suppressed by the princes. These movements, however, were only preludes to the great revolution, which is usually known as the Peasants' War (*Bauernkrieg*).

The Renaissance and the Reformation were awakening extravagant hopes in the minds of the German peasants, and it is still a matter of controversy among historians to what extent Luther and the reformers were responsible for their rising. It may, however, be stated with some certainty that their condition was sufficiently wretched to drive them to revolt without any serious pressure from outside. The rising was due primarily neither to religious nor to political,

Sickingen's rising.

The causes of the Peasants' War.

The Peasants' War.

Charles and the movement for reform.

but to economic causes. The Peasants' War, properly so called, broke out at Stühlingen in June 1522. The insurgents found a leader in Hans Müller of Bulgenbach, who gained some support in the surrounding towns, and soon all Swabia was in revolt. Quickly the insurrection became general all over central and southern Germany. In the absence of the emperor and of his brother, the archduke Ferdinand, the authorities in these parts of the country were unable to check the movement and, aided by many knights, prominent among whom was Götz von Berlichingen, the peasants were everywhere victorious, while another influential recruit, Ulrich, the dispossessed duke of Württemberg, joined them in the hope of recovering his duchy. Ulrich's attempt, which was made early in 1525, was, however, a failure, and about the same time the peasants drew up twelve articles embodying their demands. These were sufficiently moderate. They asked for a renewal of their ancient rights of fishing and hunting freely, for a speedier method of obtaining justice, and for the removal of new and heavy burdens. In many places the lords yielded to these demands, among those who granted concessions being the elector palatine of the Rhine, the bishops of Bamberg and of Spire, and the abbots of Fulda and of Hersfeld. But meanwhile the movement was spreading through Franconia to northern Germany and was especially formidable in Thuringia, where it was led by Thomas Münzer. Here again success attended the rebel standards. But soon the victorious peasants became so violent and so destructive that Luther himself urged that they should be sternly punished, and a number of princes, prominent among whom was Philip of Hesse, banded themselves together to crush the rising. Münzer and his followers were defeated at Frankenhäusen in May, the Swabian League gained victories in the area under its control, successes were gained elsewhere by the princes, and with much cruelty the revolt of the peasants was suppressed. The general result was that the power of the territorial lords became greater than ever, although in some cases, especially in Tirol and in Baden, the condition of the peasants was somewhat improved. Elsewhere, however, this was not the case; many of the peasants suffered still greater oppression and some of the immediate nobles were forced to submit to a detested yoke.

Before the suppression of this rising the *Reichsregiment* had met with very indifferent success in its efforts to govern Germany.

Meeting at Nuremberg early in 1522 it voted some slight assistance for the campaign against the invading Turks, but the proposals put forward for raising the necessary funds aroused much opposition, an opposition which came mainly from the large and important cities. The citizens appealed to Charles V., who was in Spain, and after some hesitation the emperor decided against the *Reichsregiment*. Under such disheartening conditions it is not surprising that this body was totally unable to cope with Sickingen's insurrection, and that a few weeks after its meeting at Nuremberg in 1524 it succumbed to a series of attacks and disappeared from the history of Germany. But the *Reichsregiment* had taken one step, although this was of a negative character. It had shown some sympathy with the reformers and had declined to put the edict of Worms into immediate execution. Hardly less lukewarm, the imperial diet ordered the edict to be enforced, but only as far as possible, and meanwhile the possibilities of accommodation between the two great religious parties were becoming more and more remote. A national assembly to decide the questions at issue was announced to meet at Spire, but the emperor forbade this gathering. Then the Romanists, under the guidance of Cardinal Campeggio and the archduke Ferdinand, met at Regensburg and decided to take strong and aggressive measures to destroy Lutheranism, while, on the other hand, representatives of the cities met at Spire, and asserted their intention of forwarding and protecting the teaching of the reformed doctrines. All over the country and through all classes of the people men were falling into line on one side or the other, and everything was thus ready for a long and bitter religious war.

During these years the religious and political ideas of the Reformation were rapidly gaining ground, and, aided by a

vigorous and violent polemic literature, opposition to Rome was growing on every side. Instigated by George of Saxony the Romanist princes formed a defensive league at Dessau in 1525; the reforming princes took a similar step at Gotha in 1526. Such were the prevailing conditions when the diet met at Spire in June 1526 and those who were still loyal to the Roman Church clamoured for repressive measures. But on this occasion the reformers were decidedly in the ascendant. Important ecclesiastical reforms were approved, and instructions forbidding all innovations and calling upon the diet to execute the edict of Worms, sent by the emperor from Spain, were brushed aside on the ground that in the preceding March when this letter was written Charles and the pope were at peace, while now they were at war. Before its dissolution the diet promulgated a decree providing that, pending the assembly of a national council, each prince should order the ecclesiastical affairs of his own state in accordance with his own conscience, a striking victory for the reformers and incidentally for separatist ideas. The three years which elapsed between this diet and another important diet which met in the same city are full of incident. Guided by Luther and Melancthon, the principal states and cities in which the ideas of the reformers prevailed—electoral Saxony, Brandenburg, Hesse and the Rhenish Palatinate, Strassburg, Nuremberg, Ulm and Augsburg—began to carry out measures of church reform. The Romanists saw the significance of this movement and, fortunately for them, were able to profit by the dissensions which were breaking out in the ranks of their opponents, especially the doctrinal differences between the followers of Luther and those of Zwingli. Persecutions for heresy had begun, the feeling between the two great religious parties being further embittered by some revelations made by Otto von Pack (q.v.) to Philip of Hesse. Pack's stories, which concerned the existence of a powerful league for the purpose of making war upon the reformers, were proved to be false, but the soreness occasioned thereby remained. The diet met in February 1529 and soon received orders from the emperor to repeal the decree of 1526. The supporters of the older faith were now predominant and, although they were inclined to adopt a somewhat haughty attitude towards Charles, they were not averse from taking strong measures against the reformers. The decree of the diet, formulated in April, forbade the reformers to make further religious changes, while the toleration which was conceded to Romanists in Lutheran states was withheld from Lutherans in Romanist states. This decree was strongly resented by the reforming princes and cities. They drew up a formal protest against it (hence the name "Protestant"), which they presented to the archduke Ferdinand, setting forward the somewhat novel theory that the decree of 1526 could not be annulled by a succeeding diet unless both the parties concerned assented thereto. By this decree they declared their firm intention to abide.

The untiring efforts of Philip of Hesse to unite the two wings of the Protestant forces met with very little success, and the famous conference at Marburg in the autumn of 1529, for which he was responsible, revealed the fact that it was practically impossible for the Lutherans and the Zwinglians to act together even when threatened by a common danger, while a little later the alliance between the Lutheran states of north Germany and the Zwinglian cities of the south was destroyed by differences upon points of doctrine. In 1530 the emperor, flushed with success in Italy and at peace with his foreign foes, came to Germany with the express intention of putting an end to heresy. In June he opened the diet at Augsburg, and here the Lutherans submitted a summary of their doctrines, afterwards called the Augsburg Confession. Drawn up by Melancthon, this pronouncement was intended to widen the breach between the Lutherans and the Zwinglians, and to narrow that between the Lutherans and the Romanists; from this time it was regarded as the chief standard of the Lutheran faith. Four Zwinglian cities, Strassburg, Constance, Lindau and Memmingen, replied with a confession of their own and the Romanists also drew up an answer. The period of

Progress of the Reformation.

The diet of Augsburg.

negotiation which followed served only to show that no accommodation was possible. Charles himself made no serious effort to understand the controversy; he was resolved, whether the Lutherans had right on their side or not, that they should submit, and he did not doubt but that he would be able to awe them into submission by an unwonted display of power. But to his surprise the Lutheran princes who attended the diet refused to give way. They were, however, outnumbered by their enemies, and it was the Romanist majority which dictated the terms of the decree, which was laid before the diet in September, enjoining a return to religious conformity within seven months. The Protestant princes could only present a formal protest and leave Augsburg. Finally the decree of the diet, promulgated in November, ordered the execution of the edict of Worms, the restoration of all church property, and the maintenance of the jurisdiction of the bishops. The duty of enforcing the decree was especially entrusted to the *Reichshammergericht*; thus by the processes of law the Protestant princes were to be deprived of much of their property, and it seemed probable that if they did not submit the emperor would have recourse to arms.

For the present, however, fresh difficulties with France and an invasion by the Turks, who had besieged Vienna with an immense army in the autumn of 1529, forced Charles to mask his designs. Meanwhile some of the Lutherans, angered and alarmed by the decisions of the *Reichshammergericht*, abandoned the idea that resistance to the imperial authority was unlawful and, meeting in December 1530, laid the foundation of the important league of Schmalkalden, among the first members of the confederation being the rulers of Saxony and Hesse and the cities of Bremen and Magdeburg. The league was soon joined by other strong cities, among them Strassburg, Ulm, Constance, Lübeck and Goslar; but it was not until after the defeat and death of Zwingli at Kappel in October 1531 that it was further strengthened by the adhesion of those towns which had hitherto looked for leadership to the Swiss reformer. About this time the military forces of the league were organized, their heads being the elector of Saxony and the landgrave of Hesse. But the league had a political as well as a religious aspect. It was an alliance between the enemies of the house of Habsburg, and on this side it gained the support of the duke of Bavaria and treated with Francis I. of France. To this its rapid growth was partly due, but more perhaps to the fact that the Reformation in Germany was above all things a popular movement, and thus many princes who would not have seceded from the Roman Church of their own accord were compelled to do so from political motives. They had been strong enough to undermine the imperial power; they were not strong enough to resist the pressure put upon them by a majority of their subjects. It was early in 1532, when faced with the necessity of resisting the Turkish advance, that Charles met the diet at Regensburg. He must have men and money for this purpose even at the price of an arrangement with the Protestants. But the Lutherans were absent from the diet, and the Romanists, although they voted help, displayed a very uncompromising temper towards their religious foes. Under these circumstances the emperor took the matter into his own hands, and his negotiations with the Protestants resulted in July 1532 in the religious peace of Nuremberg, a measure which granted temporary toleration to the Lutherans and which was repeatedly confirmed in the following years. Charles's reward was substantial and immediate. His subjects vied with each other in hurrying soldiers to his standard, and in a few weeks the great Turkish host was in full retreat.

While the probability of an alliance between Pope Clement VII. and Francis I. of France, together with other international complications, prevented the emperor from following up his victory over the Turks, or from reducing the dissenters from the Roman religion to obedience, Protestantism was making substantial progress in the states, notably in Anhalt and in Pomerania, and in the cities, and in January 1534 the Protestant princes were bold

enough to declare that they did not regard the decisions of the *Reichshammergericht* as binding upon them. About this time Germany witnessed three events of some importance. Through the energy of Philip of Hesse, who was aided by Francis I., Ulrich of Württemberg was forcibly restored to his duchy. The members of the Romanist league recently founded at Halle would not help the Habsburgs, and in June 1534, by the treaty of Cadan, King Ferdinand was forced to recognize the restoration as a *fait accompli*; at the same time he was compelled to promise that he would stop all proceedings of the *Reichshammergericht* against the members of the league of Schmalkalden. The two other events were less favourable for the new religion, or rather for its orthodox manifestations. After a struggle, the Anabaptists obtained control of Münster and for a short time governed the town in accordance with their own peculiar ideas, while at Lübeck, under the burgomaster Jürgen Wullenweber, a democratic government was also established. But the bishop of Münster and his friends crushed the one movement, and after interfering in the affairs of Denmark the Lübeckers were compelled to revert to their former mode of government. The outbreak of the war between the Empire and France in 1536 almost coincided with the enlargement of the league of Schmalkalden, the existence of which was prolonged for ten years. All the states and cities which subscribed to the confession of Augsburg were admitted to it, and thus a large number of Protestants, including the duchies of Württemberg and Pomerania and the cities of Augsburg and Frankfurt, secured a needful protection against the decrees of the *Reichshammergericht*, which the league again repudiated. Among the new members of the confederation was Christian III., king of Denmark. About the same time (May 1536) an agreement between the Lutherans and the Zwinglians was arranged by Martin Bucer, and was embodied in a document called the Concord of Wittenberg, and for the present the growing dissensions between the heads of the league, John Frederick, elector of Saxony, and Philip of Hesse, were checked. Thus strengthened the Protestant princes declared against the proposed general council at Mantua, while as a counterpoise to the league of Schmalkalden the imperial envoy, Mathias Held (d. 1563), persuaded the Romanist princes in June 1538 to form the league of Nuremberg. But, although he had made a truce with France at Nice in this very month, Charles V. was more conciliatory than some of his representatives, and at Frankfurt in April 1539 he came to terms with the Protestants, not, however, granting to them all their demands. In 1539, too, the Protestants received a great accession of strength, the Lutheran prince Henry succeeding his Romanist brother George as duke of Saxony. Ducal Saxony was thus completely won for the reformed faith, and under the politic elector Joachim II. the same doctrines made rapid advances in Brandenburg. Thus practically all North Germany was united in supporting the Protestant cause.

In 1542, when Charles V. was again involved in war with France and Turkey, who were helped by Sweden, Denmark and Scotland, the league of Schmalkalden took advantage of his occupations to drive its stubborn foe, Henry, duke of Brunswick-Wolfenbüttel, from his duchy and to enthroned Protestantism completely therein. But this was not the only victory gained by the Protestants about this time. The citizens of Regensburg accepted their doctrines, which also made considerable progress in the Palatinate and in Austria, while the archbishop of Cologne, Hermann von Wied, and William, duke of Gelderland, Cleves and Juliers, announced their secession from the Roman religion. The Protestants were now at the height of their power, but their ascendancy was about to be destroyed, and that rather by the folly and imprudence of their leaders than by the skill and valour of their foes. The unity and the power of the league of Schmalkalden were being undermined by two important events, the bigamy of Philip of Hesse, which for political reasons was condoned by the Lutheran divines, and the dissensions between John Frederick, the ruler of electoral, and Maurice, the new ruler of ducal Saxony. To save himself from the

The
League of
Schmal-
kalden.

Successes
of the
Protestants.

Internal
affairs of
Germany.

Their
defects.

consequences of his double marriage, which had provided him with powerful enemies, Philip in June 1541 came to terms with the emperor, who thus managed to spike the guns of the league of Schmalkalden, although the strength of this confederation did not fail until after the campaign against Henry of Brunswick. But while on the whole the fortunes of the European war, both in the east and in the west, were unfavourable to the imperialists, Charles V. found time in 1543 to lead a powerful force against William of Gelderland, who had joined the circle of his foreign foes. William was completely crushed; Gelderland was added to the hereditary lands of the Habsburgs, while the league of Schmalkalden impotently watched the proceedings. This happened about a year after war between the two branches of the Saxon house had only been averted by the mediation of Luther and of Philip of Hesse. The emperor, however, was unable, or unwilling, to make a more general attack on the Protestants. In accordance with the promises made to them at Frankfurt in 1539, conferences between the leaders of the two religious parties were held at Hagenau, at Worms and at Regensburg, but they were practically futile. The diets at Regensburg and at Nuremberg gave very little aid for the wars, and did nothing to solve the religious difficulties which were growing more acute with repeated delays. At the diet of Spire in 1544 Charles purchased military assistance from the Protestants by making lavish promises to them. With a new army he marched against the French, but suddenly in September 1544 he concluded the treaty of Crépy with Francis I. and left himself free to begin a new chapter in the history of Germany.

Charles was now nearly ready to crush the Protestants, whose influence and teaching had divided Germany and weakened the imperial power, and were now endangering the supremacy of the Habsburgs in the Netherlands and in Alsace. His plan was to bring about the meeting of a general council to make the necessary reforms in the church, and then at whatever cost to compel the Protestants to abide by its decisions. While Pope Paul III., somewhat reluctantly, summoned the council which ultimately met at Trent, Charles made vigorous preparations for war. Having made peace with the Turks in October 1545 he began to secure allies. Assistance was promised by the pope; the emperor purchased the neutrality of Duke William of Bavaria, and at a high price the active aid of Maurice of Saxony; he managed to detach from the league of Schmalkalden those members who were without any enthusiasm for the Protestant cause and also those who were too timid to enter upon a serious struggle. Meanwhile the league was inactive. Its chiefs differed on questions of policy, one section believing that the emperor did not intend to proceed to extremities, and for some time no measures were taken to meet the coming peril. At last, in June 1546, during the meeting of the diet at Regensburg, Philip and John Frederick of Saxony realized the extent of the danger and began to muster their forces. They were still much more powerful than the emperor, but they did not work well together, or with Sebastian Schärtlin von Burfenbach, who led their troops in South Germany. In July 1546 they were placed under the imperial ban, and the war began in the valley of the Danube. Charles was aided by soldiers hurried from Italy and the Netherlands, but he did not gain any substantial successes until after October 1546, when his ally Maurice invaded electoral Saxony and forced John Frederick to march northwards to its defence. The Lutheran cities of southern and central Germany, among them Strassburg, Augsburg, Ulm and Frankfurt, now submitted to the emperor, while Ulrich of Württemberg and the elector palatine of the Rhine, Frederick II., followed their example. Having restored Roman Catholicism in the archbishopric of Cologne and seen Henry of Brunswick settled in his duchy early in 1547, Charles led his men against his principal enemies, Philip of Hesse and John Frederick, who had quickly succeeded in driving Maurice from his electorate. At Mühlberg in April 1547 he overtook the army of the Saxon elector. His victory was complete. John Frederick was taken prisoner, and a little later Philip of Hesse, after vainly prolonging the struggle, was induced

to surrender. The rising in the other parts of northern Germany was also put down, and the two leaders of political Lutheranism were prisoners in the emperor's hands.

Unable to shake the allegiance of John Frederick to the Lutheran faith, Charles kept him and Philip of Hesse in captivity and began to take advantage of his triumph, although Magdeburg was still offering a stubborn resistance to his allies. By the capitulation of Wittenberg the electorate of Saxony was transferred to Maurice, and in the mood of a conqueror the emperor met the diet at Augsburg in September 1547. His proposals to strengthen and reform the administration of Germany were, however, not acceptable to the princes, and the main one was not pressed; but the Netherlands were brought under the protection of the Empire and some minor reforms were carried through. A serious quarrel with the pope, who had moved the council from Trent to Bologna, only increased the determination of Charles to establish religious conformity. In consultation with both Romanist and Lutheran divines a confession of faith called the *Interim* was drawn up; this was in the nature of a compromise and was issued as an edict in May 1548, but owing to the opposition of the Romanist princes it was not made binding upon them, only upon the Lutherans. There was some resistance to the *Interim*, but force was employed against Augsburg and other recalcitrant cities, and soon it was generally accepted. Thus all Germany seemed to lie at the emperor's feet. The Reformation had enabled him to deal with the princes and the imperial cities in a fashion such as no sovereign had dealt with them for three centuries.

Being now at the height of his power Charles wished to secure the succession to the imperial throne to his son Philip, afterwards Philip II. of Spain. This intention produced dissensions among the Habsburgs, especially between the emperor and his brother Ferdinand, and other causes were at work, moreover, to undermine the former's position. The Romanist princes were becoming alarmed at his predominance, the Protestant princes resented his arbitrary measures and disliked the harsh treatment meted out to John Frederick and to Philip of Hesse; all alike, irritated by the presence of Spanish soldiers in their midst, objected strongly to take Philip for their king and to any extension of Spanish influence in Germany. Turkey and France were again threatening war, and although the council had returned to Trent it seemed less likely than ever to satisfy the Protestants. The general discontent found expression in the person of Maurice of Saxony, a son-in-law of Philip of Hesse, whose services to Charles against the league of Schmalkalden had made him very unpopular in his own country. Caring little or nothing about doctrinal disputes, but a great deal about increasing his own importance, Maurice now took the lead in plotting against the emperor. He entered into an alliance with John, margrave of Brandenburg-Cüstrin, with another Hohenzollern prince, Albert Alcibiades of Bayreuth, and with other Lutheran leaders, and also with Henry II. of France, who eagerly seized this opportunity of profiting by the dissensions in the Empire and who stipulated for a definite reward. Charles knew something of these proceedings, but his recent victory had thrown him partly off his guard. The treaty with France was signed in January 1552; in March Henry II. invaded Germany as the protector of her liberties, while Maurice seized Augsburg and marched towards Innsbruck, where the emperor was residing, with the intention of making him a prisoner. An attempt at accommodation failed; Charles fled into Carinthia; and at one stroke all the advantages which he had gained by his triumph at Mühlberg were lost. Masters of the situation, Maurice and his associates met their opponents at Passau in May 1552 and arranged terms of peace, although the emperor did not assent to them until July. The two captive princes were released, but the main point agreed upon was that a diet should be called for the purpose of settling the religious difficulty, and that in the meantime the Lutherans were to enjoy full religious liberty.

Victory of Charles over the league of Schmalkalden.

The emperor purchased the neutrality of Duke William of Bavaria, and at a high price the active aid of Maurice of Saxony; he managed to detach from the league of Schmalkalden those members who were without any enthusiasm for the Protestant cause and also those who were too timid to enter upon a serious struggle. Meanwhile the league was inactive. Its chiefs differed on questions of policy, one section believing that the emperor did not intend to proceed to extremities, and for some time no measures were taken to meet the coming peril.

At last, in June 1546, during the meeting of the diet at Regensburg, Philip and John Frederick of Saxony realized the extent of the danger and began to muster their forces. They were still much more powerful than the emperor, but they did not work well together, or with Sebastian Schärtlin von Burfenbach, who led their troops in South Germany. In July 1546 they were placed under the imperial ban, and the war began in the valley of the Danube. Charles was aided by soldiers hurried from Italy and the Netherlands, but he did not gain any substantial successes until after October 1546, when his ally Maurice invaded electoral Saxony and forced John Frederick to march northwards to its defence. The Lutheran cities of southern and central Germany, among them Strassburg, Augsburg, Ulm and Frankfurt, now submitted to the emperor, while Ulrich of Württemberg and the elector palatine of the Rhine, Frederick II., followed their example. Having restored Roman Catholicism in the archbishopric of Cologne and seen Henry of Brunswick settled in his duchy early in 1547, Charles led his men against his principal enemies, Philip of Hesse and John Frederick, who had quickly succeeded in driving Maurice from his electorate. At Mühlberg in April 1547 he overtook the army of the Saxon elector. His victory was complete. John Frederick was taken prisoner, and a little later Philip of Hesse, after vainly prolonging the struggle, was induced

The "Interim."

The imperial succession.

The revolt of Maurice of Saxony.

Delayed by the war with France and Turkey, the diet for the settlement of the religious difficulty did not meet at Augsburg until February 1555. Ferdinand represented his brother, and after a prolonged discussion conditions of peace were arranged. Romanists and Lutherans were placed upon an equal footing, but the toleration which was granted to them was not extended to the Calvinists. Each secular prince had the right to eject from his land all those who would not accept the form of religion established therein; thus the principle of *cujus regio ejus religio* was set up. Although the Lutherans did not gain all their demands, they won solid advantages and were allowed to keep all ecclesiastical property secularized before the peace of Passau. A source of trouble, however, was the clause in the treaty usually called the ecclesiastical reservation. This required an ecclesiastical prince, if he accepted the teaching of the confession of Augsburg, or in other words became a Lutheran, forthwith to resign his principality. The Lutherans denied the validity of this clause, and notwithstanding the protests of the Roman Catholics several prelates became Lutheran and kept their territories as secular possessions. The peace of Augsburg can hardly be described as a satisfactory settlement. Individual toleration was not allowed, or only allowed in unison with exile, and in the treaty there was abundant material for future discord.

After Maurice of Saxony had made terms with Charles at Passau he went to help Ferdinand against the Turks, but one of his allies, Henry II. of France, continued the war in Germany while another, Albert Alcibiades, entered upon a wild campaign of plunder in Franconia. The French king seized Metz, which was part of the spoil promised to him by his allies, and Charles made an attempt to regain the city. For this purpose he took Albert Alcibiades into his service, but after a stubborn fight his troops were compelled to retreat in January 1553. Albert then renewed his raids, and these became so terrible that a league of princes, under Maurice of Saxony, was formed to crush him; although Maurice lost his life at Sievershausen in July 1553, this purpose was accomplished, and Albert was driven from Germany. After the peace of Augsburg, which was published in September 1555, the emperor carried out his intention of abdicating. He entrusted Spain and the Netherlands to Philip, while Ferdinand took over the conduct of affairs in Germany, although it was not until 1558 that he was formally installed as his brother's successor.

Ferdinand I., who like all the German sovereigns after him was recognized as emperor without being crowned by the pope, made it a prime object of his short reign to defend and enforce the religious peace of Augsburg for which he was largely responsible. Although in all probability numerically superior at this time to the Romanists, the Protestants were weakened by divisions, which were becoming daily more pronounced and more serious, and partly owing to this fact the emperor was able to resist the demands of each party and to moderate their excesses. He was continually harassed by the Turks until peace was made in 1562, and connected therewith were troubles in Bohemia and especially in Hungary, two countries which he had acquired through marriage, while North Germany was disturbed by the wild schemes of Wilhelm von Grumbach (*q.v.*) and his associate John Frederick, duke of Saxony. With regard to the religious question efforts were made to compose the differences among the Protestants; but while these ended in failure the Roman Catholics were gaining ground. Ferdinand sought earnestly to reform the church from within, and before he died in July 1564 the Counter-Reformation, fortified by the entrance of the Jesuits into Germany and by the issue of the decrees of the council of Trent, had begun.

Under Ferdinand's rule there were some changes in the administration of the Empire. Lutherans sat among the judges of the *Reichskammergericht*, and the Aulic Council, or *Hofrat*, established by Maximilian I. for the Austrian lands, extended its authority over the Empire and was known as the *Reichshofrat*. Side by side with these

changes the imperial diet was becoming more useless and unwieldy, and the electors were gaining power, owing partly to the *Wahlkapitulation*, by which on election they circumscribed the power of each occupant of the imperial throne.

Ferdinand's son and successor, the emperor Maximilian II., was a man of tolerant views; in fact at one time he was suspected of being a Lutheran, a circumstance which greatly annoyed the Habsburgs and delayed his own election as king of the Romans. However, having given to the electors assurances of his fidelity to the Roman Church, he was chosen king in November 1562, and became ruler of Germany on his father's death nearly two years later. Like other German sovereigns Maximilian pursued the phantom of religious union. His first diet, which met at Augsburg in 1566, was, however, unable, or unwilling, to take any steps in this direction, and while the Roman Catholics urged the enforcement of the decrees of the council of Trent the serious differences among the Protestants received fresh proof from the attempt made to exclude the Calvinist prince Frederick III., elector palatine of the Rhine, from the benefits of the peace of Augsburg. After this Frederick and the Calvinists looked for sympathy more and more to the Protestants in France and the Netherlands, whom they assisted with troops, while the Lutherans, whose chief prince was Augustus, elector of Saxony, adopted a more cautious policy and were anxious not to offend the emperor. There were, moreover, troubles of a personal and private nature between these two electors and their families, and these embittered their religious differences. But these divergences of opinion were not only between Roman Catholic and Lutheran or between Lutheran and Calvinist, they were, in electoral and ducal Saxony at least, between Lutheran and Lutheran. Thus the Protestant cause was weakened just when it needed strengthening, as, on the other side, the Roman Catholics, especially Albert, duke of Bavaria, were eagerly forwarding the progress of the older faith, which towards the end of this reign was restored in the important abbey of Fulda. In secular affairs Maximilian had, just after his accession, to face a renewal of the Turkish war. Although his first diet voted liberal assistance for the defence of the country, and a large and splendid army was collected, he had gained no advantage when the campaign ended. The diet of Spires, which met in 1570, was mainly occupied in discussing measures for preventing the abuses caused by the enlistment by foreigners of German mercenary troops, but nothing was done to redress this grievance, as the estates were unwilling to accept proposals which placed more power in the emperor's hands. Maximilian found time to make earnest but unavailing efforts to mediate between his cousin, Philip II. of Spain, and the revolted Netherlands, and also to interfere in the affairs of Poland, where a faction elected him as their king. He was still dealing with this matter and hoping to gain support for it from the diet of Regensburg when he died (October 1576).

Maximilian's successor was his son, Rudolph II., who had been chosen king of the Romans in October 1575, and who in his later years showed marked traces of insanity. The new emperor had little of his father's tolerant spirit, and under his feeble and erratic rule religious and political considerations alike tended to increase the disorder in Germany. The death of the Calvinist leader, the elector palatine Frederick III., in October 1576 and the accession of his son Louis, a prince who held Lutheran opinions, obviously afforded a favourable opportunity for making another attempt to unite the Protestants. Under the guidance of Augustus of Saxony a Lutheran confession of faith, the *Formula concordiæ*, was drawn up; but, although this was accepted by 51 princes and 35 towns, others—like the landgraves of Hesse and the cities of Magdeburg and Strassburg—refused to sign it, and thus it served only to emphasize the divisions among the Protestants. Moreover, the friendship between the Saxon and the Palatine houses was soon destroyed; for, when the elector Louis died in 1583, he was succeeded by a minor, his son Frederick IV., who was under the guardianship of his uncle John Casimir

The
peace of
Augsburg.

End of the
reign.

Ferdinand
and I.

Maximilian II.

Rudolph II.

Administrative
changes.



(1543-1592), a prince of very marked Calvinist sympathies and of some military experience. Just before this time much unrest in the north-west of Germany had been caused by the settlement there of a number of refugees from the Netherlands. Spreading their advanced religious views, these settlers were partly responsible for two serious outbreaks of disorder. At Aix-la-Chapelle the Protestants, not being allowed freedom of worship, took possession of the city in 1581. The matter came before the diet, which was opened at Augsburg in July 1582, but the case was left undecided; afterwards, however, the *Reichshofrat* declared against the insurgents, although it was not until 1598 that Protestant worship was abolished and the Roman Catholic governing body was restored. At Cologne the archbishop, Gebhard Truchsess von Waldburg, married and announced his intention of retaining his spiritual office. Had this proceeding passed unchallenged, the Protestants, among whom Gebhard now counted himself, would have had a majority in the electoral college. The Roman Catholics, however, secured the deposition of Gebhard and the election in his stead of Ernest, bishop of Liège, and war broke out in 1583. Except John Casimir, the Protestant princes showed no eagerness to assist Gebhard, who in a short time was driven from his see, and afterwards took up his residence in Strassburg, where also he instigated a rebellion on a small scale. Thus these quarrels terminated in victories for the Roman Catholics, who were successful about this time in restoring their faith in the bishoprics of Würzburg, Salzburg, Bamberg, Paderborn, Minden and Osnabrück. Another dispute also ended in a similar way. This was the claim made by the administrator of the archbishopric of Magdeburg, a Hohenzollern prince, Joachim Frederick, afterwards elector of Brandenburg, to sit and vote in the imperial diet; it was not admitted, and the administrator retired from Augsburg, a similar fate befalling a similar claim made by several other administrators some years later.

After the death of Augustus of Saxony in February 1586 there was another brief alliance between the Protestant parties, although on this occasion the lead was taken not by the Saxon, but by the Palatine prince. Less strict in his adherence to the tenets of Lutheranism than Augustus, the new elector of Saxony, Christian I., fell under the influence of John Casimir. The result was that Protestant princes, including the three temporal electors, united in placing their grievances before the emperor; obtaining no redress they met at Torgau in 1591 and offered help to Henry IV. of France, a proceeding which was diametrically opposed to the past policy of Saxony. But this alliance, like its forerunner, was of very short duration. Christian I. died in 1591, and under Christian II. electoral Saxony re-established a rigid Lutheranism at home and pursued a policy of moderation and neutrality abroad. A short time afterwards the militant party among the Protestants suffered a heavy loss by the death of their leader, John Casimir, whose policy, however, was continued by his nephew and pupil, the elector Frederick IV. But neither desertion nor death was able to crush entirely the militant Protestants, among whom Christian, prince of Anhalt (1568-1630), was rapidly becoming the most prominent figure. They made themselves very troublesome at the diet of Regensburg in 1593, and also at the diet held in the same city four years later, putting forward various demands for greater religious freedom and seeking to hinder, or delay, the payment of the grant for the Turkish war. Moreover, in 1598 they put forward the theory that the vote of a majority in the diet was not binding upon the minority; they took up the same position at Regensburg in 1603, when they raised strong objections to the decisions of the *Reichshofrat* and afterwards withdrew from the diet in a body. Thus, under Maximilian of Bavaria and Christian of Anhalt respectively the two great parties were gaining a better idea of their own needs and of each other's aims and were watching vigilantly the position in the duchies of Cleves, Jülich and Berg, where a dispute over the succession was impending. While wars and rumours of wars were disturbing the peace in the west of Germany the Turks were again harassing the east.

The war between them and the Empire, which was renewed in 1593, lasted almost without interruption until November 1606, when peace was made, the tribute long paid by the emperor to the sultan being abandoned. This peace was concluded not by Rudolph, but by his brother, the archduke Matthias, who owing to the emperor's mental incapacity had just been declared by his kinsman the head of the house of Habsburg. Rudolph resented this indignity very greatly, and until his death in January 1612 the relations between the brothers were very strained, but this mainly concerns the history of Hungary and of Bohemia, which were sensibly affected by the fraternal discord.

By this time however, there were signs of substantial progress on the part of the great Catholic reaction, which was to have important consequences for Germany. This was due mainly to the persistent zeal of the Jesuits. For a long time the Protestants had absorbed the intellectual strength of the country, but now many able scholars and divines among the Jesuits could hold their own with their antagonists. These devoted missionaries of the church gave their attention mainly to the young, and during the reign of Rudolph II. they were fortunate enough to make a deep impression upon two princes, each of whom was destined to play a great part in the events of his time. These princes were Maximilian, duke of Bavaria, and Ferdinand, archduke of Styria, the former a member of the house of Wittelsbach, and the latter of the house of Habsburg. Maximilian became prominent in 1607 by executing an imperial mandate against the free city of Donauwörth, where a religious riot had taken place, and afterwards treating it as his own. Rendered suspicious by this arbitrary act, the Protestant princes in 1608 formed a confederation known as the Evangelical Union, and in response the Roman Catholics, under the guidance of Maximilian, united in a similar confederation afterwards called the Catholic League. This was founded at Munich in July 1609. As the Union was headed by the elector palatine of the Rhine, Frederick IV., who was a Calvinist, many Lutherans, among them the elector of Saxony, were by no means enthusiastic in its support. It acquired, however, immense importance through its alliance with Henry IV. of France, who, like Henry II., wished to profit by the quarrels in Germany, and who interfered in the disputed succession to the duchies of Cleves and Jülich. War seemed about to break out between the two confederations and their foreign allies over this question, but after the murder of the French king in May 1610 the Union did not venture to fight.

Ferdinand was even more vigorous than Maximilian in defence of his religion. On assuming the government of Styria he set to work to extirpate Protestantism, which had made considerable progress in the Austrian arch-duchies. Soon afterwards he was selected by the Habsburgs as the heir of the childless emperor Matthias, and on coming to Vienna after the death of that sovereign in March 1619 he found himself in the midst of hopeless confusion. The Bohemians refused to acknowledge him as their king and elected in his stead Frederick V., the elector palatine of the Rhine, a son-in-law of the English king James I., and the Hungarians and the Austrians were hardly less disaffected. As Ferdinand II., however, he succeeded in obtaining the imperial crown in August 1619, and from that time he was dominated by a fixed resolve to secure the triumph of his church throughout the Empire, a resolve which cost Germany the Thirty Years' War.

He began with Bohemia. Although supported by Spain he could not obtain from this quarter an army sufficiently strong to crush the Bohemians, and for some time he remained powerless and inactive in Vienna. Then at the beginning of 1620 he came to terms with Maximilian of Bavaria, who, after carefully securing his own interests, placed the army of the League, commanded by the celebrated Tilly, at his disposal. Conditionally the Union promised assistance to Frederick, but he wasted several months and vaguely hoped that the English king would help him out of his embarrassments. Meanwhile Tilly advanced into Bohemia, and in November 1620 Frederick's army was utterly routed at

The Counter-Reformation.

Ferdinand II.

The conquest in Bohemia.

the battle of the White Hill, near Prague, and the unfortunate elector had just time to escape from the kingdom he had rashly undertaken to govern. Ferdinand drove to the uttermost the advantages of his victory. The Union being destroyed and the Bohemian revolution crushed, attention was turned to the hereditary lands of the elector palatine. The Spanish troops and the army of the League invaded the Rhenish Palatinate, which was defended by Frederick's remaining adherents, Christian of Brunswick and Count Ernst von Mansfeld, but after several battles it passed completely into the possession of the imperialists. Having been placed under the imperial ban Frederick became an exile from his inheritance, and the electorate which he was declared to have forfeited was conferred on Maximilian.

Thus ended the first stage of the Thirty Years' War, although some desultory fighting continued between the League and its opponents. The second began in 1625 with the formation, after much fruitless negotiation, of a Protestant combination, which had the support of England, although its leading member was Christian IV., king of Denmark, who as duke of Holstein was a prince of the Empire, and who like other Lutherans was alarmed at the emperor's successes. It was in this war that Europe first became familiar with the great name of Wallenstein. Unable himself to raise and equip a strong army, and restive at his dependence on the League, Ferdinand gladly accepted Wallenstein's offer to put an army into the field at no cost to himself. After Wallenstein had beaten Mansfeld at the bridge of Dessau in April 1626, and Tilly had defeated Christian of Denmark at Lutter in the succeeding August, the two generals united their forces. Denmark was invaded, and Wallenstein, now duke of Friedland, was authorized to govern the conquered duchies of Mecklenburg and Pomerania; but his ambitious scheme of securing the whole of the south coast of the Baltic was thwarted by the resistance of the city of Stralsund, which for five months he vainly tried to take. Denmark, however, was compelled to conclude peace at Lübeck in May 1629.

Intoxicated by success, Ferdinand had issued two months before the famous Edict of Restitution. This ordered the restoration of all ecclesiastical lands which had come into the possession of the Protestants since the peace of Passau in 1552, and, as several archbishoprics and bishoprics had become Protestant, it struck a tremendous blow at the emperor's foes and stirred among them intense and universal opposition. A little later, yielding to Maximilian and his colleagues in the League, Ferdinand dismissed Wallenstein, whose movements had aroused their resentment, from his service. A more inauspicious moment could not have been chosen for these two serious steps, because in the summer of 1630 Gustavus Adolphus left Sweden at the head of a strong army for the purpose of sustaining the Protestant cause in Germany. At first this great king was coldly received by the Protestants, who were ignorant of his designs and did not want a stranger to profit by the internal disputes of their country. A mistake at the outset would probably have been fatal to him, but he saw the dangers of his position and moved so warily that in less than a year he had obtained the alliance of the elector of Saxony, a consequence of the terrible sack of Magdeburg by the imperialists in May 1631 and of the devastation of the electorate by Tilly. He had also obtained on his own terms the assistance of France, and was ready to enter upon his short but brilliant campaign.

Having captured Frankfort-on-Oder and forced the hesitating elector of Brandenburg, George William, to grant him some assistance, Gustavus Adolphus added the Saxon army to his own, and in September 1631 he met Tilly, at the head of nearly the whole force of the League, at Breitenfeld, near Leipzig, where he gained a victory which placed North Germany entirely at his feet. So utterly had he shattered the emperor's power that he could doubtless have marched straight to Vienna; he preferred, however, to proceed through central into southern Germany, while his Saxon ally, the elector John George, recovered Silesia and Lusatia and invaded Bohemia.

Würzburg and Frankfort were among the cities which opened their gates to the Swedish king as the deliverer of the Protestants; several princes sought his alliance, and, making the captured city of Mainz his headquarters, he was busily engaged for some months in resting and strengthening his army and in negotiating about the future conduct of the war. Early in 1632 he led his troops into Bavaria. In April he defeated Tilly at the crossing of the Lech, the imperialist general being mortally wounded during this fight, and then he took possession of Augsburg and of Munich. Before these events Ferdinand had realized how serious had been his mistake in dismissing Wallenstein, and after some delay his agents persuaded the great general to emerge from his retirement. The conditions, however, upon which Wallenstein consented to come to the emperor's aid were remarkably onerous, but Ferdinand had perforce to assent to them. He obtained sole command of the imperial armies, with the power of concluding treaties and of granting pardons, and he doubtless insisted on the withdrawal of the Edict of Restitution, although this is not absolutely certain; in brief, the only limits to his power were the limits to the strength of his army. Having quickly assembled this, he drove the Saxons from Bohemia, and then marched towards Franconia, with the intention of crossing swords with his only serious rival, Gustavus Adolphus, who had left Munich when he heard that this foe had taken the field. The Swedes and their allies occupied Nuremberg, while the imperialists fortified a great camp and blockaded the city. Gustavus made an attempt to storm these fortifications, but he failed to make any impression on them; he failed also in inducing Wallenstein to accept battle, and he was forced to abandon Nuremberg and to march to the protection of Saxony. Wallenstein followed; and the two armies faced each other at Lützen on the 16th of November 1632. Here the imperialists were beaten, but the victory was even more disastrous to the Protestant cause than a defeat, for the Swedish king was among the slain.

The Swedes, whose leader was now the chancellor Oxenstierna, were stunned by this catastrophe, but in a desultory fashion they maintained the struggle, and in April 1633 a new league was formed at Heilbronn between them and the representatives of four of the German circles, while by a new agreement France continued to furnish monetary aid. Of this alliance Sweden was the predominant member, but the German allies had a certain voice in the direction of affairs, the military command being divided between the Swedish general Horn and Bernhard, duke of Saxe-Weimar. About this time some discontent arose in the allied army, and to allay this Bernhard was granted the bishoprics of Würzburg and of Bamberg, with the title of duke of Franconia, but on the strange condition that he should hold the duchy as the vassal of Sweden, not as a vassal of the Empire. The war, thus revived, was waged principally in the valleys of the Danube and the Rhine, the Swedes, seizing Alsace while Bernhard captured Regensburg. Meanwhile Wallenstein was again arousing the suspicions of his nominal allies. Instead of attacking the enemy with his accustomed vigour, he withdrew into Bohemia and was engaged in lengthy negotiations with the Saxon soldier and diplomatist, Hans Georg von Arnim (1581-1641), his object being doubtless to come to terms with Saxony and Brandenburg either with or without the emperor's consent. His prime object was, however, to secure for himself a great territorial position, possibly that of king of Bohemia, and it is obvious that his aims and ambitions were diametrically opposed to the ends desired by Ferdinand and by his Spanish and Bavarian allies. At length he set his troops in motion. Having gained some successes in the north-east of Germany he marched to succour the hardly pressed elector of Bavaria; then suddenly abandoning this purpose he led his troops back to Bohemia and left Bernhard of Saxe-Weimar in possession of the Danube valley. It is not surprising that a cry, louder than ever, now arose for his dismissal. Ferdinand did as he was required. In January 1634 he declared Wallenstein deposed from his command, but he was still at the head of an army when he was

Danish interference in the war.

Dismissal of Wallenstein.

The league of Heilbronn and the death of Wallenstein.

The campaign of Gustavus Adolphus.

murdered in the following month at Eger. Commanded now by the king of Hungary, afterwards the emperor Ferdinand III., the imperialists retook Regensburg and captured Donauwörth; then, aided by some Spanish troops, they gained a victory at Nördlingen in September 1634, the results of which were as decisive and as satisfactory for them as the results of Breitenfeld had been for their foes two years before.

The demoralization of the Swedes and their allies, which was a consequence of the defeat at Nördlingen, was the opportunity of France. Having by clever diplomacy placed garrisons in several places in Alsace and the Palatinate, the king of France, or rather Cardinal Richelieu, now entered the field as a principal, made a definite alliance with Sweden at Compiègne in April 1635, and in the following month declared war and put four armies in motion. But the thoughts of many had already turned in the direction of peace, and in this manner John George of Saxony took the lead, signing in May 1635 the important treaty of Prague with the emperor. The vexed and difficult question of the ownership of the ecclesiastical lands was settled by fixing November 1627 as the deciding date; those who were in possession then were to retain them for forty years, during which time it was hoped a satisfactory arrangement would be reached. The Saxon elector gained some additions of territory and promised to assist Ferdinand to recover any lands which had been taken from him by the Swedes, or by other foes. For this purpose a united army was to serve under an imperial general, and all leagues were to be dissolved. In spite of the diplomatic efforts of Sweden the treaty of Prague was accepted almost at once by the elector of Brandenburg, the duke of Württemberg and other princes, and also by several of the most important of the free cities. It was only, in fact, the failure of Saxony and Sweden to come to terms which prevented a general peace in Germany. The Thirty Years' War now took a different form. Its original objects were almost forgotten and it was continued mainly to further the ambitions of France, thus being a renewal of the great fight between the houses of Habsburg and of Bourbon, and to secure for Sweden some recompense for the efforts which she had put forward.

While the signatories of the peace of Prague were making ready to assist the emperor the only Germans on the other side were found in the army under Bernhard of Saxe-Weimar. The final stage of the war opened with considerable Swedish successes in the north of Germany, especially the signal victory gained by them over the imperialists and the Saxons at Wittstock in October 1636. At the same time good fortune was attending the operations of the French in the Rhineland, where they were aided by Bernhard of Saxe-Weimar, a satisfactory financial arrangement between these parties having been reached in the autumn of 1635. The year 1638 was an especially fortunate one for France and her allies. Bernhard's capture of Rheinfelden and of Breisach gave them possession of the surrounding districts, but dissensions arose concerning the division of the spoil; these, however, were stopped by the death of Bernhard in July 1639, when France took his army into her pay. Thus the war continued, but the desire for peace was growing stronger, and this was reflected in the proceedings of the diet which met at Regensburg in 1640. Under Count Torstenssen the Swedes defeated the imperialists at Breitenfeld in 1642; three years later they gained another victory at Jankau and advanced almost to Vienna, and then the last decisive move of the war was made by the great French general, Turenne. Having been successful in the Rhineland, where he had captured Philippsburg and Worms, Turenne joined his forces to those of Sweden under Wrangel and advanced into Bavaria. Ravaging the land, they compelled the elector Maximilian to sign a truce and to withdraw his troops from the imperial army. When, however, the allied army had retired Maximilian repented of his action. Again he joined the emperor, but his punishment was swift and sure, as Turenne and Wrangel again marched into the electorate and defeated the Bavarians at Zusmarshausen, near Augsburg, in May 1648. A few minor operations followed,

and then came the welcome news of the conclusion of the treaty of Westphalia.

The preliminary negotiations for peace were begun at Hamburg and Cologne before the death of the emperor Ferdinand II. in 1637. By a treaty signed at Hamburg in December 1641 it was agreed that peace conferences should meet at Münster and at Osnabrück in March 1642, the emperor treating with France in the former, and with Sweden in the latter city. The Roman Catholic princes of the Empire were to be represented at Münster and the Protestants at Osnabrück. Actually the conferences did not meet until 1645, when the elector of Brandenburg had made, and the elector of Saxony was about to make, a truce with Sweden, these two countries being withdrawn from the ravages of the war. In three years the many controversial questions were discussed and settled, and in October 1648 the treaty of Westphalia was signed and the Thirty Years' War was at an end.

The Thirty Years' War settled once for all the principle that men should not be persecuted for their religious faith. It is true that the peace of Westphalia formally recognized only the three creeds, Catholicism, Lutheranism and Calvinism, but so much suffering had been caused by the interference of the state with individual conviction, that toleration in the largest sense, so far as law was concerned, was virtually conceded. This was the sole advantage gained from the war by the Protestants. The Catholics insisted at first on keeping all the ecclesiastical lands which had been taken from them before the Edict of Restitution in 1629. The Protestants responded by demanding that they should lose nothing which they had held before 1618, when the war began. A compromise was at last effected by both parties agreeing to the date 1624, an arrangement which secured to the Catholics their gains in Bohemia and the other territories of the house of Habsburg. The restoration of the elector palatine to part of his lands, and his reinstatement in the electoral office, were important concessions; but on the other hand, the duke of Bavaria kept the Upper Palatinate, the elector palatine becoming the eighth and junior member of the electoral college.

The country suffered enormous territorial losses by the war. Up to this time the possession of Metz, Toul and Verdun by France had never been officially recognized; now these bishoprics were formally conceded to her. She also received as much of Alsace as belonged to Austria. To the Swedes were granted Western Pomerania, with Stettin, and the archbishopric of Bremen and the bishopric of Verden. These acquisitions, which surpassed the advantages Gustavus Adolphus had hoped to win, gave Sweden the command both of the Baltic and of the North Sea. In virtue of her German possessions Sweden became a member of the Empire; but France obtained absolute control of her new territories. There was a further diminution of Germany by the recognition of the independence of Switzerland and the United Provinces. Both had long been virtually free; they now for the first time took the position of distinct nations.

In the political constitution of Germany the peace of Westphalia did not so much make changes as sanction those already effected. The whole tendency of the Reformation had been to relax the bonds which united the various elements of the state to each other and to their head. It divided the nation into two hostile parties, and the emperor was not able to assume towards them a perfectly impartial position. His imperial crown imposed upon him the necessity of associating himself with the Roman Catholics; so that the Protestants had a new and powerful reason for looking upon him with jealousy, and trying to diminish his authority. The Roman Catholics, while maintaining their religion, were willing enough to co-operate with them for this object; and Germany often saw the strange spectacle of princes rallying round the emperor for the defence of the church, and at the same time striking deadly blows at his political influence. The diet was a scene of perpetual quarrelling between the two factions, and their differences made it impossible for the imperial

The peace of Westphalia.

Effects of the Thirty Years' War.

Loss of territory.

The Reformation and the political constitution.

France takes part in the war.

Bernhard of Saxe-Weimar.

chamber to move beyond the region of official routine. Thus before the Thirty Years' War the Empire had virtually ceased to exist, Germany having become a loose confederation of principalities and free cities. For a moment the emperor Ferdinand appeared to have touched the ideal of Charles V. in so far, at least, as it related to Germany, but only for a moment. The stars in their courses fought against him, and at the time of his death he saw how far beyond his power were the forces with which even Charles had been unable to contend. The state of things which actually existed the peace of Westphalia made legal. So nearly complete was the independence of the states that each received the right to form alliances with any of the others, or with foreign powers, nominally on condition that their alliances should not be injurious to the emperor or to the Empire. Any authority which still lawfully belonged to the emperor was transferred to the diet. It alone had now the power of making laws, of concluding treaties in the name of Germany, and of declaring war and re-establishing peace. No one, however, expected that it would be of any real service. From 1663 it became a permanent body, and was attended only by the representatives of the princes and the cities; and from that time it occupied itself mainly with trifles, leaving the affairs of each state to be looked after by its own authorities, and those of the country generally to such fortunes as chance should determine.

It would not have been strange if so shadowy an Empire had been brought altogether to an end. Some slight bond of connexion was, however, necessary for defence against common dangers; and the Empire had existed so long, and so many great associations were connected with it, that it seemed to all parties preferable to any other form of union. Moreover, Sweden, and other states which were now members of the Empire, warmly supported it; and the house of Habsburg, on which it reflected a certain splendour, would not willingly have let it die. An Austrian ruler, even when he spoke only in the name of Austria, derived authority from the fact that as emperor he represented many of the greatest memories of European history.

The effect of the Thirty Years' War on the national life was disastrous. It had not been carried on by disciplined armies, but by hordes of adventurers whose sole object was plunder. The cruelties they inflicted on their victims are almost beyond conception. Before the war the population was nearly twenty millions; after it the number was probably about six millions. Whole towns and villages were laid in ashes, and vast districts turned into deserts. Churches and schools were closed by hundreds, and to such straits were the people often reduced that cannibalism is said to have been not uncommon. Industry and trade were so completely paralysed that in 1635 the Hanseatic League was virtually broken up, because the members, once so wealthy, could not meet the necessary expenditure. The population was not only impoverished and reduced in numbers but broken in spirit. It lost confidence in itself, and for a time effected in politics, literature, art and science little that is worthy of serious study.

The princes knew well how to profit by the national prostration. The local diets, which, as we have seen, formed a real check on petty tyranny, and kept up an intimate relation between the princes and their subjects, were nearly all destroyed. Those which remained were injurious rather than beneficial, since they often gave an appearance of lawfulness to the caprices of arbitrary sovereigns. After the Thirty Years' War it became fashionable for the heirs of principalities to travel, and especially to spend some time at the court of France. Here they readily imbibed the ideas of Louis XIV., and in a short time nearly every petty court in Germany was a feeble imitation of Versailles. Before the Reformation, and even for some time after it, the princes were thorough Germans in sympathies and habits; they now began to be separated by a wide gulf from their people. Instead of studying the general welfare, they wrung from exhausted states the largest possible revenue to support a lavish and ridiculous expenditure. The

pettiest princeling had his army, his palaces, his multitudes of household officers; and most of them pampered every vulgar appetite without respect either to morality or to decency. Many nobles, whose lands had been wasted during the war, flocked to the little capitals to make their way by contemptible court services. Beneath an outward gloss of refinement these nobles were, as a class, coarse and selfish, and they made it their chief object to promote their own interests by fostering absolutist tendencies. Among the people there was no public opinion to discourage despotism; the majority accepted their lot as inevitable, and tried rather to reproduce than to restrain the vices of their rulers. Even the churches offered little opposition to the excesses of persons in authority, and in many instances the clergy, both Protestant and Catholic, acquired an unenviable notoriety for their readiness to overlook or condone actions which outraged the higher sentiments of humanity. In the free imperial cities there was more manliness of tone than elsewhere, but there was little of the generous rivalry among the different classes which had once raised them to a high level of prosperity. Most of them resigned their liberties into the hands of oligarchies, and others allowed themselves to be annexed by ambitious princes. (A. W. H.')

Ferdinand III. succeeded to the throne when the fortunes of his house were at a low ebb, and he continued the Thirty Years' War, not in the hope of re-establishing the Roman Catholic religion or of restoring the imperial authority, but of remedying as far as he could the havoc caused by his father's recklessness. After the conclusion of peace nothing happened to make his reign memorable. His son Leopold I. was a man of narrow intellect and feeble will; yet Germany seldom so keenly felt the need of a strong emperor, for she had during two generations to contend with a watchful and grasping rival. For more than a century it had been the policy of France to strengthen herself by fostering the internal dissensions of Germany. This was now easy, and Louis XIV. made unscrupulous use of the advantages his predecessors had helped to gain for him. Germany, as a whole, could not for a long time be induced to resist him. His schemes directly threatened the independence of the princes; but they were too indolent to unite against his ambition. They grudged even the contributions necessary for the maintenance of the frontier fortresses, and many of them stooped to accept the bribes he offered them on condition that they should remain quiet. In his war with the United Provinces and Spain, begun in 1672, he was opposed by the emperor as ruler of Austria, and by Frederick William, the elector of Brandenburg; and in 1675 the latter gained a splendid victory at Fehrbellin over his allies, the Swedes. At the end of the war, in 1678, by the peace of Nijmegen, Louis took care that Frederick William should be deprived of the fruits of his victory, and Austria had to resign Freiburg im Breisgau to the French. Under the pretence that when France gained the Austrian lands in Alsace she also acquired a right to all places that had ever been united to them, Louis began a series of systematic robberies of German towns and territories. "Chambers of Reunion" were appointed to give an appearance of legality to these proceedings, which culminated, in 1681, in the seizure of Strassburg. Germans of all states and ranks were indignant at so gross a humiliation, but even the loss of Strassburg did not suffice to move the diet. The emperor himself might probably have interfered, but Louis had provided him with ample employment by stirring up against him the Hungarians and the Turks. So complete was his hold over the majority of the princes that when the Turks, in 1683, surrounded Vienna, and appeared not unlikely to advance into the heart of Germany, they looked on indifferently, and allowed the emperor to be saved by the promptitude and courage of John Sobieski, king of Poland. At last, when, in 1689, on the most frivolous pretext, Louis poured into southern Germany armies which were guilty of shameful outrages, a number of princes came forward and aided the emperor. This time France was sternly opposed by the league of which William III. of England was the moving spirit;

The cities.

Ferdinand III.

Leopold I.

Louis XIV. of France.

Continuance of the empire.

National life.

The princes.

and although at the end of the war he kept Strassburg, he had to give up Freiburg, Philipsburg, Breisach, and the places he had seized because of their former connexion with Alsace. In the War of the Spanish Succession two powerful princes, the elector of Bavaria and the elector of Cologne, joined Louis; but as the states of the Empire declared war against him in 1702, the other princes, more or less loyally, supported the emperor and his allies. Leopold died during the progress of this war, but it was vigorously continued by his son Joseph I.

Joseph's brother and successor, Charles VI., also went on with it; and such were the blows inflicted on France by the victories

of Blenheim, Ramillies and Malplaquet that the war **Charles VI.** was generally expected to end in her utter discomfiture. But the conclusion of the treaty of Utrecht by England, in 1713, so limited the military power of Charles VI. that he was obliged to resign the claims of Austria to the Spanish throne, and to content himself with the Spanish Netherlands, Milan, Naples and Sardinia. He cared so little for Germany, as distinguished from Austria, that he allowed Louis to compel the diet to cede the imperial fortress of Landau. At a later stage in his reign he was guilty of an act of even grosser selfishness; for after the War of the Polish Succession, in which he supported the claims of Augustus III., elector of Saxony, he yielded Lorraine to Stanislaus Leszczyński, whose claims had been defended by France, and through whom France ultimately secured this beautiful German province. Having no son, Charles drew up in 1713 the pragmatic sanction, which ordained that, in the event of an Austrian ruler being without male heirs, his hereditary lands and titles should pass to his nearest female relative. The aim of his whole policy was to secure for this measure, which was proclaimed as a fundamental law in 1724, the approval of Europe; and by promises and threats he did at last obtain the guarantee of the states of the Empire and the leading European powers.

Germany was now about to be aroused from the torpor into which she had been cast by the Thirty Years' War; but her awakening was due, not to the action of the Empire, which was more and more seen to be practically dead, but to the rivalry of two great German states, Austria and Prussia. The latter had long been laying the foundations of her power. Brandenburg, the centre of the Prussian kingdom, was, as we have seen, granted in the 15th century by the emperor Sigismund to Frederick, count of Hohenzollern. In his hands, and in those of his prudent successors, it became one of the most flourishing of the North-German principalities. At the time of the Reformation Albert, a member of a subordinate branch of the house of Hohenzollern, happened to be grand master of the Teutonic Order. He became a Protestant, dissolved the order, and received in fief of the king of Poland the duchy of Prussia. In 1611 this duchy fell by inheritance to the elector of Brandenburg, and by the treaty of Wehlau, in 1657, in the time of Frederick William, the Great Elector, it was declared independent of Poland. By skill, foresight and courage Frederick William managed to add largely to his territories; and in an age of degenerate sovereigns he was looked upon as an almost model ruler. His son, Frederick, aspired to royal dignity, and in 1701, having obtained the emperor's assent, was crowned king of Prussia. The extravagance of Frederick drained the resources of his state, but this was amply atoned for by the rigid economy of Frederick William I., who not only paid off the debts accumulated by his father, but amassed an enormous treasure. He so organized all branches of the public service that they were brought to a point of high efficiency, and his army was one of the largest, best appointed and best trained in Europe (see PRUSSIA: *History*). He died in 1740, and within six months, when Frederick II. was on the Prussian throne, Maria Theresa claimed, in virtue of the pragmatic sanction, the lands and hereditary titles of her father Charles VI.

Frederick II., a young, ambitious and energetic sovereign, longed not only to add to his dominions but to play a great part in European politics. His father had guaranteed the prag-

matic sanction, but as the conditions on which the guarantee had been granted had not been fulfilled by Charles VI., Frederick did not feel bound by it, and revived some old claims of his family on certain Silesian duchies. Maria Theresa would not abate her rights, but before she could assert them Frederick had entered Silesia and made himself master of it. Meanwhile, the elector of Bavaria had come forward and disputed Maria Theresa's right to the succession, and the elector of Saxony had also put in a claim to the Austrian lands. Taking advantage of these disputes, France formed an alliance with the two electors and with the king of Prussia against Austria; and in the war which followed the allies were at first so successful that the elector of Bavaria, through the influence of France, was crowned emperor as Charles VII. (1742-1745). Maria Theresa, a woman of a noble and undaunted spirit, appealed, with her infant son, afterwards Joseph II., in her arms, to the Hungarian diet, and the enthusiastic Magyars responded chivalrously to her call. To be more at freedom she concluded peace with Frederick, and ceded Silesia to him, although greatly against her will. Saxony also was pacified and retired from the struggle. After this Maria Theresa, supported by England, made way so rapidly and so triumphantly that Frederick became alarmed for his new possessions; and in 1742 he once more proclaimed war against her, nominally in aid of the emperor, Charles VII. Ultimately, in 1748, she was able to conclude an honourable peace at Aix-la-Chapelle; but she had been forced, as before, to rid herself of Frederick by confirming him in the sovereignty of the territory he had seized.

After the death of Charles VII., Francis, grand duke of Tuscany, Maria Theresa's husband, was elected emperor. Francis I. (1745-1765), an amiable nonentity, with the instincts of a shopkeeper, made no pretence of discharging important imperial duties, and the task of ruling the hereditary possessions of the house of Habsburg fell wholly to the empress-queen. She executed it with discretion and vigour, so that Austria in her hands was known to be one of the most formidable powers in the world. Her rival, Frederick II., was, if possible, still more active. It did not occur to him, any more than to the other German sovereigns of the 18th century, to associate his people with him in the government of the country; he was in every respect a thoroughly absolute sovereign. But he shared the highest ideas of the age respecting the responsibilities of a king, and throughout his long reign acted in the main faithfully as "the first servant of the state." The army he always kept in readiness for war; but he also encouraged peaceful arts, and diffused throughout his kingdom so much of his own alert and aggressive spirit that the Prussians became more intelligent and more wealthy than they had ever before been. He excited the admiration of the youth of Germany, and it was soon the fashion among the petty princes to imitate his methods of government. As a rule, they succeeded only in raising far larger armies than the taxpayers could afford to maintain.

Maria Theresa never gave up the hope of winning back Silesia, and, in order to secure this object, she laid aside the jealousies of her house, and offered to conclude an alliance with France. Frederick had excited the envy of surrounding sovereigns, and had embittered them against him by stinging sarcasms. Not only France, therefore, but Russia, Saxony and ultimately Sweden, willingly came to terms with Austria, and the aim of their union was nothing short of the partition of Prussia. Frederick, gaining knowledge of the plot, turned to England, which had in the previous war helped Austria. At the close of 1755 his offer of an alliance was acceded to; and in the following year, hoping by vigorously taking the initiative to prevent his enemies from united action, he invaded Saxony, and began the Seven Years' War (*q.v.*), the result of which was to confirm Prussia in the possession of Silesia.

Prussia now took rank as one of the leading European powers, and by her rise a new element was introduced into the political

Frederick the Great.

First Silesian war.

Charles VII.

Second Silesian war.

Francis I.

The Seven Years' War, 1756-1763.

life of Germany. Austria, although associated with the Empire, could no longer feel sure of her predominance, and it was inevitable that the jealousies of the two states should lead to a final conflict for supremacy. Even before the Seven Years' War there were signs that the German people were beginning to tire of incessant imitation of France, for in literature they welcomed the early efforts of Klopstock, Wieland and Lessing; but the movement received a powerful impulse from the great deeds of Frederick. The nation, as a whole, was proud of him, and began, for the first time since the Thirty Years' War, to feel that it might once more assume a commanding place in the world.

In 1772 the necessities of Frederick's position compelled him to join Russia and Austria in the deplorable partition of Poland, whereby he gained West Prussia, exclusive of Danzig and Thorn, and Austria acquired West Silesia. After this he had to watch closely the movements of the emperor Joseph II., who, although an ardent admirer of Frederick, was anxious to restore to Austria the greatness she had partially lost. The younger branch of the Wittelsbach line, which had hitherto possessed Bavaria, having died out in 1777, Joseph asserted claims to part of its territory. Frederick intervened, and although no battle was fought in the nominal war which followed, the emperor was obliged to content himself with a very unimportant concession. He made a second attempt in 1785, but Frederick again came forward. This time he formed a league (*Fürstentbund*) for the defence of the imperial constitution, and it was joined by the majority of the small states. The memory of this league was almost blotted out by the tremendous events which soon absorbed the attention of Germany and the world, but it truly indicated the direction of the political forces which were then at work beneath the surface, and which long afterwards triumphed. The formation of the league was a distinct attempt on the part of Prussia to make herself the centre for the national aspirations both of northern and of southern Germany.

The French Revolution was hailed by many of the best minds of Germany as the opening of a new era. Among the princes it excited horror and alarm, and in 1792 the emperor Leopold II. and Frederick William II., the unworthy successor of Frederick the Great, met at Pillnitz, and agreed to support by arms the cause of the French king. A more important resolution was never taken. It plunged Europe into a conflict which cost millions of lives, and which overthrew the entire states system of the continent. Germany herself was the principal sufferer. The structure which the princes had so laboriously built up crumbled into ruins, and the mistakes of centuries were expiated in an agony of disaster and humiliation.

The states of the Empire joined Austria and Prussia, and, had there been hearty co-operation between the allies, they could scarcely have failed of success. While the war was in progress, in 1793, Prussia joined Russia in the second partition of Poland. Austria considered herself overreached, and began negotiations with Russia for the third and final partition, which was effected by the three powers in 1795. Prussia, irritated by the proceedings of her rival, did as little as possible in the war with France; and in 1795 she retired from the struggle, and by the treaty of Basel ceded to the French republic her possessions on the left bank of the Rhine. The war was continued by Austria, but her power was so effectually shattered by blow after blow that in 1797 she was forced to conclude the peace of Campo Formio. Napoleon Bonaparte, to whose genius the triumph of France was mainly due, began separate negotiations with the states of the Empire at Rastadt; but, before terms could be agreed upon, war again began in 1799, Austria acting on this occasion as the ally of Great Britain and Russia. She was beaten, and the peace of Lunéville added fresh humiliations to those imposed upon her by the previous war. France now obtained the whole of the left bank of the Rhine, the dispossessed princes being compensated by grants of secularized church lands and of mediatised imperial cities (1803). The contempt

of Napoleon for the Empire was illustrated by his occupation of Hanover in 1803, and by his seizure of the duke of Enghien on imperial territory in 1804. In 1805 Austria once more appealed to arms in association with her former allies, but in vain. By the peace of Presburg she accepted more disastrous terms than ever, and for the moment it seemed as if she could not again hope to rise to her former splendour. In this war she was opposed not only by France, but by Bavaria, Württemberg and Baden, all of which were liberally rewarded for their services, the rulers of the two former countries being proclaimed kings. The degradation of Germany was completed by the formation, in 1806, of the Confederation of the Rhine, which was composed of the chief central and southern states. The welfare of the Empire was asserted to be its object, but a body of which Napoleon was the protector existed, of course, for no other purpose than to be a menace to Austria and Prussia. Francis II., who had succeeded Leopold II. in 1792 and in 1804 had proclaimed himself hereditary emperor of Austria, as Francis I., now resigned the imperial crown, and thus the Holy Roman Empire and the German kingdom came to an end. The various states, which had for centuries been virtually independent, were during the next few years not connected even by a nominal bond. (J. St.)

Frederick William III. (1797-1840) of Prussia, the successor of Frederick William II., had held aloof from the struggle of Austria with France. This attitude had been dictated partly by his constitutional timidity, partly by the desire to annex Hanover, to which Austria and Russia would never have assented, but which Napoleon was willing to concede in return for a Prussian alliance. The Confederation of the Rhine, however, was a menace to Prussia too serious to be neglected; and Frederick William's hesitations were suddenly ended by Napoleon's contemptuous violation of Prussian territory in marching three French brigades through Ansbach without leave asked. The king at once concluded a convention with the emperor Alexander I. of Russia and declared war on France. The campaign that ended in the disastrous battle of Jena (October 14, 1806) followed; and the prestige of the Prussian arms, created by Frederick the Great, perished at a blow. With the aid of Russia Frederick William held out a while longer, but after Napoleon's decisive victory at Friedland (June 14, 1807) the tsar came to terms with the French emperor, sacrificing the interests of his ally. By the treaty of Tilsit (July 9) the king of Prussia was stripped of the best part of his dominions and more than half his subjects. (J. St.)

Germany now seemed fairly in the grip of Napoleon. Early in November 1806 he had contemptuously deposed the elector of Hesse and added his dominions to Jerome's kingdom of Westphalia; on the 21st of the same month he issued from Berlin the famous decree establishing the "continental system," which, by forbidding all trade with England, threatened German commerce with ruin. His triumph seemed complete when, on the 11th of October 1807, Metternich signed at Fontainebleau, on behalf of Austria, a convention that conceded all his outstanding claims, and seemed to range the Habsburg monarchy definitely on his side. There was, however, to be one final struggle before Napoleon's supremacy was established. The submission of Austria had been but an expedient for gaining time; under Count Stadion's auspices she set to work increasing and reorganizing her forces; and when it became clear from Napoleon's resentment that he was meditating fresh designs against her she declared war (1809). The campaign ended in the crushing defeat of Wagram (July 6) and the humiliating treaty of peace dictated by Napoleon at the palace of Schönbrunn in Vienna (October 14). Austria, shorn of her fairest provinces, robbed of her overseas commerce, bankrupt and surrounded on all sides by the territories of the French emperor and his allies, seemed to exist only on sufferance, and had ceased to have any effective authority in Germany—now absolutely in the power of Napoleon, who proved this in 1810 by annexing the whole of the northern coast as far as the Elbe to his empire.

End of the Holy Roman Empire.

Prussia defeated at Jena.

Napoleon in power.

The very completeness of the humiliation of Germany was the means of her deliverance. She had been taught self-respect by Frederick II., and by her great writers in literature and philosophy; it was felt to be intolerable that in politics she should do the bidding of a foreign master. Among a large section of the community patriotism became for the first time a consuming passion, and it was stimulated by the counsels of several manly teachers, among whom the first place belongs to the philosopher Fichte. The governments cautiously took advantage of the national movement to strengthen their position. Even in Austria, where on the 8th of October 1809 Metternich had become minister for foreign affairs and the dominant influence in the councils of the empire, some timely concessions were made to the various populations. Prussia, under the guidance of her great minister Stein, reorganized her entire administration. She abolished serfdom, granted municipal rights to the cities, established an admirable system of elementary and secondary education, and invited all classes to compete for civil offices; and ample means were provided for the approaching struggle by drastic military reform. Napoleon had extracted an engagement that the Prussian army should be limited to 42,000 men. This was fulfilled in the letter, but in spirit set aside, for one body of men was trained after another until the larger part of the male population were in a position, when a fitting opportunity should occur, to take up arms for their country.

The disastrous retreat of the French from Moscow in 1812 gave Germany the occasion she desired. In 1813 King Frederick William, after an agony of hesitation, was forced by the patriotic initiative of General York, who concluded with the Russians the convention of Tauroggen on his own responsibility, and by the pressure of public opinion supported by Queen Louise and by Hardenberg, to enter into an alliance with Russia. All now depended on the attitude of Austria; and this was for some time doubtful. The diplomacy of Metternich (*q.v.*), untouched by the patriotic fervour which he disliked and distrusted, was directed solely to gaining time to enable Austria to intervene with decisive effect and win for the Habsburg monarchy the position it had lost. When the time came, after the famous interview with Napoleon at Dresden, and the breakdown of the abortive congress of Prague, Austria threw in her lot with the allies. The campaign that followed, after some initial reverses, culminated in the crushing victory of the allies at Leipzig (October 16-18, 1813), and was succeeded by the joint invasion of France, during which the German troops wreaked vengeance on the unhappy population for the wrongs and violences of the French rule in Germany.

Long before the issue of the War of Liberation had been finally decided, diplomacy had been at work in an endeavour to settle the future constitution of Germany. In this matter, as in others, the weakness of the Prussian government played into the hands of Austria. Metternich had been allowed to take the initiative in negotiating with the princes of the Confederation of the Rhine, and the price of their adhesion to the cause of the allies had been the guarantee by Austria of their independent sovereignty. The guarantee had been willingly given; for Metternich had no desire to see the creation of a powerful unified German empire, but aimed at the establishment of a loose confederation of weak states over which Austria, by reason of her ancient imperial prestige and her vast non-German power, would exercise a dominant influence. This, then, was the view that prevailed, and by the treaty of Chaumont (March 1, 1814) it was decided that Germany should consist of a confederation of sovereign states.

The new constitution of Germany, as embodied in the Final Act of the congress of Vienna (June 9, 1815) was based on this principle. It was the work of a special committee of the congress, presided over by Metternich; and, owing to the panic created by Napoleon's return from Elba (March 5), it remained a mere sketch, the hasty output of a few hurried sessions, of which the elaboration was reserved for the future. In spite of the clamour of the mediatized

princes for the restoration of their "liberties," no attempt was made to reverse the essential changes in the territorial disposition of Germany made during the revolutionary epoch. Of the 300 odd territorial sovereignties under the Holy Empire only 39 survived, and these were readjusted on the traditional principles of "compensations," "rectification of frontiers" and "balance of power." The most fateful arrangements were naturally those that affected the two leading powers, Austria and Prussia. The latter had made strenuous efforts, supported by Alexander I. of Russia, to obtain the annexation of the whole of Saxony, a project which was defeated by the opposition of Great Britain, Austria and France, an opposition which resulted in the secret treaty of the 3rd of January 1815 for eventual armed intervention. She received, however, the northern part of Saxony, Swedish Pomerania, Posen and those territories—formerly part of the kingdom of Westphalia—which constitute her Rhine provinces. While Prussia was thus established on the Rhine, Austria, by exchanging the Netherlands for Lombardo-Venetia and abandoning her claims to the former Habsburg possessions in Swabia, definitively resigned to Prussia the task of defending the western frontier of Germany, while she strengthened her power in the south-east by recovering from Bavaria, Salzburg, Vorarlberg and Tirol. Bavaria, in her turn, received back the greater part of the Palatinate on the left bank of the Rhine, with a strip of territory to connect it with the main body of her dominions. For the rest the sovereigns of Württemberg and Saxony retained the title of king bestowed upon them by Napoleon, and this title was also given to the elector of Hanover; the dukes of Weimar, Mecklenburg and Oldenburg became grand dukes; and Lübeck, Bremen, Hamburg and Frankfurt were declared free cities.

As the central organ of this confederation (*Bund*) was established the federal diet (*Bundestag*), consisting of delegates of the several states. By the terms of the Final Act this diet had very wide powers for the development of the mutual relations of the governments in all matters of common interest. It was empowered to arrange the fundamental laws of the confederation; to fix the organic institutions relating to its external, internal and military arrangements; to regulate the trade relations between the various federated states. Moreover, by the famous Article 13, which enacted that there were to be "assemblies of estates" in all the countries of the *Bund*, the constitutional liberties of the German people seemed to be placed under its aegis. But the constitution of the diet from the first condemned its debates to sterility. In the so-called narrower assembly (*Engere Versammlung*), for the transaction of ordinary business, Austria, Prussia, Bavaria, Saxony, Hanover, Württemberg, Baden, Hesse-Cassel, Hesse-Darmstadt, Holstein and Luxemburg had one vote each; while the remaining twenty-eight states were divided into six *curias*, of which each had but a single vote. In this assembly a vote of the majority decided. Questions of more than usual importance were, however, to be settled in the general assembly (*Plenum*) where a two-thirds majority was necessary to carry a resolution. In this assembly the voting power was somewhat differently distributed; but the attempt to make it bear some proportion to the importance of the various states worked out so badly that Austria had only four times the voting power of the tiny principality of Liechtenstein. Finally it was laid down by Article 7 that a unanimous vote was necessary for changing "fundamental laws, organic institutions, individual rights, or in matters of religion," a formula wide enough to embrace every question of importance with which the diet might be called upon to deal. Austria, in virtue of her tradition, received the perpetual presidency of the diet. It was clear that in such a governing body neither Austria nor Prussia would be content with her constitutional position, and that the internal politics of Germany would resolve themselves into a diplomatic duel for ascendancy between the two powers, for which the diet would merely serve as a convenient arena.

In this duel the victory of Austria was soon declared. The Prussian government believed that the effective government

Revival of Germany.

War of Liberation.

The federal diet.

The German confederation.

of Germany could only be secured by a separate understanding between the two great powers; and the indiscretion of the Prussian plenipotentiary revealed to the diet a plan for what meant practically the division of Germany into Prussian and Austrian spheres of influence. This threw the lesser princes, already alarmed at the growth of Prussian military power, into the arms of Austria, which thus secured a permanent majority in the diet. To avoid any possible modification of a situation so satisfactory, Count Buol, the Austrian president of the diet, was instructed to announce that the constitution as fixed by the Final Act, and guaranteed by Europe, must be regarded as final; that it might be interpreted, but not altered.

The conception of the diet as a sort of international board of control, responsible in the last resort not to Germany but to Europe, exactly suited Metternich's policy, in which the interests of Germany were subordinate to the wider ambitions of the Habsburg monarchy. It was, moreover, largely justified by the constituent elements of the diet itself. Of the German states represented in it even Prussia, by the acquisition of Posen, had become a non-German power; the Habsburg monarchy was predominantly non-German; Hanover was attached to the crown of Great Britain, Holstein to that of Denmark, Luxembourg to that of the Netherlands. The diet, then, properly controlled, was capable of being converted into an effective instrument for furthering the policy of "stability" which Metternich sought to impose upon Europe. Its one effort to make its authority effective as the guardian of the constitution, in the matter of the repudiation of the Westphalian debt and of the sale of the domains by the elector of Hesse, was crushed by the indignant intervention of Austria. Henceforth its sole effective function was to endorse and promulgate the decrees of the government of Vienna.

In this respect the diet fairly reflected the place of Germany in Europe. The constitution was the work of the powers, which in all matters arising out of it constituted the final court of appeal. The result was not wholly one-sided. Until the congress of Troppau in 1820 "Jacobinism" was still enthroned in high places in the person of Alexander I. of Russia, whose "divine mission," for the time, included a not wholly disinterested advocacy of the due carrying out of Article 13 of the Final Act. It was not to Russia's interest to see Austrian influence supreme in the confederation. The lesser German princes, too, were quick to grasp at any means to strengthen their position against the dominant powers, and to this end they appealed to the Liberal sentiment of their peoples. Not that this sentiment was very deep or widespread. The mass of the people, as Metternich rightly observed, wished for rest, not constitutions; but the minority of thoughtful men—professors, students, officials, many soldiers—resented the dashing of the hopes of German unity aroused by the War of Liberation, and had drunk deep of the revolutionary inspiration. This sentiment, since it could not be turned to the uses of a united Germany, might be made to serve the purposes of particularism. Prussia, in spite of the promises of Frederick William in the hour of need, remained without a central constitution; all the more reason why the states of second rank should provide themselves with one. Charles Augustus, the enlightened grand duke of Weimar, set the example, from the best of motives. Bavaria, Baden, Württemberg and others followed, from motives less disinterested. Much depended on the success of these experiments.

To Metternich they were wholly unwelcome. In spite of the ring-fence of censors, and custom-house officers, there was danger of the Liberal infection spreading to Austria, with disintegrating results; and the pose of the tsar as protector of German liberties was a perpetual menace. The zeal and inexperience of German Liberals played into his hands. The patriotist and Pan-Germanism of the gymnastic societies (*Turnvereine*) and students' associations (*Burschenschaften*) expressed themselves with more noise than discretion; in the South-German parliaments the platitudes and catchwords of the Revolution were echoed. Soon, in Baden, in

Württemberg, in Bavaria, the sovereigns and the chambers were at odds, united only in a common opposition to the central authority. To sovereigns whose nerves had been shattered by the vicissitudes of the revolutionary epoch these symptoms were in the highest degree alarming; and Metternich was at pains to exaggerate their significance. The "Wartburg festival" of October 1818, which issued in nothing worse than the solemn burning, in imitation of Dr. Martin Luther, of Kamptz's police law, a corporal's cane and an uhlan's stays, was magnified into a rebellion; drew down upon the grand duke of Weimar a collective protest of the powers; and set in motion the whole machinery of reaction. The murder of the dramatist Kotzebue, as an agent of this reaction, in the following year, by a fanatical student named Karl Sand, clinched the matter; it became obvious to the governments that a policy of rigorous repression was necessary if a fresh revolution were to be avoided. In October, after a preliminary meeting between Metternich and Hardenberg, in the course of which the latter signed a convention pledging Prussia to Austria's system, a meeting of German ministers was held at Carlsbad, the discussion of which issued in the famous Carlsbad Decrees (October 17, 1819). These contained elaborate provisions for supervising the universities and muzzling the press, laying down that no constitution "inconsistent with the monarchical principle" should be granted, and setting up a central commission at Mainz to inquire into the machinations of the great revolutionary secret society which existed only in the imagination of the authorities. The Carlsbad Decrees, hurried through the diet under Austrian pressure, excited considerable opposition among the lesser sovereigns, who resented the claim of the diet to interfere in the internal concerns of their states, and whose protests at Frankfurt had been expunged from the records. The king of Württemberg, ever the champion of German "particularism," gave expression to his feelings by issuing a new constitution to his kingdom, and appealed to his relative, the emperor Alexander, who had not yet been won over by Metternich to the policy of war *à outrance* against reform, and took this occasion to issue a fresh manifesto of his Liberal creed.

At the conference of ministers which met at Vienna, on the 20th of November, for the purpose of "developing and completing the Federal Act of the congress of Vienna," Metternich found himself face to face with a more formidable opposition than at Carlsbad. The "middle" states, headed by Württemberg, had drawn together, to form the nucleus of an inner league of "pure German States" against Austria and Prussia, and of "Liberal particularism" against the encroachments of the diet. With Russia and, to a certain extent, Great Britain sympathetic, it was impossible to ignore their opposition. Moreover, Prussia was hardly prepared to endorse a policy of greatly strengthening the authority of the diet, which might have been fatal to the Customs Union of which she was laying the foundation. Metternich realized the situation, and yielded so gracefully that he gave his temporary defeat the air of a victory. The result was that the Vienna Final Act (May 15, 1820), which received the sanction of the diet on the 8th of June, was not unsatisfactory to the lesser states while doing nothing to lessen Austrian prestige. This instrument merely defined more clearly the principles of the Federal Act of 1815. So far from enlarging the powers of the diet, it reaffirmed the doctrine of non-intervention; and, above all, it renewed the clause forbidding any fundamental modification of the constitution without a unanimous vote. On the vexed question of the interpretation of Article 13 Metternich recognized the inexpediency of requiring the South German states to revise their constitutions in a reactionary sense. By Articles 56 and 57, however, it was laid down that constitutions could only be altered by constitutional means; that the complete authority of the state must remain united in its head; and that the sovereign could be bound to co-operate with the estates only in the exercise of particular rights. These provisions, in fact, secured for Metternich all that was necessary for the success of his policy: the maintenance of the *status quo*. So long as the repressive machinery instituted by the Carlsbad

Decrees worked smoothly, Germany was not likely to be troubled by revolutions.

The period that followed was one, outwardly at least, of political stagnation. The Mainz Commission, though hampered by the jealousy of the governments (the king of Prussia refused to allow his subjects to be haled before it), was none the less effective enough in preventing all free expression of opinion; while at the universities the official "curators" kept Liberal enthusiasts in order. The exuberance of the epoch of Liberation gave place to a dull lethargy in things political, relieved only by the Philhellenism which gave voice to the aspirations of Germany under the disguise of enthusiasm for Greece. Even the July revolution of 1830 in Paris reacted but partially and spasmodically on Germany. In Hanover, Brunswick, Saxony and Hesse-Cassel popular movements led to the granting of constitutions, and in the states already constituting Liberal concessions were made or promised.

Revolutions of 1830.

But the governments of Prussia and Austria were unaffected; and when the storm had died down Metternich was able, with the aid of the federal diet, to resume his task of holding "the Revolution" in check. No attempt was, indeed, made to restore the deposed duke of Brunswick, who by universal consent had richly deserved his fate; but the elector of Hesse could reckon on the sympathy of the diet in his struggle with the chambers (see HESSE-CASSEL), and when, in 1837, King Ernest Augustus of Hanover inaugurated his reign by restoring the old illiberal constitution abolished in 1831, the diet refused to interfere. It was left to the seven professors of Göttingen to protest; who, deprived of their posts, became as famous in the constitutional history of Germany as the seven bishops in that of England.

Yet this period was by no means sterile in developments destined to produce momentous results. In Prussia especially the government continued active in organizing and consolidating the heterogeneous elements introduced into the monarchy by the settlement of 1815. The task was no easy one. There was no sense of national unity between the Catholics of the Rhine provinces, long submitted to the influence of liberal France, and the Lutheran squires of the mark of Brandenburg, the most stereotyped class in Europe; there was little in common between either and the Polish population of the province of Posen. The Prussian monarchy, the traditional champion of Protestant orthodoxy, found the new Catholic elements difficult to assimilate; and premonitory symptoms were not wanting of a revival of the secular contest between the spiritual and temporal powers which was to culminate after the promulgation of the dogma of papal infallibility (1870) in the *Kulturkampf*. These conditions formed the excuse for the continual postponement of the promised constitution. But the narrow piety of Frederick William III. was less calculated to promote the success of a benevolent despotism than the contemptuous scepticism of Frederick the Great, and a central parliament would have proved a safety valve for jarring passions which the mistaken efforts of the king to suppress, by means of royal decrees and military coercion, only served to embitter. Yet the conscientious tradition of Prussian officialism accomplished much in the way of administrative reform.

Above all it evolved the Customs-Union (*Zollverein*), which gradually attached the smaller states, by material interests if not by sympathy, to the Prussian system. A reform of the tariff conditions in the new Prussian monarchy had been from the first a matter of urgent necessity, and this was undertaken under the auspices of Baron Heinrich von Bülow (1792-1846), minister in the foreign department for commerce and shipping, and Karl Georg Maassen (1769-1834), the minister of finance. When they took office there were in Prussia sixty different tariffs, with a total of nearly 3800 classes of taxable goods: in some parts importation was free, or all but free; in others there was absolute prohibition, or duties so heavy as to amount to practical prohibition. Moreover, the long and broken line of the Prussian frontier, together

with the numerous enclaves, made the effective enforcement of a high tariff impossible. In these circumstances it was decided to introduce a system of comparative free trade; raw materials were admitted free; a uniform import of 10% was levied on manufactured goods, and 20% on "colonial wares," the tax being determined not by the estimated value, but by the weight of the articles. It was soon realized, however, that to make this system complete the neighbouring states must be drawn into it; and a beginning was made with those which were enclaves in Prussian territory, of which there were no less than thirteen. Under the new tariff laws light transit dues were imposed on goods passing through Prussia; and it was easy to bring pressure to bear on states completely surrounded by Prussian territory by increasing these dues or, if need were, by forbidding the transit altogether. The small states, though jealous of their sovereign independence, found it impossible to hold out. Schwarzburg-Sondershausen was the first to succumb (1819); Schwarzburg-Rudolstadt (1822), Saxe-Weimar and Anhalt-Bernburg (1823), Lippe-Detmold and Mecklenburg-Schwerin (1826) followed suit so far as their "enclaved" territories were concerned; and in 1826 Anhalt-Dessau and Anhalt-Cöthen, after several years' resistance, joined the Prussian Customs-Union. In 1828 Hesse-Cassel entered into a commercial treaty with Prussia. Meanwhile, alarmed at this tendency, and hopeless of obtaining any general system from the federal diet, the "middle" states had drawn together; by a treaty signed on the 18th of January 1828 Württemberg and Bavaria formed a tariff union, which was joined in the following year by the Hohenzollern principalities; and on the 24th of September 1828 was formed the so-called "Middle German Commercial Union" (*Handelsverein*) between Hanover, Hesse-Cassel, the Saxon duchies, Brunswick, Nassau, the principalities of Reuss and Schwarzburg, and the free cities of Frankfurt and Bremen, the object of which was to prevent the extension of the Prussian system and, above all, any union of the northern Zollverein with that of Bavaria and Württemberg. It was soon, however, found that these separate systems were unworkable; on the 27th of May 1829 Prussia signed a commercial treaty with the southern union; the *Handelsverein* was broken up, and one by one the lesser states joined the Prussian Customs-Union. Finally, on the 22nd of March 1833, the northern and southern unions were amalgamated; Saxony and the Thuringian states attached themselves to this union in the same year; and on the 1st of January 1834 the German Customs- and Commercial-Union (*Deutscher Zoll- und Handelsverein*) came into existence, which included for tariff purposes within a single frontier the greater part of Germany. Outside this, though not in hostility to it, Hanover, Brunswick, Oldenburg and Schaumburg-Lippe formed a separate customs-union (*Steuerverein*) by treaties signed on the 1st of May 1834 and the 7th of May 1836, and to this certain Prussian and Hessian enclaves were attached. Subsequently other states, e.g. Baden and Nassau (1836), Frankfurt and Luxemburg (1842), joined the Prussian Zollverein, to which certain of the members of the *Steuerverein* also transferred themselves (Brunswick and Lippe, 1842). Finally, as a counter-move to the Austrian efforts to break up the Zollverein, the latter came to terms with the *Steuerverein*, which, on the 1st of January 1854, was absorbed in the Prussian system. Hamburg was to remain outside until 1883; but practically the whole of what now is Germany was thus included in a union in which Prussia had a predominating influence, and to which, when too late, Austria in vain sought admission.¹

Even in the earlier stages of its development the Zollverein had a marked effect on the condition of the country. Its growth coincided with the introduction of railways, and enabled the nation to derive from them the full benefit; so that, in spite of the confusion of political powers, material prosperity increased, together with the consciousness of national unity and a tendency to look to Berlin rather than to Vienna as the centre of this unity.

¹ The best account, in English, of the development of the Zollverein is in Percy Ashley's *Modern Tariff History* (London, 1904).

This tendency was increased by the accession to the throne of Prussia, in 1840, of Frederick William IV., a prince whose conspicuous talents and supposed "advanced" views raised the hopes of the German Liberals in the same degree as they excited the alarm and contempt of Metternich. In the end, however, the fears were more justified than the hopes. The reign began well, it is true, notably in the reversal of the narrow ecclesiastical policy of Frederick William III. But the new king was a child of the romantic movement, with no real understanding of, and still less sympathy with, the modern Liberal point of view. He cherished the idea of German unity, but could conceive of it only in the form of the restored Holy Empire under the house of Habsburg; and so little did he understand the growing nationalist temper of his people that he seriously negotiated for a union of the Lutheran and Anglican churches, of which the sole premature offspring was the Protestant bishopric of Jerusalem.

Meanwhile the Unionist and Liberal agitation was growing in strength, partly owing to the very efforts made to restrain it. The emperor Nicholas I. of Russia, kept informed by his agents of the tendencies of opinion, thought it right to warn his kinsman of Prussia of the approach of danger. But Frederick William, though the tsar's influence over him was as great as over his father, refused to be convinced. He even thought the time opportune for finishing "the building begun by Papa" by summoning the central assembly of the diets, and wrote to the tsar to this effect (December 31, 1845); and he persevered in this intention in spite of the tsar's paternal remonstrances. On the 13th of February 1847 was issued a patent summoning the united diet of Prussia. But, as Metternich had prophesied, this only provided an organ for giving voice to larger constitutional aspirations. The result was a constitutional dead-lock; for the diet refused to sanction loans until its "representative" character was recognized; and the king refused to allow "to come between Almighty God in heaven and this land a blotted parchment, to rule us with paragraphs, and to replace the ancient, sacred bond of loyalty." On the 26th of June the diet was dissolved, nothing having been done but to reveal the widening gulf between the principle of monarchy and the growing forces of German Liberalism.

The strength of these forces was revealed when the February revolution of 1848 in Paris gave the signal for the outbreak of popular movements throughout Europe. The effect of the revolution in Vienna, involving the fall of Metternich (May 13) and followed by the nationalist movements in Hungary and Bohemia, was stupendous in Germany. Accustomed to look to Austria for guidance and material support, the princes everywhere found themselves helpless in face of the popular clamour. The only power which might have stemmed the tide was Prussia. But Frederick William's emotional and kindly temperament little fitted him to use "the mailed fist"; though the riot which broke out in Berlin on the 15th of March was suppressed by the troops with but little bloodshed, the king shrank with horror from the thought of fighting his "beloved Berliners," and when on the night of the 18th the fighting was renewed, he entered into negotiation with the insurgents, negotiations that resulted in the withdrawal of the troops from Berlin. The next day, Frederick William, with characteristic histrionic versatility, was heading a procession round the streets of Berlin, wrapped in the German tricolour, and extolling in a letter to the indignant tsar the consummation of "the glorious German revolution."

The collapse of the Prussian autocracy involved that of the lesser German potentates. On the 30th of March the federal diet hoisted the German tricolour and authorized the assembling of the German national parliament at Frankfort. Arrangements for this had already been made without official sanction. A number of deputies, belonging to different legislative assemblies, taking it upon themselves to give voice to the national demands, had met at Heidelberg, and a committee appointed by them had invited all

Germans who then were, or who had formerly been, members of diets, as well as some other public men, to meet at Frankfort for the purpose of considering the question of national reform. About 500 representatives accepted the invitation. They constituted themselves a preliminary parliament (*Vorparlament*), and at once began to provide for the election of a national assembly. It was decided that there should be a representative for every group of 50,000 inhabitants, and that the election should be by universal suffrage. A considerable party wished that the preliminary parliament should continue to act until the assembly should be formed, but this was overruled, the majority contenting themselves with the appointment of a committee of 50, whose duty it should be in the interval to guard the national interests. Some of those who were discontented with this decision retired from the preliminary parliament, and a few of them, of republican sympathies, called the population of Upper Baden to arms. The rising was put down by the troops of Baden, but it did considerable injury by awakening the fears of the more moderate portion of the community. Great hindrances were put in the way of the elections, but, as the Prussian and Austrian governments were too much occupied with their immediate difficulties to resist to the uttermost, the parliament was at last chosen, and met at Frankfort on the 18th May. The old diet, without being formally dissolved, (an omission that was to have notable consequences) broke up, and the national representatives had before them a clear field. Their task would in any case have been one of extreme difficulty.

The new-born sentiment of national unity disguised a variety of conflicting ideals, as well as deep-seated traditional local antagonisms; the problem of constructing a new Germany out of states, several of which, and those the most powerful, were largely composed of non-German elements, was sure to lead to international complications; moreover, the military power of the monarchies had only been temporarily paralysed, not destroyed. Yet, had the parliament acted with promptitude and discretion it might have been successful. Neither Austria nor Prussia was for some time in a position to thwart it, and the sovereigns of the smaller states were too much afraid of the revolutionary elements manifested on all sides to oppose its will. But the Germans had had no experience of free political life. Nearly every deputy had his own theory of the course which ought to be pursued, and felt sure that the country would go to ruin if it were not adopted. Learned professors and talkative journalists insisted on delivering interminable speeches and on examining in the light of ultimate philosophical principles every proposal laid before the assembly. Thus precious time was lost, violent antagonisms were called forth, the patience of the nation was exhausted, and the reactionary forces were able to gather strength for once more asserting themselves. The very first important question brought out the weaknesses of the deputies. This related to the nature of the central provisional executive. A committee appointed to discuss the matter suggested that there should be a directory of three members, appointed by the German governments, subject to the approval of the parliament, and ruling by means of ministers responsible to the latter body. This elaborate scheme found favour with a large number of members, but others insisted that there should be a president or a central committee, appointed by the parliament, while another party pleaded that the parliament itself should exercise executive as well as legislative functions. At last, after a vast amount of tedious and useless discussion, it was agreed that the parliament should appoint an imperial vicar (*Reichsverweser*) who should carry on the government by means of a ministry selected by himself; and on the motion of Heinrich von Gagern the archduke John of Austria was chosen by a large majority for the office. With as little delay as possible he formed an imperial cabinet, and there were hopes that, as his appointment was generally approved both by the sovereigns and the people, more rapid progress would be made with the great and complicated work in hand. Unfortunately, however, it was necessary to enter upon the discussion of the fundamental laws, a subject

German
national
ism.

Frankfort
parliament.

presenting many opportunities for the display of rhetoric and intellectual subtlety. It was soon obvious that beneath all varieties of individual opinion there were two bitterly hostile tendencies—republican and constitutionalist. These two parties attacked each other with constantly growing animosity, and in a few weeks sensible men outside the parliament gave up all hope of their dealing satisfactorily with the problem they had been appointed to solve.

In the midst of these disputes the attention of the nation was occupied by a question which had arisen before the outbreak of the revolutionary movements—the so-called “Schleswig-Holstein question” (*q.v.*). In 1846 Christian VIII. of Denmark had officially proclaimed that Schleswig and the greater part of Holstein were indissolubly connected with the Danish monarchy. This excited vehement opposition among the Germans, on the ground that Holstein, although subject to the king of Denmark, was a member of the German confederation, and that in virtue of ancient treaties it could not be severed from Schleswig. In 1848 the German party in the duchies, headed by Prince Frederick of Augustenburg, rose against the Danish government. Frederick VII., who had just succeeded Christian VIII., put down the rebellion, but Prussia, acting in the name of the confederation, despatched an army against the Danes, and drove them from Schleswig. The Danes, who were supported by Russia, responded by blockading the Baltic ports, which Germany, having no navy, was unable effectually to defend. By the mediation of Great Britain an armistice was concluded, and the Prussian troops evacuated the northern districts of Schleswig. As the Danes soon afterwards took possession of Schleswig again, the Prussians once more drove them back, but, in view of the threatening attitude of the powers, Frederick William summoned up courage to flout the opinion of the German parliament, and on the 26th of August, without the central government being consulted, an armistice of seven months was agreed upon at Malmö.

The full significance of this event was not at once realized. To indignant patriots it seemed no more than a piece of perfidy, for which Prussia should be called to account by united Germany. The provisional government of the duchies appealed from Prussia to the German regent; and the Frankfort parliament hotly took up its cause. A large majority voted an order countermanding the withdrawal of the Prussian troops, in spite of the protest of the ministry, who saw that it would be impossible to make it effective. The ministry resigned, but no other could be found to take its place; and the majority began to realize the situation. The central government depended ultimately on the armed support of the two great powers; to quarrel with those would be to ruin the constitution, or at best to play into the hands of the extreme revolutionists. On the 14th of September the question of the convention of Malmö again came up for discussion, and was angrily debated. The democrats called their adherents to arms against the traitors who were preparing to sell the Schleswig-Holsteiners. The Moderates took alarm; they had no stomach for an open war with the governments; and in the end the convention was confirmed by a sufficient majority. The result was civil war in the streets of Frankfort; two deputies were murdered; and the parliament, which could think of no better way of meeting the crisis than by continuing “with imposing calm” to discuss “fundamental rights,” was only saved from the fury of the mob by Prussian troops. Its existence was saved, but its prestige had vanished; and the destinies of the German people were seen to be in the hands that held the sword.

While these events were in progress, it seemed not impossible that the Austrian empire would fall to pieces. Bohemia and the Italian states were in revolt, and the Hungarians strove with passionate earnestness for independence. Towards the end of 1848 Vienna was completely in the hands of the revolutionary party, and it was taken only after desperate fighting. A reactionary ministry, headed by Prince Schwarzenberg, was then raised to power,

and in order that a strong policy might be the more vigorously pushed forward, the emperor Ferdinand resigned, and was succeeded by his nephew, Francis Joseph.

The prospects of reform were not much more favourable in Prussia. The assembly summoned amid the revolutionary excitement of March met on the 22nd of May. Demands for a constitutional system were urged with great force, and they would probably have been granted but for the opposition due to the violence of politicians out of doors. The aristocratic class saw ruin before it if the smallest concession were made to popular wishes, and it soon recovered from the terror into which it had been plunged at the outbreak of the revolution. Extreme antagonism was excited by such proposals as that the king should no longer be said to wear his crown “by the grace of God”; and the animosity between the liberal and the conservative sections was driven to the highest pitch by the attack of the democratic majority of the diet on the army and the attempt to remodel it in the direction of a national militia. Matters came to a crisis at the end of October when the diet passed a resolution calling on the king to intervene in favour of the Viennese revolutionists. When, on the evening of the 30th, a mob surrounded the palace, clamouring for the king to give effect to this resolution, Frederick William lost patience, ordered General Wrangel to occupy Berlin with troops, and on the 2nd of November placed Count Brandenburg, a scion of the royal house and a Prussian of the old school, at the head of a new ministry. On the pretext that fair deliberation was impossible in the capital, the assembly was now ordered to meet in Brandenburg, while troops were concentrated near Berlin and a state of siege was proclaimed. In vain the assembly protested and continued its sittings, going even so far as to forbid the payment of taxes while it was subjected to illegal treatment. It was forced in the end to submit. But the discussions in Brandenburg were no more successful than those in Berlin; and at last, on the 5th of December, the king dissolved the assembly, granted a constitution about which it had not been consulted, and gave orders for the election of a representative chamber.

About the time that the Prussian parliament was thus created, and that the emperor Ferdinand resigned, the Frankfort parliament succeeded in formulating the fundamental laws, which were duly proclaimed to be those of Germany as it was now to be constituted. The principal clauses of the constitution then began to be discussed. By far the most difficult question was the relation in which Austria should stand to the Germany of the future. There was a universal wish that the Austrian Germans should be included in the German state; on the other hand, it was felt that if all the various nationalities of Austria formed a united monarchy, and if this monarchy as a whole were included in the confederation, it would necessarily overshadow Germany, and expose her to unnecessary external dangers. It was therefore resolved that, although a German country might be under the same ruler as non-German lands, it could not be so joined to them as to form with them a single nation. Had the parliament adopted this resolution at once, instead of exhausting itself by pedantic disquisitions on the abstract principles of jurisprudence, it might have hoped to triumph; but Austria was not likely to submit to so severe a blow at the very time when she was strong enough to appoint a reactionary government, and had nearly re-established her authority, not only in Vienna, but in Bohemia and in Italy. Prince Schwarzenberg took the earliest opportunity to declare that the empire could not assent to any weakening of its influence. Bitter strife now broke out in the parliament between the Great German (*Gross-Deutsch*) and Little German (*Klein-Deutsch*) parties. Two of the ministers resigned, and one of those who took their place, Heinrich von Gagern (*q.v.*), proposed that, since Austria was to be a united state, she should not enter the confederation, but that her relations to Germany should be regulated by a special act of union. This of course meant that Prussia should be at the head of Germany, and recommended itself to the majority of the

Reform in Prussia.

Schleswig-Holstein.

Dispute in the Frankfort assembly.

The question of the constitution.

The revolution in Austria.

constitutional party. It was resisted by the Austrian members, who were supported by the ultramontanes and the democrats, both of whom disliked Prussia, the former because of her Protestantism, the latter because of her bureaucratic system. Gagern's proposal was, however, adopted. Immediately afterwards the question as to the character of the executive was raised. Some voted that a directory of princes should be appointed, others that there should be a president, eligible from the whole German nation; but the final decision was that the headship of the state should be offered by the parliament to some particular German prince, and that he should bear the title of German emperor.

The whole subject was as eagerly discussed throughout the country as in Frankfurt. Austria firmly opposed the idea of a united German state, insisting that the Austrian emperor could not consent to be subordinate to any other prince. She was supported by Bavaria, but on the other side were Prussia, Brunswick, Baden, Nassau, Mecklenburg and various other countries, besides the Hanseatic towns. For some time Austria offered no counter scheme, but she ultimately proposed that there should be a directory of seven princes, the chief place being held alternately by a Prussian and an Austrian imperial vicar. Nothing came of this suggestion, and in due time the parliament proceeded to the second reading of the constitution. It was revised in a democratic sense, but the imperial title was maintained, and a narrow majority decided that it should be hereditary. Frederick William IV. of Prussia was then chosen emperor.

All Germany awaited with anxiety the reply of Frederick William. It was thought not improbable that he would accept the honour offered him, for in the early part of his reign he had spoken of German unity as enthusiastically as of liberty, and, besides, the opportunity was surprisingly favourable. The larger number of the North-German states were at least not unwilling to submit to the arrangement; and Austria, whose opposition in ordinary circumstances would have been fatal, was paralysed by her struggle with Hungary. Frederick William, however, whose instincts were far from democratic, refused "to pick up a crown out of the gutter"; and the deputation which waited upon him was dismissed with the answer that he could not assume the imperial title without the full sanction of the princes and the free cities.

This answer was in reality a death-blow to the hopes of German patriots, but the parliament affected to believe that its cause was not yet lost, and appointed a committee to see that the provisions of the constitution were carried out. A vigorous agitation began in the country for the acceptance of the constitution by the governments. The king of Württemberg was forced to accede to it; and in Saxony, Baden and Rhenish Bavaria armed multitudes kept the sovereigns in terror. Prussia, which, following the example of Austria, had recalled her representatives from Frankfurt, sent her troops to put down these risings, and on the 21st of May 1849 the larger number of the deputies to the parliament voluntarily resigned their seats. A few republican members held on by it, and transferred the sittings to Stuttgart. Here they even elected an imperial government, but they had no longer any real influence, and on the 18th of June they were forcibly dispersed by order of the Württemberg ministry.

Although Frederick William had refused to become emperor, he was unwilling to miss altogether the opportunity afforded by the difficulties of Austria. He invited the states to send representatives to Berlin to discuss the constitution of Germany; and he concluded a treaty with the kings of Saxony and Hanover. Two days afterwards the three allies agreed upon a constitution which was in many respects identical with that drawn up by the Frankfurt parliament. The functions of the executive were, however, extended, the electoral law was made less democratic, and it was decided that, instead of an emperor, there should be merely a supreme chief aided by a college of princes. This constitution was accepted by a number of states, which assumed the name

of "The Union," and on the 30th of March 1850 a parliament consisting of two houses met in Erfurt. Both houses accepted the constitution; and, immediately after they broke up, the members of the Union assembled in Berlin, and a provisional college of princes was elected. By that time, however, the whole situation of Germany had changed. In the autumn of 1849 Austria had succeeded, by the help of Russia, in quelling the Hungarian insurrection, and she was then in no mood to let herself be thrust aside by Prussia. Encouraged by her, Hanover and Saxony had severed themselves from the Union, and Saxony, Württemberg and Bavaria arrived at an understanding as to a wholly new constitution. Afterwards all four states, with several others, accepted the invitation of Austria to consider the propriety of re-establishing the Confederation. The representatives of the states favourable to this proposal, *i.e.* Austria, Luxemburg, Denmark and the four kingdoms, came together in Frankfurt on the 4th of September 1850, constituted themselves a *Plenum* of the old diet and refused to admit the other states except under the terms of the act of 1815.

Thus the issue to which the events of about a century had been pointing was apparently raised; Germany was divided into two hostile parties, one set of states grouping themselves around Austria, another around Prussia. A difficulty which arose in Hesse-Cassel almost compelled the powers to bring their differences to the test of war. In this small state the liberal movement of 1848 had been followed by reaction, and the elector ventured to replace Hassenpflug, the unpopular minister who had been driven from power. Hassenpflug, being detested by the chamber, dissolved it in June 1850; but the new one was not less hostile, and refused to sanction the collection of the taxes until it had considered the budget. For this offence it also was dissolved, and orders were issued for the raising of the taxes without its consent. Many officials refused to obey; the judges remained loyal to the constitution; and when attempts were made to solve the difficulty by the army, the officers instructed to act resigned in a body. Meanwhile, Hassenpflug had appealed to the representatives in Frankfurt who claimed to be the restored diet, and under the influence of Austria they resolved to support him. Prussia, on the other hand, announced its determination to carry out the principles of the Union and to maintain the Hessian constitution. Austrian and Bavarian troops having entered Hesse, a Prussian army immediately occupied Cassel, and war appeared to be imminent. Prussia, however, was wholly unprepared for war; and, when this was realized, Radowitz, the foreign minister, who had so far pursued a vigorous policy, retired, and was replaced by Manteuffel, who, although the whole Prussian army was mobilized, began by making concessions. The Union was dissolved; and after Austria had despatched an ultimatum formulating her demands, Baron Manteuffel met Prince Schwarzenberg at Olmütz, and, by a convention signed on the 29th of November 1850, virtually yielded everything he insisted upon. The difficulty in Hesse was to be left to the decision of the German governments; and as soon as possible ministerial conferences were to be held in Dresden, with a view to the settlement of the German constitution.

The Austrian government strove to secure the appointment of a stronger executive than had hitherto existed; but its proposals met with steady opposition from Prussia. Every Prussian scheme was in like manner resisted by Austria. Thus, from the sheer inability of the assembled ministers to devise a plan on which all could agree, Prussia and the states that had joined her in the Union were compelled to recognize the Frankfurt diet. From the 12th of June 1851 its sittings went on as if nothing had occurred since it was dispersed.

This wretched fiasco was hardly less satisfactory to the majority of Germans than the manner in which the national claims in Schleswig-Holstein were maintained. The armistice of Malmoe having expired in March 1849, the war with Denmark was resumed. A considerable army was despatched against

ances by the Frankfort government, but on the 10th of an armistice was signed at Berlin for six months, and afterwards Prussia concluded peace. The inhabitants of the duchies, however, continued the war. During the interval at Olmütz between Manteuffel and Schwarzenberg it was that, like the affairs of Hesse-Cassel, those of Schleswig-Holstein should be submitted to the decision of all German states, and that, in the meantime, Prussia and Austria should act separately. By the intervention of Austrian troops peace was made; and when, early in 1852, the government of Denmark, offering a constitution for the whole monarchy, promised to appoint separate ministers for Schleswig and Holstein, and to give equal justice to the German and the Danish populations, the Danish powers declared themselves satisfied and the Austrian troops were withdrawn. The diet also, after some delay, proposed to be content with this arrangement. While it was discussing the subject, a conference of the European powers at London, and by the protocol of May 28, 1852, settled that Frederick VII. of Denmark should be succeeded by his son, duke of Glücksburg, and that the duchies should be indissolubly united to the Danish monarchy. Austria and Prussia accepted the protocol, but it was not signed by the diet.

In all these later events the first place had been taken by Austria. The temporary dissolution of the Zollverein in 1851 gave her an opportunity of trying to extend her influence, and she demanded that a union should be formed of which she should be the leading member. A congress of all the German states, with the exception of Prussia and two states which sympathized with her, was held in 1851; and it was followed by several other congresses favourable to Austrian pretensions. Prussia, however, being here on the ground, refused to give way; and not only was the union restored in accordance with her wishes, but she concluded with her in 1853 a treaty of commerce which secured her some important concessions.

Prussia had now fairly entered a period which, although not last very long, was, in some respects, as humiliating as any in her history. The popular movement, from which all great things had been hoped, had on some occasions almost touched its goal; and, as might have been expected, a reaction set in, which the princes knew how to turn to the fullest advantage. The Austrian government, after the rejection of Hungary, withdrew every concession it had made under pressure, and established a thorough despotism, resting upon the rights of the individual nationalities, and bringing all its subjects into a common political mould. In 1848 the parliament, summoned by the king on the 5th of October 1848, met early in the following year. Although the democrats had declined to vote, it was not conservative for the court, and not till the 31st of January 1850 was a understanding arrived at respecting the constitution. The constitution thus established was repeatedly revised, and always for the same object—to reduce to a minimum the power of the popular representatives, and to exalt and extend that of the monarchy. At the same time the ministry persecuted the press, and allowed hardly a whisper of discontent to pass unheeded. The smaller states followed with alacrity in the footsteps of the two leading powers. The Liberal ministries of 1848 and 1850, dismissed, the constitutions were changed or abolished, and new members were elected under a severely restricted suffrage. The battle had been fairly fought out between the government and the people, the latter would still have triumphed; but the former had now, in the Frankfort diet, a mightier enemy than ever against freedom. What it could do was made so clearly from the case of Hesse-Cassel. After the settlement at Olmütz, federal troops occupied that country, and the execution was carried out with shameful harshness. The law was everywhere proclaimed; officers, and all classes of men who had incurred the displeasure of the government, were subjected to arbitrary penalties; and such was the misery of the people that multitudes of them were compelled to emigrate.

The constitution having been destroyed by the *Bund*, the elector proclaimed one of his own making; but even the chamber elected under the provisions of this despotic scheme could not tolerate his hateful tyranny, and there were incessant disputes between it and the government. The *Bund* interfered in a like spirit in Hanover, although with less disastrous results, after the accession of George V. in 1851. For the whole of Germany this was emphatically the period of petty despotism, and not only from Hesse, but from all parts of the country there was a vast stream of emigration, mainly to the New World.

The outbreak of the Crimean War profoundly moved the German nation. The sympathies of Austria were necessarily with the Western powers, and in Prussia the majority of the people took the same side; but the Prussian government, which was at this time completely under the control of Russia, gave its moral support to the tsar. It did, indeed, assent to a treaty—afterwards signed on behalf of the confederation—by which Prussia and Austria guaranteed each other, but it resolutely opposed the mobilization of the confederate army. The Prussian people were keenly irritated by the cordial relations between their court and the most despotic power in Europe. They felt that they were thus most unjustly separated from the main stream of Western progress.

During the Crimean War the political reaction continued with unabated force. In Prussia the government appeared resolved to make up for its temporary submission to the popular will by the utmost violence on which it could venture. A general election took place in the autumn of 1855, and so harshly was the expression of opinion restrained that a chamber was returned with scarcely a single liberal element of serious importance. The feudalists called for a still further revision of the constitution, and urged that even the reforms effected by Stein should be undone. In Bavaria a chamber elected about the same time as that of Prussia was rather less docile; but the government shared to the full the absolutist tendencies of the day, and energetically combated the party which stood up for law and the constitution. The Hanoverian government, backed by the Frankfort diet, was still more successful in its warfare with the moderate reformers whom it was pleased to treat as revolutionists; and in Austria the feudalists so completely gained the upper hand that on the 18th of August 1855 the government signed a concordat, by which the state virtually submitted itself to the control of the church.

The German people seemed to have lost both the power and the will to assert their rights; but in reality they were deeply dissatisfied. And it was clear to impartial observers that, in the event of any great strain upon the power of the governments, the absolutist system would break down. The first symptom that the reaction had attained its utmost development displayed itself in Prussia, whose attention was for a time distracted from home politics by a quarrel with Switzerland. The Swiss authorities had imprisoned some foolish royalists of Neuchâtel, in which the house of Hohenzollern had never resigned its rights. War was threatened by Prussia, but when the prisoners were set free, the two states entered upon negotiations, and in the summer of 1857 King Frederick William withdrew all claims to the principality.

Soon after this, the mental condition of the king made it necessary that his duties should be undertaken by a substitute, and his brother William, the prince of Prussia, took his place for three months. In October 1858 the prince became regent. The accession to power of the new regent was universally recognized as involving a change of system. The temper of William, in contradistinction to that of his brother, was pre-eminently practical; and he had the reputation of a brave, piously orthodox Prussian soldier. The nickname "cartridge-prince" (*Kartüschenprinz*) bestowed upon him during the troubles of '48 was undeserved; but he was notoriously opposed to Liberalism and, had he followed his own instincts, he would have modified the constitution in a reactionary sense. Fortunately, however, he was singularly open to conviction,

Crimean War.

Prussia and Switzerland.

Regency of William of Prussia.

and Otto von Bismarck, though not yet in office, was already in his confidence. Bismarck realized that, in the struggle with Austria which he foresaw, Prussia could only be weakened were she to take up an attitude of opposition to the prevailing Liberal sentiment, and that to tamper with the constitution would not only be inexpedient, but useless, since special measures could always be resorted to, to meet special circumstances. The interests of Prussia, he urged, had been too often sacrificed to abstract ideas. William listened and was convinced. He not only left the constitution intact, but he dismissed Manteuffel's "feudal" ministry and replaced it with moderate Liberals.

The change was more revolutionary in appearance than in reality. Manteuffel and his policy were associated in the regent's mind with the humiliation of Olmütz, and the dismissal of the ministry symbolized the reversal of this policy. William believed with his whole soul in the unification of Germany, and in Prussia as its instrument; and, if he doubted, it was only as to the how and when. Of one thing he was certain—that whoever aspired to rule over Germany must be prepared to seize it (letter to von Natzmer, May 20, 1849). This attitude had little in common with the Liberal appeal to the voice of the people. Such a revolutionary foundation might be good enough for the ephemeral empires of France; the appeal of Prussia should be to the God of battles alone.

The antagonism between these conflicting principles was not long in revealing itself. In Germany the relations between

Prussia and the Austro-Italian War.

Austria and Prussia were becoming unpleasantly strained in the question of the admission of the Habsburg monarchy to the Zollverein, in that of the elector of Hesse and his parliament, in that of the relation of the Elbe duchies to the crown of Denmark. But for the outbreak of the Italian war of 1859 the struggle of 1866 might have been anticipated. The outcome of the war increased the prestige of Prussia. She had armed, not with the idea of going to the aid of a German power in difficulties, but in order, at the right moment, to cast her sword into the scale wherein her own interests might for the time lie. At the menace of her armaments, concentrated on the Rhine, Napoleon had stopped dead in the full career of victory; Austria, in the eyes of German men, had been placed under an obligation to her rival; and Italy realized the emergence of a new military power, whose interests in antagonism to Austria were identical with her own.

So striking an object lesson was not lost on the Prussian regent, and he entered on a vigorous policy of reforming and strengthening the army, General von Roon being appointed minister of war for this purpose. To the Liberal ministers, however, and to the Liberal majority in the Prussian diet, this was wholly objectionable. Schemes were under discussion for reforming the constitution of the Confederation and drawing the German states closer together on a Liberal basis; the moment seemed singularly inopportune for Prussia, which had not shown herself particularly zealous for the common interests, to menace the other German governments by increasing her separate armaments. When, therefore, on the 10th of February 1860, the bills necessary for carrying out the reform of the army were introduced into the diet, they met with so strenuous an opposition that they had to be withdrawn. Supplies were, however, granted for fourteen months, and the regent took this as justifying him in proceeding with his plans. On the 1st of January 1861 the standards of the new regiments were solemnly blessed; on the next day Frederick William IV. died, and the new king was face to face with a constitutional crisis.

Austria, meanwhile, had been making the first tentative essays in constitutional concession, which culminated, in May 1861, in the establishment at Vienna of a *Reichsrat* for the whole empire, including Hungary. The popularity she thus gained among German Liberals and Nationalists was helped by the course of events at Berlin. The Prussian diet of 1862 was no whit more tractable than its predecessor, but fell to attacking the professional army and advocating the extension of the militia (*Landwehr*) system; on the 11th of March the king dissolved

it in disgust, whereupon the Liberal ministry resigned, and was succeeded by the Conservative cabinet of Prince Hohenlohe. Public opinion was now violently asserted against the government; the new elections resulted (May 6) in the return of a yet larger Liberal majority; on the 22nd of August the army estimates were thrown out. Hohenlohe now declared himself incapable of carrying on the government, and King William entrusted it to Otto von Bismarck.

In choosing this man of iron will as his instrument during the actual crisis the king's instinct had not betrayed him. For nine years Prussian delegate at the diet of Frankfort, Bismarck was intimately acquainted with all the issues of the German problem; with his accustomed calculated bluntness he had more than once openly asserted that this problem could only be settled by Austria ceasing to influence the German courts and transferring "her centre of gravity towards Budapest"; with equal bluntness he told the committee on the budget, on the 30th of September 1862, that the problem could not be solved "by parliamentary decrees," but only "by blood and iron." For the supreme moment of this solution he was determined that Prussia should be fully prepared; and this meant that he must defy the majority within the diet and public opinion without. Some sort of constitutional pretence was given to the decision of the government to persevere with the military reforms by the support of the Upper House, and of this Bismarck availed himself to raise the necessary taxes without the consent of the popular assembly. He regretted the necessity for flouting public opinion, which he would have preferred to carry with him; in due course he would make his peace with Liberal sentiment, when success should have justified his defiance of it. His plans were singularly helped by international developments. The Polish rising of 1863 came just in time to prevent a threatened Franco-Russian alliance; the timid and double-faced attitude of both France and Austria during the revolt left them isolated in Europe, while Bismarck's ready assistance to Russia assured at least the benevolent neutrality in the coming struggle with the Habsburg power.

Meanwhile, among the German people the object lesson of the Italian war had greatly stimulated the sentiment of national unity. As to the principle, however, on which this unity was to be based, the antagonism that had been fatal in 1849 still existed. The German National Union (*Deutscher Nationalverein*), organized in the autumn of 1859, favoured the exclusion of Austria and the establishment of a federation under the hegemony of Prussia; it represented the views of the so-called "Gothaer," the political heirs of the rump of the Frankfort parliament which had re-assembled at Gotha in June 1849, and supported the Prussian Union and the Erfurt parliament. To counteract this, a conference of five hundred "Great Germans" assembled at Frankfort and, on the 22nd of October 1862, founded the German Reform Union (*Deutscher Reformverein*), which, consisting mainly of South German elements, supported the policy of Austria and the smaller states. The constitutional crisis in Prussia, however, brought both societies into line, and in 1863 the National Union united with the Reform Union in an attempt to defeat Prussian policy in the Schleswig-Holstein question.

This anti-Prussian feeling Austria now tried to exploit for her own advantage. On the 2nd of August the emperor Francis Joseph proposed to King William, during a meeting at Gastein, to lay before an assembly of the German princes a scheme for the reconstitution of the *Bund* of Frankfort. The king neither accepted nor refused; but, without waiting for his assent, invitations were sent out to the other princes, and on the 14th the congress (*Fürstentag*) opened at Frankfort. Of the German sovereign states but four were unrepresented—Anhalt-Bernburg, Holstein, Lippe and Prussia; but the absence of Prussia was felt to be fatal; the minor princes existed by reason of the balance between the two great powers, and objected as strongly to the exclusion of the one as of the other from the Confederation; an invitation to King William was therefore signed by all present and carried by the king of Saxony

Bismarck.

Views as to German unity.

The "Fürstentag" of Frankfort.

in person to Berlin. Bismarck, however, threatened to resign if the king accepted; and the congress had to do the best it could without Prussian co-operation. On the 1st of September it passed, with some slight modifications, the Austrian proposals for the reconstruction of the *Bund* under a supreme Directory, an assembly of delegates from the various parliaments, a federal court of appeal and periodical conferences of sovereigns. Everything now depended on the attitude of Prussia, and on the 22nd her decision was received. "In any reform of the *Bund*," it ran, "Prussia, equally with Austria, must have the right of vetoing war; she must be admitted, in the matter of the presidency, to absolute equality with Austria; and, finally, she will yield no title of her rights save to a parliament representing the whole German nation."

Prussia thus made a bid for the sympathy of the democracy at the same time as she declared war against the dynasties; and her power was revealed by the fact that her veto was sufficient to wreck a proposal seconded by the all but unanimous vote of the German sovereigns. The Austrian stroke had failed, and worse than failed, for Napoleon III., who had been filled with alarm at this attempt to create on his flank an "empire of 70,000,000," saw in Prussia's attitude no more than a determination to maintain for her own ends the division and weakness of Germany; and this mistaken diagnosis of the situation determined his attitude during the crisis that followed.

This crisis was due to the reopening of a fresh acute phase of the Schleswig-Holstein question by the accession of the "protocol-king" Christian IX. to the throne of Denmark (November 15, 1863), and his adhesion to the new constitution, promulgated two days before, which embodied the principle of the inalienable union of the Elbe duchies with the Danish body politic. The news of this event caused vast excitement in Germany; and the federal diet was supported by public opinion in its decision to uphold the claims of Prince Frederick of Augustenburg to the succession of the duchies. An agitation in his favour had already begun in Holstein and, after the promulgation of the new Danish constitution, this was extended to Schleswig. On the 24th of December Saxon and Hanoverian troops occupied Holstein in the name of the German Confederation, and supported by their presence and the favour of the population the prince of Augustenburg, as Duke Frederick VIII., assumed the government.

From these proceedings Prussia and Austria held rigorously aloof. Both had signed the protocol of 1852, and both realized that, if the European powers were to be given no excuse to intervene, their attitude must be scrupulously "correct"; and this involved the recognition of King Christian's rights in the duchies. On the other hand, the constitution of the 13th of November had been in flat contradiction to the protocol of London, which recognized the separate rights of the duchies; and if the two great German powers chose to make this violation of an agreement to which they had been parties a *casus belli*, Europe would have no right to interfere. Prussia had begun to mobilize in November; and Austria also soon realized that action must speedily be taken if the lesser German governments were not to be allowed to get out of hand. Russia and Great Britain had already protested against the occupation of Holstein and the support given to the Augustenburg claimant; and now Beust, the Saxon minister, was proposing that the federal diet, which had been no party to the protocol, should formally recognize his claim. Bismarck, then, had no difficult task in persuading Austria that the time for action had come. A last attempt of the two powers to carry the diet with them in recognizing the protocol having failed, they formally announced that they would act in the matter as independent European powers. On the 16th of January 1864 the agreement between them was signed, an article, drafted by Austria, intended to safeguard the settlement of 1852, being replaced at the instance of Prussia

Austro-Prussian alliance.

by another, which stated that the contracting powers would decide only in concert upon the relations of the duchies, and that in no case would they determine the succession save by mutual

consent. A clause was also inserted provisionally recognizing the principle of the integrity of Denmark.

Whatever Austria's ulterior views may have been, Bismarck certainly from the first had but one aim before him. He saw clearly what the possession of the duchies would mean to Germany, their vast importance for the future of German sea-power; already he had a vision of the great war-harbour of Kiel and the canal connecting the Baltic and the North seas; and he was determined that these should be, if not wholly Prussian, at least wholly under Prussian control. Annexation was the goal which from the beginning he kept steadily before his eyes (*Reminiscences*, ii. 10). As for treaties to the contrary, he was to avow in his *Reminiscences* that these have little force when no longer reinforced by the interests of the contracting parties. His main fear was that the Danes might refuse to fight and appeal instead to a European congress; and, to prevent this, he led the Copenhagen government to believe that Great Britain had threatened to intervene in the event of Prussia going to war, "though, as a matter of fact, England did nothing of the kind." This sufficed to provoke the defiance of the Danes, and on the 1st of February 1864 the Austrian and Prussian troops crossed the Eider. The issue of a war between powers so ill-matched was a foregone conclusion; the famous rampart of the Dannewerk (q.v.), on which the Danish defence chiefly relied, was turned, and after a short campaign, in which the Danes fought with distinguished courage, peace was concluded by the treaty of Vienna (August 1, 1864), by which Schleswig, Holstein and Lauenburg were ceded to Austria and Prussia jointly.

Danish War of 1864.

The Austro-Prussian alliance had been only an interlude in the great drama in which the two powers were playing rival parts. To the other causes of friction between them had been added, just before the war, a renewed quarrel as to Austria's relation to the Zollverein. In 1862, in the name of the customs union, Prussia had concluded with France a commercial treaty, based mainly on free trade principles. This treaty most of the small states refused to sign, and they were supported in their objections by Austria, which loudly complained that Prussia had given to a foreign power what she had denied to a sister state of the *Bund*. Prussia, however, remained firm, and declared that, were the treaty rejected, she would break up the Zollverein. After the war Bismarck in fact succeeded in obtaining the signature of the smaller states to the treaty; and Austria, her protests having proved unavailing, was fain to sign a commercial treaty with the Zollverein, essentially the same as that of 1853. Treaties concluded with Great Britain and Belgium, about the same time, also tended to enhance Prussian prestige.

Austria, Prussia and the Zollverein.

Austria now sought in the question of the Elbe duchies an occasion for re-establishing her influence in Germany. The ambitions of Prussia were notorious, and Austria had no wish to see her rival still further strengthened by the annexation of the duchies. In this attitude she was sure of the support of the German princes, and of German public opinion, which was enthusiastically in favour of the Augustenburg claimant. She therefore took up the cause of Duke Frederick, and under her influence a small majority of the federal diet decided to request the two powers to invest him with the sovereignty of Holstein. Bismarck's reply was to deny the competency of the diet to interfere; and in the Prussian parliament the minister of war moved for a special grant for the creation of a war-harbour at Kiel. Against this Austria protested, as having the same right as Prussia to Kiel; an angry correspondence followed; but neither power was quite prepared for war, and on the 20th of August 1865 the convention of Gastein, to use Bismarck's phrase, "papered over the cracks." Pending a settlement, Schleswig was to be occupied and administered by Prussia, Holstein by Austria; while Lauenburg was made over absolutely to Prussia in return for a money payment. This was so far a diplomatic victory for Prussia, as it ignored entirely the claims of the duke of Augustenburg.

Convention of Gastein.

Bismarck had consented to the convention of Gastein in order

to gain time to prepare the ground for the supreme struggle with Austria for the hegemony of Germany. He had no intention of postponing the issue long; for the circumstances of the two powers were wholly favourable to Prussia. The Prussian army had attained an unprecedented excellence of organization and discipline; the Prussian people, in spite of the parliamentary deadlock, were loyal and united; while in Austria army and state were alike disorganized by nationalist discontent and the breakdown of the centralized system. But there were other factors to be considered. The attitude of Napoleon was dubious; the active alliance of Italy was necessary to the certainty of Prussian success; and the policy of Italy depended ultimately upon that of France. Lastly, the conscience of King William, though since the acquisition of Lauenburg he had "developed a taste for conquest," shrank from provoking war with a German power. The news of the convention of Gastein, which seemed to re- cement the union of Germany, had been received in France with clamorous indignation; and on the 29th of August, under pressure of public opinion, the French government issued a circular note denouncing it as an outrage on national liberty and European law, the protest being backed by note of the 14th of September circulated by Lord John Russell on behalf of the British government. But Napoleon was himself little inclined to use the warlike tone of his people; and Bismarck found it easy to win him over to his views by explaining the temporary nature of the convention, and by dropping hints at the famous interview at Biarritz (September 30, 1865) of possible "compensations" to France in the event of a Prussian victory over Austria; the probability of a prolonged struggle in Germany between two powers apparently evenly matched, moreover, held out to the French emperor the prospect of his being able to intervene at the proper moment with overwhelming effect.

Napoleon having been successfully hoodwinked, Bismarck turned to Italy. His previous advances had been interrupted by the Gastein convention, which seemed to the Italian government a betrayal of the Italian cause. Italy attempted to negotiate with Austria for the purchase of Venetia; but the offer was curiously refused by the emperor Francis Joseph, and the counter-proposal of a commercial *rapprochement* was forestalled by Prussia, which with the aid of most of the lesser states, angered by the betrayal of their interests by Austria at Gastein, arranged a commercial treaty between Italy and the Zollverein, an act which involved the recognition of the Italian kingdom. The counter-stroke of Austria was to embarrass Prussia by allowing full play in Holstein to the agitation in favour of the Augustenburg claimant. To the protests of Prussia, Austria replied that she had a full right to do what she liked in the duchy, and that she still adhered to the declaration of the princes, made on the 28th of May 1864, in favour of Duke Frederick. This "perfidy" removed the last scruples of King William; and the Austro-Prussian alliance came to an end with the declaration of Bismarck that Prussia "must win full freedom for her own entire policy" and his refusal to continue the correspondence.

War, though still postponed, was now certain; and with this certainty the desire of the Italians for the Prussian alliance, now recommended by Napoleon, revived. By the 16th of March 1866 the Austrian war preparations were so far advanced that Count Mensdorff thought it safe to send an ultimatum to Prussia and, at the same time, a circular note to the princes declaring that, in the event of an evasive reply, Austria would move in the diet for the mobilization of the federal forces. On the 24th Bismarck in his turn issued a circular note stating that, in view of the Austrian war preparations, Prussia must take measures for her defence; at the same time he laid before the princes the outline of the Prussian scheme for the reform of the Confederation, a scheme which included a national parliament to be elected by universal suffrage, "as offering surer guarantees for conservative action than limitations that seek to determine the majority beforehand." Clearly Prussia meant war, and the Italian government thought it safe to sign, on the 8th of April 1866,

a treaty of alliance. By this instrument it was agreed that in the event of her proposals for the reform of the federal constitution being rejected by the German princes, Prussia should declare war "in order to give effect to her proposals," and that, in that case, Italy would also declare war against Austria. As a result of the war Venetia was to be added to Italy and an equivalent amount of territory in North Germany to Prussia. The agreement, however, was only to hold good if war broke out within three months.

On the day after the signature of the treaty the Prussian project of reform was presented to the federal diet. It was, however, no more than a bid for the support of public opinion on the part of Bismarck; for even while it was under discussion an angry correspondence was being carried on between Berlin and Vienna on the question of armaments, and by the beginning of May both powers were making undisguised preparations for war. On the 21st of April, the very day when the discussion of the Prussian proposals began in the diet, Austria, alarmed at a threatened attack by Garibaldi on Venetia, began to mobilize in defiance of an agreement just arrived at with Prussia. Five days later, in spite of this, she sent an ultimatum to Berlin, demanding the continuance of the Prussian disarmament and an immediate settlement of the Schleswig-Holstein question. The supreme issue was, however, delayed for a few weeks by the intervention of Napoleon, who, urged on by the loud alarm of the French people at the prospective aggrandizement of Prussia, attempted to detach Italy from the Prussian alliance by persuading Austria to a cession of Venetia. The negotiations broke down on the refusal of Italy to throw over her ally, and Napoleon's proposal of a European congress, to reconsider the whole settlement under the treaties of 1815, proved equally abortive. Meanwhile the preparations for war had been continued, and on the 1st of June Austria flung down the gage by declaring her intention of submitting the whole question of the duchies to the federal diet and of summoning a meeting of the Holstein estates. This was denounced by Bismarck in a circular note to the powers as a breach of the convention of Gastein and of the treaty of January 16, 1864, by which Austria and Prussia had agreed to govern the duchies in common. At the same time he handed in the formal protest of Prussia to the federal diet. Prussia, he said, would only recognize the right of a reformed federal power to settle the Schleswig-Holstein question, and this power must be based on a German parliament, which alone could guarantee Prussia that any sacrifices she might make would be for the good of Germany and not of the dynasties. The Prussian plan of reform laid before the diet included the exclusion of Austria from the Confederation; the creation of a federal navy; the division of the supreme command of the army between Prussia and Bavaria; a parliament elected by manhood suffrage; the regulation of the relations between the Confederation and Austria by a special treaty. In the event of the actual constitution of the *Bund* being shattered by war, the German states were asked whether they would be prepared to join this new organization. On the 9th of June Prussian troops had already marched into Holstein, the Austrians, with Duke Frederick, falling back on Altona. On the 14th the Prussian scheme of reform was laid before the diet, together with Austria's counter-proposal for a decree of federal execution against Prussia. In the event of the rejection of Prussia's motion, Bismarck had made it clear that Prussia would withdraw from the Confederation, and that in the event of her being victorious in the ensuing war those states of northern Germany that voted against her would cease to exist. In spite of this, the Austrian motion was carried by nine votes to six. The Prussian delegate at once withdrew from the diet, and on the following day (June 15) the Prussian troops advanced over the Saxon frontier.

The war that followed, conveniently called the Seven Weeks' War, (*q.v.*), culminated before a month had passed, on the 3rd of July, in the crushing Prussian victory of Königgrätz. The rapidity and overwhelming character of the Prussian success

Prusso-
Italian
alliance.

Prussian
scheme
for the
reform
of the
"Bund."

Hostile
attitude of
France.

End of the
Austro-
Prussian
under-
standing.

Prussia
withdraws
from the
"Bund."

ensured the triumph of Bismarck's policy. The intervention which Napoleon had planned resolved itself into diplomatic *pourparlers* of which the result was wholly insignificant; and even before the war was ended Bismarck was preparing for an understanding with Austria and with the South German states that should minimize the risk of a French attack. By the preliminary treaty of peace signed at Nikolsburg on the 26th of July the great objects for which Prussia had fought were fully secured. By Article I. the integrity of the Austrian monarchy was preserved, with the exception of Lombardo-Venetia; by Article II. Austria consented to "a new organization of Germany without the participation of the empire of Austria," consented to "the closer union" to be founded by the king of Prussia to the north of the Main, and to the German states south of the Main entering into a union, the national relations of which with the North German Confederation were to be "the subject of an ulterior agreement between the two parties"; by Article III. Austria transferred all her rights in Schleswig and Holstein to Prussia, reserving the right of the people of north Schleswig to be again united to Denmark should they "express a desire to be so by a vote freely given"; by Article V. the territory of Saxony was to remain intact. These Articles, embodying the more important terms, were included with slight verbal alterations in the treaty of peace signed at Prague on the 23rd of August. Separate treaties of peace had been signed with Württemberg on the 13th, with Baden on the 17th and with Bavaria on the 22nd of August, treaties with Hesse-Darmstadt followed on the 3rd of September, with Saxe-Meiningen on the 8th of October and with Saxony on the 21st. The other unfortunate North German states which had sided with Austria were left to their fate, and on the 20th of September King William issued a decree annexing Hanover, Hesse-Cassel, Nassau and the free city of Frankfurt to the Prussian monarchy, and bringing them under the Prussian constitution.

Treaty of Prague, August 23.

Aggrandisement of Prussia.

The return of King William to his capital had been a triumphal progress; and Bismarck had shared to the full the new-born popularity of his master. He seized the occasion to make his peace with Liberal sentiment, and the bill of indemnity for past ministerial breaches of the constitution was carried in the new Prussian diet with enthusiasm. On the 24th of February 1867 the constituent diet of the confederation, elected by universal suffrage and the ballot, met in Berlin, and soon accepted in its essential features the constitution submitted to it. It was arranged that the headship of the confederation should be hereditary, that it should belong to the king of Prussia, and that legislative functions should be exercised by a federal council (*Bundesrat*), representative of the various governments, and by a diet (*Bundestag*) elected by the whole people.

Federal constitution.

The federal parliament began at once the task of consolidating the new institutions. In the sessions of 1869 and 1870 it established a supreme tribunal of commerce, sitting in Leipzig, and passed a new penal code. Great as were these results, they did not satisfy the aspirations of patriotic Germans, who, having so suddenly and so unexpectedly approached unity, longed that the work should be completed. A party called the National Liberals was formed, whose main object was to secure the union of South with North Germany, and it at once entered into peculiar relations with Bismarck, who, in spite of his native contempt for parliaments and parliamentary government, was quite prepared to make use of any instruments he found ready to his hand. There was, indeed, plentiful need for some show of concession to Liberal sentiment, if a union of hearts was to be established between the South and North Germans. The states south of the Main had issued from the war as sovereign and independent powers, and they seemed in no great haste to exchange this somewhat precarious dignity either for a closer alliance among each other or with the North German Confederation. The peoples, too, fully shared the dislike of their rulers to the idea of a closer union

National Liberals.

with North Germany. The democrats hated Prussia as "the land of the corporal's stick," and Bismarck as the very incarnation of her spirit. The Roman Catholics hated her as the land *par excellence* of Protestantism and free thought. Nothing but the most powerful common interests could have drawn the dissevered halves of Germany together. This sense of common interests it was Bismarck's study to create. An important step was taken in 1867 by the conclusion of a treaty with the southern states, by which it was agreed that all questions of customs should be decided by the federal council and the federal diet, and that, for the consideration of such questions, the southern states should send representatives to Berlin. In reality, however, the customs parliament (*Zollparlament*) was of little service beyond the limits of its special activity. In the election to the customs parliament in 1868, Württemberg did not return a single deputy who was favourable to the national cause; in Bavaria the anti-nationalists had a large majority; and even in Baden and Hesse-Darmstadt, where the opposition to Prussia was less severe, a powerful minority of the deputies had no liking for Bismarck and his ways. Thus the customs parliament was kept rigidly to the objects for which it was founded, greatly to the disappointment of patriots who had not doubted that it would become an effective instrument for the attainment of far larger purposes. Had the completion of unity depended wholly on internal causes, it certainly would not have been soon achieved, but other forces, not altogether unexpectedly, came to Bismarck's aid. France had been irritated by the enormous increase of Prussian power, and even before the treaty of Prague was signed the emperor Napoleon III. indicated a wish to be "compensated" with the left bank of the Rhine. This was a claim exactly calculated to play into Bismarck's hands. The communication of the French emperor's original proposals to the South German governments, whose traditional policy had been to depend on France to save them from the ambitions of the German great powers, was enough to throw them into the arms of Prussia. The treaties of peace between Prussia and the South German states were accompanied by secret treaties of offensive and defensive alliance, under which the supreme command in war was to be given to the Prussian king. A common war against a common enemy now appeared the surest means of welding the dissevered halves of Germany together, and for this war Bismarck steadily prepared. There were soon plentiful signs of where this enemy was to be sought. On the 14th of March 1867 Thiers in the French Chamber gave voice to the indignation of France at the bungling policy that had suffered the aggrandizement of Prussia. The reply of Bismarck was to publish (March 19) the secret treaties with the South German states. War was now only a question of time, and the study of Bismarck was to bring it on at the moment most favourable to Germany, and by a method that should throw upon France the appearance of being the aggressor. The European situation was highly favourable. France was hampered by the Roman question, which divided her own counsels while it embroiled her with Italy, the Luxemburg question, arising out of her continued demand for "compensation," had only served to isolate her still further in Europe. French patriotic feeling, suspicious, angry and alarmed, needed only a slight provocation to cause it to blaze up into an uncontrollable fever for war.

The provocation was supplied at the right moment by the candidature of the prince of Hohenzollern for the vacant crown of Spain. To bring the Peninsula under French influence had been for centuries the ambition of French statesmen, it was intolerable that it should fall to a "Prussian" prince and that France should be threatened by this new power not only from the east but from the south. High language was used at Paris, and the French ambassador, Count Benedetti, was instructed to demand from the king of Prussia the withdrawal of the Hohenzollern candidature. The demand was politely but firmly refused, and Bismarck, judging that the moment had come for applying the match to

with North Germany. The democrats hated Prussia as "the land of the corporal's stick," and Bismarck as the very incarnation of her spirit. The Roman Catholics hated her as the land *par excellence* of Protestantism and free thought. Nothing but the most powerful common interests could have drawn the dissevered halves of Germany together. This sense of common interests it was Bismarck's study to create. An important step was taken in 1867 by the conclusion of a treaty with the southern states, by which it was agreed that all questions of customs should be decided by the federal council and the federal diet, and that, for the consideration of such questions, the southern states should send representatives to Berlin. In reality, however, the customs parliament (*Zollparlament*) was of little service beyond the limits of its special activity. In the election to the customs parliament in 1868, Württemberg did not return a single deputy who was favourable to the national cause; in Bavaria the anti-nationalists had a large majority; and even in Baden and Hesse-Darmstadt, where the opposition to Prussia was less severe, a powerful minority of the deputies had no liking for Bismarck and his ways. Thus the customs parliament was kept rigidly to the objects for which it was founded, greatly to the disappointment of patriots who had not doubted that it would become an effective instrument for the attainment of far larger purposes. Had the completion of unity depended wholly on internal causes, it certainly would not have been soon achieved, but other forces, not altogether unexpectedly, came to Bismarck's aid. France had been irritated by the enormous increase of Prussian power, and even before the treaty of Prague was signed the emperor Napoleon III. indicated a wish to be "compensated" with the left bank of the Rhine. This was a claim exactly calculated to play into Bismarck's hands. The communication of the French emperor's original proposals to the South German governments, whose traditional policy had been to depend on France to save them from the ambitions of the German great powers, was enough to throw them into the arms of Prussia. The treaties of peace between Prussia and the South German states were accompanied by secret treaties of offensive and defensive alliance, under which the supreme command in war was to be given to the Prussian king. A common war against a common enemy now appeared the surest means of welding the dissevered halves of Germany together, and for this war Bismarck steadily prepared. There were soon plentiful signs of where this enemy was to be sought. On the 14th of March 1867 Thiers in the French Chamber gave voice to the indignation of France at the bungling policy that had suffered the aggrandizement of Prussia. The reply of Bismarck was to publish (March 19) the secret treaties with the South German states. War was now only a question of time, and the study of Bismarck was to bring it on at the moment most favourable to Germany, and by a method that should throw upon France the appearance of being the aggressor. The European situation was highly favourable. France was hampered by the Roman question, which divided her own counsels while it embroiled her with Italy, the Luxemburg question, arising out of her continued demand for "compensation," had only served to isolate her still further in Europe. French patriotic feeling, suspicious, angry and alarmed, needed only a slight provocation to cause it to blaze up into an uncontrollable fever for war.

The provocation was supplied at the right moment by the candidature of the prince of Hohenzollern for the vacant crown of Spain. To bring the Peninsula under French influence had been for centuries the ambition of French statesmen, it was intolerable that it should fall to a "Prussian" prince and that France should be threatened by this new power not only from the east but from the south. High language was used at Paris, and the French ambassador, Count Benedetti, was instructed to demand from the king of Prussia the withdrawal of the Hohenzollern candidature. The demand was politely but firmly refused, and Bismarck, judging that the moment had come for applying the match to

Customs parliament.

South German hostility to union.

Irritation of France.

The Hohenzollern candidature.

the powder magazine, published an "edited" version of the telegram from the king describing the episode, a version which "without the addition of a single word" turned the refusal into an insult. The "Ems telegram" made the continuance of peace impossible; on the 14th of July Napoleon III. signed the declaration of war; and on the 2nd of August the affair of Saarbrücken opened the struggle which was to cause the downfall of the French and the creation of the German empire (see FRANCO-GERMAN WAR). On the 18th of January 1871, ten days before the capitulation of Paris, William I., king of Prussia, was proclaimed German emperor in the great hall of the palace of Versailles, on the initiative of the king of Bavaria, the most powerful of the South German sovereigns, the traditional ally of France. The cession of Alsace and the greater part of Lorraine, wrested two centuries before by Louis XIV. from the Holy Empire, was the heaviest part of the price that France had to pay for peace (treaty of Frankfurt, May 10, 1871). (W. A. P.)

The foundation of the empire in 1871 begins a new era in the history of Germany. The rivalry of the dynasties to which for so long the interests of the nation had been sacrificed now ceased. By the treaties of Versailles the kingdoms of Bavaria and Württemberg, and the grand-duchy of Baden, as well as the southern provinces of the grand-duchy of Hesse, were added to the North German Confederation. Henceforward all the German states that had survived the struggle of 1866, with the exception of the empire of Austria, the grand-duchy of Luxemburg, and the principality of Liechtenstein, were incorporated in a permanent federal state under the leadership of Prussia. The revision in 1871 made no important alterations in the constitution of 1867. The states retained their autonomy except in those matters which were expressly transferred to the imperial authorities; the princes retained their sovereignty; the king of Prussia, though he now took the title of German emperor, was only *primus inter pares*; he was president of the confederation, but had no superiority over the other princes. None the less, from this time the acts of the state governments and parliaments have ceased to have more than a local importance; the history of the nation is centred in Berlin, in the Bundesrat or federal council, in which the interests of the individual states are represented, in the Reichstag, in which the feelings and wishes of the nation are expressed, and above all, in the Prussian government and imperial executive.

The new constitution has stood the test. The number of states of which the empire consists has remained unaltered;¹ occasional disputes have been settled harmoniously in a legal manner. The special rights reserved to Bavaria and Württemberg have not proved, as was feared, a danger to the stability of the empire. Much apprehension had been caused by the establishment of a permanent committee for foreign affairs in the Bundesrat, over which the Bavarian representative was to preside; but the clause remained a dead letter. There is no record that the committee ever met until July 1900, when it was summoned to consider the situation in China; and on that occasion it probably formed a useful support to the government, and helped to still apprehension lest a too adventurous policy should be pursued. Another clause determined that in a division in the Reichstag on any law which did not concern the whole empire, the representatives of those states which were not concerned should not vote. This, had it been retained, would have destroyed the coherence of the Reichstag as representative of the whole nation. It was repealed in 1873. The permission to maintain diplomatic missions has been equally harmless: most of the states have recalled all their diplomatic representatives; Saxony, Bavaria and Württemberg have maintained only those at Vienna, the Vatican and at St Peters-

¹ The only formal change is that the duchy of Lauenburg, which since 1865 had been governed by the king of Prussia as a separate principality (but without a vote in the Bundesrat), was in 1876 incorporated in the Prussian province of Schleswig-Holstein.

burg. Bavaria has even voluntarily adopted many imperial laws from which it was legally exempted; for instance, the laws of settlement.

If the states have been loyal to the empire, the imperial government has also respected the constitutional privileges of the states. The harmonious working of the constitution depends on the union of policy between the empire and Prussia, for it is the power of Prussia which gives strength to the empire. This was practically secured by the fact that the emperor, who is king of Prussia, appoints the chancellor, and the chancellor is generally president of the Prussian ministry as well as minister of foreign affairs—in his person the government of the two is identified. For twenty years the double office was held by Bismarck, who, supported as he was by the absolute confidence of the emperor, and also of the allied princes, held a position greater than that ever attained by any subject in modern Europe since the time of Richelieu. For ten months in 1873 he, indeed, resigned the office of minister-president to Roon, and in the same way Caprivi, during the years 1893-1894, held the chancellorship alone; but in neither case was the experiment successful, and Hohenlohe and Bülow adhered to the older plan. So important is the practical co-operation of the imperial administration and the Prussian government, that it has become customary to appoint to seats in the Prussian ministry the more important of the secretaries of state who administer imperial affairs under the chancellor. Delbrück, head of the imperial chancery, had held this position since 1868; in 1877 Bulow, secretary of state for foreign affairs, was appointed Prussian minister, and this has become the ordinary practice. One result of this is to diminish the control which the Prussian parliament is able to maintain over the Prussian ministry.

In the federal council Prussian policy nearly always prevails, for though Prussia has only seventeen votes out of fifty-eight, the smaller states of the North nearly always support her; practically she controls the vote of Waldeck and since 1885 those of Brunswick. A definite defeat of Prussia on an important question of policy must bring about a serious crisis; it is generally avoided because, as the meetings are secret, an arrangement or compromise can be made. Bismarck, knowing that nothing would more impede the consolidation of the empire than an outbreak of local patriotism, always so jealous of its rights, generally used his influence to avoid constitutional disputes, and discouraged the discussion of questions which would require an authoritative interpretation of the constitution. It was, however, opposition in the Bundesrat which obliged him to abandon his scheme for imperial railways, and when, in 1877, it was necessary to determine the seat of the new supreme court of justice, the proposal of the government that Berlin should be chosen was out-voted by thirty to twenty-eight in favour of Leipzig. On this occasion Bismarck accepted the decision, but when important interests were at stake he showed himself as ready to crush opposition as in the older days, as in the case of Hamburg and Bremen.

The great personal qualities of the reigning emperors and the widely extended family connexions of the house of Hohenzollern have enabled them to hold with ease their position as leaders among the ruling families. So far as is known, with one or two unimportant exceptions, the other princes loyally accepted their new position. It is only as regards the house of Brunswick that the older dynastic questions still have some political importance.

The other princes who were dispossessed in 1866 have all been reconciled to Prussia. The elector of Hesse and the duke of Nassau have formally relinquished their claims. *Hanover.* In 1883 the daughter of the duke of Augustenburg, the former claimant to the duchies of Schleswig and Holstein, married the heir to the Prussian throne, who became William II. On the other hand, the royal family of Hanover has never ceased to protest against the acts by which they were deprived of their dominions. King George to the end of his days, whether in Austria or in France, still regarded himself as in a state of war with Prussia. As he had used his large personal property to organize a regiment in order to regain his possessions, the Prussian

Franco-German War.

Proclamation of the German empire.

The new empire, 1871.

Prussia and the empire.

government had sequestrated that part of his income, amounting to some £50,000, over which they had control, and used it as secret service money chiefly for controlling the press; to this fund the name "Welfen-Fond" was commonly given. After 1870 the Hanoverian regiment was disbanded, but the sequestration continued. The death of the old king in 1878 made no difference, for his son in a letter to the king of Prussia announced that he assumed and maintained all his father's rights, and that he did not recognize the legal validity of the acts by which he was, as a matter of fact, prevented from enjoying them. His protest was supported by a considerable number of his former subjects, who formed a party in the Reichstag. The marriage of the duke of Cumberland (the title by which the king called himself till he could come into his possessions) with Princess Thyra of Denmark in the same year was made the occasion of a great demonstration, at which a deputation of the Hanoverian nobility assured the duke of their continued attachment to his house.

After Bismarck's retirement the emperor attempted to bring about a reconciliation with the duke and the Hanoverians. His attention had been drawn to the bad moral effect of the use to which the Welfen-Fond was applied, and on the duke of Cumberland writing him a letter, in which, while maintaining his claims to the throne of Hanover, he recognized the empire and undertook not to support any enterprise against the empire or Prussia, with the consent of the Prussian parliament the sequestration of his property was removed. The attitude of passive resistance is, however, still maintained, and has affected the position of the duchy of Brunswick.

In 1884 William, duke of Brunswick, died after a reign of fifty-four years. The younger son of the duke who fell at Quatre Bras, he had been called to the throne in 1831 to take the place of his elder brother Charles, who had been deposed. Duke Charles had died at Geneva in 1873, and as both brothers were childless the succession went to the duke of Cumberland as head of the younger branch of the house of Brunswick-Lüneburg. Duke William before his death had arranged that the government should be carried on by a council of regency so long as the heir was prevented from actually assuming the government; at the end of a year a regent was to be chosen from among the non-reigning German princes. He hoped in this way to save his duchy, the last remnant of the dominions of his house, from being annexed by Prussia. As soon as he died the town was occupied by the Prussian troops already stationed therein; the duke of Cumberland published a patent proclaiming his succession; the council of state, however, declared, in agreement with the Bundesrat, that the relations in which he stood to the kingdom of Prussia were inconsistent with the alliances on which the empire was based, and that therefore he could not assume the government. The claim of the duke of Cambridge as the only male heir of full age was referred to the Bundesrat, but the duke refused to bring it before that body, and after a year the Brunswick government elected as regent Prince Albert of Hohenzollern, to hold office so long as the true heir was prevented from entering on his rights. On the death of Prince Albert in September 1906, the Brunswick diet petitioned the Bundesrat to allow the youngest son of the duke of Cumberland to succeed to the duchy on renouncing his personal claims to the crown of Hanover. This was refused, and on the 28th of May 1907 Duke John Albert of Mecklenburg-Schwerin was elected regent by the diet. Under the regency of Prince Albert, Brunswick, which had hitherto steadily opposed all attempts to assimilate and subordinate its institutions to those of Prussia, though it retained formal independence, was brought into very close dependence upon Prussia, as is the case with all the other northern states. In them the armies are incorporated in the Prussian army; the railways are generally merged in the Prussian system; indirect taxation, post office, and nearly the whole of the judicial arrangements are imperial. None, however, has yet imitated the prince of Waldeck, who in 1867, at the wish of his own subjects, transferred the administration of his principality to Prussia. The local estates

still meet, and the principality still forms a separate administrative district, but it is managed by a director appointed by Prussia. The chief reason for this act was that the state could not meet the obligations laid upon it under the new system, and the responsibility for any deficit now rests with Prussia.

A curious difficulty, a relic of an older state of society, arose in the principality of Lippe, in consequence of the extinction of the elder ruling line and a dispute as to the succession (see LIFFE). Some political importance attached to the case, for it was not impossible that similar difficulties might occur elsewhere, and the open support given by the emperor to the prince of Schaumburg-Lippe, who had married his sister, caused apprehension of Prussian aggression.

A much more serious question of principle arose from the peculiar circumstances of Mecklenburg. The grand-duchies, which, though divided between two lines of the ducal house, had a common constitution, were the only state in Germany in which the parliament still took the form of a meeting of the estates—the nobility and the cities—and had not been altered by a written constitution. Repeated attempts of the grand-dukes to bring about a reform were stopped by the opposition of the Ritterschaft. Büfing, one of the Mecklenburg representatives in the Reichstag, therefore proposed to add to the imperial constitution a clause that in every state of the confederation there should be a parliamentary assembly. This was supported by all the Liberal party and carried repeatedly; of course it was rejected by the Bundesrat; for it would have established the principle that the constitution of each state could be revised by the imperial authorities, which would have completely destroyed their independence. It is noticeable that in 1894 when this motion was introduced it was lost; a striking instance of the decay of Liberalism.

The public political history of Germany naturally centres around the debates in the Reichstag, and also those in the Prussian parliament. In the Prussian parliament are discussed questions of education, local government, religion and direct taxation, and though of course it is only concerned with Prussian affairs, Prussia is so large a part of Germany that its decisions have a national importance. A very large number of the members of the Reichstag and of the Prussian parliament sit in both, and the parties in the two are nearly identical. In fact, the political parties in the Reichstag are generally directly descended from the older Prussian parties.

The first place belongs to the Conservatives, who for twenty years had been the support of the Prussian government. The party of the feudal aristocracy in North Germany, they were strongest in the agricultural districts east of the Elbe; predominantly Prussian in origin and in feeling, they had great influence at court and in the army, and desired to maintain the influence of the orthodox Lutheran Church. To them Bismarck had originally belonged, but the estrangement begun in 1866 constantly increased for the next ten years. A considerable number of the party had, however, seceded in 1867 and formed a new union, to which was given the name of the *Deutsche Reichspartei* (in the Prussian House they were called the *Frei Conservativen*). These did not include any prominent parliamentary leaders, but many of the most important ministers and officials, including Moltke and some of the great nobles. They were essentially a government party, and took no part in the attacks on Bismarck, which came from the more extreme Conservatives, the party of the *Kreuzzeitung*.

The events of 1866 had brought about a similar division among the Progressives. A large section, including the most important leaders, determined to support Bismarck in his national policy and to subordinate to this, though not to surrender, the struggle after constitutional development. Under the name of *National-Liberal-Partei* they became in numbers as in ability the strongest party both in Prussia and the empire. Essentially a German, not a Prussian party, they were joined by the Nationalists from the annexed provinces of Hanover and Hesse; in 1871 they were greatly

Duchy of Brunswick.

The Mecklenburg constitution.

Lippe.

Public affairs: political parties.

Conservatives.

National Liberals.

Waldeck.

strengthened by the addition of the National representatives from the southern states; out of fourteen representatives from Baden twelve belonged to them, seventeen out of eighteen Württemberger, and a large majority of the Bavarians. It was on their support that Bismarck depended in building up the institutions of the empire. The remainder of the Progressives, the *Fortschrittspartei*, maintained their protest against the military and monarchical elements in the state; they voted against the constitution in 1867 on the ground that it did not provide sufficient guarantees for popular liberty, and in 1871 against the treaty with Bavaria because it left too much independence to that state. Their influence was strongest in Berlin, and in the towns of East Prussia, they have always remained characteristically Prussian.

These great parties were spread over the whole of Germany, and represented the great divisions of political thought. To them must be added others which were more local, as the *Volks-partei* or People's party in Württemberg, which kept alive the extreme democratic principles of 1848, but was opposed to Socialism. They had been opposed to Prussian supremacy, and in 1870 for the time completely lost their influence, though they were to regain it in later years.

Of great importance was the new party of the Centre. Till the year 1863 there had been a small party of Catholics in the Prussian parliament who received the name of **The Centre.** *Centrum*, from the part of the chamber in which they sat. They had diminished during the years of conflict and disappeared in 1866. In December 1870 it was determined to found a new party which, while not avowedly Catholic, practically consisted entirely of Catholics. The programme required the support of a Christian-Conservative tendency; it was to defend positive and historical law against Liberalism, and the rights of the individual states against the central power. They were especially to maintain the Christian character of the schools. Fifty-four members of the Prussian parliament at once joined the new party, and in the elections for the Reichstag in 1871 they won sixty seats. Their strength lay in Westphalia and on the Rhine, in Bavaria and the Polish provinces of Prussia. The close connexion with the Poles, the principle of federalism which they maintained, the support given to them by the Bavarian "patriots," their protest against the "revolution from above" as represented equally by the annexation of Hanover and the abolition of the papal temporal power, threw them into strong opposition to the prevailing opinion, an opposition which received its expression when Hermann von Mallinrodt (1821-1874), the most respected of their parliamentary leaders, declared that "justice was not present at the birth of the empire." For this reason they were generally spoken of by the Nationalist parties as *Reichsfeindlich*.

This term may be more properly applied to those who still refuse to recognize the legality of the acts by which the empire was founded. Of these the most important were the so-called Guelphs (*Welfen*), described by themselves as the *Hannoversche Rechtspartei*, member of the old Hanoverian nobility who represented the rural districts of Hanover and still regarded the deposed King George V. and, after his death, the duke of Cumberland as their lawful sovereign. In the elections of 1898 they still returned nine members to the Reichstag, but in those of 1903 their representation had sunk to six, and in 1907 it had practically disappeared. A similar shrinkage has been displayed in the case of the protesting Alsace-Lorrainers, who returned only two deputies in 1907. A pleasant concession to Hanoverian feeling was made in 1899, when the emperor ordered that the Hanoverian regiments in the Prussian army should be allowed to assume the names and so continue the traditions of the Hanoverian army which was disbanded in 1866.

The government has also not succeeded in reconciling to the empire the alien races which have been incorporated in the kingdom of Prussia. From the Polish districts of **Polen.** West Prussia, Posen and Silesia a number of representatives have continued to be sent to Berlin to protest against their incorporation in the empire. Bismarck, influenced by the

older Prussian traditions, always adopted towards them an attitude of uncompromising opposition. The growth of the Polish population has caused much anxiety; supported by the Roman Catholic Church, the Polish language has advanced, especially in Silesia, and this is only part of the general tendency, so marked throughout central Europe, for the Slavs to gain ground upon the Teutons. The Prussian government has attempted to prevent this by special legislation and severe administrative measures. Thus in 1885 and 1886 large numbers of Austrian and Russian Poles who had settled in these provinces were expelled. Windthorst thereupon raised the question in the Reichstag, but the Prussian government refused to take any notice of the interpolation on the ground that there was no right in the constitution for the imperial authority to take cognizance of acts of the Prussian government. In the Prussian parliament Bismarck introduced a law taking out of the hands of the local authorities the whole administration of the schools and giving them to the central authority, so as to prevent instruction being given in Polish. A further law authorized the Prussian government to spend £5,000,000 in purchasing estates from Polish families and settling German colonists on the land. The commission, which was appointed for the purpose, during the next ten years bought land to the amount of about 200,000 acres and on it settled more than 2000 German peasants. This policy has not, however, produced the intended effect; for the Poles founded a society to protect their own interests, and have often managed to profit by the artificial value given to their property. It has merely caused great bitterness among the Polish peasants, and the effect on the population is also counteracted by the fact that the large proprietors in purely German districts continue to import Polish labourers to work on their estates.

In the general change of policy that followed after the retirement of Bismarck an attempt was made by the emperor to conciliate the Poles. Concessions were made to them in the matter of schools, and in 1891 a Pole, Florian von Stabilewski (1841-1906), who had taken a prominent part in the Kulturkampf, was accepted by the Prussian government as archbishop of Posen-Gnesen. A moderate party arose among the Poles which accepted their position as Prussian subjects, gave up all hopes of an immediate restoration of Polish independence, and limited their demands to that free exercise of the religion and language of their country which was enjoyed by the Poles in Austria. They supported government bills in the Reichstag, and won the commendation of the emperor. Unfortunately, for reasons which are not apparent, the Prussian government did not continue a course of conciliation; in 1901 administrative edicts still further limited the use of the Polish language; even religious instruction was to be given in German, and an old royal ordinance of 1817 was made the pretext for forbidding private instruction in Polish.

All these efforts have been in vain. The children in the schools became the martyrs of Polish nationality. Religious instruction continued to be given to them in German, and when they refused to answer questions which they did not understand, they were kept in and flogged. In 1906, as a protest, the school children to the number of 100,000 struck throughout Prussian Poland; and, as a result of a pastoral issued by the archbishop, Polish parents withdrew their children from religious instruction in the schools. The government responded by fining and imprisoning the parents. The efforts of the government were not confined to the forcible Germanization of the children. Polish newspapers were confiscated and their editors imprisoned, fines were imposed for holding Polish meetings, and peasants were forbidden to build houses on their own land. The country gentlemen could not have a garden party without the presence of a commissary of police.

The climax, however, was reached in 1907 when Prince Bülow, on the 26th of November, introduced into the Prussian parliament a bill to arm the German Colonization Committee in Posen with powers of compulsory expropriation. He pointed out that though the commission had acquired 815,000 acres of land and settled upon it some 100,000 German colonists, nearly 250,000

acres more had passed from German into Polish hands. He proposed, therefore, to set aside a credit of £17,500,000 for this purpose. On the 26th of February 1908 the discussion on this bill was continued, Count Arnim defending it on the ground that "conciliation had failed and other measures must now be tried!" The Poles were aiming at raising their standard of civilization and learning and thus gradually expelling the Germans, and this, together with the rapid growth of the Polish population, constituted a grave danger. These arguments were reinforced by an appeal of Prince Bülow to the traditions of Bismarck, and in spite of a strenuous and weighty opposition, the bill with certain modifications passed by 143 votes to 111 in the Upper House, and was accepted by the Lower House on the 13th of March. A bill forbidding the use of any language but German at public meetings, except by special permission of the police, had been laid before the Reichstag in 1907 by Prince Bülow at the same time as he had introduced the Expropriation Bill into the Prussian parliament. The bill, with certain drastic amendments limiting its scope, passed the House on the 8th of April by a majority of 200 to 179. This law gave increased freedom in the matter of the right of association and public meeting; but in the case of the Poles it was applied with such rigidity that, in order to evade it they held "mute" public meetings, resolutions being written up in Polish on a blackboard and passed by show of hands, without a word being said.¹

Compared with the Polish question, that of the Danes in North Schleswig is of minor importance; they number less than 150,000,

Danes. and there is not among them, as among the Poles, the constant encroachment along an extended line of frontier; there is also no religious question involved. These Danish subjects of Germany have elected one member to the Reichstag, whose duty is to demand that they should be handed over to Denmark. Up to the year 1878 they could appeal to the treaty of Prague; one clause in it determined that the inhabitants of selected districts should be allowed to vote whether they should be Danish or German. This was inserted merely to please Napoleon; after his fall there was no one to demand its execution. In 1878, when the Triple Alliance was concluded, Bismarck, in answer to the Guelphic demonstration at Copenhagen, arranged with Austria, the other party to the treaty of Prague, that the clause should lapse. Since then the Prussian government, by prohibiting the use of Danish in the schools and public offices, and by the expulsion from the country of the numerous Danish optants who had returned to Schleswig, has used the customary means for compelling all subjects of the king to become German in language and feeling.²

The attempt to reconcile the inhabitants of Alsace-Lorraine to their condition proved equally difficult. The provinces had been placed under the immediate rule of the emperor and the chancellor, who was minister for them; laws were to be passed by the Reichstag. In accordance

Alsace-Lorraine. with the treaty of Frankfurt, the inhabitants were permitted to choose between French and German nationality, but all who chose the former had to leave the country; before the 1st of October 1872, the final day, some 50,000 had done so. In 1874, for the first time, the provinces were enabled to elect members for the Reichstag; they used the privilege to send fifteen *Elzasser*, who, after delivering a formal protest against the annexation, retired from the House; they joined no party, and took little part in the proceedings except on important occasions to vote against the government. The same spirit was shown in the elections for local purposes. It seemed to be the sign of a change when a new party, the *Autonomisten*, arose, who demanded as a practical concession that the dictatorship of the chancellor should cease and local self-government be granted. To some extent this was done in 1879; a resident governor or *Statthalter* was appointed, and a local representative assembly, which was consulted as to new laws. All the efforts of Field marshal

Edwin von Manteuffel, the first governor, to win the confidence of the people failed; the anti-German feeling increased; the party of protestors continued in full numbers. The next governor, Prince Hohenlohe, had to use more stringent measures, and in 1888, to prevent the agitation of French agents, an imperial decree forbade any one to cross the frontier without a passport. Since 1890 there has been, especially in the neighbourhood of Strassburg, evidence of a spread of national German feeling, probably to a great extent due to the settlement of Germans from across the Rhine.

The presence of these anti-German parties, amounting sometimes to one-tenth of the whole, in the Reichstag added greatly to the difficulty of parliamentary government. Gradually, however, as a new generation grew up their influence declined. In the Reichstag of 1907, Guelphs, Alsace-Lorrainers and Danes together could muster only five members.

The great work since 1870 has been that of building up the institutions of the empire. For the first time in the history of Germany there has been a strong administration ordering, directing and arranging the life of the whole nation. The unification of Germany was not ended by the events of 1866 and 1871; it was only begun. *The period 1870 to 1871.*

The work has throughout been done by Prussia; it has been the extension of Prussian principles and Prussian administrative energy over the whole of Germany. It naturally falls into two periods; the first, which ends in 1878, is that in which Bismarck depended on the support of the National Liberals. They were the party of union and uniformity. The Conservatives were attached to the older local diversities, and Bismarck had therefore to turn for help to his old enemies, and for some years an alliance was maintained, always precarious but full of results.

The great achievement of the first period was legal reform. In nothing else was legislation so much needed. Forty-six districts have been enumerated, each of which enjoyed a separate legal system, and the boundaries of these districts seldom coincided with the frontiers of the states. Everywhere the original source of law was the old German common law, but in each district it had been wholly or partly superseded by codes, text-books and statutes to a great extent founded on the principles of the Roman civil law. Owing to the political divisions, however, this legislation, which reached back to the 14th century, had always been carried out by local authorities. There had never been any effective legislation applicable to the whole nation. There was not a state, not the smallest principality, in which some authoritative but imperfect law or code had not been published. Every free city, even an imperial village, had its own "law," and these exist down to the present time. In Bremen the foundation of the civil code was still the statutes of 1433; in Munich, those of 1347. Most of the states by which these laws had been published had long ago ceased to exist; probably in every case their boundaries had changed, but the laws remained valid (except in those cases in which they had been expressly repealed) for the whole of the district for which they had been originally promulgated. Let us take a particular case. In 1501 a special code was published for the upper county of Katzellenbogen. More than a hundred years ago Katzellenbogen was divided between the neighbouring states. But till the end of the 19th century this code still retained its validity for those villages in Hesse, and in the Prussian province of Hesse, which in old days had been parts of Katzellenbogen. The law, however, had to be interpreted so as to take into consideration later legislation by the kingdom of Westphalia, the electorate of Hesse, and any other state (and they are several) in which for a short time some of these villages might have been incorporated.

In addition to these earlier imperfect laws, three great codes have been published, by which a complete system was applied to a large district: the Prussian Code of 1794, the Austrian Code of 1811 and the Code Napoléon, which applied to all Germany left of the Rhine; for neither Prussia, nor Bavaria, nor Hesse had ever ventured to interfere with the French law. In Prussia therefore the older provinces came under the Prussian

¹ See *Annual Register* (1908), pp. 289 et seq.

² The whole question is exhaustively treated from the Danish point of view in *La Question de Slesvig* (Copenhagen, 1906), a collective work edited by F. de Jessen.

Code, the Rhine provinces had French law, the newly annexed provinces had endless variety, and in part of Pomerania considerable elements of Swedish law still remained, a relic of the long Swedish occupation. On the other hand, some districts to which the Prussian Code applied no longer belonged to the kingdom of Prussia—for instance, Anspach and Bayreuth, which are now in Bavaria. In other parts of Bavaria in the same way Austrian law still ran, because they had been Austrian in 1811. In two states only was there a more or less uniform system: in Baden, which had adopted a German translation of the Code Napoléon; and in Saxony, which had its own code, published in 1865. In criminal law and procedure there was an equal variety. In one district was trial by jury in an open court; in another the old procedure by written pleadings before a judge. In many districts, especially in Mecklenburg and some of the Prussian provinces, the old feudal jurisdiction of the manorial courts survived.

The constant changes in the law made by current legislation in the different states really only added to the confusion, and though imperial laws on these points with which the central government was qualified to deal superseded the state laws, it is obvious that to pass occasional acts on isolated points would have been only to introduce a further element of complication. It was therefore convenient, so far as was possible, to allow the existing system to continue until a full and complete code dealing with the whole of one department of law could be agreed upon, and thus a uniform system (superseding all older legislation) be adopted. Legislation, therefore, has generally taken the form of a series of elaborate codes, each of which aims at scientific completeness, and further alterations have been made by amendments in the original code. The whole work has been similar in character to the codification of French law under Napoleon; in most matters the variety of the older system has ceased, and the law of the empire is now comprised in a limited number of codes.

A beginning had been made before the foundation of the empire; as early as 1861 a common code for trade, commerce and banking had been agreed upon by the states included in the Germanic Confederation. It was adopted by the new confederation of 1869. In 1877 it was replaced by a new code. In 1869 the criminal law had been codified for the North German Confederation, and in 1870 there was passed the *Gewerbeordnung*, an elaborate code for the regulation of manufactures and the relations of masters to workmen. These were included in the law of the empire, and the work was vigorously continued.

In 1871 a commission was appointed to draw up regulations for civil and criminal procedure, and also to frame regulations for the organization of the law courts. The draft code of civil procedure, which was published in December 1872, introduced many important reforms, especially by substituting public and verbal procedure for the older German system, under which the proceedings were almost entirely carried on by written documents. It was very well received. The drafts for the other two laws were not so successful. Protests, especially in South Germany, were raised against the criminal procedure, for it was proposed to abolish trial by jury and substitute over the whole empire the Prussian system, and a sharp conflict arose as to the method of dealing with the press. After being discussed in the Reichstag, all three projects were referred to a special commission, which after a year reported to the diet, having completely remodelled the two latter laws. After further amendment they were eventually accepted, and became law in 1877. By these and other supplementary laws a uniform system of law courts was established throughout the whole empire; the position and pay of the judges, the regulations regarding the position of advocates, and costs, were uniform, and the procedure in every state was identical. To complete the work a supreme court of appeal was established in Leipzig, which was competent to hear appeals not only from imperial law, but also from that of the individual states.

By the original constitution, the imperial authorities were only qualified to deal with criminal and commercial law; the

whole of the private law, in which the variety was greatest, was withdrawn from their cognizance. Lasker, to remedy this defect, proposed, therefore, an alteration in the constitution, which, after being twice carried against the opposition of the Centre, was at last accepted by the Bundesrat. A commission was then appointed to draw up a civil code. They completed the work by the end of 1887; the draft which they then published was severely criticized, and it was again submitted for revision to a fresh commission, which reported in 1895. In its amended form this draft was accepted by the Reichstag in 1896, and it entered into force on the 1st of January 1900. The new Civil Code deals with nearly all matters of law, but excludes those concerning or arising out of land tenure and all matters in which private law comes into connexion with public law; for instance, the position of government officials, and the police; it excludes also the relations of master and servant, which in most points are left to the control of individual states. It was accompanied by a revision of the laws for trade and banking.

Equal in importance to the legal was the commercial reform, for this was the condition for building up the material prosperity of the country. Germany was a poor country, but the poverty was to a great extent the result of political causes. Communication, trade, manufactures, were impeded by the political divisions, and though the establishment of a customs union had preceded the foundation of the empire, the removal of other barriers required imperial legislation. A common system of weights and measures was introduced in 1868. The reform of the currency was the first task of the empire. In 1871 Germany still had seven different systems; the most important was the *Thaler* and the *Groschen*, which prevailed over most of North Germany, but even within this there were considerable local differences. Throughout the whole of the south of Germany and in some North German states the *gulden* and *kreuzer* prevailed. Then there were other systems in Hamburg and in Bremen. Everywhere, except in Bremen, the currency was on a silver basis. In addition to this each state had its own paper money, and there were over 100 banks with the right of issuing bank-notes according to regulations which varied in each state. In 1871 a common system for the whole empire was established, the unit being the *Mark* (= 100 Pfennig), which was divided into a hundred *Pfennige*: a gold currency was introduced (*Doppel-Kronen* = 20 *M.*; *Kronen* = 10 *M.*); no more silver was to be coined, and silver was made a legal tender only up to the sum of twenty marks. The gold required for the introduction of the new coinage was provided from the indemnity paid by France. Great quantities of *thalers*, which hitherto had been the staple of the currency, were sold. The right of coinage was, however, left to the individual states, and as a special concession it was determined that the rulers of the states should be permitted to have their head placed on the reverse of the gold coins. All paper currency, except that issued by the empire, ceased, and in 1873 the Prussian Bank was converted into the Imperial Bank (*Reichsbank*).

Closely connected with the reform of the currency and the codification of the commercial law was the reform of the banking laws. Here the tendency to substitute uniform imperial laws for state laws is clearly seen. Before 1870 there had been over 100 banks with the right of issue, and the conditions on which the privilege was granted varied in each state. By the Bank Act of March 14, 1875, which is the foundation of the existing system, the right of granting the privilege is transferred from the governments of the states to the Bundesrat. The existing banks could not be deprived of the concessions they had received, but unless they submitted to the regulations of the new law their notes were not to be recognized outside the limits of the state by which the concession had been granted. All submitted to the conditions except the Brunswick Bank, which remained outside the banking system of the empire until the Bank Act of June 5, 1906, was passed, when it surrendered its right to issue notes. The experience of Germany in this matter has been different from that of England, for nearly all the private banks have now

Com-
mercial
reform.

Banking
laws.

surrendered their privilege, and there remain only five banks, including the Reichsbank, which still issue bank notes. The other four are situated in Bavaria, Saxony, Württemberg and Baden. The total note-issue was fixed by the law of 1875, a proposal being assigned to each bank. Any part of this issue assigned to private banks which might be withdrawn from circulation, owing to a deficiency in the legal reserve funds, was to be transferred to the Reichsbank. The result has been the tendency of the latter gradually to absorb the whole note-issue. By the law of 1906 the Reichsbank was authorized to issue 20 M. and 50 M. notes. Treasury notes (*Reichs-Kassenscheine*) for these amounts were no longer to be issued; but the state reserved the right to circulate notes of the value of 5 M. and 10 M.

The organization of the imperial post-office was carried out with great success by Herr von Stephan (*q.v.*), who remained at the head of this department from its creation till his death in 1897. Proposals were also made to Bavaria and Württemberg to surrender their special rights, but these were not accepted.

The unification of the railways caused greater difficulties. Nearly every state had its own system; there was the greatest

Railways. variety in the methods of working and in the tariffs, and the through traffic, so important for the commercial prosperity of the country, was very ineffective. In Baden, Württemberg and Hanover the railways were almost entirely the property of the state, but in all other parts public and private lines existed side by side, an arrangement which seemed to combine the disadvantages of both systems. In 1871 three-quarters of the railway lines belonged to private companies, and the existence of these powerful private corporations, while they were defended by many of the Liberals, was, according to the national type of thought, something of an anomaly. Bismarck always attached great importance to the improvement of the railway service, and he saw that uniformity of working and of tariffs was very desirable. In the constitution of the empire he had introduced several clauses dealing with it. The independent administration of its lines by each state was left, but the empire received the power of legislating on railway matters; it could build lines necessary for military purposes even against the wish of the state in whose territory they lay, and the states bound themselves to administer their lines as part of a common system. In order to carry out these clauses a law was passed on the 27th of June 1873—creating an imperial railway office (*Reichseisenbahnamt*) for the purpose of exercising a general control over the railways. This office has done much in the matter of unifying the systems of various railways and of regulating their relations to the military, postal and telegraph organizations; it also took a leading part in the framing of the international laws regarding goods traffic; but the imperial code of railway law which it drafted has never been laid before the Reichstag. It effectively controls only the privately owned lines in Prussia. Yet, in setting it up, Bismarck had in mind the ultimate acquisition of all the railways by the empire. He found, however, that it was impossible to carry any Bill enforcing this. He therefore determined to begin by transferring to the imperial authority the Prussian state railways; had he been able to carry this out the influence of the imperial railways would have been so great that they would gradually have absorbed those of the other states. The Bill was carried through the Prussian parliament, but the opposition aroused in the other states was so great that he did not venture even to introduce in the Bundesrat a law empowering the empire to acquire the Prussian railways. In many of the state parliaments resolutions were carried protesting against the system of imperial railways, and from that time the preservation of the local railway management has been the chief object towards which, in Saxony, Bavaria and Württemberg, local feeling has been directed. The only imperial railways are those in Alsace-Lorraine.

The result of the legal reform and other laws has been greatly to diminish the duties of the state governments, for every new imperial law permanently deprives the local parliaments of part of their authority. Generally there remains to them the control of education and religion—their most important duty—police,

all questions connected with land tenure, local government, the raising of direct taxes, and, in the larger states, the management of railways. The introduction of workmen's insurance, factory legislation, and other measures dealing with the condition of the working classes by imperial legislation, was at a later period still further to limit the scope of state legislation.

Meanwhile the government was busy perfecting the administration of the national defences. From the war indemnity large sums had been expended on coast defence, on fortifications and on replacing the equipment and stores destroyed during the war. A special fund, producing annually about a million pounds, was put aside, from which pensions to the wounded, and to the widows and orphans of those who had fallen, should be provided. It was also desirable to complete the military organization. It must be remembered that technically there is no German army, as there is no German minister of war. Each state, however small, maintains its own contingent, subject to its own prince, who has the right and the obligation of administering it according to the provisions of the treaty by which he entered the federation. Practically they are closely tied in every detail of military organization. The whole of the Prussian military system, including not only the obligation to military service, but the rules for recruiting, organization, drill and uniforms, has to be followed in all the states; all the contingents are under the command of the emperor, and the soldiers have to swear obedience to him in addition to the oath of allegiance to their own sovereign. It is therefore not surprising that, having so little freedom in the exercise of their command, all the princes and free cities (with the exception of the three kings) arranged separate treaties with the king of Prussia, transferring to him (except for certain formal rights) the administration of their contingents, which are thereby definitely incorporated in the Prussian army. The first of these treaties was arranged with Saxe-Coburg Gotha in 1861; those with the other North German states followed at short intervals after 1866. The last was that with Brunswick, which was arranged in 1885; Duke William had always refused to surrender the separate existence of his army. Owing to the local organization, this does not prevent the contingent of each state from preserving its separate identity; it is stationed in its own district, each state contributing so many regiments.

In 1872 a common system of military jurisprudence was introduced for the whole empire except Bavaria (a revised code of procedure in military courts was accepted by Bavaria in 1898); finally, in February 1874, an important law was laid before the Reichstag codifying the administrative rules. This superseded the complicated system of laws and royal ordinances which had accumulated in Prussia during the fifty years that had elapsed since the system of short service had been introduced; the application to other states of course made a clearer statement of the laws desirable. Most of this was accepted without opposition or debate. On one clause a serious constitutional conflict arose. In 1867 the peace establishment had been provisionally fixed by the constitution at 1% of the population, and a sum of 225 thalers (£33, 15s.) had been voted for each soldier. This arrangement had in 1871 been again continued to the end of 1874, and the peace establishment fixed at 401,650. The new law would have made this permanent. If this had been done the power of the Reichstag over the administration would have been seriously weakened; its assent would no longer have been required for either the number of the army or the money. The government attached great importance to the clause, but the Centre and the Liberal parties combined to throw it out. A disastrous struggle was averted by a compromise suggested by Bennigsen. The numbers were fixed for the next seven years (the so-called *Septennat*); this was accepted by the government, and carried against the votes of the Centre and some of the Progressives. On this occasion the Fortschrittspartei, already much diminished, split up into two sections. The principle then established has since been maintained; the periodical votes on the army have become the occasion for formally testing the strength of the Government.

in which he could no longer co-operate with Bismarck. The work of the office was then divided between several departments, at the head of each of which was placed a separate official, the most important receiving the title of secretary of state. Bismarck, as always, refused to appoint ministers directly responsible either to the emperor or to parliament; the new officials in no way formed a collegiate ministry or cabinet. He still retained in his own hands, as sole responsible minister, the ultimate control over the whole imperial administration. The more important secretaries of state, however, are political officials, who are practically almost solely responsible for their department; they sit in the Bundesrat, and defend their policy in the Reichstag, and they often have a seat in the Prussian ministry. Moreover, a law of 1878, the occasion of which was Bismarck's long absence from Berlin, empowered the chancellor to appoint a substitute or representative (*Stellvertreter*) either for the whole duties of his office or for the affairs of a particular department. The signature of a man who holds this position gives legal validity to the acts of the emperor.

This reorganization was a sign of the great increase of work which had already begun to fall on the imperial authorities, and was a necessary step towards the further duties which Bismarck intended to impose upon them.

Meanwhile the relations with the National Liberals reached a crisis. Bismarck remained in retirement at Varzin for nearly a year; before he returned to Berlin, at the end of 1877, he was visited by Bennigsen, and the Liberal leader was offered the post of vice-president of the Prussian ministry and vice-president of the Bundesrat. The negotiations broke down, apparently because Bennigsen refused to accept office unless he received a guarantee that the constitutional rights of the Reichstag should be respected, and unless two other members of the party, Forckenbeck and Stauffenberg, were given office. Bismarck would not assent to these conditions, and, even if he had been willing to do so, could hardly have overcome the prejudices of the emperor. On the other hand, Bennigsen refused to accept Bismarck's proposal for a state monopoly of tobacco. From the beginning the negotiations were indeed doomed to failure, for what Bismarck appears to have aimed at was to detach Bennigsen from the rest of his party and win his support for an anti-Liberal policy.

The session of 1878, therefore, opened with a feeling of great uncertainty. The Liberals were very suspicious of Bismarck's intentions. Proposals for new taxes, especially one on tobacco, were not carried. Bismarck took the opportunity of avowing that his ideal was a monopoly of tobacco, and this statement was followed by the resignation of Camphausen, minister of finance. It was apparent that there was no prospect of his being able to carry through the great financial reform which he contemplated. He was looking about for an opportunity of appealing to the country on some question which would enable him to free himself from the control of the Liberal majority. The popular expectations were expressed in the saying attributed to him, that he would "crush the Liberals against the wall." The opportunity was given by the Social Democrats.

The constant increase of the Social Democrats had for some years caused much uneasiness not only to the government, but also among the middle classes. The attacks on national feeling, the protest against the war of 1870, the sympathy expressed for the *Communards*, had offended the strongest feelings of the nation, especially as the language used was often very violent; the soldiers were spoken of as murderers, the generals as cut-throats. Attacks on religion, though not an essential part of the party programme, were common, and practically all avowed Social Democrats were hostile to Christianity. These qualities, combined with the open criticism of the institutions of marriage; of monarchy, and of all forms of private property, joined to the deliberate attempt to stir up class hatred, which was indeed an essential part of their policy, caused a widespread feeling that the Social Democrats were a serious menace to civilization. They were looked upon even by many Liberals as an enemy to be crushed;

much more was this the case with the government. Attempts had already been made to check the growth of the party. Charges of high treason were brought against some. In 1872 Bebel and Liebknecht were condemned to two years' imprisonment. In 1876 Bismarck proposed to introduce into the Criminal Code a clause making it an offence punishable with two years' imprisonment "to attack in print the family, property, universal military service, or other foundation of public order, in a manner which undermined morality, feeling for law, or the love of the Fatherland." The opposition of the Liberals prevented this from being carried. Lasker objected to these "elastic paragraphs," an expression for which in recent years there has been abundant use. The ordinary law was, however, sufficient greatly to harass the Socialists. In nearly every state there still existed, as survivals of the old days, laws forbidding the union of different political associations with one another, and all unions or associations of working men which followed political, socialistic or communistic ends. It was possible under these to procure decisions in courts of justice dissolving the General Union of Workers and the coalitions and unions of working men. The only result was, that the number of Socialists steadily increased. In 1874 they secured nine seats in the Reichstag, in 1877 twelve, and nearly 500,000 votes were given to Socialist candidates.

There was then no ground for surprise that, when in April 1878 an attempt was made on the life of the emperor, Bismarck used the excuse for again bringing in a law expressly directed against the Socialists. It was badly drawn up and badly defended. The National Liberals refused to vote for it, and it was easily defeated. The Reichstag was prorogued; six days later a man named Nobiling again shot at the emperor, and this time inflicted dangerous injuries. It is only fair to say that no real proof was brought that the Socialists had anything to do with either of these crimes, or that either of the men was really a member of the Socialist party; nevertheless, a storm of indignation rose against them. The government seized the opportunity. So great was the popular feeling, that a repressive measure would easily have been carried; Bismarck, however, while the excitement was at its height, dissolved the Reichstag, and in the elections which took place immediately, the Liberal parties, who had refused to vote for the first law, lost a considerable number of seats, and with them their control over the Reichstag.

The first use which Bismarck made of the new parliament was to deal with the Social Democrats. A new law was introduced forbidding the spread of Socialistic opinions by books, newspapers or public meetings, empowering the police to break up meetings and to suppress newspapers. The Bundesrat could proclaim a state of siege in any town or district, and when this was done any individual who was considered dangerous by the police could be expelled. The law was carried by a large majority, being opposed only by the Progressives and the Centre. It was applied with great severity. The whole organization of newspapers, societies and trades unions was at once broken up. Almost every political newspaper supported by the party was suppressed; almost all the pamphlets and books issued by them were forbidden; they were thereby at once deprived of the only legitimate means which they had for spreading their opinions. In the autumn of 1878 the minor state of siege was proclaimed in Berlin, although no disorders had taken place and no resistance had been attempted, and sixty-seven members of the party were excluded from the city. Most of them were married and had families; money was collected in order to help those who were suddenly deprived of their means of subsistence. Even this was soon forbidden by the police. At elections every kind of agitation, whether by meetings of the party or by distribution of literature, was suppressed. The only place in Germany where Socialists could still proclaim their opinions was in the Reichstag. Bismarck attempted to exclude them from it also. In this, however, he failed. Two members who had been expelled from Berlin appeared in the city for the meeting of the Reichstag at the end of 1878. The government at once asked permission that they should be charged with breaking the law.

Legislation against the Socialists.

Period after 1878.

Social democracy.

The constitution provided that no member of the House might be brought before a court of justice without the permission of the House, a most necessary safeguard. In this case the permission was almost unanimously refused. Nor did they assent to Bismarck's proposal that the Reichstag should assume power to exclude from the House members who were guilty of misusing the liberty of speech which they enjoyed there. Bismarck probably expected, and it is often said that he hoped, to drive the Socialists into some flagrant violation of the law, of such a kind that it would be possible for him completely to crush them. This did not happen. There were some members of the party who wished to turn to outrage and assassination. Most, a printer from Leipzig, who had been expelled from Berlin, went to London, where he founded the *Freiheit*, a weekly paper, in which he advocated a policy of violence. He was thereupon excluded from the party, and after the assassination of the emperor Alexander II. of Russia had to leave England for Chicago. A similar expulsion befell others who advocated union with the Anarchists. As a whole, however, the party remained firm in opposition to any action which would strengthen the hands of their opponents. They carried on the agitation as best they could, chiefly by distributing reports of speeches made in the Reichstag. A weekly paper, the *Social-Democrat*, was established at Zürich. Its introduction into Germany was of course forbidden, but it was soon found possible regularly to distribute thousands of copies every week in every part of the country, and it continued to exist till 1887 at Zürich, and till 1890 in London. In August of 1880 a congress of Socialists was held at the castle of Wyden, in Switzerland, at which about eighty members of the party met, discussed their policy, and separated before the police knew anything of it. Here it was determined that the members of the Reichstag, who were protected by their position, should henceforward be the managing committee of the party, and arrangements were made for contesting the elections of 1881. A similar meeting was held in 1883 at Copenhagen, and in 1887 at St Gallen, in Switzerland. Notwithstanding all the efforts of the government, though every kind of public agitation was forbidden, they succeeded in winning twelve seats in 1881. The law, which had obviously failed, was renewed in 1881; the state of siege was applied to Hamburg, Leipzig and Stettin, but all to no purpose; and though the law was twice more renewed, in 1886 and in 1888, the feeling began to grow that the Socialists were more dangerous under it than they had been before.

The elections of 1878, by weakening the Liberal parties, enabled Bismarck also to take in hand the great financial reform which he had long contemplated.

At the foundation of the North German Confederation it had been arranged that the imperial exchequer should receive the produce of all customs duties and also of excise. It depended chiefly on the taxes on salt, tobacco, brandy, beer and sugar. So far as the imperial expenses were not covered by these sources of revenue, until imperial taxes were introduced, the deficit had to be covered by "matricular" contributions paid by the individual states in proportion to their population. All attempts to introduce fresh imperial taxes had failed. Direct taxation was opposed by the governments of the states, which did not desire to see the imperial authorities interfering in those sources of revenue over which they had hitherto had sole control; moreover, the whole organization for collecting direct taxes would have had to be created. At the same time, owing to the adoption of free trade, the income from customs was continually diminishing. The result was that the sum to be contributed by the individual states constantly increased, and the amount to be raised by direct taxation, including local rates, threatened to become greater than could conveniently be borne. Bismarck had always regarded this system with disapproval, but during the first four or five years he had left the care of the finances entirely to the special officials, and had always been thwarted in his occasional attempts to introduce a change. His most cherished project was a large increase in the tax on tobacco, which at this time paid, for home-grown tobacco, the nominal duty of four marks per hundred

kilo. (about a farthing a pound), and on imported tobacco twenty-four marks. Proposals to increase it had been made in 1869 and in 1878, and on the latter occasion Bismarck for the first time publicly announced his desire for a state monopoly, a project which he never gave up, but for which he never was able to win any support. Now, however, he was able to take up the work. At his invitation a conference of the finance ministers met in July at Heidelberg; they agreed to a great increase in the indirect taxes, but refused to accept the monopoly on tobacco. At the beginning of the autumn session a union of 204 members of the Reichstag was formed for the discussion of economic questions, and they accepted Bismarck's reforms. In December he was therefore able to issue a memorandum explaining his policy; it included a moderate duty, about 5%, on all imported goods, with the exception of raw material required for German manufactures (this was a return to the old Prussian principle); high finance duties on tobacco, beer, brandy and petroleum; and protective duties on iron, corn, cattle, wood, wine and sugar. The whole of the session of 1879 was occupied with the great struggle between Free Trade and Protection, and it ended with a decisive victory for the latter. On the one side *Protection* were the seaports, the chambers of commerce, and the city of Berlin, the town council of which made itself the centre of the opposition. The victory was secured by a coalition between the agricultural interests and the manufacturers; the latter promised to vote for duties on corn if the landlords would support the duties on iron. In the decisive vote the duty on iron was carried by 218 to 88, on corn by 226 to 109. The principle of protection was thus definitely adopted, though considerable alterations have been made from time to time in the tariff. The result was that the income from customs and excise rose from about 230 million marks in 1878-1879 to about 700 millions in 1898-1899, and Bismarck's object in removing a great burden from the states was attained.

The natural course when the new source of income had been obtained would have been simply to relieve the states of part or all of their contribution. This, however, was not done. The Reichstag raised difficulties on the constitutional question. The Liberals feared that if the government received so large a permanent source of revenue it would be independent of parliament; the Centre, that if the contributions of the states to the imperial exchequer ceased, the central government would be completely independent of the states. Bismarck had to come to an agreement with one party or the other; he chose the Centre, probably for the reason that the National Liberals were themselves divided on the policy to be pursued, and therefore their support would be uncertain; and he accepted an amendment, the celebrated *Franckenstein Clause*, proposed by Georg Arbogast Freiherr von Franckenstein (1825-1890), one of the leaders of the Centre, by which all proceeds of customs and the tax on tobacco above 130 million marks should be paid over to the individual states in proportion to their population. Each year a large sum would be paid to the states from the imperial treasury, and another sum as before paid back to meet the deficit in the form of state contributions. From 1871 to 1879 the contribution of the states had varied from 94 to 67 million marks; under the new system the surplus of the contributions made by the states over the grant by the imperial treasury was soon reduced to a very small sum, and in 1884-1885 the payments of the empire to the states exceeded the contributions of the states to the empire by 20 million marks, and this excess continued for many years; so that there was, as it were, an actual grant in relief of direct taxation. In Prussia, by the *Lex Huene*, from 1885 to 1895, all that sum paid to Prussia, so far as it exceeded 15 million marks, was handed over to the local authorities in relief of rates. The increased expenditure on the navy after 1897 again caused the contributions required from the states to exceed the grants to them from the imperial exchequer. In 1903 Baron von Stengel, who succeeded Baron von Thielmann as finance minister in this year, proposed that the matricular contributions of the several states, instead of varying as heretofore with the exigencies of the annual budget,

State
contrib-
utions.

Financial
reform.

should be fixed by law. This plan, originally suggested by Dr von Miquel, was adopted by the Reichstag in May 1904. The deficits in the imperial budget, however, continued. In 1909 the whole system of German imperial finance was once more in the melting-pot, and, in spite of the undoubted wealth of the country, the conflict of state and party interests seemed to make it practically impossible to remould it on a satisfactory basis.

The acceptance by Bismarck of the principle of Protection and his alliance with the Catholic Centre were followed by the disruption of the National Liberal party and a complete change in the parliamentary situation. Already the

Party changes.

Liberal ministers, Falk and Hohrecht, had resigned, as well as Max von Forckenbeck the president, and Stauffenberg the vice-president of the Reichstag; in their place there were chosen a Conservative, and the Catholic Baron von Franckenstein. The whole party had voted against the Franckenstein Clause, but a few days later fifteen of the right wing left the party and transferred their support to the government. For another year the remainder kept together, but there was no longer any real harmony or co-operation; in 1880 nineteen, including most of the ablest leaders, Lasker, Forckenbeck, Bamberger and Bunsen, left the party altogether. The avowed cause of difference was commercial policy; they were the Free Traders, but they also justly foresaw that the reaction would extend to other matters. They took the name of the *Liberaler Vereinigung*, but were generally known as the *Secessionisten*; they hoped to become the nucleus of a united Liberal party in which all sections should join together on the principles of Free Trade and constitutional development. At the elections of 1881 they secured forty-seven seats, but they were not strong enough to maintain themselves, and with great reluctance in 1884 formed a coalition with the Progressives (*Freisinnigen*), who had gained greatly in strength owing to the breach among the government parties. They did so reluctantly, because they would thereby condemn themselves to assume that attitude of purely negative criticism which, during the great days of their prosperity, they had looked down upon with contempt, and were putting themselves under the leadership of Eugen Richter, whom they had long opposed. The new party, the *Deutschfreisinnige*,

Secessionists.

had no success; at the election of 1884 they secured only sixty-seven seats, a loss of thirty-nine; they were subjected to all inconveniences which belonged to opposition; socially, they were boycotted by all who were connected with the court or government; they were cut off from all hope of public activity, and were subjected to constant accusations for *Bismarck Beleidigung*. Their only hope was in the time when the crown prince, who had shown great sympathy with them, should succeed. They were popularly known as the crown prince's party. Lasker soon died; others, such as Forckenbeck and Bunsen, retired from public life, unable to maintain their position at a time when the struggle of class interests had superseded the old conflicts of principle. At the election of 1887 they lost more than half their seats, and in 1893 the party again broke up.

Prussian-ists.

The remainder of the National Liberals only won forty-five seats in 1881, and during the next three years they were without influence on the government; and even Bennigsen, unable to follow Bismarck in his new policy, disgusted at the proposals for biennial budgets and the misuse of government influence at the elections, retired from political life. In 1884 a new development took place: under the influence of Miquel a meeting was held at Heidelberg of the South German members of the party, who accepted the commercial and social policy of the government, including the Socialist law; their programme received Bismarck's approval, and was accepted by the rest of the party, so that they henceforward were taken into favour by the government; but they had won the position by sacrificing almost all the characteristics of the older Liberalism—the hope of a reunion for all the different sections which had hitherto kept the name of Liberal was at an end.

These events had a very unfortunate effect on the character of the parliament. From 1878 to 1887 there was no strong party

on which Bismarck could depend for support. After 1881 the parties of opposition were considerably strengthened. Alsatians and Poles, Guelphs, Clericals and Radicals were joined in a common hostility to the government. Parliamentary history took the form of a hostile criticism of the government proposals, which was particularly bitter because of the irreconcilable opposition of the Free Traders. Few of the proposals were carried in their entirety, many were completely lost; the tobacco monopoly and the brandy monopoly were contemptuously rejected by enormous majorities; even an increase of the tax on tobacco was refused; the first proposal for a subsidy to the Norddeutsche Lloyd were rejected. The personal relations of the chancellor to Parliament were never so bitter. At the same time, in Prussia there was a tendency to make more prominent the power of the king and to diminish the influence of the parliament. A proposal to introduce biennial budgets was for this reason regarded with great suspicion by the Opposition as a reactionary measure, and rejected. The old feelings of suspicion and jealousy were again aroused; the hostility which Bismarck encountered was scarcely less than in the old days of the conflict. After the elections of 1881 a protest was raised against the systematic influence exercised by Prussian officials. Puttkammer, who had now become minister of the interior, defended the practice, and a royal edict of 4th January 1882 affirmed the monarchial character of the Prussian constitution, the right of the king personally to direct the policy of the state, and required those officials who held appointments of a political nature to defend the policy of the government, even at elections.

One result of the new policy was a reconciliation with the Centre. Now that Bismarck could no longer depend on the support of the Liberals, it would be impossible to carry on the government if the Catholics maintained their policy of opposition to all government measures. They had supported him in his commercial reform

End of the Kulturkampf.

of 1878, but by opposing the Septennate in 1880 they had shown that he could not depend upon them. It was impossible to continue to treat as enemies of the state a party which had supplied one of the vice-presidents to the Reichstag, and which after the election of 1881 outnumbered by forty votes any other single party. Moreover, the government, which was now very seriously alarmed at the influence of the Social Democrats, was anxious to avail itself of every influence which might be used against them. In the struggle to regain the adherence of the working men it seemed as though religion would be the most valuable ally, and it was impossible to ignore the fact that the Roman Catholic priests had alone been able to form an organization in which hundreds of thousands of working men had been enlisted. It was therefore for every reason desirable to remedy a state of things by which so many parishes were left without incumbents, a condition the result of which must be either to diminish the hold of Christianity over the people, or to confirm in them the belief that the government was the real enemy of Christianity. It was not easy to execute this change of front with dignity, and impossible to do so without forsaking the principles on which they had hitherto acted. Ten years were to pass before the work was completed. But the cause of the conflict had been rather in the opinions of the Liberals than in the personal desire of Bismarck himself. The larger political reasons which had brought about the conflict were also no longer valid; the fears to which the Vatican decrees had given rise had not been fulfilled; the failure of the Carlists in Spain and of the Legitimists in France, the consolidation of the new kingdom in Italy, and the alliance with Austria had dispelled the fear of a Catholic league. The growth of the Catholic democracy in Germany was a much more serious danger, and it proved to be easier to come to terms with the pope than with the parliamentary Opposition. It would clearly be impossible to come to any agreement on the principles. Bismarck hoped, indeed, putting all questions of principle aside, to establish a *modus vivendi*; but even this was difficult to attain. An opportunity was given by the death of the pope in 1878. Leo XIII. notified his accession to the Prussian government in

a courteous despatch; the interchange of letters was followed by a confidential discussion between Bismarck and Cardinal Franchi at Kissingen during the summer of 1878. The hope that this might bring about some agreement was frustrated by the sudden death of the cardinal, and his successor was more under the influence of the Jesuits and the more extreme party. Bismarck, however, was not discouraged.

The resignation of Falk in July 1879 was a sign of the change of policy; he was succeeded by Puttkammer, who belonged to the old-fashioned Prussian Conservatives and had no sympathy with the Liberal legislation. The way was further prepared by a lenient use of the penal laws. On the 24th of February 1880 the pope, in a letter to the ex-archbishop of Cologne, said he was willing to allow clerical appointments to be notified if the government withdrew the obnoxious laws. In 1880 a provisional Bill was submitted to parliament giving the crown discretionary power not to enforce the laws. It was opposed by the Liberals on the ground that it conceded too much, by the Clericals that it granted too little, but, though carried only in a mutilated form, it enabled the priests who had been ejected to appoint substitutes, and religious worship was restored in nearly a thousand parishes. In the elections of 1881 the Centre gained five more seats, and in 1883 a new law was introduced prolonging and extending that of 1881. Meanwhile a Prussian envoy had again been appointed at the Vatican; all but three of the vacant bishoprics were filled by agreement between the pope and the king, and the sequestrated revenues were restored. Finally, in 1886, a fresh law, besides other concessions, did away with the *Kultur Examen*, and exempted seminaries from state control. It also abolished the ecclesiastical court, which, in fact, had proved to be almost unworkable, for no priests would appeal to it. By this, the real *Kulturkampf*, the attempt of the state to control the intellect and faith of the clergy, ceased. A further law of 1887 permitted the return to Prussia of those orders which were occupied in charitable work.

As permanent results of the conflict there remain only the alteration in the Prussian constitution and the expulsion of the Jesuits; the Centre continued to demand the repeal of this, and to make it the price of their support of government measures; in 1897 the Bundesrat permitted the return of the Redemptorists, an allied order. With these exceptions absolute religious peace resulted; the Centre to a great extent succeeded to the position which the National Liberals formerly held; in Bavaria, in Baden, in Prussia they obtained a dominant position, and they became a government party.

Meanwhile Bismarck, who was not intimidated by the parliamentary opposition, irritating and embarrassing though it was, resolutely proceeded with his task of developing the material resources of the empire. In order to do so the better, he undertook, in addition to his other offices, that of Prussian minister of commerce. He was now able to carry out, at least partially, his railway schemes, for he could afford to ignore Liberal dislike to state railways, and if he was unable to make all the lines imperial, he could make most of them Prussian. The work was continued by his successors, and by the year 1896 there remained only about 2000 kilometres of private railways in Prussia; of these none except those in East Prussia belonged to companies of any great importance. More than this, Bismarck was able to obtain Prussian control of the neighbouring states; in 1886 the Brunswick railways were acquired by the Prussian government, and in 1895 the private lines in Thuringia. The imperial railways in Alsace-Lorraine are managed in close connexion with the Prussian system, and in 1895 an important step was taken towards extending Prussian influence in the south. A treaty was made between Prussia and Hesse by which the two states together bought up the Hesse-Ludwig railway (the most important private company remaining in Germany), and in addition to this agreed that they would form a special union for the joint administration of all the lines belonging to either state. What this means is that the Hessian lines are managed by the Prussian department, but Hesse has the right of appointing one director,

and the expenses and profits are divided between the two states in proportion to their population. Thus a nucleus and precedent has been formed similar to that by which the *Zollverein* was begun, and it was hoped that it might be possible to arrange similar agreements with other states, so that in this way a common management for all lines might be established. There is, however, strong opposition, especially in South Germany, and most of the states cling to the separate management of their own lines. Fearful that Prussia might obtain control over the private lines, they have imitated Prussian policy and acquired all railways for the state, and much of the old opposition to Prussia is revived in defence of the local railways.

A natural supplement to the nationalization of railways was the development of water communication. This is of great importance in Germany, as all the chief coal-fields and manufacturing districts—Silesia, Saxony, Westphalia and Alsace—are far removed from the sea. The most important works were the canal from Dortmund to the mouth of the Ems, and the Jähde canal from the Ems to the Elbe, which enables Westphalian coal to reach the sea, and so to compete better with English coal. In addition to this, however, a large number of smaller works were undertaken, such as the canalization of the Main from Frankfurt to the Rhine, and a new canal from the Elbe to Lübeck. The great ship canal from Kiel to the Elbe, which was begun in 1887 and completed in 1896, has perhaps even more importance for naval than for commercial purposes. The Rhine, so long the home of romance, has become one of the great arteries of traffic, and lines of railways on both sides have caused small villages to become large towns. The Prussian government also planned a great scheme by which the Westphalian coal-fields should be directly connected with the Rhine in one direction and the Elbe in the other by a canal which would join together Minden, Hanover and Magdeburg. This would give uninterrupted water communication from one end of the country to the other, for the Elbe, Oder and Vistula are all navigable rivers connected by canals. This project, which was a natural continuation of Bismarck's policy, was, however, rejected by the Prussian parliament in 1890. The opposition came from the Agrarians and extreme Conservatives, who feared that it would enable foreign corn to compete on better terms with German corn; they were also jealous of the attention paid by the government to commercial enterprise in which they were not immediately interested. The project was again laid by the government before the Prussian *Landtag* on the 14th of April 1901 and was again rejected. In 1904 it was once more introduced in the modified form of a proposal of a canal from the Rhine to Leine in Hanover, with a branch from Datteln to Ham, and also of a canal from Berlin to Stettin. This bill was passed in February 1905.

Equally important was the action of the government in developing foreign trade. The first step was the inclusion of Hamburg and Bremen in the *Zollverein*; this was necessary if German maritime enterprise was to become a national and not merely a local concern, for the two Hansa cities practically controlled the whole foreign trade and owned three-quarters of the shipping; but so long as they were excluded for the Customs Union their interests were more cosmopolitan than national. Both cities, but especially Hamburg, were very reluctant to give up their privileges and the commercial independence which they had enjoyed almost since their foundation. As a clause in the constitution determined that they should remain outside the Customs Union until they voluntarily offered to enter it, there was some difficulty in overcoming their opposition. Bismarck, with characteristic energy, proposed to take steps, by altering the position of the imperial customs stations, which would practically destroy the commerce of Hamburg, and some of his proposals which seemed contrary to the constitution aroused a very sharp resistance in the Bundesrat. It was, however, not necessary to go to extremities, for in 1881 the senate of Hamburg accepted an agreement which, after a keen struggle, was ratified by the citizens. By this Hamburg was to enter the *Zollverein*; a part of the

harbour was to remain a free port, and the empire contributed two million pounds towards rearranging and enlarging the harbour. A similar treaty was made with Bremen, the free port of that city being situated near the mouth of the Weser at Bremerhaven; and in 1888, the necessary works having been completed, the cities entered the Customs Union. They have had no reason to regret the change, for no part of the country profited so much by the great prosperity of the following years, notwithstanding the temporary check caused by the serious outbreak of cholera at Hamburg in 1892.

During the first years of the empire Bismarck had occasionally been asked to interest himself in colonial enterprise. He had refused, for he feared that foreign complications might ensue, and that the country might weaken itself by dissipation of energy. He was satisfied that the Germans should profit by the commercial liberty allowed in the British colonies. Many of the Germans were, however, not contented with this, and disputes regarding the rights of German settlers in Fiji caused some change of feeling. The acquisition of German colonies was really the logical and almost necessary sequel of a protective policy. For that reason it was always opposed by the extreme Liberal party.

The failure of the great Hamburg house of Godefroy in 1879 threatened to ruin the growing German industries in the South Seas, which it had helped to build up. Bismarck therefore consented to apply to the Reichstag for a state guarantee to a company which would take over its great plantations in Samoa. This was refused, chiefly owing to the influence of the Liberal party. Bismarck therefore, who took this rebuff much to heart, said he would have nothing more to do with the matter, and warned those interested in colonies that they must depend on self-help; he could do nothing for them. By the support of some of the great financial firms they succeeded in forming a company, which carried on the business and undertook fresh settlements on the islands to the north of New Guinea. This event led also to the foundation of a society, the *Deutscher Kolonial Verein*, under the presidency of the prince of Hohenlohe-Langenburg, to educate public opinion. Their immediate object was the acquisition of trading stations. The year 1884 brought a complete change. Within a few months Germany acquired extended possessions in several parts both of Africa and the South Seas. This was rendered possible owing to the good understanding which at that time existed between Germany and France. Bismarck therefore no longer feared, as he formerly had, to encounter the difficulties with Great Britain which would be the natural result of a policy of colonial expansion.

His conversion to the views of the colonial party was gradual, as was seen in his attitude to the proposed acquisition of German stations in South-West Africa. In Namaqualand and Damaraland, British influence, exercised from Cape Colony, had long been strong, but the British government had refused to annex the country even when asked so to do by the German missionaries who laboured among the natives. In 1882 F. A. Lüderitz, a Bremen tobacco merchant, approached Bismarck on the question of establishing a trading station on the coast at Angra Pequena. The chancellor, while not discouraging Lüderitz, acted with perfect fairness to Great Britain, and throughout 1883 that country might have acted had she known her mind. She did not, and in the summer of 1884 Bismarck decided no longer to await her pleasure, and the south-west coast of Africa from the frontier of the Portuguese possessions to the Orange river, with the exception of Walvis Bay, was taken under German protection. During the same year Dr Nachtigal was despatched to the west coast, and stealing a march on his British and French rivals he secured not only Togoland but Cameroon for the Germans. On the east coast Bismarck acted decisively without reference to British interests: A company, the *Gesellschaft für deutsche Kolonisation*, was founded early in 1884 by Dr Carl Peters, who with two companions went off to the east coast of Africa and succeeded in November of that year in negotiating treaties with various chiefs on the mainland who were alleged to be independent of Zanzibar.

In this region British opposition had to be considered, but in February 1885 a German protectorate over the territory acquired by Peters was proclaimed.

Similar events took place in the South Seas. The acquisition of Samoa, where German interests were most extensive, was prevented (for the time being) by the arrangement made in 1870 with Great Britain and the United States. But in 1884 and 1885 the German flag was hoisted on the north of New Guinea (to which the name Kaiser Wilhelmsland has been given), on several parts of the New Britain Archipelago (which afterwards became the Bismarck Archipelago), and on the Caroline Islands. The last acquisition was not kept. The Spanish government claimed the islands, and Bismarck, in order to avoid a struggle which would have been very disastrous to monarchical government in Spain, suggested that the pope should be asked to mediate. Leo XIII. accepted the offer, which was an agreeable reminiscence of the days when popes determined the limits of the Spanish colonial empire, all the more gratefully that it was made by a Protestant power. He decided in favour of Spain, Germany being granted certain rights in the islands. The loss of the islands was amply compensated for by the political advantages which Bismarck gained by this attention to the pope, and, after all, not many years elapsed before they became German.

Bismarck in his colonial policy had repeatedly explained that he did not propose to found provinces or take over for the government the responsibility for their administration; he intended to leave the responsibility for their material development to the merchants, and even to entrust to them the actual government. He avowedly wished to imitate the older form of British colonization by means of chartered companies, which had been recently revived in the North Borneo Company; the only responsibility of the imperial government was to be their protection from foreign aggression. In accordance with this policy, the territories were not actually incorporated in the empire (there would also have been constitutional difficulties in doing that), and they were officially known as Protectorates (*Schutzgebiete*), a word which thus acquired a new signification. In 1885 two new great companies were founded to undertake the government. The *Deutsch-Ost-Afrika Gesellschaft*, with a capital of £200,000, took over the territories acquired by Dr Peters, and for the South Seas the *Neu-Guinea Gesellschaft*, founded by an amalgamation of a number of firms in 1884, received a charter in 1885. It was not, however, possible to limit the imperial responsibility as Bismarck intended. In East Africa the great revolt of the Arabs in 1888 drove the company out of all their possessions, with the exception of the port of Dar-es-Salam. The company was not strong enough to defend itself; troops had to be sent out by the emperor under Captain Wissmann, who as imperial commissioner took over the government. This, which was at first a temporary arrangement, was afterwards made permanent.

The New Guinea Company had less formidable enemies to contend with, and with the exception of a period of three years between 1889 and 1892, they maintained a full responsibility for the administration of their territory till the year 1899, when an agreement was made and ratified in the Reichstag, by which the possession and administration was transferred to the empire in return for a subsidy of £20,000 a year, to be continued for ten years. The whole of the colonies have therefore now come under the direct administration of the empire. They were at first placed under the direction of a special department of the Foreign Office, and in 1890 a council of experts on colonial matters was instituted, while in 1907 a separate office for colonial affairs was created. In 1887 the two chief societies for supporting the colonial movement joined under the name of the *Deutsche Kolonialgesellschaft*. This society takes a great part in forming public opinion on colonial matters.

This new policy inevitably caused a rivalry of interests with other countries, and especially with Great Britain. In every spot at which the Germans acquired territory they found themselves in opposition to British interests. The settlement of Angra

Pequeña caused much ill-feeling in Cape Colony, which was, however, scarcely justified, for the Cape ministry was equally responsible with the British government for the dilatoriness which led to the loss of what is now German South-West Africa. In Togoland and Cameroon British traders had long been active, and the proclamation of British sovereignty was impending when the German flag was hoisted. The settlement in East Africa menaced the old-established British influence over Zanzibar, which was all the more serious because of the close connexion between Zanzibar and the rulers of the Persian Gulf; and Australia saw with much concern the German settlement in New Guinea, especially as a British Protectorate (which in the view of Australians should have included the whole of what Germany was allowed to take) had previously been established in the island. In Africa Britain and France proceeded to annex territory adjacent to the German acquisitions, and a period followed during which the boundaries of German, French and British possessions were determined by negotiation. The overthrow of Jules Ferry and the danger of war with France made a good understanding with Great Britain of more importance. Bismarck, by summoning a conference to Berlin (1884-1885) to discuss African questions, secured for Germany a European recognition which was very grateful to the colonial parties; and in 1888, by lending his support to the anti-slavery movement of Cardinal Lavigerie, he won the support of the Centre, who had hitherto opposed the colonial policy. Finally a general agreement for the demarcation of Africa was made in 1890 (see AFRICA, § 5). A similar agreement had been made in 1886 regarding the South Seas. It was made after Bismarck had retired from office, and he, as did the colonial party, severely criticized the details; for the surrender of Zanzibar and Witu cut short the hopes which had been formed of building up a great German empire controlling the whole of East Africa. Many of the colonial party went further, and criticized not only the details, but the principle. They were much offended by Caprivi's statement that no greater injury could be done to Germany than to give her the whole of Africa, and they refused to accept his contention that "the period of flag-boasting was over," and that the time had come for consolidating their possessions. It must, however, be recognized that a continuation of the ambitious policy of the last few years might easily have involved Germany in dangerous disputes.

It appeared a small compensation that Great Britain surrendered to Germany the island of Heligoland, which she had taken from the Danes in the Napoleonic wars. It was annexed to Prussia; the natives born before the year 1880 were exempted from military service, and till the year 1901 no additional import duties were to be imposed. It has been strongly fortified and made a naval station.

It was easy for the Opposition to criticize the colonial policy. They could point out that, with the exception of parts of South-West Africa, no territory had been acquired in which any large number of German emigrants could live and rear families. They went as a rule to the United States and South America, or to territories under the British flag. As markets for German products the colonies remained of small importance; in 1907 the whole value of the trade, import and export, between Germany and her colonies was less than £3,300,000, and the cost of administration, including the grant to the shipping companies, often exceeded the total trade. Many mistakes were made in the administration, and cases of misconduct by individual officials formed the text for attacks on the whole system. Generally, however, these criticisms were premature; it was surely wise, while the opportunity was still open, to take care that Germany, in the partition of the world among European races, should not alone go entirely without a share. The lack of colonial experience, and, often, the lack of sympathy with, or understanding of, the negro and other races over whom they had assumed a protectorate, were contributory causes in the slow development of Germany's African colonies. The unwillingness of the Reichstag to sanction the expenditure of any large sums on railways and other public works also

hindered the exploitation of the economic resources of very large areas. Yet at the close of the first twenty-five years' existence of the colonial empire it might be said that the initial difficulties had been overcome, and sufficient knowledge gained to ensure Germany a return fairly commensurate with the efforts she had put forth. The necessity to enlist the interests of the natives on the side of the government, if any progress was to be made in industry or trade, was a lesson slowly learned. After the Arab opposition had been crushed on the east coast of Africa, there still remained the native states to be dealt with, and few tribes voluntarily submitted to European control. There was a serious rising in 1905-1906, when thousands of lives were lost. In Togoland there were disturbances of a comparatively minor character; in the Cameroon hinterland campaigns were undertaken against the Fulu and Bornuese princes. It was, however, in South-West Africa that the Germans had their chief and most bitter experience in colonial warfare. Though "annexed" in 1884 it was not till ten years later, after protracted fighting, that the Hottentots of Namaqualand recognized Germany. After another decade of comparative peace war again broke out (1903) and spread from the Hottentots to the Herero. The Anglo-Boer War had then but recently ended, and in Germany generally, and especially in military circles, it had provoked much adverse criticism on the inability of the British to bring the contest to a speedier conclusion. To their surprise the Germans now found that, against an inferior foe operating in a more restricted area, they were unable to do as well as the British army had done. The story of the war is told elsewhere (see GERMAN SOUTH-WEST AFRICA); it lasted well into 1908 and the Germans were indebted to the Cape Mounted Police for material help in bringing it to an end. As it progressed the Germans adopted many of the methods employed by the British in their colonial wars, and they learned to appreciate more accurately the immensity of the task which Lord Kitchener accomplished in overcoming the guerrilla warfare in the Boer republics.

It was obviously little use acquiring colonies and creating manufactures if German foreign trade was to be in the hands of other nations. As early as 1881 the government had published a proposal for a subvention to German shipping; it was criticized with peculiar energy by Bamberger and the Free Traders; a Bill introduced in 1884 was abandoned, but in 1885 Bismarck succeeded in carrying a vote by which, for fifteen years, four million marks could annually be devoted to helping a line of mail steamers to the Pacific and Australia and a branch line in the Mediterranean. An agreement was made with the Norddeutsche Lloyd, one clause of which was that all the new steamers were to be built in Germany; in 1890 a further vote was passed for a line to Delagoa Bay and Zanzibar. This far from exhausts the external activity of the nation and the government: the establishment of studentships for the study of oriental languages enabled Germans to make their way in the Turkish and Persian empires, and to open up a fresh market for German goods; by the great excavations at Pergamum and Olympia Germany entered with great distinction on a field in which the way had been shown by France and Great Britain. The progress of technical studies and industrial enterprise enabled Germany to take a leading place in railway and shipbuilding, in the manufacture of military weapons, in chemical experiments, and in electrical work.

It was a part of the new policy not only to combat Social Democracy by repression, but to win the confidence of the working men by extending to them the direct protection of the state. Recent legislation, culminating in the *Gewerbeordnung* of 1860, had, in accordance with the principles of the Liberal Economists, or, as the Germans called it, the Manchester School, instituted freedom from state control in the relations between employers and workmen. The old gilda had been destroyed, compulsory apprenticeship had ceased; little protection, however, was given to the working men, and the restrictions on the employment of women and children were of little use, as there was no efficient system of factory inspection.

Germany and Great Britain.

Colonial wars. The Herero rising.

Enlarged industrial policy.

Heligoland.

Progress of German colonial expansion.

Social reforms.

It was difficult for the men by their own exertions to improve their condition, for the masters had full liberty of association, which the law refused to the workmen. Even before 1870 a protest was raised against this system among the Roman Catholics, who were chiefly concerned for the preservation of family life, which was threatened by the growth of the factory system and also by the teaching of the Social Democrats. Baron von Ketteler, archbishop of Mainz, had maintained that it was the duty of the state to secure working men work and provision during sickness and old age. The general interest of the Church in the social question was recognized by a congress of the bishops at Fulda. Ketteler's work was continued by Canon Moufang, and Catholics brought forward motions in the Reichstag demanding new factory legislation. The peculiar importance of the Catholic movement is that it alone was able to some extent to meet the Socialists on their own ground.

Christian socialism.

The Catholics formed societies which were joined by large numbers of workmen. Originated by Father Kolping on the Rhine, they soon spread over the whole of Catholic Germany. Herr von Schorlemer-Ast, a Catholic landed proprietor from Westphalia, formed similar associations among the peasants. The result of this has been that the Social Democrats have failed to conquer the Catholic as they have the Protestant districts. A similar movement began among the Protestants after the commercial crisis of 1873, which forms an epoch in German thought, since it was from that year that men first began to question the economic doctrines of Liberalism, and drew attention to the demoralization which seemed to arise from the freedom of speculation and the influence of the stock exchange—a movement which in later years led to some remarkable attempts to remedy the evil by legislation. A minister, Rudolph Todt, and Rudolph Meyer criticized the moral and economic doctrines of Liberalism; his writings led to the foundation of the *Christlich-Soziale Arbeiterverein*, which for a few years attained considerable notoriety under the leadership of Adolph Stöcker. The Protestant movement has not succeeded in attaining the same position as has the Catholic among the working men; but it received considerable support among the influential classes at court, and part of the programme was adopted by the Conservative party, which in 1876 demanded restriction of industrial liberty and legislation which would prevent the ruin of the independent artisans.

In a country where learned opinion has so much influence on public affairs it was of especial importance that several of the younger teachers separated themselves from the dominant Manchester School and asserted the duty of the state actively to promote the well-being of the working classes. At a congress held in Erfurt in 1873, Schmoller, Wagner, Brentano and others founded the *Verein für Sozial-Politik*, which by its publications has had much influence on German thought.

The peculiar social conditions brought it about that in many cases the Christian Social movement took the form of Anti-Semitism (*q.v.*). Nearly all the bankers and stock-brokers in Germany were Jews. Many of the leaders of the Liberal parties, *e.g.* Bamberger and Lasker, were of Jewish origin; the doctrines of Liberalism were supported by papers owned and edited by Jews; hence the wish to restore more fully the avowedly Christian character of the state, coinciding with the attack on the influence of finance, which owed so much to the Liberal economic doctrines, easily degenerated into attacks on the Jews. The leader in this was Stöcker. During the years 1879 to 1881 the anti-Semite agitation gained considerable importance in Berlin, Breslau and other Prussian cities, and it culminated in the elections of that year, leading in some cases to riots and acts of violence.

So long as the government was under the influence of the National Liberals, it was indifferent if not hostile to these movements. The Peasants' Union had actually been forbidden by the police; Bismarck himself was violently attacked for his reputed connexion with a great Jewish firm of bankers. He had, however, kept himself informed regarding these movements, chiefly by means of Hermann Wagener, an old editor of the

Kreuzzeitung, and in the year 1878 he felt himself free to return in this matter to his older opinions. The new policy suggested in that year was definitely announced at the opening of the session in the spring of 1881, and at the meeting of the new Reichstag in November 1881. It was explained in a speech from the throne, which, as the emperor could not be present, became an imperial message. This is generally spoken of as the beginning of a new era. The help of the Reichstag was asked for "healing social evils by means of legislation . . . based on the moral foundation of Christianity." Compulsory insurance, the creation of corporate unions among working men under the protection of the state, and the introduction of indirect taxes, were the chief elements in the reform.

The condition of parties was such that Bismarck could not hope to win a majority for his schemes, especially as he could not obtain the monopoly on tobacco on which he depended to cover the expense. The first reform was the restoration of the gilds, to which the Conservatives attached great importance. Since 1866 they continued to exist only as voluntary associations with no public duties; many had been dissolved, and this is said to have brought about bad results in the management of lodging-houses, the condition of apprentices, support during illness, and the maintenance of labour bureaux. It was supposed that, if they could be restored, the corporate spirit would prevent the working men from falling under the influence of the Socialists. The law of 1881, while it left membership voluntary, gave to them many duties of a semi-public nature, especially that of arbitration between masters and men. These were extended by a further law in 1884.

The really important element was the scheme for a great imperial system by which all working men and women should be provided for in case of sickness, accident or old age. Bismarck hoped by this to relieve the parishes of the burden of the poor-rate, which would be transferred to the empire; at the same time the power of the government would be greatly extended. The first proposal in March 1881 was for compulsory insurance against accidents. Every one employed on railways, mines and factories was to be insured in an imperial office; the premium was to be divided equally between masters, workmen and the state. It was bitterly opposed by the Liberals, especially by Bamberger; all essential features were altered by the Reichstag, and it was withdrawn by the government after it had passed the third reading.

Compulsory insurance.

In 1882 a fresh scheme was laid before the newly elected Reichstag dealing with insurance against accident and against sickness. The two parts were separated by the Reichstag; the second, which was the necessary prelude to the other, was passed in 1883. The law was based on an old Prussian principle; insurance was made compulsory, but the state, instead of doing the work itself, recognized the existing friendly and other societies; they were still to enjoy their corporate existence and separate administration, but they were placed under state control, and for this purpose an imperial insurance department was created in the office of the secretary of state for the interior. Uniform regulations were to be followed in all trades and districts; one-third of the premium was paid by the employer, two-thirds by the workmen.

The Accident Law of 1883 was rejected, for it still included the state contribution to which the Reichstag would not assent, and also contributions from the workmen. A new law, drafted according to their wishes, was passed in 1884. It applied only to those occupations, mines and factories, in which the use of machinery was common; it threw the whole burden of compensation on to the masters; but, on the other hand, for the first thirteen weeks after an accident the injured workman received compensation from the sick fund, so that the cost only fell on the masters in the more serious cases. The masters were compelled to insure themselves against the payments for which they might become liable, and for this purpose had to form trades associations, self-governing societies, which in each district included all the masters for each particular trade. The application of this law was subsequently extended to other trades.

It was not till 1889 that the greatest innovation, that of insurance against old age, was carried. The obligation to insure rested on all who were in receipt of wages of not more than two pounds a week. Half the premium, according to the wages received, was paid by the master. The pension began at the age of seventy, the amount varying by very complicated rules, but the state paid a fixed sum of two pounds ten shillings annually in addition to the pension. These measures worked well. They were regarded with satisfaction by masters and men alike. Alterations have been made in detail, and further alterations demanded, but the laws have established themselves in practice. The large amount of self-administration has prevented an undue increase of bureaucratic power. The co-operation of masters and men in the administration of the societies has a good effect on the relations of the classes.

Except in the matter of insurance, the total result, however, for the moment was small. The demands repeatedly made by the Centre and the Conservatives for effective factory legislation and prohibition of Sunday labour were not successful. Bismarck did not wish to lay heavier burdens on the capitalists, and it was not till a later period that they were carried out.

During all this period Bismarck's authority was so great, that in the conduct of foreign affairs he was freed from the criticism and opposition which so often hampered him in his internal policy, and he was able to establish that system of alliances on which for so many years the political system of Europe depended. The close union of the three empires which had existed since the meeting of the emperors in 1872 did not survive the outbreak of disturbances in the East. Bismarck had maintained an attitude of neutrality, but after the congress of Berlin he found himself placed between the alternatives of friendship with Austria or Russia. Movements of Russian troops on the western frontier threatened Austria, and the tsar, in a letter to the German emperor, stated that peace could only be maintained if Germany gave her support to Russia. Bismarck, now that the choice was forced upon him, determined in favour of Austria, and during a visit to Vienna in October, arranged with Count Andrassy an alliance by which in the event of either being attacked by Russia the other was to assist; if either was attacked by any power other than Russia, the other was to preserve benevolent neutrality unless the attacking power was helped by Russia. The effect of this was to protect Austria from attack by Russia, and Germany from the danger of a combined attack by France and Russia. Bismarck with some difficulty procured the consent of the emperor, who by arranging a meeting with the tsar had attempted to preserve the old friendship. From that time the alliance with Austria has continued. In 1883 it was joined by Italy, and was renewed in 1887, and in 1891 for six years, and if not then denounced, for twelve.

In 1882, after the retirement of Gorchakov, the relations with Russia again improved. In 1884 there was a meeting of the three emperors, and at the same time Bismarck came to a close understanding with France on colonial questions. The period of quiet did not last long. The disaster in Tongking brought about a change of ministry in France, and Bulgarian affairs again alienated Austria and Russia. Bismarck with great skill used the growing foreign complications as a means of freeing himself from parliamentary difficulties at the same time that he secured the position of Germany in Europe.

To meet the increase in the French army, and the open menaces in which the Russian press indulged, a further increase in the German army seemed desirable. The Septennate would expire in 1888. In the autumn of 1886 a proposal was laid before the Reichstag to increase the peace establishment for the next seven years to 468,409 men. The Reichstag would not assent to this, but the opposition parties offered to vote the required increase for three years. Bismarck refused to accept this compromise, and the Reichstag was dissolved. Under his influence the Conservatives and National Liberals formed a coalition or *Cartel* by which each agreed to support the candidates of the other. The elections caused

greater excitement than any which had taken place since 1870. The numbers who went to the poll were much larger, and all the opposition parties, except the Catholics, including even the Socialists, suffered severe loss. Bismarck, in order to win the support of the Centre, appealed directly to the pope, but Windthorst took the responsibility of refusing to obey the pope's request on a matter purely political. The National Liberals again became a government party, but their position was much changed. They were no longer, as in the old days, the leading factor. They had to take the second place. They were subordinate to the Conservatives. They could no longer impose their will upon the government. In the new parliament the government proposals were accepted by a majority of 223 to 48 (seven members of the Centre voted for it, the others abstained). The opposition consisted chiefly of Socialists and Radicals (*Freisinnigen*).

The fall of Boulanger removed the immediate danger from France, but for the rest of the year the relations with Russia caused serious apprehensions. Anti-German articles appeared in Russian newspapers. The growth of the Nationalist party in Russia led to measures injurious to German trade and German settlers in Russia. German vessels were forbidden to trade on the Niemen. The increase of the duties on iron injured German trade. Stringent measures were taken to stamp out German nationality in the Baltic provinces, similar to those used by the Germans against the Poles. Foreigners were forbidden to hold land in Russia. The German government retaliated by a decree of the Reichstag refusing to deal with Russian paper. Large accumulations of troops on the western frontier excited alarm in Germany and Austria. During a short visit paid by the emperor of Russia to Berlin in November Bismarck discovered that forged despatches misrepresenting the policy of Germany in the Eastern Question had been communicated to him. This did not seem to remove all danger, and in February 1888 the government introduced an amendment to the imperial Military Law extending the obligation for service from twelve to eighteen years. In this way it was possible to increase the war establishment, excluding the Landsturm, by about half a million men without adding to the burden in time of peace. Another law authorized a loan of £14,000,000 for military equipment. At the same time the text of the Triple Alliance was published. The two laws were adopted without opposition. Under the effect of one of Bismarck's speeches, the Military Bill was unanimously passed almost without debate.

It was probably at the meeting of 1884 that a secret treaty, the existence of which was not known for many years, was arranged between Germany and Russia. The full text has never been published, and the exact date is uncertain. Either state pledged itself to observe benevolent neutrality in case the other were attacked by a third power. Apparently the case of an attack by France on Germany, or by Austria on Russia, was expressly mentioned. The treaty lapsed in 1890, and owing to Bismarck's dismissal was not renewed. Caprivi refused to renew it because it was doubtful whether by increasing the number of treaties the value of them was not diminished. Under this system it was to be apprehended that if war broke out between Austria and Russia, Austria would claim the support of Germany under the Triple Alliance, Russia neutrality under this treaty. The decision of Germany would theoretically have to depend on the question which party was the aggressor—a question which notoriously is hardly ever capable of an answer. (For this treaty see the debate in the Reichstag of the 16th of November 1896; the *Hamburger Nachrichten* of 24th October in the same year; and Schulthess, *Europäisches Geschichtskalender*, 1896.)

The emperor William died on the 9th of March 1888. He was succeeded by his son, who took the title of Frederick III. In Italy the older title of king of Piedmont has been absorbed in the newer kingdom of Italy; this is not the case in Germany, where the title German emperor is merely attached to and not substituted for that of king of Prussia. The events of this short reign, which lasted

Foreign affairs: the Triple Alliance.

Relations with Russia.

Secret treaty with Russia.

Elections of 1887.

Reign of Frederick III.

only ninety-nine days, have chiefly a personal interest, and are narrated under the articles **FREDERICK III.** and **BISMARCK**. The illness and death of the emperor, however, destroyed the last hope of the Liberals that they might at length succeed to power. For a generation they had waited for his accession, and bitter was their disappointment, for it was known that his son was more inclined to follow the principles of Bismarck than those of his own father. The emperor, crippled and dying though he was, showed clearly how great a change he would, had he lived, have introduced in the spirit of the government. One of his first acts was severely to reprimand Puttkammer for misusing government influence at elections. The minister sent in his resignation, which was accepted, and this practice, which had been deliberately revived during the last ten years, was thereby publicly disavowed. Bismarck's own position would naturally have been seriously affected by the fall of a colleague with whom he was closely connected, and another point of internal policy showed also how numerous were the differences between the chancellor and the emperor. Laws had been passed prolonging the period of both the Prussian and Imperial parliaments from three to five years; when they were laid before the emperor for his signature he said that he must consider them. Bismarck then pointed out that the constitution of the empire did not authorize the emperor to withhold his assent from a law which had passed both the Reichstag and the Bundesrat; he could as king of Prussia oppose it by his representatives in the federal council, but when it had been accepted there, it was his duty as emperor to put the law into execution. The emperor accepted this exposition of the constitution, and after some delay eventually gave his consent also to the Prussian law, which he was qualified to reject.

He was succeeded by his eldest son, William II. (*q.v.*) The first year of the new reign was uneventful. In his public speeches the emperor repeatedly expressed his reverence for the memory of his grandfather, and his determination to continue his policy; but he also repudiated the attempt of the extreme Conservatives to identify him with their party. He spent much time on journeys, visiting the chief courts of Europe, and he seemed to desire to preserve close friendship with other nations, especially with Russia and Great Britain. Changes were made in the higher posts of the army and civil service, and Moltke resigned the office of chief of the staff, which for thirty years he had held with such great distinction.

The beginning of the year 1890 brought a decisive event. The period of the Reichstag elected in 1887 expired, and the new elections, the first for a quinquennial period, would take place. The chief matter for decision was the fate of the Socialist law; this expired on the 30th of September 1890. The government at the end of 1889 introduced a new law, which was altered in some minor matters, and which was to be permanent. The Conservatives were prepared to vote for it; the Radicals and Centre opposed it; the decision rested with the National Liberals, and they were willing to accept it on condition that the clause was omitted which allowed the state governments to exclude individuals from districts in which the state of siege had been proclaimed. The final division took place on the 25th of February 1890. An amendment had been carried omitting this clause, and the National Liberals therefore voted for the bill in its amended form. The Conservatives were ready to vote as the government wished; if Bismarck was content with the amended bill, they would vote for it, and it would be carried; no instructions were sent to the party; they therefore voted against the bill, and it was lost. The House was immediately dissolved. It was to have been expected that, as in 1878, the government would appeal to the country to return a Conservative majority willing to vote for a strong law against the Socialists. Instead of this, the emperor, who was much interested in social reform, published two proclamations. In one addressed to the chancellor he declared his intention, as emperor, of bettering the lot of the working classes; for this purpose he proposed to call an international congress to consider the possibility of meeting *the requirements and wishes of the working men; in the other,*

which he issued as king of Prussia, he declared that the regulation of the time and conditions of labour was the duty of the state, and the council of state was to be summoned to discuss this and kindred questions. Bismarck, who was less hopeful than the emperor, and did not approve of this policy, was thereby prevented from influencing the elections as he would have wished to do; the coalition parties, in consequence, suffered severe loss; Socialists, Centre and Radicals gained numerous seats. A few days after the election Bismarck was dismissed from office. The difference of opinion between him and the emperor was not confined to social reform; beyond this was the more serious question as to whether the chancellor or the emperor was to direct the course of the government. The emperor, who, as Bismarck said, intended to be his own chancellor, required Bismarck to draw up a decree reversing a cabinet order of Frederick William IV., which gave the Prussian minister-president the right of being the sole means of communication between the other ministers and the king. This Bismarck refused to do, and he was therefore ordered to send in his resignation.

Among those more immediately connected with the government his fall was accompanied by a feeling of relief which was not confined to the Opposition, for the burden of his *Chancellorship* rule had pressed heavily upon all. There was, however, no change in the principles of government or avowed *Course of Caprivi* change in policy; some uncertainty of direction and sudden oscillations of policy showed the presence of a less experienced hand. Bismarck's successor, General von Caprivi, held a similar combination of offices, but the chief control passed now into the hands of the emperor himself. He aspired by his own will to direct the policy of the state; he put aside the reserve which in modern times is generally observed even by absolute rulers, and by his public speeches and personal influence took a part in political controversy. He made very evident the monarchical character of the Prussian state, and gave to the office of emperor a prominence greater than it had hitherto had.

One result of this was that it became increasingly difficult in political discussions to avoid criticizing the words and actions of the emperor. Prosecutions for *lèse-majesté* became commoner than they were in former reigns, and the difficulty was much felt in the conduct of parliamentary debate. The rule adopted was that discussion was permitted on those speeches of the emperor which were officially published in the *Reichsanzeiger*. It was, indeed, not easy to combine that respect and reverence which the emperor required should be paid to him, with that open criticism of his words which seemed necessary (even for self-defence) when the monarch condescended to become the censor of the opinions and actions of large parties and classes among his subjects. The attempts to combine personal government with representative institutions was one of much interest; it was more successful than might have been anticipated, owing to the disorganization of political parties and the absence of great political leaders; in Germany, as elsewhere, the parliaments had not succeeded in maintaining public interest, and it is worth noting that even the attendance of members was very irregular. There was below the surface much discontent and subdued criticism of the exaggeration of the monarchical power, which the Germans called *Byzantinismus*; but after all the nation seemed to welcome the government of the emperor, as it did that of Bismarck. The uneasiness which was caused at first by the unwonted vigour of his utterances subsided, as it became apparent how strong was his influence for peace, and with how many-sided an activity he supported and encouraged every side of national life. Another result of the personal government by the emperor was that it was impossible, in dealing with recent history, to determine how far the ministers of state were really responsible for the measures which they defended, and how far they were the instruments and mouthpieces of the policy of the emperor.

The first efforts of the "New course," as the new administration was termed, showed some attempt to reconcile to the government those parties and persons whom Bismarck had kept in opposition. The continuation of social reform was to win over the allegiance of the working men to the person of the emperor.

an attempt was made to reconcile the Guelphs, and even the Poles were taken into favour; Windthorst was treated with marked distinction. The Radicals alone, owing to their ill-timed criticism on the private relations of the imperial family, and their continued opposition to the army, were excluded. The attempt, however, to unite and please all parties failed, as did the similar attempt in foreign policy. Naturally enough, it was social reform on which at first activity was concentrated, and the long-delayed factory legislation was now carried out. In 1887 and 1888 the Clerical and Conservative majority had carried through

Factory laws.

the Reichstag laws restricting the employment of women and children and prohibiting labour on Sundays. These were not accepted by the Bundesrat, but after the International Congress of 1890 an important amendment and addition to the *Gesetzordnung* was carried to this effect. It was of even greater importance that a full system of factory inspection was created. A further provision empowered the Bundesrat to fix the hours of labour in unhealthy trades; this was applied to the bakeries by an edict of 1895, but the great outcry which this caused prevented any further extension.

These acts were, however, accompanied by language of great decision against the Social Democrats, especially on the occasion of a great strike in Westphalia, when the emperor warned the men that for him every Social Democrat was an enemy to the empire and country. None the less, all attempts to win the working men from the doctrinaire Socialists failed. They continued to look on the whole machinery of government, emperor and army, church and police, as their natural enemies, and remained completely under the bondage of the abstract theories of the Socialists, just as much as fifty years ago the German bourgeois were controlled by the Liberal theories. It is strange to see how the national characteristics appeared in them. What began as a great revolutionary movement became a dogmatic and academic school of thought; it often almost seemed as though the orthodox interpretation of Marx's doctrine was of more importance than an improvement in the condition of the working men, and the discussions in the annual Socialist Congress resembled the arguments of theologians rather than the practical considerations of politicians. The party, however, prospered, and grew in strength beyond all anticipation. The repeal of the Socialist law was naturally welcome to them as a great personal triumph over Bismarck; in the elections of 1890 they won thirty-five, in 1893 forty-four, in 1898 fifty-six seats. Their influence was not confined to the artisans; among their open or secret adherents were to be found large numbers of government employes and clerks. In the autumn of 1890 they were able, for the first time, to hold in Germany a general meeting of delegates, which was continued annually. In the first meetings it appeared that there were strong opposing tendencies within the party which for the first time could be brought to public discussion. On the one side there was a small party, *die Jungen*, in Berlin, who attacked the parliamentary leaders on the ground that they had lent themselves to compromise and had not maintained the old *intransigent* spirit. In 1891, at Erfurt, Werner and his followers were expelled from the party; some of them drifted into anarchism, others disappeared. On the other hand, there was a large section, the leader of whom was Herr von Vollmar, who maintained that the social revolution would not come suddenly, as Bebel and the older leaders had taught, but that it would be a gradual evolution; they were willing to co-operate with the government in remedial measures by which, within the existing social order, the prosperity and freedom of the working classes might be advanced; their position was very strong, as Vollmar had succeeded in extending Socialism even in the Catholic parts of Bavaria. An attempt to treat them as not genuine Socialists was frustrated, and they continued in co-operation with the other branch of the party. Their position would have been easier were it not for the repeated attempts of the Prussian government to crush the party by fresh legislation and the supervision exercised by the police. It was a sign of most serious import for the future that in 1897 the electoral law in the kingdom of Saxony was altered with the

express purpose of excluding the Socialists from the Saxon Landtag. This and other symptoms caused serious apprehension that some attempt might be made to alter the law of universal suffrage for the Reichstag, and it was policy of this kind which maintained and justified the profound distrust of the governing classes and the class hatred on which Social democracy depends. On the other hand, there were signs of a greater willingness among the Socialists to co-operate with their old enemies the Liberals.

In foreign affairs a good understanding with Great Britain was maintained, but the emperor failed at that time to preserve the friendship of Russia. The close understanding between France and Russia, and the constant increase in the armies of these states, made a still further increase of the German army desirable. In 1890, while the Septennate had still three more years to run, Caprivi had to ask for an additional 20,000 men. It was the first time that an increase of this kind had been necessary within the regular period. When, in 1893, the proposals for the new period were made, they formed a great change. Compulsory service was to be made a reality; no one except those absolutely unfit was to escape it. To make enlistment of so large an additional number of recruits possible, the period of service with the colours was reduced to two years. The parliamentary discussion was very confused; the government eventually accepted an amendment giving them 557,003 for five and a half years instead of the 570,877 asked for; this was rejected by 210 to 162, the greater part of the Centre and of the Radicals voting against it. Parliament was at once dissolved. Before the elections the Radical party broke up, as about twenty of them determined to accept the compromise. They took the name of the *Freisinnige Vereinigung*, the others who remained under the leadership of Richter forming the *Freisinnige Volkspartei*. The natural result of this split was a great loss to the party. The Liberal opposition secured only twenty-three seats instead of the sixty-seven they had held before. It was, so far as now can be foreseen, the final collapse of the old Radical party. Notwithstanding this the bill was only carried by sixteen votes, and it would have been thrown out again had not the Poles for the first time voted for the government, since the whole of the Centre voted in opposition.

This vote was a sign of the increasing disorganization of parties and of growing parliamentary difficulties which were even more apparent in the Prussian Landtag. Miquel, as minister of finance, succeeded indeed in carrying a reform by which the proceeds of the tax on land and buildings were transferred to the local government authorities, and the loss to the state exchequer made up by increased taxation of larger incomes and industry. The series of measures which began in 1891, and were completed in 1895, won a more general approbation than is usual, and Miquel in this successfully carried out his policy of reconciling the growing jealousies arising from class interests.

Caprivi's administration was further remarkable for the arrangement of commercial treaties. In 1892 treaties with Austria-Hungary, Italy, Belgium and Switzerland for twelve years bound together the greater part of the continent, and opened a wide market for German manufactures; the idea of this policy was to secure, by a more permanent union of the middle European states, a stable market for the goods which were being excluded owing to the great growth of Protection in France, Russia and America. These were followed by similar treaties with Rumania and Servia, and in 1894, after a period of sharp customs warfare, with Russia. In all these treaties the general principle was a reduction of the import duties on corn in return for advantages given to German manufactures, and it is this which brought about the struggle of the government with the Agrarians which after 1894 took the first place in party politics.

The agricultural interests in Germany had during the middle of the 19th century been in favour of Free Trade. The reason of this was that, till some years after the foundation of the empire, the production of corn and food-stuffs was more than sufficient for the population; as long as they exported corn, potatoes and cattle, they required no protection

Military legislation.

Commercial treaties.

Agrarians.

from foreign competition, and they enjoyed the advantages of being able to purchase colonial goods and manufactured articles cheaply. Mecklenburg and Hanover, the purely agricultural states, had until their entrance into the Customs Union, followed a completely Free Trade policy. The first union of the Agrarian party, which was formed in 1876 under the name of the Society for the Reform of Taxation, did not place protection on their programme; they laid stress on bimetalism, on the reform of internal taxation, especially of the tax on land and buildings, and on the reform of the railway tariff, and demanded an increase in the stamp duties. These last three points were all to some extent attained. About this time, however, the introduction of cheap corn from Russia began to threaten them, and it was in 1879 that, probably to a great extent influenced by Bismarck, they are first to be found among those who ask for protection.

After that time there was a great increase in the importation of food-stuffs from America. The increase of manufactures and the rapid growth of the population made the introduction of cheap food from abroad a necessity. In the youth of the empire the amount of corn grown in Germany was sufficient for the needs of its inhabitants; the amount consumed in 1899 exceeded the amount produced by about one-quarter of the total. At the same time the price, making allowance for the fluctuations owing to bad harvests, steadily decreased, notwithstanding the duty on corn. In twenty years the average price fell from about 235 to 135 marks the 1000 kilo. There was therefore a constant decrease in the income from land, and this took place at a time when the great growth of wealth among the industrial classes had made living more costly. The agriculturists of the north and east saw themselves and their class threatened with loss, and perhaps ruin; their discontent, which had long been growing, broke out into open fire during the discussion of the commercial treaties. As these would inevitably bring about a large increase in the importation of corn from Rumania and Russia, a great agitation was begun in agricultural circles, and the whole influence of the Conservative party was opposed to the treaties. This brought about a curious situation, the measures being only carried by the support of the Centre, the Radicals, and the Socialists, against the violent opposition of those classes, especially the landowners in Prussia, who had hitherto been the supporters of the government. In order to prevent the commercial treaty with Russia, a great agricultural league was founded in 1893, the *Bund der Landwirte*; some 7000 landowners joined it immediately. Two days later the Peasants' League, or *Deutsche Bauernbund*, which had been founded in 1885 and included some 44,000 members, chiefly from the smaller proprietors in Pomerania, Posen, Saxony and Thuringia, merged itself in the new league. This afterwards gained very great proportions. It became, with the Social Democrats, the most influential society which had been founded in Germany for defending the interests of a particular class; it soon numbered more than 200,000 members, including landed proprietors of all degrees. Under its influence a parliamentary union, the *Wirtschaftsvereinigung*, was founded to ensure proper consideration for agricultural affairs; it was joined by more than 100 members of the Reichstag; and the Conservative party fell more and more under the influence of the Agrarians.

Having failed to prevent the commercial treaties, Count Kanitz introduced a motion that the state should have a monopoly of all imported corn, and that the price at which it was to be sold should be fixed by law. On the first occasion, in 1894, only fifty members were found to vote for this, but in the next year ninety-seven supported the introduction of the motion, and it was considered worth while to call together the Prussian council of state for a special discussion. The whole agitation was extremely inconvenient to the government. The violence with which it was conducted, coming, as it did, from the highest circles of the Prussian nobility, appeared almost an imitation of Socialist methods; but the emperor, with his wonted energy, personally rebuked the leaders, and warned them that the opposition of Prussian nobles to their king was a monstrosity. Nevertheless they were able to overthrow the chancellor, who was specially

obnoxious to them. In October 1894 he was dismissed suddenly, without warning, and almost without cause, while the emperor was on a visit to the Eulenburgs, one of the most influential families of the Prussian nobility.

Caprivi's fall, though it was occasioned by a difference between him and Count Eulenburg, and was due to the direct act of the emperor, was rendered easier by the weakness of his parliamentary position. There was no party on whose help he could really depend. The Military Bill had offended the prejudices of conservative military critics; the British treaty had alienated the colonial party; the commercial treaties had only been carried by the help of Poles, Radicals and Socialists; but it was just these parties who were the most easily offended by the general tendencies of the internal legislation, as shown in the Prussian School Bill. Moreover, the bitter and unscrupulous attacks of the Bismarckian press to which Caprivi was exposed made him unpopular in the country, for the people could not feel at ease so long as they were governed by a minister of whom Bismarck disapproved. There was therefore no prospect of forming anything like a stable coalition of parties on which he could depend.

The emperor was fortunate in securing as his successor Prince Chlodwig von Hohenlohe. Though the new chancellor once more united with this office that of Prussian minister-president, his age, and perhaps also his character, prevented him from exercising that constant activity and vigilance which his two predecessors had displayed.

During his administration even the secretary of state for foreign affairs, Baron Marschall von Bieberstein, and afterwards Count von Bülow, became the ordinary spokesman of the government, and in the management of other departments the want of a strong hand at the head of affairs was often missed. Between the emperor, with whom the final direction of policy rested, and his subordinates, the chancellor often appeared to evade public notice. The very first act of the new chancellor brought upon him a severe rebuff. At the opening of the new buildings which had been erected in Berlin for the Reichstag, cheers were called for the emperor. Some of the Socialist members remained seated. It was not clear that their action was deliberate, but none the less the chancellor himself came down to ask from the House permission to bring a charge of *lèse-majesté* against them, a request which was, of course, almost unanimously refused.

The Agrarians still maintained their prominent position in Prussia. They opposed all bills which would appear directly or indirectly to injure agricultural interests. They looked with suspicion on the naval policy of the emperor, for they disliked all that helps industry and commerce. They would only give their support to the Navy Bills of 1897 and 1900 in return for large concessions limiting the importation of margarine and American preserved meat, and the removal of the *Indemnitäts Nachweis* acted as a kind of bounty on the export of corn. They successfully opposed the construction of the great canal from Westphalia to the Elbe, on the ground that it would facilitate the importation of foreign corn. They refused to accept all the compromises which Miquel, who was very sympathetic towards them, suggested, and thereby brought about his retirement in May 1901.

The opposition of the Agrarians was for many reasons peculiarly embarrassing. The franchise by which the Prussian parliament is elected gave the Conservatives whom they controlled a predominant position. Any alteration of the franchise was, however, out of the question, for that would admit the Socialists. It was, moreover, the tradition of the Prussian court and the Prussian government, (and it must be remembered that the imperial government is inspired by Prussian traditions) that the nobility and peasants were in a peculiar way the support of the crown and the state. The old distrust of the towns, of manufacturers and artisans, still continued. The preservation of a peasant class was considered necessary in the interests of the army. Besides, intellectual and social prejudices required a strong Conservative party. In the south and west of Germany, however, the Conservative party was practically non-existent. In these parts,

owing to the changes introduced at the revolution, the nobility, who hold little land, are, comparatively speaking, without political importance. In the Catholic districts the Centre had become absolutely master, except so far as the Socialists threaten their position. Those of the great industrialists who belonged to the National Liberals or the Moderate Conservatives did not command that influence which men of their class generally hold in Great Britain, because the influence of Social Democracy banded together the whole of the working men in a solid phalanx of irreconcilable opposition, the very first principle of which was the hostility of classes. The government, therefore, were compelled to turn for support to the Centre and the Conservatives, the latter being almost completely under the influence of the old Prussian nobility from the north-east. But every attempt to carry out the policy supported by these parties aroused an opposition most embarrassing to the government.

The Conservatives distrusted the financial activity which centred round the Exchanges of Berlin and other towns, and in this they had the sympathy of Agrarians and **Exchange regula-** Anti-Semites, as well as of the Centre. The Agrarians **tions.** believed that the Berlin Exchange was partly responsible for the fall of prices in corn; the Anti-Semites laid stress on the fact that many of the financiers were of Jewish extraction; the Centre feared the moral effects of speculation. This opposition was shown in the demand for additional duties on stamps (this was granted by Bismarck), in the opposition to the renewal of the Bank Charter, and especially in the new regulations for the Exchange which were carried in 1896. One clause in this forbade the dealing in "futures" in corn, and at the same time a special Prussian law required that there should be representatives of agriculture on the managing committee of the Exchange. The members of the Exchanges in Berlin and other towns refused to accept this law. When it came into effect they withdrew and tried to establish a private Exchange. This was prevented, and after two years they were compelled to submit and the Berlin Bourse was again opened.

Political parties now came to represent interests rather than principles. The government, in order to pass its measures,

Political bargain-

was obliged to purchase the votes by class legislation, and it bought those with whom it could make the best bargain—these being generally the Centre, as the ablest tacticians, and the Conservatives, as having the highest

social position and being boldest in declaring their demands. No great parliamentary leader took the place of Windthorst, Lasker and Bennigsen; the extra-parliamentary societies, less responsible and more violent, grew in influence. The Anti-Semites gained in numbers, though not in reputation. The Conservatives, hoping to win votes, even adopted an anti-Semite clause in their programme. The general tendency among the numerous societies of Christian Socialism; which broke up almost as quickly as they appeared, was to drift from the alliance with the ultra-Conservatives and to adopt the economic and many of the political doctrines of the Social Democrats. The *National-Sozialer Verein* defended the union of Monarchy and Socialism. Meanwhile the extreme spirit of nationality was fostered by the *All-deutscher Verein*, the policy of which would quickly involve Germany in war with every other nation. More than once the feelings to which they gave expression endangered the relations of Germany and Austria-Hungary. The persecution of the Poles in Prussia naturally aroused indignation in Austria, where the Poles had for long been among the strongest elements on which the government depended; and it was not always easy to prevent the agitation on behalf of the Germans in Bohemia from assuming a dangerous aspect.

In the disintegration of parties the Liberals suffered most. The unity of the Conservatives was preserved by social forces and the interests of agriculture; the decay of the Liberals was the result of universal suffrage. Originally the opponents of the landed interest and the nobility, they were the party of the educated middle class, of the learned, of the officials and finance. They never succeeded in winning the support of the working men. They had identified themselves with the interests of the

capitalists, and were not even faithful to their own principles. In the day of their power they showed themselves as intolerant as their opponents had been. They resorted to the help of the government in order to stamp out the opinions with which they disagreed, and the claims of the artisans to practical equality were rejected by them, as in earlier days the claims of the middle class had been by the nobles.

The Centre alone maintained itself. Obligated by their constitution to regard equally the material interests of all classes—for they represent rich and poor, peasants and artisans—they were the natural support of the government when it attempted to find a compromise between the clamour of opposing interests. Their own demands were generally limited to the defence of order and religion, and to some extent coincided with the wishes of the emperor; but every attempt to introduce legislation in accordance with their wishes led to a conflict with the educated opinion of the country, which was very detrimental to the authority of the government. In the state parliaments of Bavaria, Baden and Hesse their influence was very great. There was, moreover, a tendency for local parties to gain in numbers and influence—the *Volkspartei* in Württemberg, the Anti-Semites in Hesse, and the *Bauernbund* (Peasants' League) in Bavaria. The last demanded that the peasants should be freed from the payment to the state, which represented the purchase price for the remission of feudal burdens. It soon lost ground, however, partly owing to personal reasons, and partly because the Centre, in order to maintain their influence among the peasants, adopted some features of their programme.

Another class which, seeing itself in danger from the economic changes in society, agitated for special legislation was the small retail traders of the large towns. They demanded **Mittel-** additional taxation on the vast shops and stores, the **stand-** growth of which in Berlin, Munich and other towns **politik.** seemed to threaten their interests. As the preservation of the smaller middle class seemed to be important as a bulwark against Socialism, they won the support of the Conservative and Clerical parties, and laws inspired by them were passed in Bavaria, Württemberg and Prussia. This *Mittelstand-Politik*, as it is called, was very characteristic of the attitude of mind which was produced by the policy of Protection. Every class appealed to the government for special laws to protect itself against the effects of the economic changes which had been brought about by the modern industrial system. Peasants and landlords, artisans and tradesmen, each formed their own league for the protection of their interests, and all looked to the state as the proper guardian of their class interests.

After the fall of Caprivi the tendency of the German government to revert to a strong conservative policy in matters of religion, education, and in the treatment of political discussions became very marked. The complete **Moral and religious** alienation of the working classes from Christianity **policy.** caused much natural concern, combined as it was

with that indifference to religion which marks the life of the educated classes in the large towns; and especially in Berlin. A strong feeling arose that social and political dangers could only be avoided by an increase in religious life, and the emperor gave the authority of his name to a movement which produced numerous societies for home mission work, and (at least in Berlin) led to the erection of numerous churches. Unfortunately, this movement was too often connected with political reaction, and the working classes were inclined to believe that the growth of religion was valued because it afforded an additional support to the social and political order. The situation was somewhat similar to that which existed during the last years of Frederick William IV., when the close association of religion with a Conservative policy made orthodoxy so distasteful to large sections of society. The government, which had not taken warning by the fate of the School Bill, attempted to carry other measures of the same kind. The emperor had returned to Bismarck's policy of joining social reform with repressive legislation. In a speech at Königsberg in November 1894, he summoned the nobles of Prussia to support him in the struggle for religion, for morality,

for order, against the parties of *Umsturz*, or Revolution, and shortly afterwards an amendment of the Criminal Code, commonly called the *Umsturz-Vorlage*, was introduced, containing provisions to check attempts to undermine the loyalty of the soldiers, and making it a crime punishable with three years' imprisonment to attack religion, monarchy, marriage, the family or property by abusive expressions in such a manner as to endanger public peace. The discussion of this measure occupied most of the session of 1895; the bill was amended by the Centre so as to make it even more strongly a measure for the defence of religion; and clauses were introduced to defend public morality, by forbidding the public exhibition of pictures or statues, or the sale of writings, which, "without being actually obscene, might rudely offend the feeling of modesty." These Clerical amendments aroused a strong feeling of indignation. It was represented that the freedom of art and literature was being endangered, and the government was obliged to withdraw the bill. The tendency towards a stricter censorship was shown by a proposal which was carried through the Prussian parliament for controlling the instruction given at the universities by the *Privadozenten*. Some of the Conservative leaders, especially Baron von Stumm, the great manufacturer (one of Bismarck's chief advisers on industrial matters), demanded protection against the teaching of some of the professors with whose economic doctrines they did not agree; pastors who took part in the Christian-Social movement incurred the displeasure of the government; and Professor Delbrück was summoned before a disciplinary court because, in the *Preussische Jahrbücher*, which he edited, he had ventured to criticize the policy of the Prussian government towards the Danes in Schleswig. All the discontent and suspicion caused by this policy broke out with greater intensity when a fresh

Lex Heinze. attempt was made in 1900 to carry those clauses of the old *Umsturz-Vorlage* which dealt with offences against public morality. The gross immoralities connected with prostitution in Berlin had been disclosed in the case of a murderer called Heinze in 1891; and a bill to strengthen the criminal law on the subject was introduced but not carried. The measure continued, however, to be discussed, and in 1900 the government proposed to incorporate with this bill (which was known as the *Lex Heinze*) the articles from the *Umsturz-Vorlage* subjecting art and literature to the control of the criminal law and police. The agitation was renewed with great energy. A *Goethe-Verein* was founded to protect *Kultur*, which seemed to be in danger. In the end the obnoxious clauses were only withdrawn when the Socialists used the forms of the House to prevent business from being transacted. It was the first time that organized obstruction had appeared in the Reichstag, and it was part of the irony of the situation that the representatives of art and learning owed their victory to the Socialists, whom they had so long attacked as the great enemies of modern civilization.

These were not the only cases in which the influence of the parties of reaction caused much discontent. There was the question of the right of combination. In nearly every state there still existed old laws forbidding political societies to unite with one another. These laws had been passed in the years immediately after the revolution of 1848, and were quite out of place under modern conditions. The object of them was to prevent a network of societies from being formed extending over large districts, and so acquiring political power. In 1895 the Prussian police used a law of 1850 as a pretext for dissolving the Socialist organization in Berlin, as had been done twenty years before. A large majority of the Reichstag demanded that an imperial law should be passed repealing these laws and establishing the right of combination, and they refused to pass the revised Civil Code until the chancellor promised that this should be done. Instead of this course being adopted, however, special laws were introduced in most of the states, which, especially in Prussia and Saxony, while they gave the right of combination, increased the power of the police to forbid assemblies and societies. It was apparent that large and influential parties still regarded political meetings as something

in themselves dangerous and demoralizing, and hence the demand of the Conservatives that women and young persons should be forbidden to attend. In Prussia a majority of the Upper House and a very large minority of the Lower House (103 to 306) voted for an amendment expressly empowering the police to break up meetings in which anarchistic, socialistic or communistic doctrines were defended in such a manner as to be dangerous to society; the Saxon Conservatives demanded that women at least should be forbidden to attend socialistic meetings, and it remained illegal for any one under twenty-one years of age to be present at a political meeting. In consequence of the amendments in the Upper House the Prussian law was lost; and at last, in 1899, a short imperial law was carried to the effect that "societies of every kind might enter into union with one another." This was at once accepted by the chancellor; it was the time when the Navy Bill was coming on, and it was necessary to win votes. The general feeling of distrust which this prolonged controversy aroused was, however, shown by the almost contemptuous rejection in 1899 of a Bill to protect artisans who were willing to work against intimidation or violence (the *Zuchthaus-Vorlage*), a vote which was the more significant as it was not so much occasioned by the actual provisions of the bill, but was an expression of the distrust felt for the motives by which the government was moved and the reluctance to place any further powers in their hands.

Meanwhile the emperor had set himself the task of doing for the German fleet what his grandfather had done for the army. The acquisition of Heligoland enabled a new naval station to be established off the mouth of the Elbe; the completion of the canal from Kiel to the mouth of the Elbe, by enabling ships of war to pass from the Baltic to the North Sea greatly increased the strategic strength of the fleet. In 1890 a change in the organization separated the command of the fleet from the office of secretary of state, who was responsible for the representation of the admiralty in the Reichstag, and the emperor was brought into more direct connexion with the navy. During the first five years of the reign four line-of-battle ships were added and several armoured cruisers for the defence of commerce and colonial interests. With the year 1895 began a period of expansion abroad and great naval activity. The note was given in a speech of the emperor's on the twenty-fifth anniversary of the foundation of the empire, in which he said, "The German empire has become a world empire." The ruling idea of this new *Welt-Politik* was that Germany could no longer remain merely a continental power; owing to the growth of population she depended for subsistence on trade and exports; she could not maintain herself amid the rivalry of nations unless the government was able actively to support German traders in all parts of the world. The extension of German trade and influence has, in fact, been carried out with considerable success. There was no prospect of further territory in Equatorial Africa, and the hope of bringing about a closer union with the South African Republic was not fulfilled. On the Pacific, however, there were great gains;¹ long-established plans for obtaining a port in China which might serve as a base for the growing trade at Tientsin were carried out at the end of 1897; the murder of two Catholic missionaries was made the pretext for landing troops in the bay of Kiao-chau; and in amends China granted the lease of some 50 sq. m. of territory, and also a concession for building railways. The emperor showed his strong personal interest by sending his brother, Prince Henry, in command of a squadron to take possession of this territory, and the visit of a German prince to the emperor of China strongly appealed to the popular imagination. The emperor's characteristically rhetorical speeches on this occasion—particularly his identification of his brother with the "mailed fist" of Germany—excited considerable comment.

¹ In 1899, following the Spanish-American War, Germany purchased the Caroline, Pelew and Marianne Islands from Spain; in 1899-1900 by agreement with Great Britain and America she acquired the two largest of the Samoan islands, renouncing in favour of Britain her protectorate over certain of the Solomon islands.

In Turkey the government, helped again by the personal interest of the emperor, who himself visited the sultan at Constantinople, gained important concessions for German influence and German commerce. The Turkish armies were drilled and commanded by German officers, and in 1899 a German firm gained an important concession for building a railway to Baghdad. In Brazil organized private enterprise established a considerable settlement of German emigrants, and though any political power was for the time impossible, German commerce increased greatly throughout South America.

Encouraged by the interest which the events in China had aroused, a very important project was laid before the Reichstag in November 1897, which would enable Germany to take a higher place among the maritime powers. A completely new procedure was introduced. Instead of simply proposing to build a number of new ships, the bill laid down permanently the number of ships of every kind of which the navy was to consist. They were to be completed by 1904; and the bill also specified how often ships of each class were to be replaced. The plan would establish a normal fleet, and the Reichstag, having once assented, would lose all power of controlling the naval budget. The bill was strongly opposed by the Radicals; the Centre was divided; but the very strong personal influence of the emperor, supported by an agitation of the newly-formed *Flottenverein* (an imitation of the English Navy League), so influenced public opinion that the opposition broke down. A general election was imminent, and no party dared to go to the country as the opponents of the fleet.

Scarcely had the bill been carried when a series of events took place which still more fully turned public attention to colonial affairs, and seemed to justify the action of the government. The war between the United States and Spain showed how necessary an efficient fleet was under modern conditions, and also caused some feeling of apprehension for the future arising from the new policy of extension adopted by the United States. And the brewing of the storm in South Africa, where the Boers were preparing to resist British suzerainty, helped to make the nation regret that their fleet was not sufficiently strong to make German sympathies effective. The government used with great address the bitter irritation against Great Britain which had become one of the most deep-seated elements in modern German life. This feeling had its origin at first in a natural reaction against the excessive admiration for English institutions which distinguished the Liberals of an older generation. This reaction was deliberately fostered during Bismarck's later years for internal reasons; for, as Great Britain was looked upon as the home of parliamentary government and Free Trade, a less favourable view might weaken German belief in doctrines and institutions adopted from that country. There also existed in Germany a curious compound of jealousy and contempt, natural in a nation the whole institutions of which centred round the army and compulsory service, for a nation whose institutions were based not on military, but on parliamentary and legal institutions. It came about that in the minds of many Germans the whole national regeneration was regarded as a liberation from British influence. This feeling was deliberately fostered by publicists and historians, and was intensified by commercial rivalry, since in the struggle for colonial expansion and trade Germans naturally came to look on Great Britain, who held the field, as their rival. The sympathy which the events of 1896 and 1899 awakened for the

Boers caused all these feelings, which had long been growing, to break out in a popular agitation more widespread than any since the foundation of the empire.

It was used by the Nationalist parties, in Austria as well as in Germany, to spread the conception of Pan-Germanism; the Boers as Low Germans were regarded as the representatives of Teutonic civilization, and it seemed possible that the conception might be used to bring about a closer friendship, and even alliance, with Holland. In 1896 the emperor, by despatching a telegram of congratulation to President Kruger after the collapse

of the Jameson Raid, had appeared to identify himself with the national feeling. When war broke out in 1899 it was obviously impossible to give any efficient help to the Boers, but the government did not allow the moment to pass without using it for the very practical purpose of getting another *Navy Bill*, 1900, bill through the Reichstag by which the navy was to be nearly doubled. Some difficulties which arose regarding the exercise by the British government of the right of search for contraband of war were also used to stimulate public feeling. The Navy Bill was introduced in January 1900. There were some criticisms of detail, but the passing of the bill was only a matter of bargaining. Each party wished in return for its support to get some concessions from the government. The Agrarians asked for restrictions on the importation of food; the Centre for the Lex Heinze and the repeal of the Jesuit law; the Liberals for the right of combination.

The murder of the German ambassador, Baron von Ketteler, at Peking in 1900 compelled the government to take a leading part in the joint expedition of the powers to China. A force of over 20,000 men was organized by voluntary enlistment from among the regular army; and the supreme command was obtained by the emperor for Count von Waldersee, who had succeeded Moltke as chief of the staff. The government was, however, sharply criticized for not first consulting the Reichstag in a matter involving the first military expedition since the foundation of the empire. It was desirable in such circumstances that a younger and more vigorous statesman than Prince Hohenlohe should be placed at the head of affairs before the Reichstag met; and on the 17th of October he resigned, and was succeeded as chancellor by Herr von Bülow, the foreign secretary. (J. W. H.E.; W. A. P.)

It remains only to sketch the main features of German history in later years. In spite of the denunciation by the Social Democratic leaders of what they stigmatized as a "policy of brag," the general popularity of the idea of establishing a strong sea power was proved by the rapid extension of the Navy League, which in 1904 had already 3505 branches. For an increase in the navy there was, indeed, sufficient excuse in the enormous expansion of German over-sea commerce and the consequent growth of the mercantile marine; the value of foreign trade, which in 1894 was £365,000,000, had risen in 1904 to £610,000,000, and in the same period the tonnage of German merchant shipping had increased by 234%. In the session of 1901 Admiral von Tirpitz, the minister of marine, admitted in answer to a Socialist interpellation that the naval programme of 1900 would have to be enlarged. In 1903 Count Bülow declared in the Reichstag that the government was endeavouring to pursue a middle course between "the extravagant aspirations of the Pan-Germans and the parochial policy of the Social Democrats, which forgets that in a struggle for life and death Germany's means of communication might be cut off." At the same time the emperor presented to the Reichstag a comparative table, drawn up by his own hand, showing the relative strength of the British and German navies. An inspired article in the *Grenzboten* declared the object of this to be to moderate at once the aggressive attitude of the Pan-Germans towards Great Britain and British alarms at the naval development of Germany. This gave a fresh impetus to the naval agitation and counter-agitation. In 1904 Count Bülow again found it necessary, in reply to the Socialist leader Bebel, to declare that the German naval armaments were purely defensive. "I cannot conceive," he said, "that the idea of an Anglo-German war should be seriously entertained by sensible people in either country." On the 16th of November 1905 a new Navy Bill amplifying the programme of 1900 was accepted by the Federal Diet. The Navy League, encouraged by its success, now redoubled its exertions and demanded that the whole programme should be completed by 1912 instead of 1917. Bebel denounced this agitation as obviously directed against England; and the government thought it expedient to disavow the action of its too zealous allies. A telegram addressed by the emperor William to the presidents of the League, Generals Keim and Menner, led to

their resignation; but the effect of this was largely counteracted by the presence of Prince Henry of Prussia and the king of Württemberg at the annual congress of the League at Stuttgart in May, while at the Colonial Congress in the autumn the necessity for a powerful navy was again one of the main themes of discussion. That the government was, in fact, at one with the League as to the expediency of pushing on the naval programme was proved by the revelations of the first lord of the admiralty, Mr McKenna, in the debate on the naval estimates in the British parliament of 1909. From these it was clear that the German government had for some time past been pressing on its naval armaments with little regard to the ostensible programme, and that in the matter of the newest types of battleships, Great Britain had to reckon with the fact that, before the date fixed for the completion of the programme, Germany might establish at least an equality.

The same determined spirit which characterized German naval policy was evident also in her relations with the other powers.

Foreign policy.

The suspicions as to the stability of the Triple Alliance produced, indeed, for some years a kind of nervousness in the attitude of the government, whose determination to assert for Germany a leading international rôle tended to isolate her in Europe. This nervousness was, in 1903 and 1904, especially evident in the efforts to weaken the Franco-Russian alliance by the policy of what Bebel denounced as Germany "crawling on her stomach before Russia." Germany not only backed up Russian policy in the East, and at the outbreak of the Russo-Japanese War took up towards her an attitude of more than benevolent neutrality, but the cabinets of Berlin and St Petersburg entered into an agreement under which political offenders against either government were to be treated as traitors to both. This arrangement, which made the Prussian police the active allies of the Third Section in the persecution of political suspects, created vast indignation among all shades of Liberal opinion in Germany, an indignation which culminated with the famous Königsberg trial.

This was a prosecution of nine German subjects for sedition, conspiracy and *lèse-majesté* against the Russian emperor, and for the circulation of books and pamphlets attacking him and his government. The defendants were poor smugglers from the Estonian border marshes, who in the course of their ordinary avocations had carried bales of revolutionary tracts into Russia without troubling as to their contents. The trial, which took place in July 1904, excited widespread attention. The prosecution was conducted with all the force of the government; the defence was undertaken by some of the most brilliant Liberal advocates of Germany and developed in effect into an elaborate indictment, supported by a great weight of first-hand evidence, of the iniquities of the Russian régime. The verdict of the court was a serious rebuff for the government; after a preliminary investigation of nine months, and a public trial of a fortnight, the major charges against the prisoners were dismissed, and six of them were condemned only to short terms of imprisonment for conspiracy.

The progress of the Russo-Japanese War, however, soon relieved Germany of all anxiety as to the safety of her eastern frontiers, and produced a corresponding change in her attitude. The Russian disasters in Manchuria at the beginning of 1905 were followed by an extraordinary demonstration of the emperor William's ideas as to "the world-wide dominion of the Hohenzollerns," in a sort of imperial progress in the East, made for the purpose of impressing the Mahomedan world with the power of Germany. In 1904 the German attitude towards Great Britain had been in the highest degree conciliatory; the Anglo-French agreement as to Egypt was agreed to at Berlin; a visit of King Edward VII. to Kiel was reciprocated by that of the German squadron to Plymouth; in July a treaty of arbitration was signed between the two countries, while in the Reichstag the chancellor declared that, Germany's interests in Morocco being purely commercial, the understanding between France and England as to that country, embodied in the convention of the 5th of April 1904, did not immediately concern her. This attitude

was now changed. On the 31st of March 1905 the emperor William landed at Tangier, and is reported on this occasion to have used language which in effect amounted to a promise to support the sultan of Morocco in resisting French control. His visit to the Holy Land and the solemn pilgrimage to Jerusalem were, in the same way, a striking *coup de théâtre* designed to strengthen the influence won by Germany in the councils of the Ottoman empire, an influence which she had been careful not to weaken by taking too active a part in the concert of the powers engaged in pressing on the question of Macedonian reform.

Meanwhile pressure was being put upon France to admit the German claim to a voice in the affairs of North Africa, a claim fortified by the mission of Count von Tattenbach, German minister at Lisbon, to Fez for the purpose of securing from the sherrifian government special privileges for Germany. This aggressive policy was firmly resisted by M. Delcassé, the French minister of foreign affairs, and for a while war seemed to be inevitable. At Berlin powerful influences, notably that of Herr von Holstein—that mysterious omnipotence behind the throne—were working for this end; the crippling of Russia seemed too favourable an opportunity to be neglected for crushing the menace of French armaments. That an actual threat of war was conveyed to the French government (through the German ambassador at Rome, it is said) there can be no doubt. That war was prevented was due partly to the timidity of French ministers, partly to the fact that at the last moment Herr von Holstein shrank from the responsibility of pressing his arguments to a practical conclusion. The price of peace, however, was the resignation of M. Delcassé, who had been prepared to maintain a bold front. Germany had perhaps missed an opportunity for putting an end for ever to the rivalry of France; but she had inflicted a humiliation on her rival, and proved her capacity to make her voice heard in the councils of Europe.¹ The proceedings of the conference of Algéciras (see MOROCCO) emphasized the restored confidence of Germany in her international position. It was notably the part played by Austria in supporting the German point of view throughout at the conference that strengthened the position of Germany in Europe, by drawing closer the bonds of sympathy between the two empires. How strong this position had become was demonstrated during the crisis that arose after the revolution in Turkey and the annexation of Bosnia and Herzegovina by Austria in October 1908. The complete triumph of Baron von Aehrenthal's policy, in the face of the opposition of most of the European powers, was due to German support, and Germany suddenly appeared as the arbiter of the affairs of the European continent (see EUROPE: History). German nervousness, which had seen British intrigues everywhere, and suspected in the beneficent activities of King Edward VII. a Machiavellian plan for isolating Germany and surrounding her with a net of hostile forces, gave way to a spirit of confidence which could afford to laugh at the terror of Germany which, to judge from the sensational reports of certain popular British journals, had seized upon Great Britain.

The great position gained by the German empire in these years was won in the face of great and increasing internal difficulties. These difficulties were, in the main, the outcome of the peculiar constitution of the empire, of the singular compromise which it represented between the traditional medieval polity and the organization of a modern state, and of the conflicts of ideals and of interests to which this gave rise; these being complicated by the masterful personality of the emperor William, and his tendency to confuse his position as German emperor by the will of the princes with his position as king of Prussia by the grace of God.

In general, Germany had passed since the war through a social and economic revolution similar to that undergone by Great Britain during the earlier half of the 19th century, though on a greater scale and at a much accelerated pace. A country

¹ The elevation of Count Bulow to the rank of prince immediately after the crisis was significantly compared with the same honour bestowed on Bismarck at Versailles in 1871.

mainly agricultural, and in parts purely feudal, was changed into one of vast industries and of great concentrations of population; and for the ferment created by this change there was no such safety-valve in the representative system as had existed in England since the Reform Bill. In spite of the election of the Reichstag by manhood suffrage, there existed, as Count Bülow pointed out in 1904, no real parliamentary system in Germany, and "owing to the economic, political, social and religious structure of the nation" there could never be one. Of the numerous groups composing the German parliament no one ever secured a majority, and in the absence of such a majority the imperial government, practically independent of parliament, knew how to secure its assent to its measures by a process of bargaining with each group in turn. This system had curious and very far-reaching results. The only group which stood outside it, in avowed hostility to the whole principle on which the constitution was based, was that of the Social Democrats, "the only great party in Germany which," so the veteran Mommsen declared in 1901, "has any claim to political respect." The consequence was the rapid extension and widening of the chasm that divided the German people. The mass of the working-class population in the Protestant parts of Germany belonged to the Social Democracy, an inclusive term covering variations of opinion from the doctrinaire system of Marx to a degree of Radicalism which in England would not be considered a bar to a peerage. To make head against this, openly denounced by the emperor himself as a treasonable movement, the government was from time to time forced to make concessions to the various groups which placed their sectional interests in the forefront of their programmes. To conciliate the Catholic Centre party, numerically the strongest of all, various concessions were from time to time made to the Roman Catholic Church, e.g. the repeal in 1904 of the clause of the Anti-Jesuit Law forbidding the settlement of individual members of the order in Germany. The Conservative Agrarians were conciliated by a series of tariff acts placing heavy duties on the importation of agricultural produce and exempting from duty agricultural implements.

The first of these tariffs, which in order to overcome Socialist obstruction was passed *en bloc* on December 13-14, 1902, led to an alarming alteration in the balance of parties in the new Reichstag of 1903, the Socialists—who had previously numbered 58—winning 81 seats, a gain of 23. Of the other groups only one, and that hostile to the government—the Poles—had gained a seat. This startling victory of the Social Democracy, though to a certain extent discounted by the dissensions between the two wings of the party which were revealed at the congress at Dresden in the same year, was in the highest degree disconcerting to the government; but in the actual manipulation of the Reichstag it facilitated the work of the chancellor by enabling him to unite the other groups more readily against the common enemy. The most striking effect of the development of this antagonism was the gradual disappearance as a factor in politics of the Liberals, the chief builders of the Empire. Their part henceforth was to vote blindly with the Conservative groups, in a common fear of the Social Democracy, or to indulge in protests, futile because backed by no power inside or outside the parliament; their impotence was equally revealed when in December 1902 they voted with the Agrarians for the tariff, and in May 1909 when they withdrew in judgment from the new tariff committee, and allowed the reactionary elements a free hand. The political struggle of the future lay between the Conservative and Clerical elements in the state, alike powerful forces, and the organized power of the Social Democracy. In the elections of 1907, indeed, the Social Democratic party, owing to the unparalleled exertion of the government, had a set-back, its representation in parliament sinking to 43; but at the International Socialist Congress, which met at Stuttgart on the 18th of August, Herr Bebel was able to point out that, in spite of its defeat at the polls, the Socialist cause had actually gained strength in the country, their total poll having increased from 3,010,771 in 1903 to 3,250,000.

In addition to the political strife and anxiety due to this fundamental cleavage within the nation, Germany was troubled during the first decade of the 20th century by friction and jealousies arising out of the federal constitution of the Empire and the preponderant place in it of Prussia. In the work of pressing on the national and international expansion of Germany the interests and views of the lesser constituent states of the Empire were apt to be overlooked or overridden; and in the southern states there was considerable resentment at the unitarian tendency of the north, which seemed to aim at imposing the Prussian model on the whole nation. This resentment was especially conspicuous in Bavaria, which clings more tenaciously than the other states to its separate traditions. When, on the 1st of April 1902, a new stamp, with the superscription "Deutsches Reich," was issued for the Empire, including Württemberg, Bavaria refused to accept it, retaining the stamp with the Bavarian lion, thus emphasizing her determination to retain her separate postal establishment. On the 23rd of October 1903 Baron Pödevels, the new premier, addressing the Bavarian diet, declared that his government "would combat with all its strength" any tendency to assure the future of the Empire on any lines other than the federative basis laid down in the imperial constitution.

This protest was the direct outcome of an instance of the tendency of the emperor to interfere in the affairs of the various governments of the Empire. In 1902 the Clerical majority in the Bavarian diet had refused to vote £20,000 asked by the government for art purposes, whereupon the emperor had telegraphed expressing his indignation and offering to give the money himself, an offer that was politely declined. Another instance of the emperor's interference, constitutionally of more importance as directly affecting the rights of the German sovereigns, was in the question of the succession to the principality of Lippe (see LIPPE). The impulsive character of the emperor, which led him, with the best intentions and often with excellent effect, to interfere everywhere and in everything and to utter opinions often highly inconvenient to his ministers, was the subject of an interpellation in the Reichstag on the 20th of January 1903 by the Socialist Herr von Vollmar, himself a Bavarian. Count Bülow, in answer to his criticisms, declared that "the German people desired, not a shadow, but an emperor of flesh and blood." None the less, he continued "indiscretions" of the emperor so incensed public opinion that, five years later, the chancellor himself was forced to side with it in obtaining from the emperor an undertaking to submit all his public utterances previously to his ministers for approval (see WILLIAM II., German emperor).

Meanwhile, the attempt to complete the Germanization of the frontier provinces of the Empire by conciliation or repression continued. In this respect progress was made especially in Alsace-Lorraine. In May 1902, in return for the money granted by the *Reichsländer* for the restoration of the imperial castle of Hoheköningsburg in the Vosges, the emperor promised to abolish the *Diktaturparagraphen*; the proposal was accepted by the Reichstag, and the exceptional laws relating to Alsace-Lorraine were repealed. Less happy were the efforts of the Prussian government at the Germanization of Prussian Poland and Schleswig. In the former, in spite of, or perhaps because of, the attempt to crush the Polish language and spirit, the Polish element continuously increased, reinforced by immigrants from across the frontier; in the latter the Danish language more than held its own, for similar reasons, but the treaty signed on the 11th of January 1907 between Prussia and Denmark, as to the status of the Danish "optants" in the duchies, removed the worst grievance from which the province was suffering (see SCHLESWIG-HOLSTEIN QUESTION).

Of more serious import were the yearly and increasing deficits in the imperial budget, and the consequent enormous growth of the debt. This was partly due to the commercial and industrial depression of the early years of the century, partly was another outcome of the federal constitution, which made it difficult to

Prussia
and the
Empire.

Personal
inter-
ventions
of the
emperor.

Social
Demo-
cracy.

The non-
German
national-
ities.

adjust the budget to the growing needs of the Empire without disarranging the finances of its constituent states. The crisis became acute when the estimates for the year 1909 showed that some £25,000,000 would have to be raised by additional taxes, largely to meet the cost of the expanded naval programme. The budget presented to the Reichstag by Prince Bülow, which laid new burdens upon the landed and capitalist classes, was fiercely opposed by the Agrarians, and led to the break-up of the Liberal-Conservative *bloc* on whose support the chancellor had relied since the elections of 1906. The budget was torn to pieces in the committee selected to report on it; the Liberal members, after a vain protest, seceded; and the Conservative majority had a free hand to amend it in accordance with their views. In the long and acrimonious debates that followed in the Reichstag itself the strange spectacle was presented of the chancellor fighting a coalition of the Conservatives and the Catholic Centre with the aid of the Socialists and Liberals. The contest was from the first hopeless, and, but for the personal request of the emperor that he would pilot the Finance Bill through the House in some shape or other, Prince Bülow would have resigned early in the year. So soon as the budget was passed he once more tendered his resignation, and on the 14th of July a special edition of the *Imperial Gazette* announced that it had been accepted by the emperor. The post of imperial chancellor was at the same time conferred on Theobald von Bethmann-Hollweg, the imperial secretary of state for the interior.¹

(W. A. P.)

Bibliography of German History.—Although the authorities for the history of Germany may be said to begin with Caesar, it is Tacitus who is especially useful, his *Germania* being an invaluable mine of information about the early inhabitants of the country. In the dark and disordered centuries which followed there are only a few scanty notices of the Germans, mainly in the works of foreign writers like Gregory of Tours and Jordanes; and then the 8th and 9th centuries, the time of the revival of learning which is associated with the name of Charlemagne, is reached. By the end of this period Christianity had been firmly established among most of the German tribes; the monks were the trustees of the new learning, and we must look mainly, although not exclusively, to the monasteries for our authorities. The work of the monks generally took the form of *Annales* or *Chronica*, and among the numerous German monasteries which are famous in this connexion may be mentioned Fulda, Reichenau, St Gall and Lorsch. For contemporary history and also for the century or so which preceded the lifetimes of their authors these writings are fairly trustworthy, but beyond this they are little more than collections of legends. There are also a large number of lives of saints and churchmen, in which the legendary element is still more conspicuous.

With regard to the *Annales* and *Chronica* three important considerations must be mentioned. They are local, they are monastic, and they are partisan. The writer in the Saxon abbey of Corvey, or in the Franconian abbey of Fulda, knows only about events which happened near his own doors; he records, it is true, occurrences which rumour has brought to his ears, but in general he is trustworthy only for the history of his own neighbourhood. The Saxon and the Franconian annalists know nothing of the distant Bavarians; there is even a gulf between the Bavarian and the Swabian. Then the *Annals* are monastic. To their writers the affairs of the great world are of less importance than

those of the monastery itself. The Saxon Widukind, for instance, gives more space to the tale of the martyrdom of St Vitus than he does to several of the important campaigns of Henry the Fowler. Lastly, the annalist is a partisan. One is concerned to glorify at all costs the Carolingian house; another sacrifices almost everything to attack the emperor Henry IV. and to defend the Papacy; while a third holds a brief for some king or emperor, like Louis the Pious or Otto the Great.

Two difficulties are met with in giving an account of the sources of German history. In the 7th, 8th and 9th centuries it is hard, if not impossible, to disentangle the history of Germany from that of the rest of the Frankish empire of which it formed part; in fact it is not until the time of the dissensions between the sons of the emperor Louis I. that there are any signs of demarcation between the East and the West Franks, or, in other words, any separate history of Germany. The second difficulty arises later and is due to the connexion of Germany with the Empire. Germany was always the great pillar of the imperial power; for several centuries it was the Empire in everything but in name, and yet its political history is often overshadowed by the glamour of events in Italy. While the chroniclers were recording the deeds of Frederick I. and of Frederick II. in the peninsula, the domestic history of Germany remained to a large extent unwritten.

Among the early German chroniclers the Saxon Widukind, the author of the *Res gestae Saxonicae*, is worthy of mention. He was a monk of Corvey, and his work is the best authority for the early history of Saxony. Lambert, a monk of Hersfeld, and Widukind's countryman, Bruno, in his *De bello Saxonico*, tell the story of the great contest between the emperor Henry IV. and Pope Gregory VII., with special reference to the Saxon part of the struggle. But perhaps the ablest and the most serviceable of these early writers is Otto of Freising, a member of the Babenberg family. Otto was also related to the great house of Hohenstaufen, a relationship which gave him access to sources of information usually withheld from the ordinary monastic annalist, and his work is very valuable for the earlier part of the career of Frederick I. Something is learned, too, from biographies written by the monks, of which Einhard's *Vita Karoli Magni* is the greatest and the best, and Wipo's life of the emperor Conrad II. is valuable, while another Carolingian courtier, Nithard, has a special interest as, almost alone among these early chroniclers, being a soldier and not a monk.

The monastic writers remain our chief authorities until the great change brought about by the invention of printing, although a certain amount of work was done by clerical writers attached to the courts of various rulers. Parallel with this event the revival of learning was producing a great number of men who could write, and, more important still, of men who were throwing off the monastic habits of thought and passing into a new intellectual atmosphere. The Renaissance was followed by the fierce controversies aroused by the Reformation, and the result was the output of an enormous mass of writings covering every phase of the mighty combat and possessing every literary virtue save that of impartiality. But apart from these polemical writings, many of which had only an ephemeral value, the Renaissance was the source of another stream of historical literature. Several princes and other leading personages, foremost among whom was the emperor Maximilian I., had spent a good deal of time and money in collecting the manuscripts of the medieval chroniclers, and these now began to be printed. The chronicle of Otto of Freising, which appeared in 1515, and the *Vita* of Einhard, which appeared six years later, are only two among the many printed at this time. The publication of collections of chronicles began in 1529, and the uncritical fashion in which these were reproduced made forgeries easy and frequent. There was, indeed, more than a zeal for pure learning behind this new movement; for both parties in the great religious controversy of the time used these records of the past as a storehouse of weapons of offence. The Protestants eagerly sought out the writings which exposed and denounced the arrogance of the

¹ He was born on November 29, 1856, the son of a wealthy Rhinish landowner, and grandson of Moritz August von Bethmann-Hollweg (1795-1877), professor of law at Bonn, ennobled in 1840, and from 1838 to 1862 minister of education and religion at Berlin. Herr von Bethmann-Hollweg studied law at Strassburg, Leipzig and Berlin, entered the Prussian civil service in 1882, and, passing successfully through the various stages of a German administrative career, became governor (Oberpräsident) of the province of Brandenburg in 1899. In 1905 he became Prussian minister of the interior. Two years later he succeeded Count Posadowsky as imperial secretary of state for the interior and representative of the imperial chancellor, and was at the same time made vice-president of the council of Prussian ministers, an office and title which had been in abeyance for some years and were now again suppressed.

popes, while the Romanists attempted to counter them with the numerous lives of the saints.

But before the raw material of history thus began to increase enormously in bulk, it had already begun to change its character and to assume its modern form. The *Chronicle* still survived as a medium of conveying information, though more often than not this was now written by a layman; but new stores of information were coming into existence, or rather the old stores were expanding and taking a different form. Very roughly these may be divided into six sections. (1) Official documents issued by the emperors and other German rulers. (2) Treaties concluded between Germany and other powers and also between one German state and another. (3) Despatches sent to England, Spain and other countries by their representatives in various parts of Germany. (4) Controversial writings or treatises written to attack or defend a given position, largely the product of the Reformation period. (5) The correspondence of eminent and observant persons. (6) An enormous mass of personal impressions taking the form of Commentaries, Memoirs and Diaries (*Tagebücher*). Moreover, important personages still find eulogistic biographers and defenders, e.g. the fanciful writings about the emperor Maximilian I. or Pufendorf's *De rebus gestis Friderici Wilhelmi Magni electoris Brandenburgici*.

Through the dust aroused by the great Reformation controversy appear the dim beginnings of the scientific spirit in the writing of history, and in this connexion the name of Aventinus, "the Bavarian Herodotus," may be mentioned. But for many years hardly any progress was made in this direction. Even if they possessed the requisite qualifications the historiographers attached to the courts of the emperor Charles V. and of lesser potentates could not afford to be impartial. Thus new histories were written and old ones unearthed, collected and printed, but no attempt was made to criticize and collate the manuscripts of the past, or to present two sides of a question in the writings of the present. Among the collections of authorities made during the 16th and 17th centuries those of J. Pistorius (Frankfort, 1583-1607), of E. Lindenbrog (Frankfort, 1600) and of M. Freher (Frankfort, 1600-1611), may be noticed, although these were only put together and printed in the most haphazard and unconnected fashion. Passing thus through these two centuries we reach the beginning of the 18th century and the work done for German historical scholarship by the philosopher Leibnitz, who sought to do for his own country what Muratori was doing for Italy. For some years it had been recognized that the collection and arrangement of the authorities for German history was too great an undertaking for any one man, and societies under very influential patronage were founded for this purpose. But very slight results attended these elaborate schemes, although their failure did not deter Leibnitz from pursuing the same end. The two chief collections which were issued by the philosopher are the *Accessiones historice* (1698-1700) and the *Scriptores rerum Brunsvicensium*; the latter of these, containing documents centring round the history of the Welf family, was published in three volumes at Hanover (1707-1711). Leibnitz worked at another collection, the *Origines Guelficæ*, which was completed and issued by his pupils (Hanover, 1750-1780), and also at *Annales imperii occidentis Brunsvicensis*, which, although the most valuable collection of the kind yet made, was not published until edited by G. H. Pertz (Hanover, 1843-1846). Other collections followed those of Leibnitz, among which may be mentioned the *Corpus historicum mediæ ævi* of J. G. Eccard (Leipzig, 1723) and the *Scriptores rerum Germanicarum* of J. B. Mencke (Leipzig, 1728). But these collections are merely heaps of historical material, good and bad; the documents therein were not examined and they are now quite superseded. They give, however, evidence of the great industry of their authors, and are the foundations upon which modern German scholarship has built.

In the 19th century the scientific spirit received a great impetus from the German system of education, one feature of which was that the universities began to require original work for some of their degrees. In this field of scientific research the

Germans were the pioneers, and in it they are still pre-eminent, with Ranke as their most famous name and the *Monumenta Germaniæ historica* as their greatest production. The *Monumenta* is a critical and ordered collection of documents relating to the history of Germany between 500 and 1500. It owes its origin mainly to the efforts of the statesman Stein, who was responsible for the foundation of the *Gesellschaft für ältere deutsche Geschichtskunde*, under the auspices of which the work was begun. The *Gesellschaft* was established in 1819, and, the editorial work having been entrusted to G. H. Pertz, the first volume of the *Monumenta* was published in 1826. The work was divided into five sections: *Scriptores*, *Leges*, *Diplomata*, *Epistolæ* and *Antiquitates*, but it was many years before anything was done with regard to the two last-named sections. In the three remaining ones, however, folio volumes were published regularly, and by 1909 thirty folio volumes of *Scriptores*, five of *Leges* and one of *Diplomata imperii* had appeared. But meanwhile a change of organization had taken place. When Pertz resigned his editorial position in 1874 and the *Gesellschaft* was dissolved, twenty-four folio volumes had been published. The Prussian Academy of Sciences now made itself responsible for the continuance of the work, and a board of direction was appointed, the presidents of which were successively G. Waitz, W. Wattenbach, E. Dümmler and O. Holder-Egger. Soon afterwards as money became more plentiful the scope of work was extended; the production of the folio volumes continued, but the five sections were subdivided and in each of these a series of quarto volumes was issued. The titles of these new sections give a sufficient idea of their contents. The *Scriptores* are divided into *Auctores antiquissimi*, *Scriptores rerum Merovingicarum*, *Scriptores rerum Langobardicarum et Italicarum*, *Libelli de lite imperatorum et pontificum*, *Gesta pontificum Romanorum* and *Deutsche Chroniken*, or *Scriptores qui vernacula lingua usi sunt*. The *Leges* are divided into *Leges nationum Germanicarum*, *Capitularia regum Francorum*, *Concilia*, *Constitutiones imperatorum et regum* and *Formulae*. Three quarto volumes of *Diplomata regum et imperatorum Germaniæ* and one of *Diplomata Karolingorum* had been published by 1909. Work was also begun upon the *Antiquitates* and the *Epistolæ*. The sections of the former are *Follæ Latini mediæ ævi*, *Libri confraternitatum* and *Necrologia Germaniæ*, and of the latter *Epistolæ sæculi XIII.* and *Epistolæ Merovingici et Karolini ævi*. Meanwhile the publication of the *Scriptores* proper continues, although the thirty-first and subsequent volumes are in quarto and not in folio, and the number of volumes in the whole undertaking is continually being increased. The archives of the *Gesellschaft* have been published in twelve volumes, and a large number of volumes of the *Nemes Archiv* have appeared. Some of the MSS. have been printed in facsimile, and an index to the *Monumenta*, edited by O. Holder-Egger and K. Zeumer, appeared in 1890. The writings of the more important chroniclers have been published separately, and many of them have been translated into German.

It will thus be seen that the ground covered by the *Monumenta* is enormous. The volumes of the *Scriptores* contain not only the domestic chroniclers, but also selections from the work of foreign writers who give information about the history of Germany—for example, the Englishman Matthew Paris. In the main these writings are arranged in chronological order. Each has been edited by an expert, and the various introductions give evidence of the number of MSS. collated and the great pains taken to ensure textual accuracy on the part of the different editors, among whom may be mentioned Mommsen and Lappenberg. Other great names in German historical scholarship have also assisted in this work. In addition to Waitz the *Leges* section has enjoyed the services of F. Bluhme and of H. Brunner, and the *Diplomata* section of T. Sickel, H. Bresslau and E. Mühlbacher.

The progress of the *Monumenta* stimulated the production of other works of a like nature, and among the smaller collections of authorities which appeared during the 19th century two are worthy of mention. These are the *Fontes rerum Germanicarum*, edited by J. F. Böhmer (Stuttgart, 1843-1868), a collection of sources of the 12th, 13th and 14th centuries, and the *Bibliotheca*

rerum Germanicarum, edited by Ph. Jaffé (Berlin, 1864-1873). Another development followed the production of the *Monumenta*, this being the establishment in most of the German states of societies the object of which was to foster the study of local history. Reference may be made to a *Verein* for this purpose in Saxony and to others in Silesia and in Mecklenburg. Much has also been done in Prussia, in Brandenburg, in Bavaria, in Hanover, in Württemberg and in Baden, and collections of authorities have been made by competent scholars, of which the *Geschichtsquellen der Provinz Sachsen und angrenzender Gebiete* (Halle, 1870, fol.), which extends to forty volumes, the smaller *Scriptores rerum Prussicarum* (Leipzig, 1861-1874), and the seventy-seven volumes of the *Publikationen aus den königlichen preussischen Staatsarchiven, veranlasst und unterstützt durch die königliche Archivverwaltung* (Leipzig, 1878, fol.), may be cited as examples. The cities have followed the same path and their archives are being thoroughly examined. In 1836 an *Urkundenbuch* of Frankfurt was published, and this example has been widely followed, the work done in Cologne, in Bremen and in Mainz being perhaps specially noticeable. Moreover an historical commission at Munich has published twenty-eight volumes in the series *Die Chroniken der deutschen Städte vom 14. bis ins 16. Jahrhundert* (Leipzig, 1862, fol.). Lastly, many documents relating to the great families of Germany, among them those of Hohenzollern and of Wittelsbach, have been carefully edited and given to the world.

With this great mass of material collected, sifted and edited by scholars of the highest standing it is not surprising that modern works on the history of Germany are stupendous in number and are generally of profound learning, and this in spite of the fact that some German historians—Gregorovius, Pauli and Lappenberg, for example—have devoted their time to researches into the history of foreign lands.

The earliest period is dealt with by K. Zeuss in *Die Deutschen und die Nachbarstämme* (Munich, 1837; new ed., Göttingen, 1904); and then by F. Dahn in his *Urgeschichte der germanischen und romanischen Völker* (Berlin, 1880-1889) and his *Die Könige der Germanen*, volumes of which have appeared at intervals between 1861 and 1909.

The Carolingian time is covered by E. Dümmler's *Geschichte des ostfränkischen Reichs* (Leipzig, 1887-1888), and then follow Ranke's *Jahrbücher des deutschen Reichs unter dem sächsischen Hause* (Berlin, 1837-1840), W. von Giesebrecht's *Geschichte der deutschen Kaiserzeit* (1855-1888), and F. Raumer's *Geschichte der Hohenstaufen*.

For the reigns of Lothair the Saxon and Conrad III. P. Jaffé's books, *Geschichte des deutschen Reiches unter Lothar dem Sachsen* (Berlin, 1843) and *Geschichte des deutschen Reiches unter Conrad III.* (Hanover, 1845), may be consulted.

The chief histories on the period between the fall of the Hohenstaufen and the Renaissance are: T. Lindner, *Deutsche Geschichte unter den Habsburgern und Luxemburgern* (Stuttgart, 1888-1893); O. Lorenz, *Deutsche Geschichte im 13. und 14. Jahrhundert* (Vienna, 1863-1867); J. Aschbach, *Geschichte Kaiser Sigmunds* (Hamburg, 1838-1845); K. Fischer, *Deutsches Leben und deutsche Zustände von der Hohenstaufenzeit bis ins Reformationsalter* (Gotha, 1884); V. von Kraus, *Deutsche Geschichte im Ausgang des Mittelalters* (Stuttgart, 1898-1905), and A. Bachmann, *Deutsche Reichsgeschichte im Zeitalter Friedrichs III. und Maximilians I.* (Leipzig, 1884-1894).

The two greatest works on the Reformation period are L. von Ranke's *Deutsche Geschichte im Zeitalter der Reformation* (Leipzig, 1882) and J. Janßen's *Geschichte des deutschen Volkes seit dem Ausgang des Mittelalters* (1897-1903). Other works which may be mentioned are: F. B. von Buchholtz, *Geschichte der Regierung Ferdinands I.* (Vienna, 1831-1838); C. Egelhaaf, *Deutsche Geschichte im Zeitalter der Reformation* (Berlin, 1893), and F. von Bezold, *Geschichte der deutschen Reformation* (Berlin, 1890).

For the years after the Reformation we have Ranke, *Zur deutschen Geschichte—Vom Religionsfrieden bis zum 30jährigen Kriege* (Leipzig, 1888); M. Ritter, *Deutsche Geschichte im Zeitalter der Gegenreformation und des dreissigjährigen Krieges* (Stuttgart, 1887, fol.); C. Droysen, *Geschichte der Gegenreformation* (Berlin, 1893); A. Gindely, *Rudolf II. und seine Zeit* (Prague, 1862-1868) and *Geschichte des dreissigjährigen Krieges* (Prague, 1869-1880). Gindely's book is, of course, only one among an enormous number of works on the Thirty Years' War.

For the period leading up to the time of Frederick the Great we have B. Erdmannsdörfer, *Deutsche Geschichte vom Westfälischen Frieden bis zum Regierungsantritt Friedrichs des Grossen* (Berlin, 1802-1893); and then follow Ranke, *Zur Geschichte von Österreich und Preussen zwischen den Friedensschlüssen von Aachen und Hubertusburg* (Leipzig, 1875) and *Die deutschen Mächte und der Fürstenbund*

(Leipzig, 1871-1872); K. Biedermann, *Deutschland im 18. Jahrhundert* (Leipzig, 1854-1880); W. Oncken, *Das Zeitalter Friedrichs des Grossen* (Berlin, 1880-1882); A. von Arneth, *Geschichte Maria Theresias* (Vienna, 1863-1879); L. Häusser, *Deutsche Geschichte vom Tode Friedrichs des Grossen bis zur Gründung des Deutschen Bundes* (Berlin, 1861-1863), and K. T. von Heigel, *Deutsche Geschichte vom Tode Friedrichs des Grossen bis zur Auflösung des alten Reichs* (Stuttgart, 1899, fol.).

For the 19th century we may mention: H. von Treitschke, *Deutsche Geschichte im 19. Jahrhundert* (Leipzig, 1879-1894); H. von Sybel, *Die Begründung des deutschen Reiches durch Wilhelm I.* (Munich, 1889-1894); G. Kaufmann, *Politische Geschichte Deutschlands im 19. Jahrhundert* (Berlin, 1900), and H. von Zwienedeck-Südenhorst, *Deutsche Geschichte von der Auflösung des alten bis zur Gründung des neuen Reiches* (Stuttgart, 1897-1905). These are perhaps the most important, but there are many others of which the following is a selection: K. Fischer, *Die Nation und der Bundestag* (Leipzig, 1880); K. Klüpfel, *Geschichte der deutschen Erhebungsbewegungen bis zur Erfüllung* (Berlin, 1872-1873); H. Blum, *Die deutsche Revolution 1848-1849* (Florence, 1897) and *Das deutsche Reich zur Zeit Bismarcks* (Leipzig, 1893); W. Maurenbrecher, *Gründung des deutschen Reiches* (Leipzig, 1892); H. Friedjung, *Der Kampf um die Vorherrschaft in Deutschland 1850-1866* (Stuttgart, 1897); C. von Kaltenborn, *Geschichte der deutschen Bundesverhältnisse und Einheitsbestrebungen von 1806-1850* (Berlin, 1857); J. Jastrow, *Geschichte des deutschen Einheitsstrahmes und seiner Erfüllung* (Berlin, 1885), and P. Klöppel, *Dreissig Jahre deutscher Verfassungsgeschichte* (Leipzig, 1900).

For the most recent developments of German politics see H. Schulthess, *Europäischer Geschichtskalender* (Nördlingen, 1861, fol., a work similar to the English *Annual Register*); W. Müller and K. Wippermann, *Politische Geschichte der Gegenwart* (Berlin, 1868, fol.); the *Statistisches Jahrbuch des deutschen Reichs*, and A. L. Lowell, *Governments and Parties in Continental Europe* (1896).

A good general history of Germany is the *Bibliothek deutscher Geschichte*, edited by H. von Zwienedeck-Südenhorst (Stuttgart, 1876, fol.). Other general histories, although on a smaller scale, are K. Lamprecht, *Deutsche Geschichte* (Berlin, 1891-1896); O. Kämmler, *Deutsche Geschichte* (Dresden, 1889); K. Biedermann, *Deutsche Volks- und Kulturgeschichte* (Wiesbaden, 1885); T. Lindner, *Geschichte des deutschen Volks* (Stuttgart, 1894); the *Handbuch der deutschen Geschichte*, edited by B. Gebhardt (Stuttgart, 1901), and K. W. Nitzsch, *Geschichte des deutschen Volkes bis zum Augsburger Religionsfrieden* (Leipzig, 1883-1885).

Special reference is deservedly made to three works of the highest value. These are J. G. Droysen's great *Geschichte der preussischen Politik* (Berlin, 1855-1886); the *Deutsche Reichstagsakten*, the first series of which was published at Munich (1867, fol.) and the second at Gotha (1893-1901); and the collection known as the *Regesta imperii*, which owes its existence to the labours of J. F. Böhmner. Nearly the whole of the period between 751 and 1347 is covered by these volumes; the charters and other documents of some of the German kings being edited by Böhmner himself, and new and enlarged editions of certain sections have been brought out by J. Ficker, E. Winkelmann and others. Much useful information on the history of different periods is contained in the lives of individual emperors and others. Among these are H. Prutz, *Kaiser Friedrich I.* (Danzig, 1871-1874); F. W. Schirrmacher, *Kaiser Friedrich II.* (Göttingen, 1859-1865); H. Ullmann, *Kaiser Maximilian I.* (Stuttgart, 1884-1891); F. von Hurter, *Geschichte Kaiser Ferdinands II.* (Schaffhausen, 1857-1864), and H. Blum, *Fürst Bismarck und seine Zeit* (Munich, 1895). There is also the great series of volumes, primary and supplementary, forming the *Allgemeine deutsche Biographie* (Leipzig, 1875, fol.), in which the word *deutsche* is interpreted in the widest possible sense.

Apart from political histories there are useful collections of laws and other official documents of importance, and also a large number of valuable works on the laws and constitutions of the Germans and on German institutions generally. Among the collections are M. Goldast, *Collectio constitutionum imperialis* (1613; new and enlarged edition, 1673); the *Capitulationes imperatorum et regum Romano-Germanorum* (Strassburg, 1851) of Johann Limnäus, and the *Corpus juris Germanici antiqui* (Berlin, 1824) of F. Walter. Collections dealing with more recent history are J. C. Glaser's *Archiv des norddeutschen Bundes. Sammlung aller Gesetze, Verträge und Aktenstücke, die Verhältnisse des norddeutschen Bundes betreffend* (Berlin, 1867); W. Jungermann's *Archiv des deutschen Reiches* (Berlin, 1873, fol.), and the *Acta Borussiaica. Denkmäler der preussischen Staatsverwaltung im 18. Jahrhundert* (Berlin, 1892, fol.). Mention may also be made of C. C. Homeyer's edition of the *Sachsenspiegel* and L. A. von Lassberg's edition of the *Schwabenspiegel*; the many volumes of Wallenstein's letters and papers; the eighteen volumes of the *Urkunden und Aktenstücke zur Geschichte des Kurfürsten Friedrich Wilhelm von Brandenburg* (Berlin, 1864, fol.); and the thirty volumes of the *Politische Korrespondenz Friedrichs des Grossen* (Berlin, 1879-1905). Modern writers on these subjects distinguished for their learning are G. Waitz (*Deutsche Verfassungsgeschichte*, Kid and Berlin, 1844, fol.) and G. L. von Maurer (*Geschichte der Städteverfassung in Deutschland*, Erlangen, 1869-1871, and other cognate writings), their works being valuable not only for the early institutions

of the Germans, but also for those of other Teutonic peoples. Other works on the German constitution and German laws are K. F. Eichhorn, *Deutsche Staats- und Rechtsgeschichte* (Göttingen, 1843-1844); R. Schröder, *Lehrbuch der deutschen Rechtsgeschichte* (Leipzig, 1889 and again 1902); H. Brunner, *Deutsche Rechtsgeschichte* (Leipzig, 1887-1892); and *Grundzüge der deutschen Rechtsgeschichte* (Leipzig, 1901-1903); and E. Mayer, *Deutsche und französische Verfassungsgeschichte von 9-11. Jahrhundert* (Leipzig, 1899).

Manners and customs are dealt with in J. Scherr's *Deutsche Kultur- und Sittengeschichte* (Leipzig, 1852-1853); J. Lippert's *Deutsche Sitten- und Lebensgeschichte* (Vienna and Prague, 1889); O. Henne am Rhyu's *Kulturgeschichte des deutschen Volkes* (Berlin, 1886); *Die Geschichte des deutschen Volkes und seiner Kultur im Mittelalter* (Leipzig, 1891-1898) of H. Gerdes, and F. von Löhner's *Kulturgeschichte der Deutschen im Mittelalter* (Munich, 1891-1894). Among the works on husbandry may be mentioned: K. Bücher, *Die Entstehung der Volkswirtschaft* (Tübingen, 1893); K. T. von Inama-Sternegg, *Deutsche Wirtschaftsgeschichte* (Leipzig, 1879-1901), and K. Lamprecht, *Deutsches Wirtschaftsleben im Mittelalter* (Leipzig, 1886). For antiquities see M. Heyne, *Fünf Bücher deutscher Hausaltertümer von den ältesten geschichtlichen Zeiten bis zum 16. Jahrhundert* (Leipzig, 1899-1903); and L. Lindenschmit, *Handbuch der deutschen Altertumskunde* (Brunswick, 1880-1889). For the history of the German church see A. Hauck, *Kirchengeschichte Deutschlands* (Leipzig, 1887-1903); F. W. Kottberg, *Kirchengeschichte Deutschlands* (Göttingen, 1846-1848), and J. Friedrich, *Kirchengeschichte Deutschlands* (Bamberg, 1867-1869). For finance see K. D. Hüllmann, *Deutsche Finanzgeschichte des Mittelalters* (1895); for the administration of justice, O. Franklin, *Das Reichsgericht im Mittelalter* (Weimar, 1867-1869), and A. Stölzel, *Die Entwicklung des gelehrten Richteramt in deutschen Territorien* (Stuttgart, 1872); for the towns and their people see J. Jastrow, *Die Volkswirtschaft deutscher Städte zu Ende des Mittelalters und zu Beginn der Neuzeit* (Berlin, 1886); F. W. Barthold, *Geschichte der deutschen Städte und des deutschen Bürgertums* (Leipzig, 1850-1854), and K. Hegel, *Städte und Gilden der germanischen Völker im Mittelalter* (Leipzig, 1891); and for manufactures and commerce see J. Falke, *Die Geschichte des deutschen Handels* (Leipzig, 1859-1860); H. A. Mascher, *Das deutsche Gewerbeleben von der frühesten Zeit bis auf die Gegenwart* (Potsdam, 1866); F. W. Stahl, *Das deutsche Handwerk* (Giessen, 1874); the numerous writings on the history of the Hanseatic League and other works. The nobles and the other social classes have each their separate histories, among these being C. F. F. von Strantz, *Geschichte des deutschen Adels* (Breslau, 1845), and K. H. Roth von Schreckenstein, *Die Ritterwürde und der Ritterstand* (Freiburg, 1866).

The Germans have produced some excellent historical atlases, among them K. von Spruner's *Historisch-geographischer Handatlas* (Gotha, 1853); a new edition of this by T. Menke called *Handatlas für die Geschichte des Mittelalters und der neueren Zeit* (Gotha, 1880), and G. Droysen's *Allgemeiner historischer Handatlas* (Leipzig, 1886). The historical geography of Germany is dealt with in B. Knöll's *Historische Geographie Deutschlands im Mittelalter* (Breslau, 1903); in F. H. Müller's *Die deutschen Stämme und ihre Fürsten* (Hamburg, 1852), and in many other works referring to the different parts of the country.

English books on the history of Germany are not very numerous. There is a short *History of Germany* by James Sims (1874), another by E. F. Henderson (1902), and *A History of Germany 1715-1815* by C. T. Atkinson (1900). H. A. L. Fisher's *Medieval Empire* (1898) is very useful for the earlier period, and J. Bryce's *Holy Roman Empire* is indispensable. There is a translation of Janssen's *Geschichte* by M. A. Mitchell and A. M. Christie (1896, fol.), and there are useful chapters in the different volumes of the *Cambridge Modern History*. Two English historians have distinguished themselves by their work on special periods: Carlyle with his *History of Friedrich II., called the Great* (1872-1873), and W. Robertson with his *History of the Reign of Charles V.* (1829). There is also E. Armstrong's *Charles V.* (London, 1902). Among German historical periodicals are the *Historische Zeitschrift*, long associated with the name of H. von Sybel, and the *Historisches Jahrbuch*.

In guides to the historical sources and to modern historical works Germany is well served. There is the *Quellenkunde der deutschen Geschichte* (Leipzig, 1906) of Dahlmann-Waitz, a most compendious volume, and the learned *Deutschlands Geschichtsquellen im Mittelalter* (Berlin, 1893-1894) of W. Wattenbach; A. Pottast's *Bibliotheca historica mediæ ævi* (Berlin, 1896), and the *Deutschlands Geschichtsquellen seit der Mitte des 13. Jahrhunderts* (Berlin, 1886-1887) of O. Lorenz and A. Goldmann. (A. W. H. *)

GERMERSHEIM, a fortified town of Germany in Rhenish Bavaria, at the confluence of the Queich and the Rhine, 8 m. S.W. of Speyer. Pop. (1905) 5914. It possesses a Roman Catholic and an Evangelical church, a synagogue, a progymnasium and a hospital. The industries include fishing, shipbuilding and brewing. GERMERSHEIM existed as a Roman stronghold under the name of *Vicus Julius*. The citadel was rebuilt by the emperor Conrad II., but the town itself was founded in 1276 by the emperor Rudolph I., who granted it the rights of a free imperial city.

From 1330 to 1622, when it was conquered by Austria, the town formed part of the Palatinate of the Rhine. From 1644 to 1650 it was in the possession of France; but on the conclusion of the peace of Westphalia it was again joined to the Palatinate. In 1674 it was captured and devastated by the French under Turenne, and after the death of the elector Charles (1685) it was claimed by the French as a dependency of Alsace. As a consequence there ensued the disastrous GERMERSHEIM war of succession, which lasted till the peace of Ryswick in 1697. Through the intervention of the pope in 1702, the French, on payment of a large sum, agreed to vacate the town, and in 1715 its fortifications were rebuilt. On the 3rd of July 1744 the French were defeated there by the imperial troops, and on the 19th and 22nd of July 1793 by the Austrians. In 1835 the new town was built, and the present fortifications begun. See Probst, *Geschichte der Stadt und Festung GERMERSHEIM* (Speyer, 1898).

GERMISTON, a town of the Transvaal, 9 m. E. of Johannesburg. Pop. of the municipality (1904) 29,477, of whom 9123 were whites. It lies 5478 ft. above the sea, in the heart of the Witwatersrand gold-mining district, and is an important railway junction. The station, formerly called Elahdsfontein Junction, is the meeting-point of lines from the ports of the Cape and Natal, and from Johannesburg, Pretoria and Delagoa Bay. Though possessing a separate municipality, Germiston is practically a suburb of Johannesburg (q.v.).

GERMONIUS, ANASTASIUS [ANASTASE GERMON] (1551-1627), canon lawyer, diplomatist and archbishop of Tarantaise, belonged to the family of the marquises of Ceve, in Piedmont, where he was born. As archdeacon at Turin he was a member of the commission appointed by Pope Clement VIII. to edit the *Liber septimus decretalium*; and he also wrote *Paratita* on the five books of the *Decretals of Gregory IX.* He represented the duke of Savoy at the court of Rome under Clement VIII. and Paul V., and was ambassador to Spain under Kings Philip III. and IV. He died on the 4th of August 1627. Germonius is best known for his treatise on ambassadors, *De legatis principum et populorum libri tres* (Rome, 1627). The book is diffuse, pedantic and somewhat heavy in style, but valuable historically as written by a theorist who was also an expert man of affairs. (See DIPLOMACY.)

GERO (c. 900-965), margrave of the Saxon east mark, was probably a member of an influential Saxon family. In 937 he was entrusted by the German king Otto, afterwards the emperor Otto the Great, with the defence of the eastern frontier of Saxony against the Wends and other Slavonic tribes; a duty which he discharged with such ability and success that in a few years he extended the Saxon frontier almost to the Oder, and gained the chief credit for the suppression of a rising of the conquered peoples in a great victory on the 16th of October 955. In 963 he defeated the Lusatians, compelled the king of the Poles to recognize the supremacy of the German king, and extended the area of his mark so considerably that after his death it was partitioned into three, and later into five marks. Gero, who is said to have made a journey to Rome, died on the 20th of May 965, and was buried in the convent of Gerrode which he had founded on his Saxon estates. He is referred to by the historian Widukind as a *preses*, and is sometimes called the "great margrave." He has been accused of treachery and cruelty, is celebrated in song and story, and is mentioned as the "margrave Gère" in the *Nibelungenlied*.

See Widukind, "Res gestæ Saxonicae," in the *Monumenta Germaniæ historica. Scriptores*, Band iii.; O. von Heinemann, *Markgraf Gero* (Brunswick, 1860).

GEROLSTEIN, a village and climatic health resort of Germany, in the Prussian Rhine Province, attractively situated on the Kyll, in the Eifel range, 1100 ft. above the sea, 58 m. W. of Andernach by rail, and at the junction of lines to Trèves and St. Vith. The castle of Gerolstein, built in 1115 and now in ruins, affords a fine view of the Kyllthal. Gerolstein is celebrated for its lithia waters, which are largely exported. Pop. (1900) 1308.

GÉRÔME, JEAN LÉON (1824-1904), French painter, was born on the 11th of May 1824, at Vesoul (Haute-Saône). He went to Paris in 1841 and worked under Paul Delaroche, whom he

accompanied to Italy (1844-1845). On his return he exhibited "The Cock-fight," which gained him a third-class medal in the Salon of 1847. "The Virgin with Christ and St John" and "Anacreon, Bacchus and Cupid" took a second-class medal in 1848. He exhibited "Bacchus and Love, Drunk," a "Greek Interior" and "Souvenir d'Italie," in 1851; "Paestum" (1852); and "An Idyll" (1853). In 1854 Gérôme made a journey to Turkey and the shores of the Danube, and in 1857 visited Egypt. To the exhibition of 1855 he contributed a "Pifferaro," a "Shepherd," "A Russian Concert" and a large historical canvas, "The Age of Augustus and the Birth of Christ." The last was somewhat confused in effect, but in recognition of its consummate ability the State purchased it. Gérôme's reputation was greatly enhanced at the Salon of 1857 by a collection of works of a more popular kind: the "Duel: after a Masquerade," "Egyptian Recruits crossing the Desert," "Memnon and Sesostris" and "Camels Watering," the drawing of which was criticized by Edmond About. In "Caesar" (1859) Gérôme tried to return to a severer class of work, but the picture failed to interest the public. "Phryne before the Areopagus," "Le Roi Candaule" and "Socrates finding Alcibiades in the House of Aspasia" (1861) gave rise to some scandal by reason of the subjects selected by the painter, and brought down on him the bitter attacks of Paul de Saint-Victor and Maxime Ducamp. At the same Salon he exhibited the "Egyptian chopping Straw," and "Rembrandt biting an Etching," two very minutely finished works. Gérôme's best paintings are of Eastern subjects; among these may be named the "Turkish Prisoner" and "Turkish Butcher" (1863); "Prayer" (1865); "The Slave Market" (1867); and "The Harem out Driving" (1869). He often illustrated history, as in "Louis XIV. and Molière" (1863); "The Reception of the Siamese Ambassadors at Fontainebleau" (1865); and the "Death of Marshal Ney" (1868). Gérôme was also successful as a sculptor; he executed, among other works, "Omphale" (1887), and the statue of the duc d'Aumale which stands in front of the château of Chantilly (1899). His "Bellona" (1892), in ivory, metal, and precious stones, which was also exhibited in the Royal Academy of London, attracted great attention. The artist then began an interesting series of "Conquerors" wrought in gold, silver and gems—"Bonaparte entering Cairo" (1897); "Tamerlane" (1898); and "Frederick the Great" (1899). Gérôme was elected member of the Institut in 1865. He died in 1904.

GERONA, a maritime frontier province in the extreme north-east of Spain, formed in 1833 of districts taken from Catalonia, and bounded on the N. by France, E. and S.E. by the Mediterranean Sea, S.W. and W. by Barcelona, and N.W. by Lérida. Pop. (1900) 299,287; area, 2264 sq. m. In the north-west a small section of the province, with the town of Llívia, is entirely isolated and surrounded by French territory; otherwise Gerona is separated from France by the great range of the Pyrenees. Its general aspect is mountainous, especially in the western districts. Most of the lower chains are covered with splendid forests of oak, pine and chestnut. There are comparatively level tracts of arable land along the lower course of the three main rivers—the Ter, Muga and Fluvià, which rise in the Pyrenees and flow in a south-easterly direction to the sea. The coast-line is not deeply indented, but includes one large bay, the Gulf of Rosas. Its two most conspicuous promontories, Capes Creus and Bagur, are the easternmost points of the Iberian Peninsula. The climate is generally temperate and rainy during several months in the valleys and near the coast, but cold in the Cerdana district and other mountainous regions during eight months, while Gerona, La Bisbal and Santa Coloma are quite Mediterranean in their hot summers and mild winters. Agriculture is backward, but there are profitable fisheries and fish-curing establishments along the whole seaboard, notably at the ports of Llansó, Rosas, Palamós, San Feliu de Guixols and Blanes. Next in importance is the cork industry at San Feliu de Guixols, Palafrugell and Cassà. More than one hundred mineral springs are scattered over the province, and in 1903 twenty mines were at work, although their total output, which included antimony,

coal, copper, lead, iron and other ores, was valued at less than £7000. There are also important hydraulic cement and ochre works, and no fewer than twenty-two of the towns are centres of manufactures of linen, cotton, woollen stuffs, paper, cloth, leather, steel and furniture. The commerce of the province is important, Port Bou (or Portbou) being, after Irun, the most active outlet for the trade by railway not only with France but with the rest of the continent. The main railway from Barcelona to France runs through the province, and several branch railways, besides steam and electric tramways, connect the principal towns. Gerona, the capital (pop. 1900, 15,781, and Figueras (10,714), long a most important frontier fortress, are described in separate articles; the only other towns with more than 7000 inhabitants are San Feliu de Guixols (11,333), Olot (7938) and Palafrugell (7087). The inhabitants of the province are, like most Catalans, distinguished for their enterprise, hardiness and keen local patriotism; but emigration, chiefly to Barcelona, kept their numbers almost stationary during the years 1875-1905. The percentage of illegitimate births (1.5) is lower than in any other part of Spain. (See also CATALUNYA.)

GERONA, the capital of the province of Gerona, in north-eastern Spain, on the railway from Barcelona to Perpignan in France, and on the right bank of the river Ter, at its confluence with the Oña, a small right-hand tributary. Pop. (1900) 15,787. The older part of the town occupies the steep slope of the Montjuich, or Hill of the Capuchins, and with its old-fashioned buildings presents a picturesque appearance against a background of loftier heights; the newer portion stretches down into the plain and beyond the Oña, which is here crossed by a bridge of three arches. The old city walls and their bastions still remain, though in a dilapidated state; and the hill is crowned by what were at one time very strong fortifications, now used as a prison. Gerona is the seat of a bishop, has a seminary, a public library and a theatre, and carries on the manufacture of paper and cotton and woollen goods. Its churches are of exceptional interest. The cathedral is one of the grandest specimens of Gothic architecture in Spain, the nave being the widest pointed vault in Christendom, as it measures no less than 73 ft. from side to side, while Albi, the next in size, is only 53 ft., and Westminster Abbey is only 38. The old cathedral on the same site was used as a mosque by the Moors, and on their expulsion in 1015 it appears to have been very greatly modified, if not entirely rebuilt. During the 14th century new works were again carried out on an extensive scale, but it was not till the beginning of the 15th that the proposal to erect the present magnificent nave was originated by the master of the works, Guillermo Boffiy. The general appearance of the exterior is rather ungainly, but there is a fine approach by a flight of 86 steps to the façade, which rises in tiers and terminates in an oval rose-window. Among the tombs may be mentioned those of Bishop Berenger or Berenguer (d. 1408), Count Ramon Berenguer II. (d. 1082) and the countess Ermesinda (d. 1057). The collegiate church of San Feliu (St Felix) is mainly of the 14th century, but it was considerably modified in the 16th, and its façade dates from the 18th. It is one of the few Spanish churches that can boast of a genuine spire, and it thus forms a striking feature in the general view of the town. The Benedictine church of San Pedro de Galligans (or de los Gallos) is an interesting Romanesque building of early date. It is named from the small river Galligans, an affluent of the Oña, which flows through the city. In the same neighbourhood is a small church worthy of notice as a rare Spanish example of a transverse triapsal plan.

Gerona is the ancient Gerunda, a city of the Ausetani. It claims to be the place in which St Paul and St James first rested when they came to Spain; and it became the see of a bishop about 247. For a considerable period it was in the hands of the Moors, and their emir, Suleiman, was in alliance with Pippin the Short, king of the Franks, about 750. It was taken by Charlemagne in 785; but the Moors regained and sacked it in 795, and it was not till 1015 that they were finally expelled. At a later date it gave the title of count to the king of Aragon's eldest son. It has been besieged no fewer than twenty-five times in all, and only four

of the sieges have resulted in its capture. The investment by the French under Marshal Hocquincourt in 1653, that of 1684 by the French under Marshal Bellefonds, and the successful enterprise of Marshal Noailles in 1694 are the three great events of its history in the 17th century. Surrendered by the French at the peace of Ryswick, it was again captured by the younger Marshal Noailles in 1706, after a brilliant defence; and in 1717 it held out against the Austrians. But its noblest resistance was yet to be made. In May 1809 it was besieged by the French, with 35,000 troops, under J. A. Verdier, P. F. Augereau and Gouvion St Cyr; forty batteries were erected against it and a heavy bombardment maintained; but under the leadership of Mariano Alvarez de Castro it held out till famine and fever compelled a capitulation on the 12th of December. The French, it is said, had spent 20,000 bombs and 60,000 cannon balls, and their loss was estimated at 15,000 men.

See Juan Gaspar Roig y Jalpi, *Resumen de las Grandezas, &c.* (Barcelona, 1678); J. A. Nieto y Samaniego, *Memorias* (Tarragona, 1810); G. E. Street, *Gothic Architecture in Spain* (London, 1869).

GEROUSIA (Gr. *γερουσία*, Doric *γερουσία*), the ancient council of elders at Sparta, corresponding in some of its functions to the Athenian Boule. In historical times it numbered twenty-eight members, to whom were added *ex officio* the two kings and, later, the five ephors. Candidates must have passed their sixtieth year, i.e. they must no longer be liable to military service, and they were possibly restricted to the nobility. Vacancies were filled by the Apella, that candidate being declared elected whom the assembly acclaimed with the loudest shouts—a method which Aristotle censures as childish (*Polit.* ii. 9, p. 1271 a 9). Once elected, the *gerontes* held office for life and were irresponsible. The functions of the council were among the most important in the state. It prepared the business which was to be submitted to the Apella, and was empowered to set aside, in conjunction with the kings, any "crooked" decision of the people. Together with the kings and ephors it formed the supreme executive committee of the state, and it exercised also a considerable criminal and political jurisdiction, including the trial of kings; its competence extended to the infliction of a sentence of exile or even of death. These powers, or at least the greater part of them, were transferred by Cleomenes III. to a board of *patronomi* (Pausanias ii. 9. 1); the *gerousia*, however, continued to exist at least down to Hadrian's reign, consisting of twenty-three members annually elected, but eligible for re-election (*Sparta Museum Catalogue*, Nos. 210, 612 and Introduction § 17).

Fuller discussions of the *gerousia* will be found in Aristotle, *Politics*, ii. 9, 17-19; Plutarch, *Lycurgus*, 5, 26; G. F. Schömann, *Antiquities of Greece; The State* (Eng. trans.), p. 230 ff.; G. Gilbert, *Constitutional Antiquities of Sparta and Athens* (Eng. trans.), p. 47 ff.; C. O. Müller, *History and Antiquities of the Doric Race* (Eng. trans.), iii. c. 6, §§ 1-3; G. Busolt, *Die griechischen Staats- und Rechtsaltertümer* (Iwan Müller's *Handbuch der klassischen Altertumswissenschaft*, iv. 1), § 89; *Griechische Geschichte*, 2te Auflage i. 550 ff.; A. H. J. Greenidge, *Handbook of Greek Constitutional History*, 100 ff.; H. Gabriel, *De magistratibus Lacedaemoniorum*, 31 ff. (M. N. T.)

GERRESHEIM, a town of Germany, in the Prussian Rhine Province, 6 m. by rail E. of Düsseldorf. It contains a fine Romanesque church, dating from the 13th century, which forms a portion of an ancient nunnery (founded in the 10th century and secularized in 1806), and has extensive glass manufactures and wire factories. Pop. (1905) 14,434.

GERRHA (Arab. *al-Jar'a*), an ancient city of Arabia, on the west side of the Persian Gulf, described by Strabo (Bk. xvi.) as inhabited by Chaldean exiles from Babylon, who built their houses of salt and repaired them by the application of salt water. Pliny (*Hist. Nat.* vi. 32) says it was 5 m. in circumference with towers built of square blocks of salt. Various identifications of the site have been attempted, J. P. B. D'Anville choosing El Katif, C. Niebuhr preferring Kuwet and C. Forster suggesting the ruins at the head of the bay behind the islands of Bahrein.

See A. Sprenger, *Die alte Geographie Arabiens* (Bern, 1875), pp. 135-137.

GERRÚS, a small province of Persia, situated between Khamsch and Azerbaïjan in the N., Kurdistan in the W. and Hamadan in the S. Its population is estimated at 80,000, and its capital, Bijár, 180 m. from Hamadan, has a population of

about 4000 and post and telegraph offices. The province is fief of the chief of the Gerrús Kurds, pays a yearly revenue of about £3000, and supplies a battalion of infantry (the 34th) to the army.

GERRY, ELBRIDGE (1744-1814), American statesman, was born in Marblehead, Massachusetts, on the 17th of July 1744, the son of Thomas Gerry (d. 1774), a native of Newton, England, who emigrated to America in 1730, and became a prosperous Marblehead merchant. The son graduated at Harvard in 1762 and entered his father's business. In 1772 and 1773 he was a member of the Massachusetts General Court, in which he identified himself with Samuel Adams and the patriot party, and in 1773 he served on the Committee of Correspondence, which became one of the great instruments of intercolonial resistance. In 1774-1775 he was a member of the Massachusetts Provincial Congress. The passage of a bill proposed by him (November 1775) to arm and equip ships to prey upon British commerce, and for the establishment of a prize court, was, according to his biographer, Austin, "the first actual avowal of offensive hostility against the mother country, which is to be found in the annals of the Revolution." It is also noteworthy, says Austin, as "the first effort to establish an American naval armament." From 1776 to 1781 Gerry was a member of the Continental Congress, where he early advocated independence, and was one of those who signed the Declaration after its formal signing on the 2nd of August 1776, at which time he was absent. He was active in debates and committee work, and for some time held the chairmanship of the important standing committee for the superintendence of the treasury, in which capacity he exercised a predominant influence on congressional expenditures. In February 1780 he withdrew from Congress because of its refusal to respond to his call for the yeas and nays. Subsequently he laid his protest before the Massachusetts General Court which voted its approval of his action. On his return to Massachusetts, and while he was still a member of Congress, he was elected under the new state constitution (1780) to both branches of the state legislature, but accepted only his election to the House of Representatives. On the expiration of his congressional term, he was again chosen a delegate by the Massachusetts legislature, but it was not until 1783 that he resumed his seat. During the second period of his service in Congress, which lasted until 1785, he was a member of the committee to consider the treaty of peace with Great Britain, and chairman of two committees appointed to select a permanent seat of government. In 1784 he bitterly attacked the establishment of the order of the Cincinnati on the ground that it was a dangerous menace to democratic institutions. In 1786 he served in the state House of Representatives. Not favouring the creation of a strong national government he declined to attend the Annapolis Convention in 1786, but in the following year, when the assembling of the Constitutional Convention was an assured fact, although he opposed the purpose for which it was called, he accepted an appointment as one of the Massachusetts delegates, with the idea that he might personally help to check too strong a tendency toward centralization. His exertions in the convention were ceaseless in opposition to what he believed to be the wholly undemocratic character of the instrument, and eventually he refused to sign the completed constitution. Returning to Massachusetts, he spoke and wrote in opposition to its ratification, and although not a member of the convention called to pass upon it, he laid before this convention, by request, his reasons for opposing it, among them being that the constitution contained no bill of rights, that the executive would unduly influence the legislative branch of the government, and that the judiciary would be oppressive. Subsequently he served as an Anti-Federalist in the national House of Representatives in 1789-1793, taking, as always, a prominent part in debates and other legislative concerns. In 1797 he was sent by President John Adams, together with John Marshall and Charles Cotesworth Pinckney, on a mission to France to obtain from the government of the Directory a treaty embodying a settlement of several long-standing disputes. The discourteous and underhanded treatment of this embassy by Talleyrand and his agents.

archbishop and grand inquisitor, and his book had been publicly burned before the cathedral of Notre Dame. Gerson wished a council to confirm this sentence. His literary labours were as untiring as ever. He maintained in a series of tracts that a general council could depose a pope; he drew up indictments against the reigning pontiffs, reiterated the charges against Jean Petit, and exposed the sin of schism—in short, he did all he could to direct the public mind towards the evils in the church and the way to heal them. His efforts were powerfully seconded by the emperor Sigismund, and the result was the council of Constance (see CONSTANCE, COUNCIL OF). Gerson's influence at the council was supreme up to the election of a new pope. It was he who dictated the form of submission and cession made by John XXIII., and directed the process against Huss. Many of Gerson's biographers have found it difficult to reconcile his proceedings against Huss with his own opinions upon the supremacy of the pope; but the difficulty has arisen partly from misunderstanding Gerson's position; partly from supposing him to be the author of a famous tract—*De modis uniendi ac reformandi Ecclesiam in concilio universali*. All Gerson's high-sounding phrases about the supremacy of a council were meant to apply to some time of emergency. He was essentially a trimmer, and can scarcely be called a reformer, and he hated Huss with all the hatred the trimmer has of the reformer. The three bold treatises, *De necessitate reformationis Ecclesiae*, *De modis uniendi ac reformandi Ecclesiam*, and *De difficultate reformationis in concilio universali*, long ascribed to Gerson, were proved by Schwab in his *Johannes Gerson* not to be his work, and have since been ascribed to Abbot Andreas of Randuf, and with more reason to Dietrich of Nicheim (see NIEM, DIETRICH OF).

The council of Constance, which revealed the eminence of Gerson, became in the end the cause of his downfall. He was the prosecutor in the case of Jean Petit, and the council, overawed by the duke of Burgundy, would not affirm the censure of the university and archbishop of Paris. Petit's justification of murder was declared to be only a moral and philosophical opinion, not of faith. The utmost length the council would go was to condemn one proposition, and even this censure was annulled by the new pope, Martin V., on a formal pretext. Gerson dared not return to France, where, in the disturbed state of the kingdom, the duke of Burgundy was in power. He lay hid for a time at Constance and then at Rattenberg in Tirol, where he wrote his famous book *De consolatioe theologiae*. On returning to France he went to Lyons, where his brother was prior of the Celestines. It is said that he taught a school of boys and girls in Lyons, and that the only fee he exacted was to make the children promise to repeat the prayer, "Lord, have mercy on thy poor servant Gerson." His later years were spent in writing books of mystical devotion and hymns. He died at Lyons on the 12th of July 1429. Tradition declares that during his sojourn there he translated or adapted from the Latin a work upon eternal consolation, which afterwards became very famous under the title of *The Imitation of Christ*, and was attributed to Thomas à Kempis. It has, however, been proved beyond a doubt that the famous *Imitatio Christi* was really written by Thomas, and not by John Gerson or the abbot Gerson.

The literature on Gerson is very abundant. See Dupin, *Gersoniana*, including *Vita Gersoni*, prefixed to the edition of Gerson's works in 5 vols. fol., from which quotations have here been made; Charles Schmidt, *Essai sur Jean Gerson, chancelier de l'Université de Paris* (Strassburg, 1839); J. B. Schwab, *Johannes Gerson* (Würzburg, 1859); H. Jadart, *Jean Gerson, son origine, son village natal et sa famille* (Reims, 1882). On the relations between Gerson and D'Ailly see Paul Tschackert, *Peter von Ailly* (Gotha, 1877). On Gerson's public life see also histories of the councils of Pisa and Constance, especially Herm. v. der Hardt, *Con. Constantiensis libri iv.* (1695-1699). The best editions of his works are those of Paris (3 vols., 1606) and Antwerp (5 vols., 1706). See also Ulysse Chevalier, *Répertoire des sources hist. Bio-bibliographie* (Paris, 1905, &c.), s.v. "Gerson." (T. M. L.: X.)

GERSONIDES, or **GEN GERSÓN** (**GERSHON**), **LEVI**, known also as **RALBAG** (1288-1344), Jewish philosopher and commentator, was born at Bagnols in Languedoc, probably in 1288. As in the case of the other medieval Jewish philosophers little is known

of his life. His family had been distinguished for piety and exegetical skill, but though he was known in the Jewish community by commentaries on certain books of the Bible, he never seems to have accepted any rabbinical post. Possibly the freedom of his opinions may have put obstacles in the way of his preferment. He is known to have been at Avignon and Orange during his life, and is believed to have died in 1344, though Zacuto asserts that he died at Perpignan in 1370. Part of his writings consist of commentaries on the portions of Aristotle then known, or rather of commentaries on the commentaries of Averroes. Some of these are printed in the early Latin editions of Aristotle's works. His most important treatise, that by which he has a place in the history of philosophy, is entitled *Milhamot 'Adonai* (The Wars of God), and occupied twelve years in composition (1317-1329). A portion of it, containing an elaborate survey of astronomy as known to the Arabs, was translated into Latin in 1342 at the request of Clement VI. The *Milhamot* is throughout modelled after the plan of the great work of Jewish philosophy, the *Moreh Nebukim* of Moses Maimonides, and may be regarded as an elaborate criticism from the more philosophical point of view (mainly Averroistic) of the syncretism of Aristotelianism and Jewish orthodoxy as presented in that work. The six books pass in review (1) the doctrine of the soul, in which Gersonides defends the theory of impersonal reason as mediating between God and man, and explains the formation of the higher reason (or acquired intellect, as it was called) in humanity,—his view being thoroughly realist and resembling that of Avicenna; (2) prophecy; (3) and (4) God's knowledge of facts and providence, in which is advanced the curious theory that God does not know individual facts, and that, while there is general providence for all, special providence only extends to those whose reason has been enlightened; (5) celestial substances, treating of the strange spiritual hierarchy which the Jewish philosophers of the middle ages accepted from the Neoplatonists and the pseudo-Dionysius, and also giving, along with astronomical details, much of astrological theory; (6) creation and miracles, in respect to which Gersonides deviates widely from the position of Maimonides. Gersonides was also the author of a commentary on the Pentateuch and other exegetical and scientific works.

A careful analysis of the *Milhamot* is given in Rabbi Isidore Weil's *Philosophie religieuse de Levi-Ben-Gerson* (Paris, 1868). See also Munk, *Mélanges de phil. juive et arabe*; and Joel, *Religions-philosophie d. L. Ben-Gerson* (1862). The *Milhamot* was published in 1560 at Riva di Trento, and has been published at Leipzig, 1866. (L. A.)

GERSOPPA, FALLS OF, a cataract on the Sharavati river in the North Kanara district of Bombay. The falls are considered the finest in India. The river descends in four separate cascades called the Raja or Horseshoe, the Roarer, the Rocket and the Dame Blanche. The cliff over which the river plunges is 830 ft. high, and the pool at the base of the Raja Fall is 132 ft. deep. The falls are reached by boat from Honavar, or by road from Gersoppa village, 18 m. distant. Near the village are extensive ruins (the finest of which is a cruciform temple) of Nagrabastikere, the capital of the Jain chiefs of Gersoppa. Their family was established in power in 1409 by the Vijayanagar kings, but subsequently became practically independent. The chieftaincy was several times held by women, and on the death of the last queen (1608) it collapsed, having been attacked by the chief of Bednur. Among the Portuguese the district was celebrated for its pepper, and they called its queen "Regina da pimenta" (queen of pepper).

GERSTÄCKER, FRIEDRICH (1816-1872), German novelist and writer of travels, was born at Hamburg on the 10th of May 1816, the son of Friedrich Gerstäcker (1790-1825), a celebrated opera singer. After being apprenticed to a commercial house he learnt farming in Saxony. In 1837, however, having imbibed from *Robinson Crusoe* a taste for adventure, he went to America and wandered over a large part of the United States, supporting himself by whatever work came to hand. In 1843 he returned to Germany, to find himself, to his great surprise, famous as an author. His mother had shown his diary, which he regularly

sent home, and which contained descriptions of his adventures in the New World, to the editor of the *Rosen*, who published them in that periodical. These sketches having found favour with the public, Gerstäcker issued them in 1844 under the title *Streif- und Jagdsüge durch die Vereinigten Staaten Nordamerikas*. In 1845 his first novel, *Die Regulatoren in Arkansas*, appeared, and henceforth the stream of his productiveness flowed on uninterruptedly. From 1849 to 1852 Gerstäcker travelled round the world, visiting North and South America, Polynesia and Australia, and on his return settled in Leipzig. In 1860 he again went to South America, chiefly with a view to inspecting the German colonies there and reporting on the possibility of diverting the stream of German emigration in this direction. The result of his observations and experiences he recorded in *Achtzehn Monate in Südamerika* (1862). In 1862 he accompanied Duke Ernest of Saxe-Coburg-Gotha to Egypt and Abyssinia, and on his return settled at Coburg, where he wrote a number of novels descriptive of the scenes he had visited. In 1867-1868 Gerstäcker again undertook a long journey, visiting North America, Venezuela and the West Indies, and on his return lived first at Dresden and then at Brunswick, where he died on the 31st of May 1872. His genial and straightforward character made him personally beloved; and his works, dealing as they did with the great world hitherto hidden from the narrow "parochialism" of German life, obtained an immense popularity. This was not due to any graces of style, in which they are singularly lacking; but the unstudied freshness of the author's descriptions, and his sturdy humour, appealed to the wholesome instincts of the public. Many of his books were translated into foreign languages, notably into English, and became widely known on both sides of the Atlantic. His best works, from a literary point of view, are, besides the above-mentioned *Regulatoren*, his *Flusspiraten des Mississippi* (1848); the novel *Tahiti* (1854); his Australian romance *Die beiden Ströfinge* (1857); *Aus dem Matrosenleben* (1857); and *Blau Wasser* (1858). His *Travels* exist in an English translation.

Gerstäcker's *Gesammelte Schriften* were published at Jena in 44 vols. (1872-1879); a selection, edited by D. Theden in 24 vols. (1889-1890). See A. Karl, *Friedrich Gerstäcker, der Weisgerichte. Ein Lebensbild* (1873).

GERSTENBERG, HEINRICH WILHELM VON (1737-1823), German poet and critic, was born at Tondern in Schleswig on the 3rd of January 1737. After studying law at Jena he entered the Danish military service and took part in the Russian campaign of 1762. He spent the next twelve years in Copenhagen, where he was intimate with Klopstock. From 1775 to 1783 he represented Denmark's interests as "Danish Resident" at Lübeck, and in 1786 received a judicial appointment at Altona, where he died on the 1st of November 1823. In the course of his long life Gerstenberg passed through many phases of his nation's literature. He began as an imitator of the Anacreontic school (*Tändelciem*, 1759); then wrote, in imitation of Gleim, *Kriegslieder eines dänischen Grenadiers* (1762); with his *Gedicht eines Skalden* (1766) he joined the group of "bards" led by Klopstock. His *Ariadne auf Naxos* (1767) is the best cantata of the 18th century; he translated Beaumont and Fletcher's *Maid's Tragedy* (1767), and helped to usher in the *Sturm und Drang* period with a gruesome but powerful tragedy, *Ugolino* (1768). But he did perhaps even better service to the new literary movement with his *Briefe über Merkwürdigkeiten der Literatur* (1766-1770), in which the critical principles of the *Sturm und Drang*—and especially its enthusiasm for Shakespeare,—were first definitely formulated. In later life Gerstenberg lost touch with literature, and occupied himself mainly with Kant's philosophy.

His *Vermischte Schriften* appeared in 3 vols. (1815). The *Briefe über Merkwürdigkeiten der Literatur* were republished by A. von Weilen (1888), and a selection of his poetry, including *Ugolino*, by R. Hamel, will be found in Kürschner's *Deutsche Nationalliteratur*, vol. 48 (1884).

GERUZEZ, NICOLAS EUGÈNE (1799-1865), French critic, was born on the 6th of January 1799 at Reims. He was assistant professor at the Sorbonne, and in 1852 he became secretary to the faculty of literature. He wrote a *Histoire de l'éloquence politique et religieuse en France aux XIV^e, XV^e, et XVI^e siècles*

(1837-1838); an admirable *Histoire de la littérature française depuis les origines jusqu'à la Révolution* (1852), which he supplemented in 1859 by a volume bringing down the history to the close of the revolutionary period; and some miscellaneous works. Geruzez died on the 29th of May 1865 in Paris. A posthumous volume of *Mélanges et pensées* appeared in 1877.

GERVAIS, PAUL (1816-1879), French palaeontologist, was born on the 26th of September 1816 at Paris, where he obtained the diplomas of doctor of science and of medicine, and in 1835 he began palaeontological research as assistant in the laboratory of comparative anatomy at the Museum of Natural History. In 1841 he obtained the chair of zoology and comparative anatomy at the Faculty of Sciences in Montpellier, of which he was in 1856 appointed dean. In 1848-1852 appeared his important work *Zoologie et paléontologie françaises*, supplementary to the palaeontological publications of G. Cuvier and H. M. D. de Blainville; of this a second and greatly improved edition was issued in 1859. In 1865 he accepted the professorship of zoology at the Sorbonne, vacant through the death of L. P. Gratiolet; this post he left in 1868 for the chair of comparative anatomy at the Paris museum of natural history, the anatomical collections of which were greatly enriched by his exertions. He died in Paris on the 10th of February 1879.

He also wrote *Histoire naturelle des mammifères* (1853, &c.); *Zoologie médicale* (1859, with F. J. van Beneden); *Recherches sur l'ancien état de l'homme et la période quaternaire*, 19 pl. (1867); *Zoologie et paléontologie générales* (1867); *Ostéographie des éléphants* (1869, &c., with van Beneden).

GERVASE OF CANTERBURY (d. c. 1210), English monk and chronicler, entered the house of Christchurch, Canterbury, at an early age. He made his profession and received holy orders in 1163; but we have no further clue to the date of his birth. We know nothing of his life beyond what may be gathered from his own writings. Their evidence suggests that he died in or shortly after 1210, and that he had resided almost continuously at Canterbury from the time of his admission. The only office which we know him to have held is that of sacrist, which he received after 1190 and laid down before 1197. He took a keen interest in the secular quarrels of the Canterbury monks with their archbishops, and his earliest literary efforts were controversial tracts upon this subject. But from 1188 he applied his mind to historical composition. About that year he began the compilation of his *Chronica*, a work intended for the private reading of his brethren. Beginning with the accession of Stephen he continued his narrative to the death of Richard I. Up to 1188 he relies almost entirely upon extant sources; but from that date onwards is usually an independent authority. A second history, the *Gesta Regum*, is planned on a smaller scale and traces the fortunes of Britain from the days of Brutus to the year 1209. The latter part of this work, covering the years 1199-1209, is perhaps an attempt to redeem the promise, which he had made in the epilogue to the *Chronica*, of a continuation dealing with the reign of John. This is the only part of the *Gesta* which deserves much attention. The work was continued by various hands to the year 1328. From the *Gesta* the indefatigable Gervase turned to a third project, the history of the see of Canterbury from the arrival of Augustine to the death of Hubert Walter (1205). A topographical work, with the somewhat misleading title *Mappa mundi*, completes the list of his more important writings. The *Mappa mundi* contains a useful description of England shire by shire, giving in particular a list of the castles and religious houses to be found in each. The industry of Gervase was greater than his insight. He took a narrow and monastic view of current politics; he was seldom in touch with the leading statesmen of his day. But he appears to be tolerably accurate when dealing with the years 1188-1209; and sometimes he supplements the information provided by the more important chronicles.

See the introductions and notes in W. Stubbs's edition of the *Historical Works of Gervase of Canterbury* (Rolls edition, 2 vols., 1879-1880). (H. W. C. D.)

GERVASE OF TILBURY (fl. 1211), Anglo-Latin writer of the late 12th and early 13th centuries, was a kinsman and schoolfellow of Patrick, earl of Salisbury, but lived the life of a scholarly

adventurer, wandering from land to land in search of patrons. Before 1177 he was a student and teacher of law at Bologna; in that year he witnessed the meeting of the emperor Frederic I. and Pope Alexander III. at Venice. He may have hoped to win the favour of Frederic, who in the past had found useful instruments among the civilians of Bologna. But Frederic ignored him; his first employer of royal rank was Henry fitz Henry, the young king of England (d. 1183), for whom Gervase wrote a jest-book which is no longer extant. Subsequently we hear of Gervase as a clerk in the household of William of Champagne, cardinal archbishop of Reims (d. 1202). Here, as he himself confesses, he basely accused of heretical opinions a young girl, who had rejected his advances, with the result that she was burned to death. He cannot have remained many years at Reims; before 1189 he attracted the favour of William II. of Sicily, who had married Joanna, the sister of Henry fitz Henry. William took Gervase into his service and gave him a country-house at Nola. After William's death the kingdom of Sicily offered no attractions to an Englishman. The fortunes of Gervase suffered an eclipse until, some time after 1198, he found employment under the emperor Otto IV., who by descent and political interest was intimately connected with the Plantagenets. Though a clerk in orders Gervase became marshal of the kingdom of Arles, and married an heiress of good family. For the delectation of the emperor he wrote, about 1211, his *Otia Imperialia* in three parts. It is a farrago of history, geography, folklore and political theory—one of those books of table-talk in which the literature of the age abounded. Evidently Gervase coveted but ill deserved a reputation for encyclopaedic learning. The most interesting of his dissertations are contained in the second part of the *Otia*, where he discusses, among other topics, the theory of the Empire and the geography and history of England. We do not know what became of Gervase after the downfall of Otto IV. But he became a canon; and may perhaps be identified with Gervase, provost of Ebbekeisdorf, who died in 1235.

See the *Otia Imperialia* in G. Leibnitz's *Scriptores rerum Brunsvicensium*, vols. i. and ii. (Hanover, 1707); extracts in J. Stevenson's edition of *Goggehall* (Rolls series, 1875). Of modern accounts the best are those by W. Stubbs in his edition of *Gervase of Canterbury*, vol. i. introd. (Rolls series, 1879), and by R. Pauli in *Nachrichten der Gesellschaft der Wissenschaften zu Göttingen* (1882). In the older biographers the *Dialogus de scaccario* of Richard Fitz Neal (q.v.) is wrongly attributed to Gervase. (H. W. C. D.)

GERVEX, HENRI (1852—), French painter, was born in Paris on the 10th of December 1852, and studied painting under Cabanel, Brissot and Fromentin. His early work belonged almost exclusively to the mythological genre which served as an excuse for the painting of the nude—not always in the best of taste; indeed, his "Rolla" of 1878 was rejected by the jury of the Salon *pour immoralité*. He afterwards devoted himself to representations of modern life and achieved signal success with his "Dr Péan at the Salpêtrière," a modernized paraphrase, as it were, of Rembrandt's "Anatomy Lesson." He was entrusted with several important official paintings and the decoration of public buildings. Among the first are "The Distribution of Awards (1889) at the Palais de l'Industrie" (now in the Versailles Museum), "The Coronation of Nicolas II." (Moscow, May 14, 1896), "The Mayors' Banquet" (1900), and the portrait group "La République Française"; and among the second, the ceiling for the Salle des Fêtes at the hôtel de ville, Paris, and the decorative panels painted in conjunction with Blanchon for the mairie of the 19th arrondissement, Paris. He also painted, with Alfred Stevens, a panorama, "The History of the Century" (1889). At the Luxembourg is his painting "Satyrs playing with a Bacchante," as well as the large "Members of the Jury of the Salon" (1885). Other pictures of importance, besides numerous portraits in oils and pastel, are "Communion at Trinity Church," "Return from the Ball," "Diana and Endymion," "Job," "Civil Marriage," "At the Ambassadeurs," "Yachting in the Archipelago," "Nana" and "Maternity."

GERVINUS, GEORG GOTTFRIED (1805-1871), German literary and political historian, was born on the 20th of May

1805 at Darmstadt. He was educated at the gymnasium of the town, and intended for a commercial career, but in 1823 he became a student of the university of Giessen. In 1826 he went to Heidelberg, where he attended the lectures of the historian Schlosser, who became henceforth his guide and his model. In 1828 he was appointed teacher in a private school at Frankfurt-on-Main, and in 1830 *Privatdozent* at Heidelberg. A volume of his collected *Historische Schriften* procured him the appointment of professor extraordinarius; while the first volume of his *Geschichte der politischen Nationalliteratur der Deutschen* (1835-1842, 5 vols., subsequently entitled *Geschichte der deutschen Dichtung*; 5th edition, by K. Bartsch, 1871-1874) brought him the appointment to a regular professorship of history and literature at Göttingen. This work is the first comprehensive history of German literature written both with scholarly erudition and literary skill. In the following year he wrote his *Grundzüge der Historik*, which is perhaps the most thoughtful of his philosophico-historical productions. The same year brought his expulsion from Göttingen in consequence of his manly protest, in conjunction with six of his colleagues, against the unscrupulous violation of the constitution by Ernest Augustus, king of Hanover and duke of Cumberland. After several years in Heidelberg, Darmstadt and Rome, he settled permanently in Heidelberg, where, in 1844, he was appointed honorary professor. He zealously took up in the following year the cause of the German Catholics, hoping it would lead to a union of all the Christian confessions, and to the establishment of a national church. He also came forward in 1846 as a patriotic champion of the Schleswig-Holsteiners, and when, in 1847, King Frederick William IV. promulgated the royal decree for summoning the so-called "United Diet" (Vereiniger Landtag), Gervinus hoped that this event would form the basis of the constitutional development of the largest German state. He founded, together with some other patriotic scholars, the *Deutsche Zeitung*, which certainly was one of the best-written political journals ever published in Germany. His appearance in the political arena secured his election as deputy for the Prussian province of Saxony to the National Assembly sitting in 1848 at Frankfurt. Disgusted with the failure of that body, he retired from all active political life.

Gervinus now devoted himself to literary and historical studies, and between 1849 and 1852 published his work on *Shakespeare* (4 vols., 4th ed. 2 vols., 1872; Eng. trans. by F. E. Bunnell, 1863, new ed. 1877). He also revised his *History of German Literature*, for a fourth edition (1853), and began at the same time to plan his *Geschichte des neunzehnten Jahrhunderts* (8 vols., 1854-1860), which was preceded by an *Einleitung in die Geschichte des neunzehnten Jahrhunderts* (1853). The latter caused some stir in the literary and political world, owing to the circumstance that the government of Baden imprudently instituted a prosecution against the author for high treason. In 1868 appeared *Händel und Shakespeare, zur Ästhetik der Tonkunst*, in which he drew an ingenious parallel between his favourite poet and his favourite composer, showing that their intellectual affinity was based on the Teutonic origin common to both, on their analogous intellectual development and character. The ill-success of this publication, and the indifference with which the latter volumes of his *History of the 19th Century* were received by his countrymen, together with the feeling of disappointment that the unity of Germany had been brought about in another fashion and by other means than he wished to see employed, embittered his later years. He died at Heidelberg on the 18th of March 1871.

Gervinus's autobiography (*G. Gervinus' Leben, von ihm selbst*) was published by his widow in 1893. It does not, however, go beyond the year 1836. See E. Lehmann, *Gervinus, Verrückter einer Charakteristik* (1871); R. Gosche, *Gervinus* (1871); J. Dörfel, *Gervinus als historischer Denker* (1904).

GERYON (GERYONES, GERYONEUS), in Greek mythology, the son of Chrysaor and Callirrhoe, daughter of Oceanus, and king of the island of Erythia. He is represented as a monster with three heads or three bodies (*triformis, trigeminus*), sometimes with wings, and as the owner of herds of red cattle, which were

tended by the giant shepherd Eurytion and the two-headed dog Orthrus. To carry off these cattle to Greece was one of the twelve "labours" imposed by Eurystheus upon Heracles. In order to get possession of them, Heracles travelled through Europe and Libya, set up the two pillars in the Straits of Gibraltar to show the extent of his journey, and reached the great river Oceanus. Having crossed Oceanus and landed on the island, Heracles slew Orthrus together with Eurytion, who in vain strove to defend him, and drove off the cattle. Geryon started in pursuit, but fell a victim to the arrows of Heracles, who, after various adventures, succeeded in getting the cattle safe to Greece, where they were offered in sacrifice to Hera by Eurystheus. The geographical position of Erytheia is unknown, but all ancient authorities agree that it was in the far west. The name itself (= red) and the colour of the cattle suggest the fiery aspect of the disk of the setting sun; further, Heracles crosses Oceanus in the golden cup or boat of the sun-god Helios. Geryon (from γῆρυς, the howler or roarer) is supposed to personify the storm, his father Chrysaor the lightning, his mother Callirrhoe the rain. The cattle are the rain-clouds, and the slaying of their keepers typifies the victory of the sun over the clouds, or of spring over winter. The euhemeristic explanation of the struggle with the triple monster was that Heracles fought three brothers in succession.

See Apollodorus ii. 5. 10; Hesiod, *Theogony*, 287; Diod. Sic. iv. 17; Herodotus iv. 8; F. Wieseler in Ersch and Gruber, *Allgemeine Encyclopädie*; F. A. Voigt in Roscher's *Lexikon der Mythologie*; L. Preller, *Griechische Mythologie*; article "Hercules" in Daremberg and Saglio, *Dictionnaire des antiquités*.

GESENIUS, HEINRICH FRIEDRICH WILHELM (1786–1842), German orientalist and biblical critic, was born at Nordhausen, Hanover, on the 3rd of February 1786. In 1803 he became a student of philosophy and theology at the university of Helmstedt, where Heinrich Henke (1752–1800) was his most influential teacher; but the latter part of his university course was taken at Göttingen, where J. G. Eichhorn and T. C. Tychsen (1758–1834) were then at the height of their popularity. In 1806, shortly after graduation, he became *Receptent* and *Privatdozent* in that university; and, as he was fond of afterwards relating, had Neander for his first pupil in Hebrew. In 1810 he became professor extraordinarius in theology, and in 1811 ordinarius, at the university of Halle, where, in spite of many offers of high preferment elsewhere, he spent the rest of his life. He taught with great regularity for upward of thirty years, the only interruptions being that of 1813–1814 (occasioned by the War of Liberation, during which the university was closed) and those occasioned by two prolonged literary tours, first in 1820 to Paris, London and Oxford with his colleague Johann Karl Thilo (1794–1853) for the examination of rare oriental manuscripts, and in 1835 to England and Holland in connexion with his Phoenician studies. He soon became the most popular teacher of Hebrew and of Old Testament introduction and exegesis in Germany; during his later years his lectures were attended by nearly five hundred students. Among his pupils the most eminent were Peter von Bohlen (1796–1840), A. G. Hoffmann (1769–1864), Hermann Hupfeld, Emil Rüdiger (1801–1874), J. F. Tuch (1806–1867), W. Vatke (1806–1882) and Theodor Benfey (1809–1881). In 1827, after declining an invitation to take Eichhorn's place at Göttingen, Gesenius was made a *Consistorialrath*; but, apart from the violent attacks to which he, along with his friend and colleague Julius Wegscheider, was in 1830 subjected by E. W. Hengstenberg and his party in the *Evangelische Kirchenzeitung*, on account of his rationalism, his life was uneventful. He died at Halle on the 23rd of October 1842. To Gesenius belongs in a large measure the credit of having freed Semitic philology from the trammels of theological and religious prepossession, and of inaugurating the strictly scientific (and comparative) method which has since been so fruitful. As an exegete he exercised a powerful, and on the whole a beneficial, influence on theological investigation.

Of his many works, the earliest, published in 1810, entitled *Versuch über die maltesische Sprache*, was a successful refutation of the widely current opinion that the modern Maltese was of Punic origin. In the

same year appeared the first volume of the *Hebräisches u. Chaldäisches Handwörterbuch*, completed in 1812. Revised editions of this appear periodically in Germany, e.g. that of H. Zimmermann and F. Buhl (1905). The publication of a new English edition was started in 1892 under the editorship of Professors C. A. Briggs, S. R. Driver and F. Brown. The *Hebräische Grammatik*, published in 1813 (27th edition by E. Kautzsch; English translation from 25th and 26th German editions by G. W. Collins and A. E. Cowley, 1898), was followed in 1815 by the *Geschichte der hebräischen Sprache* (now very rare), and in 1817 by the *Ausführliches Lehrgebäude der hebräischen Sprache*. The first volume of his well-known commentary on Isaiah (*Der Prophet Jesaja*), with a translation, appeared in 1821; but the work was not completed until 1829. The *Thesaurus philologico-criticus linguae Hebraicae et Chaldaicae* V. T., begun in 1829, he did not live to complete; the latter part of the third volume is edited by E. Rödiger (1858). Other works: *De Pentateuchi Samaritani origine, indole, et auctoritate* (1815), supplemented in 1822 and 1824 by the treatise *De Samaritanorum theologia*, and by an edition of *Carmina Samaritana*; *Paläographische Studien über phönizische u. punische Schrift* (1835), a pioneering work which he followed up in 1837 by his collection of Phoenician monuments (*Scripturae linguaeque Phoeniciae monumenta quaequod supersunt*); an Aramaic lexicon (1834–1839); and a treatise on the Hittite language written in conjunction with E. Rödiger in 1841. Gesenius also contributed extensively to Ersch and Gruber's *Encyclopädie*, and enriched the German translation of J. L. Burckhardt's *Travels in Syria and the Holy Land* with valuable geographical notes. For many years he also edited the *Halle Allgemeine Literaturzeitung*. A sketch of his life was published anonymously in 1843 (*Gesenius: eine Erinnerung für seine Freunde*), and another by H. Gesenius, *Wilhelm Gesenius, ein Erinnerungsbild aus dem hundertjährigen Geburtstag*, in 1886. See also the article in the *Allgemeine deutsche Biographie*.

GESNER, ABRAHAM (1797–1864), Canadian geologist, was born in Nova Scotia in 1797. He qualified as a doctor of medicine in London in 1827. Returning to the Dominion, he published in 1836 *Remarks on the Geology and Mineralogy of Nova Scotia*, and continuing his researches he was enabled in 1843 to bring before the Geological Society of London "A Geological Map of Nova Scotia, with an accompanying Memoir" (*Proc. Geol. Soc.* iv. 186). In 1849 he issued a volume on the industrial resources of the country. He dealt also with the geology and mineralogy of New Brunswick and Prince Edward's Island. Devoting himself to the economic side of geology in various parts of North America, he was enabled to bring out in 1861 *A Practical Treatise on Coal, Petroleum and other Distilled Oils*. He died at Halifax, N.S., on the 29th of April 1864.

GESNER, JOHANN MATTHIAS (1691–1761), German classical scholar and schoolmaster, was born at Roth near Ansbach on the 9th of April 1691. He studied at the university of Jena, and in 1714 published a work on the *Philopatris* ascribed to Lucian. In 1715 he became librarian and corrector (vice-principal) at Weimar, in 1729 rector of the gymnasium at Ansbach, and in 1730 rector of the Thomas school at Leipzig. On the foundation of the university of Göttingen he became professor of rhetoric (1734) and subsequently librarian. He died at Göttingen on the 3rd of August 1761. His special merit lies in the attention he devoted to the explanation and illustration of the subject matter of the classical authors.

His principal works are: editions of the *Scriptores rei rusticae*, of Quintilian, Claudian, Pliny the Younger, Horace and the Orphic poems (published after his death); *Primae linguae isagoges in eruditionem universalem* (1756); an edition of B. Faber's *Thesaurus eruditiois scholasticae* (1726), afterwards continued under the title *Novae linguae et eruditiois Romanae Thesaurus* (1749); *Opuscula minora varii argumenti* (1743–1745); *Thesaurus epistolicus Gesnerianus* (ed. Klotz, 1768–1770); *Index etymologicus latinitalis* (1749). See J. A. Ernesti, *Opuscula oratoria* (1762), p. 309; H. Sauppe, *Göttinger Professoren* (1872); C. H. Pöbner, *J. M. Gesner und sein Verhältniss zum Philanthropismus und Neuhumanismus* (1898), a contribution to the history of pedagogy in the 18th century; articles by F. A. Eckstein in *Allgemeine deutsche Biographie* ix.; and Sandys, *Hist. of Class. Schol.* iii. (1908), 5-9.

GESNER [improperly **GESNER**; in Latin, **GESNERUS**], **KONRAD VON** (1516–1565), German-Swiss writer and naturalist, called "the German Pliny" by Cuvier, was born at Zülrich on the 26th of March 1516. The son of a poor furrier, he was educated in that town, but fell into great need after the death of his father at the battle of Kappel (1531). He had good friends, however, in his old master, Myconius, and subsequently in Heinrich Bullinger, and he was enabled to continue his studies at the

universities of Strassburg and Bourges (1532-1533); he found also a generous patron in Paris (1534), in the person of Joh. Steiger of Berne. In 1535 the religious troubles drove him back to Zürich, where he made an imprudent marriage. His friends again came to his aid, enabled him to study at Basel (1536), and in 1537 procured for him the professorship of Greek at the newly founded academy of Lausanne (then belonging to Berne). Here he had leisure to devote himself to scientific studies, especially botany. In 1540-1541 he visited the famous medical university of Montpellier, took his degree of doctor of medicine (1541) at Basel, and then settled down to practise at Zürich, where he obtained the post of lecturer in physics at the Carolinum. There, apart from a few journeys to foreign countries, and annual summer botanical journeys in his native land, he passed the remainder of his life. He devoted himself to preparing works on many subjects of different sorts. He died of the plague on the 13th of December 1565. In the previous year he had been ennobled.

To his contemporaries he was best known as a botanist, though his botanical MSS. were not published till long after his death (at Nuremberg, 1751-1771, 2 vols. folio), he himself issuing only the *Enchiridion historiae plantarum* (1541) and the *Catalogus plantarum* (1542) in four tongues. In 1545 he published his remarkable *Bibliotheca universalis* (ed. by J. Simler, 1574), a catalogue (in Latin, Greek and Hebrew) of all writers who had ever lived, with the titles of their works, &c. A second part, under the title of *Pandectarium sive partitionum universalium Conradi Gesneri Ligurini libri xxi.*, appeared in 1548; only nineteen books being then concluded. The 21st book, a theological encyclopaedia, was published in 1549, but the 20th, intended to include his medical work, was never finished. His great zoological work, *Historia animalium*, appeared in 4 vols. (quadrupeds, birds, fishes) folio, 1551-1558, at Zürich, a fifth (snakes) being issued in 1587 (there is a German translation, entitled *Thierbuch*, of the first 4 vols., Zürich, 1563); this work is the starting-point of modern zoology. Not content with such vast works, Gesner put forth in 1555 his book entitled *Mithridates de differentiis linguis*, an account of about 130 known languages, with the Lord's Prayer in 22 tongues, while in 1556 appeared his edition of the works of Aelian. To non-scientific readers, Gesner will be best known for his love of mountains (below the snow-line) and for his many excursions among them, undertaken partly as a botanist, but also for the sake of mere exercise and enjoyment of the beauties of nature. In 1541 he prefixed to a singular little work of his (*Libellus de lacte et operibus lactariis*) a letter addressed to his friend, J. Vogel, of Glarus, as to the wonders to be found among the mountains, declaring his love for them, and his firm resolve to climb at least one mountain every year, not only to collect flowers, but in order to exercise his body. In 1555 Gesner issued his narrative (*Descriptio Montis Fraclii sive Montis Pilati*) of his excursion to the Gnepfstein (6200 ft.), the lowest point in the Pilatus chain, and therein explains at length how each of the senses of man is refreshed in the course of a mountain excursion.

Lives by J. Hanhart (Winterthur, 1824) and J. Simler (Zürich, 1566); see also Lebert's *Gesner als Arzt* (Zürich, 1854). A part of his unpublished writing, edited by Prof. Schmedel, was published at Nuremberg in 1753.

GESSNER, SOLOMON (1730-1788), Swiss painter and poet, was born at Zürich on the 1st of April 1730. With the exception of some time (1749-1750) spent in Berlin and Hamburg, where he came under the influence of Ramlar and Hagedorn, he passed the whole of his life in his native town, where he carried on the business of a bookseller. He died on the 2nd of March 1788. The first of his writings that attracted attention was his *Lied eines Schneiders an sein bewaffnetes Mädchen* (1751). Then followed *Daphnis* (1754), *Idyllen* (1756 and 1772), *Inkel* and *Yariko* (1756), a version of a story borrowed from the *Spectator* (No. 11, 13th of March 1711) and already worked out by Gellert and Bodmer, and *Der Tod Abels* (1758), a sort of idyllic pastoral. It is somewhat difficult for us now to understand the reason of Gesner's universal popularity, unless it was the taste of the

period for the conventional pastoral. His writings are marked by sweetness and melody, qualities which were warmly appreciated by Lessing, Herder and Goethe. As a painter Gesner represented the conventional classical landscape.

Collected editions of Gesner's works were repeatedly published (2 vols. 1777-1778, finally 2 vols. 1841, both at Zürich). They were translated into French (3 vols., Paris, 1786-1793), and versions of the *Idyllen* appeared in English, Dutch, Portuguese, Spanish, Swedish and Bohemian. Gesner's life was written by Hottiner (Zürich, 1796), and by H. Wölflin (Frauenfeld, 1890); see also his *Briefwechsel mit seinem Sohn* (Bern and Zürich, 1801).

GESSO, an Italian word (Lat. *gypsum*), for "plaster of Paris" especially when used as a ground for painting, or for modelling or sculpture.

GESTA ROMANORUM, a Latin collection of anecdotes and tales, probably compiled about the end of the 13th century or the beginning of the 14th. It still possesses a twofold literary interest, first as one of the most popular books of the time, and secondly as the source, directly or indirectly, of later literature, in Chaucer, Gower, Shakespeare and others. Of its authorship nothing certain is known; and there is little but gratuitous conjecture to associate it either with the name of Helinandus or with that of Petrus Berchorius (Pierre Bercheure). It is even a matter of debate whether it took its rise in England, Germany or France. The work was evidently intended as a manual for preachers, and was probably written by one who himself belonged to the clerical profession. The name, *Deeds of the Romans*, is only partially appropriate to the collection in its present form, since, besides the titles from Greek and Latin history and legend, it comprises fragments of very various origin, oriental and European. The unifying element of the book is its moral purpose. The style is barbarous, and the narrative ability of the compiler seems to vary with his source; but he has managed to bring together a considerable variety of excellent material. He gives us, for example, the germ of the romance of "Guy of Warwick"; the story of "Darius and his Three Sons," versified by Oclvele; part of Chaucer's "Man of Lawes' Tale"; a tale of the emperor Theodosius, the same in its main features as that of Shakespeare's *Lear*; the story of the "Three Black Crows"; the "Hermit and the Angel," well known from Parnell's version, and a story identical with the *Fridolin* of Schiller. Owing to the loose structure of the book, it was easy for a transcriber to insert any additional story into his own copy, and consequently the MSS. of the *Gesta Romanorum* exhibit considerable variety. Oesterley recognizes an English group of MSS. (written always in Latin), a German group (sometimes in Latin and sometimes in German), and a group which is represented by the vulgate or common printed text. The earliest editions are supposed to be those of Ketelaer and de Lecompt at Utrecht, of Arnold Ter Hoenen at Cologne, and of Ulrich Zell at Cologne; but the exact date is in all three cases uncertain.

An English translation, probably based directly on the MS. Harl. 5369, was published by Wynkyn de Worde about 1510-1515, the only copy of which now known to exist is preserved in the library of St John's College, Cambridge. In 1577 Richard Robinson published a revised edition of Wynkyn de Worde, and the book proved highly popular. Between 1648 and 1703 at least eight impressions were issued. In 1703 appeared the first vol. of a translation by B. F., probably Bartholomew Pratt, from the Latin edition of 1514. A translation by the Rev. C. Swan, first published in 2 vols. in 1824, forms part of Bohn's antiquarian library, and was re-edited by Wynard Hooper in 1877 (see also the latter's edition in 1894). The German translation was first printed at Augsburg, 1489. A French version, under the title of *Le Violier des histoires romaines moralisées*, appeared in the early part of the 16th century, and went through a number of editions; it has been reprinted by G. Brunet (Paris, 1858). Critical editions of the Latin text have been produced by A. Keller (Stuttgart, 1842) and Oesterley (Berlin, 1872). See also Warton, "On the *Gesta Romanorum*," dissertation iii., prefixed to the *History of English Poetry*; Douce, *Illustrations of Shakespeare*, vol. ii.; Frederick Madden, Introduction to the Roxburghe Club edition of *The Old English Versions of the Gesta Romanorum* (1838).

GETA, PUBLIUS SEPTIMIUS (189-212), younger son of the Roman emperor Septimius Severus, was born at Mediolanum (Milan). In 198 he received the title of Caesar, and in 209 those of Imperator and Augustus. Between him and his brother Caracalla

there existed from their early years a keen rivalry and antipathy. On the death of their father in 211 they were proclaimed joint emperors; and after the failure of a proposed arrangement for the division of the empire, Caracalla pretended a desire for reconciliation. He arranged a meeting with his brother in his mother's apartments, and had him murdered in her arms by some centurions.

Dio Cassius lxxvii. 2; Spartianus, *Caracalla*, 2; Herodian iv. 1.

GETAE, an ancient people of Thracian origin, closely akin to the Daci (see **DACIA**). Their original home seems to have been the district on the right bank of the Danube between the rivers Oescus (Iskr) and Iatrus (Yantra). The view that the Getae were identical with the Goths has found distinguished supporters, but it is not generally accepted. Their name first occurs in connexion with the expedition of Darius Hystaspis (515 B.C.) against the Scythians, in the course of which they were brought under his sway, but they regained their freedom on his return to the East. During the 5th century, they appear as furnishing a contingent of cavalry to Sitalces, king of the Odrysae, in his attack on Perdiccas II., king of Macedon, but the decay of the Odrysian kingdom again left them independent. When Philip II. of Macedon in 342 reduced the Odrysae to the condition of tributaries, the Getae, fearing that their turn would come next, made overtures to the conqueror. Their king Cothelas undertook to supply Philip with soldiers, and his daughter became the wife of the Macedonian. About this time, perhaps being hard pressed by the Triballi and other tribes, the Getae crossed the Danube. Alexander the Great, before transporting his forces into Asia, decided to make his power felt by the Macedonian dependencies. His operations against the Triballi not having met with complete success, he resolved to cross the Danube and attack the Getae. The latter, unable to withstand the phalanx, abandoned their chief town, and fled to the steppes (*Γετία ἡ Ἰππυος*, north of the Danube delta), whither Alexander was unwilling to follow them. About 326, an expedition conducted by Zopyrion, a Macedonian governor of Thrace, against the Getae, failed disastrously. In 292, Lysimachus declared war against them, alleging as an excuse that they had rendered assistance to certain barbarous Macedonian tribes. He penetrated to the plains of Bessarabia, where his retreat was cut off and he was forced to surrender. Although the people clamoured for his execution, Dromichaetes, king of the Getae, allowed him to depart unharmed, probably on payment of a large ransom, great numbers of gold coins having been found near Thorda, some of them bearing the name of Lysimachus. When the Gauls made their way into eastern Europe, they came into collision with the Getae, whom they defeated and sold in large numbers to the Athenians as slaves. From this time the Getae seem to have been usually called Daci; for their further history see **DACIA**.

The Getae are described by Herodotus as the most valiant and upright of the Thracian tribes; but what chiefly struck Greek inquirers was their belief in the immortality of the soul (hence they were called *ἀθάνατοι*) and their worship of Zalmoxis (or Zamolxis), whom the euhemerists of the colonies on the Euxine made a pupil of Pythagoras. They were very fond of music, and it was the custom for their ambassadors the priests to present themselves clad in white, playing the lyre and singing songs. They were experts in the use of the bow and arrows while on horseback.

See E. R. Rösler, "Die Geten und ihre Nachbarn," in *Sitzungsberichte der k. Akad. der Wissenschaften, philosophisch-historische Classe*, xlv. (1863), and *Romanische Studien* (Leipzig, 1871); W. Tomaschek, "Die alten Thraker," in above *Sitzungsberichte*, cxxviii. (Vienna, 1893); W. Bessel, *De rebus Geticis* (Göttingen, 1854); C. Müllenhoff in Ersch and Gruber's *Allgemeine Encyclopädie*; T. Mommsen, *Hist. of Rome* (Eng. trans.), bk. v. ch. 7.

GETHSEMANE (Hebr. for "oil-press"), the place to which Jesus and His disciples withdrew on the eve of the Crucifixion. It was evidently an enclosed piece of ground, a plantation rather than a garden in our sense of the word. It lay east of the Kidron and on the lower slope of the mount of Olives, at the foot of which is the traditional site dating from the 4th century and now possessed by the Franciscans. The Grotto of the Agony, a few

hundred yards farther north, is an ancient cave-cistern, now a Latin sanctuary. (See further **JERUSALEM**.)

GETTYSBURG, a borough and the county-seat of Adams county, Pennsylvania, U.S.A., about 35 m. S.W. of Harrisburg. Pop. (1900) 3495; (1910) 4030. It is served by the Western Maryland and the Gettysburg & Harrisburg railways. The site of the borough is a valley about 1½ m. wide; the neighbouring country abounds in attractive scenery. Katalysine Spring in the vicinity was once a well-known summer resort; its waters contain lithia in solution. Gettysburg has several small manufacturing establishments and is the seat of Pennsylvania College (opened in 1832, and the oldest Lutheran college in America), which had 312 students (68 in the preparatory department) in 1907-1908, and of a Lutheran theological seminary, opened in 1826 on Seminary Ridge; but the borough is best known as the scene of one of the most important battles of the Civil War. Very soon after the battle a soldiers' national cemetery was laid out here, in which the bodies of about 3600 Union soldiers have been buried; and at the dedication of this cemetery, in November 1863, President Lincoln delivered his celebrated "Gettysburg Address." In 1864 the Gettysburg Battle-Field Memorial Association was incorporated, and the work of this association resulted in the conversion of the battle-field into a National Park, an act for the purpose being passed by Congress in 1895. Within the park the lines of battle have been carefully marked, and about 600 monuments, 1000 markers, and 500 iron tablets have been erected by states and regimental associations. Hundreds of cannon have been mounted, and five observation towers have been built. From 1816 to 1840 Gettysburg was the home of Thaddeus Stevens. Gettysburg was settled about 1740, was laid out in 1787, was made the county-seat in 1800, and was incorporated as a borough in 1806.

Battle of Gettysburg.—The battle of the 1st, 2nd and 3rd of July 1863 is often regarded as the turning-point of the American Civil War (*q.v.*) although it arose from a chance encounter. Lee, the commander of the Confederate Army of Northern Virginia, had merely ordered his scattered forces to concentrate there, while Meade, the Federal commander, held the town with a cavalry division, supported by two weak army corps, to screen the concentration of his Army of the Potomac in a selected position on Pipe Creek to the south-eastward. On the 1st of July the leading troops of General A. P. Hill's Confederate corps approached Gettysburg from the west to meet Ewell's corps, which was to the N. of the town, whilst Longstreet's corps followed Hill. Lee's intention was to close up Hill, Longstreet and Ewell before fighting a battle. But Hill's leading brigades met a strenuous resistance from the Federal cavalry division of General John Buford, which was promptly supported by the infantry of the I. corps under General J. F. Reynolds. The Federals so far held their own that Hill had to deploy two-thirds of his corps for action, and the western approaches of Gettysburg were still held when Ewell appeared to the northward. Reynolds had already fallen, and the command of the Federals, after being held for a time by Gen. Abner Doubleday, was taken over by Gen. O. O. Howard, the commander of the XI. corps, which took post to bar the way to Ewell on the north side. But Ewell's attack, led by the fiery Jubal Early, swiftly drove back the XI. corps to Gettysburg; the I. corps, with its flank thus laid open, fell back also, and the remnants of both Federal corps retreated through Gettysburg to the Cemetery Hill position. They had lost severely in the struggle against superior numbers, and there had been some disorder in the retreat. Still a formidable line of defence was taken up on Cemetery Hill and both Ewell and Lee refrained from further attacks, for the Confederates had also lost heavily during the day and their concentration was not complete. In the meanwhile Meade had sent forward General W. S. Hancock, the commander of the Federal II. corps, to examine the state of affairs and on Hancock's report he decided to fight on the Cemetery Hill position. Two corps of his army were still distant, but the XII. arrived before night, the III. was near, and Hancock moved the II. corps on his own initiative. Headquarters and the artillery reserve started for Gettysburg on the night of the 1st.

GETTYSBURG

On the other side, the last divisions of Hill's and Ewell's corps formed up opposite the new Federal position, and Longstreet's corps prepared to attack its left.

Owing, however, to misunderstandings between Lee and Longstreet (*q.v.*), the Confederates did not attack early on the morning of the 2nd, so that Meade's army had plenty of time to make its dispositions. The Federal line at this time occupied the horse-shoe ridge, the right of which was formed by Culp's Hill, and the centre by the Cemetery hill, whence the left wing stretched southward, the III. corps on the left, however, being thrown forward considerably. The XII. held Culp's, the remnant of the I. and XI. the Cemetery hills. On the left was the II., and in its advanced position—the famous "Salient"—the III., soon to be supported by the V.; the VI., with the reserve artillery, formed the general reserve. It was late in the day when the Confederate attack was made, and valuable time had been lost, but Longstreet's troops advanced with great spirit. The III.



corps Salient was the scene of desperate fighting; and the "Peach Orchard" and the "Devil's Den" became as famous as the "Bloody Angle" of Spottsylvania or the "Hornets' Nest" of Shiloh. While the Confederate attack was developing, the important positions of Round Top and Little Round Top were unoccupied by the defenders—an omission which was repaired only in the nick of time by the commanding engineer of the army, General G. K. Warren, who hastily called up troops of the V. corps. The attack of a Confederate division was, after a hard struggle, repulsed, and the Federals retained possession of the Round Tops. The III. corps in the meantime, furiously attacked by troops of Hill's and Longstreet's corps, was steadily pressed back, and the Confederates actually penetrated the main line of the defenders, though for want of support the brigades which achieved this were quickly driven out. Ewell, on the Confederate left, waited for the sound of Longstreet's guns, and thus no attack was made by him until late in the day. Here Culp's Hill was carried with ease by one of Ewell's divisions, most of the Federal XII. corps having been withdrawn to aid in the fight on the other wing; but Early's division was repulsed in its efforts to storm Cemetery Hill, and the two divisions of the centre (one of Hill's, one of Ewell's corps) remained inactive.

That no decisive success had been obtained by Lee was clear to all, but Ewell's men on Culp's Hill, and Longstreet's corps below Round Top, threatened to turn both flanks of the Federal position, which was no longer a compact horseshoe but had been considerably prolonged to the left; and many of the units in the Federal army had been severely handled in the two days' fighting. Meade, however, after discussing the eventuality of a retreat with his corps commanders, made up his mind to hold his ground. Lee now decided to alter his tactics. The broken ground near Round Top offered so many obstacles that he decided not to press Longstreet's attack further. Ewell was to resume his attack on Meade's extreme right, while the decisive blow was to be given in the centre (between Cemetery Hill and Trostle's) by an assault delivered in the Napoleonic manner by the fresh troops of Pickett's division (Longstreet's corps). Meade, however, was not disposed to resign Culp's Hill, and with it the command of the Federal line of retreat, to Ewell, and at early dawn on the 3rd a division of the XII. corps, well supported by artillery, opened the Federal counter-attack; the Confederates made a strenuous resistance, but after four hours' hard fighting the other division of the XII. corps, and a brigade of the VI., intervened with decisive effect, and the Confederates were driven off the hill. The defeat of Ewell did not, however, cause Lee to alter his plans. Pickett's division was to lead in the great assault, supported by part of Hill's corps (the latter, however, had already been engaged). Colonel E. P. Alexander, Longstreet's chief of artillery, formed up one long line of seventy-five guns, and sixty-five guns of Hill's corps came into action on his left. To the converging fire of these 140 guns the Federals, cramped for space, could only oppose seventy-seven. The attacking troops formed up before 9 A.M., yet it was long before Longstreet could bring himself to order the advance, upon which so much depended, and it was not till about 1 P.M. that the guns at last opened fire to prepare the grand attack. The Federal artillery promptly replied, but after thirty minutes' cannonade its commander, Gen. H. J. Hunt, ordered his batteries to cease fire in order to reserve their ammunition to meet the infantry attack. Ten minutes later Pickett asked and received permission to advance, and the infantry moved forward to cross the 1800 yds. which separated them from the Federal line. Their own artillery was short of ammunition, the projectiles of that day were not sufficiently effective to cover the advance at long ranges, and thus the Confederates, as they came closer to the enemy, met a tremendous fire of unshaken infantry and artillery.

The charge of Pickett's division is one of the most famous episodes of military history. In the teeth of an appalling fire from the rifles of the defending infantry, who were well sheltered, and from the guns which Hunt had reserved for the crisis, the Virginian regiments pressed on, and with a final effort broke Meade's first line. But the strain was too great for the supporting brigades, and Pickett was left without assistance. Hancock made a fierce counterstroke, and the remnant of the Confederates retreated. Of Pickett's own division over three-quarters, 3393 officers and men out of 4500, were left on the field, two of his three brigadiers were killed and the third wounded, and of fifteen regimental commanders ten were killed and five wounded. One regiment lost 90% of its numbers. The failure of this assault practically ended the battle; but Lee's line was so formidable that Meade did not in his turn send forward the Army of the Potomac. By the morning of the 5th of July Lee's army was in full retreat for Virginia. He had lost about 30,000 men in killed, wounded and missing out of a total force of perhaps 75,000. Meade's losses were over 23,000 out of about 82,000 on the field. The main body of the cavalry on both sides was absent from the field, but a determined cavalry action was fought on the 3rd of July between the Confederate cavalry under J. E. B. Stuart and that of the Federals under D. McM. Gregg some miles E. of the battlefield, and other Federal cavalry made a dashing charge in the broken ground south-west of Round Top on the third day, inflicting thereby, though at great loss to themselves, a temporary check on the right wing of Longstreet's infantry.

GEULINX, ARNOLD (1624-1660), Belgian philosopher, was born at Antwerp on the 31st of January 1624. He studied philosophy and medicine at the university of Louvain, where he remained as a lecturer for several years. Having given offence by his unorthodox views, he left Louvain, and took refuge in Leiden, where he appears to have been in the utmost distress. He entered the Protestant Church, and in 1663, through the influence of his friend Abraham Heidanus, who had assisted him in his greatest need, he obtained a poorly paid lectureship at the university. He died at Leiden in November 1669. His most important works were published posthumously. The *Metaphysica vera* (1691), and the *Γνωσθί οσαυτών, sive Ethica* (under the pseudonym "Philaretus," 1675), are the works by which he is chiefly known. Mention may also be made of *Physica vera* (1688), *Logica restituta* (1662) and *Annotata in Principia philosophiae R. Cartesii* (1691).

Geulinx principally deals with the question, left in an obscure and unsatisfactory state by Descartes, of the relation between soul and body. Whereas Descartes made the union between them a violent collocation, Geulinx practically called it a miracle. Extension and thought, the essences of corporeal and spiritual natures, are absolutely distinct, and cannot act upon one another. External facts are not the causes of mental states, nor are mental states the causes of physical facts. So far as the physical universe is concerned, we are merely spectators; the only action that remains for us is contemplation. The influence we seem to exercise over bodies by will is only apparent; volition and action only accompany one another. Since true activity consists in knowing what one does and how one does it, I cannot be the author of any state of which I am unconscious; I am not conscious of the mechanism by which bodily motion is produced, hence I am not the author of bodily motion ("Quod nescis quomodo fiat, id non facis"). Body and mind are like two clocks which act together, because both have been set together by God. A physical occurrence is but the occasion (opportunity, occasional cause) on which God excites in me a corresponding mental state; the exercise of my will is the occasion on which God moves my body. Every operation in which mind and matter are both concerned is an effect of neither, but the direct act of God. Geulinx was thus the first definitely to systematize the theory called Occasionalism, which had already been propounded by Gérauld de Cordemoy (d. 1684), a Parisian lawyer, and Louis de la Forge, a physician at Saumur. But the principles on which the theory was founded compelled a further advance. God, who is the cause of the concomitance of bodily and mental facts, is in truth the sole cause in the universe. No fact contains in itself the ground of any other; the existence of the facts is due to God, their sequence and coexistence are also due to him. He is the ground of all that is. My desires, volitions and thoughts are thus the desires, volitions and thoughts of God. Apart from God, the finite being has no reality, and we only have the idea of it from God. Descartes had left untouched, or nearly so, the difficult problem of the relation between the universal element or thought and the particular desires or inclinations. All these are regarded by Geulinx as modes of the divine thought and action, and accordingly the end of human endeavour is the end of the divine will or the realization of reason. The love of right reason is the supreme virtue, whence flow the cardinal virtues, diligence, obedience, justice and humility. Since it is impossible for us to make any alteration in the world of matter, all we can do is to submit. Chief of the cardinal virtues is humility, a confession of our own helplessness and submission to God. Geulinx's idea of life is "a resigned optimism."

Geulinx carried out to their extreme consequences the irreconcilable elements in the Cartesian metaphysics, and his works have the peculiar value attaching to the vigorous development of a one-sided principle. The abrupt contradictions to which such development leads of necessity compels revision of the principle itself. He was thus important as the precursor of Malebranche and Spinoza.

Edition of his philosophical works by J. P. N. Land (1891-1893, for which a recently discovered MS. was consulted); see also the

same editor's *Arnold Geulinx und seine Philosophie* (1895), and article (translated) in *Mind*, xvi, 223 seq.; V. van der Haeghen, *Geulinx. Etude sur sa vie, sa philosophie, et ses ouvrages* (Ghent, 1886); E. Grimm, *A. Geulinx's Erkenntnistheorie und Occasionalismus* (1875); E. Pfeiderer, *A. G. als Hauptvertreter der okkasionalistischen Metaphysik und Ethik* (1882); G. Sämtleben, *Geulinx, ein Vorgänger Spinozas* (1885); also Falckenberg, *Hist. of Mod. Philos.* (Eng. trans., 1895), ch. iii.; G. Monchamp, *Hist. du Cartésianisme en Belgique* (Brussels, 1886); H. Höffding, *Hist. of Mod. Philos.* (Eng. trans., 1900), i. 245.

GEUM, in botany, a genus of hardy perennial herbs (natural order Rosaceae) containing about thirty species, widely distributed in temperate and arctic regions. The erect flowering shoots spring from a cluster of radical leaves, which are deeply cut or lobed, the largest division being at the top of the leaf. The flowers are borne singly on long stalks at the end of the stem or its branches. They are white, yellow or red in colour, and shallowly cup-shaped. The fruit consists of a number of dry achenes, each of which bears a hook formed from the persistent lower portion of the style, and admirably adapted for ensuring distribution. Two species occur in Britain under the popular name "avens." *G. urbanum* is a very common hedge-bank plant with small yellow flowers; *G. rivale* (water avens) is a rarer plant found by streams, and has larger yellow flowers an inch or more across. The species are easy to cultivate and well adapted for borders or the rock-garden. They are propagated by seeds or by division. The most popular garden species are *G. chiloense* and its varieties, *G. coccineum* and *G. montanum*.

GEVELSBERG, a town of Germany, in the Prussian Rhine Province, 6 m. S.W. from Hagen, on the railway to Düsseldorf. It has two churches, schools and a hospital, and considerable manufactures of cutlery. Pop. (1905) 15,838.

GEX, a town of eastern France, chief town of an arrondissement in the department of Ain, 10 m. N.W. of Geneva and 3 m. from the Swiss frontier. Pop. (1906) town, 1385; commune, 2727. The town is beautifully situated 2000 ft. above sea-level at the base of the most easterly and highest chain of the Jura. It is the seat of a subprefect and has a tribunal of first instance, and carries on considerable trade in wine, cheese and other provisions, chiefly with Geneva. It gives its name to the old Pays de Gex, situated between the Alps and the Jura, which was at various times under the protection of the Swiss, the Genevese and the counts of Savoy, until in 1601 it came into the possession of France, retaining, however, until the Revolution its old independent jurisdiction, with Gex as its chief town. The Pays de Gex is isolated by the Jura from the rest of French territory, and comes within the circumscription of the Swiss customs, certain restrictions being imposed on its products by the French customs.

GEYSER, **GEISER**, or **GEISIR**, a natural spring or fountain which discharges into the air, at more or less regular intervals of time, a column of heated water and steam; it may consequently be regarded as an intermittent hot spring. The word is the Icelandic *geysir*, gusher or rager, from the verb *geysa*, a derivative of *gjosa*, to gush. In native usage it is the proper name of the Great Geyser, and not an appellative—the general term *hærr*, a hot spring, making the nearest approach to the European sense of the word (see Cleasby and Vigfusson, *Icelandic English Dictionary*, s.v.).

Any hot spring capable of depositing siliceous material by the evaporation of its water may in course of time transform itself into a geyser, a tube being gradually built up as the level of the basin is raised, much in the same manner as a volcanic cone is produced. Every geyser continuing to deposit siliceous material is preparing its own destruction; for as soon as the tube becomes deep enough to contain a column of water sufficiently heavy to prevent the lower strata attaining their boiling points, the whole mechanism is deranged. The deposition of the sinter is due in part to the cooling and evaporation of the siliceous waters, and in part to the presence of living algae. In geyser districts it is easy to find thermal springs busy with the construction of the tube; warm pools, or *lauge*, as the Icelanders call them, on the top of siliceous mounds, with the mouth of

the shaft still open in the middle; and dry basins from which the water has receded with their shafts now choked with rubbish.

Geysers exist at the present time in many volcanic regions, as in the Malay Archipelago, Japan and South America; but the three localities where they attain their highest development are Iceland, New Zealand and the Yellowstone Park, U.S.A. The very name by which we call them indicates the historical priority of the Iceland group.

The Iceland geysers, mentioned by Saxo Grammaticus, are situated about 30 m. N.W. of Hecla, in a broad valley at the foot of a range of hills from 300 to 400 ft. in height. Within a circuit of about 2 m., upwards of one hundred hot springs may be counted, varying greatly both in character and dimensions. The Great Geysir in its calm periods appears as a circular pool about 60 ft. in diameter and 4 ft. in depth, occupying a basin on the summit of a mound of siliceous concretion; and in the centre of the basin is a shaft, about 10 ft. in diameter and 70 ft. in depth, lined with the same siliceous material. The clear sea-green water flows over the eastern rim of the basin in little runnels. On the surface it has a temperature of from 76° to 89° C., or from 168° to 188° F. Within the shaft there is of course a continual shifting both of the average temperature of the column and of the relative temperatures of the several strata. The results of the observations of Bunsen and A. L. O. Descloizeaux in 1847 were as follows (cf. *Pogg. Ann.*, vol. 72 and *Comptes rendus*, vol. 19): About three hours after a great eruption on July 6, the temperature 6 metres from the bottom of the shaft was 121.6° C.; at 9.50 metres, 121.1°; at 16.30 metres, 109° (?); and at 19.70 metres, 95° (?). About nine hours after a great eruption on July 6, at about 0.3 metres from the bottom, it was 123°; at 4.8 metres it was 122.7°; at 0.6 metres, 113°; at 14.4 metres, 85.8°; at 19.2 metres, 82.6°. On the 7th, there having been no eruption since the previous forenoon, the temperature at the bottom was 127.5°; at 5 metres from the bottom, 123°; at 9 metres, 120.4°; at 14.75 metres, 106.4°; and at 19 metres, 55°. About three hours after a small eruption, which took place at forty minutes past three o'clock in the afternoon of the 7th, the temperature at the bottom was 126.5°; at 6.85 metres up it was 121.8°; at 14.75 metres, 110°; and at 19 metres, 55°. Thus, continues Bunsen, it is evident that the temperature of the column diminishes from the bottom upwards; that, leaving out of view small irregularities, the temperature in all parts of the column is found to be steadily on the increase in proportion to the time that has elapsed since the previous eruption; that even a few minutes before the great eruption the temperature at no point of the water column reached the boiling point corresponding to the atmospheric pressure at that part; and finally, that the temperature about half-way up the shaft made the nearest approach to the appropriate boiling point, and that this approach was closer in proportion as an eruption was at hand. The Great Geysir has varied very much in the nature and frequency of its eruptions since it began to be observed. In 1809 and 1810, according to Sir W. J. Hooker and Sir George S. Mackenzie, its columns were 100 or 90 ft. high, and rose at intervals of 30 hours, while, according to Henderson, in 1815 the intervals were of 6 hours and the altitude from 80 to 150 ft.

About 100 paces from the Great Geysir is the *Strokkur* or churn, which was first described by Stanley in 1789. The shaft in this case is about 44 ft. deep, and, instead of being cylindrical, is funnel-shaped, having a width of about 8 ft. at the mouth, but contracting to about 10 in. near the centre. By casting stones or turf into the shaft so as to stopper the narrow neck, eruptions can be accelerated, and they often exceed in magnitude those of the Great Geysir itself. During quiescence the column of water fills only the lower part of the shaft, its surface usually lying from 9 to 12 ft. below the level of the soil. Unlike that of the Great Geysir, it is always in ebullition, and its temperature is subject to comparatively slight differences. On the 8th of July 1847 Bunsen found the temperature at the bottom 112.9° C.; at 3 metres from the bottom, 111.4°; and at 6 metres, 108°; the whole depth of water was on that occasion 10.15 metres. On the 6th, at 2.90 metres from the bottom it was 114.2°; and

at 6.20 metres, 109.3°. On the 10th, at 0.35 metres from the bottom, the reading gave 113.9°; at 4.65 metres, 113.7°; and at 8.85 metres, 99.9°.

The great geysir-district of New Zealand is situated in the south of the province of Auckland in or near the upper basin of the Waikato river, to the N.E. of Lake Taupo. The scene presented in various parts of the districts is far more striking and beautiful than anything of the same kind to be found in Iceland, but this is due not so much to the grandeur of the geysers proper as to the bewildering profusion of boiling springs, steam-jets and mud-volcanoes, and to the fantastic effects produced on the rocks by the siliceous deposits and by the action of the boiling water. In about 1880 the geysers were no longer active, and this condition prevailed until the

Tarawera eruption of 1886, when seven gigantic geysers came into existence; water, steam, mud and stones were discharged to a height of 600 to 800 ft. for a period of about four hours, when quieter conditions set in. Waikite near Lake Rotorua throws the column to a height of 30 or 35 ft.

In the Yellowstone National Park, in the north-west corner of Wyoming, the various phenomena of the geysers can be observed on the most portentous scale. The geysers proper are about one hundred in number; the non-eruptive hot springs are much more numerous, there being more than 3000. The dimensions and activity of several of the geysers render those of Iceland and New Zealand almost insignificant in comparison. The principal groups are situated along the course of that tributary of the Upper Madison which bears the name of Fire Hole River. Many of the individual geysers have very distinctive characteristics in the form and colour of the mound, in the style of the eruption and in the shape of the column. The "Giantess" lifts the main column to a height of only 50 or 60 ft., but shoots a thin spire to no less than 250 ft. The "Castle" varies in height from 10 or 15 to 250 ft.; and on the occasions of greatest effort the noise is appalling, and shakes the ground like an earthquake. "Old

Faithful" owes its name to the regularity of its action. Its eruptions, which raise the water to a height of 100 or 150 ft., last for about five minutes, and recur every hour or thereabouts. The "Beehive" sometimes attains a height of 219 ft.; and the water, instead of falling back into the basin, is dissipated in spray and vapour. Very various accounts are given of the "Giant." F. V. Hayden saw it playing for an hour and twenty minutes, and reaching a height of 140 ft., and Doane says it continued in action for three hours and a half, and had a maximum of 200 ft.; but at the earl of Dunraven's visit the eruption lasted only a few minutes.

Theory of Geysers.—No satisfactory explanation of the phenomena of geysers was advanced till near the middle of the 19th century, when Bunsen elucidated their nature. Sir George Mackenzie, in his *Travels in Iceland* (2nd ed., 1812), submitted a theory which partially explained the phenomena met with. "Let us suppose a cavity C (fig. 1), communicating with the pipe PQ, filled with boiling water to the height AB, and that the steam above this line is confined so that it sustains the water to the height P. If we suppose a sudden addition of heat to be applied under the cavity C, a quantity of steam will be produced which, owing to the great pressure, will be evolved in starts, causing the noises like discharges of artillery and the shaking of the ground." He admitted that this could be only a partial explanation of the facts of the case, and that he was unable

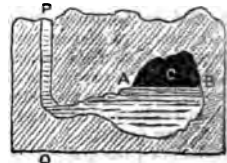

FIG. 1.



FIG. 2.

to account for the frequent and periodical production of the necessary heat; but he has the credit of hitting on what is certainly the proximate cause—the sudden evolution of steam. By Bunsen's theory the whole difficulty is solved, as is beautifully demonstrated by the artificial geyser designed by J. H. J. Müller of Freiburg (fig. 2). If the tube *ab* be filled with water and heated at two points, first at *a* and then at *b*, the following succession of changes is produced. The water at *a* beginning to boil, the superincumbent column is consequently raised, and the stratum of water which was on the point of boiling at *b* being raised to *d* is there subjected to a diminished pressure; a sudden evolution of steam accordingly takes place at *d*, and the superincumbent water is violently ejected. Received in the basin *c*, the air-cooled water sinks back into the tube, and the temperature of the whole column is consequently lowered; but the under strata of water are naturally those which are least affected by the cooling process; the boiling begins again at *a*, and the same succession of events is the result (see R. Bunsen, "Physikalische Beobachtungen über die hauptsächlichsten Geisire Islands," *Pogg. Ann.*, 1847, vol. 72; and Müller, "Über Bunsen's Geysirtheorie," *ibid.*, 1850, vol. 79).

The principal difference between the artificial and the natural geyser-tube is that in the latter the effect is not necessarily produced by two distinct sources of heat like the two fires of the experimental apparatus, but by the continual influx of heat from the bottom of the shaft, and the difference between the boiling-points of the different parts of the column owing to the different pressures of the superincumbent mass. This may be thus illustrated: AB is the column of water; on the right side the figures represent approximately the boiling-points (Fahr.) calculated according to the ordinary laws, and the figures on the left the actual temperature of the same places. Both gradually increase as we descend, but the relation between the two is very different at different heights. At the top the water is still 30° from its boiling-point, and even at the bottom it is 19°; but at D the deficiency is only 4°. If, then, the stratum at D be suddenly lifted as high as C, it will be 2° above the boiling-point there, and will consequently expend those 2° in the formation of steam.

GEZER (the Kazir of Thethmosis [Thothmes] III.'s list of Palestinian cities and the Gazri of the Amarna tablets), a royal Canaanite city on the boundary of Ephraim, in the maritime plain (Josh. xvi. 3-10), and near the Philistine border (2 Sam. v. 25). It was allotted to the Levites, but its original inhabitants were not driven out until the time of Solomon, when "Pharaoh, king of Egypt" took the city and gave it as a dowry to his daughter, Solomon's wife (1 Kings ix. 16). Under the form Gazera it is mentioned (1 Macc. iv. 15) as being in the neighbourhood of Emmaus-Nicopolis ('Amwās) and Jamnia (Yebnah). Throughout the history of the Maccabean wars Gezer or Gazara plays the part of an important frontier post. It was first taken from the Syrians by Simon the Asmonean (1 Macc. xiv. 7). Josephus also mentions that the city was "naturally strong" (*Antiq.* viii. 6. 1). The position of Gezer is defined by Jerome (*Onomasticon*, s.v.) as four Roman miles north (*contra septentrionem*) of Nicopolis ('Amwās). This points to the mound of debris called *Tell-el-Jezari* near the village of Abū Shūsheh. The site is naturally very strong, the town standing on an isolated hill, commanding the western road to Jerusalem just where it begins to enter the mountains of Judea. This identification has been confirmed by the discovery of a series of boundary inscriptions, apparently marking the limit of the city's lands, which have been found cut in rock—outcrops partly surrounding the site. They read in every case *ḥm*, "the boundary of Gezer," with the name *Alkios* in Greek, probably that of the governor under whom the inscriptions were cut. The site has been partially excavated by the Palestine Exploration Fund, and an enormous mass of material for the history of Palestine recovered from it, including remains of a pre-Semitic aboriginal race, a remarkably perfect High Place, the castle built by Simon, and other remains of the first importance.

See R. A. S. Macalister's reports in *Palestine Exploration Fund Quarterly Statement* (October 1902 onwards). Also *Bible Sidelights from the Mount of Gezer*, by the same writer. (R. A. S. M.)

GFBRÖRER, AUGUST FRIEDRICH (1803-1861), German historian, was born at Calw, Württemberg, on the 5th of March

† So written; with a medial *m* (o) instead of the final (o).

1803, and at the close of his preliminary studies at the seminary of Blaubeuren entered the university of Tübingen in 1821 as a student of evangelical theology. After passing his final examinations in 1825, he spent a year in Switzerland, during part of the time acting as companion and secretary to C. von Bonstetten (1745-1832); the year 1827 was spent chiefly in Rome. Returning to Württemberg in 1828, he first undertook the duties of repetent or theological tutor in Tübingen, and afterwards accepted a curacy in Stuttgart; but having in 1830 received an appointment in the royal public library at Stuttgart, he thenceforth gave himself exclusively to literature and historical science. His first work on Philo (*Philo u. die jüdisch-alexandrinische Theosophie*, Stuttgart, 1831) was rapidly followed by an elaborate biography, in two volumes, of Gustavus Adolphus (*Gustav Adolf, König von Schweden, und seine Zeit*, Stuttgart, 1835-1837), and by a critical history of primitive Christianity (*Kritische Geschichte des Urchristentums*, 3 vols., Stuttgart, 1838). Here Gfrörer had manifested opinions unfavourable to Protestantism, which, however, were not openly avowed until fully developed in his church history (*Allgemeine Kirchengeschichte bis Beginn des 14ten Jahrhunderts*, Stuttgart, 1841-1846). In the autumn of 1846 he was appointed to the chair of history in the university of Freiburg, where he continued to teach until his death at Carlsbad on the 6th of July 1861. In 1848 he sat as a representative in the Frankfort parliament, where he supported the "High German" party, and in 1853 he publicly went over to the Church of Rome. He was a bitter opponent of Prussia and an ardent controversialist.

Among his later historical works the most important is the *Geschichte der ost- u. westfränkischen Karolinger* (Freiburg, 1848); but those on the pseudo-Isidorian Decretals (*Untersuchung über Alter, Ursprung, u. Werth der Decretalen des falschen Isidorus*, 1848), on the primitive history of mankind (*Urgeschichte des menschlichen Geschlechts*, 1855), on Hildebrand (*Papst Gregorius VII. u. sein Zeitalter*, 7 vols., 1859-1861), on the history of the 18th century (*Geschichte des 18ten Jahrhunderts*, 1862-1873), on German popular rights (*Zur Geschichte deutscher Volksrechte im Mittelalter*, Basel, 1865-1866) and on Byzantine history (*Byzantinische Geschichten*, 1872-1874), are also of real value.

GHADAMES, GADAMES or READĀMES, a town in an oasis of the same name, in that part of the Sahara which forms part of the Turkish vilayet of Tripoli. It is about 300 m. S.W. of the city of Tripoli and some 10 m. E. of the Algerian frontier. According to Gerhard Rohlfs, the last form given to the word most correctly represents the Arabic pronunciation, but the other forms are more often used in Europe. The streets of the town are narrow and vaulted and have been likened to the bewildering galleries of a coalpit. The roofs are laid out as gardens and preserved for the exclusive use of the women. The Ghadamsi merchants have been known for centuries as keen and adventurous traders, and their agents are to be found in the more important places of the western and central Sudan, such as Kano, Katsena, Kanem, Bornu, Timbuktu, as well as at Ghat and Tripoli. Ghadames itself is the centre of a large number of caravan routes, and in the early part of the 19th century about 30,000 laden camels entered its markets every year. The caravan trade was created by the Ghadamsi merchants who, aided by their superior intelligence, capacity and honesty, long enjoyed a monopoly. In 1873 Tripolitan merchants began to compete with them. In 1893 came the invasion of Bornu by Rabah, and the total stoppage of this caravan route for nearly ten years to the great detriment of the merchants of Ghadames. The caravans from Kano were also frequently pillaged by the Tuareg, so that the prosperity of the town declined. Later on, the opening of rapid means of transport from Kano and other cities to the Gulf of Guinea also affected Ghadames, which, however, maintains a considerable trade. The chief articles brought by the caravans are ostrich leathers, skins and ivory and one of the principal imports is tea. In 1845 the population was estimated at 3000, of whom about 500 were slaves and strangers, and upwards of 1200 children; in 1905 it amounted in round numbers to 7000. The inhabitants are chiefly Berbers and Arabs. A Turkish garrison is maintained in the town.

Before the Christian era Ghadames was a stronghold of the

Garamantes whose power was overthrown in the days of Augustus by L. Cornelius Balbus Minor, who captured Ghadames (Cydamus). It is not unlikely that Roman settlers may have been attracted to the spot by the presence of the warm springs which still rise in the heart of the town, and spread fertility in the surrounding gardens. In the 7th century Ghadames was conquered by the Arabs. It appears afterwards to have fallen under the power of the rulers of Tunisia, then to a native dynasty which reigned at Tripoli, and in the 16th century it became part of the Turkish vilayet of Tripoli. It has since then shared the political fortunes of that country. In the first half of the 19th century it was visited by several British explorers and later by German and French travellers.

See J. Richardson, *Travels in the Great Desert of Sahara in 1845-1846... including a Description of... Ghadames* (London, 1848); G. Rohlf, *Reise durch Marokko... und Reise durch die Grosse Wüste über Rhadames nach Tripoli* (Bremen, 1868).

GHAT, or **RHAT**, an oasis and town, forming part of the Turkish vilayet of Tripoli. Ghat is an important centre of the caravan trade between the Nigerian states and the seaports of the Mediterranean (see TRIPOLI).

GHATS, or **GHAUTS** (literally "the Landing Stairs" from the sea, or "Passes"), two ranges of mountains extending along the eastern and western shores of the Indian peninsula. The word properly applies to the passes through the mountains, but from an early date was transferred by Europeans to the mountains themselves.

The Eastern Ghats run in fragmentary spurs and ranges down the Madras coast. They begin in the Orissa district of Balasore, pass southwards through Cuttack and Puri, enter the Madras presidency in Ganjam, and sweep southwards through the districts of Vizagapatam, Godavari, Nellore, Chingleput, South Arcot, Trichinopoly and Tinnevely. They run at a distance of 50 to 150 m. from the coast, except in Ganjam and Vizagapatam, where in places they almost abut on the Bay of Bengal. Their geological formation is granite, with gneiss and mica slate, with clay slate, hornblende and primitive limestone overlying. The average elevation is about 1500 ft., but several hills in Ganjam are between 4000 and 5000 ft. high. For the most part there is a broad expanse of low land between their base and the sea, and their line is pierced by the Godavari, Kistna and Cauvery rivers.

The Western Ghats (Sahyadri in Sanskrit) start from the south of the Tapti valley, and run south through the districts of Khandesh, Nasik, Thana, Satara, Ratnagiri, Kanara and Malabar, and the states of Cochin and Travancore, meeting the Eastern Ghats at an angle near Cape Comorin. The range of the Western Ghats extends uninterrupted, with the exception of a gap or valley 25 m. across, known as the Palghat gap, through which runs the principal railway of the south of India. The length of the range is 800 m. from the Tapti to the Palghat gap, and south of this about 200 m. to the extreme south of the peninsula. In many parts there is only a narrow strip of coast between the hills and the sea; at one point they rise in magnificent precipices and headlands out of the ocean. The average elevation is 3000 ft., precipitous on the western side facing the sea, but with a more gradual slope on the east to the plains below. The highest peaks in the northern section are Kalsubai, 5427 ft.; Harischandragarh, 4691 ft.; and Mahabaleshwar, where is the summer capital of the government of Bombay, 4700 ft. South of Mahabaleshwar the elevation diminishes, but again increases, and attains its maximum towards Coorg, where the highest peaks vary from 5500 to 7000 ft., and where the main range joins the interior Nilgiri hills. South of the Palghat gap, the peaks of the Western Ghats rise as high as 8000 ft. The geological formation is trap in the northern and gneiss in the southern section.

GHAZALI [Muhammad ibn Muhammad Abū Hāmid al-Ghazālī] (1058-1111), Arabian philosopher and theologian, was born at Tūs, and belonged to a family of Ghazāla (near Tūs) distinguished for its knowledge of canon law. Educated at first in Tūs, then in Jorjān, and again in Tūs, he went to college at Nishāpūr, where he studied under Juwainī (known as the

Imām ul-Haramain) until 1085, when he visited the celebrated vizier Nizām ul-Mulk, who appointed him to a professorship in his college at Bagdad in 1091. Here he was engaged in writing against the Isma'ilites (Assassins). After four years of this work he suddenly gave up his chair, left home and family and gave himself to an ascetic life. This was due to a growing scepticism, which caused him much mental unrest and which gradually gave way to mysticism. Having secured his chair for his brother he went to Damascus, Jerusalem, Hebron, Mecca, Medina and Alexandria, studying, meditating and writing in these cities. In 1106 he was tempted to go to the West, where the Moravid (Almoravid) reformation was being led by Yūsuf ibn Tāshīn, with whom he had been in correspondence earlier. Yūsuf, however, died in this year, and Ghazālī abandoned his idea. At the wish of the sultan Malik Shah he again undertook professional work, this time in the college of Nizām ul-Mulk at Nishāpūr, but returned soon after to Tūs, where he died in December 1111.

Sixty-nine works are ascribed to Ghazālī (cf. C. Brockelmann's *Gesch. d. arabischen Litteratur*, i. 421-426, Weimar, 1898). The most important of those which have been published are: a treatise on eschatology called *Ad-durrat ul-fākhirā* ("The precious pearl"); ed. L. Gautier (Geneva, 1878); the great work, *Ikhyā ul-Ulūm* ("Revival of the sciences") (Bulaq, 1872; Cairo, 1889); see a commentary by al-Murtada called the *Ilhāf*, published in 13 vols. at Fez, 1885-1887, and in 10 vols. at Cairo, 1893; the *Bidayat ul-Hidāya* (Bulaq, 1870, and often at Cairo); a compendium of ethics, *Mizān ul-Amāl*, translated into Hebrew, ed. J. Goldenthal (Paris, 1839); a more popular treatise on ethics, the *Kimīya us-Sa'āda*, published at Lucknow, Bombay and Constantinople, ed. H. A. Homes as *The Alchemy of Happiness* (Albany, N.Y., 1873); the ethical work *O Child*, ed. by Hammer-Purgstall in Arabic and German (Vienna, 1838); the *Destruction of Philosophers (Tahafut ul-Falāsifa)* (Cairo, 1885, and Bombay, 1887). Of this work a French translation was begun by Carra de Vaux in *Muséon*, vol. xviii. (1899); the *Mogāzib ul-Falāsifa*, of which the first part on logic was translated into Latin by Dom. Gundisalvi (Venice, 1506), ed. with notes by G. Beer (Leiden, 1888); the *Kitāb ul-Munqid*, giving an account of the changes in his philosophical ideas, ed. by F. A. Schmölders in his *Essai sur les écoles philosophiques chez les Arabes* (Paris, 1842), also printed at Constantinople, 1876, and translated into French by Barbier de Meynard in the *Journal asiatique* (1877, i. 1-93); answers to questions asked of him ed. in Arabic and Hebrew, with German translation and notes by H. Malter (Frankfort, 1896); Eng. trans., *Confessions of al-Ghazzali*, by Claud Field (1909).

For Ghazālī's life see McG. de Siane's translation of Ibn Khallikān, ii. 621 ff.; R. Göschel's *Über Ghazzālī's Leben und Werke* (Berlin, 1859); D. B. Macdonald's "Life of al-Ghazzālī," in *Journal of American Oriental Society*, vol. xx. (1899), and Carra de Vaux's *Gazālī* (Paris, 1902); see ARABIAN PHILOSOPHY. (G. W. T.)

GHAZI (an Arabic word, from *ghazā*, to fight), the name given to Mahomedans who have vowed to exterminate unbelievers by the sword. It is also used as a title of honour, generally translated "the Victorious," in the Ottoman empire for military officers of high rank, who have distinguished themselves in the field against non-Moslem enemies; thus it was conferred on Osman Pasha after his famous defence of Plevna.

GHAZIABAD, a town of British India in Meerut district of the United Provinces, 12 m. from Delhi and 28 m. from Meerut. Pop. (1901) 11,275. The town was founded in 1740 by Ghazi-uddin, son of Azaf Jah, first nizām of the Deccan, and takes its name from its founder. It has considerably risen in importance as the point of junction of the East Indian, the North-Western and the Oudh & Rohilkhand railway systems. The town has a trade in grain and hides.

GHAZIPUR, a town and district of British India, in the Benares division of the United Provinces. The town stands on the left bank of the Ganges, 44 m. E. of Benares. It is the headquarters of the government opium department, where all the opium from the United Provinces is collected and manufactured under a monopoly. There are also scent distilleries, using the produce of the rose-gardens in the vicinity. Lord Cornwallis, governor-general of India, died at Ghazipur in 1805, and a domed monument and marble statue (by Flaxman) are erected over his grave. Pop. (1901) 39,429.

The district of Ghazipur has an area of 1389 sq. m. It forms part of the great alluvial plain of the Ganges, which divides it into two unequal portions. The northern subdivision lies

between the Gumti and the Gogra, whose confluences with the main stream mark its eastern and western limits respectively. The southern tract is a much smaller strip of country, enclosed between the Karamnasa and the great river itself. There are no hills in the district. A few lakes are scattered here and there, formed where the rivers have deserted their ancient channels. The largest is that of Suraha, once a northern bend of the Ganges, but now an almost isolated sheet of water, 5 m. long by about 4 broad. Ghazipur is said to be one of the hottest and dampest districts in the United Provinces. In 1901 the population was 913,818, showing a decrease of 11% in the decade. Sugar refining is the chief industry, and provides the principal article of export. The main line of the East Indian railway traverses the southern portion of the district, with a branch to the Ganges bank opposite Ghazipur town; the northern portion is served by the Bengal & North-Western system.

GHAZNI, a famous city in Afghanistan, the seat of an extensive empire under two medieval dynasties, and again of prominent interest in the modern history of British India. Ghazni stands on the high tableland of central Afghanistan, in 68° 18' E. long., 33° 44' N. lat., at a height of 7280 ft. above the sea, and on the direct road between Kandahar and Kabul, 221 m. by road N.E. from the former, and 92 m. S.W. from the latter. A very considerable trade in fruit, wool, skins, &c., is carried on between Ghazni and India by the Povindah kafilas, which yearly enter India in the late autumn and pass back again to the Afghan highlands in the early spring. The Povindah merchants invariably make use of the Gomal pass which leads to the British frontier at Dera Ismail Khan. The opening up of this pass and the British occupation of Wana, by offering protection to the merchants from Waziri blackmailing, largely increased the traffic.

Ghazni, as it now exists, is a place in decay, and probably does not contain more than 4000 inhabitants. It stands at the base of the terminal spur of a ridge of hills, an offshoot from the Gul-Koh, which forms the watershed between the Arghandāb, and Tarnak rivers. The castle stands at the northern angle of the town next the hills, and is about 150 ft. above the plain. The town walls stand on an elevation, partly artificial, and form an irregular square, close on a mile in circuit (including the castle), the walls being partly of stone or brick laid in mud, and partly of clay built in courses. They are flanked by numerous towers. There are three gates. The town consists of dirty and very irregular streets of houses several stories high, but with two straighter streets of more pretension, crossing near the middle of the town. Of the strategical importance of Ghazni there can hardly be a question. The view to the south is extensive, and the plain in the direction of Kandahar stretches to the horizon. It is bare except in the vicinity of the river, where villages and gardens are tolerably numerous. Abundant crops of wheat and barley are grown, as well as of madder, besides minor products. The climate is notoriously cold,—snow lying 2 or 3 ft. deep for about three months, and tradition speaks of the city as having been more than once overwhelmed by snowdrift. Fuel is scarce, consisting chiefly of prickly shrubs. In summer the heat is not like that of Kandahar or Kabul, but the radiation from the bare heights renders the nights oppressive, and constant dust-storms occur. It is evident that the present restricted walls cannot have contained the vaunted city of Mahmud. Probably the existing site formed the citadel only of his city. The remarks of Ibn Batuta (c. 1332) already suggest the present state of things, viz. a small town occupied, a large space of ruin; for a considerable area to the N.E. is covered with ruins, or rather with a vast extent of shapeless mounds, which are pointed out as Old Ghazni. The only remains retaining architectural character are two remarkable towers rising to the height of about 140 ft., and some 400 yds. apart from each other. They are similar, but whether identical, in design, is not clearly recorded. They belong, on a smaller and far less elaborate scale, to the same class as the Kutb Minar at Delhi (q.v.). Arabic inscriptions in Cufic characters show the most northerly to have been the work of Mahmud himself, the

other that of his son Masa'ud. On the Kabul road, a mile beyond the Minaret of Mahmud, is a village called Rauzah ("the Garden," a term often applied to garden-mausoleums). Here, in a poor garden, stands the tomb of the famous conqueror. It is a prism of white marble standing on a plinth of the same, and bearing a Cufic inscription praying the mercy of God on the most noble Amir, the great king, the lord of church and state, Abul Kasim Mahmud, son of Sabuktagin. The tomb stands in a rude chamber, covered with a dome of clay, and hung with old shawls, ostrich eggs, tiger-skins and so forth. The village stands among luxuriant gardens and orchards, watered by a copious aqueduct. Sultan Baber celebrates the excellence of the grapes of Rauzah.

There are many holy shrines about Ghazni surrounded by orchards and vineyards. Baber speaks of them, and tells how he detected and put a stop to the imposture of a pretended miracle at one of them. These sanctuaries make Ghazni a place of Moslem pilgrimage, and it is said that at Constantinople much respect is paid to those who have worshipped at the tomb of the great Ghazi. To test the genuineness of the boast, professed pilgrims are called on to describe the chief *notabilia* of the place, and are expected to name all those detailed in certain current Persian verses.

History.—The city is not mentioned by any narrator of Alexander's expedition, nor by any ancient author so as to admit of positive recognition. But it is very possibly the *Gasaca* which Ptolemy places among the *Paropamisadae*, and this may not be inconsistent with Sir H. Rawlinson's identification of it with *Gasos*, an Indian city spoken of by two obscure Greek poets as an impregnable place of war. The name is probably connected with the Persian and Sanskrit *ganj* and *ganja*, a treasury (whence the Greek and Latin *Gasa*). We seem to have positive evidence of the existence of the city before the Mahomedan times (644) in the travels of the Chinese pilgrim, Hsuan Tsang, who speaks of *Ho-si-na* (i.e. probably *Ghasni*) as one of the capitals of *Tsaukuta* or Arachosia, a place of great strength. In early Mahomedan times the country adjoining Ghazni was called *Zābul*. When the Mahomedans first invaded that region Ghazni was a wealthy entrepot of the Indian trade. Of the extent of this trade some idea is given by Ibn Haukal, who states that at Kabul, then a mart of the same trade, there was sold yearly indigo to the value of two million dinars (£1,000,000). The enterprise of Islam underwent several ebbs and flows over this region. The provinces on the Helmund and about Ghazni were invaded as early as the caliphate of Moaiya (662–680). The arms of Yaqub b. Laith swept over Kabul and Arachosia (Al-Rukhā) about 871, and the people of the latter country were forcibly converted. Though the Hindu dynasty of Kabul held a part of the valley of Kabul river till the time of Mahmud, it is probably to the period just mentioned that we must refer the permanent Mahomedan occupation of Ghazni. Indeed, the building of the fort and city is ascribed by a Mahomedan historian to Amr b. Laith, the brother and successor of Ya'kub (d. 901), though the facts already stated discredit this. In the latter part of the 9th century the family of the Samanid, sprung from Samarkand, reigned in splendour at Bokhara. Alptagin, originally a Turkish slave, and high in the service of the dynasty, about the middle of the 10th century, losing the favour of the court, wrested Ghazni from its chief (who is styled Abu Bakr Lawik, wali of Ghazni), and established himself there. His government was recognized from Bokhara, and held till his death. In 977 another Turk slave, Sabuktagin, who had married the daughter of his master Alptagin, obtained rule in Ghazni. He made himself lord of nearly all the present territory of Afghanistan and of the Punjab. In 997 Mahmud, son of Sabuktagin, succeeded to the government, and with his name Ghazni and the Ghaznevid dynasty have become perpetually associated. Issuing forth year after year from that capital, Mahmud (q.v.) carried fully seventeen expeditions of devastation through northern India and Gujarat, as well as others to the north and west. From the borders of Kurdistan to Samarkand, from the Caspian to the Ganges, his authority was acknowledged.

The wealth brought back to Ghazni was enormous, and contemporary historians give glowing descriptions of the magnificence of the capital, as well as of the conqueror's munificent support of literature. Mahmud died in 1030, and some fourteen kings of his house came after him; but though there was some revival of importance under Ibrahim (1050-1099), the empire never reached anything like the same splendour and power. It was overshadowed by the Seljuks of Persia, and by the rising rivalry of Ghor (*q.v.*), the hostility of which it had repeatedly provoked. Bahram Shah (1118-1152) put to death Kutbuddin, one of the princes of Ghor, called king of the Jibal or Hill country, who had withdrawn to Ghazni. This prince's brother, Saifuddin Suri, came to take vengeance, and drove out Bahram. But the latter recapturing the place (1149) paraded Saifuddin and his vizier ignominiously about the city, and then hanged them on the bridge. Ala-uddin of Ghor, younger brother of the two slain princes, then gathered a great host, and came against Bahram, who met him on the Helmund. The Ghor prince, after repeated victories, stormed Ghazni, and gave it over to fire and sword. The dead kings of the house of Mahmud, except the conqueror himself and two others, were torn from their graves and burnt, whilst the bodies of the princes of Ghor were solemnly disinterred and carried to the distant tombs of their ancestors. It seems certain that Ghazni never recovered the splendour that perished then (1152). Ala-uddin, who from this deed became known in history as *Jahān-sā* (*Brâlemonde*), returned to Ghor, and Bahram reoccupied Ghazni; he died in 1157. In the time of his son Khusrū Shah, Ghazni was taken by the Turkish tribes called Turkomans (generally believed to have been what are now called Turkomans). The king fled to Lahore, and the dynasty ended with his son. In 1173 the Ghuzz were expelled by Ghiyasuddin sultan of Ghor (nephew of Ala-uddin Jahansoz), who made Ghazni over to his brother Muizuddin. This famous prince, whom the later historians call Mahommed Ghorī, shortly afterwards (1174-1175) invaded India, taking Multan and Uchh. This was the first of many successive inroads on western and northern India, in one of which Lahore was wrested from Khusrū Malik, the last of Mahmud's house, who died a captive in the hills of Ghor. In 1192 Prithvi Rai or Pithora (as the Moslem writers call him), the Chauhan king of Ajmere, being defeated and slain near Thanewar, the whole country from the Himalaya to Ajmere became subject to the Ghorī king of Ghazni. On the death of his brother Ghiyasuddin, with whose power he had been constantly associated, and of whose conquests he had been the chief instrument, Muizuddin became sole sovereign over Ghor and Ghazni, and the latter place was then again for a brief period the seat of an empire nearly as extensive as that of Mahmud the son of Sabuktagin. Muizuddin crossed the Indus once more to put down a rebellion of the Khokhars in the Punjab, and on his way back was murdered by a band of them, or, as some say, by one of the *Mulhidah* or Assassins. The slave lieutenants of Muizuddin carried on the conquest of India, and as the rapidly succeeding events broke their dependence on any master, they established at Delhi that monarchy of which, after it had endured through many dynasties, and had culminated with the Mogul house of Baber, the shadow perished in 1857. The death of Muizuddin was followed by struggle and anarchy, ending for a time in the annexation of Ghazni to the empire of Khwarizm by Mahommed Shah, who conferred it on his famous son, Jelaluddin, and Ghazni became the headquarters of the latter. After Jenghiz Khan had extinguished the power of his family in Turkestan, Jelaluddin defeated the army sent against him by the Mongol at Parwan, north of Kabul. Jenghiz then advanced and drove Jelaluddin across the Indus, after which he sent Ogdai his son to besiege Ghazni. Henceforward Ghazni is much less prominent in Asiatic history. It continued subject to the Mongols, sometimes to the house of Hulagu in Persia, and sometimes to that of Jagatai in Turkestan. In 1326, after a battle between Amir Hosain, the viceroy of the former house in Khorasan, and Tarmashirin, the reigning khan of Jagatai, the former entered Ghazni and once more subjected it to devastation, and this time the tomb of Mahmud to desecration.

Ibn Batuta (*c.* 1332) says the greater part of the city was in ruins, and only a small part continued to be a town. Timur seems never to have visited Ghazni, but we find him in 1401 bestowing the government of Kabul, Kandahar, and Ghazni on Pir Mahommed, the son of his son Jahangir. In the end of the century it was still in the hands of a descendant of Timur, Ulugh Beg Mirza, who was king of Kabul and Ghazni. The illustrious nephew of this prince, Baber, got peaceful possession of both cities in 1504, and has left notes on both in his own inimitable Memoirs. His account of Ghazni indicates how far it had now fallen. "It is," he says, "but a poor mean place, and I have always wondered how its princes, who possessed also Hindustan and Khorasan, could have chosen such a wretched country for the seat of their government, in preference to Khorasan." He commends the fruit of its gardens, which still contribute largely to the markets of Kabul. Ghazni remained in the hands of Baber's descendants, reigning at Delhi and Agra, till the invasion of Nadir Shah (1738), and became after Nadir's death a part of the new kingdom of the Afghans under Ahmad Shah Durani. We know of but two modern travellers who have recorded visits to the place previous to the war of 1839. George Forster passed as a disguised traveller with a qafila in 1783. "Its slender existence," he says, "is now maintained by some Hindu families, who support a small traffic, and supply the wants of the few Mahommedan residents." Vigne visited it in 1836, having reached it from Multan with a caravan of Lobani merchants, travelling by the Gomal pass. The historical name of Ghazni was brought back from the dead, as it were, by the news of its capture by the British army under Sir John Keane, 23rd July 1839. The siege artillery had been left behind at Kandahar; escalade was judged impracticable; but the project of the commanding engineer, Captain George Thomson, for blowing in the Kabul gate with powder in bags, was adopted, and carried out successfully, at the cost of 182 killed and wounded. Two years and a half later the Afghan outbreak against the British occupation found Ghazni garrisoned by a Bengal regiment of sepoy, but neither repaired nor provisioned. They held out under great hardships from the 16th of December 1841 to the 6th of March 1842, when they surrendered. In the autumn of the same year General Nott, advancing from Kandahar upon Kabul, reoccupied Ghazni, destroyed the defences of the castle and part of the town, and carried away the famous gates of Somnath (*q.v.*).

GHEE (Hindustani *ghi*), a kind of clarified butter made in the East. The best is prepared from butter of the milk of cows, the less esteemed from that of buffaloes. The butter is melted over a slow fire, and set aside to cool; the thick, opaque, whitish, and more fluid portion, or ghee, representing the greater bulk of the butter, is then removed. The less liquid residue, mixed with ground-nut oil, is sold as an inferior kind of ghee. It may be obtained also by boiling butter over a clear fire, skimming it the while, and when all the water has evaporated, straining it through a cloth. Ghee which is rancid or tainted, as is often that of the Indian bazaars, is said to be rendered sweet by boiling with leaves of the *Moringa pterygosperma* or horse-radish tree. In India ghee is one of the commonest articles of diet, and indeed enters into the composition of everything eaten by the Brahmans. It is also extensively used in Indian religious ceremonies, being offered as a sacrifice to idols, which are at times bathed in it. Sanskrit treatises on therapeutics describe ghee as cooling, emollient and stomachic, as capable of increasing the mental powers, and of improving the voice and personal appearance, and as useful in eye-diseases, tympanitis, painful dyspepsia, wounds, ulcers and other affections. Old ghee is in special repute among the Hindus as a medicinal agent, and its efficacy as an external application is believed by them to increase with its age. Ghee more than ten years old, the *purana ghrita* of Sanskrit materia medicas, has a strong odour and the colour of lac. Some specimens which have been much longer preserved—and "clarified butter a hundred years old is often heard of"—have an earthy look, and are quite dry and hard, and nearly inodorous. Medicated ghee is made by warming ordinary ghee

to remove contained water, melting, after the addition of a little turmeric juice, in a metal pan at a gentle heat, and then boiling with the prepared drugs till all moisture is expelled, and straining through a cloth.

GHEEL, or **GEEL**, a town of Belgium, about 30 m. E. of Antwerp and in the same province. Pop. (1904) 14,087. It is remarkable on account of the colony of insane persons which has existed there for many centuries. The legend reads that in the year 600 Dymphna, an Irish princess, was executed here by her father, and in consequence of certain miracles she had effected she was canonized and made the patron saint of the insane. The old Gothic church is dedicated to her, and in the choir is a shrine, enclosing her relics, with fine panel paintings representing incidents in her life by, probably, a contemporary of Memling. The colony of the insane is established in the farms and houses round the little place within a circumference of 30 m. and is said to have existed since the 13th century. This area is divided into four sections, each having a doctor and a superintendent attached to it. The Gheel system is regarded as the most humane method of dealing with the insane who have no homicidal tendencies, as it keeps up as long as possible their interest in life.

GHENT (Flem. *Gent*, Fr. *Gand*), the capital of East Flanders, Belgium, at the junction of the Scheldt and the Lys (Ley). Pop. (1880) 131,431, (1904) 162,482. The city is divided by the rivers (including the small streams Lieve and Moere) and by canals, some navigable, into numerous islands connected by over 200 bridges of various sorts. Within the limits of the town, which is 6 m. in circumference, are many gardens, meadows and promenades; and, though its characteristic lanes are gloomy and narrow, there are also broad new streets and fine quays and docks. The most conspicuous building in the city is the cathedral of St Bavon¹ (Sint Baafs), the rich interior of which contrasts strongly with its somewhat heavy exterior. Its crypt dates from 941, the choir from 1274-1300, the Late Gothic choir chapels from the 15th century, and the nave and transept from 1533-1554. Among the treasures of the church is the famous "Worship of the Lamb" by Hubert and Jan van Eyck. Of the original 12 panels, taken to France during the Revolutionary Wars, only 4 are now here, 6 being in the Berlin museum and two in that of Brussels. Among the other 55 churches may be mentioned that of St Nicholas, an Early Gothic building, the oldest church in date of foundation in Ghent, and that of St Michael, completed in 1480, with an unfinished tower. In the centre of the city stands the unfinished Belfry (*Belfroot*), a square tower some 300 ft. high, built 1183-1339. It has a cast-iron steeple (restored in 1854), on the top of which is a gold dragon which, according to tradition, was brought from Constantinople either by the Varangians or by the emperor Baldwin after the Latin conquest. Close to it is the former Cloth-hall, a Gothic building of 1325. The hôtel-de-ville consists of two distinct parts. The northern façade, a magnificent example of Flamboyant Gothic, was erected between 1518 and 1533, restored in 1829 and again some fifty years later. The eastern façade overlooking the market-place was built in 1595-1628, in the Renaissance style, with three tiers of columns. It contains a valuable collection of archives, from the 13th century onwards. On the left bank of the Lys is the Oudeburg (s'Gravenstein, Château des Contes), the former castle of the first counts of Flanders, dating from 1180 and now restored. The château of the later counts, in which the emperor Charles V. was born, is commemorated only in the name of a street, the Cours des Princes.

To the north of the Oudeburg, on the other side of the Lys, is the Marché du Vendredi, the principal square of the city. This was the centre of the life of the medieval city, the scene of all great public functions, such as the homage of the burghers to

the counts, and of the auto-da-fés under the Spanish regime. In it stands a bronze statue of Jacob van Artevelde, by Devigné-Quyo, erected in 1863. At a corner of the square is a remarkable cannon, known as *Dulle Griete* (Mad Meg), 19 ft. long and 11 ft. in circumference. It is ornamented with the arms of Philip the Good, duke of Burgundy, and must have been cast between 1419 and 1467. On the Scheldt, near the Place Laurent, is the Geeraard-duivelsteen (château of Gerard the Devil), a 13th-century tower formerly belonging to one of the patrician families, now restored and used as the office of the provincial records. Of modern buildings may be mentioned the University (1826), the Palais de Justice (1844), and the new theatre (1848), all designed by Roelandt, and the Institut des Sciences (1890) by A. Pauli. In the park on the site of the citadel erected by Charles V. are some ruins of the ancient abbey of St Bavon and of a 12th-century octagonal chapel dedicated to St Macharius. In the park is also situated the Museum of Fine Arts, completed in 1902.

One of the most interesting institutions of Ghent is the great Béguinage (Begynhof) which, originally established in 1234 by the Bruges gate, was transferred in 1874 to the suburb of St Amandsberg. It constitutes a little town of itself, surrounded by walls and a moat, and contains numerous small houses, 18 convents and a church. It is occupied by some 700 Beguines, women devoted to good works (see BEGUINES). Near the station is a second Béguinage with 400 inmates. In addition to these there were in Ghent in 1901 fifty religious houses of various orders.

As a manufacturing centre Ghent, though not so conspicuous as it was in the middle ages, is of considerable importance. The main industries are cotton-spinning, flax-spinning, cotton-printing, tanning and sugar refining; in addition to which there are iron and copper foundries, machine-building works, breweries and factories of soap, paper, tobacco, &c. As a trading centre the city is even more important. It has direct communication with the sea by a ship-canal, greatly enlarged and deepened since 1895, which connects the Grand Basin, stretching along the north side of the city, with a spacious harbour excavated at Terneuzen on the Scheldt, 21½ m. to the north, thus making Ghent practically a sea-port; while a second canal, from the Lys, connects the city via Bruges with Ostende.

Among the educational establishments is the State University, founded by King William I. of the Netherlands in 1816. With it are connected a school of engineering, a school of arts and industries and the famous library (about 300,000 printed volumes and 2000 MSS.) formerly belonging to the city. In addition there are training schools for teachers, an episcopal seminary, a conservatoire and an art academy with a fine collection of pictures mainly taken from the religious houses of the city on their suppression in 1795. The oldest Belgian newspaper, the *Gazet van Gent*, was founded here in 1667.

History.—The history of the city is closely associated with that of the countship of Flanders (*q.v.*), of which it was the seat. It is mentioned so early as the 7th century and in 868 Baldwin of the Iron Arm, first count of Flanders, who had been entrusted by Charles the Bald with the defence of the northern marches, built a castle here against the Normans raiding up the Scheldt. This was captured in 949 by the emperor Otto I. and was occupied by an imperial burgrave for some fifty years, after which it was retaken by the counts of Flanders. Under their protection, and favoured by its site, the city rapidly grew in wealth and population, the zenith of its power and prosperity being reached between the 13th and 15th centuries, when it was the emporium of the trade of Germany and the Low Countries, the centre of a great cloth industry, and could put some 20,000 armed citizens into the field. The wealth of the burghers during this period was equalled by their turbulent spirit of independence; feuds were frequent,—against the rival city of Bruges, against the counts, or, within the city itself, between the plebeian crafts and the patrician governing class. Of these risings the most notable was that, in the earlier half of the 14th century, against Louis de Crécy, count of Flanders, under the leadership of Jacob van Artevelde (*q.v.*).

¹ Bavo, or Allowin (*c.* 580-*c.* 653), patron saint of Ghent, was a nobleman converted by St Amandus, the apostle of Flanders. He lived first as an anchorite in the forest of Mendonk, and afterwards in the monastery founded with his assistance by Amandus at Ghent.

The earliest charter to the citizens of Ghent was that granted by Count Philip of Flanders between 1169 and 1191. It did little more than arrange for the administration of justice by nominated jurats (*scabini*) under the count's *bailli*. Far more comprehensive was the second charter, granted by Philip's widow Mathilda, after his death on crusade in 1191, as the price paid for the faithfulness of the city to her cause. The magistrates of the city were still nominated *scabini* (fixed at thirteen), but their duties and rights were strictly defined and the liberties of the citizens safe-guarded; the city, moreover, received the right to fortify itself and even individuals within it to fortify their houses. This charter was confirmed and extended by Count Baldwin VIII. when he took over the city from Mathilda, an important new provision being that general rules for the government of the city were only to be made by arrangement between the count or his officials and the common council of the citizens. The burghers thus attained to a very considerable measure of self-government. A charter of 1212 of Count Ferdinand (of Portugal) and his wife Johanna introduced a modified system of election for the *scabini*; a further charter (1228) fixed the executive at 39 members, including *scabini* and members of the commune, and ordained that the *bailli* of the count and his *serientes*, like the *podestàs* of Italian cities, were not to be natives of Ghent.

Thus far the constitution of the city had been wholly aristocratic; in the 13th century the patricians seem to have been united into a guild (*Commans-gilde*) from whose members the magistrates were chosen. By the 14th century, however, the democratic craft guilds, notably that of the weavers, had asserted themselves; the citizens were divided for civic and military purposes into three classes; the rich (*i.e.* those living on capital), the weavers and the members of the 52 other guilds. In the civic executive, as it existed to the time of Charles V., the deans of the two lower classes sat with the *scabini* and councillors.

The constitution and liberties of the city, which survived its incorporation in Burgundy, were lost for a time as a result of the unsuccessful rising against Duke Philip the Good (1450). The citizens, however, retained their turbulent spirit. After the death of Mary of Burgundy, who had resided in the city, they forced her husband, the archduke Maximilian, to conclude the treaty of Arras (1482). They were less fortunate in their opposition to Maximilian's son, the emperor Charles V. In 1539 they refused, on the plea of their privileges, to contribute to a general tax laid on Flanders, and when Charles's sister Mary, the governess of the Netherlands, seized some merchants as bail for the payment, they retaliated by driving out the nobles and the adherents of Charles's government. The appearance of Charles himself, however, with an overwhelming force quelled the disturbance; the ringleaders were executed, and all the property and privileges of the city were confiscated. In addition, a fine of 150,000 golden gulden was levied on the city, and used to build the "Spanish Citadel" on the site of what is now the public park.

In the long struggle of the Netherlands against Spain, Ghent took a conspicuous part, and it was here that, on the 8th of November 1576, was signed the instrument, known as the Pacification of Ghent, which established the league against Spanish tyranny. In 1584, however, the city had to surrender on onerous terms to the prince of Parma.

The horrors of war and of religious persecution, and the consequent emigration or expulsion of its inhabitants, had wrecked the prosperity of Ghent, the recovery of which was made impossible by the closing of the Scheldt. The city was captured by the French in 1698, 1708 and 1745. After 1714 it formed part of the Austrian Netherlands, and in 1794 became the capital of the French department of the Scheldt. In 1814 it was incorporated in the kingdom of the United Netherlands, and it was here that Louis XVIII. of France took refuge during the Hundred Days. Here too was signed (December 24, 1814) the treaty of peace between Great Britain and the United States of America. After 1815 Ghent was for a time the centre of Catholic opposition to Dutch rule, as it is now that of the Flemish movement in Belgium. During the 19th century its prosperity rapidly increased. In 1866-1867, however, a serious outbreak of cholera again threatened

it with ruin; but improved sanitation, the provision of a supply of pure water and the demolition of a mass of houses unfit for habitation soon effected a radical cure.

See L. A. Warnkönig, *Flandrische Staats- und Rechtsgeschichte bis 1305* (3 vols., Tübingen, 1835-1842), and Gueldorf, *Hist. de Gand*, translated from Warnkönig, with corrections and additions (Brussels, 1846); F. de Potter, *Gent van den oudsten tijd tot heden* (6 vols., Ghent, 1883-1891); Van Duyse, *Gand monumentale et pittoresque* (Brussels, 1886); de Vlaminck, *Les Origines de la ville de Gand* (Brussels, 1891); *Annales Gandenses*, ed. G. Funck-Brentano (Paris, 1895); *Vuytsteck: Orkondeboek der stad Gent* (Ghent, 1900, &c.); Karl Hegel, *Städte und Gilden* (Leipzig, 1891), vol. ii, p. 175, where further authorities are cited. For a comprehensive bibliography, including monographs and published documents, see Ulysse Chevalier, *Répertoire des sources hist. Topo-bibliogr.*, s.v. "Gand."

GHETTO, formerly the street or quarter of a city in which Jews were compelled to live, enclosed by walls and gates which were locked each night. The term is now used loosely of any locality in a city or country where Jews congregate. The derivation of the word is doubtful. In documents of the 11th century the Jew-quarters in Venice and Salerno are styled "Judaca" or "Judacaria." At Capua in 1375 there was a place called San Nicolo ad Judaicam, and later elsewhere a quarter San Martino ad Judaicam. Hence it has been suggested Judaicam became Italian Giudeica and thence became corrupted into ghetto. Another theory traces it to "gietto," the common foundry at Venice near which was the first Jews' quarters of that city. More probably the word is an abbreviation of Italian *borghetto* diminutive of *borgo* a "borough."

The earliest regular ghettos were established in Italy in the 11th century, though Prague is said to have had one in the previous century. The ghetto at Rome was instituted by Paul IV. in 1556. It lay between the Via del Pianto and Ponte del Quattro Capi, and comprised a few narrow and filthy streets. It lay so low that it was yearly flooded by the Tiber. The Jews had to sue annually for permission to live there, and paid a yearly tax for the privilege. This formality and tax survived till 1850. During three centuries there were constant changes in the oppressive regulations imposed upon the Jews by the popes. In 1814 Pius VII. allowed a few Jews to live outside the ghetto, and in 1847 Pius IX. decided to destroy the gates and walls, but public opinion hindered him from carrying out his plans. In 1870 the Jews petitioned Pius IX. to abolish the ghetto; but it was to Victor Emmanuel that this reform was finally due. The walls remained until 1885.

During the middle ages the Jews were forbidden to leave the ghetto after sunset when the gates were locked, and they were also imprisoned on Sundays and all Christian holy days. Where the ghetto was too small for the carrying on of their trades, a site beyond its wall was granted them as a market, *e.g.* the Jewish *Tandelmarkt* at Prague. Within their ghettos the Jews were left much to their own devices, and the more important ghettos, such as that at Prague, formed cities within cities, having their own town halls and civic officials, hospitals, schools and rabbinical courts. Fires were common in ghettos and, owing to the narrowness of the streets, generally very destructive, especially as from fear of plunder the Jews themselves closed their gates on such occasions and refused assistance. On the 14th of June 1711 a fire, the largest ever known in Germany, destroyed within twenty-four hours the ghetto at Frankfort-on-Main. Other notable ghetto fires are that of Bari in 1030 and Nikolsburg in 1719. The Jews were frequently expelled from their ghettos, the most notable expulsions being those of Vienna (1670) and Prague (1744-1745). This latter exile was during the war of the Austrian Succession, when Maria Theresa, on the ground that "they were fallen into disgrace," ordered Jews to leave Bohemia. The empress was, however, induced by the protests of the powers, especially of England and Holland, to revoke the decree. Meantime the Jews, ignorant of the revocation, petitioned to be allowed to return in payment of a yearly tax. This tax the Bohemian Jews paid until 1846. The most important ghettos were those at Venice, Frankfort, Prague and Trieste. By the middle of the 19th century the ghetto system

was moribund, and with the disappearance of the ghetto at Rome in 1870 it became obsolete.

See D. Philipson, *Old European Jewries* (Philadelphia, 1894); Israel Abrahams, *Jewish Life in the Middle Ages* (1896); S. Kahn, article "Ghetto" in *Jewish Encyclopedia*, v. 652.

GHIBERTI, LORENZO (1378-1455), Italian sculptor, was born at Florence in 1378. He learned the trade of a goldsmith under his father Ugoccione, commonly called Cione, and his stepfather Bartoluccio; but the goldsmith's art at that time included all varieties of plastic arts, and required from those who devoted themselves to its higher branches a general and profound knowledge of design and colouring. In the early stage of his artistic career Ghiberti was best known as a painter in fresco, and when Florence was visited by the plague he repaired to Rimini, where he executed a highly prized fresco in the palace of the sovereign Pandolfo Malatesta. He was recalled from Rimini to his native city by the urgent entreaties of his stepfather Bartoluccio, who informed him that a competition was to be opened for designs of a second bronze gate in the baptistery, and that he would do wisely to return to Florence and take part in this great artistic contest. The subject for the artists was the sacrifice of Isaac; and the competitors were required to observe in their work a certain conformity to the first bronze gate of the baptistery, executed by Andrea Pisano about 100 years previously. Of the six designs presented by different Italian artists, those of Donatello, Brunelleschi and Ghiberti were pronounced the best, and of the three Brunelleschi's and Ghiberti's superior to the third, and of such equal merit that the thirty-four judges with whom the decision was left entrusted the execution of the work to the joint labour of the two friends. Brunelleschi, however, withdrew from the contest. The first of his two bronze gates for the baptistery occupied Ghiberti twenty years.

Ghiberti brought to his task a deep religious feeling and the striving after a high poetical ideal which are not to be found in the works of Donatello, though in power of characterization the second sculptor often stands above the first. Like Donatello, he seized every opportunity of studying the remains of ancient art; but he sought and found purer models for imitation than Donatello, through his excavations and studies in Rome, had been able to secure. The council of Florence, which met during the most active period of Ghiberti's artistic career, not only secured him the patronage of the pontiff, who took part in the council, but enabled him, through the important connexions which he then formed with the Greek prelates and magnates assembled in Florence, to obtain from many quarters of the Byzantine empire the precious memorials of old Greek art, which he studied with untiring zeal. The unbounded admiration called forth by Ghiberti's first bronze gate led to his receiving from the chiefs of the Florentine guilds the order for the second, of which the subjects were likewise taken from the Old Testament. The Florentines gazed with especial pride on these magnificent creations, which must still have shone with all the brightness of their original gilding when, a century later, Michelangelo pronounced them worthy to be the gates of paradise. Next to the gates of the baptistery Ghiberti's chief works still in existence are his three statues of St John the Baptist, St Matthew and St Stephen, executed for the church of Or San Michele. In the bas-relief of the coffin of St Zenobius, in the Florence cathedral, Ghiberti put forth much of his peculiar talent, and though he did not, as is commonly stated, execute entirely the painted glass windows in that edifice, he furnished several of the designs, and did the same service for a painted glass window in the church of Or San Michele. He died at the age of 77.

We are better acquainted with Ghiberti's theories of art than with those of most of his contemporaries, for he left behind him a commentary, in which, besides his notices of art, he gives much insight into his own personal character and views. Every page attests the religious spirit in which he lived and worked. Not only does he aim at faithfully reflecting Christian truths in his creations, he regards the old Greek statues with a kindred feeling, as setting forth the highest intellectual and moral attributes of

human nature. He appears to have cared as little as Donatello for money.

Benvenuto Cellini's criticism on Ghiberti that in his creations of plastic art he was more successful in small than in large figures, and that he always exhibited in his works the peculiar excellences of the goldsmith's quite as much as those of the sculptor's art, is after all no valid censure, for it merely affirms that Ghiberti faithfully complied with the peculiar conditions of the task imposed upon him. More frequent have been the discussions as to the part played by perspective in his representations of natural scenery. These acquired a fresh importance since the discovery of the data, from which it appeared that Paolo Uccello, who had commonly been regarded as the first great master of perspective, worked for several years in the studio or workshop of Ghiberti, so that it became difficult to determine to what extent Uccello's successful innovations in perspective were due to Ghiberti's teaching.

Cicognara's criticism on Ghiberti, in his *History of Sculpture*, has supplied the chief materials for the illustrative text of Lasinio's series of engravings of the three bronze gates of the baptistery. They consist of 42 plates in folio, and were published at Florence by Bardi in 1821. Still more vivid representations are the reproductions on a very large scale by the photographic establishment of Alinari. Both C. C. Perkins, in his *History of Tuscan Sculpture* (1864), and A. F. Rio, in his *Art chrétien* (1861-1867), have treated Ghiberti's works with much fulness, and in a spirit of sound appreciation. See also the chapter expressly devoted to the history of the competition for the baptistery gates in Hans Semper, *Donatello* (1887); the articles by Adolf Rosenberg in *Dohme's Kunst und Künstler des Mittelalters* (Leipzig, 1877); Leader Scott, *Ghiberti and Donatello* (1882). In the *Sammlung ausgewählter Biographien Vasari*, ed. Carl Frey, vol. iii. (1886), is given Ghiberti's commentary on art.

GHICA, GHICA or GHYKA, a family which played a great part in the modern development of Rumania, many of its members being princes of Moldavia and Walachia. According to Rumanian historians the Ghicas were of very humble origin, and came from Kiupru in Albania.

1. George or Gheorghe (c. 1600-1664), the founder of the family, is said to have been a playmate of another Albanian known in history as Kùpruli Aga, the famous vizier, who recognized George while he was selling melons in the streets of Constantinople, and helped him on to high positions. George became prince of Moldavia in 1658 and prince of Walachia in 1659-1660. He moved the capital from Tirgovishtea to Bucharest. From him are derived the numerous branches of the family which became so conspicuous in the history of Moldavia and Walachia.

2. The Walachian branch starts afresh from the great ban Demetrius or Dumitru Ghica (1718-1803), who was twice married and had fourteen children (see *RUMANIA: History*). One of these, Gregory (Grigorie), prince of Walachia 1822-1828, starts a new era of civilization, by breaking with the traditions of the Phanariot (Greek) period and assisting in the development of a truly national Rumanian literature. His brother, Prince Alexander Ghica, appointed jointly by Turkey and Russia (1834-1842) as hospodar of Walachia, died in 1862. Under him the so-called *règlement organique* had been promulgated; an attempt was made to codify the laws in conformity with the institutions of the country and to secure better administration of justice. Prince Demetrius Ghica, who died as president of the Rumanian senate in 1897, was the son of the Walachian prince Gregory.

3. Another Gregory Ghica, prince of Moldavia from 1775 to 1777, paid with his life for the opposition he offered when the Turks ceded the province of Bukovina to Austria.

4. Michael (Michail) (1794-1850) was the father of Elena (1827-1888), a well-known novelist, who wrote under the name of Dora d'Istria. Brought up, as was customary at the time, under Greek influences, she showed premature intelligence and literary power. She continued her education in Germany and married a Russian prince, Koltsov Mazalskiy, in 1849, but the marriage was an unhappy one, and in 1855 she left St Petersburg for Florence, where she died in 1888. In that city she developed her literary talent and published a number of works characterized by lightness of touch and brilliance of description, such as

hill-country of Ghor," as a circle ring-fenced with mountains. His brief description speaks of it as a land fruitful in crops, cattle and flocks, inhabited by infidels, except a few who passed for Mahomedans, and indicates that, like other pagan countries surrounded by Moslem populations, it was regarded as a store of slaves for the faithful. The boundary of Ghor in ascending the valley of the Hari-rud was six and a half easy marches from Herat, at Chist, two marches above Obch.

The chief part of the present population of Ghor are Taimanis, belonging to the class of nomad or semi-nomad clans called Aimák, intermingled with Zuris and Tajiks.

The people and princes of Ghor first become known to us in connexion with the Ghaznevid dynasty, and the early medieval histories of Ghor and Ghazni are so intertwined that little need be added on that subject to what will be found under *GHAZNI* (q.v.). What we read of Ghor shows it as a country of lofty mountains and fruitful valleys, and of numerous strongholds held by a variety of hill-chieftains ruling warlike clans whose habits were rife with feuds and turbulence,—indeed, in character strongly resembling the tribes of modern Afghanistan, though there seems no good reason to believe that they were of Afghan race. It is probable that they were of old Persian blood, like the older of those tribes which still occupy the country. It is possibly a corroboration of this that, in the 14th century, when one of the Ghor kings, of the Kurt dynasty reigning in Herat, had taken to himself some of the insignia of independent sovereignty, an incensed Mongol prince is said to have reviled him as "an insolent *Tajik*." Sabuktigin of Ghazni, and his famous son Mahmud, repeatedly invaded the mountain country which so nearly adjoined their capital, subduing its chiefs for the moment, and exacting tribute; but when the immediate pressure was withdrawn, the yoke was thrown off and the tribute withheld. In 1020 Mas'ud, the son of Mahmud, being then governor of Khorasan, made a systematic invasion of Ghor from the side of Herat, laying siege to its strongholds one after the other, and subduing the country more effectually than ever before. About a century later one of the princely families of Ghor, deriving the appellation of Shansabi, or Shansabaniah, from a certain ancestor Shansab, of local fame, and of alleged descent from Zohak, acquired predominance in all the country, and at the time mentioned Malik 'Izzuddin al Hosain of this family came to be recognized as lord of Ghor. He was known afterwards as "the Father of Kings," from the further honour to which several of his seven sons rose. Three of these were—(1) Amir Kutubuddin Mahommed, called the lord of the Jibal or mountains; (2) Sultan Saifuddin Suri, for a brief period master of Ghazni,—both of whom were put to death by Bahram the Ghaznevid; and (3) Sultan Alauddin Jahansoz, who wreaked such terrible vengeance upon Ghazni. Alauddin began the conquests which were afterwards immensely extended both in India and in the west by his nephews Ghiyasuddin Mahommed b. Sam and Mahommed Ghori (Muizzuddin b. Sam or Shahabuddin b. Sam), and for a brief period during their rule it was boasted, with no great exaggeration, that the public prayer was read in the name of the Ghorian from the extremity of India to the borders of Babylonia, and from the Oxus to the Straits of Ormus. After the death of Mahommed Ghori, Mahmud the son of Ghiyasuddin was proclaimed sovereign (1200) throughout the territories of Ghor, Ghazni and Hindustan. But the Indian dominion, from his uncle's death, became entirely independent, and his actual authority was confined to Ghor, Seistan and Herat. The whole kingdom fell to pieces before the power of Mahommed Shah of Khwarizm and his son Jelaluddin (c. 1214–1215), a power in its turn to be speedily shattered by the Mongol flood.

Besides the thrones of Ghor and Ghazni, the Shansabaniah family, in the person of Fakhruddin, the eldest of the seven sons of Malik 'Izzuddin, founded a kingdom in the Oxus basin, having its seat at *BAMIAN* (q.v.), which endured for two or three generations, till extinguished by the power of Khwarizm (1214). And the great Mussulman empire of Delhi was based on the conquests of Muizzuddin the Ghorian, carried out and consolidated by his Turki freedmen, Kutubuddin Aibak and his successors. The

princes of Ghor experienced, about the middle of the 13th century, a revival of power, which endured for 140 years. This later dynasty bore the name of Kurt or Kárt. The first of historical prominence was Malik Shamsuddin Kurt, descended by his mother from the great king Ghiyasuddin Ghori, whilst his other grandfather was that prince's favourite minister. In 1245 Shamsuddin held the lordship of Ghor in some kind of alliance with, or subordination to, the Mongols, who had not yet definitively established themselves in Persia; and in 1248 he received from the Great Khan Mangu an investiture of all the provinces from Merv to the Indus, including by name Sijistan (or Seistan), Kabul, Tirah (adjoining the Khyber pass), and Afghanistan (a very early occurrence of this name), which he ruled from Herat. He stood well with Hulagu, and for a long time with his son Abaka, but at last incurred the latter's jealousy, and was poisoned when on a visit to the court at Tabriz (1276). His son Ruknuddin Kurt was, however, invested with the government of Khorasan (1278), but after some years, mistrusting his Tatar suzerains, he withdrew into Ghor, and abode in his strong fortress of Kaisar till his death there in 1305. The family held on through a succession of eight kings in all, sometimes submissive to the Mongol, sometimes aiming at independence, sometimes for a series of prosperous years adding to the strength and splendour of Herat, and sometimes sorely buffeted by the hosts of masterless Tatar brigands that tore Khorasan and Persia in the decline of the dynasties of Hulagu and Jagatal. It is possible that the Kurts might have established a lasting Tajik kingdom at Herat, but in the time of the last of the dynasty, Ghiyasuddin Pir-'Ali, Tatarism, reorganized and re-embodied in the person of Timur, came against Herat, and carried away the king and the treasures of his dynasty (1380). A revolt and massacre of his garrison provoked Timur's vengeance; he put the captive king to death, came against the city a second time, and showed it no mercy (1383). Ghor has since been obscure in history.

The capital of the kingdom of Ghor, when its princes were rising to dominion in the 12th century, was Firoz Koh, where a city and fortress were founded by Saifuddin Suri. The exact position of Firoz Koh is difficult to determine, unless it be represented by the ruins of one or other of the ancient cities in the upper Murghab valley, the habitat of the Firoz Kohi section of the Chahar Aimák, which were visited by the surveyors of the Russo-Afghan boundary delimitation of 1884–1885. Extensive ruins were also found at Taiwara on one of the main affluents of the Farah Rud, where walls and terraces still existing supported the local tradition that this place was the ancient capital of Ghor. The valleys of the Taimani tribes though narrow are fertile and well cultivated, and there are many walled villages and forts about Parjuman and Zarni in the south-eastern districts. The peak of "Chalag Dalan" (described by Ferrier as "one of the highest in the world") is the Koh-i-Kaisar, which is a trifle over 13,000 ft. in height. All the country now known as Ghor was mapped during the progress of the Russo-Afghan boundary delimitation.

See the "Tabakát-i-Násiri," in the *Bibl. Indica*, transl. by Raverty; *Journal asiatique*, sér. v. tom. xvii.; "Ibn Haukal," in *J. As. Soc. Beng.* vol. xxii.; Ferrier's *Caravan Journeys*; Hammer's *Ilkhans*, &c.

GHOST (a word common to the W. Teutonic languages; O.E. *geast*, Dutch, *geest*, Ger. *Geist*), in the sense now prevailing, the spirit of a dead person considered as appearing in some visible or sensible form to the living (see APPARITIONS; PSYCHICAL RESEARCH, "Phantasms of the Dead"; SPIRITUALISM). In the earlier and wider sense of spirit in general, or of the principle of life, the word is practically obsolete. The language of the Authorized Version of the Bible, however, has preserved the phrase "to give up the ghost," still sometimes used of dying. The Spirit of God, too, the third person of the Trinity, is still called, not in the technical language of theology only, the Holy Ghost. The adjective "ghostly" is still occasionally used for "spiritual" (cf. the Ger. *geistlich*) as contrasted with "bodily," especially in such combinations as "ghostly counsel," "ghostly comfort." We may even speak of a "ghostly adviser," though not without a touch of affectation; on the other hand, the phrase

"ghostly man" for a clergyman (cf. the Ger. *Geistlicher*) is an archaism the use of which could only be justified by poetic licence, as in Tennyson's *Elaine* (1094). The word "ghost," from the shadowy and unsubstantial quality attributed to the apparitions of the dead, has come also to be commonly used to emphasize the want of force or substance generally, in such phrases as "not the ghost of a chance," "not the ghost of an idea." It is also applied to those literary and artistic "hacks" who are paid to do work for which others get the credit.

GHOST DANCE, an American-Indian ritual dance, sometimes called the Spirit Dance, the dancers wearing a white cloak. It is connected with the doctrine of a Messiah, which arose in Nevada among the Paiute Indians in 1888 and spread to other tribes. A young Paiute Indian medicine-man, known as Wovoka, and called Jack Wilson by the whites, proclaimed that he had had a revelation, and that, if this ghost dance and other ceremonies were duly performed, the Indians would be rid of the white men. The movement led to a sort of craze among the Indian tribes, and in 1890 it was one of the causes of the Sioux outbreak.

See J. Mooney, *14th Report* (1896) of *Bureau of American Ethnology*.

GIACOMETTI, PAOLO (1816-1882), Italian dramatist, born at Novi Ligure, was educated in law at Genoa, but at the age of twenty had some success with his play *Rossida* and then devoted himself to the stage. Depressed circumstances made him attach himself as author to various touring Italian companies, and his output was considerable; moreover, such actors as Ristori, Rossi and Salvini made many of these plays great successes. Among the best of them were *La Donna* (1850), *La Donna in seconde nase* (1851), *Giuditta* (1857), *Sofocle* (1860), *La Morte civile* (1880). A collection of his works was published at Milan in eight volumes (1859 et seq.).

GIAMBELLI (or **GIANIBELLI**), **FEDERIGO**, Italian military engineer, was born at Mantua about the middle of the 16th century. Having had some experience as a military engineer in Italy, he went to Spain to offer his services to Philip II. His proposals were, however, lukewarmly received, and as he could obtain from the king no immediate employment, he took up his residence at Antwerp, where he soon gained considerable reputation for his knowledge in various departments of science. He is said to have vowed to be revenged for his rebuff at the Spanish court; and when Antwerp was besieged by the duke of Parma in 1584, he put himself in communication with Queen Elizabeth, who, having satisfied herself of his abilities, engaged him to aid by his counsels in its defence. His plans for provisioning the town were rejected by the senate, but they agreed to a modification of his scheme for destroying the famous bridge which closed the entrance to the town from the side of the sea, by the conversion of two ships of 60 and 70 tons into infernal machines. One of these exploded, and, besides destroying more than 1000 soldiers, effected a breach in the structure of more than 200 ft. in width, by which, but for the hesitation of Admiral Jacobzoon, the town might at once have been relieved. After the surrender of Antwerp Giambelli went to England, where he was engaged for some time in fortifying the river Thames; and when the Spanish Armada was attacked by fire-ships in the Calais roads, the panic which ensued was very largely due to the conviction among the Spaniards that the fire-ships were infernal machines constructed by Giambelli. He is said to have died in London, but the year of his death is unknown.

See Motley's *History of the United Netherlands*, vols. i. and ii.

GIANNONE, PIETRO (1676-1748), was born at Ischitella, in the province of Capitanata, on the 7th of May 1676. Arriving in Naples at the age of eighteen, he devoted himself to the study of law, but his legal pursuits were much surpassed in importance by his literary labours. He devoted twenty years to the composition of his great work, the *Storia civile del regno di Napoli*, which was ultimately published in 1723. Here in his account of the rise and progress of the Neapolitan laws and government, he warmly espoused the side of the civil power in its conflicts with the Roman Catholic hierarchy. His merit lies in the fact that he was the first to deal systematically with the question of Church and State, and the position thus taken up by him, and the manner

in which that position was assumed, gave rise to a lifelong conflict between Giannone and the Church; and in spite of his retraction in prison at Turin, he deserves the palm—as he certainly endured the sufferings—of a confessor and martyr in the cause of what he deemed historical truth. Hooted by the mob of Naples, and excommunicated by the archbishop's court, he was forced to leave Naples and repair to Vienna. Meanwhile the Inquisition had attested after its own fashion the value of his history by putting it on the *Index*. At Vienna the favour of the emperor Charles VI. and of many leading personages at the Austrian court obtained for him a pension and other facilities for the prosecution of his historical studies. Of these the most important result was *Il Trivigno, ossia del regno dal cielo, della terra, e del papa*. On the transfer of the Neapolitan crown to Charles of Bourbon, Giannone lost his Austrian pension and was compelled to remove to Venice. There he was at first most favourably received. The post of consulting lawyer to the republic, in which he might have continued the special work of Fra Paolo Sarpi, was offered to him, as well as that of professor of public law in Padua; but he declined both offers. Unhappily there arose a suspicion that his views on maritime law were not favourable to the pretensions of Venice, and this suspicion, notwithstanding all his efforts to dissipate it, together with clerical intrigues, led to his expulsion from the state. On the 23rd of September 1735 he was seized and conveyed to Ferrara. After wandering under an assumed name for three months through Modena, Milan and Turin, he at last reached Geneva, where he enjoyed the friendship of the most distinguished citizens, and was on excellent terms with the great publishing firms. But in an evil hour he was induced to visit a Catholic village within Sardinian territory in order to hear mass on Easter day, where he was kidnapped by the agents of the Sardinian government, conveyed to the castle of Miolans and thence successively transferred to Ceva and Turin. In the fortress of Turin he remained immured during the last twelve years of his life, although part of his time was spent in composing a defence of the Sardinian interests as opposed to those of the papal court, and he was led to sign a retraction of the statements in his history most obnoxious to the Vatican (1738). But after his recantation his detention was made less severe and he was allowed many alleviations. He died on the 7th of March 1748, in his seventy-second year.

Giannone's style as an Italian writer has been pronounced to be below a severe classical model; he is often inaccurate as to the facts, for he did not always work from original authorities (see A. Manzoni, *Storia della colonia infame*), and he was sometimes guilty of unblushing plagiarism. But his very ease and freedom have helped to make his volumes more popular than many works of greater classical renown. In England the just appreciation of his labours by Gibbon, and the ample use made of them in the later volumes of *The Decline and Fall*, early secured him his rightful place in the estimation of English scholars.

The story of his life has been recorded in the *Vita* by L. Panzini, which is based on Giannone's unpublished *Autobiografia* and printed in the Milan edition of the historian's works (1823); whilst a more complete estimate of his literary and political importance may be formed by the perusal of the collected edition of the works written by him in his Turin prison, published in Turin in 1859—under the care of the distinguished statesman Pasquale Stanislao Mancini, universally recognized as one of the first authorities in Italy on questions relating to the history of his native Naples, and especially of the conflicts between the civil power and the Church. See also R. Mariano, "Giannone e Vico," in the *Revista contemporanea* (1869); G. Ferrari, *La Mente di Pietro Giannone* (1868). G. Bonacci's *Saggio sulla Storia civile del Giannone* (Florence, 1903) is a bitter attack on Giannone, and although the writer's remarks on the plagiarisms in the *Storia civile* are justified, the charge of servility is greatly exaggerated.

GIANNUTRI (Gr. *Ἀπρηλαῖον*, Lat. *Dianium*), an island of Italy, about 1 sq. m. in total area, 10 m. S.E. of Giglio and about 10 m. S. of the promontory of Monte Argentario (see ORBETELLO). The highest point is 305 ft. above sea-level. It contains the ruins of a large Roman villa, near the Cala Maestra on the E. coast of the island. The buildings may be divided into five groups: (1) a large cistern in five compartments, each measuring 39 by 17 ft.; (2) habitations both for the owners and for slaves, and

store-rooms; (3) baths; (4) habitations for slaves; (5) belvedere. The brick-stamps found begin in the Flavian and end with the Hadrianic period. The villa may have belonged to the Domitii Ahenobarbi, who certainly under the republic had property in the island of Igilium (Giglio) and near Cosa.

See G. Pellegrini in *Notizie degli scavi* (1900), 609 seq.

GIANT (O.E. *geant*, through Fr. *giant*, O.Fr. *giant*, *jaiant*, *giant*, med. pop. Lat. *gaganie*—cf. Ital. *gigante*—by assimilation from *gigantem*, acc. of Lat. *gigas*, Gr. *γίγας*). The idea conveyed by the word in classic mythology is that of beings more or less manlike, but monstrous in size and strength. Figures like the Titans and the Giants whose birth from Heaven and Earth is sung by Hesiod in the *Theogony*, such as can heap up mountains to scale the sky and war beside or against the gods, must be treated, with other like monstrous figures of the wonder-tales of the world, as belonging altogether to the realms of mythology. But there also appear in the legends of giants some with historic significance. The ancient and commonly repeated explanation of the Greek word *γίγας*, as connected with or derived from *γῆρας*, or "earth-born," is etymologically doubtful, but at any rate the idea conveyed by it was familiar to the ancient Greeks, that the giants were earth-born or indigenous races (see Welcker, *Griechische Götterlehre*, i. 787). The Bible (the English reader must be cautioned that the word giant has been there used ambiguously, from the Septuagint downwards) touches the present matter in so far as it records the traditions of the Israelites of fighting in Palestine with tall races of the land such as the Anakim (Numb. xiii. 33; Deut. ii. 10, iii. 11; 1 Sam. xvii. 4). When reading in Homer of "the Cyclopes and the wild tribes of the Giants," or of the adventures of Odysseus in the cave of Polyphemus (Homer, *Odys.* vii. 206; ix.), we seem to come into view of dim traditions, exaggerated through the mist of ages, of pre-Hellenic barbarians, goddess, cannibal, skin-clothed, hurling huge stones in their rude warfare. Giant-legends of this class are common in Europe and Asia, where the big and stupid giants would seem to have been barbaric tribes exaggerated into monsters in the legends of those who dispossessed and slew them. In early times it was usual for cities to have their legends of giants. Thus London had Gog and Magog, whose effigies (14 ft. high) still stand in the Guildhall (see Gog); Antwerp had her Antigonus, 40 ft. high; Douai had Gayant, 22 ft. high, and so on.

Besides the conception of giants, as special races distinct from mankind, it was a common opinion of the ancients that the human race had itself degenerated, the men of primeval ages having been of so far greater stature and strength as to be in fact gigantic. This, for example, is received by Pliny (*Hist. Nat.* vii. 16), and it becomes a common doctrine of theologians such as Augustine (*De civitate Dei*, xv. 9), lasting on into times so modern that it may be found in Cruden's *Concordance*. Yet so far as can be judged from actual remains, it does not appear that giants, in the sense of tribes of altogether superhuman stature, ever existed, or that the men of ancient time were on the whole taller than those now living. It is now usual to apply the word giant not to superhuman beings but merely to unusually tall men and women. In every race of mankind the great mass of individuals do not depart far from a certain mean or average height, while the very tall or very short men become less and less numerous as they depart from the mean standard, till the utmost divergence is reached in a very few giants on the one hand, and a very few dwarfs on the other. At both ends of the scale, the body is usually markedly out of the ordinary proportions; thus a giant's head is smaller and a dwarf's head larger than it would be if an average man had been magnified or diminished. The principle of the distribution of individuals of different sizes in a race or nation has been ably set forth by Quetelet (*Physique sociale*, vol. ii.; *Anthropométrie*, books iii. and iv.). Had this principle been understood formerly, we might have been spared the pains of criticizing assertions as to giants 20 ft. high, or even more, appearing among mankind. The appearance of an individual man 20 ft. high involves the existence of the race he is an extreme member of, whose mean

stature would be at least 12 to 14 ft., which is a height no human being has been proved on sufficient evidence to have approached (*Anthropom.* p. 302). Modern statisticians cannot accept the loose conclusion in Buffon (*Hist. nat.*, ed. Sonnini, iv. 134) that there is no doubt of giants having been 10, 12, and perhaps 15 ft. high. Confidence is not even to be placed in ancient asserted measurements, as where Pliny gives to one Gabbaras, an Arabian, the stature of 9 ft. 9 in. (about 9 ft. 5½ in. English), capping this with the mention of Posio and Secundilla, who were half a foot higher. That two persons should be described as both having this same extraordinary measure suggests to the modern critic the notion of a note jotted down on the philosopher's tablets, and never tested afterwards.

Under these circumstances it is worth while to ask how it is that legend and history so abound in mentions of giants outside all probable dimensions of the human frame. One cause is that, when the story-teller is asked the actual stature of the huge men who figure in his tales, he is not sparing of his inches and feet. What exaggeration can do in this way may be judged from the fact that the Patagonians, whose average height (5 ft. 11 in.) is really about that of the Chirside men in Berwickshire, are described in Pigafetta's *Voyage round the World* as so monstrous that the Spaniards' heads hardly reached their waists. It is reasonable to suppose, with Professor Nilsson (*Primitive Inhabitants of Scandinavia*, chap. vi.), that in the traditions of early Europe tribes of savages may have thus, if really tall, expanded into giants, or, if short, dwindled into dwarfs. Another cause which is clearly proved to have given rise to giant-myths of yet more monstrous type has been the discovery of great fossil bones, as of mammoth or mastodon, which were formerly supposed to be bones of giants (see Tylor, *Early History of Mankind*, chap. xi.; *Primitive Culture*, chap. x.). A tooth weighing 4½ lb and a thigh-bone 17 ft. long having been found in New England in 1712 (they were probably mastodon), Dr Increase Mather thereupon communicated to the Royal Society of London his theory of the existence of men of prodigious stature in the antediluvian world (see the *Philosophical Transactions*, xxiv. 85; D. Wilson, *Prehistoric Man*, i. 54). The giants in the streets of Basel and supporting the arms of Lucerne appear to have originated from certain fossil bones found in 1577, examined by the physician Felix Plater, and pronounced to have belonged to a giant some 16 or 19 ft. high. These bones have since been referred to a very different geological genus, but Plater's giant skeleton was accepted early in the 19th century as a genuine relic of the giants who once inhabited the earth. Of giants in real life whose stature has been authentically recorded Quetelet gives the palm to Frederick the Great's Scotch giant, who measured about 8 ft. 3 in. But since his time there have been several giants who have equalled or surpassed this figure. Patrick Cotler, an Irishman, who died at Clifton, Bristol, in 1802, was 8 ft. 7 in. high. The famous "Irish giant" O'Brien (Charles Byrne), whose skeleton is preserved in the museum of the Royal College of Surgeons, London, was 8 ft. 4 in. Chang (Chang-woo-goo), who appeared in London in 1865-1866 and again in 1880, was 8 ft. 2 in. Josef Winkelmanier, an Austrian, exhibited in London on the 10th of January 1887, was 8 ft. 9 in.; while Elizabeth Lyska, a Russian child of twelve, when shown in London in 1889, had already reached 6 ft. 8 in. Machnow, a Russian, born at Charkow, was exhibited in London in his twenty-third year in 1905; he then stood 9 ft. 3 in., and weighed 360 lb (25 st. 10 lb). From his wrist to the top of his second finger he measured 2 ft. (see *The Times*, 10th February 1905).

The whole subject of giant myths and the now entirely exploded theory that mankind has, as far as stature is concerned, degenerated since prehistoric times, has been ably dealt with in a volume published by MM. P. E. Launois and P. Roy, entitled *Études biologiques sur les géants* (Paris, 1904). See also E. J. Wood, *Giants and Dwarfs* (1860).

GIANT'S CAUSEWAY, a promontory of columnar basalt, situated on the north coast of county Antrim, Ireland. It is divided by whin-dykes into the Little Causeway, the Middle Causeway or "Honeycomb," as it is locally termed, and the Larger or Grand Causeway. The pillars composing it are

close-fitting and for the most part somewhat irregular hexagons, made up of articulated portions varying from a few inches to some feet in depth, and concave or convex at the upper and lower surfaces. In diameter the pillars vary from 15 to 20 in., and in height some are as much as 20 ft. The Great Causeway is chiefly from 20 to 30, and for a few yards in some places nearly 40 ft. in breadth, exclusive of outlying broken pieces of rock. It is highest at its narrowest part. At about half a dozen yards from the cliff, widening and becoming lower, it extends outwards into a platform, which has a slight seaward inclination, but is easy to walk upon, and for nearly 100 yds. is always above water. At the distance of about 150 yds. from the cliff it turns a little to the eastward for 20 or 30 yds., and then sinks into the sea. The neighbouring cliffs exhibit in many places columns similar to those of the Giant's Causeway, a considerable exposure of them being visible at a distance of 500 to 600 yds. in the bay to the east. A group of these columns, from their arrangement, have been fancifully named the "Giant's Organ." The most remarkable of the cliffs is the Pleaskin, the upper pillars of which have the appearance of a colonnade, and are 60 ft. in height; beneath these is a mass of coarse black amygdaloid, of the same thickness, underlain by a second range of basaltic pillars, from 40 to 50 ft. in height. The view eastward over Bengore and towards Fair Head is magnificent. Near the Giant's Causeway are the ruins of the castles of Dunseverick and Dunluce, situated high above the sea on isolated crags, and the swinging bridge of Carrick-a-Rede, spanning a chasm 80 ft. deep, and connecting a rock, which is used as a salmon-fishing station, with the mainland. In 1883 an electric railway, the first in the United Kingdom, was opened for traffic, connecting the Causeway with Portrush and Bushmills. After a protracted lawsuit (1897-1898) the Causeway, and certain land in the vicinity, were declared to be private property, and a charge is made for admission.

GIANT'S KETTLE, **GIANT'S CAULDRON** or **POT-HOLE**, in physical geography, the name applied to cavities or holes which appear to have been drilled in the surrounding rocks by eddy currents of water bearing stones, gravel and other detrital matter. The size varies from a few inches to several feet in depth and diameter. The commonest occurrence is in regions where glaciers exist or have existed; a famous locality is the Gletscher Garten of Lucerne, where there are 32 giant's kettles, the largest being 26 ft. wide and 30 ft. deep; they are also common in Germany, Norway and in the United States. It appears that water, produced by the thawing of the ice and snow, forms streams on the surface of the glacier, which, having gathered into their courses a certain amount of morainic debris, are finally cast down a crevasse as a swirling cascade or *moulin*. The sides of the crevasse are abraded, and a vertical shaft is formed in the ice. The erosion may be continued into the bed of the glacier, and the ice having left the district, the giant's kettle so formed is seen as an empty shaft, or as a pipe filled with gravel, sand or boulders. Such cavities and pipes afford valuable evidence as to the former extent of glaciers (see J. Geikie, *The Great Ice Age*). Similar holes are met with in river beds at the foot of cascades, and under some other circumstances. The term "pot-hole" is also sometimes used synonymously with "swallow-hole" (q.v.).

GIAOUR (a Turkish adaptation of the Pers. *gāw* or *gōr*, an infidel), a word used by the Turks to describe all who are not Mahomedans, with especial reference to Christians. The word, first employed as a term of contempt and reproach, has become so general that in most cases no insult is intended in its use; similarly, in parts of China, the term "foreign devil" has become void of offence. A strict analogy to *giaour* is found in the Arabic *kaafir*, or unbeliever, which is so commonly in use as to have become the proper name of peoples and countries.

GIB, ADAM (1714-1788), Scottish divine and leader of the Antiburgher section of the Scottish Secession Church, was born on the 14th of April 1714 in the parish of Muckhart, Perthshire, and, on the completion of his literary and theological studies at Edinburgh and Perth, was licensed as a preacher in 1740.

His eldest brother being a prodigal he succeeded to the paternal estate, but threw the will into the fire on his brother's promising to reform. In 1741 he was ordained minister of the large Secession congregation of Bristo Street, Edinburgh. In 1745 he was almost the only minister of Edinburgh who continued to preach against rebellion while the troops of Charles Edward were in occupation of the town. When in 1747 "the Associate Synod," by a narrow majority, decided not to give full immediate effect to a judgment which had been passed in the previous year against the lawfulness of the "Burgess Oath," Gib led the protesting minority, who separated from their brethren and formed the Antiburgher Synod (April 10th) in his own house in Edinburgh. It was chiefly under his influence that it was agreed by this ecclesiastical body at subsequent meetings to summon to the bar their "Burgess" brethren, and finally to depose and excommunicate them for contumacy. Gib's action in forming the Antiburgher Synod led, after prolonged litigation, to his exclusion from the building in Bristo Street where his congregation had met. In 1765 he made a vigorous and able reply to the General Assembly of the Church of Scotland, which had stigmatized the Secession as "threatening the peace of the country." From 1753 till within a short period of his death, which took place on the 18th of June 1788, he preached regularly in Nicolson Street church, which was constantly filled with an audience of two thousand persons. His dogmatic and fearless attitude in controversy earned for him the nickname "Pope Gib."

Principal publications: *Tables for the Four Evangelists* (1770, and with author's name, 1800); *The Present Truth, a Display of the Secession Testimony* (2 vols., 1774); *Vindiciæ dominicæ* (Edin., 1780). See Chambers's *Eminent Scotsmen*; also article UNITED PRESBYTERIAN CHURCH.

GIBARA, or **JIBARA** (once "Punta del Yarey" and "Yarey de Gibara"), a north-coast city of Oriente Province, Cuba, 80 m. N.W. of Santiago de Cuba. Pop. (1907) 6170. It is served by railway to the S.S.W., to Holguín and Cacocum (where it connects with the main line between Santiago and Havana), and is a port of call for the American Munson Line. It lies on a circular harbour, about 1 m. in diameter, which, though open to the N., affords fair shelter. At the entrance to the harbour is San Fernando, an old fort (1817), and the city is very quaint in appearance. At the back of the city are three stone-topped hills, Silla, Pan and Tabla, reputed to be those referred to by Columbus in his journal of his first voyage. Enclosing the town is a stone wall, built by the Spaniards as a defence against attack during the rebellion of 1868-1878. Gibara is the port of Holguín. It exports cedar, mahogany, tobacco, sugar, tortoise-shell, Indian corn, cattle products, coco-nuts and bananas; and is the centre of the banana trade with the United States. Gibara is an old settlement, but it did not rise above the status of a petty village until after 1817; its importance dates from the opening of the port to commerce in 1827.

GIBBON, EDWARD (1737-1794), English historian, was descended, he tells us in his autobiography, from a Kentish family of considerable antiquity; among his remoter ancestors he reckons the lord high treasurer Fiennes, Lord Say and Sele, whom Shakespeare has immortalized in his *Henry VI*. His grandfather was a man of ability, an enterprising merchant of London, one of the commissioners of customs' under the Tory ministry during the last four years of Queen Anne, and, in the judgment of Lord Bolingbroke, as deeply versed in the "commerce and finances of England" as any man of his time. He was not always wise, however, either for himself or his country; for he became deeply involved in the South Sea Scheme, in the disastrous collapse of which (1720) he lost the ample wealth he had amassed. As a director of the company, moreover, he was suspected of fraudulent complicity, taken into custody and heavily fined; but £10,000 was allowed him out of the wreck of his estate, and with this his skill and enterprise soon constructed a second fortune. He died at Putney in 1736, leaving the bulk of his property to his two daughters—nearly disinheriting his only son, the father of the historian, for having married against his wishes. This son (by name Edward) was educated

at Westminster¹ and Cambridge, but never took a degree, travelled, became member of parliament, first for Petersfield (1734), then for Southampton (1741), joined the party against Sir Robert Walpole, and (as his son confesses, not much to his father's honour) was animated in so doing by "private revenge" against the supposed "oppressor" of his family in the South Sea affair. If so, revenge, as usual, was blind; for Walpole had sought rather to moderate than to inflame public feeling against the projectors.

The historian was born at Putney, Surrey, April 27 (Old Style), 1737. His mother, Judith Porten, was the daughter of a London merchant. He was the eldest of a family of six sons and a daughter, and the only one who survived childhood; his own life in youth hung by so mere a thread as to be again and again despaired of. His mother, between domestic cares and constant infirmities (which, however, did not prevent an occasional plunge into fashionable dissipation in compliance with her husband's wishes), did but little for him. The "true mother of his mind as well as of his health" was a maiden aunt—Catherine Porten by name—with respect to whom he expresses himself in language of the most grateful remembrance. "Many anxious and solitary days," says Gibbon, "did she consume with patient trial of every mode of relief and amusement. Many wakeful nights did she sit by my bedside in trembling expectation that each hour would be my last." As circumstances allowed, she appears to have taught him reading, writing and arithmetic—acquisitions made with so little of remembered pain that "were not the error corrected by analogy," he says, "I should be tempted to conceive them as innate." At seven he was committed for eighteen months to the care of a private tutor, John Kirkby by name, and the author, among other things, of a "philosophical fiction" entitled the *Life of Automathes*. Of Kirkby, from whom he learned the rudiments of English and Latin grammar, he speaks gratefully, and doubtless truly, so far as he could trust the impressions of childhood. With reference to *Automathes* he is much more reserved in his praise, denying alike its originality, its depth and its elegance; but, he adds, "the book is not devoid of entertainment or instruction."

In his ninth year (1746), during a "lucid interval of comparative health," he was sent to a school at Kingston-upon-Thames; but his former infirmities soon returned, and his progress, by his own confession, was slow and unsatisfactory. "My timid reserve was astonished by the crowd and tumult of the school; the want of strength and activity disqualified me for the sports of the play-field. . . . By the common methods of discipline, at the expense of many tears and some blood, I purchased the knowledge of the Latin syntax," but manifestly, in his own opinion, the *Arabian Nights*, Pope's *Homer*, and Dryden's *Virgil*, eagerly read, had at this period exercised a much more powerful influence on his intellectual development than Phaedrus and Cornelius Nepos, "painfully construed and darkly understood."

In December 1747 his mother died, and he was taken home. After a short time his father removed to the "rustic solitude" of Buriton (Hants), but young Gibbon lived chiefly at the house of his maternal grandfather at Putney, where, under the care of his devoted aunt, he developed, he tells us, that passionate love of reading "which he would not exchange for all the treasures of India," and where his mind received its most decided stimulus. Of 1748 he says, "This year, the twelfth of my age, I shall note as the most propitious to the growth of my intellectual stature." After detailing the circumstances which unlocked for him the door of his grandfather's "tolerable library," he says, "I turned over many English pages of poetry and romance, of history and travels. Where a title attracted my eye, without fear or awe I snatched the volume from the shelf." In 1749, in his twelfth year, he was sent to Westminster, still residing, however, with his aunt, who, rendered destitute by her father's bankruptcy, but unwilling to live a life of dependence, had opened a boarding-

¹ The celebrated William Law had been for some time the private tutor of this Edward Gibbon, who is supposed to have been the original of the rather clever sketch of "Flatius" in the *Serious Call*.

house for Westminster school. Here in the course of two years (1749-1750), interrupted by danger and debility, he "painfully climbed into the third form"; but it was left to his ripening to "acquire the beauties of the Latin and the rudiments of the Greek tongue." The continual attacks of sickness which had retarded his progress induced his aunt, by medical advice, to take him to Bath; but the mineral waters had no effect. He then resided for a time in the house of a physician at Winchester; the physician did as little as the mineral waters; and, after a further trial of Bath, he once more returned to Putney, and made a last futile attempt to study at Westminster. Finally, it was concluded that he would never be able to encounter the discipline of a school; and casual instructors, at various times and places, were provided for him. Meanwhile his indiscriminate appetite for reading had begun to fix itself more and more decidedly upon history; and the list of historical works devoured by him during this period of chronic ill-health is simply astonishing. It included, besides Hearne's *Ductor historicus* and the successive volumes of the *Universal History*, which was then in course of publication, Littlebury's *Herodotus*, Spelman's *Xenophon*, Gordon's *Tacitus*, an anonymous translation of Procopius; "many crude lumps of Speed, Rapin, Mezeray, Davila, Machiavel, Father Paul, Bower, &c., were hastily gulped. I devoured them like so many novels; and I swallowed with the same voracious appetite the descriptions of India and China, of Mexico and Peru." His first introduction to the historic scenes the study of which afterwards formed the passion of his life took place in 1751, when, while along with his father visiting a friend in Wiltshire, he discovered in the library "a common book, the continuation of Echard's *Roman History*." "To me the reigns of the successors of Constantine were absolutely new; and I was immersed in the passage of the Goths over the Danube, when the summons of the dinner bell reluctantly dragged me from my intellectual feast." Soon afterwards his fancy kindled with the first glimpses into Oriental history, the wild "barbaric" charm of which he never ceased to feel. Ockley's book on the Saracens "first opened his eyes" to the striking career of Mahomet and his hordes; and with his characteristic ardour of literary research, after exhausting all that could be learned in English of the Arabs and Persians, the Tatars and Turks, he forthwith plunged into the French of D'Herbelot, and the Latin of Pocock's version of Abulfaragus, sometimes understanding them, but oftener only guessing their meaning. He soon learned to call to his aid the subsidiary sciences of geography and chronology, and before he was quite capable of reading them had already attempted to weigh in his childish balance the competing systems of Scaliger and Petavius, of Marsham and Newton. At this early period he seems already to have adopted in some degree the plan of study he followed in after life and recommended in his *Essai sur l'Étude*—that is, of letting his subject rather than his author determine his course, of suspending the perusal of a book to reflect, and to compare the statements with those of other authors—so that he often read portions of many volumes while mastering one.

Towards his sixteenth year he tells us "nature displayed in his favour her mysterious energies," and all his infirmities suddenly vanished. Thenceforward, while never possessing or abusing the insolence of health, he could say "few persons have been more exempt from real or imaginary ills." His unexpected recovery revived his father's hopes for his education, hitherto so much neglected if judged by ordinary standards; and accordingly in January 1752 he was placed at Esher, Surrey, under the care of Dr Francis, the well-known translator of Horace. But Gibbon's friends in a few weeks discovered that the new tutor preferred the pleasures of London to the instruction of his pupils, and in this perplexity decided to send him prematurely to Oxford, where he was matriculated as a gentleman commoner of Magdalen College, 3rd April 1752. According to his own testimony he arrived at the university "with a stock of information which might have puzzled a doctor, and a degree of ignorance of which a schoolboy might be ashamed." And indeed his huge wallet of scraps stood him in little stead at the trim banquets to which

he was invited at Oxford, while the wandering habits by which he had filled it absolutely unfitted him to be a guest. He was not well grounded in any of the elementary branches, which are essential to university studies and to all success in their prosecution. It was natural, therefore, that he should dislike the university, and as natural that the university should dislike him. Many of his complaints of the system were certainly just; but it may be doubted whether any university system would have been profitable to him, considering his antecedents. He complains especially of his tutors, and in one case with abundant reason; but, by his own confession, they might have recriminated with justice, for he indulged in gay society, and kept late hours. His observations, however, on the defects of the English university system, some of which have only very recently been removed, are acute and well worth pondering, however little relevant to his own case. He remained at Magdalen about fourteen months. "To the university of Oxford," he says, "I acknowledge no obligation; and she will as cheerfully renounce me for a son as I am willing to disclaim her for a mother. I spent fourteen months at Magdalen College; they proved the fourteen months the most idle and unprofitable of my whole life."

But thus "idle" though he may have been as a "student," he already meditated authorship. In the first long vacation—during which he, doubtless with some sarcasm, says that "his taste for books began to revive"—he contemplated a treatise on the age of Sesostris, in which (and it was characteristic) his chief object was to investigate not so much the events as the probable epoch of the reign of that semi-mythical monarch, whom he was inclined to regard as having been contemporary with Solomon. "Unprovided with original learning, unformed in the habits of thinking, unskilled in the arts of composition, I resolved to write a book"; but the discovery of his own weakness, he adds, was the first symptom of taste. On his first return to Oxford the work was "wisely relinquished," and never afterwards resumed. The most memorable incident, however, in Gibbon's stay at Oxford was his temporary conversion to the doctrines of the church of Rome. The bold criticism of Middleton's recently (1749) published *Free Enquiry into the Miraculous Powers which are supposed to have subsisted in the Christian Church* appears to have given the first shock to his Protestantism, not indeed by destroying his previous belief that the gift of miraculous powers had continued to subsist in the church during the first four or five centuries of Christianity, but by convincing him that within the same period most of the leading doctrines of popery had been already introduced both in theory and in practice. At this stage he was introduced by a friend (Mr Molesworth) to Bossuet's *Variations of Protestantism and Exposition of Catholic Doctrine* (see Gibbon, *Decline and Fall*, c. xv., note 79). "These works," says he, "achieved my conversion, and I surely fell by a noble hand." In bringing about this "fall," however, Parsons the Jesuit appears to have had a considerable share; at least Lord Sheffield has recorded that on the only occasion on which Gibbon talked with him on the subject he imputed the change in his religious views principally to that vigorous writer, who, in his opinion, had urged all the best arguments in favour of Roman Catholicism. But be this as it may, he had no sooner adopted his new creed than he resolved to profess it; "a momentary glow of enthusiasm" had raised him above all temporal considerations, and accordingly, on June 8, 1753, he records that having "privately abjured the heresies" of his childhood before a Catholic priest of the name of Baker, a Jesuit, in London, he announced the same to his father in an elaborate controversial epistle which his spiritual adviser much approved, and which he himself afterwards described to Lord Sheffield as having been "written with all the pomp, the dignity, and self-satisfaction of a martyr."

The elder Gibbon heard with indignant surprise of this act of juvenile apostasy, and, indiscreetly giving vent to his wrath, precipitated the expulsion of his son from Oxford, a punishment which the culprit, in after years at least, found no cause to deplore. In his *Memoirs* he speaks of the results of his "childish revolt against the religion of his country" with undisguised self-

gratulation. It had delivered him for ever from the "port and prejudice" of the university, and led him into the bright paths of philosophic freedom. That his conversion was sincere at the time, that it marked a real if but a transitory phase of genuine religious conviction, we have no reason to doubt, notwithstanding the scepticism he has himself expressed. "To my present feelings it seems incredible that I should ever believe that I believed in transubstantiation," he indeed declares; but his incredulous astonishment is not unminged with undoubting pride. "I could not blush that my tender mind was entangled in the sophistry which had reduced the acute and manly understandings of a Chillingworth or a Bayle." Nor is the sincerity of the Catholicism he professed in these boyish days in any way discredited by the fact of his subsequent lack of religion. Indeed, as one of the acutest and most sympathetic of his critics has remarked, the deep and settled grudge he has betrayed towards every form of Christian belief, in all the writings of his maturity, may be taken as evidence that he had at one time experienced in his own person at least some of the painful workings of a positive faith.

But little time was lost by the elder Gibbon in the formation of a new plan of education for his son, and in devising some method which if possible might effect the cure of his "spiritual malady." The result of deliberation, aided by the advice and experience of Lord Eliot, was that it was almost immediately decided to fix Gibbon for some years abroad under the roof of M. Pavilliard, a Calvinist minister at Lausanne. In as far as regards the instructor and guide thus selected, a more fortunate choice could scarcely have been made. From the testimony of his pupil, and the still more conclusive evidence of his own correspondence with the father, Pavilliard seems to have been a man of singular good sense, temper and tact. At the outset, indeed, there was one considerable obstacle to the free intercourse of tutor and pupil: M. Pavilliard appears to have known little of English, and young Gibbon knew practically nothing of French. But this difficulty was soon removed by the pupil's diligence; the very exigencies of his situation were of service to him in calling forth all his powers, and he studied the language with such success that at the close of his five years' exile he declares that he "spontaneously thought" in French rather than in English, and that it had become more familiar to "ear, tongue and pen." It is well known that in after years he had doubts whether he should not compose his great work in French; and it is certain that his familiarity with that language, in spite of considerable efforts to counteract its effects, tinged his style to the last.

Under the judicious regulations of his new tutor a methodical course of reading was marked out, and most ardently prosecuted; the pupil's progress was proportionably rapid. With the systematic study of the Latin, and to a slight extent also of the Greek classics, he conjoined that of logic in the prolix system of Crousaix; and he further invigorated his reasoning powers, as well as enlarged his knowledge of metaphysics and jurisprudence, by the perusal of Locke, Grotius and Montesquieu. He also read largely, though somewhat indiscriminately, in French literature, and appears to have been particularly struck with Pascal's *Provincial Letters*, which he tells us he reperused almost every year of his subsequent life with new pleasure, and which he particularly mentions as having been, along with Bletierie's *Life of Julian* and Giannone's *History of Naples*, a book which probably contributed in a special sense to form the historian of the Roman empire. The comprehensive scheme of study included mathematics also, in which he advanced as far as the conic sections in the treatise of L'Hôpital. He assures us that his tutor did not complain of any inaptitude on the pupil's part, and that the pupil was as happily unconscious of any on his own; but here he broke off. He adds, what is not quite clear from one who so frankly acknowledges his limited acquaintance with the science, that he had reason to congratulate himself that he knew no more. "As soon," he says, "as I understood the principles, I relinquished for ever the pursuit of the mathematics; nor can I lament that I desisted before my mind was hardened by the habit of rigid demonstration, so destructive

of the finer feelings of moral evidence, which must, however, determine the action and opinions of our lives."

Under the new influences which were brought to bear on him, he in less than two years resumed his Protestantism. "He is willing," he says, to allow M. Paviliard a "handsome share in his reversion," though he maintains, and no doubt rightly, that it was principally due "to his own solitary reflections." He particularly congratulated himself on having discovered the "philosophical argument" against transubstantiation, "that the text of Scripture which seems to inculcate the real presence is attested only by a single sense—our sight, while the real presence itself is disproved by three of our senses—the sight, the touch, and the taste." Before a similar mode of reasoning, all the other distinctive articles of the Romish creed "disappeared like a dream"; and "after a full conviction," on Christmas day, 1754, he received the sacrament in the church of Lausanne. Although, however, he adds that at this point he suspended his religious inquiries, "acquiescing with implicit belief in the tenets and mysteries which are adopted by the general consent of Catholics and Protestants," his readers will probably do him no great injustice if they assume that even then it was rather to the negations than to the affirmations of Protestantism that he most heartily assented.

With all his devotion to study at Lausanne¹ (he read ten or twelve hours a day), he still found some time for the acquisition of some of the lighter accomplishments, such as riding, dancing, drawing, and also for mingling in such society as the place had to offer. In September 1755 he writes to his aunt: "I find a great many agreeable people here, see them sometimes, and can say upon the whole, without vanity, that, though I am the Englishman here who spends the least money, I am he who is most generally liked." Thus his "studious and sedentary life" passed pleasantly enough, interrupted only at rare intervals by boyish excursions of a day or a week in the neighbourhood, and by at least one memorable tour of Switzerland, by Basel, Zürich, Lucerne and Bern, made along with Paviliard in the autumn of 1755. The last eighteen months of this residence abroad saw the infusion of two new elements—one of them at least of considerable importance—into his life. In 1757 Voltaire came to reside at Lausanne; and although he took but little notice of the young Englishman of twenty, who eagerly sought and easily obtained an introduction, the establishment of the theatre at Monrepos, where the brilliant versifier himself declaimed before select audiences his own productions on the stage, had no small influence in fortifying Gibbon's taste for the French theatre, and in at the same time abating that "idolatry for the gigantic genius of Shakespeare which is inculcated from our infancy as the first duty of an Englishman." In the same year—apparently about June—he saw for the first time, and forthwith loved, the beautiful, intelligent and accomplished Mademoiselle Susan Curchod, daughter of the pasteur of Crassier. That the passion which she inspired in him was tender, pure and fitted to raise to a higher level a nature which in some

¹ The *Journal* for 1755 records that during that year, besides writing and translating a great deal in Latin and French, he had read, amongst other works, Cicero's *Epistolæ ad familiares*, his *Brutus*, all his *Orations*, his dialogues *De amicitia* and *De senectute*, Terence (twice), and Pliny's *Epistles*. In January 1756 he says: "I determined to read over the Latin authors in order, and read this year Virgil, Sallust, Livy, Velleius Paterculus, Valerius Maximus, Tacitus, Suetonius, Quintus Curtius, Justin, Florus, Plautus, Terence and Lucretius. I also read and meditated Locke *Upon the Understanding*." Again in January 1757 he writes: "I began to study algebra under M. de Traytorrens, went through the elements of algebra and geometry, and the three first books of the Marquis de l'Hôpital's *Conic Sections*. I also read Tibullus, Catullus, Propertius, Horace with Dacier's and Torrentius's notes), Virgil, Ovid's *Epistles*, with Meziriac's commentary, the *Æs amandæ* and the *Elegies*; likewise the *Augustus* and *Tiberius* of Suetonius, and a Latin translation of Dion Cassius from the death of Julius Caesar to the death of Augustus. I also continued my correspondence, begun last year, with M. Allamand of Bex, and the Professor Breitingner of Zürich, and opened a new one with the Professor Gesner of Göttingen. *N.B.*—Last year and this I read St John's Gospel, with part of Xenophon's *Cyropædia*, the *Iliad*, and Herodotus; but, upon the whole, I rather neglected my Greek."

respects was much in need of such elevation will be doubted by none but the hopelessly cynical; and probably there are few readers who can peruse the paragraph in which Gibbon "approaches the delicate subject of his early love" without discerning in it a pathos much deeper than that of which the writer was himself aware. During the remainder of his residence at Lausanne he had good reason to "indulge his dream of felicity"; but on his return to England, "I soon discovered that my father would not hear of this strange alliance, and that without his consent I was myself destitute and helpless. After a painful struggle I yielded to my fate; I sighed as a lover, I obeyed as a son; my wound was insensibly healed by time, absence, and the habits of a new life."²

In 1758 he returned with mingled joy and regret to England, and was kindly received at home. But he found a stepmother there; and this apparition on his father's hearth at first rather appalled him. The cordial and gentle manners of Mrs Gibbon, however, and her unremitting care for his happiness, won him from his first prejudices, and gave her a permanent place in his esteem and affection. He seems to have been much indulged, and to have led a very pleasant life of it; he pleased himself in moderate excursions, frequented the theatre, mingled, though not very often, in society; was sometimes a little extravagant, and sometimes a little dissipated, but never lost the benefits of his Lausanne exile; and easily settled into a sober, discreet, calculating Epicurean philosopher, who sought the *summum bonum* of man in temperate, regulated and elevated pleasure. The first two years after his return to England he spent principally at his father's country seat at Bunton, in Hampshire, only nine months being given to the metropolis. He has left an amusing account of his employments in the country, where his love of study was at once inflamed by a large and unwooned command of books and checked by the necessary interruptions of his otherwise happy domestic life. After breakfast "he was expected," he says, to spend an hour with Mrs Gibbon; after tea his father claimed his conversation; in the midst of an interesting work he was often called down to entertain idle visitors; and, worst of all, he was periodically compelled to return the well-meant compliments. He mentions that he dreaded the "recurrence of the full moon," which was the period generally selected for the more convenient accomplishment of such formidable excursions.

His father's library, though large in comparison with that he commanded at Lausanne, contained, he says, "much trash"; but a gradual process of reconstruction transformed it at length into that "numerous and select" library which was "the foundation of his works, and the best comfort of his life both at home and abroad." No sooner had he returned home than he began the work of accumulation, and records that, on the receipt of his first quarter's allowance, a large share was appropriated to his literary wants. "He could never forget," he declares, "the joy with which he exchanged a bank note of twenty pounds for the twenty volumes of the *Memoirs* of the Academy of Inscriptions," an Academy which has been well characterized (by Sainte-Beuve) as Gibbon's intellectual fatherland. It may not be uninteresting here to note the principles which guided him both now and afterwards in his literary purchases. "I am not conscious," says he, "of having ever bought a book from a motive of ostentation; every volume, before it was deposited on the shelf, was either read or sufficiently examined"; he also mentions that he soon adopted the tolerating maxim of the elder Pliny, that no book is ever so bad as to be absolutely good for nothing.

In London he seems to have seen but little select society—partly from his father's taste, "which had always preferred the highest and lowest company," and partly from his own reserve and timidity, increased by his foreign education, which had made English habits unfamiliar, and the very language

² The affair, however, was not finally broken off till 1763. Miss Curchod soon afterwards became the wife of Necker, the famous financier; and Gibbon and the Neckers frequently afterwards met on terms of mutual friendship and esteem.

in some degree strange. And thus he was led to draw that interesting picture of the literary recluse among the crowds of London: "While coaches were rattling through Bond Street, I have passed many a solitary evening in my lodging with my books. My studies were sometimes interrupted with a sigh, which I breathed towards Lausanne; and on the approach of spring I withdrew without reluctance from the noisy and extensive scene of crowds without company, and dissipation without pleasure." He renewed former acquaintance, however, with the "poet" Mallet, and through him gained access to Lady Hervey's circle, where a congenial admiration, not to say affectation, of French manners and literature made him a welcome guest. It ought to be added that in each of the twenty-five years of his subsequent acquaintance with London "the prospect gradually brightened," and his social as well as his intellectual qualities secured him a wide circle of friends. In one respect Mallet gave him good counsel in those early days. He advised him to addict himself to an assiduous study of the more idiomatic English writers, such as Swift and Addison—with a view to unlearn his foreign idiom and recover his half-forgotten vernacular—a task, however, which he never perfectly accomplished. Much as he admired these writers, Hume and Robertson were still greater favourites, as well from their subject as for their style. Of his admiration of Hume's style, of its nameless grace of simple elegance, he has left us a strong expression, when he tells us that it often compelled him to close the historian's volumes with a mixed sensation of delight and despair.

In 1761 Gibbon, at the age of twenty-four, after many delays, and with many flutterings of hope and fear, gave to the world, in French, his maiden publication, an *Essai sur l'étude de la littérature*, which he had composed two years before. It was published partly in compliance with his father's wishes, who thought that the proof of some literary talent might introduce him favourably to public notice, and secure the recommendation of his friends for some appointment in connexion with the mission of the English plenipotentiaries to the congress at Augsburg which was at that time in contemplation. But in yielding to paternal authority, Gibbon frankly owns that he "complied, like a pious son, with the wish of his own heart."

The subject of this youthful effort was suggested, its author says, by a refinement of vanity—"the desire of justifying and praising the object of a favourite pursuit," namely, the study of ancient literature. Partly owing to its being written in French, partly to its character, the *Essai* excited more attention abroad than at home. Gibbon has criticized it with the utmost frankness, not to say severity; but, after every abatement, it is unquestionably a surprising effort for a mind so young, and contains many thoughts which would not have disgraced a thinker or a scholar of much maturer age. His account of its first reception and subsequent fortunes in England deserves to be cited as a curious piece of literary history. "In England," he says, "it was received with cold indifference, little read, and speedily forgotten. A small impression was slowly dispersed; the bookseller murmured, and the author (had his feelings been more exquisite) might have wept over the blunders and baldness of the English translation. The publication of my history fifteen years afterwards revived the memory of my first performance, and the essay was eagerly sought in the shops. But I refused the permission which Becket solicited of reprinting it; the public curiosity was imperfectly satisfied by a pirated copy of the booksellers of Dublin; and when a copy of the original edition has been discovered in a sale, the primitive value of half-a-crown has risen to the fanciful price of a guinea or thirty shillings."¹

¹ The *Essai*, in a good English translation, now appears in the *Miscellaneous Works*. Villemain finds in it "peu de vues, nulle originalité surtout, mais une grande passion littéraire, l'amour des recherches savantes et du beau langage." Sainte-Beuve's criticism is almost identical with Gibbon's own; but though he finds that "la lecture en est assez difficile et parfois obscure, la liaison des idées échappe souvent par trop de concision et par le désir qu'a eu le jeune auteur d'y faire entrer, d'y condenser la plupart de ses notes," he adds, "il y a, chemin faisant, des vues neuves et qui sentent l'historien."

Some time before the publication of the essay, Gibbon had entered a new and, one might suppose, a very uncongenial scene of life. In an hour of patriotic ardour he became (June 12, 1759) a captain in the Hampshire militia, and for more than two years (May 10, 1760, to December 23, 1762) led a wandering life of "military servitude." Hampshire, Kent, Wiltshire and Dorsetshire formed the successive theatres of what he calls his "bloodless and inglorious campaigns." He complains of the busy idleness in which his time was spent; but, considering the circumstances, so adverse to study, one is rather surprised that the military student should have done so much, than that he did so little; and never probably before were so many hours of literary study spent in a tent. In estimating the comparative advantages and disadvantages of this wearisome period of his life, he has summed up with the impartiality of a philosopher and the sagacity of a man of the world. Irksome as were his employments, grievous as was the waste of time, uncongenial as were his companions, solid benefits were to be set off against these things; his health became robust, his knowledge of the world was enlarged, he wore off some of his foreign idiom, got rid of much of his reserve; he adds—and perhaps in his estimate it was the benefit to be most prized of all—"the discipline and evolutions of a modern battalion gave me a clearer notion of the phalanx and the legion, and the captain of the Hampshire grenadiers (the reader may smile) has not been useless to the historian of the Roman empire."

It was during this period that he read Homer and Longinus, having for the first time acquired some real mastery of Greek; and after the publication of the *Essai*, his mind was full of projects for a new literary effort. The Italian expedition of Charles VIII. of France, the crusade of Richard I., the wars of the barons, the lives and comparisons of Henry V. and the emperor Titus, the history of the Black Prince, the life of Sir Philip Sidney, that of Montrose, and finally that of Sir W. Raleigh, were all of them seriously contemplated and successively rejected. By their number they show how strong was the impulse to literature, and by their character, how determined the bent of his mind in the direction of history; while their variety makes it manifest also that he had then at least no special purpose to serve, no preconceived theory to support, no particular prejudice or belief to overthrow.

The militia was disbanded in 1762, and Gibbon joyfully shook off his bonds; but his literary projects were still to be postponed. Following his own wishes, though with his father's consent, he had early in 1760 projected a Continental tour as the completion "of an English gentleman's education." This had been interrupted by the episode of the militia; now, however, he resumed his purpose, and left England in January 1763. Two years were "loosely defined as the term of his absence," which he exceeded by half a year—returning June 1765. He first visited Paris, where he saw a good deal of d'Alembert, Diderot, Barthélemy, Raynal, Helvétius, Baron d'Holbach and others of that circle, and was often a welcome guest in the saloons of Madame Geoffrin and Madame du Deffand.² Voltaire was at Geneva, Rousseau at Montmorency, and Buffon he neglected to visit; but so congenial did he find the society for which his education had so well prepared him, and into which some literary reputation had already preceded him, that he declared, "Had I been rich and independent, I should have prolonged and perhaps have fixed my residence at Paris."

From France he proceeded to Switzerland, and spent nearly a year at Lausanne, where many old friendships and studies were resumed, and new ones begun. His reading was largely designed to enable him fully to profit by the long-contemplated Italian tour which began in April 1764 and lasted somewhat more than a year. He has recorded one or two interesting notes on Turin, Genoa, Florence and other towns at which halt was made on his route; but Rome was the great object of his pilgrimage, and the words in which he has alluded to the feelings with which he

² Her letters to Walpole about Gibbon contain some interesting remarks by this "aveugle clairvoyante," as Voltaire calls her; but they belong to a later period (1777).

approached it are such as cannot be omitted from any sketch of Gibbon, however brief. "My temper is not very susceptible of enthusiasm, and the enthusiasm which I do not feel I have ever scorned to affect. But at the distance of twenty-five years I can neither forget nor express the strong emotions which agitated my mind as I first approached and entered the Eternal City. After a sleepless night, I trod with a lofty step the ruins of the forum; each memorable spot, where Romulus stood, or Tully spoke, or Caesar fell, was at once present to my eye; and several days of intoxication were lost or enjoyed before I could descend to a cool and minute investigation." Here at last his long yearning for some great theme worthy of his historic genius was gratified. The first conception of the *Decline and Fall* arose as he lingered one evening amidst the vestiges of ancient glory. "It was at Rome, on the 15th of October 1764, as I sat musing amidst the ruins of the Capitol, while the bare-footed friars were singing vespers in the temple of Jupiter, that the idea of writing the decline and fall of the city first started to my mind."

The five years and a half which intervened between his return from this tour, in June 1765, and the death of his father, in November 1770, seem to have formed the portion of his life which "he passed with the least enjoyment and remembered with the least satisfaction." He attended every spring the meetings of the militia at Southampton, and rose successively to the rank of major and lieutenant-colonel commandant; but was each year "more disgusted with the inn, the wine, the company, and the tiresome repetition of annual attendance and daily exercise." From his own account, however, it appears that other and deeper causes produced this discontent. Sincerely attached to his home, he yet felt the anomaly of his position. At thirty, still a dependant, without a settled occupation, without a definite social status, he often regretted that he had not "embraced the lucrative pursuits of the law or of trade, the chances of civil office or India adventure, or even the fat slumbers of the church." From the emoluments of a profession he "might have derived an ample fortune, or a competent income instead of being stinted to the same narrow allowance, to be increased only by an event which he sincerely deprecated." Doubtless the secret fire of a consuming, but as yet ungratified, literary ambition also troubled his repose. He was still contemplating "at an awful distance" *The Decline and Fall*, and meantime revolved some other subjects, that seemed more immediately practicable. Hesitating for some time between the revolutions of Florence and those of Switzerland, he consulted M. Deyverdun, a young Swiss with whom he had formed a close and intimate friendship during his first residence at Lausanne, and finally decided in favour of the land which was his "friend's by birth" and "his own by adoption." He executed the first book in French; it was read (in 1767), as an anonymous production, before a literary society of foreigners in London, and condemned. Gibbon sat and listened unobserved to their strictures. It never got beyond that rehearsal; Hume, indeed, approved of the performance, only deprecating as unwise the author's preference for French; but Gibbon sided with the majority.

In 1767 also he joined with M. Deyverdun in starting a literary journal under the title of *Mémoires littéraires de la Grande-Bretagne*. But its circulation was limited, and only the second volume had appeared (1768) when Deyverdun went abroad. The materials already collected for a third volume were suppressed. It is interesting, however, to know, that in the first volume is a review by Gibbon of Lord Lyttelton's *History of Henry II.*, and that the second volume contains a contribution by Hume on Walpole's *Historic Doubts*.

The next appearance of the historian made a deeper impression. It was the first distinct print of the lion's foot. "Ex ungue leonem" might have been justly said, for he attacked, and attacked successfully, the redoubtable Warburton. Of the many paradoxes in the *Divine Legation*, few are more extravagant than the theory that Virgil, in the sixth book of his *Aeneid*, intended to allegorize, in the visit of his hero and the Sibyl to the

shades, the initiation of Aeneas, as a lawgiver, into the Eleusinia mysteries. This theory Gibbon completely exploded in his *Critical Observations* (1770)—no very difficult task, indeed, but achieved in a style, and with a profusion of learning, which called forth the warmest commendations both at home and abroad. Warburton never replied; and few will believe that he would not, if he had not thought silence more discreet. Gibbon, however, regrets that the style of his pamphlet was too acrimonious; and this regret, considering his antagonist's slight claims to forbearance, is creditable to him. "I cannot forgive myself the contemptuous treatment of a man who, with all his faults, was entitled to my esteem; and I can less forgive, in a personal attack, the cowardly concealment of my name and character."

Soon after his "release from the fruitless task of the Swiss revolution" in 1768, he had gradually advanced from the wish to the hope, from the hope to the design, from the design to the execution of his great historical work. His preparations were indeed vast. The classics, "as low as Tacitus, Pliny the Younger and Juvenal," had been long familiar. He now "plunged into the ocean of the Augustan history," and "with pen almost always in hand," pored over all the original records, Greek and Latin, between Trajan and the last of the Western Caesars. "The subsidiary rays of medals and inscriptions, of geography and chronology, were thrown on their proper objects; and I applied the collections of Tillemont, whose inimitable accuracy almost assumes the character of genius, to fix and arrange within my reach the loose and scattered atoms of historical information." The Christian apologists and their pagan assailants; the Theodosian Code, with Godefroy's commentary; the *Annals and Antiquities* of Muratori, collated with "the parallel or transverse lines" of Sigonius and Maffei, Pagi and Baronius, were all critically studied. Still following the wise maxim which he had adopted as a student, "multum legere potius quam multa," he reviewed again and again the immortal works of the French and English, the Latin and Italian classics. He deepened and extended his acquaintance with Greek, particularly with his favourite authors Homer and Xenophon; and, to crown all, he succeeded in achieving the third perusal of Blackstone's *Commentaries*.

The course of his study was for some time seriously interrupted by his father's illness and death in 1770, and by the many distractions connected with the transference of his residence from Buriton to London. It was not, indeed, until October 1772 that he found himself at last independent, and fairly settled in his house and library, with full leisure and opportunity to set about the composition of the first volume of his history. Even then it appears from his own confession that he long brooded over the chaos of materials he had amassed before light dawned upon it. At the commencement, he says, "all was dark and doubtful"; the limits, divisions, even the title of his work were undetermined; the first chapter was composed three times, and the second and third twice, before he was satisfied with his efforts. This prolonged meditation on his design and its execution was ultimately well repaid by the result: so methodical did his ideas become, and so readily did his materials shape themselves, that, with the above exceptions, the original MS. of the entire six quartos was sent uncopied to the printers. He also says that not a sheet had been seen by any other eyes than those of author and printer, a statement indeed which must be taken with a small deduction; or rather we must suppose that a few chapters had been submitted, if not to the "eyes," to the "ears" of others; for he elsewhere tells us that he was "soon disgusted with the modest practice of reading the manuscript to his friends." Such, however, were his preliminary difficulties that he confesses he was often "tempted to cast away the labour of seven years"; and it was not until February 1776 that the first volume was published. The success was instant, and, for a quarto, probably unprecedented. The entire impression was exhausted in a few days; a second and a third edition were scarcely adequate to the demand. The author might almost have said, as Lord Byron after the publication of *Childe Harold*,

that "he awoke one morning and found himself famous." In addition to public applause, he was gratified by the more select praises of the highest living authorities in that branch of literature: "the candour of Dr Robertson embraced his disciple"; Hume's letter of congratulation "overpaid the labour of ten years." The latter, however, with his usual sagacity, anticipated the objections which he saw could be urged against the famous fifteenth and sixteenth chapters. "I think you have observed a very prudent temperament; but it was impossible to treat the subject so as not to give grounds of suspicion against you, and you may expect that a clamour will arise."

The "clamour" thus predicted was not slow to make itself heard. Within two years the famous chapters had elicited what might almost be called a library of controversy. The only attack, however, to which Gibbon deigned to make any reply was that of Davies, who had impugned his accuracy or good faith. His *Vindication* appeared in February 1779; and, as Milman remarks, "this single discharge from the ponderous artillery of learning and sarcasm laid prostrate the whole disorderly squadron" of his rash and feeble assailants.¹

Two years before the publication of this first volume Gibbon was elected member of parliament for Liskeard (1774). His political duties did not suspend his prosecution of his history, except on one occasion, and for a little while, in 1779, when he undertook, on behalf of the ministry, a task which, if well performed, was also, it must be added, well rewarded. The French government had issued a manifesto preparatory to a declaration of war, and Gibbon was solicited by Chancellor Thurlow and Lord Weymouth, secretary of state, to answer it. In compliance with this request he produced the able *Mémoire justificatif*, composed in French, and delivered to the courts of Europe; and shortly afterwards he received a seat at the Board of Trade and Plantations—little more than a sinecure in itself, but with a very substantial salary of nearly £800 per annum. His acceptance displeased some of his former political associates, and he was accused of "deserting his party." In his *Memoir*, indeed, Gibbon denies that he had ever enlisted with the Whigs. A note of Fox, however, on the margin of a copy of *The Decline and Fall* records a very distinct remembrance of the historian's previous vituperation of the ministry; within a fortnight of the date of his acceptance of office, he is there alleged to have said that "there was no salvation for this country until six heads of the principal persons in administration were laid upon the table." Lord Sheffield merely replies, somewhat weakly it must be said, that his friend never intended the words to be taken literally. More to the point is the often-quoted passage from Gibbon's letter to Deyverdun, where the frank revelation is made: "You have not forgotten that I went into parliament without patriotism and without ambition, and that

all my views tended to the convenient and respectable place of a lord of trade."

In April 1781 the second and third quartos of his *History* were published. They excited no controversy, and were comparatively little talked about—so little, indeed, as to have extorted from him a half murmur about "coldness and prejudice." The volumes, however, were bought and read with silent avidity. Meanwhile public events were developing in a manner that had a considerable influence upon the manner in which the remaining years of the historian's life were spent. At the general election in 1780 he had lost his seat for Liskeard, but had subsequently been elected for Lymington. The ministry of Lord North, however, was tottering, and soon after fell; the Board of Trade was abolished by the passing of Burke's bill in 1782, and Gibbon's salary vanished with it—no trifle, for his expenditure had been for three years on a scale somewhat disproportionate to his private fortune. He did not like to depend on statesmen's promises, which are proverbially uncertain of fulfilment; he as little liked to retrench; and he was wearied of parliament, where he had never given any but silent votes. Urged by such considerations, he once more turned his eyes to the scene of his early exile, where he might live on his decent patrimony in a style which was impossible in England, and pursue unembarrassed his literary studies. He therefore resolved to fix himself at Lausanne.

A word only is necessary on his parliamentary career. Neither nature nor acquired habits qualified him to be an orator; his late entrance on public life, his natural timidity, his feeble voice, his limited command of idiomatic English, and even, as he candidly confesses, his literary fame, were all obstacles to success. "After a fleeting, illusive hope, prudence condemned me to acquiesce in the humble station of a mute. . . . I was not armed by nature and education with the intrepid energy of mind and voice—'Vincentem strepitus et natum rebus agendis.' Timidity was fortified by pride, and even the success of my pen discouraged the trial of my voice." His repugnance to public life had been strongly expressed to his father in a letter of a very early date, in which he begged that the money which a seat in the House of Commons would cost might be expended in a mode more agreeable to him. Gibbon was eight-and-thirty when he entered parliament; and the obstacles which even at an earlier period he had not had courage to encounter were hardly likely to be vanquished then. Nor had he much political sagacity. He was better skilled in investigating the past than in divining the future. While Burke and Fox and so many great statesmen proclaimed the consequences of the collision with America, Gibbon saw nothing but colonies in rebellion, and a paternal government justly incensed. His silent votes were all given on that hypothesis. In a similar manner, while he abhorred the French Revolution when it came, he seems to have had no apprehension, like Chesterfield, Burke, or even Horace Walpole, of its approach; nor does he appear to have at all suspected that it had had anything to do with the speculations of the philosophic coteries in which he had taken such delight. But while it may be doubted whether his presence in parliament was of any direct utility to the legislative business of the country, there can be no question of the present advantage which he derived from it in the prosecution of the great work of his life—an advantage of which he was fully conscious when he wrote: "The eight sessions that I sat in parliament were a school of civil prudence, the first and most essential virtue of an historian."

Having sold all his property except his library—to him equally a necessary and a luxury—Gibbon repaired to Lausanne in September 1783, and took up his abode with his early friend Deyverdun, now a resident there. Perfectly free from every engagement but those which his own tastes imposed, easy in his circumstances, commanding just as much society, and that as select, as he pleased, with the noblest scenery spread out at his feet, no situation can be imagined more favourable for the

¹ In 1775 he writes to Holroyd: "I am still a mute; it is more tremendous than I imagined; the great speakers fill me with despair; the had ones with terror."

¹ For a very full list of publications in answer to Gibbon's attack on Christianity reference may be made to the *Bibliographer's Manual*, pp. 885-886 (1858). Of these the earliest were Watson's *Apology* (1776), Salisbury's *Strictures* (1776) and Chelsum's (anonymous) *Remarks* (1776). In 1778 the *Few Remarks* by a Gentleman (Francis Eyre), the *Reply* of Lotius, the *Letters* of Apthorpe and the *Examination* of Davies appeared. Gibbon's *Vindication* (1779) called for a *Reply* by Davies (1779), and *A Short Appeal to the Public* by Francis Eyre (1779). Laughton's polemical treatise was published in 1780, and those of Milner and Taylor in 1781. Chelsum returned to the attack in 1785 (*A Reply to Mr Gibbon's Vindication*), and Sir David Dalrymple (*An Inquiry into the Secondary Causes, &c.*) made his first appearance in the controversy in 1786. Travis's *Letters on 1 John* v. 7 are dated 1784; and Spedalieri's *Confutazione dell'esame del Cristianesimo fatto da Gibbon* was published at Rome (2 vols. 4to) in the same year. It is impossible not to concur in almost every point with Gibbon's own estimate of his numerous assailants. Their crude productions, for the most part, were conspicuous rather for insolence and abusiveness than for logic or learning. Those of Bishop Watson and Lord Hailes were the best, but simply because they contented themselves with a dispassionate exposition of the general argument in favour of Christianity. The most foolish and discreditable was certainly that of Davies; his unworthy attempt to depreciate the great historian's learning, and his captious, cavilling, acrimonious charges of petty inaccuracies and discreditable falsification gave the object of his attack an easy triumph.

prosecution of his literary enterprise; a hermit in his study as long as he chose, he found the most delightful recreation always ready for him at the threshold. "In London," says he, "I was lost in the crowd; I ranked with the first families in Lausanne, and my style of prudent expense enabled me to maintain a fair balance of reciprocal civilities. . . . Instead of a small house between a street and a stable-yard, I began to occupy a spacious and convenient mansion, connected on the north side with the city, and open on the south to a beautiful and boundless horizon. A garden of four acres had been laid out by the taste of M. Deyverdun: from the garden a rich scenery of meadows and vineyards descends to the Leman Lake, and the prospect far beyond the lake is crowned by the stupendous mountains of Savoy." In this enviable retreat, it is no wonder that a year should have been suffered to roll round before he vigorously resumed his great work—and with many men it would never have been resumed in such a paradise. We may remark in passing that the retreat was often enlivened, or invaded, by friendly tourists from England, whose "frequent incursions" into Switzerland our recluse seems half to lament as an evil. Among his more valued visitors were M. and Mme Necker; Mr Fox also gave him two welcome "days of free and private society" in 1788. Differing as they did in politics, Gibbon's testimony to the genius and character of the great statesman is highly honourable to both: "Perhaps no human being," he says, "was ever more perfectly exempt from the taint of malevolence, vanity, or falsehood."

When once fairly reseated at his task, he proceeded in this delightful retreat leisurely, yet rapidly, to its completion. The fourth volume, partly written in 1782, was completed in June 1784; the preparation of the fifth volume occupied less than two years; while the sixth and last, begun 18th May 1786, was finished in thirteen months. The feelings with which he brought his labours to a close must be described in his own inimitable words: "It was on the day, or rather night, of the 27th of June 1787, between the hours of eleven and twelve, that I wrote the last lines of the last page in a summer house in my garden. After laying down my pen, I took several turns in a *berceau* or covered walk of acacias, which commands a prospect of the country, the lake, and the mountains. The air was temperate, the sky was serene, the silver orb of the moon was reflected from the waters, and all nature was silent. I will not dissemble the first emotions of joy on the recovery of my freedom, and, perhaps, the establishment of my fame. But my pride was soon humbled, and a sober melancholy was spread over my mind by the idea that I had taken an everlasting leave of an old and agreeable companion, and that whatsoever might be the future date of my *History*, the life of the historian must be short and precarious."

Taking the manuscript with him, Gibbon, after an absence of four years, once more visited London in 1787; and the 51st anniversary of the author's birthday (27th April 1788) witnessed the publication of the last three volumes of *The Decline and Fall*. They met with a quick and easy sale, were very extensively read, and very liberally and deservedly praised for the unflagging industry and vigour they displayed, though just exception, if only on the score of good taste, was taken to the scoffing tone he continued to maintain in all passages where the Christian religion was specially concerned, and much fault was found with the indecency of some of his notes.¹

He returned to Switzerland in July 1788, cherishing vague schemes of fresh literary activity; but genuine sorrow caused by the death of his friend Deyverdun interfered with steady work, nor was it easy for him to fix on a new subject which should be at once congenial and proportioned to his powers; while the premonitory mutterings of the great thunderstorm of the French Revolution, which reverberated in hollow echoes even through

¹ An anonymous pamphlet, entitled *Observations on the three last volumes of the Roman History*, appeared in 1788; Disney's *Sermon, with Strictures*, in 1790; and Whitaker's *Review*, in 1791. With regard to the second of the above complaints, surprise will probably be felt that it was not extended to portions of the text as well as to the notes.

the quiet valleys of Switzerland, further troubled his repose. For some months he found amusement in the preparation of the delightful *Memoirs* (1789) from which most of our knowledge of his personal history is derived; but his letters to friends in England, written between 1788 and 1793 occasionally betray a slight but unmistakable tone of ennui. In April 1793 he unexpectedly received tidings of the death of Lady Sheffield; and the motive of friendship thus supplied combined with the pressure of public events to urge him homewards. He arrived in England in the following June, and spent the summer at Sheffield Place, where his presence was even more highly prized than it had ever before been. Returning to London early in November, he found it necessary to consult his physicians for a symptom which, neglected since 1761, had gradually become complicated with hydrocele, and was now imperatively demanding surgical aid; but the painful operations which had to be performed did not interfere with his customary cheerfulness, nor did they prevent him from paying a Christmas visit to Sheffield Place. Here, however, fever made its appearance; and a removal to London (January 6, 1794) was considered imperative. Another operation brought him some relief, but a relapse occurred during the night of the 15th, and on the following day he peacefully breathed his last. His remains were laid in the burial place of the Sheffield family, Fletching, Sussex, where an epitaph by Dr Parr describes his character and work in the language at once of elegance, of moderation and of truth.

The personal appearance of Gibbon as a lad of sixteen is brought before us somewhat dimly in M. Pavilliard's description of the "thin little figure, with a large head, disputing and arguing, with the greatest ability, all the best arguments that had ever been used in favour of popery." What he afterwards became has been made more vividly familiar by the clever silhouette prefixed to the *Miscellaneous Works* (Gibbon himself, at least, we know, did not regard it as a caricature), and by Sir Joshua Reynolds's portrait so often engraved. It is hardly fair perhaps to add a reference to Suard's highly-coloured description of the short Silenus-like figure, not more than 56 in. in height, the slim legs, the large turned-in feet, the shrill piercing voice; but almost every one will remember, from Croker's *Boswell*, Colman's account of the great historian "tapping his snuff-box, smirking and smiling, and rounding his periods" from that mellifluous mouth. It has already been seen that Gibbon's early ailments all left him on the approach of manhood; thenceforward, "till admonished by the gout," he could truly boast of an immunity well-nigh perfect from every bodily complaint; an exceptionally vigorous brain, and a stomach "almost too good," united to bestow upon him a vast capacity alike for work and for enjoyment. This capacity he never abused so as to burden his conscience or depress his spirits. "The madness of superfluous health I have never known." To illustrate the intensity of the pleasure he found alike in the solitude of his study and in the relaxations of genial social intercourse, almost any page taken at random, either from the *Life* or from the *Letters*, would suffice; and many incidental touches show that he was not a stranger to the delights of quiet contemplation of the beauties and grandeurs of nature. His manners, if formal, were refined; his conversation, when he felt himself at home, interesting and unaffected; and that he was capable alike of feeling and inspiring a very constant friendship there are many witnesses to show. That his temperament at the same time was frigid and comparatively passionless cannot be denied; but neither ought this to be imputed to him as a fault; hostile criticisms upon the grief for a father's death, that "was soothed by the conscious satisfaction that I had discharged all the duties of filial piety," seem somewhat out of place. His most ardent admirers, however, are constrained to admit that he was deficient in large-hearted benevolence; that he was destitute of any "enthusiasm of humanity"; and that so far as every sort of religious yearning or aspiration is concerned, his poverty was almost unique. Gibbon was such a man as Horace might have been, had the Roman Epicurean

been fonder of hard intellectual work, and less prone than he was to the indulgence of emotion. (H. Ro.; J. S. B.L.)

Gibbon's literary art, the sustained excellence of his style, his piquant epigrams and his brilliant irony, would perhaps not secure for his work the immortality which it seems likely to enjoy, if it were not also marked by ecumenical grasp, extraordinary accuracy and striking acuteness of judgment. It is needless to say that in many points his statements and conclusions must now be corrected. He was never content with secondhand accounts when the primary sources were accessible; "I have always endeavoured," he says, "to draw from the fountainhead; my curiosity, as well as a sense of duty, has always urged me to study the originals; and if they have sometimes eluded my search, I have carefully marked the secondary evidence on whose faith a passage or a fact were reduced to depend." Since he wrote, new authorities have been discovered or rendered accessible; works in Greek, Latin, Slavonic, Armenian, Syriac, Arabic and other languages, which he was unable to consult, have been published. Again, many of the authorities which he used have been edited in superior texts. The relative weights of the sources have been more nicely determined by critical investigation. Archaeology has become a science. In the immense region which Gibbon surveyed there is hardly a section which has not been submitted to the microscopic examination of specialists.

But apart from the inevitable advances made in the course of a century during which historical research entered upon a new phase, the reader of Gibbon must be warned against one capital defect. In judging the *Decline and Fall* it should carefully be observed that it falls into two parts which are heterogeneous in the method of treatment. The first part, a little more than five-eighths of the work, supplies a very full history of 460 years (A.D. 180-641); the second and smaller part is a summary history of about 800 years (A.D. 641-1453) in which certain episodes are selected for fuller treatment and so made prominent. To the first part unstinted praise must be accorded; it may be said that, with the materials at the author's disposition, it hardly admitted of improvement, except in trifling details. But the second, notwithstanding the brilliancy of the narrative and the mastery art in the grouping of events, suffers from a radical defect which renders it a misleading guide. The author designates the story of the later empire at Constantinople (after Heraclius) as "a uniform tale of weakness and misery," a judgment which is entirely false; and in accordance with this doctrine, he makes the empire, which is his proper subject, merely a string for connecting great movements which affected it, such as the Saracen conquests, the Crusades, the Mongol invasions, the Turkish conquests. He failed to bring out the momentous fact that up to the 12th century the empire was the bulwark of Europe against the East, nor did he appreciate its importance in preserving the heritage of Greek civilization. He compressed into a single chapter the domestic history and policy of the emperors from the son of Heraclius to Isaac Angelus; and did no justice to the remarkable ability and the indefatigable industry shown in the service of the state by most of the sovereigns from Leo III. to Basil II. He did not penetrate into the deeper causes underlying the revolutions and palace intrigues. His eye rested only on superficial characteristics which have served to associate the name "Byzantine" with treachery, cruelty, bigotry and decadence. It was reserved for Finlay to depict, with greater knowledge and a juster perception, the lights and shades of Byzantine history. Thus the later part of the *Decline and Fall*, while the narrative of certain episodes will always be read with profit, does not convey a true idea of the history of the empire or of its significance in the history of Europe. It must be added that the pages on the Slavonic peoples and their relations to the empire are conspicuously insufficient; but it must be taken into account that it was not till many years after Gibbon's death that Slavonic history began to receive due attention, in consequence of the rise of competent scholars among the Slavs themselves.

The most famous chapters of the *Decline and Fall* are the

fifteenth and sixteenth, in which the historian traces the early progress of Christianity and the policy of the Roman government towards it. The flavour of these chapters is due to the irony which Gibbon has employed with consummate art and felicity. There was a practical motive for using this weapon. An attack on Christianity laid a writer open to prosecution and penalties under the statutes of the realm (9 and 10 William III. c. 22, still unrepealed). Gibbon's stylistic artifice both averted the peril of prosecution and rendered the attack more telling. In his *Autobiography* he alleges that he learned from the *Provincial Letters* of Pascal "to manage the weapon of grave and temperate irony, even on subjects of ecclesiastical solemnity." It is not easy, however, to perceive much resemblance between the method of Pascal and that of Gibbon, though in particular passages we may discover the influence which Gibbon acknowledges. For instance, the well-known description (in chap. xviii.) of the preposition "in" occurring in a theological dogma as a "momentous particle which the memory rather than the understanding must retain" is taken directly from the first Provincial Letter. The main points in the general conclusions of these chapters have been borne out by subsequent research. The account of the causes of the expansion of Christianity is chiefly to be criticized for its omissions. There were a number of important contributory conditions (enumerated in Harnack's *Mission und Ausbreitung des Christentums*) which Gibbon did not take into account. He rightly insisted on the facilities of communication created by the Roman empire, but did not emphasize the diffusion of Judaism. And he did not realize the importance of the kinship between Christian doctrine and Hellenistic syncretism, which helped to promote the reception of Christianity. He was ignorant of another fact of great importance (which has only in recent years been fully appreciated through the researches of F. Cumont), the wide diffusion of the Mithraic religion and the close analogies between its doctrines and those of Christianity. In regard to the attitude of the Roman government towards the Christian religion, there are questions still *sub judice*; but Gibbon had the merit of reducing the number of martyrs within probable limits.

Gibbon's verdict on the history of the middle ages is contained in the famous sentence, "I have described the triumph of barbarism and religion." It is important to understand clearly the criterion which he applied; it is frequently misapprehended. He was a son of the 18th century; he had studied with sympathy Locke and Montesquieu; no one appreciated more keenly than he did political liberty and the freedom of an Englishman. This is illustrated by his love of Switzerland, his intense interest in the fortunes of that country, his design of writing "The History of the Liberty of the Swiss"—a theme, he says "from which the dullest stranger would catch fire." Such views and sentiments are incompatible with the idealization of a benevolent despotism. Yet in this matter Gibbon has been grossly misapprehended and misrepresented. For instance, Mirabeau wrote thus to Sir Samuel Romilly: "I have never been able to read the work of Mr Gibbon without being astounded that it should ever have been written in English; or without being tempted to turn to the author and say, 'You an Englishman? No, indeed.' That admiration for an empire of more than two hundred millions of men, where not one had the right to call himself free; that effeminate philosophy which has more praise for luxury and pleasures than for all the virtues; that style always elegant and never energetic, reveal at the most the elector of Hanover's slave." This criticism is based on a perverse misreading of the historian's observations on the age of Trajan, Hadrian and the Antonines. He enlarges, as it was his business to do, on the tranquillity and prosperity of the empire in that period, but he does not fail to place his finger on the want of political liberty as a fatal defect. He points out that under this benevolent despotism, though men might be happy, their happiness was unstable, because it depended on the character of a single man; and the highest praise he can give to those virtuous princes is that they "deserved the honour of restoring the republic, had the Romans of their days been capable of a rational freedom." The criterion by which

Gibbon judged civilization and progress was the measure in which the happiness of men is secured, and of that happiness he considered political freedom an essential condition. He was essentially humane; and it is worthy of notice that he was in favour of the abolition of slavery, while humane men like his friend Lord Sheffield, Dr Johnson and Boswell were opposed to the anti-slavery movement.

BIBLIOGRAPHY.—Of the original quarto edition of *The Decline and Fall*, vol. i. appeared, as has already been stated, in 1776, vols. ii. and iii. in 1781 and vols. iv.-vi. (inscribed to Lord North) in 1788. In later editions vol. i. was considerably altered by the author; the others hardly at all. The number of modern reprints has been very considerable. For many years the most important and valuable English edition was that of Milman (1839 and 1845), which was reissued with many critical additions by Dr W. Smith (8 vols. 8vo, 1854 and 1872). This has now been superseded by the edition, with copious notes, by Professor J. B. Bury (7 vols. 8vo, 1896-1900). The edition in Bohn's *British Classics* (7 vols., 1853) deserves mention. See also the essay on Gibbon in Sir Spencer Walpole's *Essays and Biographies* (1907). As a curiosity of literature Bowdler's edition, "adapted to the use of families and young persons," by the expurgation of "the indecent expressions and all allusions of an improper tendency" (5 vols. 8vo, 1825), may be noticed. The French translation of Le Clerc de Septchènes, continued by Démeunier, Bouldard and Cantwell (1788-1795), has been frequently reprinted in France. It seems to be certain that the portion usually attributed to Septchènes was, in part at least, the work of his distinguished pupil, Louis XVI. A new edition of the complete translation, prefaced by a letter on Gibbon's life and character, from the pen of Suard, and annotated by Guizot, appeared in 1812 (and again in 1828). There are at least two German translations of *The Decline and Fall*, one by Wenck, Schreiter and Beck (1805-1807), and a second by Johann C. Sporschil (1837, new ed. 1862). The Italian translation (alluded to by Gibbon himself) was, along with Spedalieri's *Confutazione*, reprinted at Milan in 1823. There is a Russian translation by Neviedomski (7 parts, Moscow, 1883-1886), and an Hungarian version of cc. 1-38 by K. Hegyessy (Pest, 1868-1869). Gibbon's *Miscellaneous Works, with Memoirs of his Life and Writings, composed by himself; illustrated from his Letters, with occasional Notes and Narrative*, published by Lord Sheffield in two volumes in 1796, has been often reprinted. The new edition in five volumes (1814) contained some previously unpublished matter, and in particular the fragment on the revolutions of Switzerland. A French translation of the *Miscellaneous Works* by Marigné appeared at Paris in 1798. There is also a German translation (Leipzig, 1801). It may be added that a special translation of the chapter on Roman Law (*Gibbon's historische Übersicht des römischen Rechts*) was published by Hugo at Göttingen in 1839, and has frequently been used as a text-book in German universities. This chapter has also appeared in Polish (Cracow, 1844) and Greek (Athens, 1840). The centenary of Gibbon's death was celebrated in 1894 under the auspices of the Royal Historical Society; *Proceedings of the Gibbon Commemoration, 1794-1894*, by R. F. T. Ball (1895). (J. B. B.)

GIBBON, the collective title of the smaller man-like apes of the Indo-Malay countries, all of which may be included in the single genus *Hylobates*. Till recently these apes have been generally included in the same family (*Simiidae*) with the chimpanzee, gorilla and orang-utan, but they are now regarded by several naturalists as representing a family by themselves—the *Hylobatidae*. One of the distinctive features of this family is the presence of small naked callosities on the buttocks; another being a difference in the number of vertebrae and ribs as compared with those of the *Simiidae*. The extreme length of the limbs and the absence of a tail are other features of these small apes, which are thoroughly arboreal in their habits, and make the woods resound with their unearthly cries at night. In agility they are unsurpassed; in fact they are stated to be so swift in their movements as to be able to capture birds on the wing with their paws. When they descend to the ground—which they must often do in order to obtain water—they frequently walk in the upright posture, either with the hands crossed behind the neck, or with the knuckles resting on the ground. Their usual food consists of leaves and fruits. Gibbons may be divided into two groups, the one represented by the siamang, *Hylobates (Symphalangus) syndactylus*, of Sumatra and the Malay Peninsula, and the other by a number of closely allied species. The union of the index and middle fingers by means of a web extending as far as the terminal joints is the distinctive feature of the siamang, which is the largest of the group, and black in colour with a white frontal band. Black or puce-grey is the prevailing colour in the second group, of which the hulock (*H. hulock*) of

Assam, *H. lar* of Arakan and Pegu, *H. entelloides* of Tenasserim (fig.), and *H. agilis* of Sumatra are well-known representatives. A female of the Hainan gibbon (*H. hainanus*) in confinement changed from uniform sooty-black (without the white frontal

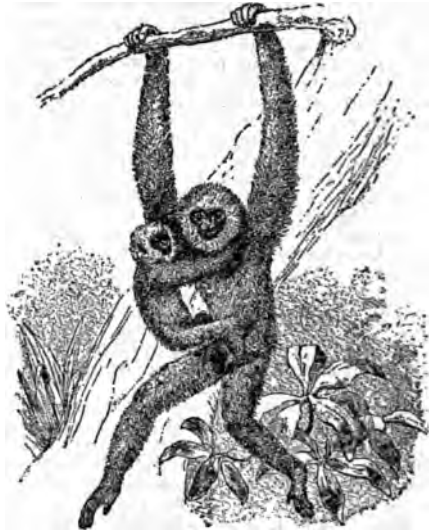

The Tenasserim Gibbon (*Hylobates entelloides*).

band of the black phase of the hulock) to puce-grey; but it is probable that this was only an individual, or at most a sexual peculiarity. The range of the genus extends from the southern bank of the Bramaputra in Assam to southern China, the Malay Peninsula, Java, Sumatra and Borneo. (R. L.)

GIBBONS, GRINLING (1648-1721), English wood-carver, was born in 1648, according to some authorities of Dutch parents at Rotterdam, and according to others of English parents at London. By the former he is said to have come to London after the great fire in 1666. He early displayed great cleverness and ingenuity in his art, on the strength of which he was recommended by Evelyn to Charles II., who employed him in the execution both of statuary and of ornamental carving in wood. In the early part of the 18th century he worked for Sir Christopher Wren. In statuary one of his principal works is a life-size bronze statue in the court of Whitehall, representing James II. in the dress of a Roman emperor, and he also designed the base of the statue of Charles I. at Charing Cross. It is, however, chiefly as a sculptor in wood that he is famous. He was employed to execute the ornamental carving for the chapel at Windsor, the foliage and festoons in the choir of St Paul's, the baptismal fonts in St James's, and an immense quantity of ornamental work at Burleigh, Chatsworth, and other aristocratic mansions. The finest of all his productions in this style is believed to be the ceiling which he devised for a room at Petworth. His subjects are chiefly birds, flowers, foliage, fruit and lace, and many of his works, for delicacy and elaboration of details, and truthfulness of imitation, have never been surpassed. He, however, sometimes wasted his ingenuity on trifling subjects; many of his flowers used to move on their stems like their natural prototypes when shaken by a breeze. In 1714 Gibbons was appointed master carver in wood to George I. He died at London on the 3rd of August 1721.

GIBBONS, JAMES (1834-), American Roman Catholic cardinal and archbishop, was born in Baltimore, Maryland, on the 23rd of July 1834, and was educated at St Charles College, Ellicott City, Maryland, and St Mary's Seminary, Baltimore, where he finished his theological training and was ordained priest

on the 30th of June 1861. After a short time spent on the missions of Baltimore, he was called to be secretary to Archbishop Martin J. Spalding and assistant at the cathedral. When in 1866 the Second Plenary Council of Baltimore considered the matter of new diocesan developments, he was selected to organize the new Vicariate Apostolic of North Carolina; and was consecrated bishop in August 1868. During the four successful years spent in North Carolina he wrote, for the benefit of his mission work, *The Faith of our Fathers*, a brief presentation of the doctrines of the Roman Catholic Church, especially intended to reach Protestants; the books passed through more than forty editions in America and about seventy in England, and an answer was made to it in *Faith of our Forefathers* (1879), by Edward J. Stearns. Gibbons was transferred to the see of Richmond, Virginia, in 1872, and in 1877 was made coadjutor, with the right of succession, to the Archbishop (James R. Bayley) of Baltimore. In October of the same year he succeeded to the archbishopric. Pope Leo XIII. in 1883 selected him to preside over the Third Plenary Council in Baltimore (1884), and on the 30th of June 1886 created him a cardinal priest, with the title of Santa Maria Trastevere. His simplicity of life, foresight and prudence made him a power in the church. Thoroughly American, and a lover of the people, he greatly altered the attitude of the Roman Catholic Church toward the Knights of Labor and other labour organizations, and his public utterances displayed the true instincts of a popular leader. He contributed frequently to periodicals, but as an author is known principally by his works on religious subjects, including *Our Christian Heritage* (1886) and *The Ambassador of Christ* (1896). For many years an ardent advocate of the establishment of a Catholic university, at the Third Plenary Council of Baltimore (1884) he saw the realization of his desires in the establishment of the Catholic University of America at Washington, of which he became first chancellor and president of the board of trustees.

GIBBONS, ORLANDO (1583-1625), English musical composer, was the most illustrious of a family of musicians all more or less able. We know of at least three generations, for Orlando's father, William Gibbons, having been one of the waits of Cambridge, may be assumed to have acquired some proficiency in the art. His three sons and at least one of his grandsons inherited and further developed his talent. The eldest, Edward, was made bachelor of music at Cambridge, and successively held important musical appointments at the cathedrals of Bristol and Exeter; Ellis, the second son, was organist of Salisbury cathedral, and is the composer of two madrigals in the collection known as *The Triumphs of Oriana*. Orlando Gibbons, the youngest and by far the most celebrated of the brothers, was born at Cambridge in 1583. Where and under whom he studied is not known, but in his twenty-first year he was sufficiently advanced and celebrated to receive the important post of organist of the Chapel Royal. His first published composition "Fantasies in three parts, composed for viols," appeared in 1610. It seems to have been the first piece of music printed in England on engraved plates, or "cut in copper, the like not heretofore extant." In 1622 he was created doctor of music by the university of Oxford. For this occasion he composed an anthem for eight parts, *O clap your Hands*, still extant. In the following year he became organist of Westminster Abbey. Orlando Gibbons died before the beginning of the civil war, or it may be supposed that, like his eldest brother, he would have been a staunch royalist. In a different sense, however, he died in the cause of his master; for having been summoned to Canterbury to produce a composition written in celebration of Charles's marriage, he there fell a victim to smallpox on the 5th of June 1625.

For a full list of his compositions, see Grove's *Dictionary of Music*. His portrait may be found in Hawkins's well-known *History*. His vocal pieces, madrigals, motets, canons, &c., are admirable, and prove him to have been a great master of pure polyphony. We have also some specimens of his instrumental music, such as the six pieces for the virginals published in *Parthenia*, a collection of instrumental music produced by Gibbons in conjunction with Dr Bull and Byrd.

GIBBS, JOSIAH WILLARD (1839-1903), American mathematical physicist, the fourth child and only son of Josiah Willard Gibbs (1790-1861), who was professor of sacred literature in Yale Divinity School from 1824 till his death, was born at New Haven on the 11th of February 1839. Entering Yale College in 1854 he graduated in 1858, and continuing his studies there was appointed tutor in 1863. He taught Latin in the first two years, and natural philosophy in the third. He then went to Europe, studying in Paris in 1866-1867, in Berlin in 1867 and in Heidelberg in 1868. Returning to New Haven in 1869, he was appointed professor of mathematical physics in Yale College in 1871, and held that position till his death, which occurred at New Haven on the 28th of April 1903. His first contributions to mathematical physics were two papers published in 1873 in the *Transactions of the Connecticut Academy* on "Graphical Methods in the Thermodynamics of Fluids," and "Method of Geometrical Representation of the Thermodynamic Properties of Substances by means of Surfaces." His next and most important publication was his famous paper "On the Equilibrium of Heterogeneous Substances" (in two parts, 1876 and 1878), which, it has been said, founded a new department of chemical science that is becoming comparable in importance to that created by Lavoisier. This work was translated into German by W. Ostwald (who styled its author the "founder of chemical energetics") in 1891 and into French by H. le Chatelier in 1899. In 1881 and 1884 he printed some notes on the elements of vector analysis for the use of his students; these were never formally published, but they formed the basis of a text-book on *Vector Analysis* which was published by his pupil, E. B. Wilson, in 1901. Between 1882 and 1889 a series of papers on certain points in the electromagnetic theory of light and its relation to the various elastic solid theories appeared in the *American Journal of Science*, and his last work, *Elementary Principles in Statistical Mechanics*, was issued in 1902. The name of Willard Gibbs, who was the most distinguished American mathematical physicist of his day, is especially associated with the "Phase Rule," of which some account will be found in the article **ENERGETICS**. In 1901 the Copley medal of the Royal Society of London was awarded him as being "the first to apply the second law of thermodynamics to the exhaustive discussion of the relation between chemical, electrical and thermal energy and capacity for external work."

A biographical sketch will be found in his collected *Scientific Papers* (2 vols., 1906).

GIBBS, OLIVER WOLCOTT (1812-1908), American chemist, was born at New York on the 21st of February 1812. His father, Colonel George Gibbs, was an ardent mineralogist; the mineral gibbsite was named after him, and his collection was finally bought by Yale College. Entering Columbia College in 1837, Wolcott (the Oliver he dropped at an early date) graduated in 1841, and, having assisted Robert Hare at Pennsylvania University for several months, he next entered the College of Physicians and Surgeons in New York, qualifying as a doctor of medicine in 1845. Leaving America he studied in Germany with K. F. Rammelsberg, H. Rose and J. von Liebig, and in Paris with A. Laurent, J. B. Dumas, and H. V. Regnault, returning in 1848. In that year he became professor of chemistry at the Free Academy, now the College of the City of New York, and in 1863 he obtained the Rumford professorship in Harvard University, a post retained until his retirement in 1887 as professor emeritus. He died on the 9th of December 1908. Gibbs' researches were mainly in analytical and inorganic chemistry, the cobaltamines, platinum metals and complex acids being especially investigated. He was an excellent teacher, and contributed many articles to scientific journals.

See the Memorial Lecture by F. W. Clarke in the *J.C.S.* (1909), p. 1299.

GIBBON, a town in Palestine whose inhabitants wrested a truce from Joshua by a trick (Josh. ix., x.); where the champions of David fought those of Ish-bosheth (2 Sam. ii. 12-32); where Joab murdered Amasa (*ib.* x. 8-10); and where Johanan went against Ishmael to avenge the murder of Gedaliah (Jer. xli. 12).

Here was an important high place (1 Kings iii. 4) where for a time the tabernacle was deposited (2 Chron. i. 3). The present name is *El-Jib*; this is a small village about 5 m. N.W. of Jerusalem, standing on an isolated hill above a flat corn valley. The village is famous for its springs, and the reputation seems ancient (cf. 2 Sam. ii. 13; Jer. xli. 12). The principal spring issues from under a cliff on the south-east side of the hill, and the water runs to a reservoir lower down. The sides of the hill are rocky, and remarkable for the regular stratification of the limestone, which gives the hill at a distance the appearance of being terraced. Scattered olive groves surround the place.

(R. A. S. M.)

GIBEONITES, the inhabitants of Gibeon, an Amorite or Hivite stronghold, the modern *El-Jib*, 5 m. N.W. from Jerusalem. According to Joshua xviii. 25 it was one of the cities of Benjamin. When the Israelites, under Joshua, invaded Canaan, the Gibeonites by a crafty ruse escaped the fate of Jericho and Ai and secured protection from the invaders (Joshua ix.). Cheyne thinks this story the attempt of a later age to explain the long independence of Gibeon and the use of the Gibeonites as slaves in Solomon's temple. An attempt on the part of Saul to exterminate the clan is mentioned in 2 Sam. xxi., and this slaughter may possibly be identified with the massacre at Nob recorded in 1 Sam. xxii. 17-19 (see *Ency. Bib.* col. 1717). The place is also associated with the murders of Asahel (2 Sam. ii. 12), Amasa (2 Sam. xx. 8) and Gedaliah (Jer. xli. 12), and with the wrathful intervention of Yahweh referred to by Isaiah (xxviii. 21), which we may identify with the memorable victory of David over the Philistines recorded in 2 Sam. v. 25 (reading Gibeon for Geba). Gibeon was the seat of an old Canaanitish sanctuary afterwards used by the Israelites; it was here that Solomon, immediately after his coronation, went to consult the oracles and had the dream in which he chose the gift of wisdom (1 Kings iii.).

GIBRALTAR, a British fortress and crown colony at the western entrance to the Mediterranean. The whole territory is rather less than 3 m. in length from north to south and varies in width from $\frac{1}{4}$ to $\frac{3}{4}$ m. Gibraltar is called after Tariq (or Tarik) ben Zaid, its name being a corruption of Jebel Tariq (Mount Tariq). Tariq invaded Andalusia in A.D. 711 with an army of 12,000 Arabs and Berbers, and in the last days of July of that year destroyed the Gothic power in a three days' fight on the banks of the river Guadalete near where Jerez de la Frontera now stands. In order to secure his communications with Africa he ordered the building of a strong castle upon the Rock, known to the Romans as Mons Calpe. This work, begun in the year of the great battle, was completed in 742. It covered a wide area, reaching from the shores of the bay to a point half-way up the north-western slope of the rock; here the keep, a massive square tower, still stands and is known as the Moorish castle.

The Rock itself is about $2\frac{1}{2}$ m. in length, and at its northern end rises almost perpendicularly from the strip of flat sandy ground which connects it with the Spanish mainland. At the north end, on the crest of the Rock 1200 ft. above sea-level, is the Rock gun, famous in the great siege. Some six furlongs to the south is the signal station (1255 ft.), through which the names and messages of passing ships are cabled to all parts of the world. Rather less than $\frac{1}{2}$ m. south of the signal station is O'Hara's Tower (1408 ft.), the highest point of the Rock. South of O'Hara's Tower the ground falls steeply to Windmill Hill, a fairly even surface about $\frac{1}{2}$ of a sq. m. in area, and sloping from 400 to 300 ft. above the sea-level. South of Windmill Hill are Europa Flats, a wall-like cliff 200 ft. or more in height dividing them. Europa Flats, sloping south, end in cliffs 50 ft. high, which at and around Europa Point plunge straight down into deep water. Europa Point is the most southern point of the Rock, and is distant $11\frac{1}{2}$ nautical miles from the opposite African coast. On Europa Point is the lighthouse in $5^{\circ} 21' W.$ and $36^{\circ} 6' 30'' N.$ On the Mediterranean side the Rock is almost as steep and inaccessible as it is from the north. Below the signal station, at the edge of the Mediterranean, lies Catalan Bay, where there is a little village chiefly inhabited by fishermen and others who make their living upon the waters; but Catalan Bay can only be approached

by land from the north or by a tunnel through the Rock from the dockyard; from Catalan Bay to Europa Point the way is barred by impassable cliffs. On the west side of the Rock the slopes are less steep, especially as they near the sea, and on this side lie the town, the Alameda or public gardens, the barracks and the dockyard.

Geology.—The rock of Gibraltar consists, for the most part, of pale grey limestone of compact and sometimes crystalline structure, generally stratified but in places apparently amorphous. Above the limestone are found layers of dark grey-blue shales with intercalated beds of grit, mudstone and limestone. Both limestone and shales are of the Lower Jurassic age. Professors A. C. Ramsay and James

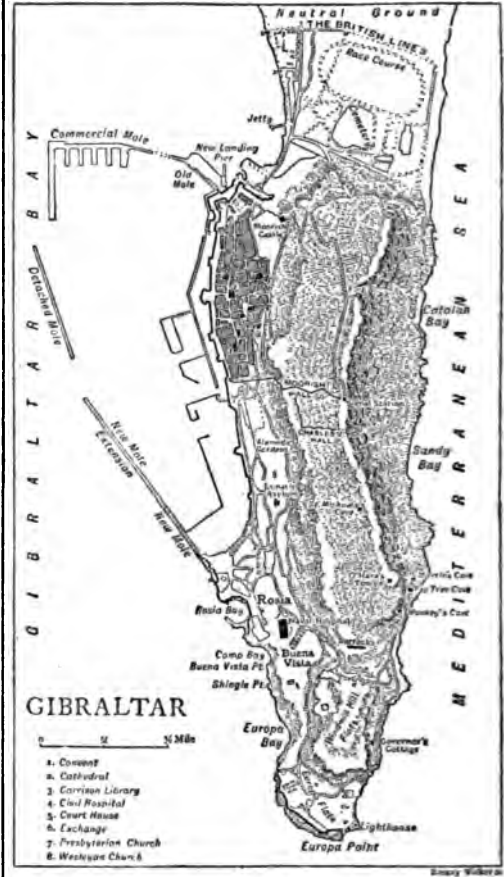

Geikie (*Quarterly Journal of the Geological Society*, London, August 1878) found also in the superficial formations of the Rock various features of interest to the students of Pleistocene geology, including massive accumulations of limestone breccia or agglomerate, bone breccias, deposits of calcareous sandstone, raised beaches and loose sands. The oldest of these superficial formations is the limestone breccia of Buena Vista, devoid of fossils and apparently formed under the stress of hard frosts, indicating conditions of climate of great severity. To account for frosts like these, it is suggested that the surface of the Rock must have been raised to an elevation much greater than its present height. In that case Europe and Africa would probably have been connected by an isthmus across some part of the present site of the Straits, and there would have been a wide area of low ground round the base of the Rock. The low ground at this, and probably at a later period, must have been clothed with a rich vegetation, necessary for the support of a varied mammalian fauna, whose remains have been found in the Genista caves. After this there would seem to have been a subsidence to a depth of some

700 ft. below the existing level. This would account for the ledges and platforms which have been formed by erosion of the sea high above the present sea-level, and for the deposits of calcareous sandstone containing sea shells of existing Mediterranean species. The extent of some of these eroded ledges shows that pauses of long duration intervened between the periods of depression. The Rock seems after this to have been raised to a level considerably above that at which it now stands; Europe and Africa would then again have been united. At a later date still the Rock sank once more to its present level.

Many caves, some of them of great extent, penetrate the interior of the rock; the best known of these are the Genista and St Michael's caves. St Michael's cave, about 1100 ft. above sea-level at its mouth, slopes rapidly down and extends over 400 ft. into the Rock; its extreme limits have not, however, been fully explored. It consists of a series of five or more chambers of considerable extent, connected by narrow and crooked passages. The outermost cave is 70 ft. in height and 200 in length, with massive pillars of stalactite reaching from roof to floor. The second cave was named the Victoria cave by its discoverer Captain Brome; beyond these are three caves known as the Leonora caves. "Nothing," writes Captain Brome, "can exceed the beauty of the stalactites; they form clusters of every imaginable shape—statuettes, pillars, foliage, figures," and he adds that American visitors have admitted that even the Mammoth cave itself could not rival these giant stalactites in picturesque beauty. The mammalian remains of the Genista cave have been described by G. Busk ("Quaternary Fauna of Gibraltar" in *Trans. of Zool. Soc.* vol. x. p. 2, 1877). They were found to contain remains of a bear, probably *Ursus fossilis* of Goldfuss; of a hyena, *H. crocuta* or *spelaea*; of cats varying from a leopard to a wild cat in size; of a rhinoceros, resembling in species remains found in the Thames valley; two forms of ibex; the hare and rabbit. No trace has been found as yet of *Rhinoceros tichorinus*, of *Ursus spelaeus* or of the reindeer; and of the elephant only a molar tooth of *Elephas antiquus*.

Further details may be found in the *Quarterly Journ. of Geol. Soc.* (James Smith of Jordanhill), vol. ii. and in vol. xxi. (*Fossil Contents of the Genista Cave*, G. Busk and Hugh Falconer; reprinted in *Palaeontological Memoirs*, H. Falconer, London, 1868).

Flora.—The upper part of the Rock is in summer burnt up and brown, but after the first autumn rains and during the winter, spring and early summer, it abounds in wild flowers and shrubs. In the public and other gardens on the lower ground, where there is a greater depth of soil, the vegetation is luxuriant and is only limited by the supply of water available for summer irrigation. Dr E. F. Kolmar (*Flora Calpensis*, London, 1846) enumerates more than four hundred varieties of plants and ferns indigenous to Gibraltar, and about fifty more which have been introduced from abroad. Of the former a few are said to be species peculiar to the Rock. The stone-pine and wild-olive are perhaps the only trees found growing in a natural state. In the public and private gardens and by the roadside may be seen the pepper tree, the plane, the white poplar, the acacia, the bella-sombra (*Phytolacca dioica*), the eucalyptus or blue gum tree, and palms of different species; and, of fruit trees, the orange, lemon, fig, pomegranate, loquat and almond. The aloe, flowering aloe and prickly pear are common, and on the eastern side of the Rock the palmito or dwarf palm (*Chamaerops humilis*) is abundant.

Fauna.—The fauna of Gibraltar, from want of space, is necessarily scanty. The Barbary apes, said to be the only wild monkeys in Europe, are still to be found on the upper part of the Rock, but in very reduced numbers; about the beginning of the 20th century four or five only remained, which were said to be all females; a young male, however, was brought from Africa. The last male of the original stock, an old patriarch, who had died shortly before this, is believed to have killed and, it is said, eaten all the young ones. A small variety of pigeon breeds in the steep cliffs at the north end of the Rock. A few red-legged partridges, some rabbits, two or three foxes and a badger or two will complete the list.

Climate.—The climate of Gibraltar is pleasant and healthy, mild in winter, and only moderately hot in summer; but the heat, though not excessive, is lasting. The three months of June, July and August are almost always without rain, and it is not often that rain falls in the months of May and September. The first autumn rains, however, which sometimes begin in September, are usually heavy. From October to May the climate is for the most part delightful, warm sunshine prevailing, tempered by cool breezes; the spells of bad weather, although blustering enough at times, are seldom of more than a few days' duration. The thermometer in summer does not often reach 90° F. in the shade; from 83° to 85° may be taken to be the average maximum for July and August, and these are the hottest months of the year. The average yearly rainfall is 34.4 in., and in fifty years from 1837 to 1906 the greatest recorded rainfall was 59.35 in., and the smallest 16.75 in. The water-supply for drinking and cooking purposes is almost wholly derived from rain-water stored chiefly in underground tanks; there are very few good

wells. Many of the better class of houses have their own rain-water tanks, and there are large tanks belonging to the naval and military authorities. Large storage tanks have been constructed by the sanitary commissioners with specially prepared collecting areas high up the Rock. The collecting areas cover 16 acres, and the storage tanks have a capacity of over six million gallons. The tanks are excavated in the solid rock, whereby the water is kept in the dark and cool. A large quantity of brackish water for flushing purposes and baths is pumped from the sandy flats of the north front on the Spanish side of the Rock.

The Town.—The modern town of Gibraltar is of comparatively recent date, nearly all the older buildings having been destroyed during the great siege (1779–1783). The town lies, with most of its buildings crowded together, at the north-western corner of the Rock, and covers only about one-ninth part of the whole area; only a small part of it is on level ground, and those of its narrow streets and lanes which are at right angles to the line wall, or sea front, are for the most part, except at their western ends, little more than ramps or rough stairs formed of rubble stones, contracting in places into stone steps.

The public buildings present few, if any, features of general interest. The "Convent" rebuilt upon the remains of an old Franciscan monastery is the official residence of the governor. The Anglican cathedral is a poor imitation of Moorish architecture. The garrison library has excellent reading rooms and a large number of volumes of miscellaneous interest. The civil hospital is a well-planned and roomy modern building. The courthouse and exchange buildings are suited to the needs of the town. The antiquary may here and there find the remains of a Moorish bath forming part of a stable, or fragments of a sculptured stone gateway bearing the arms of Castile or of Aragon built into the wall of a modern barrack. In a small disused graveyard, near Southport gate, lie buried a number of those who fell at Trafalgar. To the south of the town are the Alameda parade and gardens, a lunatic asylum, the dockyard, graving docks and the naval and military hospitals.

Population.—The inhabitants of Gibraltar are of mixed race; after the capture of the town by the British nearly the whole of the former Spanish population emigrated in a body and founded, 6 m. away, the little town of San Roque. Most of the native inhabitants are of Italian or Genoese descent; there are also a number of Maltese, and between two and three thousand Jews. The Jews never intermarry with other races and form a distinct society of their own. The language of the people is Spanish, not very correctly spoken. English is learnt as a foreign language and is rarely, if ever, spoken by the people in their own homes. Gibraltar being primarily a fortress and naval base, every effort, in view of war contingencies, is made by the authorities to prevent the natural increase of the population. Sanitary and building regulations, modelled upon English statutes designed with quite different objects, are administered with some ingenuity and not a little severity. In this way the house room available for the poorer classes is steadily reduced. The poor are thus being gradually pushed across the frontier into the neighbouring Spanish town of La Linea de la Concepcion, itself a mere suburb of Gibraltar, whose population, however, is nearly double that of the parent city. A large army of workers come daily from "the Lines" into Gibraltar, returning at "first evening gunfire" shortly after sunset, at which time the gates are closed and locked for the night. Aliens are not allowed to reside in Gibraltar without a special permit, which must be renewed at short intervals. By an order in council, taking effect from November 1900, the like disabilities were extended to British subjects not previously resident.

The recorded births, marriages and deaths over a period of 23 years are as follows:—

Yearly Average.	Births.	Marriages.	Deaths.
1883–1885 . .	621	177	513
1886–1890 . .	603	167	514
1891–1895 . .	626	186	460
1896–1900 . .	641	201	498
1901–1905 . .	629	201	572

The numbers of the population from causes which have been referred to are almost stationary, showing a slight tendency to decrease. There are no available statistics later than those of a census taken in 1901, from which it appeared that the population then numbered 27,460, of whom the garrison and its families amounted to 6,995, the civil population, being British subjects, to 17,818, and aliens resident under permits to 3,047. The latter are chiefly working men and domestic servants.

Constitution.—Gibraltar is a crown colony. Of local government properly so called there is none. There is a sanitary commission which is vested with large powers of spending and with the control of buildings and streets and other matters managed by local authorities in England. Its members are appointed by the governor. An appeal from their decisions, so far as they affect individuals, lies to the supreme court. Apart from the garrison and civil officials there are comparatively few members of the Anglican Church. The great majority of the people belong to the Church of Rome. The Jews have four synagogues. The Protestant dissenters have two places of worship, Presbyterian and Wesleyan. Education is not compulsory for the civil population, but most of the children, if not all, receive a fair education in private or private aided schools. The number of the children on the rolls of the private and private aided schools was in 1905: boys, 1,504; girls, 1,733; total 3,237.

Commerce.—Except in respect of alcoholic liquors and tobacco Gibraltar has been a free port since the year 1705—a distinction due, it is said, to the refusal of a sultan of Morocco to allow of much-needed exports from Morocco to Gibraltar if full liberty of trade were not granted to his subjects. During the great wars of the beginning of the 19th century trade was most active in Gibraltar, and some large fortunes were made; but trade on a large scale has almost disappeared. At the point of contact of two continents, on the direct line of ocean trade with the far East, in regular steam communication with all the great ports of Europe and with North and South America, Gibraltar, by its position, is fitted to be a trade centre of the world, but the unrest and suspicion engendered in Morocco by the intrigues and designs of the European powers, and excessive protective duties and maladministration in Spain, have done much to extinguish the trade of Gibraltar. There are, however, no trustworthy statistics of imports and exports. Before the year 1898 wine, beer and spirits were the only goods which paid duty. In that year a duty of 1d. per lb was for the first time put upon tobacco and produced £1444; the duty was, however, in force only for a part of the year; in 1899 the duty, at the same rate, produced £7703. In 1902 the duty on tobacco was raised to 2d. per lb and produced £29,311. In 1905 this duty produced £24,575. The chief business of Gibraltar is the coaling of passing steamers; this gives work to several thousand men. Goods are also landed for re-export to Morocco, but the bulk of the Morocco trade, much of which formerly came to Gibraltar, is now done by lines of steamers trading to and from Morocco direct to British, German or French ports. Nearly all the fresh meat consumed in Gibraltar comes from Morocco, also large quantities of poultry and eggs. A fair amount of retail business is done with the passengers of ocean steamers which call on their way to and from the East and from North and South America.

The steam tonnage cleared annually since 1883 is shown in the following table:—

Yearly Average.	British.	Foreign.	Total.
1883-1885 . .	3,525,135	817,926	4,343,061
1886-1890 . .	4,507,101	908,419	5,415,520
1891-1895 . .	3,710,856	975,390	4,686,246
1896-1900 . .	3,281,165	1,063,307	4,344,532
1901-1905 . .	2,810,849	1,309,649	4,120,498

The main sources of revenue are (i.) duties upon wine, spirits, malt liquors and tobacco; (ii.) port and harbour dues; (iii.) tavern and other licences; (iv.) post and telegraph; (v.) ground and other rents; (vi.) stamps and miscellaneous. The returns before 1898 were made in pesetas ($\text{S}=\text{£}1$). In the following table these have been converted into sterling at an average of exchange 30=£1.

Yearly Average.	i.	ii.	iii.	iv.	v.	vi.	Total.
1886-1890	9,692	17,070	5387	6,805	6485	2,873	48,312
1891-1895	9,250	13,157	4275	7,833	6208	10,113	50,836
1896-1900	14,071	8,435	4136	10,016	5924	14,460	57,047
1901-1905	35,900	6,028	3905	12,091	6945	15,859	80,728
Year 1905	36,554	5,872	4050	16,551	7489	17,007	87,523

The money, weights and measures in legal use are British. Before 1898 Spanish money only was in use. The great depreciation of the Spanish currency during the war with the United States led in 1898 to the reintroduction of British currency as the legal tender money of Gibraltar. Notwithstanding this change the Spanish dollar still remains in current use; much of the retail business of the town being done with persons resident in Spain, the dollar fully holds its own.

Harbour and Fortifications.—Great changes were made in the defences of Gibraltar early in the 20th century. Guns of the newest types replaced those of older patterns. The heavier pieces instead of being at or near the sea-level, are now high up, many of them on the crest line of the Rock; their lateral range and fire area has thereby been greatly increased and their efficiency improved in combination with an elaborate system of range finding.

With the completion of the new dockyard works the value of Gibraltar as a naval base has greatly increased. It can now undertake all the ordinary repairs and coaling of a large fleet. There is an enclosed harbour in which a fleet can safely anchor secure from the attacks of torpedo boats. A mole, at first intended for commercial purposes, closes the north end of the new harbour. The Admiralty, however, soon found that their needs had outgrown the first design and the so-called Commercial Mole has been taken over for naval purposes, plans for a new commercial mole being prepared. The funds for these extensive works were provided by the Naval Works Loan Acts of 1895 and subsequent years.

The land space available for the purposes of dockyard extension being very limited, a space of about 64 acres was reclaimed from the sea in front of the Alameda and the road to Rosia; some of the land reclaimed was as much as 40 ft. under water. The large quantity of material required for this purpose was obtained by tunnelling the Rock from W. to E. and from quarries above Catalan Bay village, to which access was gained through the tunnel. The graving docks occupy the dug-out site of the former New Mole Parade. There are three of these docks, 850,550 and 450 ft. in length respectively. The largest dock is divisible by a central caisson so that four ships can be docked at one time. The docks are all 95 ft. wide at the entrance with 35½ ft. of water over the sills at low-water spring tides. The pumping machinery can empty the largest dock, 105,000 tons of water, in five hours. There are two workshops for the chief constructor's and chief engineer's departments, each 407 ft. long and 322 broad. For the staff captain's department and stores there are buildings with 250,000 ft. of floor space. At the north end of the yard are the administrative offices, slipways for destroyers, a slip for small craft, an ordnance wharf and a boat camber. The reclaimed area is faced with a wharf wall of concrete blocks for an unbroken length of 1600 ft. with 33 ft. of water alongside at low tide; on this wharf are powerful shears and cranes.

The enclosed harbour covers 440 acres, 250 of which have a minimum depth of 30 ft. at low water. It is closed on the S. and S.W. by the New Mole (1400 ft.) and the New Mole extension (2700 ft.), together 4100 ft.; on the W. by the Detached Mole (2720 ft.) and on the N. by the Commercial Mole.

The New Mole, so called to distinguish it from the Old Mole and its later extension the Devil's Tongue at the north end of the town, is said to have been begun by the Spaniards in 1620. It was successfully assaulted by landing parties from the British fleet under Sir George Rooke at the capture of Gibraltar by the British in 1704. It was extended at different times, and before the beginning of the new works was 1400 ft. in length. The New Mole, with its latest extension, has a width at top of 103 ft. It is formed of rubble stone floated into position in barges. It has a continuous wharf wall on the harbour side 3500 ft. long, with water alongside 30 to 35 ft. deep. On the outer side coal is stacked in sheds extending nearly the whole length of the mole.

The Detached Mole is a vertical wall formed of concrete blocks, each block weighing 28 tons. These blocks were built together on the sloping block system upon a rubble

foundation of stone deposited by barges and levelled by divers for the reception of the concrete blocks.

The Commercial Mole is now chiefly used by the navy as a convenient wharf for destroyers. It encloses the harbour to the north and extends westward from the end of the Devil's Tongue. At the end nearest the town are large stores; there is also a small wharf on its outer side which is used by the tenders of ocean steamers and by the small boats which ply to Algeciras.

This mole is built of rubble, and at its western end it has an arm about 1600 ft. long running S. in the direction of the Detached Mole. Parallel with and inside the western arm are five jetties. The jetties and western arm have extensive coal sheds and are faced with a concrete wharf wall of a total length of 7000 ft. with 20 to 30 ft. of water alongside. The Devil's Tongue was an extension of the Old Mole, constructed during the great siege 1779-1783 in order to bring a flanking fire to bear upon part of the Spanish lines. It owes its name to the success with which it played its destined part.

(H. M. *)

History.—Gibraltar was known to the Greek and Roman geographers as Calpe or Alybe, the two names being probably corruptions of the same local (perhaps Phœnician) word. The eminence on the African coast near Ceuta which bears the modern English name of Apes' Hill was then designated Abyla; and Calpe and Abyla, at least according to an ancient and widely current interpretation, formed the renowned Pillars of Hercules (*Herculis columnæ*, Ἡρακλέους στῆλαι), which for centuries were the limits of enterprise to the seafaring peoples of the Mediterranean world. The military history of the Rock begins with its capture and fortification by Tariq in 711. In 1309 it was retaken by Alonzo Perez de Guzman for Ferdinand IV. of Castile and Leon, who, in order to attract inhabitants to the spot, offered an asylum to thieves and murderers, and promised to levy no taxes on the import or export of goods. The attack of Ismail ben Ferez in 1315 (2nd siege) was frustrated; but in 1333 Vasco Perez de Meyra, having allowed the fortifications and garrison to decay, was obliged to capitulate to Mahomet IV. (3rd siege) after a defence of five months. Alonzo's attempts to recover possession (4th siege) were futile, though pertinacious and heroic; but after his successful attack on Algeciras in 1344 he was encouraged to try his fortune again at Gibraltar. In 1349 he invested the Rock, but the siege (5th siege) was brought to an untimely close by his death in March 1350. The next or 6th siege resulted simply in the transference of the position from the hands of the king of Morocco to those of Yusef III. of Granada (1411), and the 7th, undertaken by the Spanish count of Niebla, Enrique de Guzman, proved fatal to the besieger and his forces (1435). In 1462, however, success attended the efforts of Alonzo de Arcos (8th siege), and in August the Rock passed once more under Christian sway. The duke of Medina Sidonia, a powerful grandee who had assisted in its capture, was anxious to get possession of the fortress, and though Henry IV. at first managed to maintain the claims of the crown, the duke ultimately made good his ambition by force of arms (9th siege), and in 1469 the king was constrained to declare his son and his heirs perpetual governors of Gibraltar. In 1479 Ferdinand and Isabella made the second duke marquis of Gibraltar, and in 1492 the third duke, Don Juan, was reluctantly allowed to retain the fortress. At length in 1502 it was formally incorporated with the domains of the crown. Don Juan tried in 1506 to recover possession, and added a 10th to the list of sieges. In 1540 the garrison had to defend itself against a much more formidable attack (11th siege)—the pirates of Algiers having determined to recover the Rock for Mahomet and themselves. The conflict was severe, but resulted in the repulse of the besiegers. After this the Spaniards made great efforts to strengthen the place, and they succeeded so well that throughout Europe Gibraltar was regarded as impregnable, the engineer Daniel Speckle (1536-1589) being chiefly responsible for the design of the fortifications.

Gibraltar was taken by the allied British and Dutch forces, after a three days' siege, on the 24th of July 1704 (see SPANISH SUCCESSION, WAR OF THE). The capture was made, as the war was being fought, in the interests of Charles, archduke of

Austria, but Sir George Rooke (*q.v.*), the British admiral, on his own responsibility caused the British flag to be hoisted, and took possession in name of Queen Anne, whose government ratified the occupation. A great number of the inhabitants of the town of Gibraltar abandoned their homes rather than recognize the authority of the invaders. The Spaniards quickly assembled an army to recapture the place, and a new siege opened in October 1704 by troops of France and Spain under the marquis of Villadarias. The activity of the British admiral, Sir John Leake, and of the military governor, Prince George of Hesse-Darmstadt (who had commanded the land forces in July), rendered the efforts of the besiegers useless. A notable incident of this siege was the gallant attempt made by 500 chosen volunteers to surprise the garrison (31st of October), an attempt which, at first successful, in the end failed disastrously. Finally, in April 1705 the French marshal de Tessé, who had replaced Villadarias, gave up the siege and retired. During the next twenty years there were endless negotiations for the peaceful surrender of the fortress, varied in 1720 by an abortive attempt at a *coup de main*, which was thwarted by the resourcefulness of the governor of Minorca (Colonel Kane), who threw reinforcements and supplies into Gibraltar at the critical moment. In 1726 the Spaniards again appealed to arms. But the count of las Torres, who had the chief command, succeeded no better than his predecessors. The place had been strengthened since 1705, and the defence of the garrison under Brigadier Clayton, the lieutenant-governor, Brigadier Kane of Minorca, and the governor, the earl of Portmore, who arrived with reinforcements, was so effective that the armistice of the 12th of June practically put a close to the siege, though two years elapsed before the general pacification ensued.

Neither in the War of the Austrian Succession nor in that of 1762 did Spain endeavour to besiege the rock, but the War of American Independence gave her better opportunities, and the great siege of 1779-1783 is justly regarded as one of the most memorable sieges of history. The governor, General Sir George Augustus Elliot (afterwards Lord Heathfield), was informed from England on the 6th of July 1779 that hostilities had begun. A short naval engagement in the straits took place on the 11th, and General Elliot made every preparation for resistance. It was not, however, until the month of August that the Spaniards became threatening. The method of the besiegers appeared to be starvation, but the interval between strained relations and war had been well employed by the ships, and supplies were, for the time at any rate, sufficient. While the Spanish siege batteries were being constructed the fortress fired, and many useful artillery experiments were carried out by the garrison at this time and subsequently throughout the siege. On the 14th of November there took place a spirited naval action in which the privateer "Buck," Captain Fagg, forced her way into harbour. This was one of many such incidents, which usually arose from the attempts made from time to time by vessels to introduce supplies from Tangier and elsewhere. December 1779, indeed, was a month of privation for the garrison, though of little actual fighting. In January 1780, on the rumour of an approaching convoy, the price of foods "fell more than two-thirds," and Admiral Sir George Rodney won a great victory over De Langara and entered the harbour. Prince William Henry (afterwards King William IV.) served on board the British fleet as a midshipman during this expedition. Supplies and reinforcements were thrown into the fortress by Rodney, and the whole affair was managed with the greatest address both by the home government and the royal navy. "The garrison," in spite of the scurvy, "might now be considered in a perfect state of defence," says Drinkwater.

On the 7th of June took place an attack by Spanish fireships, which were successfully dealt with by the naval force in the bay under Captain Lesley of H.M. frigate "Enterprise." Up to October the state of things within the fortress was much what it had been after Rodney's success. "The enemy's operations on the land side had been for many months so unimportant as scarcely to merit our attention" (Drinkwater). Scurvy was, however, prevalent (see Drinkwater, p. 121), and the supplies

Siege of Gibraltar (1779-1783).

question had again become acute. Though the enemy's batteries did not open fire, the siege works steadily progressed, in spite of the fire from the fortress, and there were frequent small engagements at sea in which the English were not always successful. Further, the expulsion, with great harshness, of the English residents of Barbary territory put an end to a service of supply and information which had been of the greatest value to Elliot (January 1781). Three more months passed in forced inaction, which the garrison, stinted as it was, endured calmly. Then, on the 12th of April 1781, on the arrival of a British relieving squadron under Admiral Darby, the whole of the Spanish batteries opened fire. Stores were landed in the midst of a heavy bombardment, and much damage was done both to the fortifications and military buildings and to the town. At this time there was a good deal of indiscipline in the garrison, with which General Elliot dealt severely. This was in the last degree necessary, for the bombardment continued up to the 1st of June, after which the rate of the enemy's fire decreased to 500 rounds per day. By the 12th of July it had almost ceased. In September the firing again became intense and the casualties increased, the working parties suffering somewhat heavily. In October there was less expenditure of ammunition, as both sides were now well covered, and in November the governor secretly prepared a great counterstroke. The sortie made on the night of the 26th-27th of November was brilliantly successful, and the Spanish siege works were mostly destroyed. At the close of the year the garrison was thus again in an excellent position.

Early in 1782 a new form of gun-carriage wheel, allowing of a large angle of depression being given, was invented by an officer of the Royal Artillery, and indeed throughout the siege many experiments (such as would nowadays be carried out at a school of gunnery) were made with guns, mountings, ammunition, methods of fire, &c., both in Gibraltar and in the Spanish camp. The gun-carriage referred to enabled 93% of hits to be obtained at 1400 yds. range. In April grates for heating shot were constructed by order of the governor; these were destined to be famous. At the same time it was reported that the duc de Crillon was now to command the besiegers (French and Spaniards) with D'Arçon as his chief engineer. The grand attack was now imminent, and preparations were made to repel it (July 1782). The chief feature of the attack was to be, as reported on the 26th of July, ten ships "fortified 6 or 7 ft. thick . . . with green timber bolted with iron, cork and raw hides; which were to carry guns of heavy metal and be bomb-proof on the top with a descent for the shells to slide off; that these vessels . . . were to be moored within half gunshot of the walls," &c. On the other side many of the now existing rock galleries were made about this time. The count of Artois and another French prince arrived in the French lines in August to witness the culminating effort of the besiegers, and some polite correspondence passed between Crillon and the governor (reprinted in Drinkwater, p. 267). The garrison made a preliminary trial of the red-hot shot on the 8th of September, and the success of the experiment not only elated the garrison but was partly instrumental in causing Crillon to hasten the main attack. After a preliminary bombardment the famous battering ships took up their positions in broad daylight on the 13th and opened fire. The British solid shot seem to have failed absolutely to penetrate the massive wooden armour on the sides and the roofs of the battering ships, and about noon the ships had settled down to their work and were shooting coolly and accurately. But between 1 and 2 P.M. the British artillerymen began to use the red-shot freely. All day the artillery-duel went on, the shore guns, though inferior in number, steadily gaining the upper hand, and the battering ships were in great distress by nightfall. The struggle continued in the dark, the garrison now shooting rapidly and well, and one by one the ten ships were set on fire. Before noon on the 14th the attack had come to an end by the annihilation of the battering fleet, every ship having been blown up or burnt to the water's edge. Upwards of 8300 rounds were expended by the garrison though less than a hundred pieces were in action. The enemy's bombardment

was, however, resumed and partial engagements continued up to the third naval relief of the fortress by Lord Howe, who won a great victory at sea over the Spaniards. The long siege came to an end on the 6th of February 1783, when the duc de Crillon informed Elliot that the preliminaries of peace had been signed. On the 31st of March the duke visited the fortress, and many courtesies passed between the late enemies. Captain (afterwards Colonel) John Drinkwater (1762-1844), the historian of the siege, first published his work in 1785. A new edition of *A History of the Siege of Gibraltar* was published in 1905. The history of the four eventful years' siege is fully detailed also in the Memoir, attached to Green's *Siege of Gibraltar* (1784), of its gallant defender Sir George Augustus Elliot, afterwards Lord Heathfield, whose military skill and moral courage place him among the best soldiers and noblest men of his time.

Since 1783 the history of Gibraltar has been comparatively uneventful. In the beginning of 1801 there were rumours of a Spanish and French attack, but the Spanish ships were defeated off Algierais in June by Admiral Saumarez. Improvements in the fortifications, maintenance of military discipline and legislation in regard to trade and smuggling, are the principal matters of recent interest.

BIBLIOGRAPHY.—To the works which have been already mentioned may be added: I. L. de Ayala, *Historia de Gibraltar* (Madrid, 1792); Jas. Bell, translation of Ayala's history (London, 1845); F. Carter, *Gibraltar to Malaga* (London, 1777-1780); G. Cockburn, *Gibraltar, Cadix, &c.* (London, 1815); O. Debeaux and G. Dautez, *Synopsis de la flore de Gibraltar* (1889); E. D. Fenton, *Sorties from Gibraltar*, (1872); H. M. Field, *Gibraltar* (New York, 1888); J. Galt, *Gibraltar, Sardinia, &c.* (London, 1813); J. Heriot, *Historical Sketch of Gibraltar* (London, 1792); R. Hort, *The Rock of Gibraltar* (London, 1839); L. W. L. Irby, *Ornithology of the Straits* (London, 1878); Thos. James, *History of the Herculean Straits* (London, 1771); J. H. Mann, *Gibraltar and its Sieges* (London, 1870); Montero, *Historia de Gibraltar* (Cadix, 1860); A. M. Monti, *Historia de Gibraltar* (Seville, 1851); J. Navarrete, *Las Llavas del Estrecho* (Madrid, 1882); M. S. Pasley, *Wild Flowers of Gibraltar* (Portsmouth, 1887); John Purdy, *Gibraltar and Mediterranean Sailing Directions* (London, 1840); H. J. M. Rey, *Essai sur la topographie médicale de Gibraltar* (Paris, 1833); Captain Sayer, *History of Gibraltar* (London, 1862); D. Sutherland, *Gibraltar to Constantinople* (London, 1790); Walker, *A Year's Insect Hunting in Gibraltar* (London, 1888). (C. F. A.)

GIBSON, CHARLES DANA (1867-), American artist and illustrator, was born at Roxbury, Massachusetts, on the 14th of September 1867. After a year's study at the schools of the Art Students' League, he began with some modest little drawings for the humorous weekly *Life*. These he followed up with more serious work, and soon made a place for himself as the delineator of the American girl, at various occupations, particularly those out of doors. These obtained an enormous vogue, being afterwards published in book form, running through many editions. The "Gibson Girl" stood for a type of healthy, vigorous, beautiful and refined young womanhood. Some book illustrations followed, notably for *The Prisoner of Zenda*. He was imitated by many of the younger draughtsmen, copied by amateurs, and his popularity was shown in his engagement by *Collier's Weekly* to furnish weekly for a year a double page. receiving for the fifty-two drawings the sum of \$50,000, said to have been the largest amount ever paid to an illustrator for such a commission. These drawings covered various local themes and were highly successful, being drawn with pen and ink with masterly facility and great directness and economy of line. So popular was one series, "The Adventures of Mr Pipp," that a successful play was modelled on it. In 1906, although besieged with commissions, Gibson withdrew from illustrative work, determining to devote himself to portraiture in oil, in which direction he had already made some successful experiments; but in a few years he again returned to illustration.

GIBSON, EDMUND (1669-1748), English divine and jurist, was born at Bampton in Westmorland in 1669. In 1686 he was entered a scholar at Queen's College, Oxford, where in 1692 he published a valuable edition of the *Saxon Chronicle* with a Latin translation, indices and notes. This was followed in 1693 by an annotated edition of the *De institutione oratoria* of Quintilian, and in 1695 by a translation in two volumes folio

of Camden's *Britannia*, "with additions and improvements," in the preparation of which he had been largely assisted by William Lloyd, John Smith and other English antiquaries. Shortly after Thomas Tenison's elevation to the see of Canterbury in 1694 Gibson was appointed chaplain and librarian to the archbishop, and in 1703 and 1710 respectively he became rector of Lambeth and archdeacon of Surrey. In the discussions which arose during the reigns of William and Anne relative to the rights and privileges of the Convocation, Gibson took a very active part, and in a series of pamphlets warmly argued for the right of the archbishop to continue or prorogue even the lower house of that assembly. The controversy suggested to him the idea of those researches which resulted in the famous *Codex juris ecclesiastici Anglicani*, published in two volumes folio in 1713,—a work which discusses more learnedly and comprehensively than any other the legal rights and duties of the English clergy, and the constitution, canons and articles of the English Church. In 1716 Gibson was presented to the see of Lincoln, whence he was in 1720 translated to that of London, where for twenty-five years he exercised an immense influence, being regularly consulted by Sir Robert Walpole on all ecclesiastical affairs. While a conservative in church politics, and declaredly opposed to methodism, he was no persecutor, and indeed broke with Walpole on the Quakers' Relief Bill of 1736. He exercised a vigilant oversight over the morals of his diocese; and his fearless denunciation of the licentious masquerades which were popular at court finally lost him the royal favour. Among the literary efforts of his later years the principal were a series of *Pastoral Letters* in defence of the "gospel revelation," against "lukewarmness" and "enthusiasm," and on various topics of the day; also the *Preservative against Popery*, in 3 vols. folio (1738), a compilation of numerous controversial writings of eminent Anglican divines, dating chiefly from the period of James II. Gibson died on the 6th of September 1748.

A second edition of the *Codex juris*, "revised and improved, with large additions by the author," was published at Oxford in 1761. Besides the works already mentioned, Gibson published a number of *Sermons*, and other works of a religious and devotional kind. The *Vita Thomae Bodleii* with the *Historia Bibliothecae Bodleianae* in the *Catalogi librorum manuscriptorum* (Oxford, 1697), and the *Reliquiae Spelmanianae* (Oxford, 1698), are also from his pen.

GIBSON, JOHN (1790–1866), English sculptor, was born near Conway in 1790, his father being a market gardener. To his mother, whom he described as ruling his father and all the family, he owed, like many other great men, the energy and determination which carried him over every obstacle. When he was nine years old the family were on the point of emigrating to America, but Mrs Gibson's determination stopped this project on their arrival at Liverpool, and there John was sent to school. The windows of the print shops of Liverpool riveted his attention, and, having no means to purchase the commonest print, he acquired the habit of committing to memory the outline of one figure after another, drawing it on his return home. Thus early he formed the system of observing, remembering and noting, sometimes even a month later, scenes and momentary actions from nature. In this way he, by degrees, transferred from the shop window to his paper at home the chief figures from David's picture of Napoleon crossing the Alps, which, by particular request, he copied in bright colours as a frontispiece to a little schoolfellow's new prayer-book, for sixpence. At fourteen years of age Gibson was apprenticed to a firm of cabinetmakers,—portrait and miniature painters in Liverpool requiring a premium which his father could not give. This employment so disgusted him that after a year (being interesting and engaging then apparently as in after-life) he persuaded his masters to change his indentures, and bind him to the wood-carving with which their furniture was ornamented. This satisfied him for another year, when an introduction to the foreman of some marble works, and the sight of a small head of Bacchus, unsettled him again. He had here caught a glimpse of his true vocation, and in his leisure hours began to model with such success that his efforts found their way to the notice of Mr Francis, the proprietor of the marble works. The wood-carving now, in turn, became

his aversion; and having in vain entreated his masters to set him free, he instituted a strike. He was every day duly at his post, but did no work. Threats, and even a blow, moved him not. At length the offer of £70 from Francis for the rebellious apprentice was accepted, and Gibson found himself at last bound to a master for the art of sculpture. Francis paid the lad 6s. a week, and received good prices for his works,—sundry early works by the youthful sculptor, which exist in Liverpool and the neighbourhood, going by the name of Francis to this day. It was while thus apprenticed that Gibson attracted the notice of William Roscoe, the historian. For him Gibson executed a basso rilievo in terra-cotta, now in the Liverpool museum. Roscoe opened to the sculptor the treasures of his library at Allerton, by which he became acquainted with the designs of the great Italian masters.

A cartoon of the Fall of the Angels marked this period,—now also in the Liverpool museum. We must pass over his studies in anatomy, pursued gratuitously by the kindness of a medical man, and his introductions to families of refinement and culture in Liverpool. Roscoe was an excellent guide to the young aspirant, pointing to the Greeks as the only examples for a sculptor. Gibson here found his true vocation. A basso rilievo of Psyche carried by the Zephyrus was the result. He sent it to the Royal Academy, where Flaxman, recognizing its merits, gave it an excellent place. Again he became unsettled. The ardent young breast panted for "the great university of Art"—Rome; and the first step to the desired goal was to London. Here he stood between the opposite advice and influence of Flaxman and Chantrey—the one urging him to Rome as the highest school of sculpture in the world, the other maintaining that London could do as much for him. It is not difficult to guess which was Gibson's choice. He arrived in Rome in October 1817, at a comparatively late age for a first visit. There he immediately experienced the charm and goodness of the true Italian character in the person of Canova, to whom he had introductions,—the Venetian putting not only his experience in art but his purse at the English student's service. Up to this time, though his designs show a fire and power of imagination in which no teaching is missed, Gibson had had no instruction, and had studied at no Academy. In Rome he first became acquainted with rules and technicalities, in which the merest tyro was before him. Canova introduced him into the Academy supported by Austria, and, as is natural with a mind like Gibson's, the first sense of his deficiencies in common matters of practice was depressing to him. He saw Italian youths already excelling, as they all do, in the drawing of the figure. But the tables were soon turned. His first work in marble—a "Sleeping Shepherd" modelled from a beautiful Italian boy—has qualities of the highest order. Gibson was soon launched, and distinguished patrons, first sent by Canova, made their way to his studio in the Via Fontanella. His aim, from the first day that he felt the power of the antique, was purity of character and beauty of form. He very seldom declined into the prettiness of Canova, and if he did not often approach the masculine strength which redeems the faults of Thorwaldsen, he more than once surpassed him even in that quality. We allude specially to his "Hunter and Dog," and to the grand promise of his "Theseus and Robber," which take rank as the highest productions of modern sculpture. He was essentially classic in feeling and aim, but here the habit of observation we have mentioned enabled him to snatch a grace beyond the reach of a mere imitator. His subjects were gleaned from the free actions of the splendid Italian people noticed in his walks, and afterwards baptized with such mythological names as best fitted them. Thus a girl kissing a child, with a sudden wring of the figure, over her shoulder, became a "Nymph and Cupid"; a woman helping her child with his foot on her hand on to her lap, a "Bacchante and Faun"; his "Amazon thrown from her Horse," one of his most original productions, was taken from an accident he witnessed to a female rider in a circus; and the "Hunter holding in his Dog" was also the result of a street scene. The prominence he gave among his favourite subjects to the little god "of soft tribulations" was no less owing to his facilities

for observing the all but naked Italian children, in the hot summers he spent in Rome.

In monumental and portrait statues for public places, necessarily represented in postures of dignity and repose, Gibson was very happy. His largest effort of this class—the group of Queen Victoria supported by Justice and Clemency, in the Houses of Parliament—was his finest work in the round. Of noble character also in execution and expression of thought is the statue of Huskisson with the bared arm; and no less, in effect of aristocratic ease and refinement, the seated figure of Dudley North. But great as he was in the round, Gibson's chief excellence lay in basso rilievo, and in this less-disputed sphere he obtained his greatest triumphs. His thorough knowledge of the horse, and his constant study of the Elgin marbles—casts of which are in Rome—resulted in the two matchless bassi rilievi, the size of life, which belong to Lord Fitzwilliam—the "Hours leading the Horses of the Sun," and "Phaëthon driving the Chariot of the Sun." Most of his monumental works are also in basso rilievo. Some of these are of a truly refined and pathetic character, such as the monument to the countess of Leicester, that to his friend Mrs Huskisson in Chichester cathedral, and that of the Bonomi children. Passion, either indulged or repressed, was the natural impulse of his art: repressed as in the "Hours leading the Horses of the Sun," and as in the "Hunter and Dog"; indulged as in the meeting of Hero and Leander, a drawing executed before he left England. Gibson was the first to introduce colour on his statues,—first, as a mere border to the drapery of a portrait statue of the queen, and by degrees extended to the entire flesh, as in his so-called "tinted" Venus, and in the "Cupid tormenting the Soul," in the Holford collection.

Gibson's individuality was too strongly marked to be affected by any outward circumstances. In all worldly affairs and business of daily life he was simple and guileless in the extreme; but he was resolute in matters of principle, determined to walk straight at any cost of personal advantage. Unlike most artists, he was neither nervous nor irritable in temperament. It was said of him that he made the heathen mythology his religion; and indeed in serenity of nature, feeling for the beautiful, and a certain philosophy of mind, he may be accepted as a type of what a pure-minded Greek pagan, in the zenith of Greek art, may have been. Gibson was elected R.A. in 1836, and bequeathed all his property and the contents of his studio to the Royal Academy, where his marbles and casts are open to the public. He died at Rome on the 27th of January 1866.

The letters between Gibson and Mrs Henry Sandbach, granddaughter of Mr Roscoe, and a sketch of his life that lady induced him to write, furnish the chief materials for his biography. See his *Life*, edited by Lady Eastlake. (E. E.)

GIBSON, THOMAS MILNER (1806-1884), English politician, who came of a good Suffolk family, was born in Trinidad, where his father, an officer in the army, was serving. He went to Trinity College, Cambridge, and in 1837 was elected to parliament as Conservative member for Ipswich, but resigned two years later, having adopted Liberal views, and became an

ardent supporter of the free-trade movement. As one of Cobden's chief allies, he was elected for Manchester in 1841, and from 1846 to 1848 he was vice-president of the board of trade in Lord John Russell's ministry. Though defeated in Manchester in 1857, he found another seat for Ashton-under-Lyne; and he sat in the cabinets from 1859 to 1866 as president of the board of trade. He was the leading spirit in the movement for the repeal of "taxes on knowledge," and his successful efforts on behalf of journalism and advertising were recognized by a public testimonial in 1862. He retired from political life in 1863, but he and his wife, whose salon was a great Liberal centre, were for many years very influential in society. Milner Gibson was a sportsman and a typical man of the world, who enjoyed life and behaved liberally to those connected with him.

GIBSON, WILLIAM HAMILTON (1850-1896), American illustrator, author and naturalist, was born in Sandy Hook, Connecticut, on the 5th of October 1850. The failure and his (1868) death of his father, a New York broker, put an end to his studies in the Brooklyn Polytechnic Institute and made it necessary for him to earn his own living. From the life insurance business, in Brooklyn, he soon turned to the study of natural history and illustration,—he had sketched flowers and insects when he was only eight years old, had long been interested in botany and entomology, and had acquired great skill in making wax flowers,—and his first drawings, of a technical character, were published in 1870. He rapidly became an expert illustrator and a remarkably able wood-engraver, while he also drew on stone with great success. He drew for *The American Agriculturist*, *Hearth and Home*, and Appleton's *American Cyclopædia*; for *The Youth's Companion* and *St Nicholas*; and then for various Harper publications, especially *Harper's Monthly Magazine*, where his illustrations first gained popularity. He died of apoplexy, brought on by overwork, on the 16th of July 1896 at Washington, Connecticut, where he had had a summer studio, and where in a great boulder is inset a relief portrait of him by H. K. Bush-Brown. He was an expert photographer, and his drawings had a nearly photographic and almost microscopic accuracy of detail which slightly lessened their artistic value, as a poetic and sometimes humorous quality somewhat detracted from their scientific worth. Gibson was perfectly at home in black-and-white, but rarely (and feebly) used colours. He was a popular writer and lecturer on natural history; in his best-known lecture, on "Cross-Fertilization," he used ingenious charts and models.

Gibson illustrated S. A. Drake's *In the Heart of the White Mountains*, C. D. Warner's *New South*, and E. P. Roe's *Nature's Serial Story*; and his own books, *The Complete American Trapper* (1876, revised, 1880, as *Camp Life in the Woods*); *Pastoral Days: or, Memories of a New England Year* (1880); *Highways and Byways* (1882); *Happy Hunting Grounds* (1886); *Strolls by Starlight and Sunshine* (1891); *Sharp Eyes: a Rambler's Calendar* (1891); *Our Edible Mushrooms and Toadstools* (1895); *Eye Spy: Afield with Nature among Flowers and Animate Things* (1897); and *My Studio Neighbours* (1898).

See John C. Adams, *William Hamilton Gibson, Artist, Naturalist, Author* (New York, 1901).

END OF ELEVENTH VOLUME

81 401ST 53 004 3 A 22v DR 6004

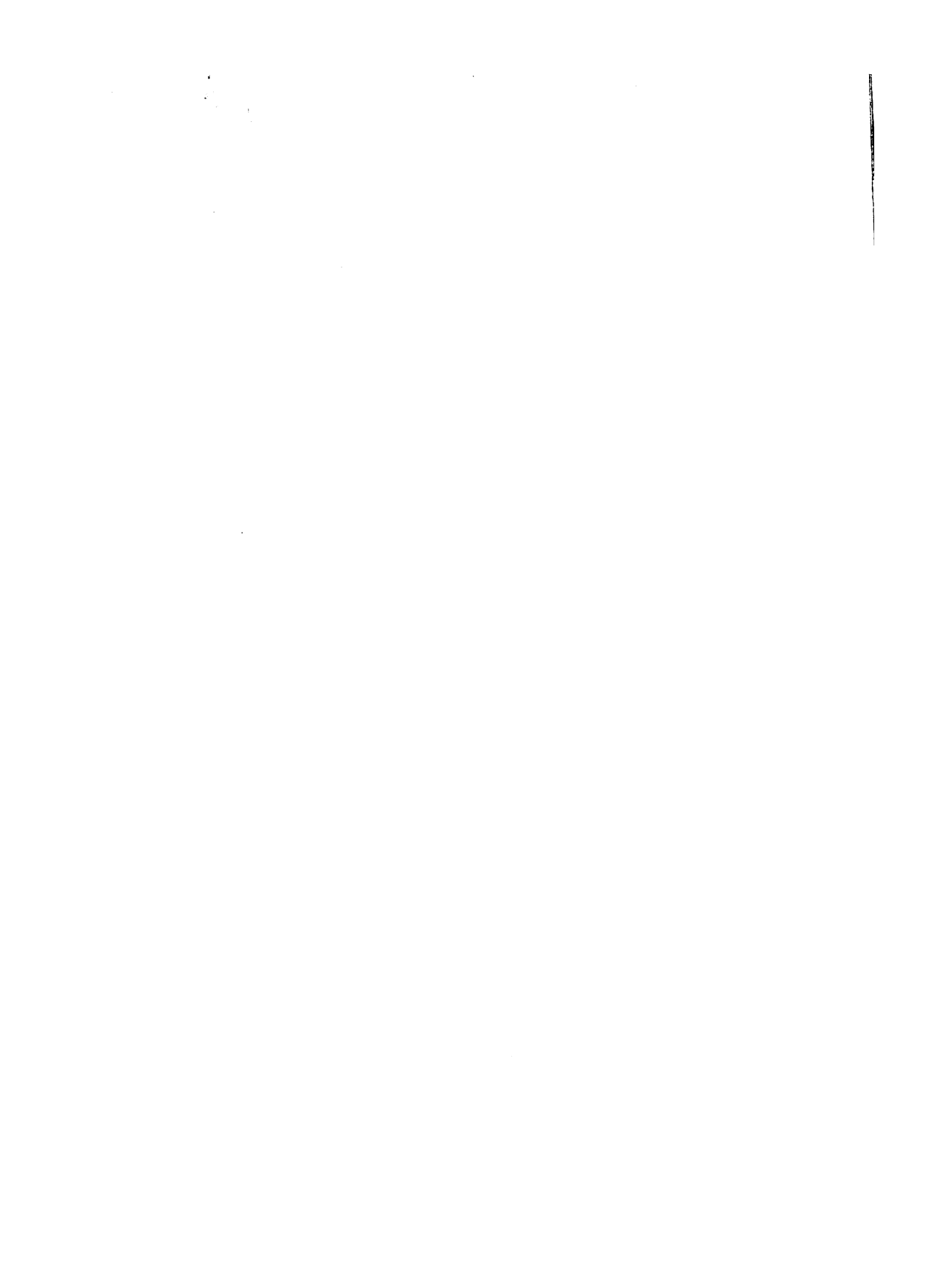

**REFERENCE
BOOK**

**THIS BOOK
DOES NOT
CIRCULATE**

Hoover Institution Library

3 6105 071 162 393

~~E5~~
E56
1922
V. 11

CECIL H. GREEN LIBRARY
STANFORD UNIVERSITY LIBRARIES
STANFORD, CALIFORNIA 94305-6004
(650) 723-1493
grncirc@sulmail.stanford.edu
All books are subject to recall.

DATE DUE

--	--